



User Guide

© Copyright 2014 Hewlett-Packard Development Company, L.P.

AMD is a trademark of Advanced Micro Devices, Inc. Bluetooth is a trademark owned by its proprietor and used by Hewlett-Packard Company under license. Intel, Celeron, Centrino, and Pentium are trademarks of Intel Corporation in the U.S. and other countries. Microsoft and Windows are U.S. registered trademarks of the Microsoft group of companies.

The information contained herein is subject to change without notice. The only warranties for HP products and services are set forth in the express warranty statements accompanying such products and services. Nothing herein should be construed as constituting an additional warranty. HP shall not be liable for technical or editorial errors or omissions contained herein.

First Edition: December 2014

Document Part Number: 799023-001

Product notice

This guide describes features that are common to most models. Some features may not be available on your computer.

Not all features are available in all editions of Windows. This computer may require upgraded and/or separately purchased hardware, drivers and/or software to take full advantage of Windows functionality. Go to <http://www.microsoft.com> for details.

To access the latest user guide, go to <http://www.hp.com/support>, and select your country. Select **Drivers & Downloads**, and then follow the on-screen instructions.

Software terms

By installing, copying, downloading, or otherwise using any software product preinstalled on this computer, you agree to be bound by the terms of the HP End User License Agreement (EULA). If you do not accept these license terms, your sole remedy is to return the entire unused product (hardware and software) within 14 days for a full refund subject to the refund policy of your seller.

For any further information or to request a full refund of the price of the computer, please contact your seller.

Safety warning notice

 **WARNING!** To reduce the possibility of heat-related injuries or of overheating the computer, do not place the computer directly on your lap or obstruct the computer air vents. Use the computer only on a hard, flat surface. Do not allow another hard surface, such as an adjoining optional printer, or a soft surface, such as pillows or rugs or clothing, to block airflow. Also, do not allow the AC adapter to come into contact with the skin or a soft surface, such as pillows or rugs or clothing, during operation. The computer and the AC adapter comply with the user-accessible surface temperature limits defined by the International Standard for Safety of Information Technology Equipment (IEC 60950-1).

Processor configuration setting (select models only)

 **IMPORTANT:** Select computer models are configured with an Intel® Pentium® N35xx series or a Celeron® N28xx/N29xx series processor and a Windows® operating system. **If your computer is configured as described, do not change the processor configuration setting in msconfig.exe from 4 or 2 processors to 1 processor.** If you do so, your computer will not restart. You will have to perform a factory reset to restore the original settings.

Table of contents

1 Starting right	1
Visit the HP Apps Store	1
Best practices	1
More HP resources	2
2 Getting to know your computer	4
Locating hardware	4
Locating software	4
Right side	5
Left side	6
Display	8
Top	9
TouchPad	9
Lights	10
Buttons and speakers	11
Keys	12
Using the action keys	12
Bottom	14
Labels	16
3 Connecting to a network	17
Connecting to a wireless network	17
Using the wireless controls	17
Wireless button	17
Operating system controls	18
Connecting to a WLAN	18
Using a WLAN	19
Using an Internet service provider	19
Setting up a WLAN	19
Configuring a wireless router	20
Protecting your WLAN	20
Using Bluetooth wireless devices (select models only)	20
Connecting to a wired network—LAN (select models only)	21
Sharing data and drives and accessing software	21

4 Enjoying entertainment features	22
Using a webcam	22
Using audio	22
Connecting speakers	22
Connecting headphones	22
Connecting headsets	23
Using video	23
Connecting video devices using an HDMI cable	23
Setting up HDMI audio	24
Connecting Miracast-compatible wireless displays (select models only)	24
5 Navigating the screen	25
Using the TouchPad gestures	25
Tap	25
Two-finger scroll	26
Two-finger pinch zoom	26
Two-finger click	26
Right-edge swipe	27
Left-edge swipe	27
Top-edge swipe and bottom-edge swipe	27
Using the keyboard and optional mouse	28
6 Managing power	29
Initiating and exiting Sleep and Hibernation	29
Manually initiating and exiting Sleep	30
Manually initiating and exiting Hibernation (select models only)	30
Setting password protection on wakeup (exiting Sleep or Hibernation)	30
Using the power meter and power settings	31
Running on battery power	31
User-replaceable battery	31
Finding battery information	32
Conserving battery power	32
Identifying low battery levels	33
Resolving a low battery level	33
Resolving a low battery level when external power is available	33
Resolving a low battery level when no power source is available	33
Resolving a low battery level when the computer cannot exit Hibernation	33
Storing a user-replaceable battery	33
Disposing of a user-replaceable battery	34
Replacing a user-replaceable battery	34

Running on AC power	34
Troubleshooting power problems	35
Shutting down (turning off) the computer	35
7 Maintaining your computer	37
Improving performance	37
Using Disk Defragmenter	37
Using Disk Cleanup	37
Updating programs and drivers	37
Cleaning your computer	38
Cleaning procedures	38
Cleaning the display	38
Cleaning the sides or cover	38
Cleaning the TouchPad, keyboard, or mouse (select models only)	39
Traveling with or shipping your computer	39
8 Securing your computer and information	40
Using passwords	40
Setting Windows passwords	41
Setting Setup Utility (BIOS) passwords	41
Using Internet security software	42
Using antivirus software	42
Using firewall software	42
Installing software updates	42
Installing HP and third-party software updates	42
Installing critical security updates	43
Securing your wireless network	43
Backing up your software applications and information	43
Using an optional security cable lock	43
9 Using Setup Utility (BIOS)	45
Starting Setup Utility (BIOS)	45
Updating the BIOS	45
Determining the BIOS version	45
Downloading a BIOS update	46
10 Using HP PC Hardware Diagnostics (UEFI)	47
Downloading HP PC Hardware Diagnostics (UEFI) to a USB device	47

11 Backing up, restoring, and recovering	49
Creating recovery media and backups	49
Creating HP Recovery media (select models only)	49
Using Windows tools	50
Restore and recovery	50
Recovering using HP Recovery Manager	51
What you need to know before you get started	51
Using the HP Recovery partition (select models only)	52
Using HP Recovery media to recover	52
Changing the computer boot order	53
Removing the HP Recovery partition (select models only)	53
12 Specifications	54
Input power	54
Operating environment	54
13 Electrostatic Discharge	55
14 Accessibility	56
Supported assistive technologies	56
Contacting support	56
Index	57

1 Starting right

This computer is a powerful tool designed to enhance your work and entertainment. Read this chapter to learn about best practices after you set up your computer, fun things to do with your computer, and where to find additional HP resources.

Visit the HP Apps Store

The HP Apps Store offers a wide choice of popular games, entertainment and music apps, productivity apps, and apps exclusive to HP that you can download to the Start screen. The selection is updated regularly and includes regional content and country-specific offers. Be sure to check the HP Apps Store frequently for new and updated features.

 **IMPORTANT:** You must be connected to the Internet to access the HP Apps Store.

To view and download an app:

1. From the Start screen, select the **Store** app.
2. Select **HP picks** to view all the available apps.

 **NOTE:** **HP picks** is available in select countries only.

3. Select the app you want to download, and then follow the on-screen instructions. When the download is complete, the app appears on the All apps screen.

Best practices

After you set up and register the computer, we recommend the following steps to get the most out of your smart investment:

- Back up your hard drive by creating recovery media. See [Backing up, restoring, and recovering on page 49](#).
- If you haven't already done so, connect to a wired or wireless network. See details in [Connecting to a network on page 17](#).
- Become familiar with the computer hardware and software. For more information, see [Getting to know your computer on page 4](#) and [Enjoying entertainment features on page 22](#).
- Update or purchase antivirus software. See [Using antivirus software on page 42](#).

More HP resources

To locate resources that provide product details, how-to information, and more, use this table.

Resource	Contents
<i>Setup Instructions</i>	<ul style="list-style-type: none">• Overview of computer setup and features
Help and Support To access Help and Support: ▲ From the Start screen, type <code>help</code> , and then from the Search window, select Help and Support . For U.S. support, go to http://www.hp.com/go/contactHP . For worldwide support, go to http://welcome.hp.com/country/us/en/wwcontact_us.html .	<ul style="list-style-type: none">• A broad range of how-to information and troubleshooting tips
Worldwide support To get support in your language, go to http://welcome.hp.com/country/us/en/wwcontact_us.html .	<ul style="list-style-type: none">• Online chat with an HP technician• Support telephone numbers• HP service center locations
<i>Safety & Comfort Guide</i> To access this guide: 1. From the Start screen, type <code>support</code> , and then select the HP Support Assistant app. – or – From the Windows desktop, click the question mark icon in the notification area, at the far right of the taskbar. 2. Select My computer , and then select User guides . – or – Go to http://www.hp.com/ergo .	<ul style="list-style-type: none">• Proper workstation setup• Guidelines for posture and work habits that increase your comfort and decrease your risk of injury• Electrical and mechanical safety information
<i>Regulatory, Safety and Environmental Notices</i> To access this document: 1. From the Start screen, type <code>support</code> , and then select the HP Support Assistant app. – or – From the Windows desktop, click the question mark icon in the notification area, at the far right of the taskbar. 2. Select My computer , and then select User guides .	<ul style="list-style-type: none">• Important regulatory notices, including information about proper battery disposal
<i>Limited Warranty*</i> To access this document: 1. From the Start screen, type <code>support</code> , and then select the HP Support Assistant app. – or –	<ul style="list-style-type: none">• Specific warranty information about this computer

Resource	Contents
	From the Windows desktop, click the question mark icon in the notification area, at the far right of the taskbar.
2.	Select My computer , and then select Warranty and services .
– or –	
	Go to http://www.hp.com/go/orderdocuments .
	*You can find the expressly provided HP Limited Warranty applicable to your product located with the user guides on your computer and/or on the CD/DVD provided in the box. In some countries/regions, HP may provide a printed HP Limited Warranty in the box. For countries/regions where the warranty is not provided in printed format, you may request a printed copy from http://www.hp.com/go/orderdocuments or write to:
	<ul style="list-style-type: none">• North America: Hewlett-Packard, MS POD, 11311 Chinden Blvd., Boise, ID 83714, USA• Europe, Middle East, Africa: Hewlett-Packard, POD, Via G. Di Vittorio, 9, 20063, Cernusco s/Naviglio (MI), Italy• Asia Pacific: Hewlett-Packard, POD, P.O. Box 200, Alexandra Post Office, Singapore 911507
	When you request a printed copy of your warranty, please include your product number, warranty period (found on your service label), name, and postal address.
	IMPORTANT: Do NOT return your HP product to the addresses above. For U.S. support, go to http://www.hp.com/go/contactHP . For worldwide support, go to http://welcome.hp.com/country/us/en/wwcontact_us.html .

2 Getting to know your computer

Locating hardware

To find out what hardware is installed on your computer:

1. From the Start screen, type `control panel`, and then select **Control Panel**.

– or –

From the Windows desktop, right-click the **Start** button, and then select **Control Panel**.

2. Select **System and Security**, select **System**, and then click **Device Manager** in the left column.

A list displays all the devices installed on your computer.

For information about system hardware components and the system BIOS version number, press `fn+esc` (select models only).

Locating software

To find out what software is installed on your computer:





- ▲ From the Start screen, click the down arrow in the lower-left corner of the screen.

– or –

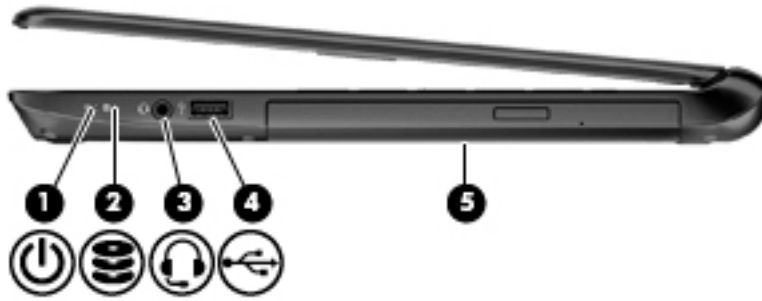
From the Windows desktop, right-click the **Start** button, and then select **Programs and Features**.





Right side

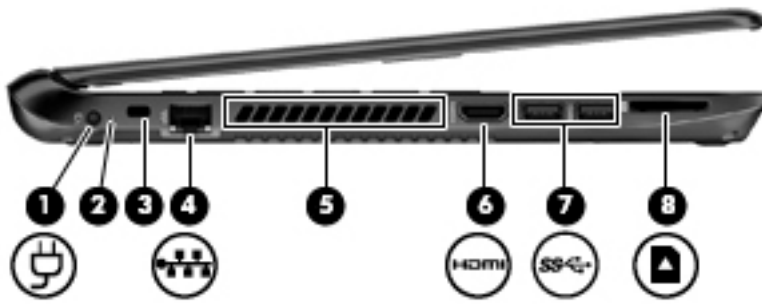

Component	Description
(1)  Power light	<ul style="list-style-type: none"> On: The computer is on. Blinking: The computer is in the Sleep state, a power-saving state. The computer shuts off power to the display and other components. Off: The computer is off or in Hibernation. Hibernation is a power-saving state that uses the least amount of power.
(2)  Hard drive light	Blinking white: The hard drive is being accessed.
(3)  Audio-out (headphone)/Audio-in (microphone) jack	<p>Connects optional powered stereo speakers, headphones, earbuds, a headset, or a television audio cable. Also connects an optional headset microphone. This jack does not support optional microphone-only devices.</p> <p>WARNING! To reduce the risk of personal injury, adjust the volume before putting on headphones, earbuds, or a headset. For additional safety information, refer to the <i>Regulatory, Safety, and Environmental Notices</i>.</p> <p>To access this document:</p> <ul style="list-style-type: none"> ▲ From the Start screen, type <code>support</code>, and then select the HP Support Assistant app. – or – From the Windows desktop, click the question mark icon in the notification area, at the far right of the taskbar. <p>NOTE: When a device is connected to the jack, the computer speakers are disabled.</p> <p>NOTE: Be sure that the device cable has a 4-conductor connector that supports both audio-out (headphone) and audio-in (microphone).</p>
(4)  USB 2.0 port	Connects an optional USB device, such as a keyboard, mouse, external drive, printer, scanner or USB hub.
(5) Optical drive (select models only)	<p>Depending on your computer model, reads an optical disc or reads and writes to an optical disc.</p> <p>NOTE: For disc compatibility information, go to the Help and Support web page (see More HP resources on page 2). Follow the web page instructions to select your computer model. Select Drivers & Downloads, and then follow the on-screen instructions.</p>

Left side



Component	Description
(1) Power connector	Connects an AC adapter.
(2) AC adapter light	<ul style="list-style-type: none"> On: The AC adapter is connected and the battery is charged. Off: The computer is using battery power. <p>– or –</p> <ul style="list-style-type: none"> White: The computer is connected to external power and the battery is charged from 90 to 99 percent. Amber: The computer is connected to external power and the battery is charged from 0 to 90 percent. Blinking amber: A battery that is the only available power source has reached a low battery level. When the battery reaches a critical battery level, the battery light begins blinking rapidly. Off: The battery is fully charged.
(3)  Security cable slot	Attaches an optional security cable to the computer. <p>NOTE: The security cable is designed to act as a deterrent, but it may not prevent the computer from being mishandled or stolen.</p>
(4)  RJ-45 (network) jack/status lights	Connects a network cable. <ul style="list-style-type: none"> White: The network is connected. Amber: Activity is occurring on the network.
(5) Vent	Enables airflow to cool internal components. <p>NOTE: The computer fan starts up automatically to cool internal components and prevent overheating. It is normal for the internal fan to cycle on and off during routine operation.</p>
(6)  HDMI port	Connects an optional video or audio device, such as a high-definition television, any compatible digital or audio component, or a high-speed High-Definition Multimedia Interface (HDMI) device.
(7)  USB 3.0 ports (2)	Connect optional USB devices, such as a keyboard, mouse, external drive, printer, scanner or USB hub.
(8)  Memory card reader	Reads optional memory cards that enable you to store, manage, share or access information.

Component	Description
	<p data-bbox="895 226 1038 249">To insert a card:</p> <ul data-bbox="895 270 1445 348" style="list-style-type: none"><li data-bbox="895 270 1445 348">▲ Hold the card label-side up, with connectors facing the slot, insert the card into the slot, and then push in on the card until it is firmly seated. <p data-bbox="895 369 1054 392">To remove a card:</p> <ul data-bbox="895 413 1286 436" style="list-style-type: none"><li data-bbox="895 413 1286 436">▲ Press in on the card it until it pops out.

Display



Component	Description
(1) WLAN antennas*	Send and receive wireless signals to communicate with wireless local area networks (WLANs).
(2) Webcam light	On: The webcam is in use.
(3) Webcam	Records video and captures photographs. Some models allow you to video conference and chat online using streaming video. To use the webcam: <ul style="list-style-type: none">▲ From the Start screen, type <i>camera</i>, and then select Camera from the list of applications.– or –From the Windows desktop, click the Start button, click All Programs to find your webcam software.
(4) Internal microphone	Records sound.

*The antennas are not visible from the outside of the computer. For optimal transmission, keep the areas immediately around the antennas free from obstructions. For wireless regulatory notices, see the section of the *Regulatory, Safety, and Environmental Notices* that applies to your country or region.

To access this document:

From the Start screen, type *support*, and then select the **HP Support Assistant** app.

– or –

From the Windows desktop, click the question mark icon in the notification area, at the far right of the taskbar.

Top

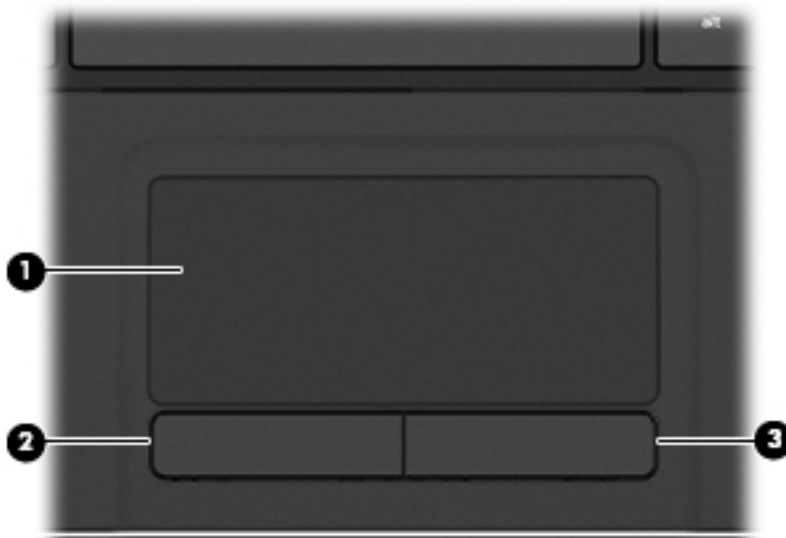

TouchPad

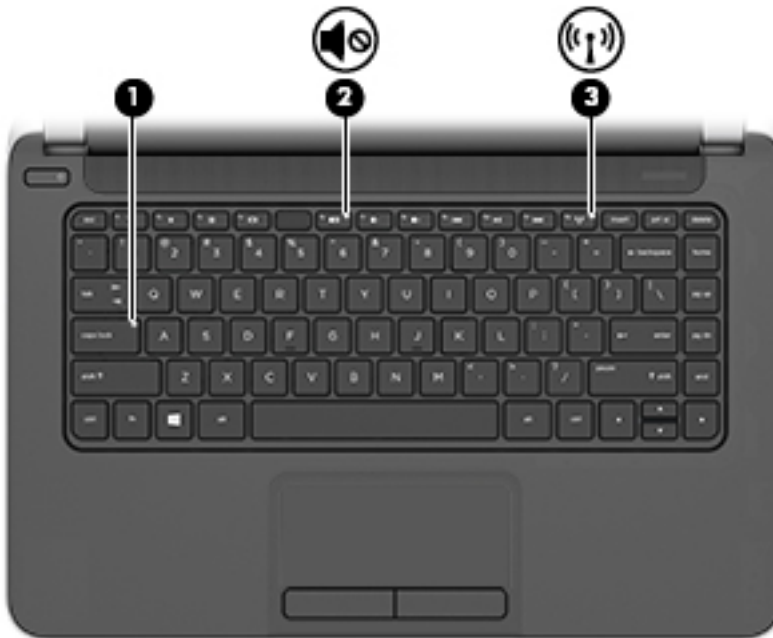

Component	Description
(1) TouchPad zone	Reads your finger gestures to move the pointer or activate items on the screen. NOTE: The TouchPad also supports edge-swipe gestures. For more information, see Using the TouchPad gestures on page 25 .
(2) Left TouchPad button	Functions like the left button on an external mouse.
(3) Right TouchPad button	Functions like the right button on an external mouse.

Lights



Component	Description
(1) Caps lock light	On: Caps lock is on, which switches the keys to all capital letters.
(2)  Mute light	<ul style="list-style-type: none">• Amber: Computer sound is off.• Off: Computer sound is on.
(3)  Wireless light	On: An integrated wireless device, such as a wireless local area network (WLAN) device and/or a Bluetooth® device, is on. NOTE: On some models, the wireless light is amber when all wireless devices are off.

Buttons and speakers

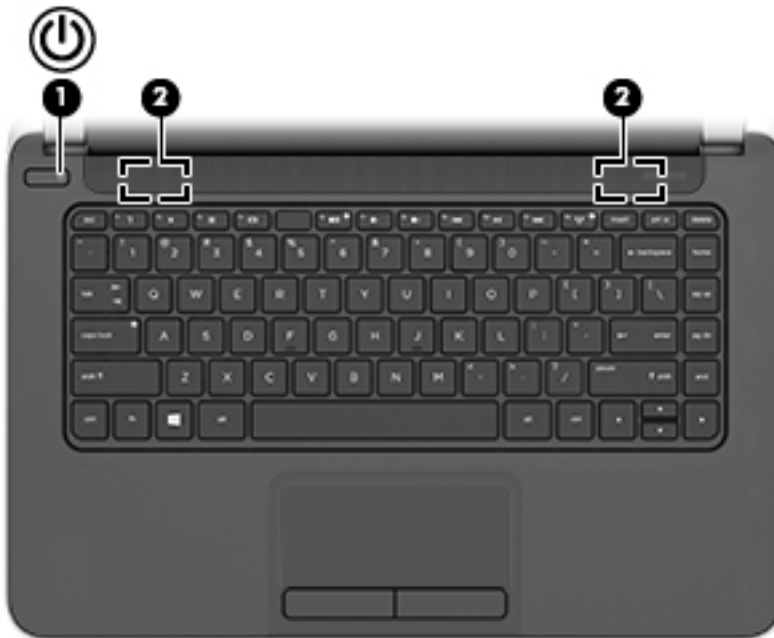

Component	Description
(1)  Power button	<ul style="list-style-type: none">• When the computer is off, press the button to turn on the computer.• When the computer is on, press the button briefly to initiate Sleep.• When the computer is in the Sleep state, press the button briefly to exit Sleep.• When the computer is in Hibernation, press the button briefly to exit Hibernation. <p>CAUTION: Pressing and holding down the power button will result in the loss of unsaved information.</p> <p>If the computer has stopped responding and Windows shutdown procedures are ineffective, press and hold the power button down for at least 5 seconds to turn off the computer.</p> <p>To learn more about your power settings, see your power options.</p> <p>▲ From the Start screen, type <code>power</code>, select Power and sleep settings, and then select Power and sleep from the list of applications.</p> <p>– or –</p> <p>From the Windows desktop, right-click the Start button, and then select Power Options.</p>
(2) Speakers (2)	Produce sound.

Keys

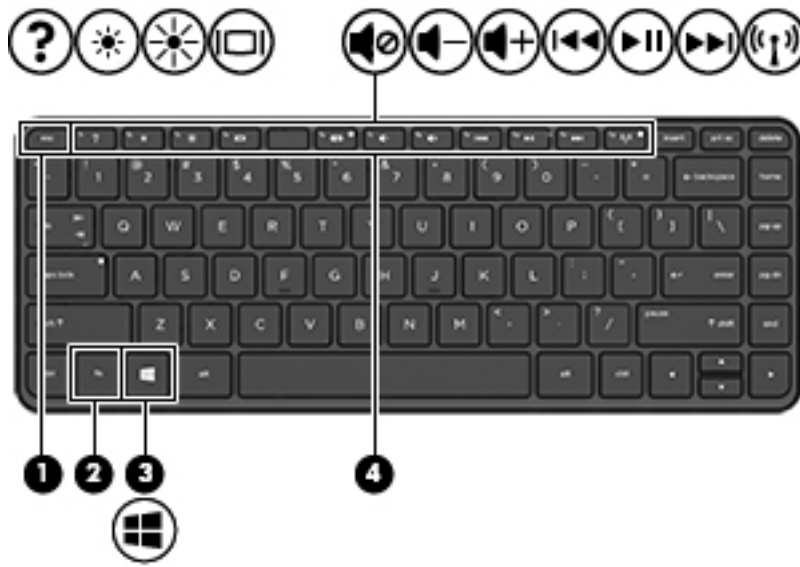

Component	Description
(1) <code>esc</code> key	Displays system information when pressed in combination with the <code>fn</code> key.
(2) <code>fn</code> key	Executes frequently used system functions when pressed in combination with the <code>esc</code> key.
(3)  Windows key	Returns you to the Start screen from an open app or the Windows desktop. NOTE: Pressing the Windows key again will return you to the previous screen.
(4) Action keys	Execute frequently used system functions.

Using the action keys

Depending on the model, your computer may have the function key features as described in this table.

An action key performs an assigned function. The icon on each of the action keys illustrates the assigned function for that key.

To use an action key function, press and hold the key.

CAUTION: Use extreme care when making changes in Setup Utility (BIOS). Errors can prevent the computer from operating properly.



NOTE: The action key feature is enabled at the factory. You can disable this feature in Setup Utility (BIOS). Refer to Help and Support for additional information.

After you have disabled the action key feature, you can still perform each function by pressing the `fn` key in combination with the appropriate action key.

Icon	Description
?	<p>Opens Help and Support, which provides tutorials, information about the Windows operating system and your computer, answers to questions, and updates to your computer.</p> <p>Help and Support also provides automated troubleshooting tools and access to support.</p>
☼	Decreases the screen brightness incrementally as long as you hold down the key.
☼	Increases the screen brightness incrementally as long as you hold down the key.
🖥️	Switches the screen image between display devices connected to the system. For example, if a monitor is connected to the computer, repeatedly pressing this key alternates the screen image from the computer display to the monitor display to a simultaneous display on both the computer and the monitor.
🔊	Mutes or restores speaker sound.
🔊-	Decreases speaker volume incrementally while you hold down the key.
🔊+	Increases speaker volume incrementally while you hold down the key.
⏮	Plays the previous track of an audio CD or the previous section of a DVD or a BD.
⏸	Begins, pauses, or resumes playback of an audio CD, a DVD, or a BD.
⏭	Plays the next track of an audio CD or the next section of a DVD or a BD.
📶	<p>Turns the wireless feature on or off.</p> <p>NOTE: A wireless network must be set up before a wireless connection is possible.</p>

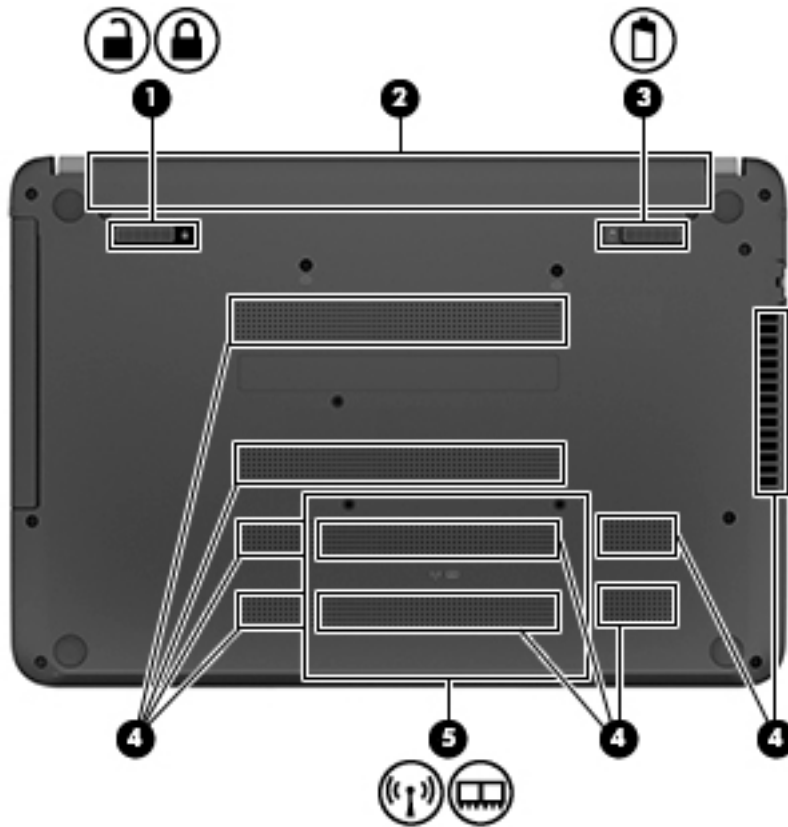
Bottom



Component	Description
(1) 	Battery lock Locks the battery in the battery bay.
(2)	Battery bay Holds the battery.
(3) 	Battery release latch Releases the battery.
(4)	Vents (9) Enable airflow to cool internal components. NOTE: The computer fan starts up automatically to cool internal components and prevent overheating. It is normal for the internal fan to cycle on and off during routine operation.
(5) 	Service door Provides access to the wireless local area network (WLAN) module slot and the memory module slots.

Component	Description
	<p>CAUTION: To prevent an unresponsive system, replace the wireless module only with a wireless module authorized for use in the computer by the governmental agency that regulates wireless devices in your country or region. If you replace the module and then receive a warning message, remove the module to restore computer functionality, and then contact support through Help and Support.</p> <p>▲ From the Start screen, type <code>help</code>, and then select Help and Support.</p> <p>- or -</p> <p>From the Windows desktop, click the question mark icon in the notification area, at the far right of the taskbar.</p>

Labels

The labels affixed to the computer provide information you may need when you troubleshoot system problems or travel internationally with the computer.

 **IMPORTANT:** Check the following locations for the labels described in this section: the bottom of the computer, inside the battery bay, under the removable service door, or on the back of the display.

- Service label—Provides important information to identify your computer. When contacting support, you will probably be asked for the serial number, and possibly for the product number or the model number. Locate these numbers before you contact support.

Your service label will resemble one of the examples shown below. Refer to the illustration that most closely matches the service label on your computer.

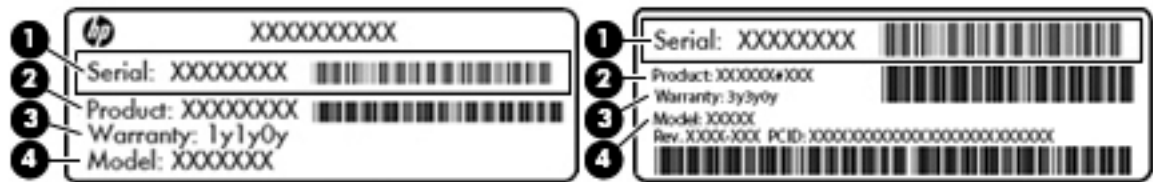

Component	
(1)	Serial number
(2)	Product number
(3)	Warranty period
(4)	Model number (select models only)

- Microsoft® Certificate of Authenticity label (select models only prior to Windows 8)—Contains the Windows Product Key. You may need the Product Key to update or troubleshoot the operating system. HP platforms with Windows 8 or Windows 8.x preinstalled do not have the physical label. Instead a Digital Product Key is electronically installed.

 **NOTE:** The Digital Product Key is automatically recognized and activated by Microsoft operating systems when a Windows 8 or Windows 8.x operating system is reinstalled using HP-approved recovery methods.

- Regulatory label(s)—Provide(s) regulatory information about the computer.
- Wireless certification label(s)—Provide(s) information about optional wireless devices and the approval markings for the countries or regions in which the devices have been approved for use.

3 Connecting to a network

Your computer can travel with you wherever you go. But even at home, you can explore the globe and access information from millions of websites using your computer and a wired or wireless network connection. This chapter will help you get connected to that world.

Connecting to a wireless network

Your computer may be equipped with one or more of the following wireless devices:

- **WLAN device**—Connects the computer to wireless local area networks (commonly referred to as Wi-Fi networks, wireless LANs, or WLANs) in corporate offices, your home, and public places such as airports, restaurants, coffee shops, hotels, and universities. In a WLAN, the mobile wireless device in your computer communicates with a wireless router or a wireless access point.
- **Bluetooth device**—Creates a personal area network (PAN) to connect to other Bluetooth-enabled devices such as computers, phones, printers, headsets, speakers, and cameras. In a PAN, each device communicates directly with other devices, and devices must be relatively close together—typically within 10 meters (approximately 33 feet) of each other.

For more information about wireless technology, the Internet, and networking, see the information and website links provided in Help and Support.

▲ From the Start screen, type `help`, and then select **Help and Support**.

– or –

From the Windows desktop, click the question mark icon in the notification area, at the far right of the taskbar.

Using the wireless controls

You can control the wireless devices in your computer using one or more of these features:

- Wireless button or wireless key (also called the airplane mode key) (referred to in this chapter as the wireless button)
- Operating system controls

Wireless button

The computer has a wireless button, one or more wireless devices, and, on select models, one or two wireless lights. All the wireless devices on your computer are enabled at the factory. If your computer has a wireless light, the wireless light is on (white) when your computer is on.

The wireless light indicates the overall power state of your wireless devices, not the status of individual devices. If the wireless light is white, at least one wireless device is on. If the wireless light is off, all wireless devices are off.

 **NOTE:** On some models, the wireless light is amber when all wireless devices are off.

Because the wireless devices are enabled at the factory, you can use the wireless button to turn on or turn off all the wireless devices simultaneously.

Operating system controls

The Network and Sharing Center allows you to set up a connection or network, connect to a network, and diagnose and repair network problems.

To use operating system controls:

1. From the Start screen, type `control panel`, and then select **Control Panel**.

– or –

From the Windows desktop, right-click the **Start** button, and then select **Control Panel**.

2. Select **Network and Internet**, and then select **Network and Sharing Center**.

For more information, see the information provided in Help and Support.

- ▲ From the Start screen, type `help`, and then select **Help and Support**.

– or –

From the Windows desktop, click the question mark icon in the notification area, at the far right of the taskbar.

Connecting to a WLAN

To connect to a WLAN, follow these steps:

1. Be sure that the WLAN device is on. On select models, if the device is on, the wireless light is white. If the wireless light is off, press the wireless button.



NOTE: On some models, the wireless light is amber when all wireless devices are off.

2. From the Start screen or the Windows desktop, point to the upper-right or lower-right corner of the display to reveal the charms.
3. Select **Settings**, and then click the network status icon.
4. Select your WLAN from the list.
5. Click **Connect**.

If the WLAN is a security-enabled WLAN, you are prompted to enter a security code. Type the code, and then click **Next** to complete the connection.



NOTE: If no WLANs are listed, you may be out of range of a wireless router or access point.



NOTE: If you do not see the WLAN you want to connect to, from the Windows desktop, right-click the network status icon, and then select **Open Network and Sharing Center**. Click **Set up a new connection or network**. A list of options is displayed, allowing you to manually search for and connect to a network or to create a new network connection.

6. Follow the on-screen instructions to complete the connection.

After the connection is made, place the mouse pointer over the network status icon in the notification area, at the far right of the taskbar, to verify the name and status of the connection.



NOTE: The functional range (how far your wireless signals travel) depends on WLAN implementation, router manufacturer, and interference from other electronic devices or structural barriers such as walls and floors.

Using a WLAN

With a WLAN device, you can access a wireless local area network (WLAN), which is composed of other computers and accessories that are linked by a wireless router or a wireless access point.

 **NOTE:** The terms *wireless router* and *wireless access point* are often used interchangeably.

- A large-scale WLAN, such as a corporate or public WLAN, typically uses wireless access points that can accommodate a large number of computers and accessories and can separate critical network functions.
- A home or small office WLAN typically uses a wireless router, which allows several wireless and wired computers to share an Internet connection, a printer, and files without requiring additional pieces of hardware or software.

To use the WLAN device in your computer, you must connect to a WLAN infrastructure (provided through a service provider or a public or corporate network).

Using an Internet service provider

When you are setting up Internet access in your home, you must establish an account with an Internet service provider (ISP). To purchase Internet service and a modem, contact a local ISP. The ISP will help set up the modem, install a network cable to connect your wireless router to the modem, and test the Internet service.

 **NOTE:** Your ISP will give you a user ID and a password to use for Internet access. Record this information and store it in a safe place.

Setting up a WLAN

To set up a WLAN and connect to the Internet, you need the following equipment:

- A broadband modem (either DSL or cable) **(1)** and high-speed Internet service purchased from an Internet service provider
- A wireless router **(2)** (purchased separately)
- A wireless computer **(3)**

 **NOTE:** Some modems have a built-in wireless router. Check with your ISP to determine what type of modem you have.

The illustration below shows an example of a wireless network installation that is connected to the Internet.

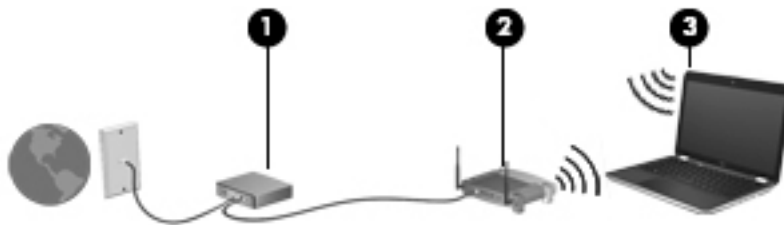

As your network grows, additional wireless and wired computers can be connected to the network to access the Internet.

For help in setting up your WLAN, see the information provided by your router manufacturer or your ISP.

Configuring a wireless router

For help in configuring a wireless router, see the information provided by your router manufacturer or your ISP.



NOTE: It is recommended that you initially connect your new wireless computer to the router by using the network cable provided with the router. When the computer successfully connects to the Internet, disconnect the cable, and access the Internet through your wireless network.

Protecting your WLAN

When you set up a WLAN or access an existing WLAN, always enable security features to protect your network from unauthorized access. WLANs in public areas (hotspots) like coffee shops and airports may not provide any security. If you are concerned about the security of your computer when connected to a hotspot, limit your network activities to email that is not confidential and basic Internet surfing.

Wireless radio signals travel outside the network, so other WLAN devices can pick up unprotected signals. Take the following precautions to protect your WLAN:

- Use a firewall.

A firewall checks information and requests that are sent to your network, and discards any suspicious items. Firewalls are available in both software and hardware. Some networks use a combination of both types.

- Use wireless encryption.

Wireless encryption uses security settings to encrypt and decrypt data that is transmitted over the network. For more information, from the Start screen, type `help`, and then select **Help and Support**.

Using Bluetooth wireless devices (select models only)

A Bluetooth device provides short-range wireless communications that replace the physical cable connections that traditionally link electronic devices such as the following:

- Computers (desktop, notebook)
- Phones (cellular, cordless, smartphone)
- Imaging devices (printer, camera)
- Audio devices (headset, speakers)
- Mouse
- External keyboard

Bluetooth devices provide peer-to-peer capability that allows you to set up a PAN of Bluetooth devices. For information about configuring and using Bluetooth devices, see the Bluetooth software Help.

Connecting to a wired network—LAN (select models only)

Use a LAN connection if you want to connect the computer directly to a router in your home (instead of working wirelessly), or if you want to connect to an existing network at your office.

Connecting to a LAN requires an 8-pin, RJ-45 (network) cable and a network jack on the computer.

To connect the network cable, follow these steps:

1. Plug the network cable into the network jack **(1)** on the computer.
2. Plug the other end of the network cable into a network wall jack **(2)** or router.

 **NOTE:** If the network cable contains noise suppression circuitry **(3)**, which prevents interference from TV and radio reception, orient the circuitry end of the cable toward the computer.

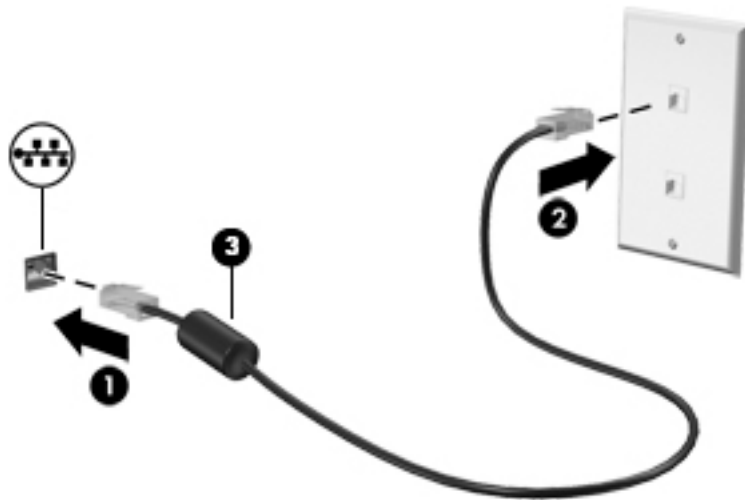

Sharing data and drives and accessing software

When your computer is part of a network, you are not limited to using only the information that is stored in your computer. Computers connected to the network can exchange software and data with each other.

For more information about sharing files, folders, or drives, see the information provided in Help and Support.

- ▲ From the Start screen, type `help`, and then select **Help and Support**.

– or –

From the Windows desktop, click the question mark icon in the notification area, at the far right of the taskbar.

 **NOTE:** When a disc like a DVD movie or game is copy-protected, it cannot be shared.

4 Enjoying entertainment features

Use your HP computer as an entertainment hub to socialize via the webcam, enjoy and manage your music, and download and watch movies. Or, to make your computer an even more powerful entertainment center, connect external devices like a monitor, projector, or TV, or speakers and headphones.

Using a webcam

The computer has an integrated webcam that records video and captures photographs. Some models may allow you to video conference and chat online using streaming video.

- ▲ To start the webcam, from the Start screen, type `camera`, and then select **Camera** from the list of applications.

For details about using the webcam, go to Help and Support.

- ▲ From the Start screen, type `help`, and then select **Help and Support**.

– or –

From the Windows desktop, click the question mark icon in the notification area, at the far right of the taskbar.

Using audio

On your computer, or on select models using an external optical drive, you can play music CDs, download and listen to music, stream audio content from the web (including radio), record audio, or mix audio and video to create multimedia. To enhance your listening enjoyment, attach external audio devices such as speakers or headphones.

Connecting speakers

You can attach wired speakers to your computer by connecting them to a USB port or to the audio-out (headphone) jack on your computer or on a docking station.

To connect wireless speakers to your computer, follow the device manufacturer's instructions. To connect high-definition speakers to the computer, see [Setting up HDMI audio on page 24](#). Before connecting speakers, lower the volume setting.

Connecting headphones

-
- ⚠ **WARNING!** To reduce the risk of personal injury, lower the volume setting before putting on headphones, earbuds, or a headset. For additional safety information, see the *Regulatory, Safety and Environmental Notices*. To access this document, from the Start screen, type `support`, and then select the **HP Support Assistant** app.
-

You can connect wired headphones to the headphone jack or to the audio-out (headphone)/audio-in (microphone) combo jack on your computer.

To connect wireless headphones to your computer, follow the device manufacturer's instructions.

Connecting headsets

WARNING! To reduce the risk of personal injury, lower the volume setting before putting on headphones, earbuds, or a headset. For additional safety information, see the *Regulatory, Safety and Environmental Notices*. To access this document, from the Start screen, type `support`, and then select the **HP Support Assistant** app.

Headphones combined with a microphone are called *headsets*. You can connect wired headsets to the audio-out (headphone)/audio-in (microphone) jack on your computer.

To connect *wireless* headsets to your computer, follow the device manufacturer's instructions.

Using video

Your computer is a powerful video device that enables you to watch streaming video from your favorite websites and download video and movies to watch on your computer when you are not connected to a network.

To enhance your viewing enjoyment, use one of the video ports on the computer to connect an external monitor, projector, or TV.

IMPORTANT: Be sure that the external device is connected to the correct port on the computer, using the correct cable. Follow the device manufacturer's instructions.

For information on using your video features, refer to Help and Support.

Connecting video devices using an HDMI cable

NOTE: To connect an HDMI device to your computer, you need an HDMI cable, purchased separately.

To see the computer screen image on a high-definition TV or monitor, connect the high-definition device according to the following instructions:

1. Connect one end of the HDMI cable to the HDMI port on the computer.

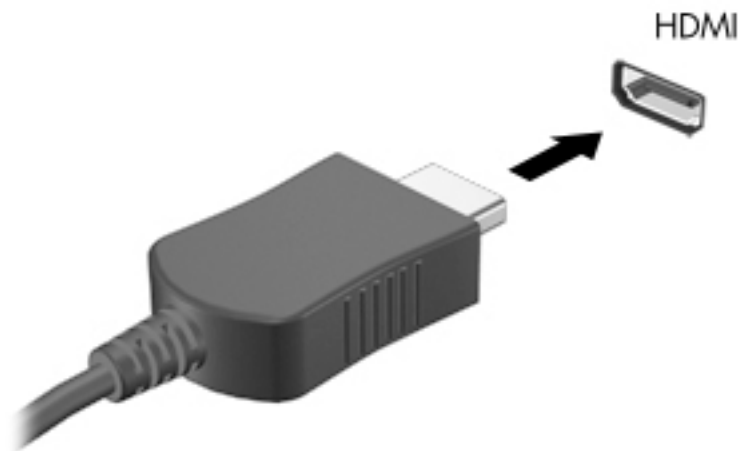

2. Connect the other end of the cable to the high-definition TV or monitor.
3. Press `f4` to alternate the computer screen image between 4 display states:

- **PC screen only:** View the screen image on the computer only.
- **Duplicate:** View the screen image simultaneously on both the computer and the external device.
- **Extend:** View the screen image extended across the computer and the external device.
- **Second screen only:** View the screen image on the external device only.

Each time you press **f4**, the display state changes.



NOTE: For best results, especially if you choose the "Extend" option, increase the screen resolution of the external device, as follows. From the Start screen, type `control panel`, and then select **Control Panel**. Select **Appearance and Personalization**. Under **Display**, select **Adjust screen resolution**.

Setting up HDMI audio

HDMI is the only video interface that supports high-definition video and audio. After you connect an HDMI TV to the computer, you can then turn on HDMI audio by following these steps:

1. From the Windows desktop, right-click the **Speakers** icon in the notification area, at the far right of the taskbar, and then select **Playback devices**.
2. On the **Playback** tab, select the name of the digital output device.
3. Click **Set Default**, and then click **OK**.

To return the audio stream to the computer speakers:

1. From the Windows desktop, right-click the **Speakers** icon in the notification area, at the far right of the taskbar, and then click **Playback devices**.
2. On the Playback tab, click **Speakers**.
3. Click **Set Default**, and then click **OK**.

Connecting Miracast-compatible wireless displays (select models only)

To discover and connect to Miracast-compatible wireless displays, follow the steps below.

To open Miracast:

- ▲ Point to the upper-right or lower-right corner of the Start screen or the Windows desktop to display the charms, click **Devices**, click **Project**, and then follow the on-screen instructions.

– or –

On select computer models, from the Start screen, click the **HP Quick Access to Miracast** icon, and then follow the on-screen instructions.

5 Navigating the screen

To quickly return to the Start screen, press the Windows key  on a keyboard.

You can navigate the computer screen in the following ways:

- Touch gestures
- Keyboard and optional mouse (purchased separately)

 **NOTE:** An external USB mouse (purchased separately) can be connected to a USB ports on the computer.

Using the TouchPad gestures

The TouchPad helps you navigate the computer screen and control the pointer using simple touch gestures. You can also customize gestures and view demonstrations of how they work.

From the Start screen, type `control panel`, select **Control Panel**, and then select **Hardware and Sound**. Under **Devices and Printers**, select **Mouse**.

 **NOTE:** TouchPad gestures are not supported in all apps.

Tap

Use the tap/double-tap gesture to select or open an item on the screen.

- Point to an item on the screen, and then tap one finger on the TouchPad zone select it. Double-tap an item to open it.



Two-finger scroll

Use the two-finger scroll gesture to move up, down, or sideways on a page or image.

- Place two fingers slightly apart on the TouchPad zone and then drag them up, down, left, or right.

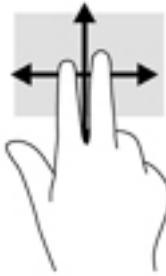

Two-finger pinch zoom

Use the two-finger pinch zoom to zoom out or in on images or text.

- Zoom out by placing two fingers apart on the TouchPad zone and then moving your fingers together.
- Zoom in by placing two fingers together on the TouchPad zone and then moving your fingers apart.



Two-finger click

Use the two-finger click gesture to open the menu for an object on the screen.

 **NOTE:** The two-finger click performs the same function as right-clicking with the mouse.

- Place two fingers on the TouchPad zone and press down to open the options menu for the selected object.



Right-edge swipe

Use the right-edge swipe to reveal the charms, which let you search, share, start apps, access devices, or change settings.

- Gently swipe your finger inward from the right edge of the TouchPad to reveal the charms.

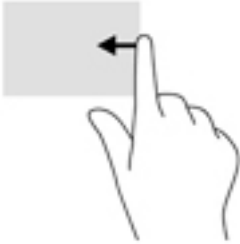

Left-edge swipe

Use the left-edge swipe to reveal your open apps so that you can access them quickly.

- Gently swipe your finger inward from the left edge of the TouchPad to switch between apps. Without lifting your finger, swipe back toward the left edge to reveal all open apps.



Top-edge swipe and bottom-edge swipe

Use the top-edge swipe or bottom-edge swipe to display command options that allow you to customize an open app.

 **IMPORTANT:** When an app is open, the top-edge swipe varies depending on the app.

- Gently swipe your finger from the top edge or the bottom edge to reveal the app command options.

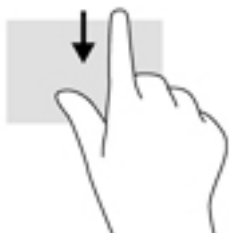

Using the keyboard and optional mouse

The keyboard and mouse allow you to type, select items, scroll and to perform the same functions as you do using touch gestures. The keyboard also allows you to use action keys and hot keys to perform specific functions.



TIP: The Windows key  on a keyboard allows you to quickly return to the Start screen from an open app or the Windows desktop. Press the button or key again to return to the previous screen.



NOTE: Depending on the country or region, your keyboard may have different keys and keyboard functions than those discussed in this section.

6 Managing power

Your computer can operate on either battery power or external power. When the computer is running on battery power only and an AC power source is not available to charge the battery, it is important to monitor and conserve the battery charge.

Initiating and exiting Sleep and Hibernation

Windows has two power-saving states, Sleep and Hibernation.

- **Sleep**—The Sleep state is automatically initiated after a period of inactivity. Your work is saved to memory, allowing you to resume your work very quickly. You can also initiate Sleep manually. For more information, see [Manually initiating and exiting Sleep on page 30](#).
- **Hibernation**—The Hibernation state is automatically initiated if the battery reaches a critical level. In the Hibernation state, your work is saved to a hibernation file and the computer powers down. You can also initiate Hibernation manually. For more information, see [Manually initiating and exiting Hibernation \(select models only\) on page 30](#).

 **CAUTION:** To reduce the risk of possible audio and video degradation, loss of audio or video playback functionality, or loss of information, do not initiate the Sleep state while reading from or writing to a disc or an external media card.

 **NOTE:** You cannot initiate any type of networking connection or perform any computer functions while the computer is in the Sleep state or in the Hibernation state.

Manually initiating and exiting Sleep

You can initiate Sleep in any of the following ways:

- Close the display.
- From the Start screen or the Windows desktop, point to the upper-right or lower-right corner of the screen to reveal the charms. Click **Settings**, click the **Power** icon, and then click **Sleep**.

You can exit Sleep in any of the following ways:

- Briefly press the power button.
- If the computer is closed, raise the display.
- Press a key on the keyboard.
- Tap or swipe the TouchPad.

When the computer exits Sleep, the power lights turn on and your work returns to the screen.



NOTE: If you have set a password to be required on exiting Sleep, you must enter your Windows password before your work returns to the screen.

Manually initiating and exiting Hibernation (select models only)

You can enable user-initiated Hibernation and change other power settings and timeouts using Power Options.

1. From the Start screen, type `power options`, and then select **Power options**.

– or –

From the Windows desktop, right-click the **Start** button, and then click **Power Options**.

2. In the left pane, click **Choose what the power button does**.
3. Click **Change Settings that are currently unavailable**.
4. In the **When I press the power button** area, select **Hibernate**.
5. Click **Save changes**.

To exit Hibernation:

- ▲ Briefly press the power button.

When the computer exits Hibernation, the power lights turn on and your work returns to the screen.



NOTE: If you have set a password to be required on exiting Hibernation, you must enter your Windows password before your work returns to the screen.

Setting password protection on wakeup (exiting Sleep or Hibernation)

To set the computer to prompt for a password when the computer exits Sleep or Hibernation, follow these steps:

1. From the Start screen, type `power options`, and then select **Power options**.

– or –

From the Windows desktop, right-click the **Start** button, and then click **Power Options**.

2. In the left pane, click **Require a password on wakeup**.

3. Click **Change Settings that are currently unavailable**.
4. Click **Require a password (recommended)**.



NOTE: If you need to create a user account password or change your current user account password, click **Create or change your user account password**, and then follow the on-screen instructions. If you do not need to create or change a user account password, go to step 5.

5. Click **Save changes**.

Using the power meter and power settings

The power meter is located on the Windows desktop. The power meter allows you to quickly access power settings and view the remaining battery charge.

- To view the percentage of remaining battery charge and the current power plan, place the mouse pointer over the power meter icon.
- To use Power Options, click the power meter icon and select an item from the list. From the Start screen, you can also type `power options`, and then select **Power Options**.

Different power meter icons indicate whether the computer is running on battery or external power. Placing the mouse pointer over the icon reveals a message if the battery has reached a low or critical battery level.

Running on battery power

When a charged battery is in the computer and the computer is not plugged into external power, the computer runs on battery power. When the computer is off and unplugged from external power, the battery in the computer slowly discharges. The computer will display a message when the battery reaches a low or critical battery level.

Computer battery life varies, depending on power management settings, programs running on the computer, screen brightness, external devices connected to the computer, and other factors.

User-replaceable battery

WARNING! To reduce potential safety issues, use only the user-replaceable battery provided with the computer, a replacement battery provided by HP, or a compatible battery purchased from HP.

CAUTION: Removing a user-replaceable battery that is the sole power source for the computer can cause loss of information. To prevent loss of information, save your work or shut down the computer through Windows before removing the battery.

To remove the user-replaceable battery (select models only), refer to the steps and illustration that most closely match your computer:

1. Turn the computer upside down on a flat surface.
2. Slide the battery lock **(1)** to unlock the battery.
3. Slide the battery release latch **(2)** to release the battery.



NOTE: The battery release latch automatically returns to its original position.

4. Remove the battery from the computer **(3)**.



Finding battery information

To access battery information:

1. From the Start screen, type `support`, and then select the **HP Support Assistant** app.

– or –

From the Windows desktop, click the question mark icon in the notification area, at the far right of the taskbar.

2. Select **Battery and Performance**.

HP Support Assistant provides the following tools and information about the battery:

- Battery Check
- Information about battery types, specifications, life cycles, and capacity

Conserving battery power

To conserve battery power and maximize battery life:

- Lower the brightness of the display.
- Select the **Power saver** setting in Power Options.
- If the computer will be unused and unplugged from external power for more than 2 weeks, remove the user-replaceable battery from the computer and store it separately in a cool, dry place.
- Turn off wireless devices when you are not using them.
- Disconnect unused external devices that are not plugged into an external power source, such as an external hard drive connected to a USB port.
- Stop, disable, or remove any external media cards that you are not using.
- Before you leave your work, initiate Sleep or shut down the computer.

Identifying low battery levels

When a battery that is the sole power source for the computer reaches a low or critical battery level, the following behavior occurs:

- The battery light (select models only) indicates a low or critical battery level.

– or –

- The power meter icon on the Windows desktop shows a low or critical battery notification.



NOTE: For additional information about the power meter, see [Using the power meter and power settings on page 31](#).

The computer takes the following actions for a critical battery level:

- If Hibernation is disabled and the computer is on or in the Sleep state, the computer remains briefly in the Sleep state, and then shuts down and loses any unsaved information.
- If Hibernation is enabled and the computer is on or in the Sleep state, the computer initiates Hibernation.

Resolving a low battery level

Resolving a low battery level when external power is available

Connect one of the following to the computer and to external power:

- AC adapter
- Optional docking or expansion device
- Optional power adapter purchased as an accessory from HP

Resolving a low battery level when no power source is available

Save your work and shut down the computer.

Resolving a low battery level when the computer cannot exit Hibernation

1. Replace the discharged user-replaceable battery with a charged battery, or connect the AC adapter to the computer and to external power.
2. Exit Hibernation by pressing the power button.

Storing a user-replaceable battery

 **CAUTION:** To reduce the risk of damage to a battery, do not expose it to high temperatures for extended periods of time.

If a computer will be unused and unplugged from external power for more than 2 weeks, remove the battery and store it separately in a cool, dry place to prolong the battery charge.

A stored battery should be checked every 6 months. If the capacity is less than 50 percent, recharge the battery before returning it to storage.

Disposing of a user-replaceable battery

⚠ WARNING! To reduce the risk of fire or burns, do not disassemble, crush, or puncture; do not short external contacts; do not dispose of in fire or water.

See the *Regulatory, Safety and Environmental Notices* for proper battery disposal.

To access this document:

▲ From the Start screen, type `support`, and then select the **HP Support Assistant** app.

– or –

From the Windows desktop, click the question mark icon in the notification area, at the far right of the taskbar.

Replacing a user-replaceable battery

Battery Check in HP Support Assistant notifies you to replace the battery when an internal cell is not charging properly or when the battery storage capacity has reached a weak condition. If the battery is possibly covered by an HP warranty, instructions include a warranty ID. A message refers you to the HP website for more information about ordering a replacement battery.

Running on AC power

For information about connecting to AC power, refer to the *Setup Instructions* poster provided in the computer box.

The computer does not use battery power when the computer is connected to AC power with an approved AC adapter or an optional docking/expansion device.

⚠ WARNING! To reduce potential safety issues, use only the AC adapter provided with the computer, a replacement AC adapter provided by HP, or a compatible AC adapter purchased from HP.

Connect the computer to AC power under any of the following conditions:

⚠ WARNING! Do not charge the computer battery while you are aboard aircraft.

- When charging or calibrating a battery
- When installing or modifying system software
- When writing information to a disc (select models only)
- When running Disk Defragmenter on computers with internal hard drives
- When performing a backup or recovery

When you connect the computer to AC power:

- The battery begins to charge.
- The screen brightness increases.
- The power meter icon on the Windows desktop changes appearance.

When you disconnect AC power:

- The computer switches to battery power.
- The screen brightness automatically decreases to save battery life.
- The power meter icon on the Windows desktop changes appearance.

Troubleshooting power problems

Test the AC adapter if the computer exhibits any of the following symptoms when it is connected to AC power:

- The computer does not turn on.
- The display does not turn on.
- The power lights do not turn on.

To test the AC adapter:

1. Shut down the computer.
2. Connect the AC adapter to the computer, and then plug it into an AC outlet.
3. Turn on the computer.
 - If the power lights turn *on*, the AC adapter is working properly.
 - If the power lights remain *off*, check the connection from the AC adapter to the computer and the connection from the AC adapter to the AC outlet to be sure that the connections are secure.
 - If the connections are secure and the power lights remain *off*, the AC adapter is not functioning and should be replaced.

Contact support for information about obtaining a replacement AC power adapter.

Shutting down (turning off) the computer

 **CAUTION:** Unsaved information is lost when the computer shuts down. Be sure to save your work before shutting down the computer.

The Shut down command closes all open programs, including the operating system, and then turns off the display and computer.

Shut down the computer under any of the following conditions:

- When you need to replace the battery or access components inside the computer
- When you are connecting an external hardware device that does not connect to a USB or video port
- When the computer will be unused and disconnected from external power for an extended period

Although you can turn off the computer with the power button, the recommended procedure is to use the Windows Shut down command.

 **NOTE:** If the computer is in the Sleep state or in Hibernation, first exit Sleep or Hibernation by briefly pressing the power button.

1. Save your work and close all open programs.
2. From the Start screen or the Windows desktop, point to the upper-right or lower-right corner of the screen to reveal the charms.
3. Click **Settings**, click the **Power** icon, and then click **Shut down**.

– or –

Right-click the **Start** button in the lower-left corner of the screen, select **Shut down or sign out**, and then select **Shut down**.

If the computer is unresponsive and you are unable to use the preceding shutdown procedures, try the following emergency procedures in the sequence provided:

- Press **ctrl+alt+delete**, click the **Power** icon, and then select **Shut Down**.
- Press and hold the power button for at least 5 seconds.
- Disconnect the computer from external power.
- On models with a user-replaceable battery, remove the battery.

7 Maintaining your computer

It is important to perform regular maintenance to keep your computer in optimal condition. This chapter explains how to use tools like Disk Defragmenter and Disk Cleanup. It also provides instructions for updating programs and drivers, steps to clean the computer, and tips for traveling with (or shipping) the computer.

Improving performance

You can improve the performance of your computer by performing regular maintenance tasks with tools such as Disk Defragmenter and Disk Cleanup.

Using Disk Defragmenter

HP recommends using Disk Defragmenter to defragment your hard drive at least once a month.



NOTE: It is not necessary to run Disk Defragmenter on solid-state drives.

To run Disk Defragmenter:

1. Connect the computer to AC power.
2. From the Start screen, type `defragment`, and then select **Defragment and optimize your drives**.
3. Follow the on-screen instructions.

For additional information, access the Disk Defragmenter software Help.

Using Disk Cleanup

Use Disk Cleanup to search the hard drive for unnecessary files that you can safely delete to free up disk space and help the computer run more efficiently.

To run Disk Cleanup:

1. From the Start screen, type `disk`, and then select one of the following:
 - **Free up disk space on this PC**
 - **Uninstall apps to free up disk space**
 - **Free up disk space by deleting unnecessary files**
2. Follow the on-screen instructions.

Updating programs and drivers

HP recommends that you update your programs and drivers on a regular basis. Updates can resolve issues and bring new features and options to your computer. For example, older graphics components might not work well with the most recent gaming software. Without the latest driver, you would not be getting the most out of your equipment.

Go to <http://www.hp.com/support> to download the latest versions of HP programs and drivers. In addition, register to receive automatic notifications when updates become available.

If you would like to update your programs and drivers, follow these instructions:

1. From the Start screen, type `support`, and then select the **HP Support Assistant** app.

-or-

From the Windows desktop, click the question mark icon in the notification area, at the far right of the taskbar.

2. Click **Updates and tune-ups**, and then click **Check for HP updates now**.
3. Follow the on-screen instructions.

Cleaning your computer

Use the following products to safely clean your computer:

- Dimethyl benzyl ammonium chloride 0.3 percent maximum concentration (for example, disposable wipes, which come in a variety of brands)
- Alcohol-free glass-cleaning fluid
- Solution of water and mild soap
- Dry microfiber cleaning cloth or a chamois (static-free cloth without oil)
- Static-free cloth wipes

⚠ CAUTION: Avoid strong cleaning solvents that can permanently damage your computer. If you are not sure that a cleaning product is safe for your computer, check the product contents to make sure that ingredients such as alcohol, acetone, ammonium chloride, methylene chloride, and hydrocarbons are not included in the product.

Fibrous materials, such as paper towels, can scratch the computer. Over time, dirt particles and cleaning agents can get trapped in the scratches.

Cleaning procedures

Follow the procedures in this section to safely clean your computer.

⚠ WARNING! To prevent electric shock or damage to components, do not attempt to clean your computer while it is on.

1. Turn off the computer.
2. Disconnect AC power.
3. Disconnect all powered external devices.

⚠ CAUTION: To prevent damage to internal components, do not spray cleaning agents or liquids directly on any computer surface. Liquids dripped on the surface can permanently damage internal components.

Cleaning the display

Gently wipe the display using a soft, lint-free cloth moistened with an alcohol-free glass cleaner. Be sure that a display is dry before you close the computer.

Cleaning the sides or cover

To clean the sides or cover, use a soft microfiber cloth or chamois moistened with one of the cleaning solutions listed previously, or use an acceptable disposable wipe.

 **NOTE:** When cleaning the cover of the computer, use a circular motion to aid in removing dirt and debris.

Cleaning the TouchPad, keyboard, or mouse (select models only)

 **WARNING!** To reduce the risk of electric shock or damage to internal components, do not use a vacuum cleaner attachment to clean the keyboard. A vacuum cleaner can deposit household debris on the keyboard surface.

 **CAUTION:** To prevent damage to internal components, do not allow liquids to drip between the keys.

- To clean the TouchPad, keyboard, or mouse, use a soft microfiber cloth or a chamois moistened with one of the cleaning solutions listed previously or use an acceptable disposable wipe.
- To prevent keys from sticking and to remove dust, lint, and particles from the keyboard, use a can of compressed air with a straw extension.

Traveling with or shipping your computer

If you have to travel with or ship your computer, follow these tips to keep your equipment safe.

- Prepare the computer for traveling or shipping:
 - Back up your information to an external drive.
 - Remove all discs and all external media cards, such as memory cards.
 - Turn off and then disconnect all external devices.
 - Shut down the computer.
- Take along a backup of your information. Keep the backup separate from the computer.
- When traveling by air, carry the computer as hand luggage; do not check it in with the rest of your luggage.

 **CAUTION:** Avoid exposing a drive to magnetic fields. Security devices with magnetic fields include airport walk-through devices and security wands. Airport conveyer belts and similar security devices that check carry-on baggage use X-rays instead of magnetism and do not damage drives.

- If you plan to use the computer during a flight, listen for the in-flight announcement that tells you when you are allowed to use your computer. In-flight computer use is at the discretion of the airline.
- If you are shipping the computer or a drive, use suitable protective packaging and label the package “FRAGILE.”
- The use of wireless devices may be restricted in some environments. Such restrictions may apply aboard aircraft, in hospitals, near explosives, and in hazardous locations. If you are uncertain of the policy that applies to the use of a wireless device in your computer, ask for authorization to use your computer before you turn it on.
- If you are traveling internationally, follow these suggestions:
 - Check the computer-related customs regulations for each country or region on your itinerary.
 - Check the power cord and adapter requirements for each location in which you plan to use the computer. Voltage, frequency, and plug configurations vary.

 **WARNING!** To reduce the risk of electric shock, fire, or damage to the equipment, do not attempt to power the computer with a voltage converter kit sold for appliances.

8 Securing your computer and information

Computer security is essential for protecting the confidentiality, integrity, and availability of your information. Standard security solutions provided by the Windows operating system, HP applications, the non-Windows Setup Utility (BIOS), and other third-party software can help protect your computer from a variety of risks, such as viruses, worms, and other types of malicious code.

 **IMPORTANT:** Some security features listed in this chapter may not be available on your computer.

Computer risk	Security feature
Unauthorized use of the computer	Power-on password
Computer viruses	Antivirus software
Unauthorized access to data	Firewall software
Unauthorized access to Setup Utility (BIOS) settings and other system identification information	Administrator password
Ongoing or future threats to the computer	Software updates
Unauthorized access to a Windows user account	User password
Unauthorized removal of the computer	Security cable lock

Using passwords

A password is a group of characters that you choose to secure your computer information and to protect online transactions. Several types of passwords can be set. For example, when you set up your computer for the first time, you were asked to create a user password to secure your computer. Additional passwords can be set in Windows or in the HP Setup Utility (BIOS) that is preinstalled on your computer.

You may find it helpful to use the same password for a Setup Utility (BIOS) feature and for a Windows security feature.

To create and save passwords, use the following tips:

- To reduce the risk of being locked out of the computer, record each password and store it in a secure place away from the computer. Do not store passwords in a file on the computer.
- When creating passwords, follow requirements set by the program.
- Change your passwords at least every 3 months.
- An ideal password is long and has letters, punctuation, symbols, and numbers.
- Before you send your computer for service, back up your files, delete confidential files, and then remove all password settings.

For additional information about Windows passwords, such as screen-saver passwords:

- ▲ From the Start screen, type `support`, and then select the **HP Support Assistant** app.

-or-

From the Windows desktop, click the question mark icon in the notification area, at the far right of the taskbar.

Setting Windows passwords

Password	Function
User password	Protects access to a Windows user account.
Administrator password	Protects administrator-level access to computer contents. NOTE: This password cannot be used to access Setup Utility (BIOS) contents.

Setting Setup Utility (BIOS) passwords

Password	Function
Administrator password	<ul style="list-style-type: none">• Must be entered each time you access Setup Utility (BIOS).• If you forget your administrator password, you cannot access Setup Utility (BIOS).
Power-on password	<ul style="list-style-type: none">• Must be entered each time you turn on or restart the computer.• If you forget your power-on password, you cannot turn on or restart the computer.

To set, change, or delete an administrator or power-on password in Setup Utility (BIOS):

 **CAUTION:** Use extreme care when making changes in Setup Utility (BIOS). Errors can prevent the computer from operating properly.

 **NOTE:** If your tablet has a keyboard base, connect the tablet to the keyboard base before beginning these steps.

1. Start Setup Utility (BIOS):
 - Computers or tablets with keyboards:
 - ▲ Turn on or restart the computer, quickly press **esc**, and then press **f10**.
 - Tablets without keyboards:
 1. Turn on or restart the tablet, and then quickly hold down the volume down button.
- or -
Turn on or restart the tablet, and then quickly hold down the Windows button.
 2. Tap **f10**.
2. Select **Security**, and then follow the on-screen instructions.

Your changes take effect when the computer restarts.

Using Internet security software

When you use your computer to access email, a network, or the Internet, you potentially expose your computer to computer viruses, spyware, and other online threats. To help protect your computer, Internet security software that includes antivirus and firewall features may be preinstalled on your computer as a trial offer. To provide ongoing protection against newly discovered viruses and other security risks, security software must be kept up to date. It is strongly recommended that you upgrade the security software trial offer or purchase the software of your choice in order to fully protect your computer.

Using antivirus software

Computer viruses can disable programs, utilities, or the operating system, or cause them to function abnormally. Antivirus software can detect most viruses, destroy them, and in most cases, repair any damage they have caused.

To provide ongoing protection against newly discovered viruses, antivirus software must be kept up to date.

An antivirus program may be preinstalled on your computer. It is strongly recommended that you use the antivirus program of your choice in order to fully protect your computer.

For more information about computer viruses, from the Start screen, type `support`, and then select the **HP Support Assistant** app.

Using firewall software

Firewalls are designed to prevent unauthorized access to a system or network. A firewall can be software you install on your computer and/or network, or it can be a combination of both hardware and software.

There are two types of firewalls to consider:

- Host-based firewalls—Software that protects only the computer it is installed on.
- Network-based firewalls—Installed between your DSL or cable modem and your home network to protect all the computers on the network.

When a firewall is installed on a system, all data sent to and from the system is monitored and compared with a set of user-defined security criteria. Any data that does not meet those criteria is blocked.

Installing software updates

HP, Windows, and third-party software installed on your computer should be regularly updated to correct security problems and improve software performance. For more information, see [Updating programs and drivers on page 37](#).

Installing HP and third-party software updates

HP recommends that you regularly update the software and drivers that were originally installed on your computer. To download the latest versions, go to <http://www.hp.com/support>. At this location, you can also register to receive automatic update notifications when they become available.

If you have installed third-party software after you purchased your computer, regularly update the software. Software companies provide software updates to their products to correct security problems and improve functionality of the software.

Installing critical security updates

 **CAUTION:** Microsoft sends out alerts regarding critical updates. To protect the computer from security breaches and computer viruses, install all critical updates from Microsoft as soon as you receive an alert.

You can install these updates manually or automatically.

To view or change the settings:

1. From the Start screen, type `control panel`.
– or –
From the Windows desktop, right-click the **Start** button, and then select **Control Panel**.
2. Select **System and Security**, select **Windows Update**, select **Change settings**, and then follow the on-screen instructions.

Securing your wireless network

When you set up a WLAN or access an existing WLAN, always enable security features to protect your network from unauthorized access. WLANs in public areas (hotspots) like coffee shops and airports may not provide any security.

Backing up your software applications and information

Regularly back up your software applications and information to protect them from being permanently lost or damaged through a virus attack or a software or hardware failure. For more information, see [Backing up, restoring, and recovering on page 49](#).

Using an optional security cable lock

A security cable lock, which is purchased separately, is designed to act as a deterrent, but it may not prevent the computer from being mishandled or stolen. Security cable locks are only one of several methods that should be employed as part of a complete security solution to help maximize theft protection.

The security cable slot on your computer may look slightly different from the illustration in this section. For the location of the security cable slot on your computer, see [Getting to know your computer on page 4](#).

1. Loop the security cable lock around a secured object.
2. Insert the key **(1)** into the security cable lock **(2)**.

3. Insert the security cable lock into the security cable slot on the computer (3), and then lock the security cable lock with the key.

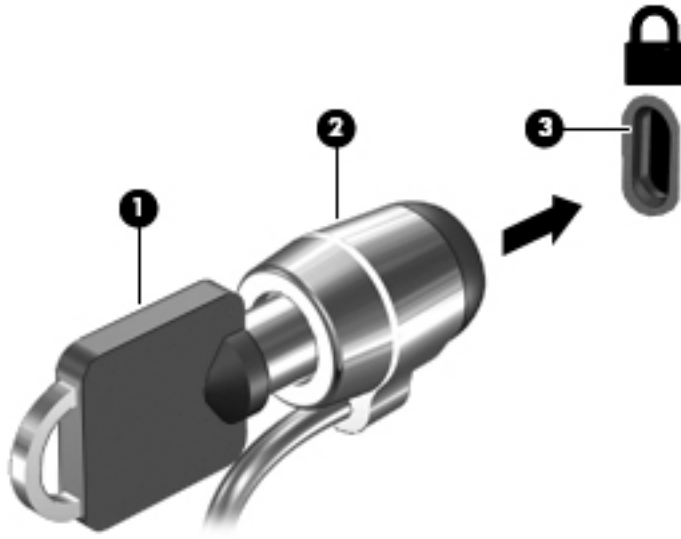

4. Remove the key and keep it in a safe place.

9 Using Setup Utility (BIOS)

Setup Utility, or Basic Input/Output System (BIOS), controls communication between all the input and output devices on the system (such as disk drives, display, keyboard, mouse, and printer). Setup Utility (BIOS) includes settings for the types of devices installed, the startup sequence of the computer, and the amount of system and extended memory.

Starting Setup Utility (BIOS)

 **CAUTION:** Use extreme care when making changes in Setup Utility (BIOS). Errors can prevent the computer from operating properly.

 **NOTE:** If your tablet has a keyboard base, connect the tablet to the keyboard base before beginning the steps in this chapter.

- Computers or tablets with keyboards:
 - ▲ Turn on or restart the computer, quickly press **esc**, and then press **f10**.
- Tablets without keyboards:
 1. Turn on or restart the tablet, and then quickly hold down the volume down button.
- or -
Turn on or restart the tablet, and then quickly hold down the Windows button.
 2. Tap **f10**.

Updating the BIOS

Updated versions of the BIOS may be available on the HP website.

Most BIOS updates on the HP website are packaged in compressed files called *SoftPaqs*.

Some download packages contain a file named *Readme.txt*, which contains information regarding installing and troubleshooting the file.

Determining the BIOS version

To determine whether available BIOS updates contain later BIOS versions than the one currently installed on the computer, you need to know the version of the system BIOS that is installed.

BIOS version information (also known as *ROM date* and *System BIOS*) can be revealed from the Start screen by typing `support`, selecting the **HP Support Assistant** app, and then selecting **System Information**, or by using Setup Utility (BIOS).

1. Start Setup Utility (BIOS) (see [Starting Setup Utility \(BIOS\) on page 45](#)).
2. Select **Main**, and then make note of your BIOS version.
3. Select **Exit**, select **Exit Discarding Changes**, and then follow the on-screen instructions.

Downloading a BIOS update

 **CAUTION:** To reduce the risk of damage to the computer or an unsuccessful installation, download and install a BIOS update only when the computer is connected to reliable external power using the AC adapter. Do not download or install a BIOS update while the computer is running on battery power, docked in an optional docking device, or connected to an optional power source. During the download and installation, follow these instructions:

- Do not disconnect power from the computer by unplugging the power cord from the AC outlet.
- Do not shut down the computer or initiate Sleep.
- Do not insert, remove, connect, or disconnect any device, cable, or cord.

 **NOTE:** If your computer is connected to a network, consult the network administrator before installing any software updates, especially system BIOS updates.

1. From the Start screen, type `support`, and then select the **HP Support Assistant** app.

– or –

From the Windows desktop, click the question mark icon in the notification area, at the far right of the taskbar.

2. Click **Updates and tune-ups**, and then click **Check for HP updates now**.

3. Follow the on-screen instructions.

4. At the download area, follow these steps:

- a. Identify the most recent BIOS update and compare it to the BIOS version currently installed on your computer. If the update is more recent than your BIOS, make a note of the date, name, or other identifier. You may need this information to locate the update later, after it has been downloaded to your hard drive.
- b. Follow the on-screen instructions to download your selection to the hard drive.

If the update is more recent than your BIOS, make a note of the path to the location on your hard drive where the BIOS update is downloaded. You will need to access this path when you are ready to install the update.

BIOS installation procedures vary. Follow any instructions that appear on the screen after the download is complete. If no instructions appear, follow these steps:

1. From the Start screen, type `file`, and then select **File Explorer**.

– or –

From the Windows desktop, right-click the **Start** button, and then select **File Explorer**.

2. Click your hard drive designation. The hard drive designation is typically Local Disk (C:).
3. Using the hard drive path you recorded earlier, open the folder on your hard drive that contains the update.
4. Double-click the file that has an `.exe` extension (for example, `filename.exe`).

The BIOS installation begins.

5. Complete the installation by following the on-screen instructions.

 **NOTE:** After a message on the screen reports a successful installation, you can delete the downloaded file from your hard drive.

10 Using HP PC Hardware Diagnostics (UEFI)

HP PC Hardware Diagnostics is a Unified Extensible Firmware Interface (UEFI) that allows you to run diagnostic tests to determine whether the computer hardware is functioning properly. The tool runs outside the operating system so that it can isolate hardware failures from issues that are caused by the operating system or other software components.

To start HP PC Hardware Diagnostics (UEFI):

1. Start Setup Utility:
 - Computers or tablets with keyboards:
 - ▲ Turn on or restart the computer, quickly press **esc**.
 - Tablets without keyboards:
 - ▲ Turn on or restart the tablet, and then quickly hold down the volume down button.
 - or -
 - Turn on or restart the tablet, and then quickly hold down the Windows button.

2. Press or tap **f2**.

The BIOS searches 3 places for the diagnostic tools, in the following order:

- a. Connected USB drive



NOTE: To download the HP PC Hardware Diagnostics (UEFI) tool to a USB drive, see [Downloading HP PC Hardware Diagnostics \(UEFI\) to a USB device on page 47](#).

- b. Hard drive
- c. BIOS

3. When the diagnostic tool opens, use the keyboard arrow keys to select the type of diagnostic test you want to run, and then follow the on-screen instructions.



NOTE: If you need to stop a diagnostic test, press or tap **esc**.

Downloading HP PC Hardware Diagnostics (UEFI) to a USB device



NOTE: Instructions for downloading HP PC Hardware Diagnostics (UEFI) are provided in English only.

There are two options to download HP PC Hardware Diagnostics to a USB device:

Option 1: HP PC Diagnostics homepage—Provides access to the latest UEFI version

1. Go to <http://hp.com/go/techcenter/pcdiags>.
2. Click the UEFI **Download** link, and then select **Run**.

Option 2: Support and Drivers pages—Provide downloads for a specific product for earlier and later versions

1. Go to <http://www.hp.com>.
2. Point to **Support**, located at the top of the page, and then click **Download Drivers**.

3. In the text box, enter the product name, and then click **Go**.
– or –
Click **Find Now** to let HP automatically detect your product.
4. Select your computer model, and then select your operating system.
5. In the **Diagnostic** section, click **HP UEFI Support Environment**.
– or –
Click **Download**, and then select **Run**.

11 Backing up, restoring, and recovering

This chapter provides information about the following processes. The information in the chapter is standard procedure for most models.

- Creating recovery media and backups
- Restoring and recovering your system

For additional information, refer to the HP Support Assistant.

- ▲ From the Start screen, type `support`, and then select the **HP Support Assistant** app.

- or -

From the Windows desktop, click the question mark icon in the notification area, at the far right of the taskbar.

 **IMPORTANT:** If you will be using F11 startup recovery or USB media recovery to recover your system, the tablet battery must have at least 70% battery power remaining before starting the recovery process.

Creating recovery media and backups

The following methods of creating recovery media and backups are available on select models only. Choose the available method according to your computer model.

- Use HP Recovery Manager after you successfully set up the computer to create HP Recovery media. This step creates a backup of the HP Recovery partition on the computer. The backup can be used to reinstall the original operating system in cases where the hard drive is corrupted or has been replaced. For information on creating recovery media, see [Creating HP Recovery media \(select models only\) on page 49](#). For information on the recovery options that are available using the recovery media, see [Recovering using HP Recovery Manager on page 51](#).

- Use Windows tools to create system restore points and create backups of personal information.

For more information, see [Using Windows tools on page 50](#).

 **NOTE:** If storage is 32 GB or less, Microsoft System Restore is disabled by default.

Creating HP Recovery media (select models only)

 **IMPORTANT:** If your computer does not list a Recovery Media Creation option, you can obtain recovery media for your system from support. See the *Worldwide Telephone Numbers* booklet included with the computer. You can also find contact information from the HP website. Go to <http://www.hp.com/support>, select your country or region, and follow the on-screen instructions.

HP Recovery Manager is a software program that allows you to create recovery media after you successfully set up the computer. HP Recovery media can be used to perform system recovery if the hard drive becomes corrupted. System recovery reinstalls the original operating system and the software programs installed at the factory and then configures the settings for the programs. HP Recovery media can also be used to customize the system or restore the factory image if you replace the hard drive.

- Only one set of recovery media can be created. Handle these recovery tools carefully, and keep them in a safe place.
- HP Recovery Manager examines the computer and determines the required storage capacity for the media that will be required.
- To create recovery discs, your computer must have an optical drive with DVD writer capability, and you must use only high-quality blank DVD-R, DVD+R, DVD-R DL, or DVD+R DL discs. Do not use rewritable discs such as CD±RW, DVD±RW, double-layer DVD±RW, or BD-RE (rewritable Blu-ray) discs; they are not compatible with HP Recovery Manager software. Or, instead, you can use a high-quality blank USB flash drive.
- If your computer does not include an integrated optical drive with DVD writer capability, but you would like to create DVD recovery media, you can use an external optical drive (purchased separately) to create recovery discs, or you can obtain recovery discs for your computer from support. See the *Worldwide Telephone Numbers* booklet included with the computer. You can also find contact information from the HP website. Go to <http://www.hp.com/support>, select your country or region, and follow the on-screen instructions. If you use an external optical drive, it must be connected directly to a USB port on the computer; the drive cannot be connected to a USB port on an external device, such as a USB hub.
- Be sure that the computer is connected to AC power before you begin creating the recovery media.
- The creation process can take an hour or more. Do not interrupt the creation process.
- If necessary, you can exit the program before you have finished creating all of the recovery DVDs. HP Recovery Manager will finish burning the current DVD. The next time you start HP Recovery Manager, you will be prompted to continue, and the remaining discs will be burned.

To create HP Recovery media:

 **IMPORTANT:** For tablets with a detachable keyboard, connect the keyboard to the keyboard dock before beginning these steps (select models only).

1. From the Start screen, type `recovery`, and then select **HP Recovery Manager**.
2. Select **Recovery Media Creation**, and then follow the on-screen instructions.

If you ever need to recover the system, see [Recovering using HP Recovery Manager on page 51](#).

Using Windows tools

You can create system restore points and create backups of personal information using Windows tools.

 **NOTE:** If storage is 32 GB or less, Microsoft System Restore is disabled by default.

- ▲ From the Start screen, type `help`, and then select **Help and Support**.

– or –

From the Windows desktop, click the question mark icon in the notification area, at the far right of the taskbar.

For more information and steps, see Help and Support.

Restore and recovery

There are several options for recovering your system. Choose the method that best matches your situation and level of expertise:

 **IMPORTANT:** Not all methods are available on all models.

- Windows offers several options for restoring from backup, refreshing the computer, and resetting the computer to its original state. For more information see Help and Support.
 - ▲ From the Start screen, type `support`, and then select the **HP Support Assistant** app.
 - or -
 - From the Windows desktop, click the question mark icon in the notification area, at the far right of the taskbar.
- If you need to correct a problem with a preinstalled application or driver, use the Drivers and Applications Reinstall option of HP Recovery Manager to reinstall the individual application or driver.
 - ▲ From the Start screen, type `recovery`, select **HP Recovery Manager**, select **Drivers and Applications Reinstall**, and then follow the on-screen instructions.
- On select models, if you want to reset your computer using a minimized image, you can choose the HP Minimized Image Recovery option from the HP Recovery partition or HP Recovery media. Minimized Image Recovery installs only drivers and hardware-enabling applications. Other applications included in the image continue to be available for installation through the Drivers and Applications Reinstall option in HP Recovery Manager.

For more information, see [Recovering using HP Recovery Manager on page 51](#).

- If you want to recover the Windows partition to original factory content, you can choose the System Recovery option from the HP Recovery partition (select models only) or use the HP Recovery media. For more information, see [Recovering using HP Recovery Manager on page 51](#). If you have not already created recovery media, see [Creating HP Recovery media \(select models only\) on page 49](#).
- On select models, if you want to recover the computer's original factory partition and content, or if you have replaced the hard drive, you can use the Factory Reset option of HP Recovery media. For more information, see [Recovering using HP Recovery Manager on page 51](#).
- On select models, if you want to remove the recovery partition to reclaim hard drive space, HP Recovery Manager offers the Remove Recovery Partition option.

For more information, see [Removing the HP Recovery partition \(select models only\) on page 53](#).

Recovering using HP Recovery Manager

HP Recovery Manager software allows you to recover the computer to its original factory state by using the HP Recovery media that you either created or that you obtained from support, or by using the HP Recovery partition (select models only). If you have not already created recovery media, see [Creating HP Recovery media \(select models only\) on page 49](#).

What you need to know before you get started

- HP Recovery Manager recovers only software that was installed at the factory. For software not provided with this computer, you must either download the software from the manufacturer's website or reinstall the software from the media provided by the manufacturer.

 **IMPORTANT:** Recovery through HP Recovery Manager should be used as a final attempt to correct computer issues.

- HP Recovery media must be used if the computer hard drive fails. If you have not already created recovery media, see [Creating HP Recovery media \(select models only\) on page 49](#).

- To use the Factory Reset option (select models only), you must use HP Recovery media. If you have not already created recovery media, see [Creating HP Recovery media \(select models only\) on page 49](#).
- If your computer does not allow the creation of HP Recovery media or if the HP Recovery media does not work, you can obtain recovery media for your system from support. See the *Worldwide Telephone Numbers* booklet included with the computer. You can also find contact information from the HP website. Go to <http://www.hp.com/support>, select your country or region, and follow the on-screen instructions.

 **IMPORTANT:** HP Recovery Manager does not automatically provide backups of your personal data. Before beginning recovery, back up any personal data you want to retain.

Using HP Recovery media, you can choose from one of the following recovery options:

 **NOTE:** Only the options available for your computer display when you start the recovery process.

- System Recovery—Reinstalls the original operating system, and then configures the settings for the programs that were installed at the factory.
- Minimized Image Recovery (select models only)—Reinstalls the operating system and all hardware-related drivers and software, but not other software applications.
- Factory Reset—Restores the computer to its original factory state by deleting all information from the hard drive and re-creating the partitions. Then it reinstalls the operating system and the software that was installed at the factory.

The HP Recovery partition (select models only) allows System Recovery and Minimized Image Recovery (select models only).

Using the HP Recovery partition (select models only)

The HP Recovery partition allows you to perform a system recovery or minimized image recovery (select models only) without the need for recovery discs or a recovery USB flash drive. This type of recovery can be used only if the hard drive is still working.

To start HP Recovery Manager from the HP Recovery partition:

 **IMPORTANT:** For tablets with a detachable keyboard, connect the keyboard to the keyboard dock before beginning these steps (select models only).

1. From the Start screen, type `recovery`, select **Recovery Manager**, and then select **HP Recovery Environment**.
- or -
Press **f11** while the computer boots, or press and hold **f11** as you press the power button.
2. Select **Troubleshoot** from the boot options menu.
3. Select **Recovery Manager**, and then follow the on-screen instructions.

Using HP Recovery media to recover

You can use HP Recovery media to recover the original system. This method can be used if your system does not have an HP Recovery partition or if the hard drive is not working properly.

1. If possible, back up all personal files.
2. Insert the HP Recovery media, and then restart the computer.



NOTE: If the computer does not automatically restart in HP Recovery Manager, change the computer boot order. See [Changing the computer boot order on page 53](#).

3. Follow the on-screen instructions.

Changing the computer boot order

If your computer does not restart in HP Recovery Manager, you can change the computer boot order, which is the order of devices listed in BIOS where the computer looks for startup information. You can change the selection for an optical drive or a USB flash drive.

To change the boot order:



IMPORTANT: For tablets with a detachable keyboard, connect the keyboard to the keyboard dock before beginning these steps (select models only).

1. Insert the HP Recovery media.
2. Start Computer Setup:

For computers or tablets with keyboards attached:

- ▲ Turn on or restart the computer or tablet, quickly press **esc**, and then press **f9** for boot options.

For computers or tablets without keyboards attached:

- ▲ Turn on or restart the computer, quickly press the volume down button, and then tap **f9** for boot options.

- or -

Turn on or restart the computer, quickly press the Windows button, and then tap **f9** for boot options.

3. Select the optical drive or USB flash drive from which you want to boot.
4. Follow the on-screen instructions.

Removing the HP Recovery partition (select models only)

HP Recovery Manager software allows you to remove the HP Recovery partition to free up hard drive space.



IMPORTANT: After you remove the HP Recovery partition, you can no longer use the Windows Refresh option or the Windows option to remove everything and reinstall Windows. In addition, you will not be able to perform System Recovery or Minimized Image Recovery from the HP Recovery partition. So before you remove the Recovery partition, create HP Recovery media; see [Creating HP Recovery media \(select models only\) on page 49](#).

Follow these steps to remove the HP Recovery partition:

1. From the Start screen, type *recovery*, and then select **HP Recovery Manager**.
2. Select **Remove Recovery Partition**, and then follow the on-screen instructions.

12 Specifications

Input power

The power information in this section may be helpful if you plan to travel internationally with the computer.

The computer operates on DC power, which can be supplied by an AC or a DC power source. The AC power source must be rated at 100–240 V, 50–60 Hz. Although the computer can be powered from a standalone DC power source, it should be powered only with an AC adapter or a DC power source that is supplied and approved by HP for use with this computer.

The computer can operate on DC power within the following specifications. Operating voltage and current varies by platform.

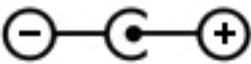
Input power	Rating
Operating voltage and current	19.5 V dc @ 2.31 A – 45 W
DC plug of external HP power supply	

 **NOTE:** This product is designed for IT power systems in Norway with phase-to-phase voltage not exceeding 240 V rms.

 **NOTE:** The computer operating voltage and current can be found on the system regulatory label.

Operating environment

Factor	Metric	U.S.
Temperature		
Operating	5°C to 35°C	41°F to 95°F
Nonoperating	-20°C to 60°C	-4°F to 140°F
Relative humidity (noncondensing)		
Operating	10% to 90%	10% to 90%
Nonoperating	5% to 95%	5% to 95%
Maximum altitude (unpressurized)		
Operating	-15 m to 3,048 m	-50 ft to 10,000 ft
Nonoperating	-15 m to 12,192 m	-50 ft to 40,000 ft

13 Electrostatic Discharge

Electrostatic discharge is the release of static electricity when two objects come into contact—for example, the shock you receive when you walk across the carpet and touch a metal door knob.

A discharge of static electricity from fingers or other electrostatic conductors may damage electronic components. To prevent damage to the computer, damage to a drive, or loss of information, observe these precautions:

- If removal or installation instructions direct you to unplug the computer, first be sure that it is properly grounded.
- Keep components in their electrostatic-safe containers until you are ready to install them.
- Avoid touching pins, leads, and circuitry. Handle electronic components as little as possible.
- Use nonmagnetic tools.
- Before handling components, discharge static electricity by touching an unpainted metal surface.
- If you remove a component, place it in an electrostatic-safe container.

14 Accessibility

HP designs, produces, and markets products and services that can be used by everyone, including people with disabilities, either on a stand-alone basis or with appropriate assistive devices.

Supported assistive technologies

HP products support a wide variety of operating system assistive technologies and can be configured to work with additional assistive technologies. Use the Search feature on your device to locate more information about assistive features.



NOTE: For additional information about a particular assistive technology product, contact customer support for that product.

Contacting support

We are constantly refining the accessibility of our products and services and welcome feedback from users. If you have an issue with a product or would like to tell us about accessibility features that have helped you, please contact us at (888) 259-5707, Monday through Friday, 6 A.M. to 9 P.M. Mountain Time. If you are deaf or hard-of-hearing and use TRS/VRS/WebCapTel, contact us if you require technical support or have accessibility questions by calling (877) 656-7058, Monday through Friday, 6:00 a.m. to 9:00 p.m. Mountain Time.

Index

A

- AC adapter 6
- AC adapter, testing 35
- accessibility 56
- action keys 12
 - identifying 12
- antivirus software, using 42
- audio-out (headphone)/audio-in (microphone) jack, identifying 5

B

- backing up software and information 43
- backups 49
- battery
 - conserving power 32
 - discharging 32
 - disposing 34
 - finding information 32
 - low battery levels 33
 - replacing 34
 - resolving low battery level 33
 - storing 33
 - user-replaceable 31
- battery cover, identifying 14
- battery information, finding 32
- battery lock, identifying 14
- battery power 31
- battery release latch 14
- battery temperature 33
- best practices 1
- BIOS
 - determining version 45
 - downloading an update 46
 - starting the Setup Utility 45
 - updating 45
- Bluetooth device 17, 20
- Bluetooth label 16
- boot order
 - changing 53
- bottom 16
- buttons
 - left TouchPad 9
 - power 11
 - right TouchPad 9

C

- caps lock light, identifying 10
- caring for your computer 38
- cleaning your computer 38
- components
 - bottom 14
 - display 8
 - left side 6
 - right side 5
 - top 9
- computer, traveling 33
- connecting to a WLAN 18
- connector, power 6
- corporate WLAN connection 18
- critical battery level 33
- critical security updates, installing 43

D

- Disk Cleanup software 37
- Disk Defragmenter software 37

E

- electrostatic discharge 55
- esc key, identifying 12
- external AC power, using 34

F

- firewall software 42
- fn key, identifying 12

H

- hard drive light 5
- hard drive, identifying 14
- HDMI port
 - connecting 23
 - identifying 6
- HDMI, configuring audio 24
- headphones, connecting 22
- headsets, connecting 23
- Hibernation
 - exiting 30
 - initiated during critical battery level 33
 - initiating 30

- high-definition devices, connecting 23, 24

- HP and third-party software updates, installing 42

- HP Apps Store, visiting 1

- HP PC Hardware Diagnostics (UEFI) downloading 47

- HP Recovery Manager
 - correcting boot problems 53
 - starting 52

- HP Recovery media

- creating 49
- recovery 52

- HP Recovery partition

- recovery 52
- removing 53

- HP resources 2

I

- initiating Sleep and Hibernation 29
- input power 54
- installing
 - critical security updates 43
 - optional security cable lock 43
- internal microphones, identifying 8
- Internet connection setup 19
- Internet security software, using 42

J

- jacks
 - audio-out (headphone)/audio-in (microphone) 5
 - network 6
 - RJ-45 (network) 6

K

- keys
 - action 12
 - esc 12
 - fn 12
 - Windows 12

L

- labels
 - Bluetooth 16

- Microsoft Certificate of Authenticity 16
- regulatory 16
- serial number 16
- service 16
- wireless certification 16
- WLAN 16
- latch, battery release 14
- left-edge swipe TouchPad and touch screen gesture 27
- lights
 - AC adapter 6
 - caps lock 10
 - hard drive 5
 - mute 10
 - power 5
 - RJ-45 (network) status 6
 - wireless 10
- locating information
 - hardware 4
 - software 4
- low battery level 33

M

- maintenance
 - Disk Cleanup 37
 - Disk Defragmenter 37
 - updating programs and drivers 37
- memory card reader, identifying 6
- memory card, identifying 6
- memory module
 - identifying 14
- minimized image recovery 52
- minimized image, creating 51
- Miracast 24
- mouse, external
 - setting preferences 25
- mute light, identifying 10

N

- network jack, identifying 6

O

- operating environment 54
- optical drive, identifying 5
- original system recovery 51

P

- passwords
 - Setup Utility (BIOS) 41
 - Windows 41
- ports
 - HDMI 6, 23
 - Miracast 24
 - USB 2.0 5
 - USB 3.0 6
- power
 - AC 34
 - battery 31
- power button, identifying 11
- power connector, identifying 6
- power lights, identifying 5
- power meter, using 31
- power settings, using 31
- product name and number, computer 16
- public WLAN connection 18

R

- recover
 - options 50
- recovery
 - discs 50, 52
 - HP Recovery Manager 51
 - media 52
 - starting 52
 - supported discs 50
 - system 51
 - USB flash drive 52
 - using HP Recovery media 50
- recovery media
 - creating 49
 - creating using HP Recovery Manager 50
- recovery partition
 - removing 53
- regulatory information
 - regulatory label 16
 - wireless certification labels 16
- right-edge swipe TouchPad and touch screen gesture 27
- RJ-45 (network) jack, identifying 6
- RJ-45 (network) status lights, identifying 6

S

- security cable lock, installing 43

- security cable slot, identifying 6
- security, wireless 20
- serial number 16
- serial number, computer 16
- service labels, locating 16
- setting password protection on
 - wakeup 30
- setup of WLAN 19
- Setup Utility (BIOS) passwords 41
- shipping the computer 39
- shutdown 35
- Sleep
 - exiting 30
 - initiating 30
- Sleep and Hibernation
 - initiating 29
- slots
 - memory card reader 6
 - security cable 6
- software
 - Disk Cleanup 37
 - Disk Defragmenter 37
 - software updates, installing 42
- speakers
 - connecting 22
 - identifying 11
- storing a battery 33
- supported discs, recovery 50
- system recovery 51
- system restore point
 - creating 50
- system restore point, creating 49

T

- tap TouchPad and touch screen
 - gesture 25
- temperature 33
- testing an AC adapter 35
- top-edge swipe and bottom-edge
 - swipe TouchPad and touch screen gesture 27
- TouchPad
 - buttons 9
 - using 25
- TouchPad and touch screen gestures
 - left-edge swipe 27
 - right-edge swipe 27
 - tap 25
 - top-edge swipe and bottom-edge
 - swipe 27

- two-finger click 26
- two-finger pinch/zoom 26
- two-finger scroll 26
- TouchPad zone, identifying 9
- traveling with the computer 16, 33, 39
- turning off the computer 35
- two-finger click TouchPad and touch screen gesture 26
- two-finger pinch/zoom TouchPad and touch screen gesture 26
- two-finger scroll TouchPad and touch screen gesture 26
- public WLAN connection 18
 - security 20
 - using 19
- wireless network, securing 43
- WLAN antennas, identifying 8
- WLAN device 16, 19
- WLAN label 16

U

- unresponsive system 35
- updating programs and drivers 37
- USB 2.0 port, identifying 5
- USB 3.0 port, identifying 6
- using external AC power 34
- using passwords 40
- using the TouchPad 25

V

- vents, identifying 6, 14
- video 23

W

- webcam
 - identifying 8
 - using 22
- webcam light, identifying 8
- Windows
 - system restore point 49, 50
- Windows key, identifying 12
- Windows passwords 41
- Windows tools
 - using 50
- Wireless Assistant software 17
- wireless button 17
- wireless certification label 16
- wireless controls
 - button 17
 - operating system 17
 - Wireless Assistant software 17
- wireless light 10, 17
- wireless network (WLAN)
 - connecting 18
 - corporate WLAN connection 18
 - equipment needed 19
 - functional range 18