



Hardware Reference Guide

HP EliteDesk 800 G1 Desktop Mini
HP EliteDesk 705 G1 Desktop Mini
HP ProDesk 600 G1 Desktop Mini
HP ProDesk 400 G1 Desktop Mini

© Copyright 2014 Hewlett-Packard Development Company, L.P.

Microsoft and Windows are U.S. registered trademarks of the Microsoft group of companies.

The information contained herein is subject to change without notice. The only warranties for HP products and services are set forth in the express warranty statements accompanying such products and services. Nothing herein should be construed as constituting an additional warranty. HP shall not be liable for technical or editorial errors or omissions contained herein.

Fourth Edition: December 2014

Third Edition: November 2014

Second Edition: May 2014

First Edition: March 2014

Document part number: 756961-004

Product Notice

This guide describes features that are common to most models. Some features may not be available on your computer.

Not all features are available in all editions of Windows 8. This computer may require upgraded and/or separately purchased hardware, drivers and/or software to take full advantage of Windows 8 functionality. See <http://www.microsoft.com> for details.

This computer may require upgraded and/or separately purchased hardware and/or a DVD drive to install the Windows 7 software and take full advantage of Windows 7 functionality. See <http://windows.microsoft.com/en-us/windows7/get-know-windows-7> for details.

Software terms

By installing, copying, downloading, or otherwise using any software product preinstalled on this computer, you agree to be bound by the terms of the HP End User License Agreement (EULA). If you do not accept these license terms, your sole remedy is to return the entire unused product (hardware and software) within 14 days for a refund subject to the refund policy of your place of purchase.

For any further information or to request a full refund of the computer, please contact your local point of sale (the seller).

About This Book

This guide provides basic information for upgrading the HP Desktop Mini Business PC.

 **WARNING!** Text set off in this manner indicates that failure to follow directions could result in bodily harm or loss of life.

 **CAUTION:** Text set off in this manner indicates that failure to follow directions could result in damage to equipment or loss of information.

 **NOTE:** Text set off in this manner provides important supplemental information.

Table of contents

1 Product features	1
Standard configuration features	1
Front panel components (EliteDesk 800, EliteDesk 705, ProDesk 600)	2
Front panel components (ProDesk 400)	3
Rear panel components (EliteDesk 800)	4
Rear panel components (EliteDesk 705)	5
Rear panel components (ProDesk 600)	6
Rear panel components (ProDesk 400)	7
Serial number location	8
2 Hardware upgrades	9
Serviceability features	9
Warnings and cautions	9
Connecting the power cord	10
Removing the computer access panel	11
Replacing the computer access panel	12
Changing from desktop to tower configuration	13
Removing and replacing a hard drive	14
Installing additional memory	17
SODIMMs	17
DDR3-SDRAM SODIMMs	17
Populating SODIMM sockets	18
Installing SODIMMs	19
Replacing the battery	22
Installing a security lock	25
Cable lock	25
Padlock	25
Appendix A Electrostatic discharge	26
Preventing electrostatic damage	26
Grounding methods	26

Appendix B Computer operating guidelines, routine care and shipping preparation	27
Computer operating guidelines and routine care	27
Shipping preparation	28
Index	29

1 Product features

Standard configuration features

Features may vary depending on the model. For a complete listing of the hardware and software installed in the computer, run the diagnostic utility (included on some computer models only).

 **NOTE:** This computer model can be used in a tower orientation or a desktop orientation. The tower stand is sold separately.



Front panel components (EliteDesk 800, EliteDesk 705, ProDesk 600)

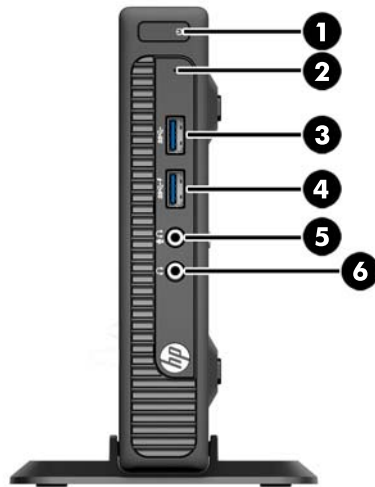

1	Dual-State Power Button	4	USB 3.0 Port - Charging
2	Hard Drive Activity Light	5	Microphone/Headphone Connector
3	USB 3.0 Port	6	Headphone Connector

NOTE: The USB 3.0 Port - Charging also provides current to charge a device such as a Smart Phone. The charging current is available whenever the power cord is plugged into the system, even when the system is off.

NOTE: When a device is plugged into the Microphone/Headphone Connector, a dialog box will pop up asking if you want to use the connector for a microphone Line-In device or a headphone. You can reconfigure the connector at any time by double-clicking the Audio Manager icon in the Windows taskbar.

NOTE: The Power On Light is normally white when the power is on. If it is flashing red, there is a problem with the computer and it is displaying a diagnostic code. Refer to the *Maintenance and Service Guide* to interpret the code.

Front panel components (ProDesk 400)

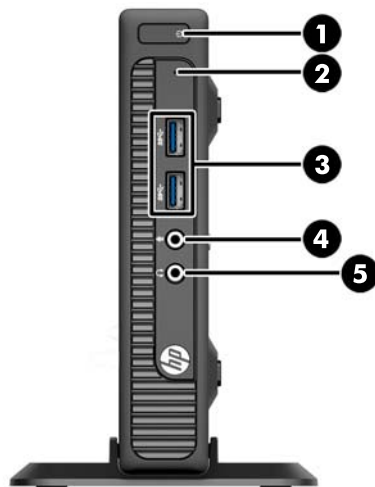

1 Dual-State Power Button

4 Microphone Connector

2 Hard Drive Activity Light





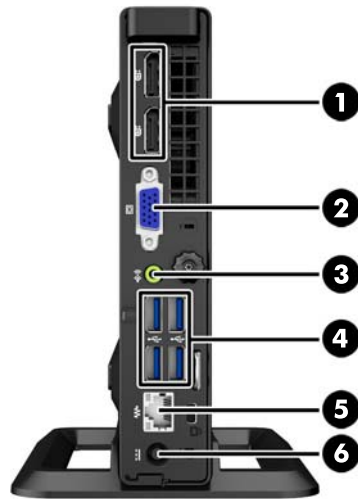

5 Headphone Connector

3 USB 3.0 Ports

NOTE: The Power On Light is normally white when the power is on. If it is flashing red, there is a problem with the computer and it is displaying a diagnostic code. Refer to the *Maintenance and Service Guide* to interpret the code.







Rear panel components (EliteDesk 800)

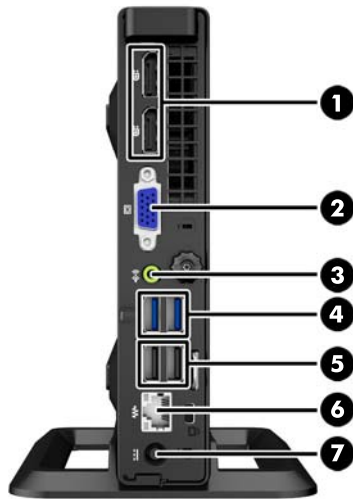

1		DisplayPort Monitor Connectors	4		USB 3.0 Ports (blue)
2		VGA Monitor Connector	5		RJ-45 Network Connector
3		Line-Out Connector for powered audio devices (green)	6		Power Cord Connector







Rear panel components (EliteDesk 705)

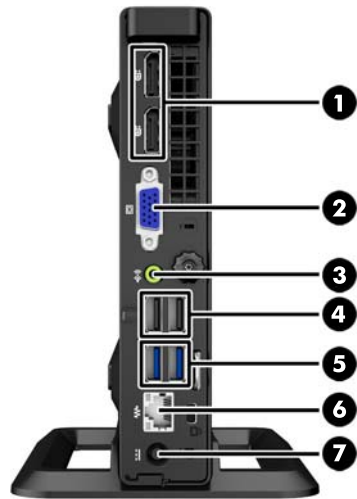

1		DisplayPort Monitor Connectors	5		USB 2.0 Ports (black)
2		VGA Monitor Connector	6		RJ-45 Network Connector
3		Line-Out Connector for powered audio devices (green)	7		Power Cord Connector
4		USB 3.0 Ports (blue)			







Rear panel components (ProDesk 600)

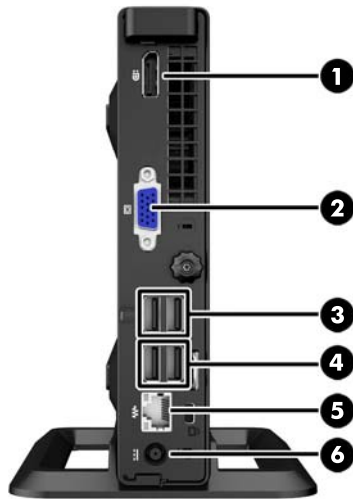

1		DisplayPort Monitor Connectors	5		USB 3.0 Ports (blue)
2		VGA Monitor Connector	6		RJ-45 Network Connector
3		Line-Out Connector for powered audio devices (green)	7		Power Cord Connector
4		USB 2.0 Ports (black)			

Rear panel components (ProDesk 400)



1	 DisplayPort Monitor Connector	4	 USB 2.0 Ports (black)
2	 VGA Monitor Connector	5	 RJ-45 Network Connector
3	 USB 2.0 Ports with enhanced power (black)	6	 Power Cord Connector

NOTE: The two upper USB ports have additional power capacity to support the Desktop Mini External Expansion Sleeves.

NOTE: The two lower USB ports support wake-from-sleep states if that option is enabled in the Computer Setup (F10) utility.

Serial number location

Each computer has a unique serial number and a product ID number that are located on the exterior of the computer. Keep these numbers available for use when contacting customer service for assistance.



2 Hardware upgrades

Serviceability features

The computer includes features that make it easy to upgrade and service. No tools are needed for most of the installation procedures described in this chapter.

Warnings and cautions

Before performing upgrades be sure to carefully read all of the applicable instructions, cautions, and warnings in this guide.

⚠ WARNING! To reduce the risk of personal injury from electrical shock, hot surfaces, or fire:

Disconnect the power cord from the wall outlet and allow the internal system components to cool before touching.

Do not plug telecommunications or telephone connectors into the network interface controller (NIC) receptacles.

Do not disable the power cord grounding plug. The grounding plug is an important safety feature.

Plug the power cord in a grounded (earthed) outlet that is easily accessible at all times.

To reduce the risk of serious injury, read the *Safety & Comfort Guide*. It describes proper workstation, setup, posture, and health and work habits for computer users, and provides important electrical and mechanical safety information. This guide is located on the Web at <http://www.hp.com/ergo>.

⚠ WARNING! Energized and moving parts inside.

Disconnect power to the equipment before removing the enclosure.

Replace and secure the enclosure before re-energizing the equipment.

⚠ CAUTION: Static electricity can damage the electrical components of the computer or optional equipment. Before beginning these procedures, ensure that you are discharged of static electricity by briefly touching a grounded metal object. See [Electrostatic discharge on page 26](#) for more information.

When the computer is plugged into an AC power source, voltage is always applied to the system board. You must disconnect the power cord from the power source before opening the computer to prevent damage to internal components.

Connecting the power cord

When connecting the power supply, it is important to follow the steps below to ensure the power cord does not pull free from the computer.

1. Plug the female end of the power cord into the power supply brick (1).
2. Connect the other end of the power cord to an electrical outlet (2).
3. Connect the round end of the power supply cord to the power supply connector on the rear of the computer (3).
4. Route the power cord through the retainer clip to prevent the cord from becoming disconnected from the computer (4).
5. Bundle any excess power cord with the supplied strap (5).

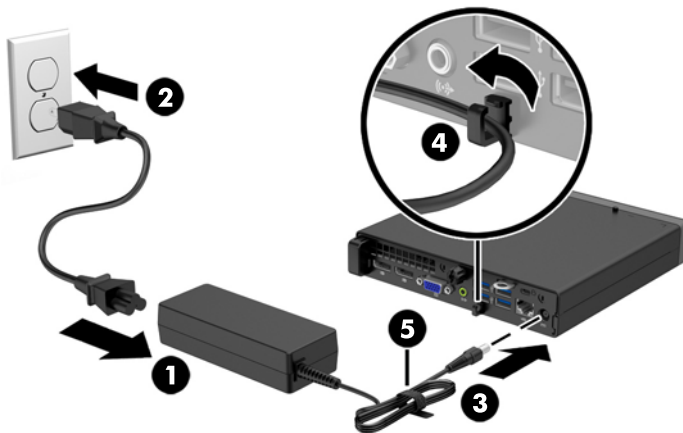

⚠ CAUTION: Failure to secure the power cable with the retainer clip may result in the power cord becoming disconnected and loss of data.

Removing the computer access panel

To access internal components, you must remove the access panel:

1. Remove/disengage any security devices that prohibit opening the computer.
2. Remove all removable media, such as a USB flash drive, from the computer.
3. Turn off the computer properly through the operating system, then turn off any external devices.
4. Disconnect the power cord from the power outlet and disconnect any external devices.

⚠ CAUTION: Regardless of the power-on state, voltage is always present on the system board as long as the system is plugged into an active AC outlet. You must disconnect the power cord to avoid damage to the internal components of the computer.

5. If the computer is on a stand, remove the computer from the stand and lay the computer down.
6. Loosen the thumbscrew on the rear of the computer (1) then slide the panel forward and lift it off the computer (2).



Replacing the computer access panel

Place the panel on the computer then slide it back (1) and tighten the thumbscrew (2) to secure the panel in place.

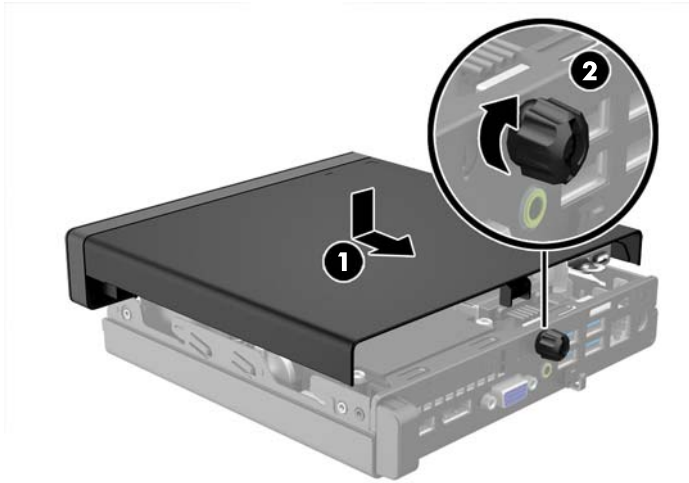

Changing from desktop to tower configuration

The computer can be used in a tower orientation with an optional tower stand that can be purchased from HP.

1. Remove/disengage any security devices that prohibit opening the computer.
2. Remove all removable media, such as a USB flash drive, from the computer.
3. Turn off the computer properly through the operating system, then turn off any external devices.
4. Disconnect the power cord from the power outlet and disconnect any external devices.

CAUTION: Regardless of the power-on state, voltage is always present on the system board as long as the system is plugged into an active AC outlet. You must disconnect the power cord to avoid damage to the internal components of the computer.

5. Orient the computer so that its right side is facing up and place the computer in the optional stand.



NOTE: To stabilize the computer in a tower orientation, HP recommends the use of the optional tower stand.

6. Reconnect the power cord and any external devices, then turn on the computer.

NOTE: Ensure at least 10.2 centimeters (4 inches) of space on all sides of the computer remains clear and free of obstructions.

7. Lock any security devices that were disengaged when the access panel was removed.

Removing and replacing a hard drive

 **NOTE:** Before you remove the old hard drive, be sure to back up the data from the old hard drive so that you can transfer the data to the new hard drive.

1. Remove/disengage any security devices that prohibit opening the computer.
2. Remove all removable media, such as a USB flash drive, from the computer.
3. Turn off the computer properly through the operating system, then turn off any external devices.
4. Disconnect the power cord from the power outlet and disconnect any external devices.

 **CAUTION:** Regardless of the power-on state, voltage is always present on the system board as long as the system is plugged into an active AC outlet. You must disconnect the power cord to avoid damage to the internal components of the computer.

5. If the computer is on a stand, remove the computer from the stand.
6. Remove the computer access panel.
7. Disconnect the hard drive power cable (1) and data cable (2) from the system board.

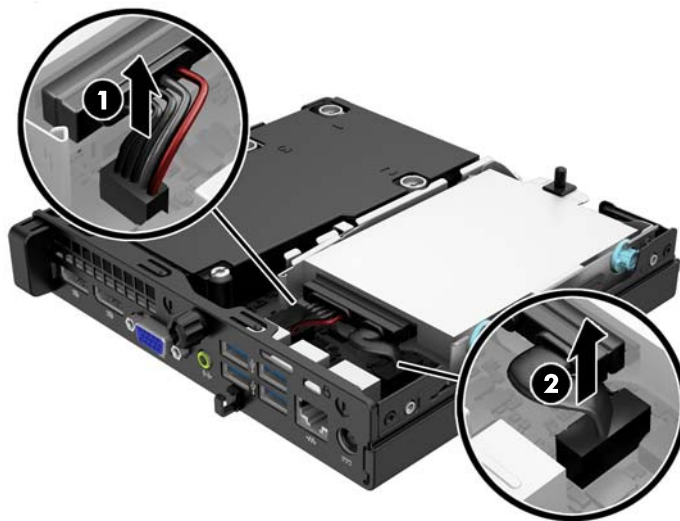

8. Pull the release lever next to the rear of the hard drive outward (1). While pulling the release lever out, slide the drive back until it stops, then lift the drive up and out of the bay (2).

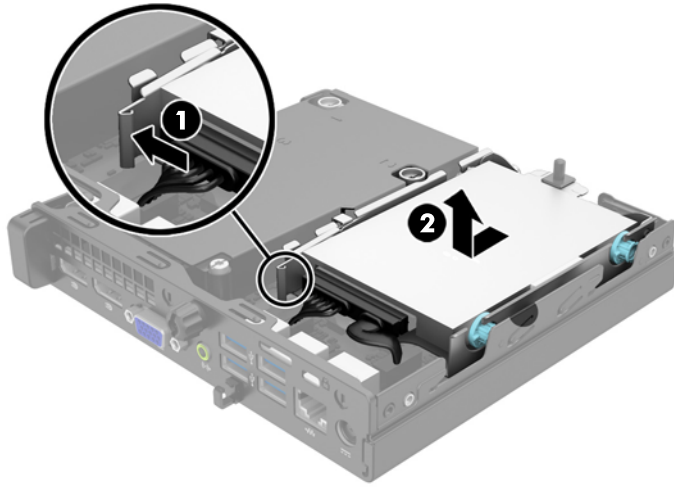

9. To install a hard drive, you must transfer the silver and blue isolation mounting guide screws from the old hard drive to the new hard drive.

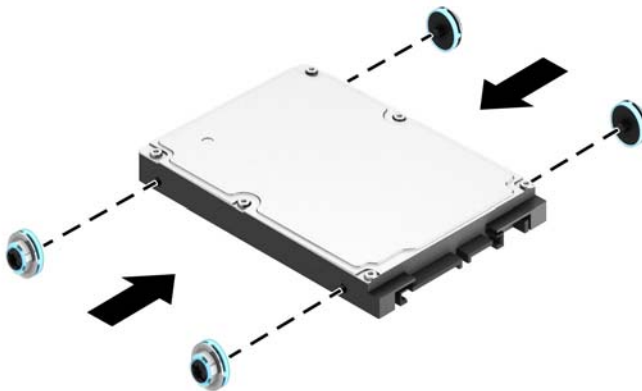

10. Transfer the drive cables from the old drive to the new drive.

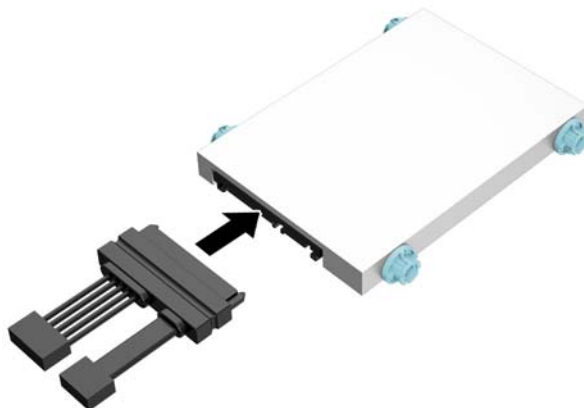

11. Align the guide screws with the slots on the chassis drive cage, press the hard drive down into the bay, then slide it forward until it stops and locks in place.



12. Connect the hard drive power cable (1) and data cable (2) to the system board.



13. Replace the access panel.
14. If the computer was on a stand, replace the stand.
15. Reconnect the power cord and turn on the computer.
16. Lock any security devices that were disengaged when the access panel was removed.

Installing additional memory

The computer comes with double data rate 3 synchronous dynamic random access memory (DDR3-SDRAM) small outline dual inline memory modules (SODIMMs).

SODIMMs

The memory sockets on the system board can be populated with up to two industry-standard SODIMMs. These memory sockets are populated with at least one preinstalled SODIMM. To achieve the maximum memory support, you can populate the system board with up to 16-GB of memory.

DDR3-SDRAM SODIMMs

For proper system operation, the SODIMMs must be:

- industry-standard 204-pin
- unbuffered non-ECC PC3-12800 DDR3-1600 MHz-compliant
- 1.5 volt DDR3-SDRAM SODIMMs

The DDR3-SDRAM SODIMMs must also:

- support CAS latency 11 DDR3 1600 MHz (11-11-11 timing)
- contain the mandatory Joint Electronic Device Engineering Council (JEDEC) specification

In addition, the computer supports:

- 512-Mbit, 1-Gbit, and 2-Gbit non-ECC memory technologies
- single-sided and double-sided SODIMMS
- SODIMMs constructed with x8 and x16 devices; SODIMMs constructed with x4 SDRAM are not supported



NOTE: The system will not operate properly if you install unsupported SODIMMs.

Populating SODIMM sockets

There are two SODIMM sockets on the system board, with one socket per channel. The sockets are labeled DIMM1 and DIMM3. The DIMM1 socket operates in memory channel B. The DIMM3 socket operates in memory channel A.

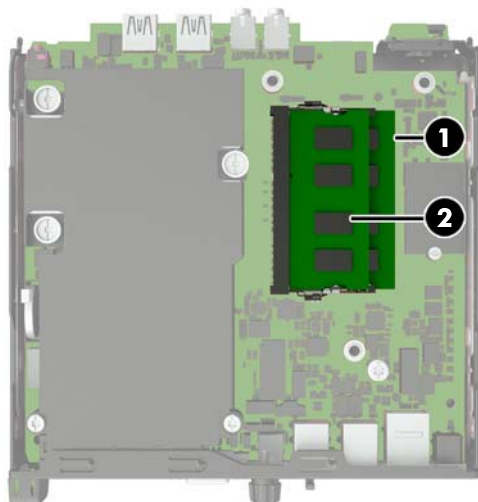

Item	Description	System Board Label	Socket Color
1	SODIMM1 socket, Channel B	DIMM1	Black
2	SODIMM3 socket, Channel A	DIMM3	Black

The system will automatically operate in single channel mode, dual channel mode, or flex mode, depending on how the SODIMMs are installed.

- The system will operate in single channel mode if the SODIMM sockets are populated in one channel only.
- The system will operate in a higher-performing dual channel mode if the memory capacity of the SODIMM in Channel A is equal to the memory capacity of the SODIMM in Channel B.
- The system will operate in flex mode if the memory capacity of the SODIMM in Channel A is not equal to the memory capacity of the SODIMM in Channel B. In flex mode, the channel populated with the least amount of memory describes the total amount of memory assigned to dual channel and the remainder is assigned to single channel. If one channel will have more memory than the other, the larger amount should be assigned to channel A.
- In any mode, the maximum operational speed is determined by the slowest SODIMM in the system.

Installing SODIMMs

⚠ CAUTION: You must disconnect the power cord and wait approximately 30 seconds for the power to drain before adding or removing memory modules. Regardless of the power-on state, voltage is always supplied to the memory modules as long as the computer is plugged into an active AC outlet. Adding or removing memory modules while voltage is present may cause irreparable damage to the memory modules or system board.

The memory module sockets have gold-plated metal contacts. When upgrading the memory, it is important to use memory modules with gold-plated metal contacts to prevent corrosion and/or oxidation resulting from having incompatible metals in contact with each other.

Static electricity can damage the electronic components of the computer or optional cards. Before beginning these procedures, ensure that you are discharged of static electricity by briefly touching a grounded metal object. For more information, refer to [Electrostatic discharge on page 26](#).

When handling a memory module, be careful not to touch any of the contacts. Doing so may damage the module.

1. Remove/disengage any security devices that prohibit opening the computer.
2. Remove all removable media, such as a USB flash drive, from the computer.
3. Turn off the computer properly through the operating system, then turn off any external devices.
4. Disconnect the power cord from the power outlet and disconnect any external devices.

⚠ CAUTION: You must disconnect the power cord and wait approximately 30 seconds for the power to drain before adding or removing memory modules. Regardless of the power-on state, voltage is always supplied to the memory modules as long as the computer is plugged into an active AC outlet. Adding or removing memory modules while voltage is present may cause irreparable damage to the memory modules or system board.

5. If the computer is on a stand, remove the computer from the stand and lay the computer down.
6. Remove the computer access panel.

7. Disconnect the hard drive power cable (1) and data cable (2) from the system board.

⚠ WARNING! To reduce risk of personal injury from hot surfaces, allow the internal system components to cool before touching.

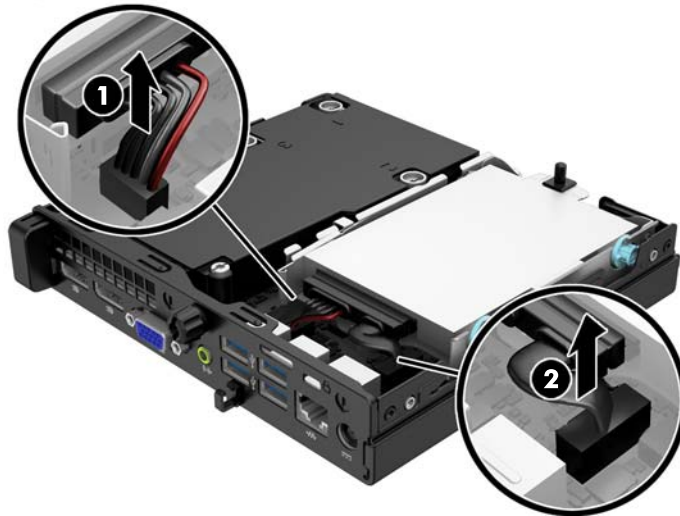

8. Pull the release lever next to the rear of the hard drive outward (1). While pulling the release lever out, slide the drive back until it stops, then lift the drive up and out of the bay (2).

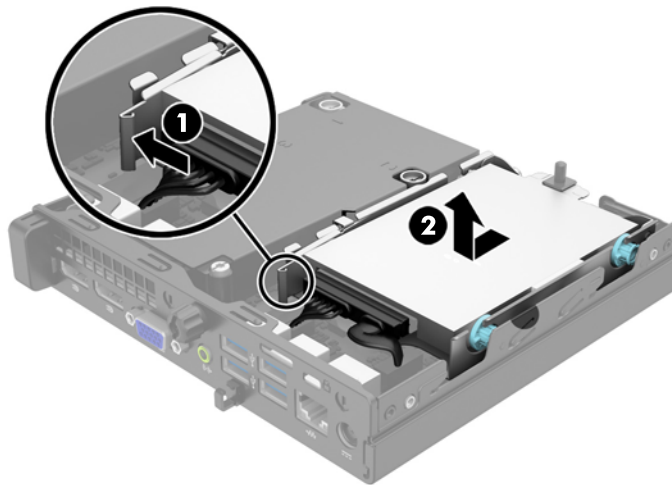

9. To remove a SODIMM, press outward on the two latches on each side of the SODIMM (1) then pull the SODIMM out of the socket (2).

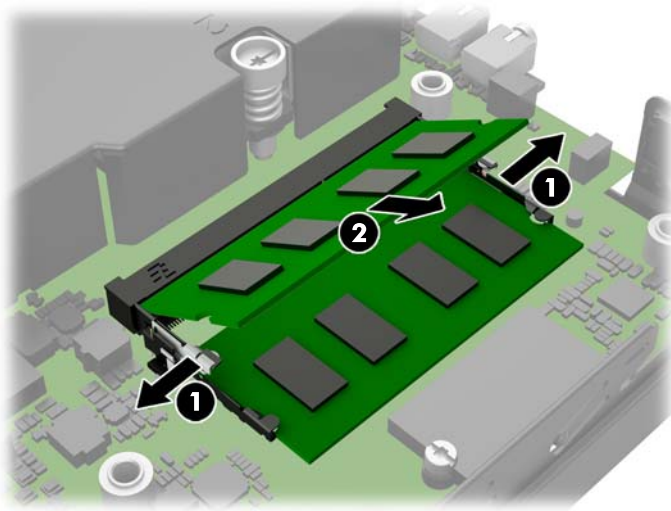

10. Slide the new SODIMM into the socket at approximately a 30° angle (1) then press the SODIMM down (2) so that the latches lock it in place.

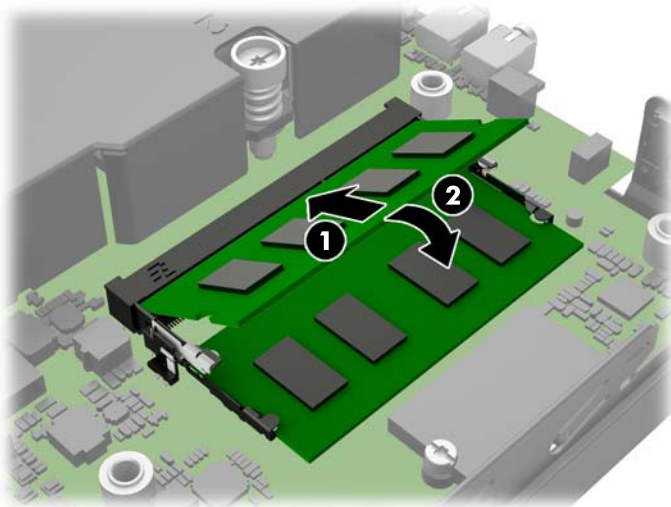

 **NOTE:** A memory module can be installed in only one way. Match the notch on the module with the tab on the memory socket.

11. Replace the hard drive and connect the power and data cables to the system board.
12. Replace the access panel.
13. If the computer was on a stand, replace the stand.
14. Reconnect the power cord and turn on the computer.
15. Lock any security devices that were disengaged when the computer cover or access panel was removed.

The computer automatically recognizes the additional memory when you turn on the computer.

Replacing the battery

The battery that comes with the computer provides power to the real-time clock. When replacing the battery, use a battery equivalent to the battery originally installed in the computer. The computer comes with a 3-volt lithium coin cell battery.

⚠ WARNING! The computer contains an internal lithium manganese dioxide battery. There is a risk of fire and burns if the battery is not handled properly. To reduce the risk of personal injury:

Do not attempt to recharge the battery.

Do not expose to temperatures higher than 60°C (140°F).

Do not disassemble, crush, puncture, short external contacts, or dispose of in fire or water.

Replace the battery only with the HP spare designated for this product.

⚠ CAUTION: Before replacing the battery, it is important to back up the computer CMOS settings. When the battery is removed or replaced, the CMOS settings will be cleared.

Static electricity can damage the electronic components of the computer or optional equipment. Before beginning these procedures, ensure that you are discharged of static electricity by briefly touching a grounded metal object.

📝 NOTE: The lifetime of the lithium battery can be extended by plugging the computer into a live AC wall socket. The lithium battery is only used when the computer is NOT connected to AC power.

HP encourages customers to recycle used electronic hardware, HP original print cartridges, and rechargeable batteries. For more information about recycling programs, go to <http://www.hp.com/recycle>.

1. Remove/disengage any security devices that prohibit opening the computer.
2. Remove all removable media, such as a USB flash drive, from the computer.
3. Turn off the computer properly through the operating system, then turn off any external devices.
4. Disconnect the power cord from the power outlet and disconnect any external devices.

⚠ CAUTION: Regardless of the power-on state, voltage is always present on the system board as long as the system is plugged into an active AC outlet. You must disconnect the power cord to avoid damage to the internal components of the computer.

5. Remove the computer access panel.

6. Locate the battery and battery holder on the system board.

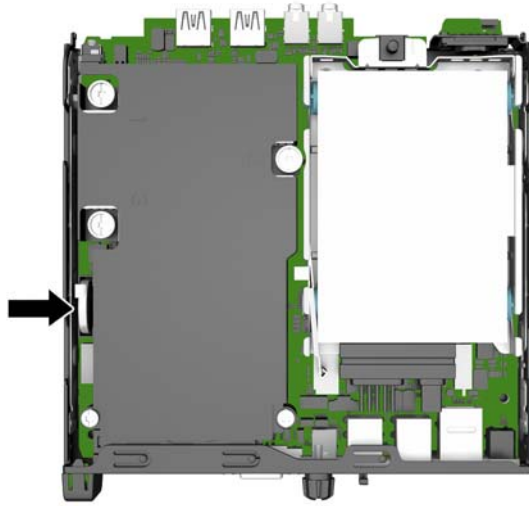

7. Depending on the type of battery holder on the system board, complete the following instructions to replace the battery.

 **NOTE:** You may need to use a small tool, such as tweezers or needle-nose pliers, to remove and replace the battery.

Type 1

- a. Pull back on the clip (1) that is holding the battery in place, and lift the battery out of the holder (2).

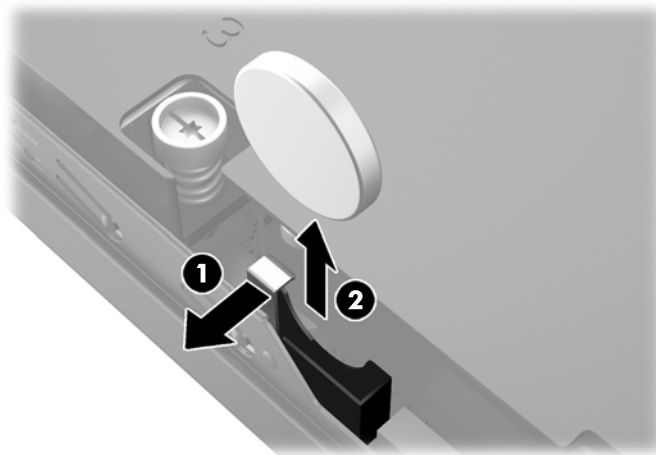

- b.** Pull back on the clip (1) and slide the replacement battery down into the holder (2).

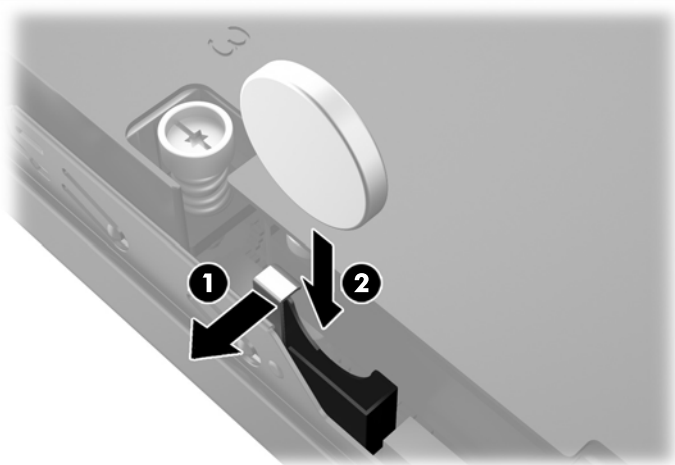

Type 2

- a.** Push the battery toward the outside of the chassis to release it from the holder and lift it out.



- b.** Lower the battery so that it is next to the holder then push it into the holder.



 **NOTE:** After the battery has been replaced, use the following steps to complete this procedure.

8. Replace the computer access panel.
9. Plug in the computer and turn on power to the computer.
10. Reset the date and time, your passwords, and any special system setups using Computer Setup.
11. Lock any security devices that were disengaged when the computer access panel was removed.

Installing a security lock

The security locks displayed below and on the following pages can be used to secure the computer.

Cable lock



Padlock



A Electrostatic discharge

A discharge of static electricity from a finger or other conductor may damage system boards or other static-sensitive devices. This type of damage may reduce the life expectancy of the device.

Preventing electrostatic damage

To prevent electrostatic damage, observe the following precautions:

- Avoid hand contact by transporting and storing products in static-safe containers.
- Keep electrostatic-sensitive parts in their containers until they arrive at static-free workstations.
- Place parts on a grounded surface before removing them from their containers.
- Avoid touching pins, leads, or circuitry.
- Always be properly grounded when touching a static-sensitive component or assembly.

Grounding methods

There are several methods for grounding. Use one or more of the following methods when handling or installing electrostatic-sensitive parts:

- Use a wrist strap connected by a ground cord to a grounded workstation or computer chassis. Wrist straps are flexible straps with a minimum of 1 megohm +/- 10 percent resistance in the ground cords. To provide proper ground, wear the strap snug against the skin.
- Use heelstraps, toestraps, or bootstraps at standing workstations. Wear the straps on both feet when standing on conductive floors or dissipating floor mats.
- Use conductive field service tools.
- Use a portable field service kit with a folding static-dissipating work mat.

If you do not have any of the suggested equipment for proper grounding, contact an HP authorized dealer, reseller, or service provider.



NOTE: For more information on static electricity, contact an HP authorized dealer, reseller, or service provider.

B Computer operating guidelines, routine care and shipping preparation

Computer operating guidelines and routine care

Follow these guidelines to properly set up and care for the computer and monitor:

- Keep the computer away from excessive moisture, direct sunlight, and extremes of heat and cold.
- Operate the computer on a sturdy, level surface. Leave a 10.2-cm (4-inch) clearance on all vented sides of the computer and above the monitor to permit the required airflow.
- Never restrict the airflow into the computer by blocking any vents or air intakes. Do not place the keyboard, with the keyboard feet down, directly against the front of the desktop unit as this also restricts airflow.
- Never operate the computer with the access panel or any of the expansion card slot covers removed.
- Do not stack computers on top of each other or place computers so near each other that they are subject to each other's re-circulated or preheated air.
- If the computer is to be operated within a separate enclosure, intake and exhaust ventilation must be provided on the enclosure, and the same operating guidelines listed above will still apply.
- Keep liquids away from the computer and keyboard.
- Never cover the ventilation slots on the monitor with any type of material.
- Install or enable power management functions of the operating system or other software, including sleep states.
- Turn off the computer before you do either of the following:
 - Wipe the exterior of the computer with a soft, damp cloth as needed. Using cleaning products may discolor or damage the finish.
 - Occasionally clean the air vents on all vented sides of the computer. Lint, dust, and other foreign matter can block the vents and limit the airflow.

Shipping preparation

Follow these suggestions when preparing to ship the computer:

1. Back up the hard drive files to an external storage device. Be sure that the backup media is not exposed to electrical or magnetic impulses while stored or in transit.



NOTE: The hard drive locks automatically when the system power is turned off.

2. Remove and store all removable media.
3. Turn off the computer and external devices.
4. Disconnect the power cord from the electrical outlet, then from the computer.
5. Disconnect the system components and external devices from their power sources, then from the computer.



NOTE: Ensure that all boards are seated properly and secured in the board slots before shipping the computer.

6. Pack the system components and external devices in their original packing boxes or similar packaging with sufficient packing material to protect them.

Index

A

access panel
 removal 11
 replacement 12

B

battery replacement 22

C

computer operating guidelines 27

E

electrostatic discharge, preventing
 damage 26

F

front panel components
 EliteDesk 800, EliteDesk 705,
 ProDesk 600 2
 ProDesk 400 3

H

hard drive
 installation 14
 removal 14

I

installation guidelines 9
installing
 battery 22
 computer access panel 12
 hard drive 14
 memory 17

L

locks
 cable lock 25
 padlock 25

M

memory
 installation 17
 socket population 18
 specifications 17

P

power cord connection 10
product ID location 8

R

rear panel components
 EliteDesk 705 5
 EliteDesk 800 4
 ProDesk 400 7
 ProDesk 600 6
removing
 battery 22
 computer access panel 11
 hard drive 14

S

security
 cable lock 25
 padlock 25
serial number location 8
shipping preparation 28
specifications
 memory 17

T

tower conversion 13

V

ventilation guidelines 27