



f800g

**Car Camcorder
User Manual**

Contents

About this Guide	3
FCC Statement	3
Prohibition of co-location.....	3
Important note	4
WEEE Notice.....	4
CE Regulatory Notice	4
Battery warning.....	5
Notes on Installation	5
Caution	6
1 Introduction.....	7
1.1 Features.....	7
1.2 Package Contents	7
1.3 Product Overview.....	8
2 Getting Started	9
2.1 Inserting the Memory Card	9
2.2 Installing in Vehicles	10
2.2.1 Mount to Windshield	10
2.2.2 Adjust the device position	11
2.3 Connecting to Power.....	12
2.4 LED Indicator.....	13
2.5 Powering the Camcorder On / Off	14
2.5.1 Auto Power On/Off	14
2.5.2 Manual Power On/Off and Reset.....	14
2.5.2.1 Manual Power On	14
2.5.2.2 Power Off	14
2.5.2.3 Reset the Camcorder.....	14
2.6 Initial Settings.....	15

2.6.1	Set Automatic Record.....	15
2.6.2	Set the Date / Time	16
2.6.3	Setting the Universal Time Code (UTC)	17
3	Using the Car Recorder.....	18
3.1	Recording Videos	18
3.1.1	Record videos while driving	18
3.1.2	LDWS (Lane Departure Warning Systems)	18
3.1.3	Driver Fatigue Alert	20
3.1.4	Motion Detection.....	21
3.1.5	Record all other types of videos.....	22
3.1.6	Emergency Recording	22
3.1.7	The Recording Screen.....	23
3.1.8	Taking Snapshot.....	24
3.1.9	4 GRID FUNCTION CHART in the LCD screen.....	25
3.2	Playing Videos and Viewing Pictures	26
3.2.1	Playing Videos and Emergency Recording	26
3.2.2	Viewing Pictures.....	27
3.2.3	The Playback Screen	28
3.2.4	Deleting Files	30
4	Adjusting the Settings	31
4.1	Using the Menu	31
4.2	Menu Items	32
5	Installing the Software	36
6	SuperCar	37
7	Specifications	38

About this Guide

The content in this document is for information purpose and is subject to change without prior notice. We made every effort to ensure that this User Guide is accurate and complete.

However, no liability is assumed for any errors and omissions that may have occurred.

The manufacturer reserves the right to change the technical specifications without prior notice.

FCC Statement

This equipment has been tested and found to comply with the limits for a Class B digital device, pursuant to Part 15 of the FCC Rules. These limits are designed to provide reasonable protection against harmful interference in a residential installation. This equipment generates, uses and can radiate radio frequency energy and, if not installed and used in accordance with the instructions, may cause harmful interference to radio communications. However, there is no guarantee that interference will not occur in a particular installation. If this equipment does cause harmful interference to radio or television reception, which can be determined by turning the equipment off and on, the user is encouraged to try to correct the interference by one or more of the following measures:

- Reorient or relocate the receiving antenna.
- Increase the separation between the equipment and receiver.
- Connect the equipment into an outlet on a circuit different from that to which the receiver is connected.
- Consult the dealer or an experienced radio/TV technician for help.

This device complies with Part 15 of the FCC Rules. Operation is subject to the following two conditions: (1) This device may not cause harmful interference, and (2) this device must accept any interference received, including interference that may cause undesired operation.

FCC Caution: Any changes or modifications not expressly approved by the party responsible for compliance could void the user's authority to operate this equipment.

Contains FCC ID: 2ACFIWM7911B

Prohibition of co-location

This device and its antenna(s) must not be co-located or operated in conjunction with any other antenna or transmitter.

Important note

Radiation Exposure Statement: This equipment complies with FCC radiation exposure limits set forth for an uncontrolled environment. End users must follow the specific operating instructions for satisfying RF exposure compliance. This equipment should be installed and operated with minimum distance 20cm between the radiator & your body. To maintain compliance with FCC exposure compliance requirements, please follow the operating instructions as documented in this manual.

WEEE Notice

Disposal of Waste Electrical and Electronic Equipment and/or Battery by users in private households in the European Union



This symbol on the product or on the packaging indicates that this can not be disposed of as a household waste. You must dispose of your waste equipment and/or battery by handing it over to the applicable take-back scheme for the recycling of electrical and electronic equipment and/or battery. For more information about recycling of this equipment and/or battery, please contact your city office, the shop where you purchased the equipment or your household waste disposal service. The recycling of materials will help to conserve natural resources and ensure that it is recycled in a manner that protects human health and environment.

CE Regulatory Notice

Herewith confirm to comply with the requirements set out in the Council Directives on the Approximation of the Laws of the Member States relating Electromagnetic Compatibility of Radio and Telecom device (1995/5/EC); the Low Voltage Directive (2006/95/EC); the Restriction of The Use of Certain Hazardous Substances in Electrical And Electronic Equipment Directive (2002/95/EC), Turkish EEE Directive.

EU Health Protection: This equipment should be installed and operated with minimum distance 20cm between the radiator & your body.

This product will meet the Basic Restriction limits of 1999/519/EC.

Battery warning

- ❖ Always charge using the provided system. Improper handling of the battery may result in explosion.
- ❖ Never dismantle or pierce the battery or allow the battery to short-circuit.
- ❖ Keep the battery out of reach of children.
- ❖ Batteries may explode if exposed to naked fire. Never dispose of batteries in a fire.
- ❖ **Disposed of used batteries observing local regulations. Never replace the battery on your own; have the dealer do it for you.**

Notes on Installation

1. This product shall be installed near the rear mirror, at the center of windshield, if possible, for optimal viewing.
2. Make sure that the lens is within the wiping range of the windshield wiper to ensure a clear view even when it rains.
3. Do not touch the lens with your fingers. Finger grease may be left on the lens and will result in unclear videos or snapshots. Clean the lens on a regular basis.
4. Do not install the device on a tinted window. Doing so may damage the tint film.
5. Make sure that the installation position is not hindered by the tinted window.
6. To use the products of the attached power charger only, please do not use other brand power charger, in order to avoid equipment burn or cause the battery explosion.

Caution

- ❖ Use the authorized charger only.
- ❖ Never disassemble or attempt repair of this product. Doing so may damage the camcorder, cause electric shock and void your product warranty.
- ❖ Never short-circuit the battery.
- ❖ Set up time and date accurately before you use this device.
- ❖ Exposing the camcorder to open flames can cause explosion.
- ❖ Due to local laws and vehicles safety considerations, do not manually operate the device while driving.
- ❖ The results of GPS positioning are only for reference, and should not affect the actual driving situation. The feature cannot ensure the location accuracy.
- ❖ GPS location accuracy may differ depending on weather and location such as high buildings, tunnels, undergrounds, or forests. GPS satellite signals cannot pass through solid materials (except glass). Tinted window may affect the performance of the GPS satellite reception.
- ❖ GPS reception performance on each device may differ. The accuracy of the location results from different devices.
- ❖ Please use the SuperCar software with recorded video for the electronic map.
- ❖ The values displayed in this system, such as speed, position, and the distance warning to the speed camera set points, may be inaccurate due to the influence of surrounding environment. They are for your reference only.
- ❖ Hewlett-Packard Company is NOT responsible for the loss of any data/content during operation.
- ❖ The firmware function in device are reference only, please follow the actual road condition.

Before you start using the Car Camcorder it is assumed that you agree to the above statements.

1 Introduction

Thank you for purchasing this advanced Car Recorder. This device is specifically designed for real time video and audio recording when driving.

1.1 Features

- Full HD recording videos (1920x1080@30fps or 1280x720@60fps)
- 2.7" LCD color touch screen
- Wide angle lens
- Multifunction traffic safety reminder
- Automatic Emergency recording for collision detection
- Support SDHC Level 6 and above. Support up to 32GB.

1.2 Package Contents

The package contains the following items. In case there is any missing or damaged item, contact your dealer immediately.

Camcorder

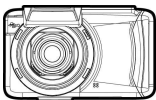

Bracket



CD-ROM



Quick start guide



Car adapter



1.3 Product Overview

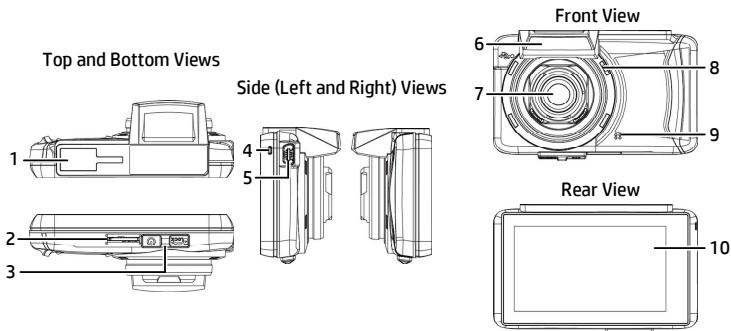

No.	Item
1	Bracket Socket
2	Memory Card Slot
3	Power Switch
4	LED Indicator
5	USB / Power Connector

No.	Item
6	GPS Antenna
7	Wide Angle Lens
8	Speaker
9	Microphone
10	LCD Touch Panel

2 Getting Started

2.1 Inserting the Memory Card

Insert memory card with the gold section facing upward and the screen of the device facing upward too, as illustrated. Push the memory card in until a click sound is heard, indicating the card is in position.

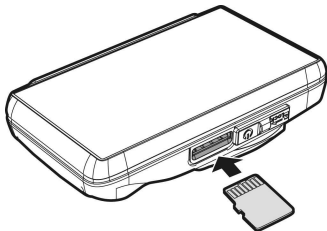

To remove the memory card

Push to eject the memory card out of the slot.

Note:

1. Do not remove or insert the memory card when the device is turned on. This may damage the memory card.
2. Please use a Class 6 or higher rating Micro SD card, max. up to 32GB.
3. Please format the micro SD cards before the initial use.
4. When removing the memory card, be careful that the card may spring out and get lost. The memory slot has this spring-out feature for easy removal of the card.

2.2 Installing in Vehicles

2.2.1 Mount to Windshield

1. Push the bracket into bracket slot on top of device, until a click sound is heard.



2. With the suction-cup laying flat, position the suction-cup on the windshield.
3. Hold the base firmly on the windshield and press down the clamp to mount the car holder to the windshield. Make sure the base is securely locked in place.



2.2.2 Adjust the device position

1. Loose the knob to swivel the device vertically.

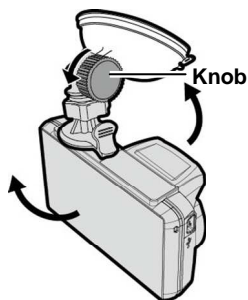

2. Loose the knob to swivel the device horizontally up to 360°.

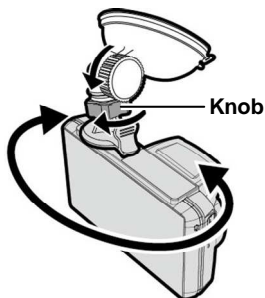

3. Then tighten the knob to make sure the device is securely locked in place.

2.3 Connecting to Power

Use only the supplied car adapter to power up the device and charging the built-in battery.

1. Connect one end of car adapter to USB/Power connector port on the camcorder.

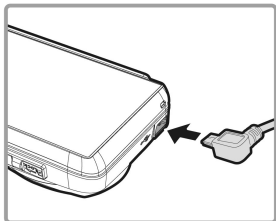



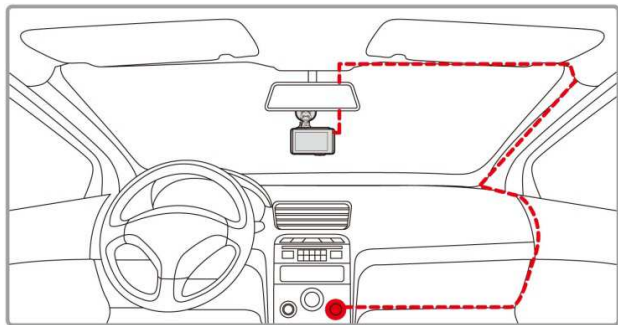



2. Plug the other end of the car adapter to the cigarette lighter socket of your vehicle. Once the vehicle engine is started, the camcorder automatically powers on.



Note:

This product shall be installed near the rear mirror, at the center of windshield, if possible, for optimal viewing.

Battery Status Indicator:

Icon	Description
	Full battery power.
	2/3 battery power.
	1/3 battery power.
	Out of battery power.
	Battery is charging.
	Connect the car adapter to charge the battery, battery is full charged.

Note:

Please take note if the environment temperature reaches 45°C or above, the car adapter still can supply power to device, but it will not charge the Lithium-ion battery. This is the characteristic of Lithium-ion and is not a malfunction.

2.4 LED Indicator

Status Explanation	LED Indicator Color
Power off, battery charging	Red
Power off, battery full charged	LED light off.
Power on, battery charging	Red
Power on, battery full charged	Green
Standby / Standby and screen off	Green
Recording/ Recording and screen off	Flash red

2.5 Powering the Camcorder On / Off

2.5.1 Auto Power On/Off

Once the vehicle engine is started, the camcorder automatically turns on. If the **Automatic Record** function is enabled, the recording will automatically start right after the camcorder powers on.

Please refer to **Set Automatic Record** (2.6.1).

2.5.2 Manual Power On/Off and Reset

2.5.2.1 Manual Power On

Slide the **power switch** and make sure that the power switch locks on the memory card slot.

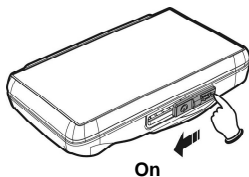

2.5.2.2 Power Off

The **power switch** to the edge and make sure that the memory slot is released and the camcorder starts power off sequence. Do not power on the camcorder when it is in the power-off sequence, or the recorded file may become corrupt.

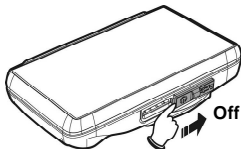

2.5.2.3 Reset the Camcorder







In case the camcorder fails to function normally due to unknown causes, slide the **power switch** and verify the memory card is in the removable state; wait for 7 seconds and slide the power switch again to restart the camcorder.

2.6 Initial Settings

Before using the device, we recommend you to enable the **Automatic Record** function and set up the correct **Date and Time**.

2.6.1 Set Automatic Record

Default setting of Automatic Record is Enabled. The device will automatically start recording when powered on. In case Automatic Record is disabled, enable it by the following steps:

1. Touch  to enter Main Menu.
2. Touch  to switchover to **Record** Main Menu.
3. Touch  /  to select  for entering **Automatic Record** function menu; touch again to select **ON**.
4. Touch  to return to Record screen.

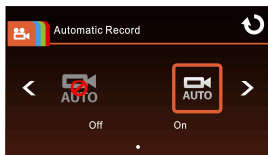
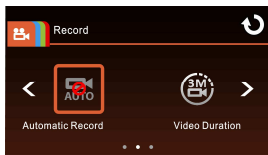

2.6.2 Set the Date / Time

To set the correct date and time, do the following:

1. Touch  to enter Main Menu.

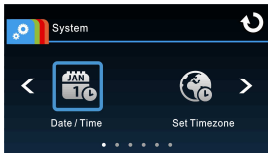

2. Select  to enter **Date / Time** menu. Touch  /  to select value; touch  /  to select

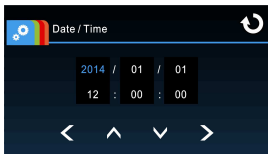









previous or next field; confirm by touching  to complete setting.

Note:

1. When the battery is depleted and the satellite synchronization is off, you must reset the date/time before the function -automatic record is started. If the user doesn't reset the date/time, the device will give you an alert after one minute and the automatic record will be started.
2. But if the satellite synchronized, the device can do automatic record immediately.

2.6.3 Setting the Universal Time Code (UTC)

Depending on your location, you may need to change the current UTC setting of the camcorder so that the correct date and time are updated when a GPS signal is detected.

1. Touch  to enter Main Menu.
2. In  **System** main menu, touch   to select  for **Set Timezone** menu, touch   to set the current time zone; then touch  again to complete setting.

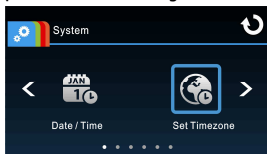

City	UTC	City	UTC	City	UTC	City	UTC	City	UTC
Accra	0	Budapest *	+1	Houston *	-6	Melbourne	+10	Santiago	-4
Addis Ababa	+3	Buenos Aires	-3	Indianapolis *	-5	Mexico City *	-6	Santo Domingo	-4
Adelaide **	+9	Cairo	+2	Islamabad	+5	Miami *	-5	São Paulo	-3
Algiers	+1	Calgary *	-7	Istanbul *	+2	Minneapolis *	-6	Seattle *	-8
Almaty	+6	Canberra	+10	Jakarta	+7	Minsk	+3	Seoul	+9
Amman *	+2	Cape Town	+2	Jerusalem *	+2	Montevideo	-3	Shanghai	+8
Amsterdam *	+1	Caracas **	-4	Johannesburg	+2	Montreal *	-5	Singapore	+8
Anadyr	+12	Casablanca *	0	Kabul **	+4	Moscow	+4	Sofia *	+2
Anchorage *	-9	Chicago *	-6	Karachi	+5	Mumbai **	+5	St. John's **	-3
Ankara *	+2	Columbus *	-5	Katmandu **	+5	Nairobi	+3	Stockholm *	+1
Antananarivo	+3	Copenhagen *	+1	Khartoum	+3	Nassau *	-5	Suva	+12
Asuncion	-4	Dallas *	-6	Kingston	-5	New Delhi **	+5	Sydney	+10
Athens *	+2	Dar es Salaam	+3	Kinshasa	+1	New Orleans *	-6	Taipei	+8
Atlanta *	-5	Darwin **	+9	Kiritimati	+14	New York *	-5	Tallinn *	+2
Auckland	+12	Denver *	-7	Kolkata **	+5	Oslo *	+1	Tashkent	+5
Baghdad	+3	Detroit *	-5	Kuala Lumpur	+8	Ottawa *	-5	Tepecigalpa	-6
Bangalore	+5	Dhaka	+6	Kuwait City	+3	Paris *	+1	Tehran **	+3
Bangkok	+7	Doha	+3	Kyiv *	+2	Perth	+8	Tokyo	+9
Barcelona *	+1	Dubai	+4	La Paz	-4	Philadelphia *	-5	Toronto *	-5
Beijing	+8	Dublin *	0	Lagos	+1	Phoenix	-7	Vancouver *	-8
Beirut *	+2	Edmonton *	-7	Lahore	+5	Prague *	+1	Vienna *	+1
Belgrade *	+1	Frankfurt *	+1	Las Vegas *	-8	Reykjavik	0	Warsaw *	+1
Berlin *	+1	Guatemala	-6	Lima	-5	Rio de Janeiro	-3	Washington DC *	-5
Bogota	-5	Halifax *	-4	Lisbon *	0	Riyadh	+3	Winnipeg *	-6
Boston *	-5	Hanoi	+7	London *	0	Rome *	+1	Yangon **	+6
Brasilia	-3	Harare	+2	Los Angeles *	-8	Salt Lake City *	-7	Zagreb *	+1
Brisbane	+10	Havana *	-5	Madrid *	+1	San Francisco *	-8	Zürich *	+1
Brussels *	+1	Hong Kong	+8	Managua	-6	San Juan	-4		
Bucharest *	+2	Honolulu	-10	Manila	+8	San Salvador	-6		

* Be sure to adjust for daylight saving time (DST) by adding +1 hour to the UTC offset.

** These areas may observe half hour increments and daylight saving time (DST).

3 Using the Car Recorder

3.1 Recording Videos

3.1.1 Record videos while driving

When the vehicle engine starts up and the **Automatic Record** function is enabled, the device automatically turns on and starts recording.

The touch panel function is not ready yet within 2 seconds upon the auto recording start .

Recording will automatically stop when the engine is switched off, or touch  to stop recording manually.



Note:

On some cars, the recording will continue when the engine is switched off. If this happens, please manually turn off the cigarette lighter or remove the car adapter from the cigarette lighter.





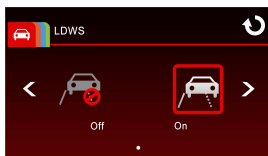
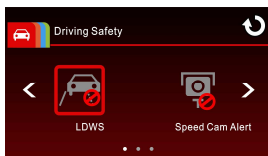

3.1.2 LDWS (Lane Departure Warning Systems)

When **LDWS** is enabled after satellite positioning, camcorder will give a voice alert and display an alarm screen if vehicle speed reaches or exceeds 50 km/h (31 mile/h) and the vehicle deviates from the original lane.

To set the LDWS (Lane Departure Warning Systems), do the following:

1. Ensure the camcorder is connected to the power adapter and is receiving power.
2. Touch  to enter Main Menu.
3. Touch  to switchover to **Driving Safety** Main Menu.



- Touch  /  to select  for entering **LDWS** function menu, then touch  again to enable the function (**on**).
- Touch  to return to record screen.
- After enabling LDWS, screen displays LDWS cross line , please adjust the equipment to align the skyline with the horizontal line, and make sure the vertical line in the middle of road.

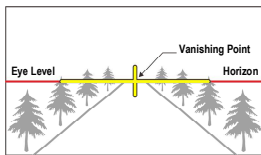
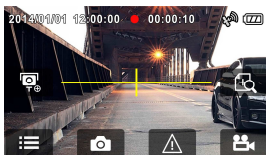

- When satellite positioning is in ready state, device will give a voice alert and an alarm screen if vehicle speed reaches or exceeds 50 km/h (31 mile/h) and the vehicle deviates from the original lane.









Note:

- LDWS is only applicable when satellite positioning is in ready state. Make sure satellite positioning of your device is ready if you want to activate this function. Satellite positioning function is dependent on the model purchased.
- When enable the LDWS, please follow this self-aligned approach in order to increase the accuracy.
- The all **Driving Safety** functions such as LDWS, Speed Cam Alert, Speed Limit Alert, Driver Fatigue Alert and Collision Detection will be disabled, if the product doesn't connect with the external power supply.

3.1.3 Driver Fatigue Alert

When **Driver Fatigue Alert** is enabled, a voice alert and a warning screen will be activated 1 hour after the device is powered on, with a repetition at every subsequent 30 minutes.

To set the driver fatigue alert, do the following:

1. Touch  to enter main menu.
2. Touch  to switch over to **Driving Safety** Main Menu.
3. Touch  /  to select  for entering **Driver Fatigue Alert** menu, touch  again to activate (**on**).
4. Touch  to return to record screen.

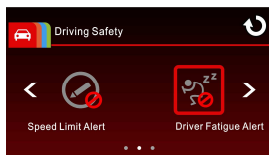







Note:

The all **Driving Safety** functions such as LDWS, Speed Cam Alert, Speed Limit Alert, Driver Fatigue Alert and Collision Detection will be disabled, if the product doesn't connect with the external power supply.

3.1.4 Motion Detection

If **Motion Detection** is activated, when the camcorder is powered on, a message “**Wait for 10 seconds to enter Motion Detection or touch the screen to power off**” will be displayed on the screen. This means the system will enter Motion Detection automatically in 10 seconds; when the camcorder detects any motion in front of lens, Video Record will be activated for a duration the same as the length setting.

To set the motion detection, do the following:

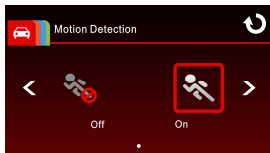
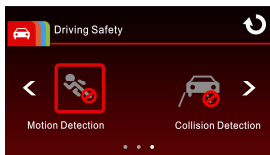

1. Touch  to enter main menu.
2. Touch  to switch over to **Driving Safety** Main Menu.
3. Touch  /  to select  for entering **Motion Detection** menu, touch  again to activate (**on**).
4. Touch  to return to record screen.



Note:

1. When the battery is fully charged and is in good condition, Motion Detection can record continuously for about 30 minutes.
2. As the device is used, the battery storage capacity will decrease gradually. This is a normal phenomenon for the battery.

3.1.5 Record all other types of videos



1. Touch  to start recording.
2. Touch  again, to halt the recording.

Note:

1. It can be configured to save a video file for every 3 or 5 minutes of recording. Please refer to *Video Duration* (4.2).
2. The device saves the recording in the memory card. If the memory card capacity is full, the oldest file in the memory card will be overwritten.

3.1.6 Emergency Recording

Start the Emergency Recording, do the following:

1. During video recording, touch  to enter emergency recording mode, the “Emergency” message will be shown immediately on the lower left corner of the screen, and the recorded file will be protected.
2. Touch  again, to halt the recording.

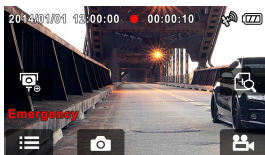





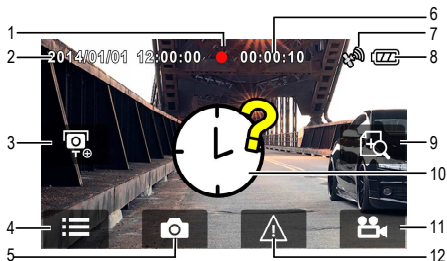

Note:

1. If the **Collision Detection** function is enabled and a collision is detected, the camcorder will automatically trigger the emergency recording. Please refer to *Collision Detection* (4.2).
2. The emergency recording file is created as a new file, which will be protected to avoid being overwritten by normal looping recording. 8G (or above) memory card can save up to 8 emergency video files. The alert message of “**Emergency files are full**” will pop up on the screen when the emergency recording files are full, and the oldest emergency file will be automatically deleted when a new emergency recording file is created.

3.1.7 The Recording Screen





No.	Icon	Item	Description
1		Recording Icon	Indicates the recording status.
2		Date / Time	Indicates the current recording date and time.
3		Add speed point	Touch to add a speed cam point.
4		Menu	Touch to enter the main menu.
5		Taking Snapshot	While recording, touch to take a photo.
6		Recording Duration	Indicates the video current duration.
7		Satellite positioning icon	The icon appears on the screen when satellite positioning of the device is ready.
8		Battery	Indicates the remaining battery power.
9		4 GRID FUNCTION CHART in the LCD	Touch to enter the 4 GRID FUNCTION CHART in the LCD screen.

		screen	Please refer to 4 GRID FUNCTION CHART in the LCD screen (3.1.9).
10		Reset of date / time Prompt	Remind the user to reset the Date / Time before start to use the device. Please refer to Set the Date / Time (2.6.2)
11		Recording	Touch  to start recording, touch  again to halt the recording.
12		Emergency Recording	During video recording, touch  to enter emergency recording mode. Please refer to Emergency Recording (3.1.6).

3.1.8 Taking Snapshot

You can also use this camcorder to take snapshots of the current scene.

1. Press  in recording mode to take a snapshot.
2. A snapshot is taken when this  icon appears at center of screen.

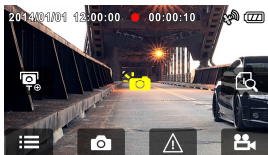

3.1.9 4 GRID FUNCTION CHART in the LCD screen

Please touch  when you are recording, then you can see the 4 GRID FUNCTION CHART in the LCD screen.

Touch any point of the screen to return to Record Screen.

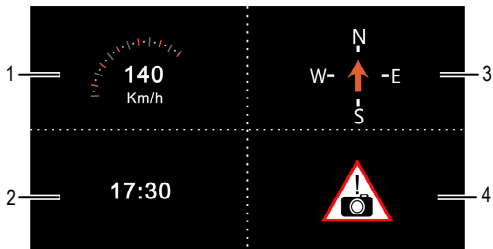

No.	Item
1	Driving Speed
2	Time

No.	Item
3	Driving direction
4	Speed Cam Alert

Note:

Driving Speed, Driving Direction and Speed Cam Alert are only applicable when satellite positioning of the device is ready; otherwise, they will be displayed in gray scale only. Satellite positioning function is dependent on the model purchased.

3.2 Playing Videos and Viewing Pictures

3.2.1 Playing Videos and Emergency Recording



Playback video record files as follows:

1. Touch  to enter main menu.

2. Touch  to switch over to **File / Position** menu.

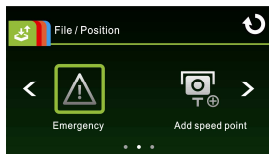
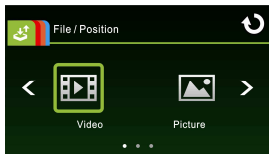
3. Touch  to enter **Video/ Emergency** function menu.





4. Touch   to browse for required video file, touch selected preview of video to enter Playback Mode





5. Touch  repetitively to return to Record Screen.

3.2.2 Viewing Pictures

View pictures as follows:

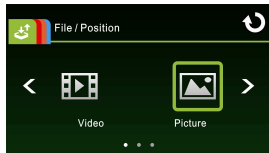
1. Touch  to enter Main Menu.
2. Touch  to switch over to **File / Position** main menu.
3. Touch  to enter **Picture** function menu.



4. Touch   to browse for required picture files, touch selected preview of picture to enter Picture Playback Mode.



5. Touch  repetitively to return Record Screen.





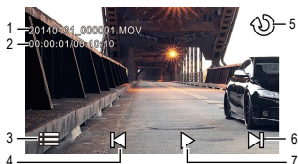



3.2.3 The Playback Screen





Video Playback Screen



Picture Playback Screen











No.	Icon	Item	Description
1	20140101_000001.MOV	File Name	Indicates name of current video or picture file.
2	00:00:01/ 00:00:10	Current Duration / Video Duration	Indicates time code and duration of current video file.
3		Menu	Touch  to enter File Deletion menu.
4		Fast Rewind / Previous File	<ul style="list-style-type: none"> • Touch  when video or picture is not in playback will switch over to the previous file. • Touch  in video playback mode will reverse the playback.
5		Return	Touch  to return to preview screen of video or picture. Touch  repetitively to return to record screen.

No.	Icon	Item	Description
6		Fast Forward / Next File	<ul style="list-style-type: none"> • Touch  when video or picture is not in playback will switch over to the next file. • Touch  in video playback mode will enable fast forward playing of video.
7		Playback/ Pause	Touch  to play or pause the video.

3.2.4 Deleting Files

To delete file(s), do the following:

1. Touch  to enter Main Menu.
2. Touch  to switch over to **File / Position** main menu.
3. Touch  to enter **Video/Picture/Emergency** menu.
4. Touch  to browse for required video or picture file; touch selected preview image to enter **Video/Picture Playback Mode**.
5. Touch  to enter **File Deletion** menu, select /  to delete one file or all files; touch /  to confirm or cancel the selection.

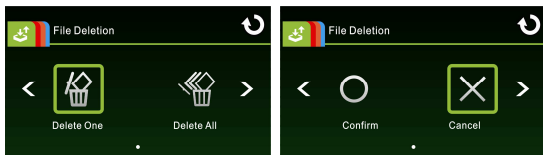

Item	Description
Delete One	Delete the current file.
Delete All	Delete all files.

6. Touch  repetitively to return to Record Screen.

Note:







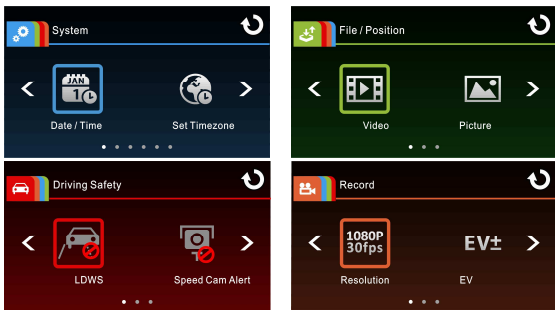

Deleted files cannot be recovered. Ensure the files have backup before deletion.

4 Adjusting the Settings

4.1 Using the Menu









You can customize the general settings via the on-screen display (OSD) menus.























1. Touch  in the record mode will stop the record and enter into Main Menu.
2. Touch  /  /  /  to switch over main menus.
3. Touch  /  to browse for function items in the respective main menu; touch a function icon to enter setting screen.
4. On completion of setting a required function item, device will return automatically to the main menu of the selected function.
5. Touch  to return to Record Screen.



4.2 Menu Items

Refer to the below table for details of main menu and function list.

Main Menu	Function List	Description	Available Option
 System	 Date / Time	Set the date and time.	
	 Set Timezone	Set the time zone you are in.	UTC -12:00 ~ UTC +12:00
	 Time Sync.	When enabled, camcorder clock will be calibrated automatically based on satellite clock of the set time zone on completion of satellite positioning.	On / Off
	 Beep	Enable/Disable the beep.	Off / Low / Medium / High
	 Language settings	Set the on-screen display menu language.	English / 繁體中文 / 简体中文 / Русский / Español / Deutsch / Français / Português / Italiano / Japanese / Arabic
	 Distance Unit	Select the display unit for distance.	KM / MILE
	 LCD setting	Set LCD off time. Device screen will be off after a set time if no operation is detected during the standby or record mode. Touch any point of the touch screen will switch it on. (Recording is not affected when screen is off).	On / Off After 30 sec. / Off After 3 min.
	 Satellite System	Select satellite system of the locality.	GPS / GLONASS

Main Menu	Function List	Description	Available Option
	 Recorder Format	Format the memory card inserted in the equipment. All the files in the card will be erased.	Yes / No
	 Default Setting	Resume the camcorder to its default setting.	Yes / No
	 Firmware Version	Indicates the current Firmware.	
 File / Position	 Video	Play / Delete a video file.	
	 Picture	Play / delete a picture file.	
	 Emergency	Play / delete an emergency record file.	
	 Add speed point	Manually add speed points after satellite positioning, up to 200 user defined speed points can be added.	
	 Delete speed point	Delete all the user defined speed points from system.	
 Driving Safety	 LDWS	When LDWS is enabled after satellite positioning, camcorder will give a voice alert and an alarm screen if vehicle speed reaches or exceeds 50 km/h (31 mile/h) and the vehicle deviates from the original lane.	On / Off
	 Speed Cam Alert	When a vehicle approaches a speed detection camera, the device will issue a voice	On / Off

Main Menu	Function List	Description	Available Option
	 Speed Limit Alert	alert and an alarm screen for reminding. User defined speed limit. Camcorder will issue an alert sound when vehicle speed exceeds the setting value.	Off / 50 km/h ~ 200 km/h
	 Driver Fatigue Alert	When Driver Fatigue Alert is enabled, a voice alert and a warning screen will be activated 1 hour after the device is powered on, with a repetition every subsequent 30 minutes.	On / Off
	 Motion Detection	If Motion Detection is activated, the camcorder will automatically trigger recording when the device detects any motion in front. When the battery is fully charged and is in good condition, Motion Detection can record continuously for about 30 minutes.	On / Off
	 Collision Detection	The camcorder will automatically trigger emergency recording when tremor of a collision is detected.	High Sensitivity / Normal Sensitivity / Low Sensitivity / Off
 Record	 Resolution	Setting of video resolution.	FHD (1080P/30fps) / HD30 (720P/30fps) / HD60 (720P/60fps)
	 EV	Set the exposure compensation.	+2.0 ~ -2.0
	 Automatic Record	Setting for enabling Automatic Record after camcorder power on.	On / Off

Main Menu	Function List	Description	Available Option
	 Video Duration	Save respective video files in a length of the selected duration.	3 min. / 5 min.
	 Voice Record	Setting for activating audio in the video.	On / Off
	 Time Stamp	Setting for the indication of date and time stamp on the picture or video recorded.	On / Off

Note:

The all **Driving Safety** functions such as LDWS, Speed Cam Alert, Speed Limit Alert, Driver Fatigue Alert and Collision Detection will be disabled, if the camcorder doesn't connect with the external power supply.

5 Installing the Software

1. Place the attached CD ROM into the CD player.
2. If the CD does not execute automatically, please use Windows File Manager to execute the **Install_CD.exe** file in the CD.

The following screen will be shown up.



3. Press the [Menu] item to start the installation process according to the instructions on-screen.

6 SuperCar

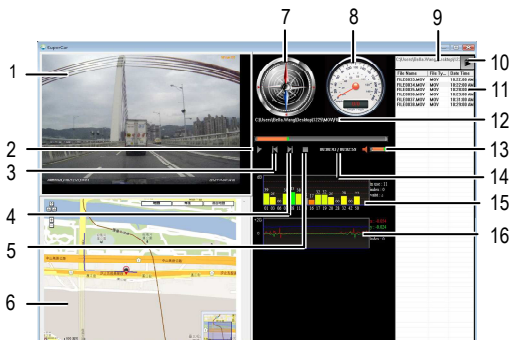

No.	Item
1	Video Player
2	Play / Pause
3	Previous
4	Next
5	Stop
6	Electronic Map
7	Compass
8	Speed Meter

No.	Item
9	File Path
10	Browser File
11	File List
12	File Name
13	Volume
14	Current Duration / Total Duration
15	Signal Noise Ratio (SNR)
16	G-Sensor

Note:

1. To display the route on Electronic Maps, please make sure the internet is connected before starting the video playback.
2. Video files (MOV / TS) and GPS/G-Sensor files (NMEA) must be stored in the same folder before starting the playback.
3. The SuperCar software is only applicable to a Windows operating system.

7 Specifications

Item	Description
Image sensor	1/2.7" CMOS sensor
Effective pixels	1920 (H) x 1080 (V)
Storage media	Support Micro SDHC Class 6, max. up to 32GB
LCD display	2.7" LCD color TFT touch screen
Lens	Wide Angle Fixed Focus lens Aperture: Up to F1.9 ; f=3.8mm
Focus range	1.5m~Infinity
Satellite System	GPS / GLONASS (Satellite Positioning feature varies depending on the model)
Movie Clip	Resolution: FHD (1080P/30fps); HD30 (720P/30fps); HD60 (720P/60fps)
	Format: MOV
Still image (Snapshot)	Resolution: 2M (1920 x 1080)
	Format: JPEG
Shutter	Electronic shutter Auto:1/2 ~1/2000 sec.
G-Sensor	3-Axis G-Force sensor
ISO	Auto
White Balance	Auto
Microphone	Yes
Speaker	Yes

Item	Description
Interface	Mini USB
Battery	Built-in 470mAh Li-polymer rechargeable (not customer replaceable)
Operating Temperature	0° ~ 50° C
Operating Humidity	20 ~ 70% RH
Storage Temperature	-20° ~ 80° C
Dimensions	80 x 30.3 x 51.2 mm
Weight	Approx. 82g (without memory card)