



# HP ElitePad 1000 G2 Rugged Tablet

User Guide

© Copyright 2015 HP Development Company,  
L.P.

Bluetooth is a trademark owned by its proprietor and used by HP Inc. under license. Java is a registered trademark of Oracle and/or its affiliates. Microsoft and Windows are either registered trademarks or trademarks of Microsoft Corporation in the United States and/or other countries.

The information contained herein is subject to change without notice. The only warranties for HP products and services are set forth in the express warranty statements accompanying such products and services. Nothing herein should be construed as constituting an additional warranty. HP shall not be liable for technical or editorial errors or omissions contained herein.

Second Edition: November 2015

First Edition: March 2015

Document Part Number: 798569-002

## Safety warning notice

---

 **WARNING!** To reduce the possibility of heat-related injuries or of overheating, do not allow the AC adapter to contact the skin or a soft surface, such as pillows or rugs or clothing, during operation. The tablet and the AC adapter comply with the user-accessible surface temperature limits defined by the International Standard for Safety of Information Technology Equipment (IEC 60950-1).

---



---

# Table of contents

<b>1 Welcome .....</b>	<b>1</b>
Finding information .....	2
<b>2 Getting to know your tablet .....</b>	<b>4</b>
Front .....	4
Back (closed) .....	6
Back (open) .....	7
Top .....	8
Bottom .....	9
Labels .....	9
Changing your tablet's settings .....	10
Changing your tablet's view .....	10
Using the tablet's autorotate lock feature .....	10
Adjusting your tablet's screen brightness .....	11
Finding your hardware and software information .....	11
Updating the software installed on the tablet .....	11
<b>3 Connecting to a network .....</b>	<b>12</b>
Connecting to a wireless network .....	12
Using the wireless controls .....	12
Using a WLAN .....	12
Using an Internet service provider .....	13
Setting up a WLAN .....	13
Configuring a wireless router .....	13
Protecting your WLAN .....	13
Connecting to a WLAN .....	14
Using Bluetooth wireless devices .....	14
Using HP Mobile Broadband (select models only) .....	15
<b>4 Navigating using touch gestures .....</b>	<b>16</b>
Using touch screen gestures .....	16
One-finger slide .....	16
Tapping .....	17
Scrolling .....	17
2-finger pinch zoom .....	18
Edge swipes (Windows 8 only) .....	18

Right-edge swipe .....	18
Left-edge swipe .....	19
Top-edge swipe .....	19
Using the on-screen keyboard .....	20

## **5 Detailed functions ..... 21**

Audio .....	21
Connecting speakers .....	21
Adjusting the volume .....	21
Connecting headphones and microphones .....	22
Checking audio functions on the tablet .....	22
Webcams .....	23
Video .....	23
HDMI .....	24
Configuring audio for HDMI .....	24
Bar-code scanner (select models only) .....	25
Configuring carriage returns .....	25
Configuring the bar-code scanner volume .....	26
Restoring default settings .....	27
Near Field Communications (NFC) .....	29

## **6 Power management ..... 30**

Shutting down the tablet .....	30
Setting power options .....	30
Using power-saving states .....	30
Initiating and exiting Sleep .....	30
Using the power meter and power settings .....	31
Setting password protection on wakeup .....	31
Using battery power .....	31
Factory-sealed batteries .....	32
Finding additional battery information .....	32
Using Battery Check .....	32
Displaying the remaining battery charge .....	32
Maximizing battery discharge time .....	32
Managing low battery levels .....	32
Identifying low battery levels .....	33
Resolving a low battery level .....	33
Conserving battery power .....	33
Using external AC power .....	33

<b>7 External cards and devices .....</b>	<b>35</b>
Using smart cards .....	35
Inserting a smart card .....	35
Removing a smart card .....	35
Using a USB device .....	35
Connecting a USB device .....	35
Removing a USB device .....	36
Using a serial device .....	36
Using optional external devices .....	37
Using optional external drives .....	37
Installing an optional security cable .....	38
<b>8 Security .....</b>	<b>39</b>
Protecting the tablet .....	39
Using passwords .....	39
Setting passwords in Windows .....	40
Setting passwords in Computer Setup .....	40
Managing a BIOS administrator password .....	40
Entering a BIOS administrator password .....	41
Using antivirus software .....	41
Using firewall software .....	42
Installing critical security updates .....	42
Using HP Client Security .....	42
<b>9 Maintenance .....</b>	<b>43</b>
IP-65 rating .....	43
Cleaning your tablet .....	43
Cleaning procedures .....	44
Cleaning the display .....	44
Cleaning the tablet .....	44
Updating programs and drivers .....	44
Using SoftPaq Download Manager .....	44
<b>10 Backup and recovery (Windows 8) .....</b>	<b>46</b>
Backing up your information .....	46
Performing a system recovery .....	46
Using the Windows recovery tools .....	46
Using f11 recovery tools .....	47
Changing the boot device order .....	47
Using Windows Refresh or Windows Reset .....	48

<b>11 Backup and recovery (Windows 10)</b> .....	<b>49</b>
Creating recovery media and backups .....	49
Creating HP Recovery media (select products only) .....	49
Using Windows tools .....	50
Restore and recovery .....	51
Recovering using HP Recovery Manager .....	51
What you need to know before you get started .....	51
Using the HP Recovery partition (select products only) .....	52
Using HP Recovery media to recover .....	52
Changing the tablet boot order .....	52
Removing the HP Recovery partition (select products only) .....	54
<b>12 Computer Setup (BIOS), TPM, and HP Sure Start</b> .....	<b>55</b>
Using Computer Setup .....	55
Starting Computer Setup .....	55
Navigating and selecting in Computer Setup .....	55
Restoring factory settings in Computer Setup .....	56
Updating the BIOS .....	57
Determining the BIOS version .....	57
Downloading a BIOS update .....	57
Changing the boot order using the f9 prompt .....	58
TPM BIOS settings (select products only) .....	58
Using HP Sure Start (select products only) .....	58
<b>13 HP PC Hardware Diagnostics (UEFI)</b> .....	<b>60</b>
Downloading HP PC Hardware Diagnostics (UEFI) to a USB device .....	60
<b>14 Support</b> .....	<b>62</b>
Contacting support .....	62
<b>15 Specifications</b> .....	<b>63</b>
Input power .....	63
Operating environment .....	63
<b>16 Accessibility</b> .....	<b>64</b>
Supported assistive technologies .....	64
Contacting support .....	64
<b>Appendix A Traveling with the tablet</b> .....	<b>65</b>



<b>Appendix B Electrostatic discharge .....</b>	<b>66</b>
<b>Appendix C Troubleshooting .....</b>	<b>67</b>
Troubleshooting resources .....	67
Resolving issues .....	67
The tablet is unable to start up .....	67
An external device is not working .....	67
A video is not visible on an external display .....	68
<b>Index .....</b>	<b>69</b>



---

# 1 Welcome

After you set up and register the tablet, it is important to take the following steps:

- **Connect to the Internet**—Set up your wireless network so that you can connect to the Internet. For more information, see [Connecting to a network on page 12](#).
- **Update your antivirus software**—Protect your tablet from damage caused by viruses. The software is preinstalled on the tablet. For more information, see [Using antivirus software on page 41](#).
- **Get to know your tablet**—Learn about your tablet features. See [Getting to know your tablet on page 4](#) and [Navigating using touch gestures on page 16](#) for additional information.
- **Find installed software**—Access a list of the software preinstalled on the tablet, as follows:

On tablets running Windows® 10, select the **Start** button, and then select **All apps**.

– or –

Tap and hold the **Start** button, and then select **Programs and Features**.

– or –

On tablets running Windows 8, on the Start screen, swipe up from the center of the touch screen to display the Apps screen.

For details about using the software included with the tablet, see the software manufacturer's instructions, which may be provided with the software or on the manufacturer's website.

- **Back up your hard drive by creating a recovery flash drive.** See [Backup and recovery \(Windows 8\) on page 46](#).

# Finding information

The tablet comes with several resources to help you perform various tasks.

Resources	For information about
<i>Setup Instructions</i> poster	<ul style="list-style-type: none"><li>• How to set up the tablet</li><li>• Help to identify tablet components</li></ul>
Get started app (Windows 10 only) To access the Get started app: Select the <b>Start</b> button, and then select the <b>Get started</b> app.	<ul style="list-style-type: none"><li>• A broad range of how-to information and troubleshooting tips</li></ul>
HP Support Assistant To access HP Support Assistant: <b>Windows 10</b> ▲ Type <code>support</code> in the taskbar search box, and then select the <b>HP Support Assistant</b> app. <b>Windows 8</b> ▲ On the Start screen, tap the <b>HP Support Assistant</b> app. To obtain the latest user guide, go to <a href="http://www.hp.com/support">http://www.hp.com/support</a> , and select your country. Select <b>Drivers &amp; Downloads</b> , and then follow the on-screen instructions	<ul style="list-style-type: none"><li>• Operating system information</li><li>• Software, driver, and BIOS updates</li><li>• Troubleshooting tools</li><li>• How to access support</li></ul>
HP support For U.S. support, go to <a href="http://www.hp.com/go/contactHP">http://www.hp.com/go/contactHP</a> . For worldwide support, go to <a href="http://welcome.hp.com/country/us/en/wwcontact_us.html">http://welcome.hp.com/country/us/en/wwcontact_us.html</a> .	<ul style="list-style-type: none"><li>• Online chat with an HP technician</li><li>• Support telephone numbers</li><li>• HP service center locations</li></ul>
<i>Regulatory, Safety, and Environmental Notices</i> To access this guide:	<ul style="list-style-type: none"><li>• Regulatory and safety information</li><li>• Environmental information</li></ul>
<b>Windows 10</b> ▲ Select the <b>Start</b> button, select <b>All apps</b> , select <b>HP Help and Support</b> , and then select <b>HP Documentation</b> . <b>Windows 8</b> ▲ Select the <b>HP Support Assistant</b> app on the Start screen, select <b>My computer</b> , and then select <b>User guides</b> .	
<i>Safety &amp; Comfort Guide</i> To access this guide:	<ul style="list-style-type: none"><li>• Proper workstation setup, posture, health, and work habits</li><li>• Electrical and mechanical safety information</li></ul>
<b>Windows 10</b> 1. Type <code>support</code> in the taskbar search box, and then select the <b>HP Support Assistant</b> app. – or – Select the question mark icon in the taskbar.	

Resources	For information about
<p>2. Select <b>My PC</b>, select the <b>Specifications</b> tab, and then select <b>User Guides</b>.</p>	
<p><b>Windows 8</b></p>	
<p>▲ Select the <b>HP Support Assistant</b> app on the Start screen, select <b>My computer</b>, and then select <b>User guides</b>.</p>	
<p>– or –</p>	
<p>Go to <a href="http://www.hp.com/ergo">http://www.hp.com/ergo</a>.</p>	
<p>HP website</p>	<ul style="list-style-type: none"> <li>• Support information</li> </ul>
<p>To obtain the latest user guide, go to <a href="http://www.hp.com/support">http://www.hp.com/support</a>, and select your country. Select <b>Drivers &amp; Downloads</b>, and then follow the on-screen instructions</p>	<ul style="list-style-type: none"> <li>• Ordering parts and finding additional help</li> <li>• Accessories available for the device</li> </ul>
<p><i>Limited Warranty*</i></p>	<p>Specific warranty information about this tablet</p>
<p>To access this guide:</p>	
<p><b>Windows 10</b></p>	
<p>1. Type <code>support</code> in the taskbar search box, and then select the <b>HP Support Assistant</b> app.</p>	
<p>– or –</p>	
<p>Select the question mark icon in the taskbar.</p>	
<p>2. Select <b>My PC</b>, and then select <b>Warranty and services</b>.</p>	
<p><b>Windows 8</b></p>	
<p>▲ Select the <b>HP Support Assistant</b> app on the Start screen, select <b>My computer</b>, and then select <b>Warranty services</b>.</p>	
<p>– or –</p>	
<p>Go to <a href="http://www.hp.com/go/orderdocuments">http://www.hp.com/go/orderdocuments</a>.</p>	
<p>*You can find the expressly provided HP Limited Warranty applicable to your product located with the user guides on your product and/or on the CD/DVD provided in the box. In some countries or regions, HP may provide a printed warranty in the box. For some countries or regions where the warranty is not provided in printed format, you may request a printed copy from <a href="http://www.hp.com/go/orderdocuments">http://www.hp.com/go/orderdocuments</a>. For products purchased in Asia Pacific, you can write to HP at HP Inc., P.O. Box 161, Kitchener Road Post Office, Singapore 912006. Include your product name, and your name, phone number, and postal address.</p>	

## 2 Getting to know your tablet

The following sections provide an overview of the HP ElitePad 1000 G2 Rugged Tablet capabilities.

- [Front](#)
- [Back \(closed\)](#)
- [Back \(open\)](#)
- [Top](#)
- [Bottom](#)
- [Labels](#)
- [Changing your tablet's settings](#)
- [Finding your hardware and software information](#)

### Front

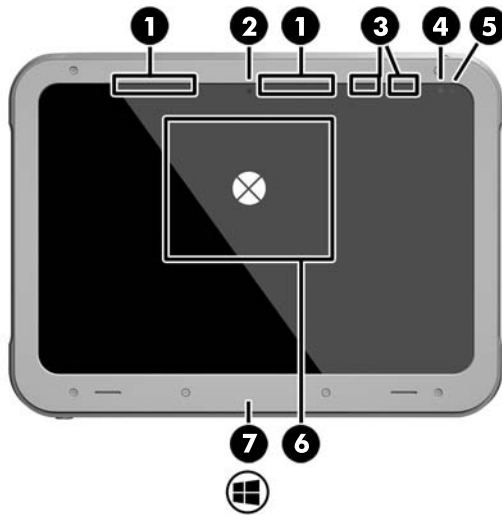

Component	Description
(1) WWAN antennas (2)* (select models only)	Send and receive wireless signals to communicate with wireless wide area networks (WWANs).
(2) Front webcam	Records video and captures still photographs. To use the webcam: <b>Windows 10</b> ▲ Type <code>cam</code> into the taskbar search box, and then tap <b>CyberLink YouCam</b> . <b>Windows 8</b> ▲ Tap <b>YouCam</b> on the Start screen. – or –

Component	Description
(3) WLAN antennas (2)*	Swipe from the right edge of the touch screen to display the charms, tap <b>Search</b> , and then tap the search box. In the search box, type <b>c</b> , and then tap <b>CyberLink YouCam</b> .
(4) Ambient light sensor	The ambient light sensor automatically adjusts the display brightness based on the lighting conditions in your environment.
(5) Webcam status light (front)	On: The webcam is on.
(6) Near Field Communications (NFC) tapping area (select models only)	Allows you to touch an NFC-compatible device to this area to wirelessly connect and communicate with the tablet and transfer data back and forth.
(7) Windows button	<b>Windows 10</b>
	Displays the Start menu.
	<b>Windows 8</b>
	Displays the Start screen.

\*The antennas are not visible on the outside of the tablet. For optimal transmission, keep the areas immediately around the antennas free from obstructions. To see wireless regulatory notices, see the section of the *Regulatory, Safety, and Environmental Notices* that applies to your country or region.

To access this guide:

**Windows 10**

1. Type **support** in the taskbar search box, and then select the **HP Support Assistant** app.

– or –

Select the question mark icon in the taskbar.

2. Select **My PC**, and then select **Warranty and services**.

**Windows 8**

- ▲ Select the **HP Support Assistant** app on the Start screen, select **My computer**, and then select **Warranty services**.

## Back (closed)



Component	Description
(1) I/O door	Provides access to an internal USB port and smart card reader.
(2) Hand strap connectors (2)	Are used to attach the included hand strap.
(3) Bar-code scanner buttons (2) (select models only)	Activate the bar-code scanner when pressed. For information about using the bar-code scanner, see <a href="#">Bar-code scanner (select models only) on page 25</a> .
(4) Webcam light	On: The webcam is in use.
(5) Webcam	Records video and captures photographs. Some models allow you to videoconference and chat online using streaming video. For information on using the webcam, access HP Support Assistant. To access HP Support Assistant, see <a href="#">Finding information on page 2</a> .
(6) Volume buttons (2)	Control the volume.
(7)  Security cable slot	Attaches an optional security cable to the tablet. Lift the edge of the security cable slot dust cover to access the slot. <b>NOTE:</b> The security cable is designed to act as a deterrent, but it may not prevent the tablet from being mishandled or stolen.





## Back (open)



Component	Description
(1)  Smart card reader	Supports a USB user authentication device that can be used while the I/O door is closed. HP does not recommend using a wireless transceiver or a USB device that prevents the I/O door from closing.  For details about different types of USB ports, see <a href="#">Using a USB device on page 35</a> .
(2) Smart card reader	Supports optional smart cards.







Component	Description
<p>(1)  Audio-out (headphone)/Audio-in (microphone) combo jack</p>	<p>Connects optional powered stereo speakers, headphones, earbuds, a headset, or a display audio cable. Also connects an optional headset microphone. This jack does not support optional microphone-only devices.</p> <p><b>WARNING!</b> To reduce the risk of personal injury, adjust the volume before putting on headphones, earbuds, or a headset. For additional safety information, see the <i>Regulatory, Safety, and Environmental Notices</i>.</p> <p>To access this guide:</p> <p><b>Windows 10</b></p> <p>Select the <b>Start</b> button, select <b>All apps</b>, select <b>HP Help and Support</b>, and then select <b>HP Documentation</b>.</p> <p><b>Windows 8</b></p> <p>Select the <b>HP Support Assistant</b> app on the Start screen, select <b>My computer</b>, and then select <b>User guides</b>.</p> <p><b>NOTE:</b> Be sure that the device cable has a 4-conductor connector that supports both audio-out (headphone) and audio-in (microphone).</p>
<p>(2)  Power button</p>	<ul style="list-style-type: none"> <li>• When the tablet is off, press the button to turn on the tablet.</li> <li>• When the tablet is on, press the button briefly to initiate Sleep.</li> <li>• When the tablet is in the Sleep state, press the button briefly to exit Sleep.</li> <li>• When the tablet is in Hibernation, press the button briefly to exit Hibernation.</li> </ul> <p><b>CAUTION:</b> Pressing and holding down the power button results in the loss of unsaved information.</p> <p>If the tablet has stopped responding and Windows® shutdown procedures are ineffective, press and hold the power button for at least 5 seconds to turn off the tablet.</p> <p>To learn more about your power settings, see your power options. See <a href="#">Setting power options on page 30</a>.</p>

## Bottom

The following components are protected by I/O doors. To open a door, gently lift its bottom edge.



Component	Description
(1)	Bar-code scanner (select models only) Scans bar codes. For information about using the bar-code scanner, see <a href="#">Bar-code scanner (select models only) on page 25</a> .
(2) 	HDMI port Connects an optional video or audio device, such as a high-definition display, any compatible digital or audio component, or a high-speed HDMI device.
(3) 	Power connector/Docking connector Connects an AC adapter or an optional docking device.
(4) 	USB 3.0 port Connects an optional USB device, such as a keyboard, mouse, external drive, printer, scanner or USB hub. For details about different types of USB ports, see <a href="#">Using a USB device on page 35</a> .
(5) 	RJ-45 (network) jack/lights Connects a network cable. <ul style="list-style-type: none"> <li>Green (left): The network is connected.</li> <li>Amber (right): Activity is occurring on the network.</li> </ul>
(6) 	DB9 serial port Connects an optional device such as a serial modem, mouse, or printer.
(7)	Shoulder strap connector Connects an optional shoulder strap.

## Labels

The labels affixed to the tablet provide information you may need when you troubleshoot system problems or travel internationally with the tablet.

 **IMPORTANT:** Check the following location for the labels described in this section: on the back of the tablet.

- Service label—Provides important information to identify your tablet. When contacting support, you will probably be asked for the serial number, and possibly for the product number or the model number. Locate these numbers before you contact support.
- Microsoft® Certificate of Authenticity label (select models only prior to Windows 8)—Contains the Windows Product Key. You may need the Product Key to update or troubleshoot the operating system. HP platforms with Windows 8 or Windows 8.x preinstalled do not have the physical label. Instead a Digital Product Key is electronically installed.

 **NOTE:** The Digital Product Key is automatically recognized and activated by Microsoft operating systems when a Windows 8 or Windows 8.x operating system is reinstalled using HP-approved recovery methods.

- Regulatory label(s)—Provide(s) regulatory information about the tablet.
- Wireless certification label(s)—Provide(s) information about optional wireless devices and the approval markings for the countries or regions in which the devices have been approved for use.
- Laser label(s) (select models only)—Provide information about using the bar-code scanner laser properly.

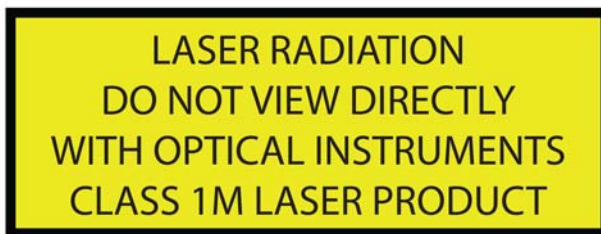

## Changing your tablet's settings

You can change view and screen brightness.

### Changing your tablet's view

Your tablet's orientation, or view, changes automatically from landscape to portrait view, or from portrait to landscape view.

1. To change the view of your tablet from landscape view to portrait view:  
Hold the tablet vertically, and then turn it 90 degrees to the right (in a clockwise direction).
2. To change the view of your tablet from portrait view to landscape view:  
Hold the tablet vertically, and then turn it 90 degrees to the left (in a counter-clockwise direction).

### Using the tablet's autorotate lock feature

To turn on your tablet's autorotate lock feature:

#### Windows 10

1. Tap the **Start** button, and then tap **Settings**.
2. Tap the screen icon to lock your current tablet view in place and to prevent rotation. The icon displays a lock symbol when the autorotate lock is active.

#### Windows 8

1. Swipe from the right edge of the touch screen to display the charms, and then tap **Settings**.
2. Tap the screen icon to lock your current tablet view in place and to prevent rotation. The icon displays a lock symbol when the autorotate lock is active.

To turn off your tablet's autorotate lock feature:

#### **Windows 10**

1. Tap the **Start** button, and then tap **Settings**.
2. Tap the **Screen** icon at the bottom right, and then tap the autorotate lock icon.

#### **Windows 8**

1. Swipe from the right edge of the touch screen to display the charms, and then tap **Settings**.
2. Tap the **Screen** icon at the bottom right, and then tap the autorotate lock icon.

## **Adjusting your tablet's screen brightness**

To adjust the screen brightness:

1. On a tablet running Windows 10, tap the **Start** button, and then tap **Settings**.

– or –

On a tablet running Windows 8, swipe from the right edge of the touch screen to display the charms, and then tap **Settings**.

2. Tap the **Screen** icon at the bottom right. A vertical slider displays that controls the screen brightness.



**NOTE:** On the Windows desktop, you can also tap the **Power Meter** icon in the notification area at the far right of the taskbar, tap **Adjust screen brightness**, and then move the slider next to **Screen brightness** at the bottom of the screen.

## **Finding your hardware and software information**

### **Updating the software installed on the tablet**

Most software, including the operating system, is updated frequently by the manufacturer or provider. Important updates to the software included with the tablet may have been released since the tablet left the factory.

Some updates may affect the way the tablet responds to optional software or external devices. Many updates provide security enhancements.

Update the operating system and other software installed on the tablet as soon as the tablet is connected to the Internet. Access the updates on the HP website at <http://www.hp.com>.

---

## 3 Connecting to a network

Your tablet can travel with you wherever you go. But even at home, you can explore the globe and access information from millions of websites using your tablet and a wireless network connection. This chapter will help you get connected to that world.

### Connecting to a wireless network

Wireless technology transfers data across radio waves instead of wires. Your tablet may be equipped with one or more of the following wireless devices:

- **Wireless local area network (WLAN) device**—Connects the tablet to wireless local area networks (commonly referred to as Wi-Fi networks, wireless LANs, or WLANs) in corporate offices, your home, and public places such as airports, restaurants, coffee shops, hotels, and universities. In a WLAN, the mobile wireless device in your tablet communicates with a wireless router or a wireless access point.
- **Bluetooth® device**—Creates a personal area network (PAN) to connect to other Bluetooth-enabled devices such as computers, phones, printers, headsets, speakers, and cameras. In a PAN, each device communicates directly with other devices, and devices must be relatively close together—typically within 10 meters (approximately 33 feet) of each other.

For more information about wireless technology, see the information and website links provided in HP Support Assistant. To access HP Support Assistant, see [Finding information on page 2](#).

### Using the wireless controls

The Network and Sharing Center allows you to set up a connection or network, connect to a network, manage wireless networks, and diagnose and repair network problems.

To use operating system controls:

1. On a tablet running Windows 10, type `control panel` in the taskbar search box, and then select **Control Panel**.

– or –

On a tablet running Windows 8, swipe from the right edge of the touch screen to display the charms, tap **Settings**, and then tap **Control Panel**.

2. Select **Network and Internet**, and then tap **Network and Sharing Center**.

For more information, access HP Support Assistant. To access HP Support Assistant, see [Finding information on page 2](#).

### Using a WLAN

With a WLAN device, you can access a wireless local area network (WLAN), which is composed of other computers and accessories that are linked by a wireless router or a wireless access point.



**NOTE:** The terms *wireless router* and *wireless access point* are often used interchangeably.

- A large-scale WLAN, such as a corporate or public WLAN, typically uses wireless access points that can accommodate a large number of computers and accessories and can separate critical network functions.
- A home or small office WLAN typically uses a wireless router, which allows several wireless and wired computers to share an Internet connection, a printer, and files without requiring additional pieces of hardware or software.

To use the WLAN device in your tablet, you must connect to a WLAN infrastructure (provided through a service provider or a public or corporate network).

## Using an Internet service provider

When you are setting up Internet access in your home, you must establish an account with an Internet service provider (ISP). To purchase Internet service and a modem, contact a local ISP. The ISP will help set up the modem, install a network cable to connect your wireless tablet to the modem, and test the Internet service.

 **NOTE:** Your ISP will give you a user ID and a password to use for Internet access. Record this information and store it in a safe place.

## Setting up a WLAN

To set up a WLAN and connect to the Internet, you need the following equipment:

- A broadband modem (either DSL or cable) **(1)** and high-speed Internet service purchased from an Internet service provider
- A wireless router **(2)** (purchased separately)
- A wireless tablet **(3)**

 **NOTE:** Some modems have a built-in wireless router. Check with your ISP to determine what type of modem you have.

The illustration below shows an example of a wireless network installation that is connected to the Internet.

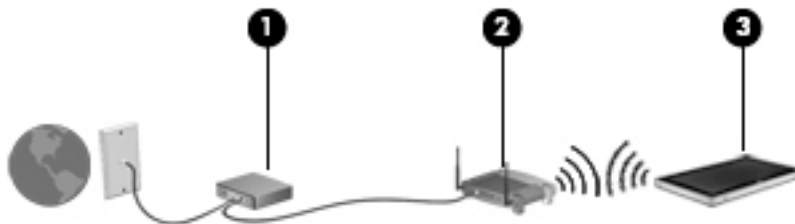

As your network grows, additional wireless and wired computers can be connected to the network to access the Internet.

For help in setting up your WLAN, see the information provided by your router manufacturer or your ISP.

## Configuring a wireless router

For help in setting up a WLAN, see the information provided by your router manufacturer or your ISP.

 **NOTE:** It is recommended that you initially connect your new wireless tablet to the router by using the network cable provided with the router. When the tablet successfully connects to the Internet, disconnect the cable, and access the Internet through your wireless network.

## Protecting your WLAN

When you set up a WLAN or access an existing WLAN, always enable security features to protect your network from unauthorized access. WLANs in public areas (hotspots) like coffee shops and airports may not provide

any security. If you are concerned about the security of your tablet in a hotspot, limit your network activities to email that is not confidential and basic Internet surfing.

Wireless radio signals travel outside the network, so other WLAN devices can pick up unprotected signals. Take the following precautions to protect your WLAN:

- Use a firewall.

A firewall checks both data and requests for data that are sent to your network, and discards any suspicious items. Firewalls are available in both software and hardware. Some networks use a combination of both types.

- Use wireless encryption.

Wireless encryption uses security settings to encrypt and decrypt data that is transmitted over the network. For more information, access HP Support Assistant. To access HP Support Assistant, see [Finding information on page 2](#).

## Connecting to a WLAN

To connect to the WLAN, follow these steps:

1. Be sure that the WLAN device is on.
2. On the Windows desktop, tap the network status icon in the notification area, at the far right of the taskbar.
3. Be sure that airplane mode is off, select a WLAN from the list, and then tap **Connect**.

If the WLAN is a security-enabled WLAN, you are prompted to enter a security code. Type the code, and then tap **Next** on a tablet running Windows 10 or **Sign in** on a tablet running Windows 8.

---

 **NOTE:** If no WLANs are listed, you may be out of range of a wireless router or access point.

 **NOTE:** If you do not see the WLAN you want to connect to, tap and hold the network status icon in the taskbar, and then select **Open Network and Sharing Center**. Tap **Set up a new connection or network**. A list of options is displayed, allowing you to manually search for and connect to a network or to create a new network connection.

---

4. Follow the on-screen instructions to complete the connection.

After the connection is made, tap the network status icon in the notification area, at the far right of the taskbar, to verify the name and status of the connection.

---

 **NOTE:** The functional range (how far your wireless signals travel) depends on WLAN implementation, router manufacturer, and interference from other electronic devices or structural barriers such as walls and floors.

---

## Using Bluetooth wireless devices

A Bluetooth device provides short-range wireless communications that replace the physical cable connections that traditionally link electronic devices such as the following:

- Computers (desktop, notebook, PDA)
- Phones (cellular, cordless, smart phone)
- Imaging devices (printer, camera)
- Audio devices (headset, speakers)
- Mouse



Bluetooth devices provide peer-to-peer capability that allows you to set up a personal area network (PAN) of Bluetooth devices. For information about configuring and using Bluetooth devices, see the Bluetooth software Help.

## Using HP Mobile Broadband (select models only)

HP Mobile Broadband enables your tablet to use WWANs to access the Internet from more places and over larger areas than it can by using WLANs. Using HP Mobile Broadband requires a network service provider (called a *mobile network operator*), which in most cases is a cellular phone network operator. Coverage for HP Mobile Broadband is similar to cellular phone voice coverage.

If your tablet has HP Mobile Broadband, it is also equipped with Global Positioning System (GPS) functionality. GPS satellites deliver location, speed, and direction information to GPS-equipped systems.

When used with mobile network operator service, HP Mobile Broadband gives you the freedom to stay connected to the Internet, send email, or connect to your corporate network whether you are on the road or outside the range of Wi-Fi hotspots.

You may need the HP Mobile Broadband Module serial number to activate mobile broadband service.

Some mobile network operators require the use of a SIM. A SIM contains basic information about you, such as a personal identification number (PIN), as well as network information. Some tablets include a SIM that is preinstalled. If the SIM is not preinstalled, it may be provided in the HP Mobile Broadband information provided with your tablet, or the mobile network operator may provide it separately from the tablet.

For information about inserting and removing the SIM, contact HP Custom Integration Services (CIS), an authorized HP service provider, or participants in the HP Self-Maintainer program.

For information about HP Mobile Broadband and how to activate service with a preferred mobile network operator, see the HP Mobile Broadband information included with your tablet.

---

## 4 Navigating using touch gestures

Your tablet allows navigation using touch gestures on the touch screen.

### Using touch screen gestures

You can control items on the touch screen directly with your fingers.

#### One-finger slide

The one-finger slide is mostly used to pan or scroll through lists and pages, but you can use it for other interactions, too, such as moving an object.

- To scroll across the screen, lightly slide one finger across the screen in the direction you want to move.

---

 **NOTE:** When many apps are displayed on the Start screen, you can slide your finger to move the screen left or right.

---

- To drag, press and hold an object, and then drag the object to move it.

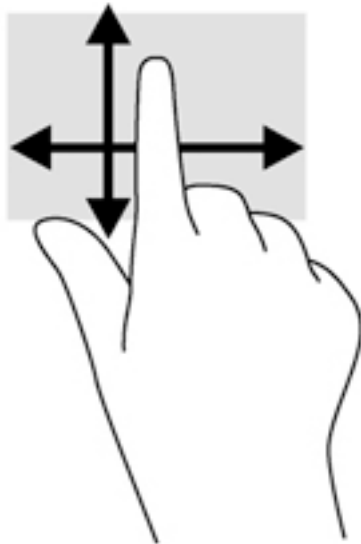

## Tapping

To make an on-screen selection, use the tap function.

- Use one finger to tap an object on the screen to make a selection. Double-tap an item to open it.

 **NOTE:** Press and hold your finger on an object to open a help screen that provides information about the object.

---



## Scrolling

Scrolling is useful for moving the pointer up, down, left, or right on a page or image.

- Place two fingers on the screen and then drag them in an up, down, left, or right motion.

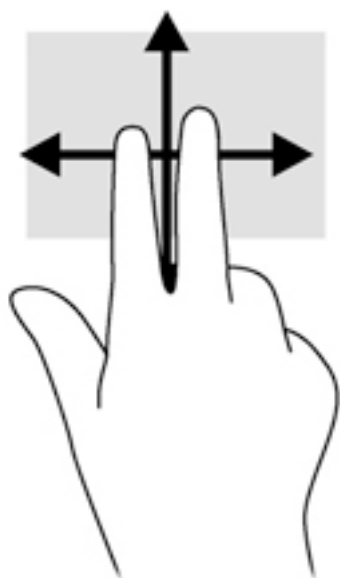

## 2-finger pinch zoom

2-finger pinch zoom allows you to zoom out or in on images or text.

- Zoom in by placing two fingers together on the screen and then moving your fingers apart.
- Zoom out by placing two fingers apart on the screen and then moving your fingers together.

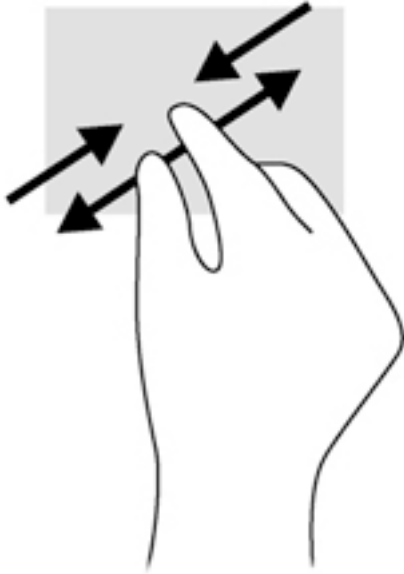

## Edge swipes (Windows 8 only)

Edge swipes allow you to access toolbars on your tablet for tasks such as changing settings and finding or using apps.

### Right-edge swipe

The right-edge swipe reveals the charms, which let you search, share, start apps, access devices, or change settings.

- Swipe your finger gently from the right edge to reveal the charms.

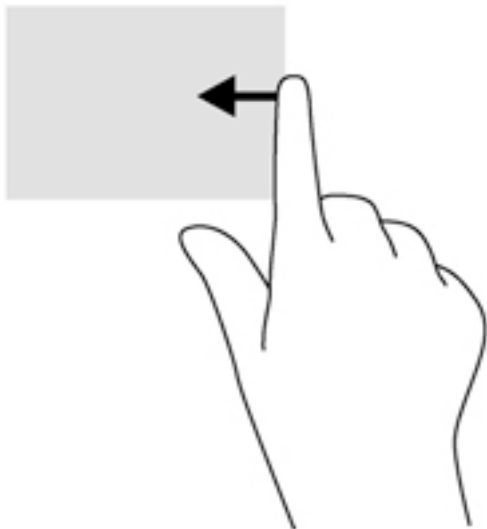

## Left-edge swipe

The left-edge swipe reveals your open apps so that you can switch between them quickly.

- Swipe your finger gently from the left edge to switch between apps. Without lifting your finger, swipe back toward the left edge to display all open apps.

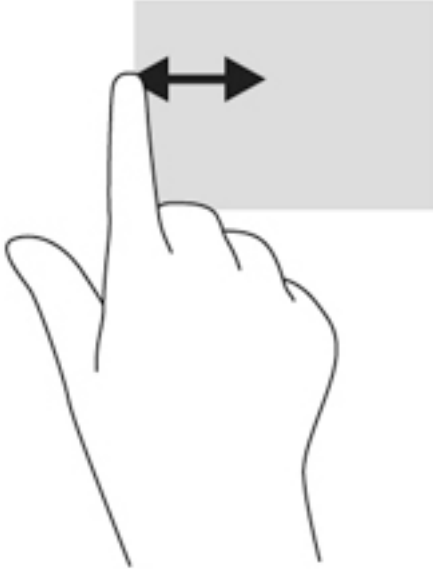

## Top-edge swipe

The top-edge swipe displays app command options that allow you to customize apps.

- Gently swipe finger from the top edge to reveal the app command options.

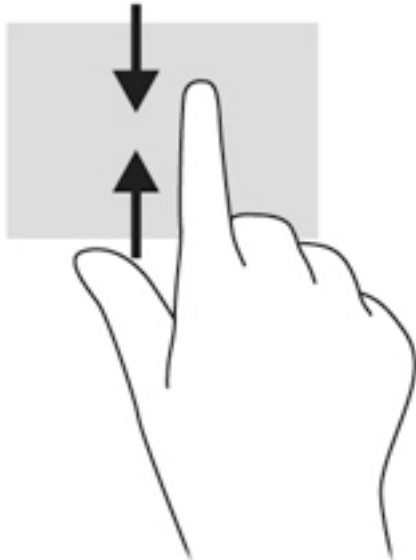

## Using the on-screen keyboard

The tablet has an on-screen keyboard that is displayed when you are in tablet mode.

1. To display this keyboard on a tablet running Windows 10, tap the keyboard icon on the right side of the notification area.

– or –

To display this keyboard on a tablet running Windows 8, on the Start screen, tap a text box. The keyboard is displayed.

2. Begin typing.

To access settings for the on-screen keyboard:

### Windows 10

- ▲ Type `control panel` in the taskbar search box, select **Control Panel**, select **Devices and Printers**, and then select **Typing**.

### Windows 8

1. Swipe from the right side of the touch screen to display the charms, and then tap **Settings**.
2. Tap **Change PC settings**, tap **PC and devices**, tap **Typing**, and then follow the on-screen instructions.

---

## 5 Detailed functions

Your tablet includes the following:

- Integrated speakers
- Integrated webcam
- Bar-code scanner (select models only)
- Multimedia buttons or keys

### Audio

On your tablet, you can download and listen to music, stream audio content from the web (including radio), record audio, or mix audio and video to create multimedia. To enhance your listening enjoyment, attach external audio devices such as speakers or headphones.

#### Connecting speakers

You can attach wired speakers to your tablet by connecting them to a USB port or to the audio-out (headphone)/audio-in (microphone) combo jack on your tablet or on a docking station.

To connect wireless speakers to your tablet, follow the device manufacturer's instructions. To connect high-definition speakers to the assembly, see [Configuring audio for HDMI on page 24](#). Before connecting audio devices, be sure to adjust the volume.

#### Adjusting the volume

You can adjust the volume using the volume buttons on the back of the tablet.

---

 **WARNING!** To reduce the risk of personal injury, adjust the volume before putting on headphones, earbuds, or a headset. For additional safety information, see the *Regulatory, Safety and Environmental Notices*.

To access this guide:

##### Windows 10

Select the **Start** button, select **All apps**, select **HP Help and Support**, and then select **HP Documentation**.

##### Windows 8

Select the **HP Support Assistant** app on the Start screen, select **My computer**, and then select **User guides**.

 **NOTE:** Volume can also be controlled through the operating system and some programs.

---

## Connecting headphones and microphones

You can connect wired headphones or headsets to the audio-out (headphone)/audio-in (microphone) combo jack on your tablet. Many headsets with integrated microphones are commercially available.

To connect *wireless* headphones or headsets to your tablet, follow the device manufacturer's instructions.

 **WARNING!** To reduce the risk of personal injury, lower the volume setting before putting on headphones, earbuds, or a headset. For additional safety information, see the *Regulatory, Safety and Environmental Notices*.

To access this guide:

### Windows 10

Select the **Start** button, select **All apps**, select **HP Help and Support**, and then select **HP Documentation**.

### Windows 8

Select the **HP Support Assistant** app on the Start screen, select **My computer**, and then select **User guides**.

 **NOTE:** If the audio functions are not working correctly, see your tablet user guide for troubleshooting suggestions.

## Checking audio functions on the tablet

 **NOTE:** For best results when recording, speak directly into the microphone and record sound in a setting free of background noise.

To check the audio functions on your tablet, follow these steps:

1. On a tablet running Windows 10, type `control panel` in the taskbar search box, and then select **Control Panel**.

– or –

On a tablet running Windows 8, swipe from the right edge of the touch screen to display the charms, tap **Search**, and then tap the search box. In the search box, type `c`, and then tap **Control Panel**.

2. Tap **Hardware and Sound**, and then tap **Sound**.

When the Sound window opens, tap the **Sounds** tab. Under **Program Events**, tap any sound event, such as a beep or alarm and then tap **Test**. You should hear sound through the speakers or through connected headphones.

To check the recording functions on your tablet, follow these steps:

1. If you are using a tablet running Windows 10, go to step 2. On a tablet running Windows 8, swipe from the right edge of the touch screen to display the charms, tap **Search**, and then tap the search box.
2. In the search box, type `sound`, and then tap **Sound Recorder**.
3. Tap **Start Recording** and speak into the microphone.
4. Save the file to your desktop.
5. Open a multimedia program and play back the recording.



To confirm or change the audio settings on your tablet:

1. If you are using a tablet running Windows 10, go to step 2. On a tablet running Windows 8, swipe from the right edge of the touch screen to display the charms, tap **Search**, and then tap the search box.
2. In the search box, type `control panel`, and then tap **Control Panel**.
3. Tap **Hardware and Sound**, and then tap **Sound**.

## Webcams

Your tablet includes two integrated webcams. With the preinstalled software, you can use the webcams to take a photo or record a video. You can preview and save the photo or video recording.

The webcam software enables you to experiment with the following features:

- Capturing and sharing video
- Streaming video with instant message software
- Taking still photos

For best results, use both hands to steady the tablet.

For details about using the webcam, see the webcam software Help.

## Video

Your HP tablet is a powerful video device that enables you to watch streaming video from your favorite websites and download video and movies to watch on your tablet without needing to connect to a network.

To enhance your viewing enjoyment, use the video port on the tablet to connect an external monitor, projector, or TV. The high-definition multimedia interface (HDMI) port allows you to connect a high-definition monitor or TV.

---

 **IMPORTANT:** Be sure that the external device is connected to the correct port on the tablet, using the correct cable. Check the device manufacturer's instructions if you have questions.

 **NOTE:** See [Getting to know your tablet on page 4](#) for information about your tablet's video ports.

---

## HDMI

The HDMI port connects the tablet to an optional video or audio device, such as a high-definition display, or to any compatible digital or audio component.

 **NOTE:** To transmit video and/or audio signals through the HDMI port, you need an HDMI cable (purchased separately).

One HDMI device can be connected to the HDMI port on the tablet. The information displayed on the tablet screen can be simultaneously displayed on the HDMI device.

To connect a video or audio device to the HDMI port:

1. After opening the I/O door at the bottom of the tablet, connect one end of the HDMI cable to the HDMI port on the tablet.

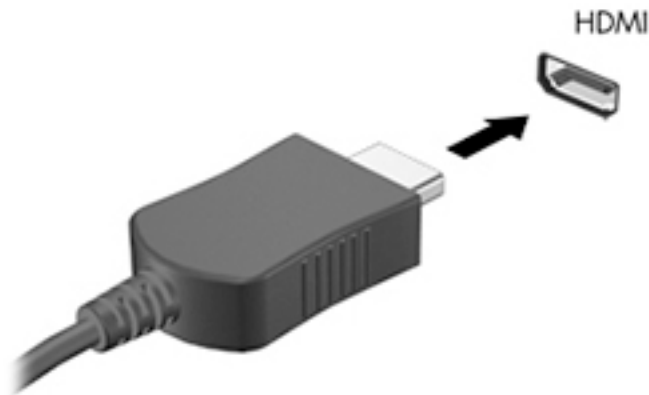

2. Connect the other end of the cable to the video device.
3. You can alternate the tablet screen image between 4 display states:
  - **PC screen only:** View the screen image on the tablet only.
  - **Duplicate:** View the screen image simultaneously on both the tablet and external device.
  - **Extend:** View the screen image extended across both the tablet and external device.
  - **Second screen only:** View the screen image on the external device only.

 **NOTE:** For best results, especially if you choose the “Extend” option, adjust the screen resolution of the external device, as follows. From the Start screen, type `control panel`, and then select **Control Panel** from the list of applications. Select **Appearance and Personalization**. Under **Display**, select **Adjust resolution** on tablets running Windows 10 or **Adjust screen resolution** on tablets running Windows 8.

## Configuring audio for HDMI

To configure HDMI audio, first connect an audio or video device, such as a high-definition TV, to the HDMI port on your tablet. Then configure the default audio playback device as follows:

1. From the Windows desktop, tap and hold the **Speakers** icon in the notification area, at the far right of the taskbar, and then select **Playback devices**.
2. On the Playback tab, select either **Digital Output** or **Digital Output Device (HDMI)**.
3. Select **Set Default**, and then select **OK**.

To return audio to the tablet speakers, follow these steps:

1. From the Windows desktop, tap and hold the **Speakers** icon in the notification area, at the far right of the taskbar, and then select **Playback devices**.
2. On the Playback tab, select **Speakers**.
3. Select **Set Default**, and then select **OK**.

## Bar-code scanner (select models only)

To use the bar-code scanner:

1. Open a bar-code reading utility (sold separately) that you have installed on the tablet.
2. Press and hold one of the bar-code scanner buttons, and aim the scanner beam at the bar code.
3. The cross is the center of the field of view and the red dots are the border. Make sure that the scanner beam covers the entire bar code.

---

 **TIP:** For best results, steady the tablet using both hands, with the scanner lens 152.4 or 177.8 millimeters (6 or 7 inches) from the bar code.

---



---

 **WARNING!** Do not look at the scanner beam with a magnifying device positioned closer than 100 mm (3.9 in). Doing so can cause an eye injury.

---

4. A green dot appears after a successful scan.

---

 **NOTE:** For more information about programming the bar-code scanner, go to <http://www.datalogic.com/>.

---

## Configuring carriage returns

To configure the bar-code scanner to insert a carriage return after each scanned bar code:

1. Open programming mode by scanning the following QR code.



2. Scan the following QR code.



3. Exit programming mode by scanning the following QR code.



The bar-code scanner inserts a carriage return after each scanned bar code until you either repeat the previous procedure or restore the default settings (see [Restoring default settings on page 27](#)).

## Configuring the bar-code scanner volume

The tablet is shipped with the tone and volume of the bar-code scanner turned off.

To turn on the tone and adjust the volume:

1. Open programming mode by scanning the following QR code.



2. Scan one of the following QR codes:

- To set the volume to low:



- To set the volume to medium:



- To set the volume to high:



- To turn the volume off:



3. Exit programming mode by scanning the following QR code.

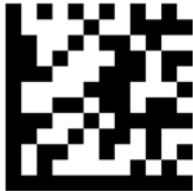

## Restoring default settings

To restore the bar-code scanner to its original settings:

1. Open programming mode by scanning the following QR code.



2. Scan the following QR code.



3. Exit programming mode by scanning the following QR code.



## Near Field Communications (NFC)

You can touch an NFC-compatible device to the center front NFC area on the tablet to wirelessly connect and communicate with the tablet and transfer data back and forth. NFC can also be used for security purposes. See [Front on page 4](#) to locate the NFC tapping area.

---

# 6 Power management

---

 **NOTE:** Your tablet has a power button.

---

## Shutting down the tablet

---

 **CAUTION:** Unsaved information is lost when the tablet shuts down.

---

The shutdown command closes all open programs, including the operating system, and then turns off the tablet.

Shut down the tablet when the tablet will be unused and disconnected from external power for an extended period

Although you can turn off the tablet with the power button, the recommended procedure is to use the Windows shutdown command:

---

 **NOTE:** If the tablet is in the Sleep state, you must first exit Sleep before shutdown is possible by briefly pressing the power button.

---

1. Save your work and close all open programs.
2. On a tablet running Windows 10, select the **Start** button, select the **Power** icon, and then select **Shut down**.

– or –

On a tablet running Windows 8, swipe from the right edge of the touch screen to display the charms, tap **Settings**, tap the **Power** icon, and then tap **Shut down**.

If the tablet is unresponsive and you are unable to use the preceding shutdown procedure, try the following emergency procedures in the sequence provided:

- Press and hold the power button for at least 5 seconds.
- Disconnect the tablet from external power.

## Setting power options

### Using power-saving states

Sleep is enabled at the factory.

When Sleep is initiated, the screen clears, and your work is saved to memory.

---

 **CAUTION:** To reduce the risk of possible audio and video degradation, loss of audio or video playback functionality, or loss of information, do not initiate Sleep while reading from or writing to a disc or an external media card.

---

### Initiating and exiting Sleep

With the tablet on, you can initiate Sleep in any of the following ways:



- Briefly press the power button.
- On a tablet running Windows 10, select the **Start** button, select the **Power** icon, and then select **Sleep**.

– or –

On a tablet running Windows 8, swipe from the right edge of the touch screen to display the charms, tap **Settings**, tap the **Power** icon, and then tap **Sleep**.

To exit Sleep, briefly press the power button.

When the tablet exits Sleep, the tablet returns to the screen where you stopped working.

---

 **NOTE:** If you have set a password to be required on wakeup, you must enter your Windows password before the tablet will return to the screen.

---

## Using the power meter and power settings

The power meter is located on the Windows desktop. The power meter allows you to quickly access power settings and view the remaining battery charge.

- To display the percentage of remaining battery charge and the current power plan, on the Windows desktop, tap the power meter icon.
- To use Power Options, tap and hold the power meter icon, and then select **Power Options**.

Different power meter icons indicate whether the tablet is running on battery or external power. The icon also displays a message if the battery has reached a low or critical battery level.

## Setting password protection on wakeup

To set the tablet to prompt for a password when the tablet exits Sleep, follow these steps:

1. Tap and hold the power meter icon, and then tap **Power Options**.
2. In the left pane, tap **Require a password on wakeup**.
3. Tap **Change Settings that are currently unavailable**.
4. Tap **Require a password (recommended)**.

---

 **NOTE:** If you need to create a user account password or change your current user account password, tap **Create or change your user account password**, and then follow the on-screen instructions. If you do not need to create or change a user account password, go to step 5.

---

5. Tap **Save changes**.

## Using battery power

The tablet runs on battery power whenever it is not plugged into external AC power. Tablet battery life varies, depending on power management settings, running programs, display brightness, external devices connected to the tablet, and other factors. When the tablet is plugged into AC power, the batteries are charged and your work is protected in case of a power outage. If the batteries are charged and the tablet is running on external AC power, the tablet automatically switches to battery power if the AC adapter is disconnected on the tablet or an AC power loss occurs.

---

 **NOTE:** When you disconnect AC power, the display brightness is automatically decreased to save battery life. For more information, see [Using external AC power on page 33](#).

---

## Factory-sealed batteries

To monitor the status of your battery, or if the battery is no longer holding a charge, run Battery Check in HP Support Assistant. To access HP Support Assistant, see [Finding information on page 2](#). In HP Support Assistant, tap **My PC**, select the **Diagnostics and Tools** tab, and then select **HP Battery Check**. If Battery Check indicates that your battery should be replaced, contact support.

The battery(ies) in this product cannot be easily replaced by users themselves. Removing or replacing the battery(ies) could affect your warranty coverage. If a battery is no longer holding a charge, contact support.

When a battery has reached the end of its useful life, do not dispose of the battery in general household waste. Follow the local laws and regulations in your area for battery disposal.

## Finding additional battery information

HP Support Assistant provides the following tools and information about the batteries.

- Battery Check tool to test battery performance
- Information on calibration, power management, and proper care and storage to maximize battery life
- Information on battery types, specifications, life cycles, and capacity

To access battery information:

1. Open **HP Support Assistant**. See [Finding information on page 2](#).
2. Tap **My PC**, select the **Diagnostics and Tools** tab, and then select **HP Battery Check**.

## Using Battery Check

HP Support Assistant provides information on the status of the battery installed in the tablet.

To run Battery Check:

1. Connect the AC adapter to the tablet.



**NOTE:** The tablet must be connected to external power for Battery Check to work properly.

2. Open **HP Support Assistant**. See [Finding information on page 2](#).
3. Tap **My PC**, select the **Diagnostics and Tools** tab, and then select **HP Battery Check**.

Battery Check examines the battery and its cells to see if they are functioning properly, and then reports the results of the examination.

## Displaying the remaining battery charge

- ▲ Tap the power meter icon on the Windows desktop in the notification area, at the far right of the taskbar.

## Maximizing battery discharge time

Battery discharge time varies depending on features you use while on battery power. Maximum discharge time gradually decreases as the battery storage capacity naturally degrades.

To maximize battery discharge time, lower the brightness on the display.

## Managing low battery levels

The information in this section describes the alerts and system responses set at the factory. Some low-battery alerts and system responses can be changed using Power Options. Preferences set using Power Options do not affect lights.

1. If you are using a tablet running Windows 10, go to step 2. On a tablet running Windows 8, swipe from the right edge of the touch screen to display the charms, tap **Search**, and then tap the search box.
2. In the search box, type `power options`, and then tap **Power Options**.

### Identifying low battery levels

When a battery that is the sole power source for the tablet reaches a low or critical battery level, the following behavior occurs:

- On the Windows desktop, the power meter icon in the notification area shows a low or critical battery notification.



**NOTE:** For additional information about the power meter, see [Using the power meter and power settings on page 31](#).

- If the tablet is on or in the Sleep state, the tablet remains briefly in the Sleep state and then shuts down and loses any unsaved information.

### Resolving a low battery level

#### Resolving a low battery level when external power is available

- ▲ Connect one of the following devices:
  - AC adapter
  - Optional docking or expansion device
  - Optional power adapter purchased as an accessory from HP

#### Resolving a low battery level when no power source is available

To resolve a low battery level when no power source is available, save your work and shut down the tablet.

### Conserving battery power

- Tap and hold the power meter, and then tap **Power Options**. Select low-power-use settings.
- Turn off wireless and LAN connections when you are not using them.
- Disconnect unused external devices that are not plugged into an external power source.
- Stop, disable, or remove any external media cards that you are not using.
- Decrease screen brightness.
- Before you leave your work, initiate Sleep, or shut down the tablet.

### Using external AC power

**WARNING!** Do not charge the tablet battery while you are onboard aircraft.

**WARNING!** To reduce potential safety issues, use only the AC adapter provided with the tablet, a replacement AC adapter provided by HP, or a compatible AC adapter purchased from HP.

**NOTE:** For information on connecting to AC power, see the *Setup Instructions* poster provided in the tablet box.

External AC power is supplied through an approved AC adapter or an optional docking or expansion device.

Connect the tablet to external AC power under any of the following conditions:

- When charging a battery
- When installing or modifying system software
- When running Disk Defragmenter
- When performing a backup or recovery

When you connect the tablet to external AC power, the following events occur:

- The battery begins to charge.
- If the tablet is turned on, the power meter icon in the notification area changes appearance.

When you disconnect external AC power, the following events occur:

- The tablet switches to battery power.
- The display brightness is automatically decreased to save battery life.

---

# 7 External cards and devices

## Using smart cards

 **NOTE:** The term *smart card* is used throughout this chapter to mean both smart cards and Java™ Cards.

A smart card is a credit card-sized accessory that carries a microchip containing memory and a microprocessor. Like personal computers, smart cards have an operating system to manage input and output, and they include security features to protect against tampering. Industry-standard smart cards are used with the smart card reader.

A PIN is needed to gain access to the contents of the microchip. For more information about smart card security features, access HP Support Assistant. To access HP Support Assistant, see [Finding information on page 2](#).

### Inserting a smart card

1. Place the tablet face-down on a flat surface. Press down on the I/O door and rotate it to the right. Remove the door.
2. Hold the card label-side up, and gently slide the card into the smart card reader until the card is seated.
3. To close the I/O door, align the dot on the I/O door with the dot on the tablet, and then rotate the door to the left until it is securely fastened.
4. Follow the on-screen instructions for logging on to the tablet using the smart card PIN.

### Removing a smart card

1. Place the tablet face-down on a flat surface. Press down on the I/O door and rotate it to the right. Remove the door.
2. Grasp the edge of the smart card, and then pull it out of the smart card reader.
3. To close the I/O door, align the dot on the I/O door with the dot on the tablet, and then rotate the door to the left until it is securely fastened.

## Using a USB device

Universal Serial Bus (USB) is a hardware interface that can be used to connect an optional external device, such as a USB keyboard, mouse, drive, printer, scanner, or hub.

Some USB devices may require additional support software, which is usually included with the device. For more information about device-specific software, see the manufacturer's instructions. These instructions may be provided with the software, on disc, or on the manufacturer's website.

The tablet has two USB ports that support USB 1.0, 1.1, 2.0, or 3.0 devices. An optional docking device or USB hub provides additional USB ports that can be used with the tablet.

### Connecting a USB device

 **CAUTION:** To reduce the risk of damage to a USB connector, use minimal force to connect the device.

- ▲ After opening the I/O door at the bottom of the tablet, connect the USB cable for the device to the USB port.

---

 **NOTE:** The following illustration might look slightly different than your tablet.

---



You will hear a sound when the device has been detected.

---

 **NOTE:** The first time you connect a USB device, a message in the notification area lets you know that the device is recognized by the tablet.

---

## Removing a USB device

---

 **CAUTION:** To reduce the risk of damage to a USB connector, do not pull on the cable to remove the USB device.

**CAUTION:** To reduce the risk of loss of information or an unresponsive system, use the following procedure to safely remove the USB device.

1. To remove a USB device, save your information and close all programs associated with the device.
2. Select the remove hardware icon on the Windows desktop in the notification area, at the far right of the taskbar, and then follow the on-screen instructions.
3. Remove the device.

## Using a serial device

A DB9 serial port connects optional devices such as a serial modem, mouse, or printer.

Some serial devices may require additional support software, which is usually included with the device. For more information about device-specific software, see the manufacturer's instructions.

- ▲ To connect a serial device, open the I/O door at the bottom of the tablet and then connect the device cable to the serial port on the tablet.

---

 **NOTE:** The following illustration might look slightly different than your tablet.

---

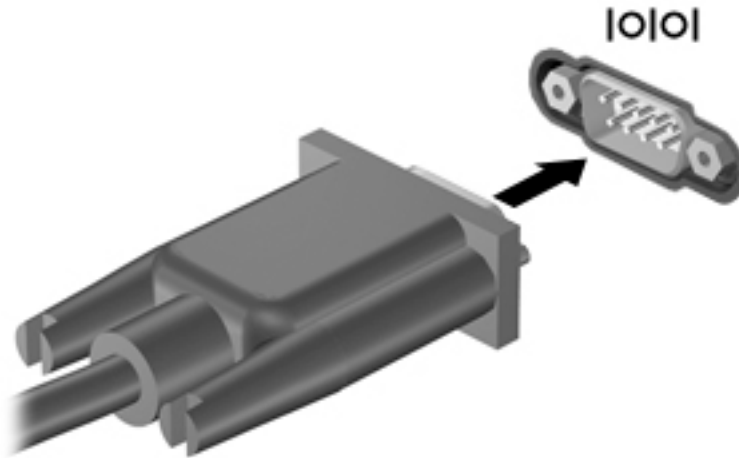

## Using optional external devices

---

 **NOTE:** For more information about required software and drivers, or to learn which port to use, see the manufacturer's instructions.

---

To connect an external device to the tablet:

 **CAUTION:** To reduce the risk of damage to the equipment when connecting a powered device, be sure that the device is turned off and the AC power cord is unplugged.

---

1. Connect the device to the tablet.
2. If you are connecting a powered device, plug the device power cord into a grounded AC outlet.
3. Turn on the device.

To disconnect an unpowered external device, turn off the device, and then disconnect it from the tablet. To disconnect a powered external device, turn off the device, disconnect it from the tablet, and then unplug the AC power cord.

## Using optional external drives

Removable external drives expand your options for storing and accessing information. You can add a USB drive by connecting the drive to a USB port on the tablet.

---

 **NOTE:** HP external USB optical drives should be connected only to powered USB ports; therefore, HP does not recommend connecting HP external USB optical drives to the tablet.

---

USB drives include the following types:

- 1.44-megabyte diskette drive
- Hard drive module
- External optical drive (CD, DVD, and Blu-ray)
- MultiBay device

## Installing an optional security cable

 **NOTE:** A security cable is designed to act as a deterrent, but it may not prevent the tablet from being mishandled or stolen.

 **NOTE:** The security cable slot on your tablet might look slightly different from the illustration in this section. See [Getting to know your tablet on page 4](#) for the location of the security cable slot on your tablet.

1. Lift the edge of the security cable slot dust cover that has a rectangular indentation.
2. Loop the security cable around a secured object.
3. Insert the key **(1)** into the cable lock **(2)**.
4. Insert the cable lock into the security cable slot on the tablet **(3)**, and then lock the cable lock with the key.

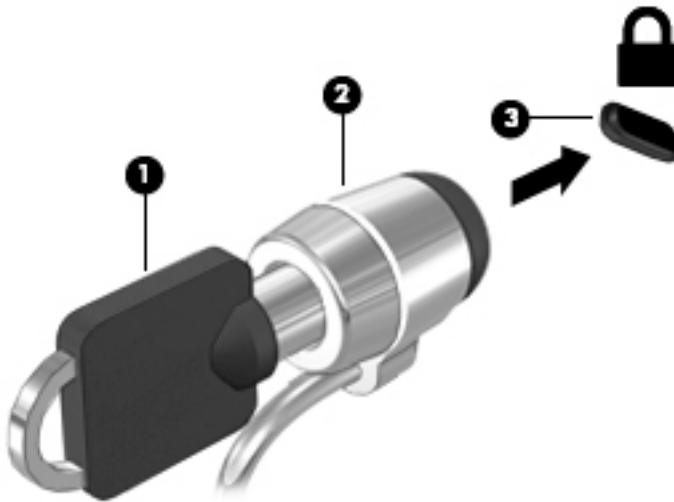





# 8 Security

## Protecting the tablet

Standard security features provided by the Windows operating system and Computer Setup can protect your personal settings and data from a variety of risks.

 **NOTE:** Security solutions are designed to act as deterrents. These deterrents may not prevent a product from being mishandled or stolen.

 **NOTE:** Before you send your tablet for service, back up and delete confidential files, and remove all password settings.

 **NOTE:** Some features listed in this chapter may not be available on your tablet.

 **NOTE:** Your tablet supports Absolute Data Protect. If your tablet is lost or stolen, it can be located and locked, and personal data can be deleted from a remote location. The tablet must be connected to the Internet.

Tablet risk	Security feature
Unauthorized use of the tablet	HP Client Security, in combination with a password or other authentication credential
Unauthorized access to Computer Setup (BIOS)	BIOS administrator password in Computer Setup*
Unauthorized startup from an optional external flash drive	Boot options feature in Computer Setup*
Unauthorized access to a Windows user account	Windows user password
Unauthorized access to data	<ul style="list-style-type: none"><li>• HP Drive Encryption software</li><li>• Windows Defender</li></ul>

\*Computer Setup is a preinstalled, ROM-based utility that can be used even when the operating system is not working or loading. You can use a pointing device (such as a USB mouse) or a keyboard to navigate and make selections in Computer Setup.

**NOTE:** On tablets without keyboards, you can use the touch screen.

## Using passwords

A password is a group of characters that you choose to secure your tablet information. Several types of passwords can be set, depending on how you want to control access to your information. Passwords can be set in Windows or in Computer Setup that is preinstalled on the tablet.

- Setup passwords are set in Computer Setup and are managed by the system BIOS.
- Windows passwords are set only in the Windows operating system.

Use the following tips for creating and saving passwords:

- When creating passwords, follow requirements set by the program.
- Do not use the same password for multiple applications or websites, and do not reuse your Windows password for any other application or website.

- Use HP Password Manager to store all of your user names and passwords for all of your websites and applications. You can securely read them in the future if they cannot be remembered.
- Do not store passwords in a file on the tablet.

The following tables list commonly used Windows and BIOS administrator passwords and describe their functions.

## Setting passwords in Windows

Password	Function
Administrator password*	Protects access to a Windows administrator-level account.  <b>NOTE:</b> Setting the Windows Administrator password does not set the BIOS Administrator password.
User password*	Protects access to a Windows user account.

\*For information about setting a Windows administrator password or a Windows user password, access HP Support Assistant. To access HP Support Assistant, see [Finding information on page 2](#).

## Setting passwords in Computer Setup

Password	Function
BIOS administrator password	Protects access to Computer Setup.

## Managing a BIOS administrator password

### Setting a new BIOS administrator password

1. Turn off the tablet. Press the power button in combination with the volume down button until the Startup menu is displayed, and then tap **F10** to enter Computer Setup.
2. Select **Security**, select **Create BIOS Administrator password** or **Set Up BIOS Administrator Password** (select products only), and then select **enter**.
3. When prompted, type a password.
4. When prompted, type the new password again to confirm.
5. To save your changes and exit Computer Setup, select the **Save** icon and then follow the on-screen instructions.

– or –

Select **Main**, select **Save Changes and Exit**, and then select **enter**.

Your changes take effect when the tablet restarts.

### Changing a BIOS administrator password

1. Turn off the tablet. Press the power button in combination with the volume down button until the Startup menu is displayed, and then tap **F10** to enter Computer Setup.
2. Select **Security**, select **Change BIOS Administrator password** or **Change password** (select products only), and then select **enter**.
3. When prompted, type your current password.

4. When prompted, type a new password.
5. When prompted, type the new password again to confirm.
6. To save your changes and exit Computer Setup, select the **Save** icon and then follow the on-screen instructions.

– or –

Select **Main**, select **Save Changes and Exit**, and then select **enter**.

Your changes take effect when the tablet restarts.

#### Deleting a BIOS administrator password

1. Turn off the tablet. Press the power button in combination with the volume down button until the Startup menu is displayed, and then tap **F10** to enter Computer Setup.
2. Select **Security**, select **Change BIOS Administrator password** or **Change password** (select products only), and then select **enter**.
3. When prompted, type your current password.
4. When prompted for the new password, leave the field empty, and then select **enter**.
5. When prompted to type your new password again, leave the field empty, and then select **enter**.
6. To save your changes and exit Computer Setup, select the **Save** icon and then follow the on-screen instructions.

– or –

Select **Main**, select **Save Changes and Exit**, and then select **enter**.

Your changes take effect when the tablet restarts.

### Entering a BIOS administrator password

At the **BIOS Administrator password** prompt, type your password (using the same kind of keys you used to set the password), and then select **enter**. After two unsuccessful attempts to enter the BIOS administrator password, you must restart the tablet and try again.

## Using antivirus software

When you use the tablet to access email, a network, or the Internet, you potentially expose it to computer viruses. Computer viruses can disable the operating system, programs, or utilities, or cause them to function abnormally.

Antivirus software can detect most viruses, destroy them, and, in most cases, repair any damage they have caused. To provide ongoing protection against newly discovered viruses, antivirus software must be kept up to date.

Windows Defender, which includes antivirus features, is preinstalled on your tablet. It is strongly recommended that you continue to use an antivirus program in order to fully protect your tablet.

For more information about viruses, access HP Support Assistant. To access HP Support Assistant, see [Finding information on page 2](#).

## Using firewall software

Firewalls are designed to prevent unauthorized access to a system or network. A firewall can be a software program you install on your tablet and/or network, or it can be a solution made up of both hardware and software.

There are two types of firewalls to consider:

- Host-based firewalls—Software that protects only the tablet it is installed on.
- Network-based firewalls—Installed between your DSL or cable modem and your home network to protect all devices on the network.

When a firewall is installed on a system, all data sent to and from the system is monitored and compared with a set of user-defined security criteria. Any data that does not meet those criteria is blocked.

Windows Defender is installed on your tablet.

---

 **NOTE:** Under some circumstances a firewall can block access to Internet games, interfere with printer or file sharing on a network, or block authorized email attachments. To permanently resolve the problem, reconfigure the firewall. To temporarily resolve the problem, disable the firewall, perform the task that you want to perform, and then reenable the firewall.

---

## Installing critical security updates

---

 **CAUTION:** Microsoft sends out alerts regarding critical updates. To protect the tablet from security breaches and computer viruses, install all critical updates from Microsoft as soon as you receive an alert.

---

You can choose whether updates are installed automatically.

To change the settings:

### Windows 10

1. Select the **Start** button, select **Settings**, and then select **Update & security**.
2. Select **Windows Update**, and then follow the on-screen instructions.
3. To schedule a time for installing updates, select **Advanced options**, and then follow the on-screen instructions.

### Windows 8

1. On the Start screen, swipe from the right side of the screen, tap **Settings**, and then tap **Control Panel**.
2. Tap **System and Security**, tap **Windows Update**, tap **Change settings**, and then follow the on-screen instructions.

## Using HP Client Security

HP Client Security software is preinstalled on your tablet. This software can be accessed through the HP Client Security tile on the Start screen; the icon on the Windows desktop in the notification area, at the far right of the taskbar; or Windows Control Panel. It provides security features that help protect against unauthorized access to the tablet, networks, and critical data. For more information, see the HP Client Security software Help.

# 9 Maintenance

## IP-65 rating

This tablet is rated IP-65, which means that it is protected against dust and jetting water.

To maintain the IP-65 rating, close the audio-in (headphone)/audio-out (microphone) jack and all I/O doors.

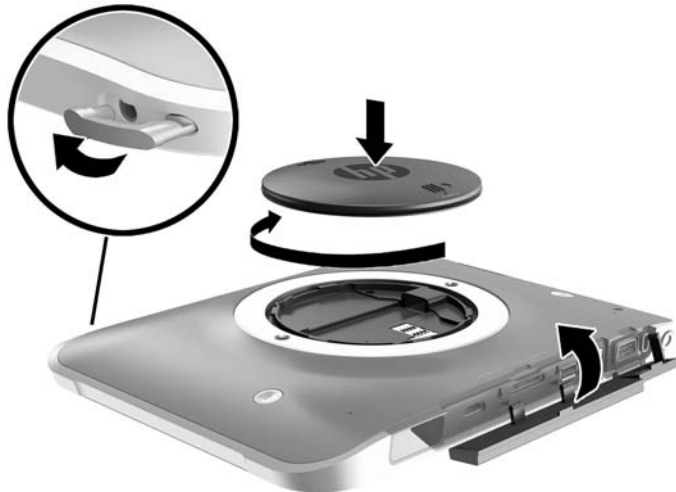

## Cleaning your tablet

Your tablet is treated with Sureshield, an antimicrobial agent which helps protect the tablet. The hand strap, quick release pins, camera lens, camera flash cover, bar-code scanner cover, screws, screen, and HP logo are not treated with Sureshield.

To preserve the antimicrobial coating, store your tablet in a cool, dry place and do not freeze it. Avoid heat, sparks, open flame, strong acids, ammonia, oxidizing agents, carbon monoxide, and carbon dioxide.

Use one of the following chemical mixtures to safely clean your tablet:

- Benzyl-C12-18-alkyldimethyl ammonium chlorides <1% with quaternary ammonium compounds, C12-14-alkyl[(ethylphenyl)methyl]dimethyl, chlorides <1%
- Isopropanol 10%–20%, 2-Butoxyethanol 1%–4%, benzyl-C12-18-alkyldimethyl ammonium chlorides <0.125%, and quaternary ammonium compounds, C12-18-alkyl [(ethylphenyl) methyl] dimethyl, chlorides <0.125%
- Isopropanol 30%–60%, benzyl-C12-18-alkyldimethyl ammonium chlorides 0.1%–1%, and quaternary ammonium compounds, C12-18-alkyl [(ethylphenyl) methyl] dimethyl 0.1%–1%
- Isopropyl alcohol wipes (Isopropyl alcohol 70%)
- Isopropanol 10%–20% and ethylene glycol monobutyl ether 1%–5%
- n-Alkyl dimethyl benzyl ammonium chloride 0.2%–0.4% with lauramine oxide 0.5%–1.5%
- Ethylene glycol n-hexyl ether 0.1%–1.0%, isopropanol 1%–5%, and water 90%–95%

- Sodium hypochlorite 1%–5% with sodium hydroxide 0.5%–2%
- Gentle dish soap and water
- Dry microfiber cleaning cloth or a chamois (static-free cloth without oil)
- Static-free cloth wipes

---

**⚠ CAUTION:** The common hospital cleaning agents listed previously were successfully tested with this product. Cleaning solvents other than those on this list may damage your tablet.

Fibrous materials, such as paper towels, can scratch the tablet. Over time, dirt particles and cleaning agents can get trapped in the scratches.

---

## Cleaning procedures

Follow the procedures in this section to safely clean your tablet.

---

**⚠ WARNING!** To prevent electric shock or damage to components, do not attempt to clean your tablet while it is on.

Turn off the tablet.

Disconnect AC power.

Disconnect all powered external devices.

**⚠ CAUTION:** To prevent damage to internal components, do not spray cleaning agents or liquids directly on any tablet port surface. Liquids dripped on the surface can permanently damage internal components. Close all ports and I/O doors.

---

## Cleaning the display

Gently wipe the display using a soft, lint-free cloth moistened with an *alcohol-free* glass cleaner. Be sure that the display is dry before storing the tablet.

## Cleaning the tablet

To clean the tablet, use a soft microfiber cloth or chamois moistened with one of the cleaning solutions listed previously or use an acceptable disposable wipe.

---

**📝 NOTE:** When cleaning the tablet, use a circular motion to aid in removing dirt and debris.

---

## Updating programs and drivers

HP recommends that you update your programs and drivers on a regular basis with the latest versions. Go to <http://www.hp.com/support> to download the latest versions. You can also register to receive automatic update notifications when they become available.

## Using SoftPaq Download Manager

HP SoftPaq Download Manager (SDM) is a tool that provides quick access to SoftPaq information for HP business tablets without requiring the SoftPaq number. Using this tool, you can easily search for SoftPaqs, and then download and unpack them.

SoftPaq Download Manager works by reading and downloading, from the HP FTP site, a published database file containing tablet model and SoftPaq information. SoftPaq Download Manager allows you to specify one or more tablet models to determine which SoftPaqs are available for download.

SoftPaq Download Manager checks the HP FTP site for updates to the database and software. If updates are found, they are downloaded and applied automatically.

SoftPaq Download Manager is available on the HP website. To use SoftPaq Download Manager to download SoftPaqs, you must first download and install the program. Go to the HP website at <http://www.hp.com/go/sdm>, and then follow the instructions to download and install SoftPaq Download Manager.

To download SoftPaqs:

1. If you are using a tablet running Windows 10, go to step 2. On tablets running Windows 8, swipe from the right edge of the touch screen to display the charms, tap **Search**, and then tap the search box.
2. In the search box, type `softpaq`, and then tap HP SoftPaq Download Manager. Follow the instructions to download SoftPaqs.



**NOTE:** If prompted by User Account Control, tap **Yes**.

---

---

# 10 Backup and recovery (Windows 8)

To protect your information, use Windows backup and restore utilities to back up individual files and folders, back up your entire hard drive, create system repair media (select models only) by using an optional external flash drive, or an optional external optical drive, or create system restore points. In case of system failure, you can use the backup files to restore the contents of your tablet.

1. Swipe from the right edge of the touch screen to display the charms, tap **Search**, and then tap the search box.
2. In the search box, type `restore`, and then select from the list of displayed options.

---

 **NOTE:** For detailed instructions on various backup and restore options, perform a search for these topics in Windows Help and Support.

In case of system instability, HP recommends that you print the recovery procedures and save them for later use.

 **NOTE:** Windows includes the User Account Control feature to improve the security of your tablet. You may be prompted for your permission or password for tasks such as installing software, running utilities, or changing Windows settings. For more information, see Windows Help and Support.

---

## Backing up your information

Recovery after a system failure is as good as your most recent backup. You should create system repair media and your initial backup immediately after initial system setup. As you add new software and data files, you should continue to back up your system on a regular basis to maintain a reasonably current backup.

For more information on the Windows backup features, see Windows Help and Support.

## Performing a system recovery

In case of system failure or instability, the tablet provides the following tools to recover your files:

- Windows recovery tools: You can use Windows Backup and Restore to recover information you have previously backed up. You can also use Windows Automatic Repair to fix problems that might prevent Windows from starting correctly.
- **f11** recovery tools: You can use the **f11** recovery tools to recover your original hard drive image. The image includes the Windows operating system and software programs installed at the factory.

---

 **NOTE:** If you are unable to boot (start up) your tablet and you cannot use the system repair media you previously created (select models only), contact support.

---

## Using the Windows recovery tools

To recover information you previously backed up, see Windows Help and Support for steps on restoring files and folders.

To recover your information using Automatic Repair, follow these steps:



---

 **CAUTION:** Some Startup Repair options will completely erase and reformat the hard drive. All files you have created and any software installed on the tablet are permanently removed. When reformatting is complete, the recovery process restores the operating system, as well as the drivers, software, and utilities from the backup used for recovery.

 **NOTE:** An external keyboard, mouse, and external flash drive may be required to perform this procedure.

---

1. If possible, back up all personal files.
2. If possible, check for the presence of the Recovery Image partition and the Windows partition. Swipe from the right edge of the touch screen, tap **Search**, and then tap the search box. Type `file`, and then tap **File Explorer**.
3. If the Windows partition and the Recovery Image partition are listed, shut down the tablet.
4. To power on the tablet, press the **Power** button and **Volume down** button simultaneously.  
The Startup menu is displayed.
5. Select **Troubleshoot**, select **Advanced Options**, and then select **Startup Repair**.
6. Follow the on-screen instructions.

 **NOTE:** For additional information on recovering information using the Windows tools, perform a search for these topics in Windows Help and Support.

---

## Using f11 recovery tools

 **CAUTION:** Using **f11** completely erases hard drive contents and reformats the hard drive. All files that you have created and any software that you have installed on the tablet are permanently removed. The **f11** recovery tool reinstalls the operating system, drivers, Windows updates, and language packs that were installed at the factory. All other software applications must be downloaded from HP.com or the Windows Store.

 **NOTE:** An external keyboard, mouse, and external flash drive may be required to perform this procedure.

---

To recover the original hard drive image using **f11**:

1. If possible, back up all personal files.
2. If possible, check for the presence of the HP Recovery partition: Swipe from the right edge of the touch screen, tap **Search**, and then tap the search box. Type `pc`, and then tap **This PC**.
3. If the HP Recovery partition is listed, shut down the tablet.
4. To power on the tablet, press the **Power** button and **Volume down** button simultaneously.  
The Startup menu is displayed.
5. Tap **F11 HP Recovery**, and then follow the on-screen instructions.

## Changing the boot device order

To change the boot order so that you can boot from an external device:

 **NOTE:** An external flash drive is required to perform this procedure.

---

1. If possible, back up all personal files.
2. Shut down the tablet.
3. Connect the external flash drive.

4. To power on the tablet, press the **Power** button and **Volume down** button simultaneously.  
The Startup menu is displayed.
5. Tap **F9 Boot Options**.
6. Select the external flash drive as the boot device.
7. Restart the tablet.

## Using Windows Refresh or Windows Reset

When your tablet is not working properly and you need to regain system stability, the Windows Refresh option allows you to start fresh and keep what is important to you.

The Windows Reset option allows you to perform detailed reformatting of your tablet, or remove personal information before you give away or recycle your tablet. For more information on these features, see Windows Help and Support.

---

# 11 Backup and recovery (Windows 10)

This chapter provides information about the following processes. The information in the chapter is standard procedure for most products.

- Creating recovery media and backups
- Restoring and recovering your system

For additional information, refer to the HP support assistant app.

- ▲ Type `support` in the taskbar search box, and then select the **HP Support Assistant** app.

– or –

Select the question mark icon in the taskbar.

---

 **IMPORTANT:** If you will be performing recovery procedures on a tablet, the tablet battery must be at least 70% charged before you start the recovery process.

**IMPORTANT:** For a tablet with a detachable keyboard, connect the keyboard to the keyboard dock before beginning any recovery process.

---

## Creating recovery media and backups

The following methods of creating recovery media and backups are available on select products only. Choose the available method according to your tablet model.

- Use HP Recovery Manager to create HP Recovery media after you successfully set up the tablet. This step creates a backup of the HP Recovery partition on the tablet. The backup can be used to reinstall the original operating system in cases where the hard drive is corrupted or has been replaced. For information on creating recovery media, see [Creating HP Recovery media \(select products only\) on page 49](#). For information on the recovery options that are available using the recovery media, see [Using Windows tools on page 50](#).
- Use Windows tools to create system restore points and create backups of personal information.

For more information, see [Recovering using HP Recovery Manager on page 51](#).

---

 **NOTE:** If storage is 32 GB or less, Microsoft System Restore is disabled by default.

---

## Creating HP Recovery media (select products only)

If possible, check for the presence of the Recovery partition and the Windows partition. From the **Start** menu, select **File Explorer**, and then select **This PC**.

- If your tablet does not list the Windows partition and the Recovery partition, you can obtain recovery media for your system from support. See the *Worldwide Telephone Numbers* booklet included with the tablet. You can also find contact information on the HP website. Go to <http://www.hp.com/support>, select your country or region, and follow the on-screen instructions.

You can use Windows tools to create system restore points and create backups of personal information, see [Using Windows tools on page 50](#).

- If your tablet does list the Recovery partition and the Windows partition, you can use HP Recovery Manager to create recovery media after you successfully set up the tablet. HP Recovery media can be used to perform system recovery if the hard drive becomes corrupted. System recovery reinstalls the original operating system and software programs that were installed at the factory and then configures the settings for the programs. HP Recovery media can also be used to customize the system or restore the factory image if you replace the hard drive.
  - Only one set of recovery media can be created. Handle these recovery tools carefully, and keep them in a safe place.
  - HP Recovery Manager examines the tablet and determines the required storage capacity for the media that will be required.
  - To create recovery discs, your tablet must have an optical drive with DVD writer capability, and you must use only high-quality blank DVD-R, DVD+R, DVD-R DL, or DVD+R DL discs. Do not use rewritable discs such as CD±RW, DVD±RW, double-layer DVD±RW, or BD-RE (rewritable Blu-ray) discs; they are not compatible with HP Recovery Manager software. Or, instead, you can use a high-quality blank USB flash drive.
  - If your tablet does not include an integrated optical drive with DVD writer capability, but you would like to create DVD recovery media, you can use an external optical drive (purchased separately) to create recovery discs. If you use an external optical drive, it must be connected directly to a USB port on the tablet; the drive cannot be connected to a USB port on an external device, such as a USB hub. If you cannot create DVD media yourself, you can obtain recovery discs for your tablet from HP. See the *Worldwide Telephone Numbers* booklet included with the tablet. You can also find contact information on the HP website. Go to <http://www.hp.com/support>, select your country or region, and follow the on-screen instructions.
  - Be sure that the tablet is connected to AC power before you begin creating the recovery media.
  - The creation process can take an hour or more. Do not interrupt the creation process.
  - If necessary, you can exit the program before you have finished creating all of the recovery DVDs. HP Recovery Manager will finish burning the current DVD. The next time you start HP Recovery Manager, you will be prompted to continue.

To create HP Recovery media:



---

**IMPORTANT:** For a tablet with a detachable keyboard, connect the keyboard to the keyboard dock before beginning these steps.

---

1. Type `recovery` in the taskbar search box, and then select **HP Recovery Manager**.
2. Select **Create recovery media**, and then follow the on-screen instructions.

If you ever need to recover the system, see [Recovering using HP Recovery Manager on page 51](#).

## Using Windows tools

You can create recovery media, system restore points, and backups of personal information using Windows tools.



---

**NOTE:** If storage is 32 GB or less, Microsoft System Restore is disabled by default.

---

For more information and steps, see the Get started app.

- ▲ Select the **Start** button, and then select the **Get started** app.

# Restore and recovery

There are several options for recovering your system. Choose the method that best matches your situation and level of expertise:

 **IMPORTANT:** Not all methods are available on all products.

- Windows offers several options for restoring from backup, refreshing the tablet, and resetting the tablet to its original state. For more information see the Get started app.
  - ▲ Select the **Start** button, and then select the **Get started** app.
- If you need to correct a problem with a preinstalled application or driver, use the Reinstall drivers and/or applications option (select products only) of HP Recovery Manager to reinstall the individual application or driver.
  - ▲ Type `recovery` in the taskbar search box, select **HP Recovery Manager**, select **Reinstall drivers and/or applications**, and then follow the on-screen instructions.
- If you want to recover the Windows partition to original factory content, you can choose the System Recovery option from the HP Recovery partition (select products only) or use the HP Recovery media. For more information, see [Recovering using HP Recovery Manager on page 51](#). If you have not already created recovery media, see [Creating HP Recovery media \(select products only\) on page 49](#).
- On select products, if you want to recover the tablet's original factory partition and content, or if you have replaced the hard drive, you can use the Factory Reset option of HP Recovery media. For more information, see [Recovering using HP Recovery Manager on page 51](#).
- On select products, if you want to remove the recovery partition to reclaim hard drive space, HP Recovery Manager offers the Remove Recovery Partition option.

For more information, see [Removing the HP Recovery partition \(select products only\) on page 54](#).

## Recovering using HP Recovery Manager

HP Recovery Manager software allows you to recover the tablet to its original factory state by using the HP Recovery media that you either created or that you obtained from HP, or by using the HP Recovery partition (select products only). If you have not already created recovery media, see [Creating HP Recovery media \(select products only\) on page 49](#).

### What you need to know before you get started

- HP Recovery Manager recovers only software that was installed at the factory. For software not provided with this tablet, you must either download the software from the manufacturer's website or reinstall the software from the media provided by the manufacturer.

 **IMPORTANT:** Recovery through HP Recovery Manager should be used as a final attempt to correct tablet issues.

- HP Recovery media must be used if the tablet hard drive fails. If you have not already created recovery media, see [Creating HP Recovery media \(select products only\) on page 49](#).
- To use the Factory Reset option (select products only), you must use HP Recovery media. If you have not already created recovery media, see [Creating HP Recovery media \(select products only\) on page 49](#).
- If your tablet does not allow the creation of HP Recovery media or if the HP Recovery media does not work, you can obtain recovery media for your system from support. See the *Worldwide Telephone Numbers* booklet included with the tablet. You can also find contact information from the HP website. Go to <http://www.hp.com/support>, select your country or region, and follow the on-screen instructions.

---

 **IMPORTANT:** HP Recovery Manager does not automatically provide backups of your personal data. Before beginning recovery, back up any personal data you want to retain.

---

Using HP Recovery media, you can choose from one of the following recovery options:

---

 **NOTE:** Only the options available for your tablet display when you start the recovery process.

---

- System Recovery—Reinstalls the original operating system, and then configures the settings for the programs that were installed at the factory.
- Factory Reset—Restores the tablet to its original factory state by deleting all information from the hard drive and re-creating the partitions. Then it reinstalls the operating system and the software that was installed at the factory.

The HP Recovery partition (select products only) allows System Recovery only.

## Using the HP Recovery partition (select products only)

The HP Recovery partition allows you to perform a system recovery without the need for recovery discs or a recovery USB flash drive. This type of recovery can be used only if the hard drive is still working.

To start HP Recovery Manager from the HP Recovery partition:

---

 **IMPORTANT:** For a tablet with a detachable keyboard, connect the keyboard to the keyboard dock before beginning these steps (select products only).

---

1. Type `recovery` in the taskbar search box, select **Recovery Manager**, and then select **HP Recovery Environment**.

Turn on or restart the tablet, and then quickly hold down the volume down button; then select **f11**.

- or -

Turn on or restart the tablet, and then quickly hold down the Windows button; then select **f11**.

2. Select **Troubleshoot** from the boot options menu.
3. Select **Recovery Manager**, and then follow the on-screen instructions.

## Using HP Recovery media to recover

You can use HP Recovery media to recover the original system. This method can be used if your system does not have an HP Recovery partition or if the hard drive is not working properly.

1. If possible, back up all personal files.
2. Insert the HP Recovery media, and then restart the tablet.

---

 **NOTE:** If the tablet does not automatically restart in HP Recovery Manager, change the tablet boot order. See [Changing the tablet boot order on page 52](#).

---

3. Follow the on-screen instructions.

## Changing the tablet boot order

If your tablet does not restart in HP Recovery Manager, you can change the tablet boot order, which is the order of devices listed in BIOS where the tablet looks for startup information. You can change the selection to an optical drive or a USB flash drive.

To change the boot order:



---

**IMPORTANT:** For a tablet with a detachable keyboard, connect the keyboard to the keyboard dock before beginning these steps.

---

1. Insert the HP Recovery media.
2. Access BIOS:
  - ▲ Turn on or restart the tablet, and then quickly hold down the volume down button; then select **f9**.
  - or -
  - Turn on or restart the tablet, and then quickly hold down the Windows button; then select **f9**.
3. Select the optical drive or USB flash drive from which you want to boot.
4. Follow the on-screen instructions.

## Removing the HP Recovery partition (select products only)

HP Recovery Manager software allows you to remove the HP Recovery partition to free up hard drive space.



**IMPORTANT:** After you remove the HP Recovery partition, you will not be able to perform System Recovery or create HP recovery media from the HP Recovery partition. So before you remove the Recovery partition, create HP Recovery media; see [Creating HP Recovery media \(select products only\) on page 49](#).



**NOTE:** The Remove Recovery Partition option is only available on products that support this function.

Follow these steps to remove the HP Recovery partition:

1. Type `recovery` in the taskbar search box, and then select **HP Recovery Manager**.
2. Select **Remove Recovery Partition**, and then follow the on-screen instructions.



---

# 12 Computer Setup (BIOS), TPM, and HP Sure Start

## Using Computer Setup

Computer Setup, or Basic Input/Output System (BIOS), controls communication between all the input and output devices on the system (such as disk drives, display, keyboard, mouse, and printer). Computer Setup includes settings for the types of devices installed, the startup sequence of the tablet, and the amount of system and extended memory.

---

 **NOTE:** Use extreme care when making changes in Computer Setup. Errors can prevent the tablet from operating properly.

---

## Starting Computer Setup

---

 **NOTE:** An external keyboard or mouse connected to a USB port can be used with Computer Setup only if USB legacy support is enabled.

---

To start Computer Setup, follow these steps:

- ▲ Start Computer Setup.
  - Tablets without keyboards:
    - ▲ Turn off the tablet. Press the power button in combination with the volume down button until the Startup menu is displayed, and then tap **F10** to enter Computer Setup.

## Navigating and selecting in Computer Setup

- To select a menu or a menu item, use the **tab** key and the keyboard arrow keys and then press **enter**, or use a pointing device to select the item.

---

 **NOTE:** On tablets without keyboards, you can use your finger to make selections.

---

- To scroll up and down, select the up arrow or the down arrow in the upper-right corner of the screen, or use the up arrow key or the down arrow key on the keyboard.
- To close open dialog boxes and return to the main Computer Setup screen, press **esc**, and then follow the on-screen instructions.

To exit Computer Setup menus, choose one of the following methods:

- To exit Computer Setup menus without saving your changes:
  - Select the **Exit** icon in the lower-right corner of the screen, and then follow the on-screen instructions.
  - or –
  - Select **Main**, select **Ignore Changes and Exit**, and then press **enter**.
- To save your changes and exit Computer Setup menus:
  - Select the **Save** icon in the lower-right corner of the screen, and then follow the on-screen instructions.
  - or –

Select **Main**, select **Save Changes and Exit**, and then press [enter](#).

Your changes take effect when the tablet restarts.

## Restoring factory settings in Computer Setup

---

 **NOTE:** Restoring defaults will not change the hard drive mode.

---

To return all settings in Computer Setup to the values that were set at the factory, follow these steps:

1. Start Computer Setup. See [Starting Computer Setup on page 55](#).
2. Select **Main**, and then select **Apply Factory Defaults and Exit**.

---

 **NOTE:** On select products, the selections may display **Restore Defaults** instead of **Apply Factory Defaults and Exit**.

---

3. Follow the on-screen instructions.
4. To save your changes and exit, select the **Save** icon in the lower-right corner of the screen, and then follow the on-screen instructions.

– or –

Select **Main**, select **Save Changes and Exit**, and then press [enter](#).

Your changes take effect when the tablet restarts.

---

 **NOTE:** Your password settings and security settings are not changed when you restore the factory settings.

---

## Updating the BIOS

Updated versions of the BIOS may be available on the HP website.

Most BIOS updates on the HP website are packaged in compressed files called *SoftPaqs*.

Some download packages contain a file named *Readme.txt*, which contains information regarding installing and troubleshooting the file.

### Determining the BIOS version

To decide whether you need to update Computer Setup (BIOS), first determine the BIOS version on your tablet.

BIOS version information (also known as *ROM date* and *System BIOS*) can be accessed by pressing **fn+esc** (if you are already in Windows) or by using Computer Setup.

1. Start Computer Setup. See [Starting Computer Setup on page 55](#).
2. Select **Main**, and then select **System Information**.
3. To exit Computer Setup without saving your changes, select the **Exit** icon in the lower-right corner of the screen, and then follow the on-screen instructions.

– or –

Select **Main**, select **Ignore Changes and Exit**, and then press **enter**.

To check for later BIOS versions, see [Downloading a BIOS update on page 57](#).

### Downloading a BIOS update

---

 **CAUTION:** To reduce the risk of damage to the tablet or an unsuccessful installation, download and install a BIOS update only when the tablet is connected to reliable external power using the AC adapter. Do not download or install a BIOS update while the tablet is running on battery power, docked in an optional docking device, or connected to an optional power source. During the download and installation, follow these instructions:

Do not disconnect power on the tablet by unplugging the power cord from the AC outlet.

Do not shut down the tablet or initiate Sleep.

Do not insert, remove, connect, or disconnect any device, cable, or cord.

---

1. From the Start screen, type *support*, and then select the **HP Support Assistant** app.
2. Make the selection for updates.
3. Follow the on-screen instructions.
4. At the download area, follow these steps:
  - a. Identify the most recent BIOS update and compare it to the BIOS version currently installed on your tablet. Make a note of the date, name, or other identifier. You may need this information to locate the update later, after it has been downloaded to your hard drive.
  - b. Follow the on-screen instructions to download your selection to the hard drive.

Make a note of the path to the location on your hard drive where the BIOS update is downloaded. You will need to access this path when you are ready to install the update.

---

 **NOTE:** If you connect your tablet to a network, consult the network administrator before installing any software updates, especially system BIOS updates.

---

BIOS installation procedures vary. Follow any instructions that are revealed on the screen after the download is complete. If no instructions are revealed, follow these steps:

1. From the Start screen, type `file`, and then select **File Explorer**.
2. Select your hard drive designation. The hard drive designation is typically Local Disk (C:).
3. Using the hard drive path you recorded earlier, open the folder that contains the update.
4. Tap and hold the file that has an `.exe` extension (for example, `filename.exe`).  
The BIOS installation begins.
5. Complete the installation by following the on-screen instructions.

---

 **NOTE:** After a message on the screen reports a successful installation, you can delete the downloaded file from your hard drive.

---

## Changing the boot order using the f9 prompt

To dynamically choose a boot device for the current startup sequence, follow these steps:

1. Access the Boot Device Options menu:
  - Computers or tablets with keyboards:
    - ▲ Turn on or restart the computer, and when the HP logo appears, press **f9** to enter the Boot Device Options menu.
  - Tablets without keyboards:
    - ▲ Turn off the tablet. Press the power button in combination with the volume down button until the Startup menu is displayed, and then tap **F9** to enter the Boot Device Options menu.
2. Select a boot device, then press `enter`.

## TPM BIOS settings (select products only)

---

 **IMPORTANT:** Before enabling Trusted Platform Module (TPM) functionality on this system, you must ensure that your intended use of TPM complies with relevant local laws, regulations and policies, and approvals or licenses must be obtained if applicable. For any compliance issues arising from your operation/usage of TPM which violates the above mentioned requirement, you shall bear all the liabilities wholly and solely. HP will not be responsible for any related liabilities.

---

TPM provides additional security for your tablet. You can modify the TPM settings in Computer Setup (BIOS).

---

 **NOTE:** If you change the TPM setting to Hidden, TPM is not visible in the operating system.

---

To access TPM settings in Computer Setup:

1. Start Computer Setup. See [Starting Computer Setup on page 55](#).
2. Select **Security**, select **TPM Embedded Security**, and then follow the on-screen instructions.

## Using HP Sure Start (select products only)

Select tablet models are configured with HP Sure Start, a technology that continuously monitors the tablet's BIOS for attacks or corruption. If the BIOS becomes corrupted or is attacked, HP Sure Start automatically restores the BIOS to its previously safe state, without user intervention.

HP Sure Start is configured and already enabled so that most users can use the HP Sure Start default configuration. The default configuration can be customized by advanced users.

To access the latest documentation on HP Sure Start, go to <http://www.hp.com/support>, and select your country. Select **Drivers & Downloads**, and then follow the on-screen instructions.

---

# 13 HP PC Hardware Diagnostics (UEFI)

HP PC Hardware Diagnostics is a Unified Extensible Firmware Interface (UEFI) that allows you to run diagnostic tests to determine whether the tablet hardware is functioning properly. The tool runs outside the operating system so that it can isolate hardware failures from issues that are caused by the operating system or other software components.

To start HP PC Hardware Diagnostics UEFI:

1. Start BIOS:
  - Computers or tablets with keyboards:
    - ▲ Turn on or restart the computer, quickly press `esc`.
  - Tablets without keyboards:
    - ▲ Turn on or restart the tablet, and then quickly hold down the volume down button.
    - or -
    - Turn on or restart the tablet, and then quickly hold down the Windows button.
2. Press or tap `f2`.

The BIOS searches three places for the diagnostic tools, in the following order:

- a. Connected USB drive



**NOTE:** To download the HP PC Hardware Diagnostics (UEFI) tool to a USB drive, see [Downloading HP PC Hardware Diagnostics \(UEFI\) to a USB device on page 60](#).

- b. Hard drive
- c. BIOS

3. When the diagnostic tool opens, select the type of diagnostic test you want to run, and then follow the on-screen instructions. On a tablet, press the volume down button to stop a diagnostic test.



**NOTE:** If you need to stop a diagnostic test on computers or tablets with a keyboard, press `esc`.

---

## Downloading HP PC Hardware Diagnostics (UEFI) to a USB device

There are two options to download HP PC Hardware Diagnostics to a USB device:

### Download the latest UEFI version:

1. Go to <http://www.hp.com/go/techcenter/pcdiags>. The HP PC Diagnostics home page is displayed.
2. In the HP PC Hardware Diagnostics section, select the **Download** link, and then select **Run**.

### Download any version of UEFI for a specific product:

1. Go to <http://www.hp.com/support>, and then select your country. The HP Support page is displayed.
2. Select **Drivers & Downloads**.

3. In the text box, enter the product name, and then select **Go**.

– or –

Select **Find Now** to let HP automatically detect your product.

4. Select your tablet, and then select your operating system.

5. In the **Diagnostic** section, follow the on-screen instructions to select and download the UEFI version you want.

---

# 14 Support

## Contacting support

If the information provided in this user guide or HP Support Assistant does not address your questions, you can contact support. For worldwide support, go to <http://h20565.www2.hp.com/portal/site/hpsc>.

Here you can:

- Chat online with an HP technician.



**NOTE:** When support chat is not available in a particular language, it is available in English.

- Email support.
- Find support telephone numbers.
- Locate an HP service center.



# 15 Specifications

## Input power

The power information in this section may be helpful if you plan to travel internationally with the tablet.

The tablet operates on DC power, which can be supplied by an AC or a DC power source. The AC power source must be rated at 100–240 V, 50–60 Hz. Although the tablet can be powered from a standalone DC power source, it should be powered only with an AC adapter or a DC power source supplied and approved by HP for use with this tablet.

The tablet can operate on DC power within the following specifications.

Input Power	Rating
Operating voltage and current	9 V DC @ 1.1 A – 10 W

 **NOTE:** This product is designed for IT power systems in Norway with phase-to-phase voltage not exceeding 240 V rms.

 **NOTE:** The tablet operating voltage and current can be found on the system regulatory label.

## Operating environment

Factor	Metric	U.S.
<b>Temperature</b>		
Operating (writing to optical disc)	<b>5°C to 35°C</b>	41°F to 95°F
Nonoperating	<b>-20°C to 60°C</b>	-4°F to 140°F
<b>Relative humidity</b> (noncondensing)		
Operating	<b>10% to 90%</b>	10% to 90%
Nonoperating	<b>5% to 95%</b>	5% to 95%
<b>Maximum altitude</b> (unpressurized)		
Operating	<b>-15 m to 3,048 m</b>	-50 ft to 10,000 ft
Nonoperating	<b>-15 m to 12,192 m</b>	-50 ft to 40,000 ft

---

# 16 Accessibility

HP designs, produces, and markets products and services that can be used by everyone, including people with disabilities, either on a stand-alone basis or with appropriate assistive devices.

## Supported assistive technologies

HP products support a wide variety of operating system assistive technologies and can be configured to work with additional assistive technologies. Use the Search feature on your device to locate more information about assistive features.

---

 **NOTE:** For additional information about a particular assistive technology product, contact customer support for that product.

---

## Contacting support

We are constantly refining the accessibility of our products and services and welcome feedback from users. If you have an issue with a product or would like to tell us about accessibility features that have helped you, please contact us at +1 (888) 259-5707, Monday through Friday, 6 a.m. to 9 p.m. North American Mountain Time. If you are deaf or hard-of-hearing and use TRS/VRS/WebCapTel, contact us if you require technical support or have accessibility questions by calling +1 (877) 656-7058, Monday through Friday, 6 a.m. to 9 p.m. North American Mountain Time.

---

 **NOTE:** Support is in English only.

---

---

# A Traveling with the tablet

For best results, follow these traveling and shipping tips:

- Prepare the tablet for traveling or shipping:

- Back up your information.
- Remove all external media cards, such as memory cards.

---

**⚠ CAUTION:** To reduce the risk of damage to the tablet, damage to a drive, or loss of information, remove the media from a drive before shipping, storing, or traveling with a drive.

---

- Turn off and then disconnect all external devices.
  - Shut down the tablet.
- Take along a backup of your information. Keep the backup separate from the tablet.
  - When traveling by air, carry the tablet as hand luggage; do not check it in with the rest of your bags.

---

**⚠ CAUTION:** Avoid exposing a drive to magnetic fields. Security devices with magnetic fields include airport walk-through devices and security wands. Airport conveyer belts and similar security devices that check carry-on baggage use X-rays instead of magnetism and do not damage drives.

---

- In-flight tablet use is at the discretion of the airline. If you plan to use the tablet during a flight, check with the airline in advance.
- If you are shipping the tablet, use suitable protective packaging and label the package “FRAGILE.”
- If the tablet has a wireless device installed, such as an 802.11b/g device, a Global System for Mobile Communications (GSM) device, or a General Packet Radio Service (GPRS) device, the use of these devices may be restricted in some environments. Such restrictions may apply onboard aircraft, in hospitals, near explosives, and in hazardous locations. If you are uncertain of the policy that applies to the use of a particular device, ask for authorization to use it before you turn it on.
- If you are traveling internationally, follow these suggestions:
  - Check the tablet-related customs regulations for each country or region on your itinerary.
  - Check the power cord and adapter requirements for each location in which you plan to use the tablet. Voltage, frequency, and plug configurations vary.

---

**⚠ WARNING!** To reduce the risk of electric shock, fire, or damage to the equipment, do not attempt to power the tablet with a voltage converter kit sold for appliances.

---

---

## B Electrostatic discharge

Electrostatic discharge is the release of static electricity when two objects come into contact—for example, the shock you receive when you walk across the carpet and touch a metal door knob.

A discharge of static electricity from fingers or other electrostatic conductors may damage electronic components.

To prevent damage to the tablet, damage to a drive, or loss of information, observe these precautions:

- If removal or installation instructions direct you to unplug the tablet, unplug it after being properly grounded and before removing a cover.
- Keep components in their electrostatic-safe containers until you are ready to install them.
- Avoid touching pins, leads, and circuitry. Handle electronic components as little as possible.
- Use nonmagnetic tools.
- Before handling components, discharge static electricity by touching an unpainted metal surface of the component.
- If you remove a component, place it in an electrostatic-safe container.

If you need more information about static electricity or assistance with component removal or installation, contact HP support.

---

# C Troubleshooting

## Troubleshooting resources

- Access website links and additional information about the tablet through HP Support Assistant. To access HP Support Assistant, see [Finding information on page 2](#).



**NOTE:** Some checkup and repair tools require an Internet connection. HP also provides additional tools that do not require an Internet connection.

- Contact HP support. For U.S. support, go to <http://www.hp.com/go/contactHP>. For worldwide support, go to [http://welcome.hp.com/country/us/en/wwcontact\\_us.html](http://welcome.hp.com/country/us/en/wwcontact_us.html).

Choose from the following types of support:

- Chat online with an HP technician.



**NOTE:** When chat is not available in a particular language, it is available in English.

- Send an email to HP support.
- Find HP support worldwide telephone numbers.
- Locate an HP service center.

## Resolving issues

The following sections describe several common issues and solutions.

### The tablet is unable to start up

If the tablet does not turn on when you press the power button, the following suggestions may help you determine why the tablet does not start up:

- If the tablet is plugged into an AC outlet, plug another electrical device into the outlet to be sure that the outlet is providing adequate power.



**NOTE:** Use only the AC adapter provided with the tablet or one approved by HP for this tablet.

- If the tablet is plugged into an external power source other than an AC outlet, plug the tablet into an AC outlet using the AC adapter. Be sure that the power cord and AC adapter connections are secure.

### An external device is not working

Follow these suggestions if an external device does not function as expected:

- Turn on the device according to the manufacturer's instructions.
- Be sure that all device connections are secure.
- Be sure that the device is receiving electrical power.
- Be sure that the device, especially if it is older, is compatible with the operating system.
- Be sure that the correct drivers are installed and updated.

## A video is not visible on an external display

1. Be sure that both the tablet and an external display device are on. Then, on the on-screen keyboard, press **fn+f4** one or more times to switch between the tablet screen and the external display.
2. Configure the monitor settings to make the external display primary:
  - a. From the Windows desktop, tap and hold on a blank area of the tablet desktop, and select **Screen resolution**.
  - b. Specify a primary display and a secondary display.



**NOTE:** When you are using both displays, a DVD image will not appear on any display designated as the secondary display.

---

# Index

## A

- accessibility 64
- administrator password 40
- ambient light sensor, identifying 5
- antivirus software 41
- audio functions, checking 22
- audio-in (microphone) jack, identifying 8
- audio-out (headphone) jack, identifying 8

## B

- backups 49
- bar-code scanner
  - configuring 25, 26
  - default settings 27
  - identifying 9
  - scanning 25
- battery
  - conserving power 33
  - discharging 32
  - displaying remaining charge 32
  - low battery levels 32
- Battery Check 32
- battery information, finding 32
- battery power 31
- BIOS
  - determining version 57
  - downloading an update 57
  - updating 57
- Bluetooth device 12, 14
- Bluetooth label 10
- boot order
  - changing 52
- bottom 10
- buttons
  - bar-code scanner 6
  - power 8, 30
  - volume 21

## C

- cables
  - USB 36
- caring for your tablet 43
- checking audio functions 22

- cleaning your tablet 43
- components
  - bottom 9
  - front 4
  - rear 6, 7
  - top 8
- Computer Setup
  - navigating and selecting 55
  - restoring factory settings 56
- configuring
  - audio for HDMI 24
- connecting to a WLAN 14
- connector, power 9
- conservation, power 33
- corporate WLAN connection 14
- critical battery level 30
- critical updates, software 42

## D

- docking connector, identifying 9
- drive media 30
- drives
  - external 37
  - hard 37
  - optical 37

## E

- edge-swipe gestures 18, 19
- electrostatic discharge 66
- external AC power, using 33
- external devices 37
- external drive 37

## F

- f11 recovery 47
- firewall software 42

## G

- GPS 15

## H

- hard drive
  - external 37
- hard drive recovery 47
- HDMI port, connecting 24

- HDMI port, identifying 9
- HDMI, configuring audio 24
- headphone (audio-out) jack 8
- headphones and microphones, connecting 22
- high-definition devices, connecting 24
- HP Client Security 42
- HP PC Hardware Diagnostics (UEFI) using 60
- HP Recovery Manager
  - correcting boot problems 52
  - starting 52
- HP Recovery media
  - creating 49
  - recovery 52
- HP Recovery partition
  - recovery 52
  - removing 54
- hubs 35

## I

- input power 63
- integrated webcam light, identifying 6
- Internet connection setup 13
- issues, resolving 67

## J

- jacks
  - audio-in (microphone) 8
  - audio-out (headphone) 8
  - network 9
  - RJ-45 (network) 9
- Java Card
  - defined 35
  - inserting 35
  - removing 35

## K

- keys
  - volume 21

- L**
- labels
  - Bluetooth 10
  - Microsoft Certificate of Authenticity 9
  - regulatory 10
  - serial number 9
  - service 9
  - wireless certification 10
  - WLAN 10
- left-edge swipe 19
- legacy support, USB 55
- lights
  - RJ-45 (network) 9
  - webcam 6
- low battery level 32
- M**
- microphone (audio-in) jack, identifying 8
- minimized image recovery 52
- minimized image, creating 51
- N**
- Near Field Communications 29
- network jack, identifying 9
- NFC tapping area 5
- O**
- operating environment 63
- optical drive 37
- optional external devices, using 37
- original system recovery 51
- P**
- password protection on wakeup 31
- passwords
  - administrator 40
  - user 40
- pinching touch screen gesture 18
- ports
  - HDMI 9, 24
  - serial 9
- power
  - battery 31
  - conserving 33
  - options 30
- power button 30
- power button, identifying 8
- power connector, identifying 9
- power-saving states 30
- product name and number, tablet 9
- public WLAN connection 14
- R**
- readable media 30
- recover
  - options 51
- recovery 48
  - discs 50, 52
  - HP Recovery Manager 51
  - media 52
  - starting 52
  - supported discs 50
  - system 51
  - USB flash drive 52
  - using HP Recovery media 50
- recovery media
  - creating 49
  - creating using HP Recovery Manager 50
- recovery partition 47
  - removing 54
- refresh 48
- regulatory information
  - regulatory label 10
  - wireless certification labels 10
- restoring the hard drive 47
- right-edge swipe 18
- RJ-45 (network) jack, identifying 9
- RJ-45 (network) lights, identifying 9
- S**
- security cable slot, identifying 6
- security, wireless 13
- serial number 9
- serial number, tablet 9
- serial port, identifying 9
- service labels, locating 9
- setting
  - password protection on wakeup 31
  - power options 30
- setup of WLAN 13
- setup utility
  - navigating and selecting 55
  - restoring factory settings 56
- shutdown 30
- Sleep
  - exiting 30
  - initiating 30
- slots
  - security cable 6
  - smart card 7
- smart card
  - defined 35
  - inserting 35
  - removing 35
- smart card slot 7
- SoftPaqs, downloading 44
- software
  - antivirus 41
  - critical updates 42
  - firewall 42
- supported discs, recovery 50
- Sure Start
  - using 58
- system recovery 51
- system restore point
  - creating 50
  - system restore point, creating 49
- T**
- tablet, traveling 65
- top-edge swipe 19
- touch screen gestures 18, 19
  - edge-swipe gestures 18, 19
  - one-finger slide 16
  - pinch 18
  - scrolling 17
  - tapping 17
- touch screen, using 16
- TPM settings 58
- traveling with the tablet 10, 65
- troubleshooting, external display 68
- turning off the tablet 30
- U**
- unresponsive system 30
- USB 3.0 port 7, 9
- USB cable, connecting 36
- USB devices
  - connecting 35
  - description 35
  - removing 36
- USB hubs 35
- USB legacy support 55



- USB ports, identifying 7, 9
- user password 40
- using
  - external AC power 33
  - power-saving states 30

## V

- video 23
- volume
  - adjusting 21
  - buttons 21
  - keys 21

## W

- webcam 4, 6
  - using 23
- webcam light, identifying 6
- webcam, identifying 6
- Windows
  - Refresh 48
  - system restore point 49, 50
- Windows button, identifying 5
- Windows tools
  - using 50
- wireless antennas, identifying 4
- wireless certification label 10
- wireless controls, operating system 12
- wireless network (WLAN)
  - connecting 14
  - corporate WLAN connection 14
  - equipment needed 13
  - functional range 14
  - public WLAN connection 14
  - security 13
  - using 12
- WLAN
  - antennas, identifying 5
  - device 12
- WLAN device 10
- WLAN label 10
- writable media 30
- WWAN
  - antennas, identifying 4
  - device 15

## Z

- zoom touch screen gesture 18