



f720

**Car Camcorder
User Manual**

Contents

About this Guide	3
FCC Statement	3
WEEE Notice.....	3
CE Regulatory Notice	4
Notes on Installation	4
Caution	5
1 Introduction.....	6
1.1 Features.....	6
1.2 Package Contents	6
1.3 Product Overview.....	7
2 Getting Started	9
2.1 Inserting the Memory Card	9
2.2 Installing in Vehicles	10
2.3 Connecting to Power.....	10
2.4 Powering the Camcorder On / Off	12
2.4.1 Auto Power On/Off	12
2.4.2 Manual Power On/Off.....	12
2.5 Initial Settings.....	13
2.5.1 Set the Date and Time.....	13
3 Using the Camcorder.....	14
3.1 Recording Videos	14
3.1.1 Record videos while driving	14
3.1.2 Manual Video Recording.....	14
3.1.3 Emergency Recording	15
3.1.4 The Recording Screen.....	16
3.1.5 Taking Photographs	18
3.2 Playback Videos and Photos.....	18

3.2.1	Playing Videos.....	19
3.2.2	Viewing Photos	19
3.2.3	The Playback Screen	20
3.2.4	Deleting Files	21
4	Adjusting the Settings	22
4.1	Menu Tree	22
5	Specifications	24

About this Guide

The content in this document is for information purpose and is subject to change without prior notice. We made every effort to ensure that this User Guide is accurate and complete. However, no liability is assumed for any errors and omissions that may have occurred. The manufacturer reserves the right to change the technical specifications without prior notice.

FCC Statement

This equipment has been tested and found to comply with the limits for a Class B digital camcorder, pursuant to Part 15 of the FCC Rules. These limits are designed to provide reasonable protection against harmful interference in a residential installation. This equipment generates, uses and can radiate radio frequency energy and, if not installed and used in accordance with the instructions, may cause harmful interference to radio communications. However, there is no guarantee that interference will not occur in a particular installation. If this equipment does cause harmful interference to radio or television reception, which can be determined by turning the equipment off and on, the user is encouraged to try to correct the interference by one or more of the following measures:

- Reorient or relocate the receiving antenna.
- Increase the separation between the equipment and receiver.
- Connect the equipment into an outlet on a circuit different from that to which the receiver is connected.
- Consult the dealer or an experienced radio/TV technician for help.

This camcorder complies with Part 15 of the FCC Rules. Operation is subject to the following two conditions: (1) This device may not cause harmful interference, and (2) this camcorder must accept any interference received, including interference that may cause undesired operation.

FCC Caution: Any changes or modifications not expressly approved by the party responsible for compliance could void the user's authority to operate this equipment.

WEEE Notice

Disposal of Waste Electrical and Electronic Equipment and/or Battery by users in private households in the European Union



This symbol on the product or on the packaging indicates that this can not be disposed of as a household waste. You must dispose of your waste equipment and/or battery by handling it over to the applicable take-back scheme for the recycling of electrical and electronic equipment and/or battery. For more information about recycling of this equipment and/or battery, please contact your city office, the shop where you purchased the equipment or your household waste disposal service. The recycling of materials will help to conserve natural resources and ensure that it is recycled in a manner that protects human health and environment.

CE Regulatory Notice

Herewith confirm to comply with the requirements set out in the Council Directives on the Approximation of the Laws of the Member States relating Electromagnetic Compatibility of Radio and Telecom camcorder (1995/5/EC); the Low Voltage Directive (2006/95/EC); the Restriction of The Use of Certain Hazardous Substances in Electrical And Electronic Equipment Directive (2002/95/EC), Turkish EEE Directive; the Commission Regulation (EC) No 1275/2008 implementing Directive 2005/32/EC of the European Parliament and of the Council with regard to eco-design requirements for standby and off mode electric power consumption of electrical and electronic household and office equipment, and the Directive 2009/125/EC of the European parliament and of the council establishing a framework for the setting of eco-design requirements for energy-related products.

Notes on Installation

1. Do NOT setup the camcorder while driving or while the vehicle is in motion. Please stop at a safe place before adjusting or installing.
2. Install the camcorder above the rear-view mirror to obtain the best open-field view. Do NOT install the camcorder in a location that will obstruct your required driving view.
3. Make sure that the lens is within the wiping range of the windscreen wiper to ensure a clear view even when it rains.
4. Do not touch the lens with your fingers. Finger grease may be left on the lens and will result in unclear videos or snapshots. Clean the lens on a regular basis.

Caution

- ❖ Use the authorized charger only.
- ❖ Never disassemble or attempt repair of this product. Doing so may damage the camcorder, cause electric shock and void your product warranty.
- ❖ Never short-circuit the battery.
- ❖ Set up time and date accurately before you use this camcorder.
- ❖ Exposing the camcorder to open flames can cause explosion.
- ❖ Due to local laws and vehicles safety considerations, do not manually operate the camcorder while driving.
- ❖ The values displayed in this system, such as speed, position, and the distance warning to the speed camera set points, may be inaccurate due to the influence of surrounding environment. They are for your reference only.
- ❖ Hewlett-Packard Company is NOT responsible for the loss of any data/content during operation.

Before you start using the Car Camcorder it is assumed that you agree to the above statements.

1 Introduction





Thank you for purchasing this advanced camcorder. This camcorder is specifically designed for real time video and audio recording when driving.

1.1 Features

- High Dynamic Range Imaging (HDR)
- Super HD 2304*1296
- Up to 150 Degree Wide Angle Glass Lens & IR-Filter
- Built-in G-sensor
- Motion Detection
- Collision Detection
- Emergency Recording File
- Advanced Driver Assistance Systems (ADAS)







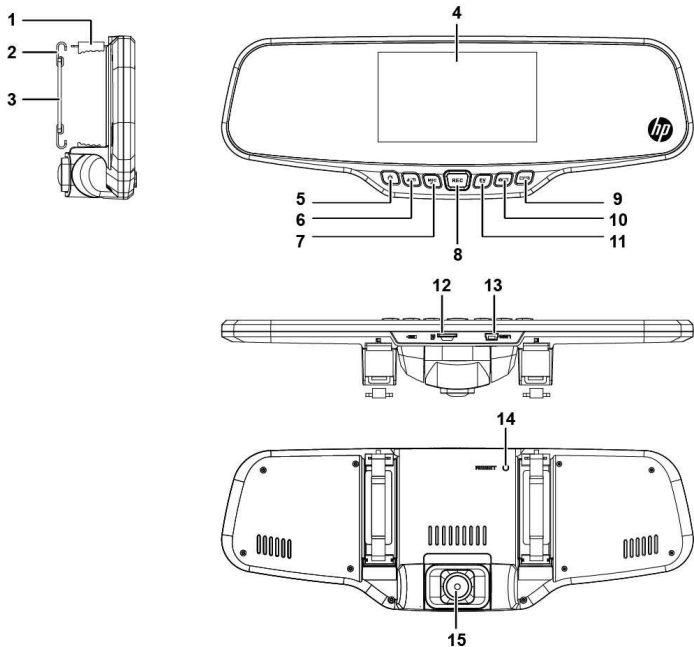

1.2 Package Contents

The package contains the following items. If there are any missing or damaged items, contact your dealer immediately.

Car camcorder	Hook+Band	CD-ROM
		
Quick start guide	Car adapter	
		

1.3 Product Overview



No.	Item
1	Rearview mirror clip
2	Hook
3	Band
4	Display
5	Power on/off()
6	Settings Menu and Delete button ( )
7	Microphone enable/ disable and Up navigation button. ()
8	Record Stop/Start and Select button (REC)
9	Press to turn LCD on or off. ( )
10	Mode Select ( )
11	Exposure Value setting and Down navigation button ()
12	MicroSD memory card port
13	Car power adapter and PC connection USB port
14	Reset
15	Lens

2 Getting Started

2.1 Inserting the Memory Card

Insert the memory card with the gold contacts facing the back of the camcorder. Push the memory card until it clicks into place. (Use class 6 or greater speed micro SD cards for this camcorder; it is recommended to format the micro SD cards before the initial use.)

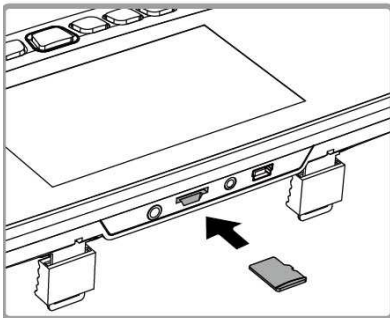

To remove the memory card

Push the edge of the memory card inward until you hear/feel it click, then allow it to push out until you can remove it from the slot.

Note:

1. Do not remove or insert the memory card when the camcorder is powered on. This may damage the memory card.
2. It is recommended to use a 32 GB, Class 6 speed or above micro SD card.
3. It is recommended to format the micro SD cards before the initial use.

2.2 Installing in Vehicles

1. Clip on to your original car mirror.



2. Circle the clip with the band.



3. Adjust the camcorder lens.

2.3 Connecting to Power

Use only the supplied car adapter to power up the camcorder and charge the built-in battery.

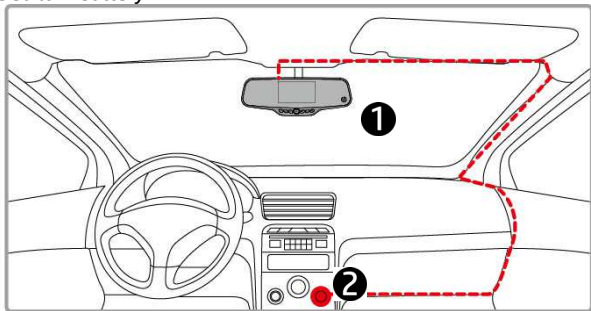







1. Connect one end of the car adapter to the USB connector of the camcorder.
2. Plug the other end of the car charger to the cigarette lighter socket of your vehicle. Once the vehicle engine is started, the camcorder automatically powers on.

Note:

Please take note if the environment temperature reaches 45°C or above, the car adapter still can supply power to camcorder, but it may not charge the battery. This is characteristic of Lithium polymer battery and is not a malfunction.

Battery Status Indicator:

Icon	Description
	Fully Charged
	75% Power
	50% Power
	25% Power
	low battery
	Connect the car adapter to charge the battery, battery is full charged.

Note:

Please take note if the environment temperature reaches 45°C or above, the car adapter still can supply power to camcorder, but it will not charge the Lithium-ion battery. This is the characteristic of Lithium-ion and is not a malfunction.

2.4 Powering the Camcorder On / Off

2.4.1 Auto Power On/Off

Once the vehicle engine is started, the camcorder automatically powers on. And the recording will automatically start.

Once the vehicle engine shuts down, the camcorder automatically saves the recording and turns off the power within 10 seconds.

Note:

Automatic power up and shut down assumes the power socket is linked to the car ignition.

2.4.2 Manual Power On/Off

To manually turn on the power, press the **POWER** button.

To turn off, press and hold the **POWER** button for at least 2 seconds.

To reset, press and hold the **RESET** button on the back of the camcorder for at least 5 seconds.

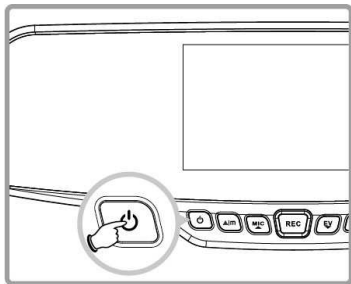

2.5 Initial Settings

2.5.1 Set the Date and Time

To set the correct date and time, do the following:

1. Press the $\Delta|M$ button twice to enter the OSD menu .
2. Press the \uparrow MIC or EV \downarrow button to select **Date / Time** and press the REC button.
3. Press the \uparrow MIC or EV \downarrow button to adjust the value and press the REC button to move to another field.
4. Repeat step 3 until the date and time setting is complete.
5. Press the $\Delta|M$ button to exit the Date/Time settings. Press the $\Delta|M$ button again to exit the settings menu and return to the live view mode.

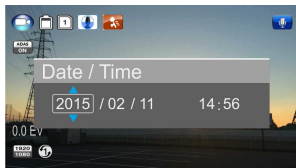

Note:

When the battery is depleted, you must reset the date/time before the function -automatic record is started. If the user doesn't reset the date/time, the camcorder will give you an alert after one minute and the automatic record will be started.

3 Using the Camcorder

3.1 Recording Videos

3.1.1 Record videos while driving

When the vehicle engine starts up and the *Automatic Record* function is enabled, the camcorder automatically turns on and starts recording.

Recording will automatically stop when the engine is switched off.
Or, press the **REC** button to stop recording manually.

Note:

With some vehicle models, the automatic power up and off feature of this car camcorder will not function because the cigarette lighter/power socket is not linked to the ignition system.

To work around this issue, please do one of the following:

- Manually turn on or off the cigarette lighter/power socket if this is possible with your vehicle model.
- Manually plug in the power adapter into the socket to turn on the car camcorder and unplug from the socket to turn off the car camcorder.

3.1.2 Manual Video Recording

1. Press the **REC** button to start recording.
2. Press the **REC** button to stop recording.

Note:

1. One video file is saved for every 1, 3 or 5 minutes of recording depending on the value selected in the settings menu. The default setting is 3 minutes..
2. The camcorder saves the recording on the memory card. If the memory card capacity is full, the oldest file in the memory card will be overwritten.

3.1.3 Emergency Recording

This Car Camcorder is equipped with a sensor that is designed to detect collisions and automatically trigger the Emergency Recording feature.

The  Emergency Recording icon will be displayed if this feature is initiated as illustrated. The Emergency Recording video will not be overwritten via the normal loop recording function of this product.

To manually initiate the Emergency Recording feature, press the  button during the normal recording function.

To stop the recording, press the **REC** button.

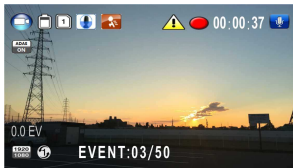







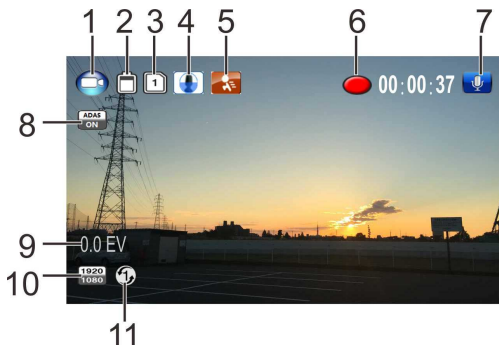

Note:

1. If the **Collision Detection** function is enabled and a collision is detected, the camcorder will automatically trigger the emergency recording feature.
2. The emergency recording file is created as a new file, which will be protected to avoid being overwritten by normal loop recording. A 4 GB memory card can save up to 5 emergency video files, and 8 GB (or above) memory card can save up to 10 emergency video files. The alert message of "**Emergency files are full**" will pop up on the screen when the emergency recording files are full, and the oldest emergency file will be automatically deleted when a new emergency recording file is created.

3.1.4 The Recording Screen







No.	Item	Description
1	Mode icon	 This icon indicates the camcorder is in Video recording mode.  This icon indicates the camcorder is in Photo capture mode.  This icon indicates the camcorder is in recorded video or photo playback mode. To switch modes, the camcorder must be in standby mode. Press the   button to cycle through the modes.
2	Battery	Indicates the estimated remaining battery power. See Battery Status Indicator 2.3
3	TF Card	When a compatible micro SD memory card is inserted, the LCD displays  . If no memory card is inserted or if the memory card is damaged / incompatible, the LCD displays  .

4	G-sensor	Indicates the sensitivity level. Higher blue bar shows higher the sensitivity. Sensor sensitivity level can be changed in the settings menu.
5	Motion Detection	If Motion Detection is activated, the camcorder will automatically trigger recording when the camcorder detects any motion in front. When the battery is fully charged and is in good condition, Motion Detection can record continuously for approximately 30 minutes.
6	Duration	Indicates the current recording duration
7	Microphone	 Indicates sound will be recorded with the video.  Indicates sound will NOT be recorded with the video. Press MIC to disable/ enable
8	Advanced Driver Assistance Systems (ADAS)	Enable/Disable Lane Departure Warning Systems (LDWS) Low Light Warning System(LLWS) Driver Fatigue Alert
9	EV	Indicates the current Exposure Value (EV). Press EV to adjust video exposure. The EV range is -2.0 to +2.0.
10	Resolution	Resolution can be changed in the Settings menu. If the camcorder is in Video mode, available resolutions are: 2304 x 1296 pixels @30fps (fps = frames per second) 1920 x 1080 pixels @30fps (High Dynamic Range) HDR 1920 x 1080 pixels @30fps 1280 x 720 pixels @60fps 1280 x 720 pixels @30fps In Photo mode, available resolutions are: 13 Megapixel (4800 x 2700) 9 Megapixel (4000 x 2250) 4 Megapixel (2688 x 1512)
11	Record Interval	The number in this icon indicates the duration length in minutes of the recorded video files. The duration can be changed (1, 3 or 5 minutes) in the Settings menu.

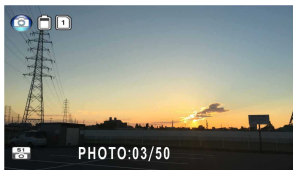
3.1.5 Taking Photographs

This camcorder is capable of taking photographs. If the camcorder is capturing video (red dot on the LCD), press the **REC** button to stop recording and place the camcorder in standby.







From the standby screen, press the   button to change the camcorder mode to photo capture. The mode icon in the upper left screen will change to photo mode  .

Note:

If recording is in progress, press the **REC** button to stop the recording first.



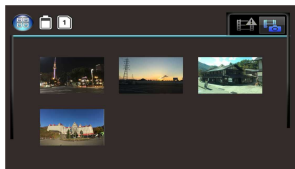

3.2 Playback Videos and Photos

1. If recording is in progress, press the **REC** button to stop recording. The standby screen is displayed.
2. Press the   button twice to enter the playback menu.
3. Press the **MIC** or **EV** button to select the file category  or  that you want to browse and press the **REC** button to display thumbnail images of the recorded video or photo files.
4. Use the **MIC** or **EV** to navigate through the video or photos thumbnails. Thumbnails will become slightly enlarged when selected.



3.2.1 Playing Videos





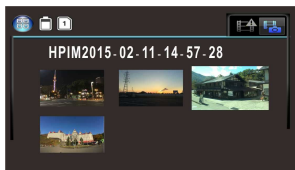



To play videos, do the following:

1. If recording is in progress, press the **REC** button to stop recording.
2. Press the  button twice to enter the **playback** menu.
3. Press the  or  button to select Emergency events icon or   Video/Photo icon and press the **REC** button.
4. Press the  or  button to select **Video** and press the **REC** button.
5. Press the  or  button to browse for the desired video file and press the **REC** button to play the video.
6. Press the **REC** button to pause the playback. Press it again to resume.





3.2.2 Viewing Photos

To view photos, do the following:

1. If recording is in progress, press the **REC** button to stop recording.
2. Press the  button twice to enter the Playback menu.
3. Press the  or  button to enter **Photo Playback** and press the **REC** button.
4. Press the  or  button to select the  icon and press the **REC** button.
5. Press the  or  button to browse for the desired photo file and press the **REC** button to view the file in full screen.

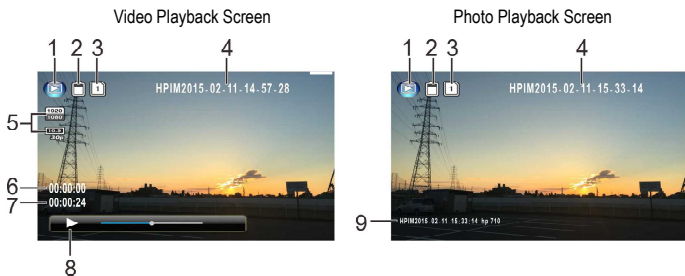
3.2.3 The Playback Screen



No.	Item	Description
1	Playback	Indicates it is in playback mode
2	Battery	Indicates the estimated remaining battery power. See Battery Status Indicator 2.3
3	TF Card	When a compatible micro SD memory card is inserted, the LCD displays  . If no memory card is inserted or if the memory card is damaged / incompatible, the LCD displays  .
4	Date and time	Indicates the recorded date and time
5	Resolution	Indicates the resolution of the video that is being displayed in playback mode.
6	Duration	Indicates the video elapse time
7	Total recorded time	Indicates total recorded time
8	Playback Bar	Press REC to playback
9	Stamp Print	Indicates the file name, date and time stamp if it was enabled in the Settings menu.



3.2.4 Deleting Files

To delete file(s), perform the following steps:

1. If recording is in progress, press the **REC** button to stop recording.



2. Press the   button twice to enter the playback menu.

3. Press the  or  button

to select the   Video/photo files icon. Note that by design, Emergency Event files cannot be deleted with this procedure and press the **REC** button.

4. Press the  or  button to select the file to be deleted.

5. Press the   button to enter the Delete option menu and press the **REC** button.

6. Press the  or  button to select an option.

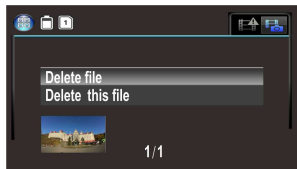
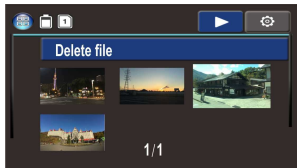

Item	Description
Delete this file	Delete the current selected file.
Delete All	Deletes all files except Emergency Event files.

7. Press the **REC** button to confirm delete.

Note:





Deleted files CANNOT be recovered. Ensure the files you wish to preserve are backup before deletion. Emergency Event files can be deleted if connected to a PC/laptop or if the memory card is formatted in the Settings menu.

4 Adjusting the Settings

4.1 Menu Tree

Refer to the below table for details on menu items and available menu options.

Main Menu	Function List	Description	Available option
	Resolution	Setting of video resolution	Resolution can be changed in the Settings menu. If the camcorder is in Video mode, available resolutions are: 2304 x 1296 pixels @30fps (fps = frames per second) 1920 x 1080 pixels @30fps (High Dynamic Range) HDR 1920 x 1080 pixels @30fps 1280 x 720 pixels @60fps 1280 x 720 pixels @30fps In Photo mode, available resolutions are: 13 Megapixel (4800 x 2700) 9 Megapixel (4000 x 2250) 4 Megapixel (2688 x 1512)
	Image Quality	Set different image quality for the recording videos	Super Fine/Fine/Normal
	Anti-flicker	Reduce flicker on LCD	Auto/60Hz/50Hz
	Time Stamp	Setting for the indication of date and time stamp on the picture or video recorded	On/Off
	ADAS Detect	Enable/Disable Lane Departure Warning Systems (LDWS) Low Light Warning System(LLWS) Driver Fatigue Alert	On/Off
	Record Interval	Set the recording duration for each recorded video file	1 min. / 3 min. / 5 min

Main Menu	Function List	Description	Available option
	Collision Detection	The camcorder will automatically trigger emergency recording when tremor of a collision is detected.	Off/low/medium/high
	Motion Detection	If Motion Detection is activated, the camcorder will automatically trigger recording when the camcorder detects any motion in front. When the battery is fully charged and is in good condition, Motion Detection can record continuously for about 30 minutes.	On/ off
	Language Setting	Set the on-screen display menu language	According to the actual shipping regions
	Date/Time	Set the date and time	
	Format	Format the memory card inserted in the equipment. All the files in the card will be erased. AND CANNOT BE RECOVERED once performed.	 
	Default Setting	Resets the camcorder to the initial factory default settings	 
	LCD Setting	Set the duration for the display to automatically turn off right after video recording starts	On/ off after 10 sec./ off after 30 sec. / Off after 3 min.
	Beep	Enable/Disable camcorders startup, power off and menu button sounds.	On/Off
	Firmware Version	Indicates the current firmware level. This may be important for support assistance.	

5 Specifications

Item	Description
Image sensor	1/3" CMOS sensor
Effective pixels	2688 (H) x 1520 (V)
Storage media	Supports Micro SDHC, up to 32GB class 6 speed or greater
LCD display	4.3" LCD color TFT
Lens	Wide Angle Fixed Focus lens Aperture: Up to F2.0 ; f=2.6 mm
Focus range	0.5m~Infinity
Video	Resolution: Super HD (2304 x 1296), 30fps
	Format: MP4 and H.264
Still image (Photograph)	In Photo mode, available resolutions are: 13 Megapixel (4800 x 2700) 9 Megapixel (4000 x 2250) 4 Megapixel (2688 x 1512)
	Format: DCF (JPEG)
Shutter	Electronic shutter Auto:1/2 ~1/2000 sec.
G-Sensor	3-Axis G-Force sensor
ISO	Auto
White Balance	Auto
Microphone	Yes
Speaker	Yes
Interface	Mini USB

Item	Description
Battery	Built-in 450 mAh Li-polymer rechargeable (This battery is NOT replaceable)
Operating Temperature	-10° ~ 60° C
Operating Humidity	20 ~ 70% RH
Storage Temperature	-20° ~ 80° C
Dimensions	284 x 100 x 45 mm
Weight	Approx. 371g