

# User Guide

© Copyright 2015 HP Development Company, L.P.

Bluetooth is a trademark owned by its proprietor and used by Hewlett-Packard Company under license. Intel, Celeron, and Pentium are trademarks of Intel Corporation in the U.S. and other countries. Microsoft and Windows are trademarks of the Microsoft group of companies.

The information contained herein is subject to change without notice. The only warranties for HP products and services are set forth in the express warranty statements accompanying such products and services. Nothing herein should be construed as constituting an additional warranty. HP shall not be liable for technical or editorial errors or omissions contained herein.

First Edition: August 2015

Document Part Number: 829782-001

### Product notice

This user guide describes features that are common to most models. Some features may not be available on your computer.

Not all features are available in all editions of Windows. This computer may require upgraded and/or separately purchased hardware, drivers and/or software to take full advantage of Windows functionality. Go to <http://www.microsoft.com> for details.

To access the latest user guide, go to <http://www.hp.com/support>, and select your country. Select **Drivers & Downloads**, and then follow the on-screen instructions.

### Software terms

By installing, copying, downloading, or otherwise using any software product preinstalled on this computer, you agree to be bound by the terms of the HP End User License Agreement (EULA). If you do not accept these license terms, your sole remedy is to return the entire unused product (hardware and software) within 14 days for a full refund subject to the refund policy of your seller.

For any further information or to request a full refund of the price of the computer, please contact your seller.

## Safety warning notice

---

 **WARNING!** To reduce the possibility of heat-related injuries or of overheating the computer, do not place the computer directly on your lap or obstruct the computer air vents. Use the computer only on a hard, flat surface. Do not allow another hard surface, such as an adjoining optional printer, or a soft surface, such as pillows or rugs or clothing, to block airflow. Also, do not allow the AC adapter to come into contact with the skin or a soft surface, such as pillows or rugs or clothing, during operation. The computer and the AC adapter comply with the user-accessible surface temperature limits defined by the International Standard for Safety of Information Technology Equipment (IEC 60950-1).

---



## Processor configuration setting (select models only)

---

 **IMPORTANT:** Select computer models are configured with an Intel® Pentium® N35xx/N37xx series or a Celeron® N28xx/N29xx/N30xx/N31xx series processor and a Windows® operating system. **If your computer is configured as described, do not change the processor configuration setting in msconfig.exe from 4 or 2 processors to 1 processor.** If you do so, your computer will not restart. You will have to perform a factory reset to restore the original settings.

---



---

# Table of contents

<b>1 Welcome</b> .....	<b>1</b>
Finding information .....	2
<b>2 Components</b> .....	<b>4</b>
Locating hardware .....	4
Locating software .....	4
Right .....	5
Left .....	8
Display .....	11
Top .....	14
TouchPad .....	14
Lights .....	15
Buttons, speakers, and fingerprint reader .....	17
Keys .....	20
Using the hot keys .....	22
Bottom .....	23
Front .....	27
Labels .....	28
Inserting a SIM card (select products only) .....	29
<b>3 Network connections</b> .....	<b>30</b>
Connecting to a wireless network .....	30
Using the wireless controls .....	30
Wireless button .....	30
Operating system controls .....	30
Connecting to a WLAN .....	31
Using HP Mobile Broadband (select products only) .....	31
Using HP Mobile Connect (select products only) .....	32
Using GPS (select products only) .....	32
Using Bluetooth wireless devices (select products only) .....	32
Connecting to a wired network .....	32
Connecting to a local area network (LAN) (select products only) .....	32
Using a modem (select products only) .....	33
Connecting a modem cable .....	33
Connecting a country- or region-specific modem cable adapter .....	34

<b>4 Screen navigation .....</b>	<b>35</b>
Using the TouchPad and touch screen gestures .....	35
Turning the TouchPad off and on .....	35
Tap .....	36
Two-finger pinch zoom .....	36
Two-finger scroll (TouchPad only) .....	36
Two-finger tap (TouchPad only) .....	37
One-finger slide (touch screen only) .....	37
<b>5 Entertainment features .....</b>	<b>38</b>
Using a webcam (select products only) .....	38
Using audio .....	38
Connecting speakers .....	38
Connecting headsets .....	38
Using sound settings .....	39
Using video .....	39
Connecting video devices by using a VGA cable .....	39
Connecting video devices using an HDMI cable .....	40
Setting up HDMI audio .....	41
<b>6 Power management .....</b>	<b>42</b>
Shutting down (turning off) the computer .....	42
Setting power options .....	42
Using power-saving states .....	42
Initiating and exiting Sleep .....	43
Enabling and exiting user-initiated Hibernation (select products only) .....	43
Using the power meter and power settings .....	43
Setting password protection on wakeup .....	44
Using battery power .....	44
Finding additional battery information .....	44
Using HP Battery Check .....	45
Displaying the remaining battery charge .....	45
Maximizing battery discharge time .....	45
Managing low battery levels .....	45
Identifying low battery levels .....	45
Resolving a low battery level .....	46
Removing the battery .....	46
Conserving battery power .....	47
Storing a battery .....	47
Disposing of a battery .....	48





Replacing a battery .....	48
Using external AC power .....	48
Testing an AC adapter .....	49
<b>7 Security .....</b>	<b>50</b>
Protecting the computer .....	50
Using passwords .....	51
Setting passwords in Windows .....	51
Setting passwords in Computer Setup .....	52
Managing a BIOS administrator password .....	52
Entering a BIOS administrator password .....	53
Managing a Computer Setup DriveLock password (select products only) .....	54
Setting a DriveLock password .....	54
Enabling DriveLock (select products only) .....	55
Disabling DriveLock (select products only) .....	55
Entering a DriveLock password (select products only) .....	56
Changing a DriveLock password (select products only) .....	56
Using Computer Setup Automatic DriveLock (select products only) .....	56
Entering an Automatic DriveLock password (select products only) .....	56
Removing Automatic DriveLock protection (select products only) .....	57
Using antivirus software .....	57
Using firewall software .....	57
Installing critical security updates .....	58
Using HP Client Security (select products only) .....	58
Using HP Touchpoint Manager (select products only) .....	58
Installing an optional security cable (select products only) .....	58
Using a fingerprint reader (select products only) .....	59
Locating the fingerprint reader .....	59
<b>8 Maintenance .....</b>	<b>60</b>
Improving performance .....	60
Using Disk Defragmenter .....	60
Using Disk Cleanup .....	60
Using HP 3D DriveGuard (select products only) .....	60
Identifying HP 3D DriveGuard status .....	61
Updating programs and drivers .....	61
Cleaning your computer .....	61
Cleaning procedures .....	61
Cleaning the display .....	62
Cleaning the sides or cover .....	62
Cleaning the TouchPad, keyboard, or mouse (select products only) .....	62

Traveling with or shipping your computer .....	62
<b>9 Backup and recovery .....</b>	<b>64</b>
Creating recovery media and backups .....	64
Creating HP Recovery media (select products only) .....	64
Using Windows tools .....	65
Restore and recovery .....	66
Recovering using HP Recovery Manager .....	66
What you need to know before you get started .....	66
Using the HP Recovery partition (select products only) .....	67
Using HP Recovery media to recover .....	67
Changing the computer boot order .....	68
Removing the HP Recovery partition (select products only) .....	68
<b>10 Computer Setup (BIOS), TPM, and HP Sure Start .....</b>	<b>69</b>
Using Computer Setup .....	69
Starting Computer Setup .....	69
Navigating and selecting in Computer Setup .....	69
Restoring factory settings in Computer Setup .....	70
Updating the BIOS .....	70
Determining the BIOS version .....	70
Downloading a BIOS update .....	71
Changing the boot order using the f9 prompt .....	72
TPM BIOS settings (select products only) .....	72
Using HP Sure Start (select products only) .....	72
<b>11 HP PC Hardware Diagnostics (UEFI) .....</b>	<b>73</b>
Downloading HP PC Hardware Diagnostics (UEFI) to a USB device .....	74
<b>12 Specifications .....</b>	<b>75</b>
Input power .....	75
Operating environment .....	75
<b>13 Electrostatic Discharge .....</b>	<b>76</b>
<b>14 Accessibility .....</b>	<b>77</b>
Supported assistive technologies .....	77
Contacting support .....	77
<b>Index .....</b>	<b>78</b>

---

# 1 Welcome

After you set up and register the computer, we recommend the following steps to get the most out of your smart investment:

-  **TIP:** To quickly return to the computer Start screen from an open app or the Windows desktop, press the Windows key  on your keyboard. Pressing the Windows key again will return you to the previous screen.
- **Connect to the Internet**—Set up your wired or wireless network so that you can connect to the Internet. For more information, see [Network connections on page 30](#).
- **Update your antivirus software**—Protect your computer from damage caused by viruses. The software is preinstalled on the computer. For more information, see [Using antivirus software on page 57](#).
- **Get to know your computer**—Learn about your computer features. See [Components on page 4](#) and [Screen navigation on page 35](#) for additional information.
- **Find installed software**—Access a list of the software preinstalled on the computer:  
Select the **Start** button, and then select **All apps**.  
— or —  
Right-click the **Start** button, and then select **Programs and Features**.
- Back up your hard drive by creating recovery discs or a recovery flash drive. See [Backup and recovery on page 64](#).

# Finding information

To locate resources that provide product details, how-to information, and more, use this table.

Resource	Contents
<i>Setup Instructions</i>	<ul style="list-style-type: none"><li>• Overview of computer setup and features</li></ul>
Get started app	<ul style="list-style-type: none"><li>• A broad range of how-to information and troubleshooting tips</li></ul>
To access the Get started app:	
▲ Select the <b>Start</b> button, and then select the <b>Get started app</b> .	
HP support	<ul style="list-style-type: none"><li>• Online chat with an HP technician</li></ul>
For U.S. support, go to <a href="http://www.hp.com/go/contactHP">http://www.hp.com/go/contactHP</a> . For worldwide support, go to <a href="http://welcome.hp.com/country/us/en/wwcontact_us.html">http://welcome.hp.com/country/us/en/wwcontact_us.html</a> .	<ul style="list-style-type: none"><li>• Support telephone numbers</li><li>• HP service center locations</li></ul>
<i>Safety &amp; Comfort Guide</i>	<ul style="list-style-type: none"><li>• Proper workstation setup</li></ul>
To access this guide:	
1. Type <code>support</code> in the taskbar search box, and then select the <b>HP Support Assistant</b> app.	
– or –	
Click the question mark icon in the taskbar.	
2. Select <b>My PC</b> , select the <b>Specifications</b> tab, and then select <b>User Guides</b> .	
– or –	
Go to <a href="http://www.hp.com/ergo">http://www.hp.com/ergo</a> .	
<i>Regulatory, Safety and Environmental Notices</i>	<ul style="list-style-type: none"><li>• Important regulatory notices, including information about proper battery disposal, if needed.</li></ul>
To access this document:	
1. Type <code>support</code> in the taskbar search box, and then select the <b>HP Support Assistant</b> app.	
– or –	
Click the question mark icon in the taskbar.	
2. Select <b>My PC</b> , select the <b>Specifications</b> tab, and then select <b>User Guides</b> .	
<i>Limited Warranty*</i>	<ul style="list-style-type: none"><li>• Specific warranty information about this computer</li></ul>
To access this document:	
1. Type <code>support</code> in the taskbar search box, and then select the <b>HP Support Assistant</b> app.	
– or –	
Click the question mark icon in the taskbar.	
2. Select <b>My PC</b> , and then select <b>Warranty and services</b> .	
– or –	

---

**Resource****Contents**

---

Go to <http://www.hp.com/go/orderdocuments>.

---

\*You can find your HP Limited Warranty located with the user guides on your product and/or on the CD or DVD provided in the box. In some countries or regions, HP may provide a printed warranty in the box. For countries or regions where the warranty is not provided in printed format, you can request a copy from <http://www.hp.com/go/orderdocuments>. For products purchased in Asia Pacific, you can write to HP at Hewlett Packard, POD, P.O. Box 200, Alexandra Post Office, Singapore 911507. Include your product name, and your name, phone number, and postal address.

---

---

## 2 Components

### Locating hardware

To find out what hardware is installed on your computer:

- ▲ Type `device manager` in the taskbar search box, and then select the **Device Manager** app.

A list displays all the devices installed on your computer.

For information about system hardware components and the system BIOS version number, press `fn+esc` (select products only).

### Locating software

To find out what software is installed on your computer:

- ▲ Select the **Start** button, and then select **All apps**.



– or –

Right-click the **Start** button, and then select **Programs and Features**.

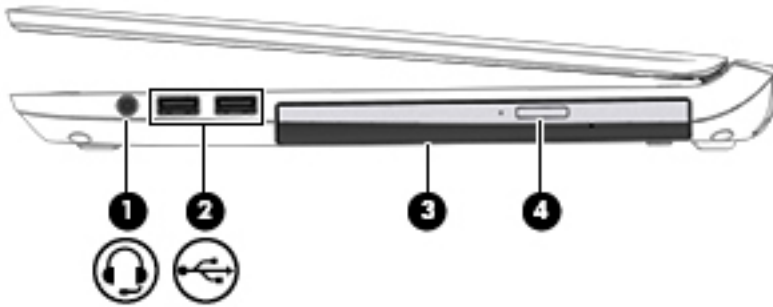

# Right

 **NOTE:** Refer to the illustration that most closely matches your computer.

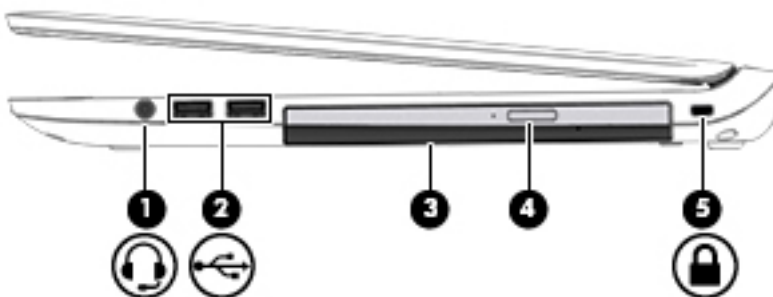

Component	Description
<b>(1)</b>  Audio-out (headphone)/Audio-in (microphone) combo jack	Connects optional powered stereo speakers, headphones, earbuds, a headset, or a television audio cable. Also connects an optional headset microphone. This jack does not support optional microphone-only devices.  <b>WARNING!</b> To reduce the risk of personal injury, adjust the volume before putting on headphones, earbuds, or a headset. For additional safety information, refer to the <i>Regulatory, Safety, and Environmental Notices</i> .  To access this guide: <ol style="list-style-type: none"> <li>Type <code>support</code> in the taskbar search box, and then select the <b>HP Support Assistant</b> app. – or – Click the question mark icon in the taskbar.</li> <li>Select <b>My PC</b>, select the <b>Specifications</b> tab, and then select <b>User Guides</b>.</li> </ol> <b>NOTE:</b> When a device is connected to the jack, the computer speakers are disabled.
<b>(2)</b>  USB 2.0 ports (2)	Connect an optional USB device, such as a keyboard, mouse, external drive, printer, scanner or USB hub.
<b>(3)</b> Optical drive (select products only)	Depending on your computer model, reads an optical disc or reads and writes to an optical disc.
<b>(4)</b> Optical drive eject button (select products only)	Releases the optical drive disc tray.



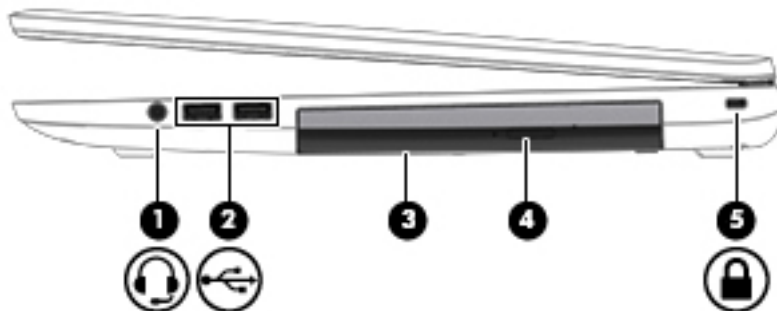

Component	Description
<b>(1)</b>  Audio-out (headphone)/Audio-in (microphone) combo jack	<p>Connects optional powered stereo speakers, headphones, earbuds, a headset, or a television audio cable. Also connects an optional headset microphone. This jack does not support optional microphone-only devices.</p> <p><b>WARNING!</b> To reduce the risk of personal injury, adjust the volume before putting on headphones, earbuds, or a headset. For additional safety information, refer to the <i>Regulatory, Safety, and Environmental Notices</i>.</p> <p>To access this guide:</p> <ol style="list-style-type: none"> <li>1. Type <code>support</code> in the taskbar search box, and then select the <b>HP Support Assistant</b> app.</li> <li>– or –</li> <li>Click the question mark icon in the taskbar.</li> <li>2. Select <b>My PC</b>, select the <b>Specifications</b> tab, and then select <b>User Guides</b>.</li> </ol> <p><b>NOTE:</b> When a device is connected to the jack, the computer speakers are disabled.</p>
<b>(2)</b>  USB 2.0 ports (2)	<p>Connect an optional USB device, such as a keyboard, mouse, external drive, printer, scanner or USB hub.</p>
<b>(3)</b> Optical drive (select products only)	<p>Depending on your computer model, reads an optical disc or reads and writes to an optical disc.</p>
<b>(4)</b> Optical drive eject button (select products only)	<p>Releases the optical drive disc tray.</p>
<b>(5)</b>  Security cable slot	<p>Attaches an optional security cable to the computer.</p> <p><b>NOTE:</b> The security cable is designed to act as a deterrent, but it may not prevent the computer from being mishandled or stolen.</p>



Component	Description
<b>(1)</b>  Audio-out (headphone)/Audio-in (microphone) combo jack	<p>Connects optional powered stereo speakers, headphones, earbuds, a headset, or a television audio cable. Also connects an optional headset microphone. This jack does not support optional microphone-only devices.</p>







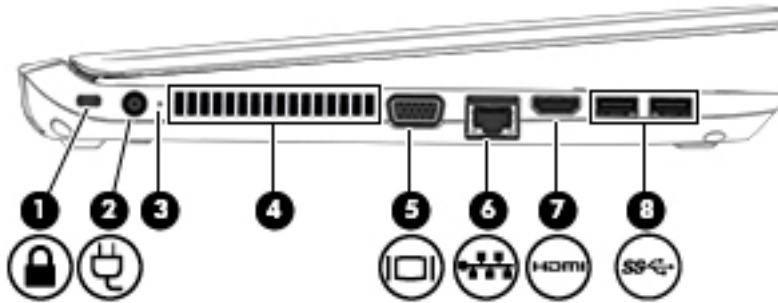

Component	Description
	<p><b>WARNING!</b> To reduce the risk of personal injury, adjust the volume before putting on headphones, earbuds, or a headset. For additional safety information, refer to the <i>Regulatory, Safety, and Environmental Notices</i>.</p> <p>To access this guide:</p> <ol style="list-style-type: none"> <li>1. Type <code>support</code> in the taskbar search box, and then select the <b>HP Support Assistant</b> app.</li> </ol> <p>– or –</p> <p>Click the question mark icon in the taskbar.</p> <ol style="list-style-type: none"> <li>2. Select <b>My PC</b>, select the <b>Specifications</b> tab, and then select <b>User Guides</b>.</li> </ol> <p><b>NOTE:</b> When a device is connected to the jack, the computer speakers are disabled.</p>
(2) 	<p>USB 2.0 ports (2)</p> <p>Connect an optional USB device, such as a keyboard, mouse, external drive, printer, scanner or USB hub.</p>
(3)	<p>Optical drive (select products only)</p> <p>Depending on your computer model, reads an optical disc or reads and writes to an optical disc.</p>
(4)	<p>Optical drive eject button (select products only)</p> <p>Releases the optical drive disc tray.</p>
(5) 	<p>Security cable slot</p> <p>Attaches an optional security cable to the computer.</p> <p><b>NOTE:</b> The security cable is designed to act as a deterrent, but it may not prevent the computer from being mishandled or stolen.</p>





# Left

 **NOTE:** Refer to the illustration that most closely matches your computer.

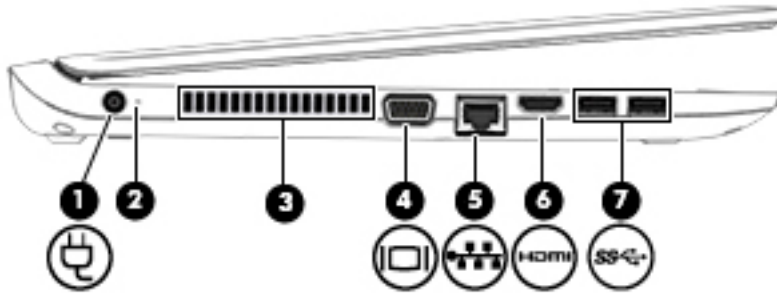





Component	Description
(1)  Security cable slot	Attaches an optional security cable to the computer. <b>NOTE:</b> The security cable is designed to act as a deterrent, but it may not prevent the computer from being mishandled or stolen.
(2)  Power connector	Connects an AC adapter.
(3) Battery light	When AC power is connected: <ul style="list-style-type: none"> <li>• White: The battery charge is greater than 90 percent.</li> <li>• Amber: The battery charge is from 0 to 90 percent.</li> <li>• Off: The battery is not charging.</li> </ul> When AC power is disconnected (battery not charging): <ul style="list-style-type: none"> <li>• Blinking amber: The battery has reached a low battery level. When the battery has reached a critical battery level, the battery light begins blinking rapidly.</li> <li>• Off: The battery is not charging.</li> </ul>
(4) Vent	Enables airflow to cool internal components. <b>NOTE:</b> The computer fan starts up automatically to cool internal components and prevent overheating. It is normal for the internal fan to cycle on and off during routine operation.
(5)  External monitor port	Connects an external VGA monitor or projector.
(6)  RJ-45 (network) jack/status lights	Connects a network cable. <ul style="list-style-type: none"> <li>• Green (right): The network is connected.</li> <li>• Amber (left): Activity is occurring on the network.</li> </ul>
(7)  HDMI port	Connects an optional video or audio device, such as a high-definition television, any compatible digital or audio component, or a high-speed High Definition Multimedia Interface (HDMI) device.
(8)  USB 3.0 ports (2)	Connect an optional USB device, such as a keyboard, mouse, external drive, printer, scanner or USB hub.

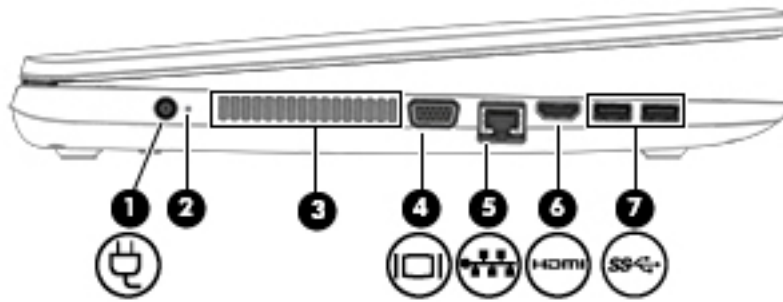

Component	Description
(1) 	Connects an AC adapter.
(2) Battery light	<p>When AC power is connected:</p> <ul style="list-style-type: none"> <li>• White: The battery charge is greater than 90 percent.</li> <li>• Amber: The battery charge is from 0 to 90 percent.</li> <li>• Off: The battery is not charging.</li> </ul> <p>When AC power is disconnected (battery not charging):</p> <ul style="list-style-type: none"> <li>• Blinking amber: The battery has reached a low battery level. When the battery has reached a critical battery level, the battery light begins blinking rapidly.</li> <li>• Off: The battery is not charging.</li> </ul>
(3) Vent	<p>Enables airflow to cool internal components.</p> <p><b>NOTE:</b> The computer fan starts up automatically to cool internal components and prevent overheating. It is normal for the internal fan to cycle on and off during routine operation.</p>
(4) 	Connects an external VGA monitor or projector.
(5) 	<p>Connects a network cable.</p> <ul style="list-style-type: none"> <li>• Green (right): The network is connected.</li> <li>• Amber (left): Activity is occurring on the network.</li> </ul>
(6) 	Connects an optional video or audio device, such as a high-definition television, any compatible digital or audio component, or a high-speed High Definition Multimedia Interface (HDMI) device.
(7) 	Connect an optional USB device, such as a keyboard, mouse, external drive, printer, scanner or USB hub.



Component	Description
(1) 	Power connector Connects an AC adapter.
(2)	Battery light When AC power is connected: <ul style="list-style-type: none"> <li>• White: The battery charge is greater than 90 percent.</li> <li>• Amber: The battery charge is from 0 to 90 percent.</li> <li>• Off: The battery is not charging.</li> </ul> When AC power is disconnected (battery not charging): <ul style="list-style-type: none"> <li>• Blinking amber: The battery has reached a low battery level. When the battery has reached a critical battery level, the battery light begins blinking rapidly.</li> <li>• Off: The battery is not charging.</li> </ul>
(3)	Vent Enables airflow to cool internal components. <b>NOTE:</b> The computer fan starts up automatically to cool internal components and prevent overheating. It is normal for the internal fan to cycle on and off during routine operation.
(4) 	External monitor port Connects an external VGA monitor or projector.
(5) 	RJ-45 (network) jack/status lights Connects a network cable. <ul style="list-style-type: none"> <li>• Green (right): The network is connected.</li> <li>• Amber (left): Activity is occurring on the network.</li> </ul>
(6) 	HDMI port Connects an optional video or audio device, such as a high-definition television, any compatible digital or audio component, or a high-speed High Definition Multimedia Interface (HDMI) device.
(7) 	USB 3.0 ports (2) Connect an optional USB device, such as a keyboard, mouse, external drive, printer, scanner or USB hub.

# Display

 **NOTE:** Refer to the illustration that most closely matches your computer.



Component	Description
(1) WLAN antennas (2)* (select products only)	Send and receive wireless signals to communicate with wireless local area networks (WLANs).
(2) WWAN antennas (2)* (select products only)	Send and receive wireless signals to communicate with wireless wide area networks (WWANs).
(3) Internal microphones (2) (select products only)	Record sound.
(4) Webcam light (select products only)	On: The webcam is in use.
(5) Webcam (select products only)	Records video and captures photographs. Some models allow you to video conference and chat online using streaming video.  To use the webcam: <ul style="list-style-type: none"><li>▲ Type <code>camera</code> in the taskbar search box, and then select <b>Camera</b>.</li></ul>

\*The antennas are not visible from the outside of the computer. For optimal transmission, keep the areas immediately around the antennas free from obstructions.

For wireless regulatory notices, see the section of the *Regulatory, Safety, and Environmental Notices* that applies to your country or region.

To access this guide:

1. Type `support` in the taskbar search box, and then select the **HP Support Assistant** app.  
– or –  
Click the question mark icon in the taskbar.
2. Select **My PC**, select the **Specifications** tab, and then select **User Guides**.

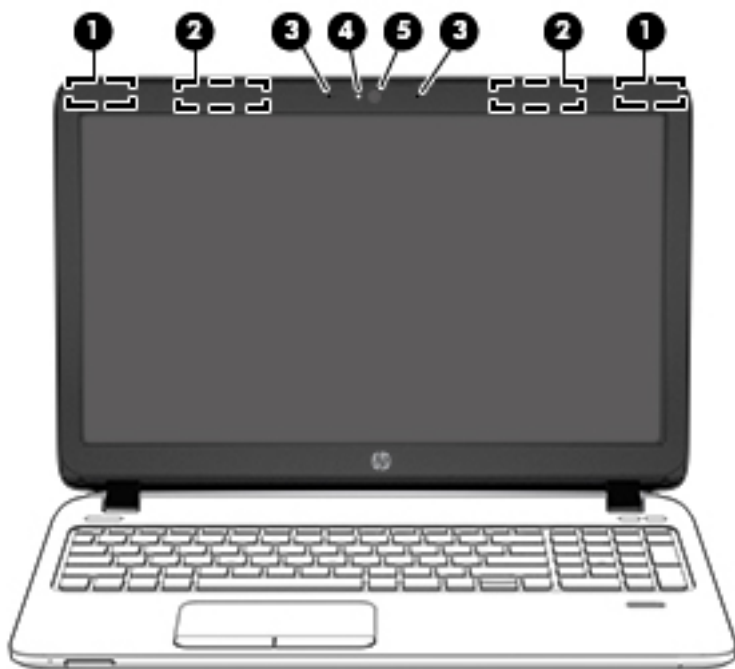

Component	Description
(1) WLAN antennas (2)* (select products only)	Send and receive wireless signals to communicate with wireless local area networks (WLANs).
(2) WWAN antennas (2)* (select products only)	Send and receive wireless signals to communicate with wireless wide area networks (WWANs).
(3) Internal microphones (2) (select products only)	Record sound.
(4) Webcam light (select products only)	On: The webcam is in use.
(5) Webcam (select products only)	Records video and captures photographs. Some models allow you to video conference and chat online using streaming video.  To use the webcam:  ▲ Type <b>camera</b> in the taskbar search box, and then select <b>Camera</b> .

\*The antennas are not visible from the outside of the computer. For optimal transmission, keep the areas immediately around the antennas free from obstructions.

For wireless regulatory notices, see the section of the *Regulatory, Safety, and Environmental Notices* that applies to your country or region.

To access this guide:

1. Type **support** in the taskbar search box, and then select the **HP Support Assistant** app.

– or –

Click the question mark icon in the taskbar.

2. Select **My PC**, select the **Specifications** tab, and then select **User Guides**.

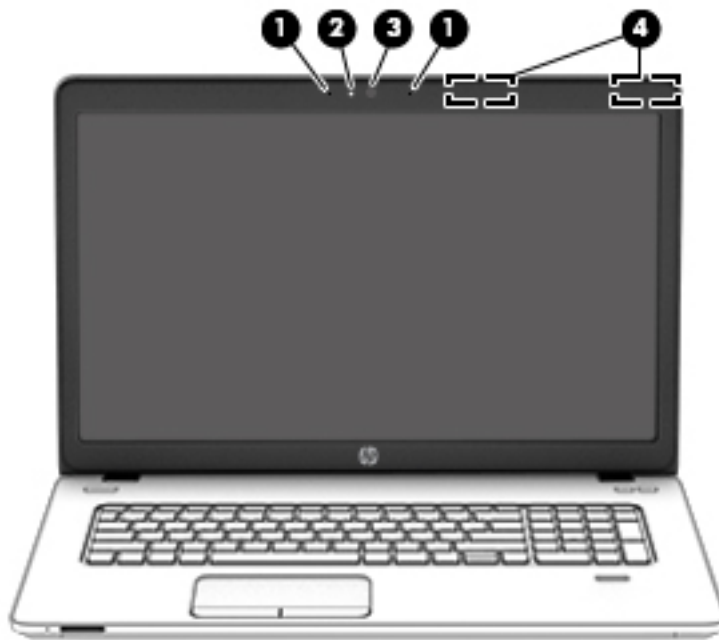

Component	Description
(1) Internal microphones (2)	Record sound.
(2) Webcam light	On: The webcam is in use.
(3) Webcam	Records video and captures photographs. Some models allow you to video conference and chat online using streaming video.  To use the webcam:  ▲ Type <code>camera</code> in the taskbar search box, and then select <b>Camera</b> .
(4) WLAN antennas (2)* (select products only)	Send and receive wireless signals to communicate with wireless local area networks (WLANs).

\*The antennas are not visible from the outside of the computer. For optimal transmission, keep the areas immediately around the antennas free from obstructions.

For wireless regulatory notices, see the section of the *Regulatory, Safety, and Environmental Notices* that applies to your country or region.

To access this guide:

1. Type `support` in the taskbar search box, and then select the **HP Support Assistant** app.  
– or –  
Click the question mark icon in the taskbar.
2. Select **My PC**, select the **Specifications** tab, and then select **User Guides**.

# Top

## TouchPad

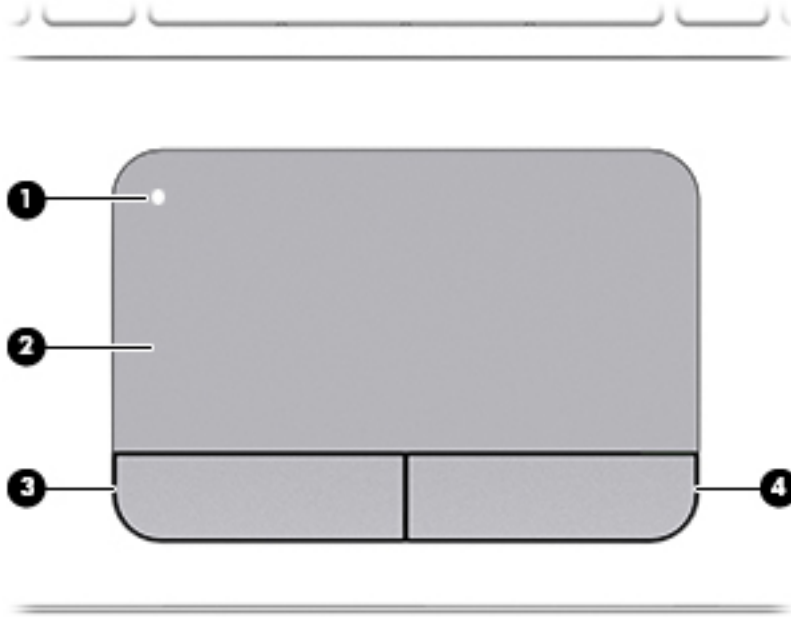





Component		Description
(1)	TouchPad on/off button	Turns the TouchPad on and off.
(2)	TouchPad zone	Reads your finger gestures to move the pointer or activate items on the screen.
(3)	Left TouchPad button	Functions like the left button on an external mouse.
(4)	Right TouchPad button	Functions like the right button on an external mouse.



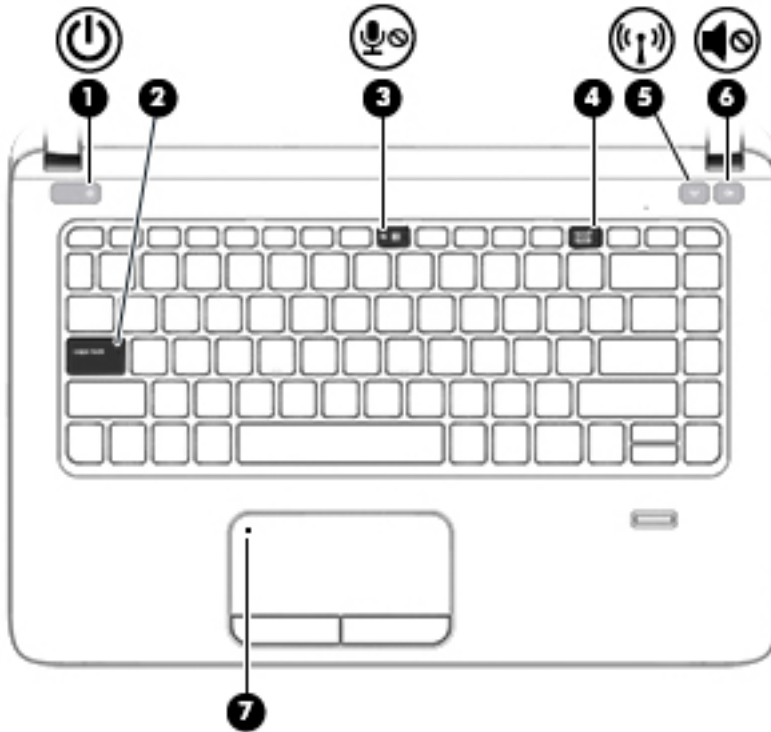



## Lights

 **NOTE:** Refer to the illustration that most closely matches your computer.

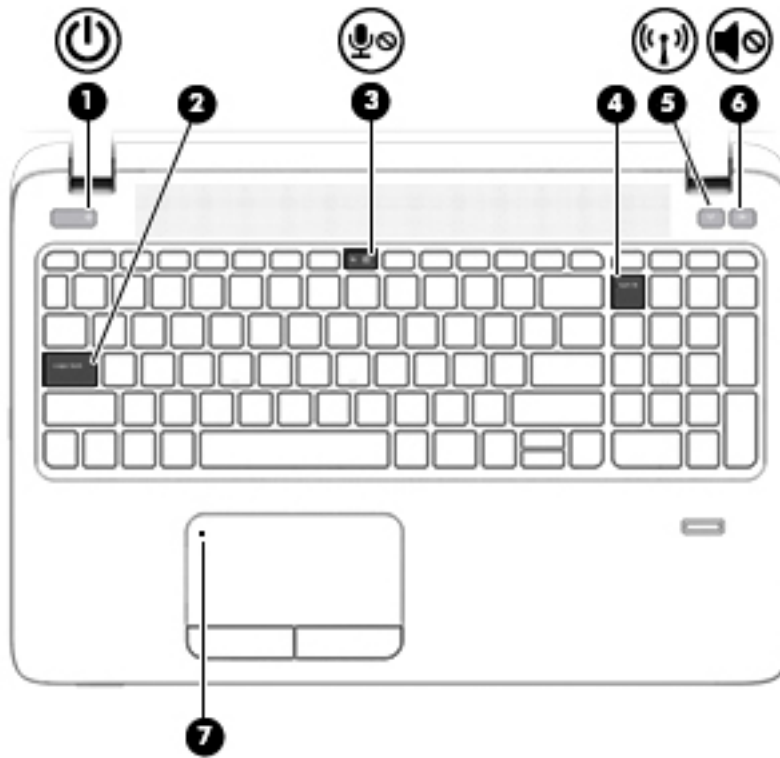

Component	Description
(1)  Power light	<ul style="list-style-type: none"> <li>On: The computer is on.</li> <li>Blinking: The computer is in the Sleep state, a power-saving state. The computer shuts off power to the display and other unneeded components.</li> <li>Off: The computer is off or in Hibernation. Hibernation is a power-saving state that uses the least amount of power.</li> </ul>
(2) Caps lock light	On: Caps lock is on, which switches the key input to all capital letters.
(3)  Microphone mute light	<ul style="list-style-type: none"> <li>Amber: microphone sound is off.</li> <li>Off: microphone sound is on.</li> </ul>
(4) Num lock light	On: Num lock is on.
(5)  Wireless light	<p>White: An integrated wireless device, such as a wireless local area network (WLAN) device and/or a Bluetooth® device, is on.</p> <p><b>NOTE:</b> On some models, the wireless light is amber when all wireless devices are off.</p>
(6)  Mute light	<ul style="list-style-type: none"> <li>Amber: Computer sound is off.</li> <li>White: Computer sound is on.</li> </ul>
(7) TouchPad light	<ul style="list-style-type: none"> <li>Amber: The TouchPad is off.</li> <li>Off: The TouchPad is on.</li> </ul>





Component	Description
(1)  Power light	<ul style="list-style-type: none"> <li>On: The computer is on.</li> <li>Blinking: The computer is in the Sleep state, a power-saving state. The computer shuts off power to the display and other unneeded components.</li> <li>Off: The computer is off or in Hibernation. Hibernation is a power-saving state that uses the least amount of power.</li> </ul>
(2) Caps lock light	On: Caps lock is on, which switches the key input to all capital letters.
(3)  Microphone mute light	<ul style="list-style-type: none"> <li>Amber: microphone sound is off.</li> <li>Off: microphone sound is on.</li> </ul>
(4) Num lock light	On: Num lock is on.
(5)  Wireless light	<p>White: An integrated wireless device, such as a wireless local area network (WLAN) device and/or a Bluetooth® device, is on.</p> <p><b>NOTE:</b> On some models, the wireless light is amber when all wireless devices are off.</p>
(6)  Mute light	<ul style="list-style-type: none"> <li>Amber: Computer sound is off.</li> <li>White: Computer sound is on.</li> </ul>
(7) TouchPad light	<ul style="list-style-type: none"> <li>Amber: The TouchPad is off.</li> <li>Off: The TouchPad is on.</li> </ul>

## Buttons, speakers, and fingerprint reader

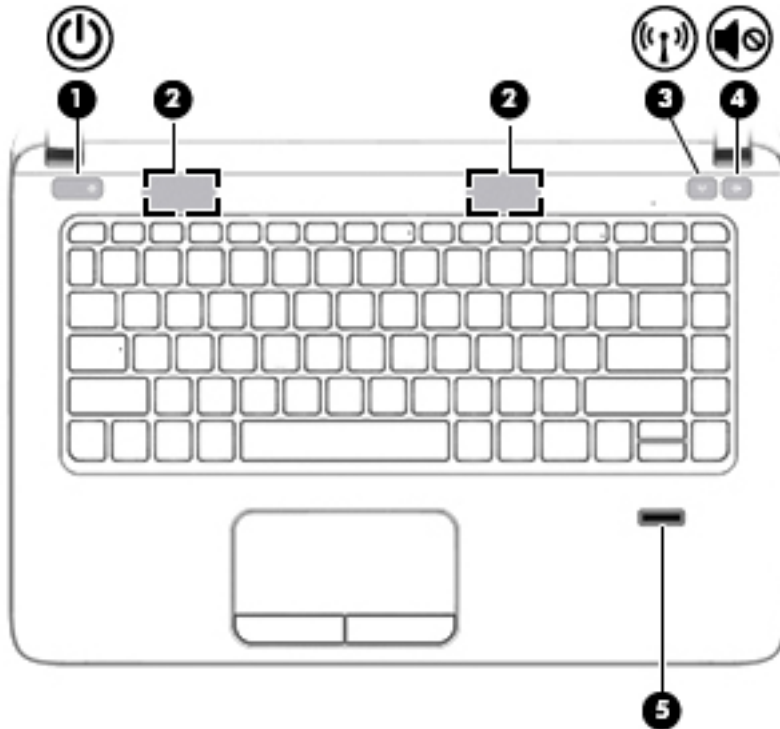
 **NOTE:** Refer to the illustration that most closely matches your computer.



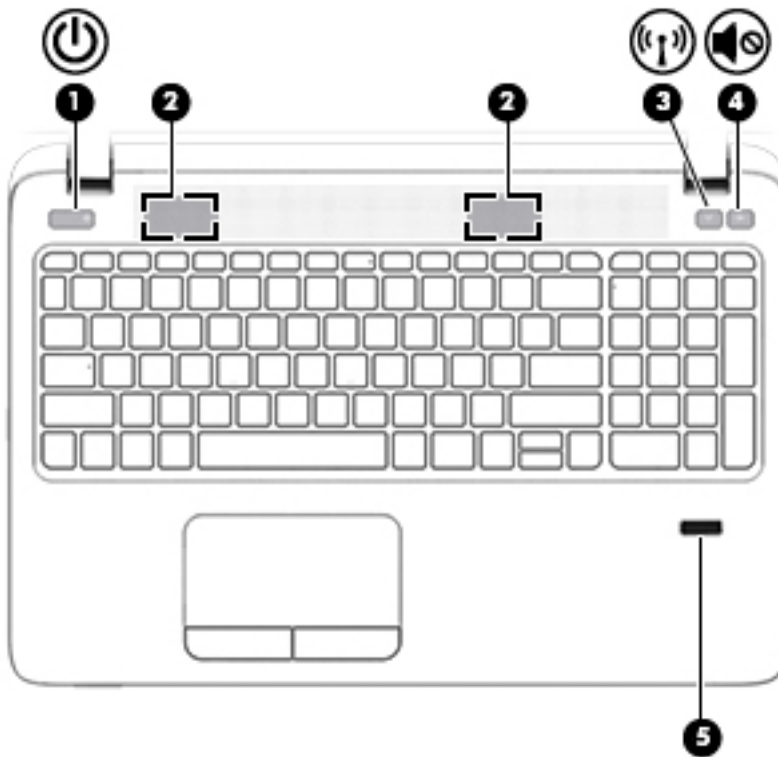

Component	Description
(1)  Power button	<ul style="list-style-type: none"> <li>• When the computer is off, press the button to turn on the computer.</li> <li>• When the computer is on, press the button briefly to initiate Sleep.</li> <li>• When the computer is in the Sleep state, press the button briefly to exit Sleep.</li> <li>• When the computer is in Hibernation, press the button briefly to exit Hibernation.</li> </ul> <p><b>CAUTION:</b> Pressing and holding down the power button results in the loss of unsaved information.</p> <p>If the computer has stopped responding and shutdown procedures are ineffective, press and hold the power button for at least 5 seconds to turn off the computer.</p> <p>To learn more about your power settings, see your power options.</p> <p>▲ Type <code>power</code> in the taskbar search box, and then select <b>Power and sleep settings</b>.</p> <p>– or –</p> <p>Right-click the <b>Start</b> button, and then select <b>Power Options</b>.</p>
(2) Speakers (2)	Produce sound.

Component	Description
(3)  Wireless button	Turns the wireless feature on or off but does not establish a wireless connection.  A wireless network must be set up before a wireless connection is possible.
(4)  Volume mute button	Mutes and restores speaker sound.
(5) Fingerprint reader (select products only)	Allows a fingerprint logon to Windows, instead of a password logon.





Component	Description
(1)  Power button	<ul style="list-style-type: none"> <li>When the computer is off, press the button to turn on the computer.</li> <li>When the computer is on, press the button briefly to initiate Sleep.</li> <li>When the computer is in the Sleep state, press the button briefly to exit Sleep.</li> <li>When the computer is in Hibernation, press the button briefly to exit Hibernation.</li> </ul> <p><b>CAUTION:</b> Pressing and holding down the power button results in the loss of unsaved information.</p> <p>If the computer has stopped responding and shutdown procedures are ineffective, press and hold the power button for at least 5 seconds to turn off the computer.</p>

Component	Description
	<p>To learn more about your power settings, see your power options.</p> <ul style="list-style-type: none"> <li>▲ Type <code>power</code> in the taskbar search box, and then select <b>Power and sleep settings</b>.</li> </ul> <p>– or –</p> <p>Right-click the <b>Start</b> button, and then select <b>Power Options</b>.</p>
(2) Speakers (2)	Produce sound.
(3)  Wireless button	<p>Turns the wireless feature on or off but does not establish a wireless connection.</p> <p>A wireless network must be set up before a wireless connection is possible.</p>
(4)  Volume mute button	Mutes and restores speaker sound.
(5) Fingerprint reader (select products only)	Allows a fingerprint logon to Windows, instead of a password logon.

## Keys

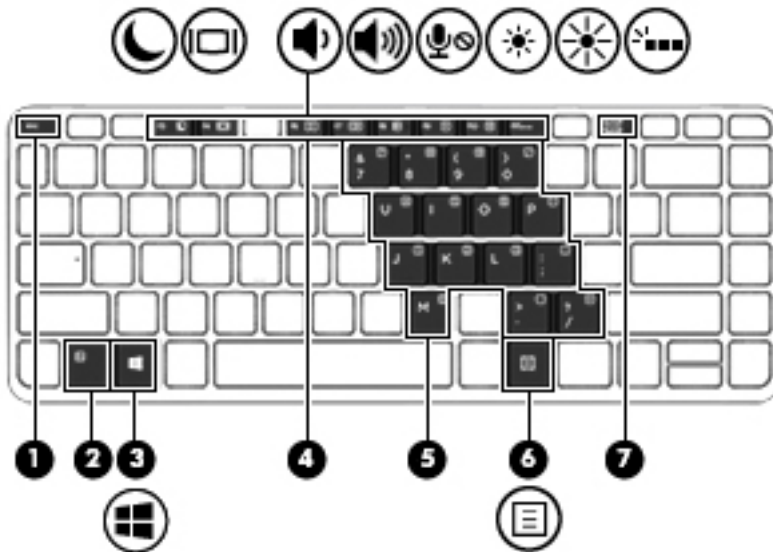
 **NOTE:** Refer to the illustration that most closely matches your computer.



Component	Description
(1) <code>esc</code> key	Displays system information when pressed in combination with the <code>fn</code> key.
(2) <code>fn</code> key	Executes frequently used system functions when pressed in combination with a function key, the <code>num lock</code> key, or the <code>esc</code> key.  See <a href="#">Using the hot keys on page 22</a>
(3)  Windows key	Opens the <b>Start</b> menu.  <b>NOTE:</b> Pressing the Windows key again will close the <b>Start</b> menu.
(4) Function keys	Execute frequently used system functions when pressed in combination with the <code>fn</code> key.
(5) Embedded numeric keypad	A numeric keypad superimposed over the keyboard alphabet keys that enables you to add, subtract, and perform other numeric tasks. When <code>num lock</code> is on, the keypad can be used like an external numeric keypad.
(6)  Windows application key	Displays options for a selected object.
(7) <code>num lock</code> key	Turns the embedded numeric keypad on and off.

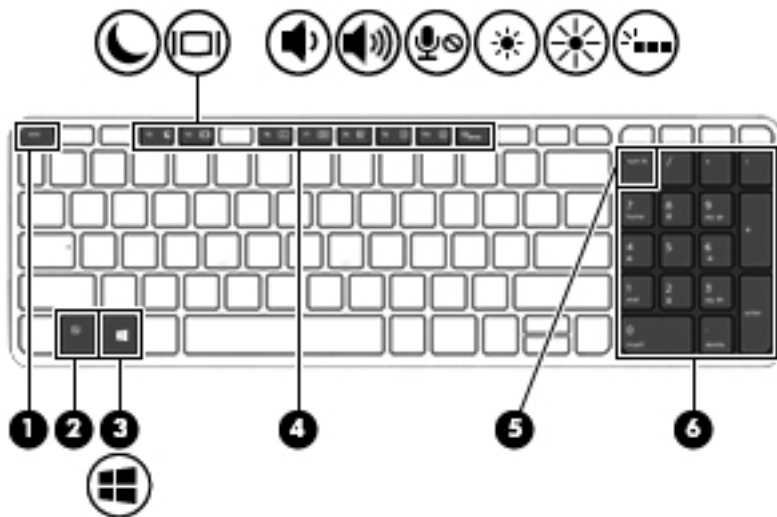









Component	Description
(1) <a href="#">esc</a> key	Displays system information when pressed in combination with the <a href="#">fn</a> key.
(2) <a href="#">fn</a> key	Executes frequently used system functions when pressed in combination with a function key, the <a href="#">num lock</a> key, or the <a href="#">esc</a> key.  See <a href="#">Using the hot keys on page 22</a>
(3)  Windows key	Opens the <b>Start</b> menu.  <b>NOTE:</b> Pressing the Windows key again will close the <b>Start</b> menu.
(4) Function keys	Execute frequently used system functions when pressed in combination with the <a href="#">fn</a> key.
(5) <a href="#">num lock</a> key	Turns the integrated numeric keypad on and off.
(6) Integrated numeric keypad	A separate keypad to the right of the alphabet keyboard that enables you to add, subtract, and perform other numeric tasks. When <a href="#">num lock</a> is on, the integrated keypad can be used like an external numeric keypad.

## Using the hot keys

To use a hot key:

- ▲ Press the **fn** key, and then press the correct function key represented by the icons below.



Press <b>fn</b> +function key	Description
	<p>Initiates Sleep, which saves your information in system memory. The display and other system components turn off and power is conserved.</p> <p>To exit Sleep, briefly press the power button.</p> <p><b>CAUTION:</b> To reduce the risk of information loss, save your work before initiating Sleep.</p>
	<p>Switches the screen image among display devices connected to the system. For example, if a monitor is connected to the computer via the optional docking device, <b>fn+f4</b> alternates the screen image from computer display to monitor display to simultaneous display on both the computer and the monitor.</p> <p>Most external monitors receive video information on the computer using the external VGA video standard. The <b>fn+f4</b> hot key can also alternate images among other devices that are receiving video information on the computer.</p>
	<p>Decreases speaker volume incrementally while you hold down the key.</p>
	<p>Increases speaker volume incrementally while you hold down the key.</p>
	<p>Mutes the microphone.</p>
	<p>Decreases the screen brightness incrementally as long as you hold down the key.</p>
	<p>Increases the screen brightness incrementally as long as you hold down the key.</p>
	<p>Turns the backlight keyboard (select products only) off or on.</p> <p><b>NOTE:</b> To conserve battery power, turn off this feature.</p>

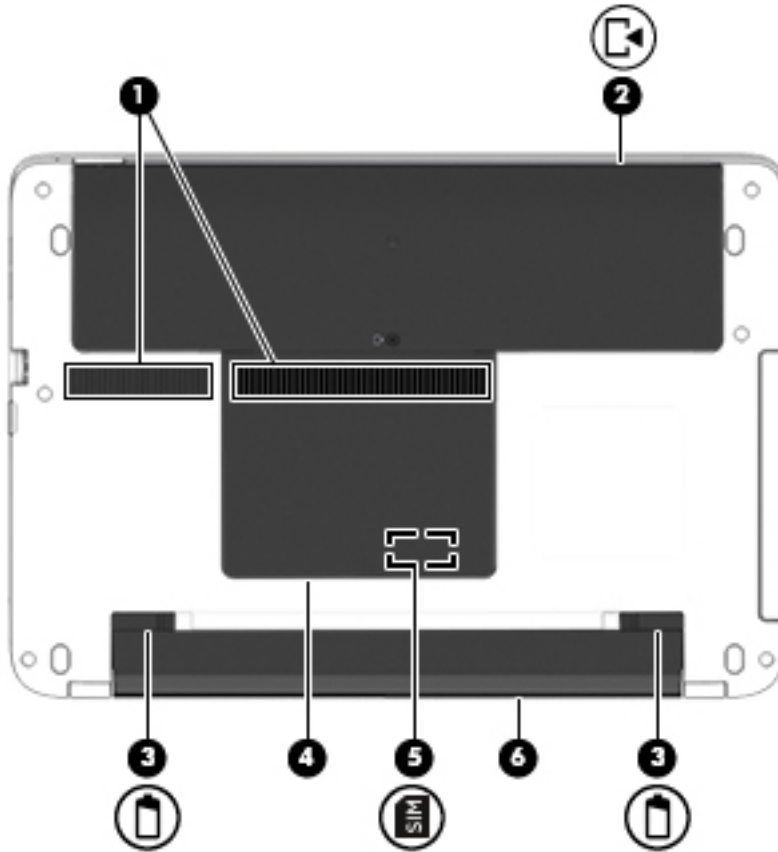

# Bottom

 **NOTE:** Refer to the illustration that most closely matches your computer.





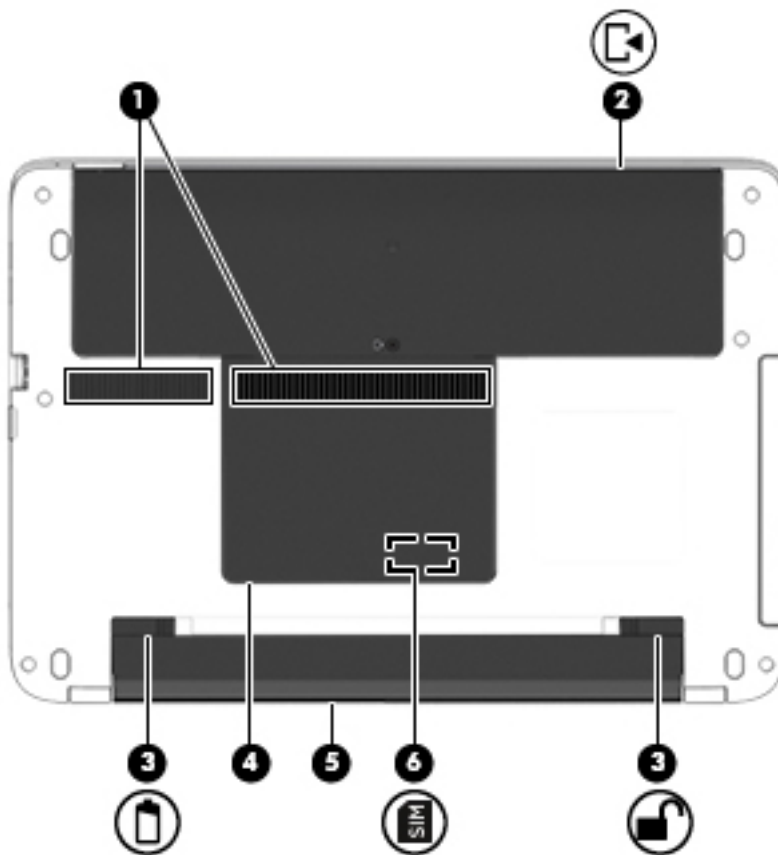

Component	Description
(1) Vents (2)	Enable airflow to cool internal components. <b>NOTE:</b> The computer fan starts up automatically to cool internal components and prevent overheating. It is normal for the internal fan to cycle on and off during routine operation.
(2)  Service door	Provides access to the hard drive bay and the memory module slots.
(3)  Battery release latches (2)	Release the battery.
(4) Service door	Provides access to the wireless LAN (WLAN) module slot, the WWAN module slot, and SIM slot.



Component	Description
	<p><b>CAUTION:</b> To prevent an unresponsive system, replace the wireless module only with a wireless module authorized for use in the computer by the governmental agency that regulates wireless devices in your country or region. If you replace the module and then receive a warning message, remove the module to restore computer functionality, and then contact support.</p> <p>▲ Type <code>support</code> in the taskbar search box, and then select the <b>HP Support Assistant</b> app.</p> <p>- or -</p> <p>Click the question mark icon in the taskbar.</p>
(5) 	<p>SIM card slot (select products only)</p> <p>Supports a wireless subscriber identity module (SIM) card. The SIM card slot is located under the service door.</p>
(6)	<p>Battery bay</p> <p>Holds the battery.</p>

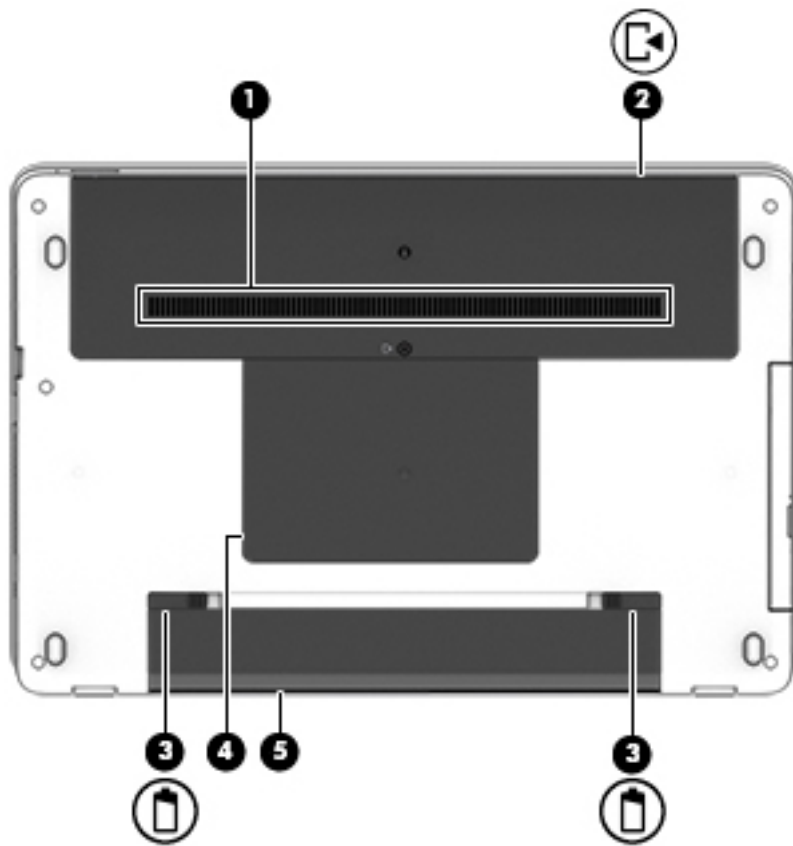

Component	Description
(1)	<p>Vents (2)</p> <p>Enable airflow to cool internal components.</p> <p><b>NOTE:</b> The computer fan starts up automatically to cool internal components and prevent overheating. It is normal for the internal fan to cycle on and off during routine operation.</p>

Component	Description
(2) 	Service door Provides access to the hard drive bay and the memory module slots.
(3) 	Battery release latch Releases the battery.
	Battery lock latch Locks the battery in the battery bay.
(4)	Service door Provides access to the wireless LAN (WLAN) module slot, the WWAN module slot, and SIM slot.  <b>CAUTION:</b> To prevent an unresponsive system, replace the wireless module only with a wireless module authorized for use in the computer by the governmental agency that regulates wireless devices in your country or region. If you replace the module and then receive a warning message, remove the module to restore computer functionality, and then contact support.  ▲ Type <code>support</code> in the taskbar search box, and then select the <b>HP Support Assistant</b> app.  - or -  Click the question mark icon in the taskbar.
(5)	Battery bay Holds the battery.
(6) 	SIM card slot (select products only) Supports a wireless subscriber identity module (SIM) card. The SIM card slot is located under the service door.



Component		Description
(1)	Vent	Enables airflow to cool internal components.  <b>NOTE:</b> The computer fan starts up automatically to cool internal components and prevent overheating. It is normal for the internal fan to cycle on and off during routine operation.
(2)	 Service door	Provides access to the hard drive bay and the memory module slots.
(3)	 Battery release latches (2)	Release the battery.
(4)	Service door	Provides access to the wireless LAN (WLAN) module slot and the WWAN module slot.

Component	Description
	<p><b>CAUTION:</b> To prevent an unresponsive system, replace the wireless module only with a wireless module authorized for use in the computer by the governmental agency that regulates wireless devices in your country or region. If you replace the module and then receive a warning message, remove the module to restore computer functionality, and then contact support.</p> <p>▲ Type <code>support</code> in the taskbar search box, and then select the <b>HP Support Assistant</b> app.</p> <p>- or -</p> <p>Click the question mark icon in the taskbar.</p>
(5)	<p>Battery bay</p> <p>Holds the battery.</p>

## Front



Component	Description
(1)	<p>Drive light</p> <ul style="list-style-type: none"> <li>Blinking white: The hard drive is being accessed.</li> <li>Amber: HP 3D DriveGuard has temporarily parked the hard drive.</li> </ul> <p><b>NOTE:</b> For more information about HP 3D DriveGuard, see <a href="#">Using HP 3D DriveGuard (select products only) on page 60</a>.</p>
(2)	<p>Memory card reader</p> <p>Reads optional memory cards that store, manage, share, or access information.</p>

# Labels

The labels affixed to the computer provide information you may need when you troubleshoot system problems or travel internationally with the computer.

**IMPORTANT:** Check the following locations for the labels described in this section: the bottom of the computer, inside the battery bay, under the service door, or on the back of the display.

- Service label—Provides important information to identify your computer. When contacting support, you will probably be asked for the serial number, and possibly for the product number or the model number. Locate these numbers before you contact support.

Your service label will resemble one of the examples shown below. Refer to the illustration that most closely matches the service label on your computer.



## Component

- (1) Serial number
- (2) Product number
- (3) Warranty period
- (4) Model number (select products only)

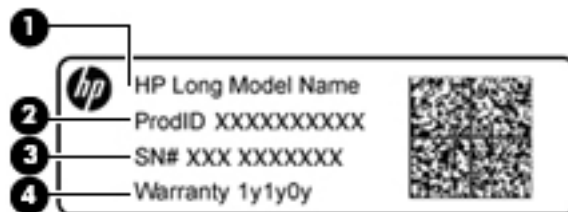

## Component

- (1) Model name (select products only)
- (2) Product number
- (3) Serial number
- (4) Warranty period

- Regulatory label(s)—Provide(s) regulatory information about the computer.
- Wireless certification label(s)—Provide(s) information about optional wireless devices and the approval markings for the countries or regions in which the devices have been approved for use.

## Inserting a SIM card (select products only)

**CAUTION:** To prevent damage to the connectors, use minimal force when inserting a SIM card.

To insert a SIM card, follow these steps:

1. Turn off the computer by using the Shut down command.
2. Close the display.
3. Disconnect all external devices connected to the computer.
4. Unplug the power cord from the AC outlet.
5. Turn the computer upside down on a flat surface, with the battery bay toward you.
6. Remove the battery.
7. Remove the smaller service door.
8. Insert the SIM card into the SIM card slot, and then press in on the SIM card until it is firmly seated.

**NOTE:** See the image below to determine which way the SIM should be inserted into your computer.

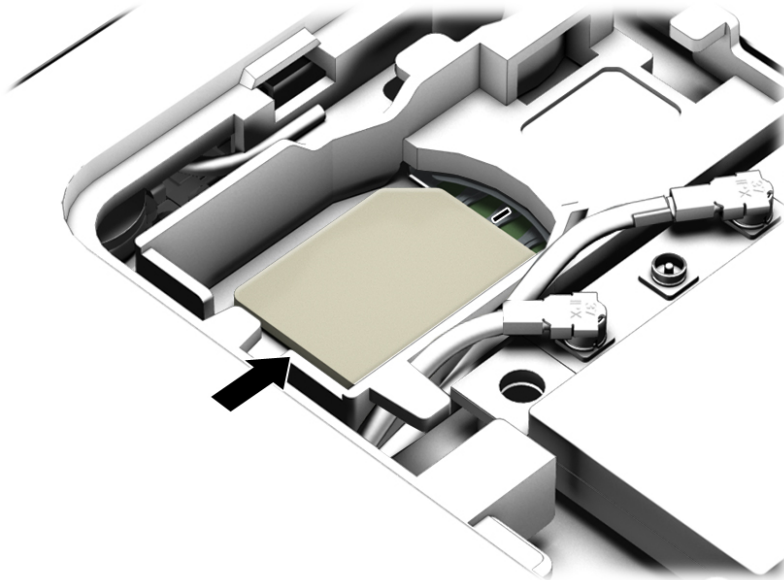

9. Replace the service door.
10. Insert the battery.

**NOTE:** HP Mobile Broadband will be disabled if the battery is not replaced.

11. Reconnect external power.
12. Reconnect external devices.
13. Turn on the computer.

To remove a SIM card, press in on the SIM card, and then remove it from the slot.

---

## 3 Network connections

Your computer can travel with you wherever you go. But even at home, you can explore the globe and access information from millions of websites using your computer and a wired or wireless network connection. This chapter will help you get connected to that world.

### Connecting to a wireless network

Your computer may be equipped with one or more of the following wireless devices:

- **WLAN device**—Connects the computer to wireless local area networks (commonly referred to as Wi-Fi networks, wireless LANs, or WLANs) in corporate offices, your home, and public places such as airports, restaurants, coffee shops, hotels, and universities. In a WLAN, the mobile wireless device in your computer communicates with a wireless router or a wireless access point.
- **HP Mobile Broadband Module (select products only)**—A wireless wide area network (WWAN) device that gives you wireless connectivity over a much larger area. Mobile network operators install base stations (similar to cell phone towers) throughout large geographic areas, effectively providing coverage across entire states, regions, or even countries.
- **Bluetooth device**—Creates a personal area network (PAN) to connect to other Bluetooth-enabled devices such as computers, phones, printers, headsets, speakers, and cameras. In a PAN, each device communicates directly with other devices, and devices must be relatively close together—typically within 10 meters (approximately 33 feet) of each other.

### Using the wireless controls

You can control the wireless devices in your computer using one or more of these features:

- **Wireless button (also called airplane mode key or wireless key)** (referred to in this chapter as wireless button)
- **Operating system controls**

#### Wireless button

The computer may have a wireless button, one or more wireless devices, and one or two wireless lights. All the wireless devices on your computer are enabled at the factory.

The wireless light indicates the overall power state of your wireless devices, not the status of individual devices.

#### Operating system controls

The Network and Sharing Center allows you to set up a connection or network, connect to a network, and diagnose and repair network problems.

To use operating system controls:

1. Type `control panel` in the taskbar search box, and then select **Control Panel**.
2. Select **Network and Internet**, and then select **Network and Sharing Center**.



## Connecting to a WLAN

---

 **NOTE:** When you are setting up Internet access in your home, you must establish an account with an Internet service provider (ISP). To purchase Internet service and a modem, contact a local ISP. The ISP will help set up the modem, install a network cable to connect your wireless router to the modem, and test the Internet service.

---

To connect to a WLAN, follow these steps:

1. Be sure that the WLAN device is on.
2. Select the network status icon in the taskbar, and then connect to one of the available networks.

If the WLAN is a security-enabled WLAN, you are prompted to enter a security code. Enter the code, and then select **Next** to complete the connection.

---

 **NOTE:** If no WLANs are listed, you may be out of range of a wireless router or access point.

 **NOTE:** If you do not see the WLAN you want to connect to, right-click the network status icon in the taskbar, and then select **Open Network and Sharing Center**. Select **Set up a new connection or network**. A list of options is displayed, allowing you to manually search for and connect to a network or to create a new network connection.

---

3. Follow the on-screen instructions to complete the connection.

After the connection is made, select the network status icon at the far right of the taskbar, to verify the name and status of the connection.

---

 **NOTE:** The functional range (how far your wireless signals travel) depends on WLAN implementation, router manufacturer, and interference from other electronic devices or structural barriers such as walls and floors.

---

## Using HP Mobile Broadband (select products only)

Your HP Mobile Broadband computer has built-in support for mobile broadband service. Your new computer, when used with a mobile operator's network, gives you the freedom to connect to the Internet, send e-mail, or connect to your corporate network without the need for Wi-Fi hotspots.

---

 **NOTE:** If your computer includes HP Mobile Connect, the instructions in this section do not apply. See [Using HP Mobile Connect \(select products only\) on page 32](#).

---

You might need the HP Mobile Broadband Module IMEI and/or MEID number to activate mobile broadband service. The number may be printed on a label located on the bottom of your computer, inside the battery bay, under the service door, or on the back of the display.

– Or –

You can find the number following these steps:

1. From the taskbar, select the network status icon.
2. Select **View Connection Settings**.
3. Under the **Mobile broadband** section, select the network status icon.

Some mobile network operators require the use of a SIM card. A SIM card contains basic information about you, such as a personal identification number (PIN), as well as network information. Some computers include a SIM card that is preinstalled. If the SIM card is not preinstalled, it may be provided in the HP Mobile Broadband information provided with your computer or the mobile network operator may provide it separately from the computer.

For information about HP Mobile Broadband and how to activate service with a preferred mobile network operator, see the HP Mobile Broadband information included with your computer.

## Using HP Mobile Connect (select products only)

HP Mobile Connect is a prepaid, mobile broadband service that provides a cost-effective, secure, simple, and flexible mobile broadband connection for your computer. To use HP Mobile Connect, your computer must have a SIM card and the **HP Mobile Connect** app. For more information about HP Mobile Connect and where it is available, go to <http://www.hp.com/go/mobileconnect>.

## Using GPS (select products only)

Your computer may be equipped with a Global Positioning System (GPS) device. GPS satellites deliver location, speed, and direction information to GPS-equipped systems.

For more information, see the HP GPS and Location software Help.

## Using Bluetooth wireless devices (select products only)

A Bluetooth device provides short-range wireless communications that replace the physical cable connections that traditionally link electronic devices such as the following:

- Computers (desktop, notebook)
- Phones (cellular, cordless, smart phone)
- Imaging devices (printer, camera)
- Audio devices (headset, speakers)
- Mouse

Bluetooth devices provide peer-to-peer capability that allows you to set up a personal area network (PAN) of Bluetooth devices. For information about configuring and using Bluetooth devices, see the Bluetooth software Help.

## Connecting to a wired network

Select products may allow wired connections: local area network (LAN) and modem connection. A LAN connection uses a network cable and is much faster than a modem, which uses a telephone cable. Both cables are sold separately.

---

**⚠ WARNING!** To reduce the risk of electric shock, fire, or damage to the equipment, do not plug a modem cable or telephone cable into an RJ-45 (network) jack.

---

## Connecting to a local area network (LAN) (select products only)

Use a LAN connection if you want to connect the computer directly to a router in your home (instead of working wirelessly), or if you want to connect to an existing network at your office.

Connecting to a LAN requires an 8-pin, RJ-45 network cable.

To connect the network cable, follow these steps:

1. Plug the network cable into the network jack **(1)** on the computer.

2. Plug the other end of the network cable into a network wall jack **(2)** or router.

 **NOTE:** If the network cable contains noise suppression circuitry **(3)**, which prevents interference from TV and radio reception, orient the circuitry end of the cable toward the computer.

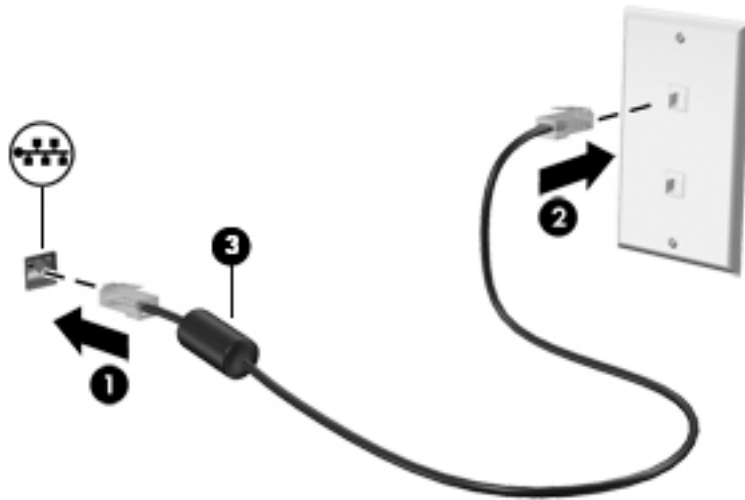

## Using a modem (select products only)

A modem must be connected to an analog telephone line using a 6-pin, RJ-11 modem cable. In some countries or regions, a specific modem cable adapter is also required. Jacks for digital PBX systems may resemble analog telephone jacks, but they are not compatible with the modem.

### Connecting a modem cable

To connect the modem cable, follow these steps:

1. Plug the modem cable into the modem jack **(1)** on the computer.
2. Plug the modem cable into the RJ-11 telephone wall jack **(2)**.

 **NOTE:** If the modem cable contains noise suppression circuitry **(3)**, which prevents interference from TV and radio reception, orient the circuitry end of the cable toward the computer.

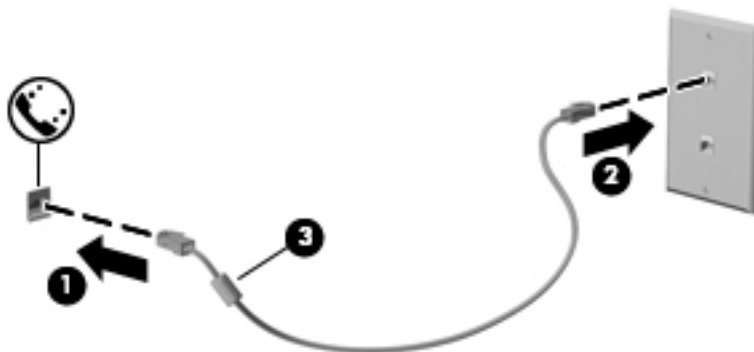

## Connecting a country- or region-specific modem cable adapter

Telephone jacks vary by country or region. To use the modem and the modem cable outside the country or region in which you purchased the computer, you must obtain a country- or region-specific modem cable adapter.

To connect the modem to an analog telephone line that does not have an RJ-11 telephone jack, follow these steps:

1. Plug the modem cable into the modem jack **(1)** on the computer.
2. Plug the modem cable into the modem cable adapter **(2)**.
3. Plug the modem cable adapter **(3)** into the telephone wall jack.

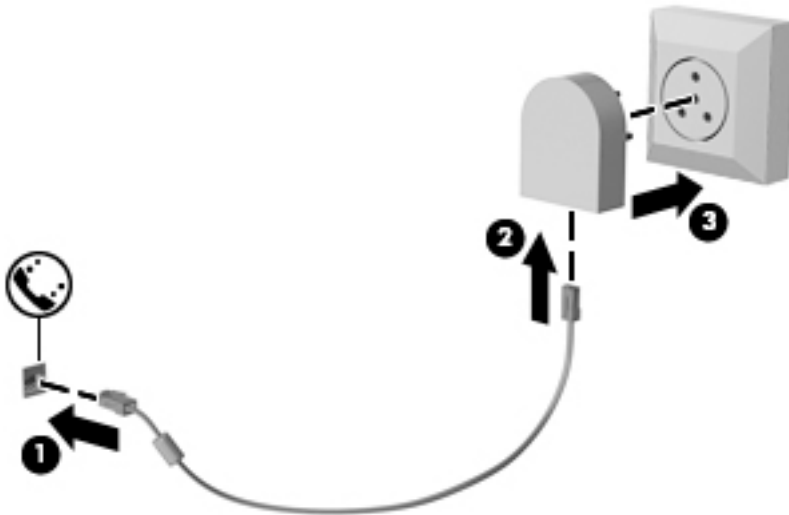

---

## 4 Screen navigation

You can navigate the computer screen in the following ways:

- Use touch gestures directly on the computer screen (select products only)
- Use touch gestures on the TouchPad
- Use keyboard and optional mouse (mouse purchased separately)
- Use the pointing stick (select products only)

### Using the TouchPad and touch screen gestures

The TouchPad helps you navigate the computer screen and control the pointer using simple touch gestures. You can also use the left and right TouchPad buttons as you would use the corresponding buttons on an external mouse. To navigate a touch screen (select products only), touch the screen directly using gestures described in this chapter.

You can also customize gestures and view demonstrations of how they work. Type `control panel` in the taskbar search box, select **Control Panel**, and then select **Hardware and Sound**. Under **Devices and Printers**, select **Mouse**.

---

 **NOTE:** Unless noted, gestures can be used on the TouchPad or a touch screen (select products only).

---

### Turning the TouchPad off and on

To turn the TouchPad off and on, quickly double-tap the TouchPad on/off button.

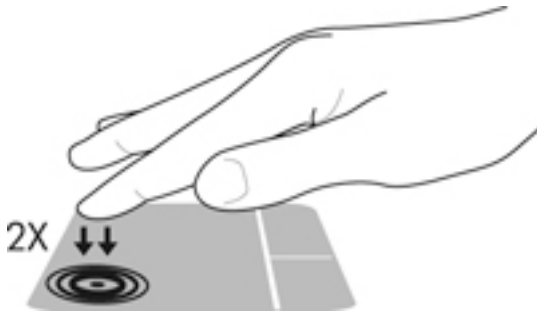

## Tap

Use the tap/double-tap gesture to select or open an item on the screen.

- Point to an item on the screen, and then tap one finger on the TouchPad zone or touch screen to select the item. Double-tap an item to open it.



## Two-finger pinch zoom

Use the two-finger pinch zoom to zoom out or in on images or text.

- Zoom out by placing two fingers apart on the TouchPad zone or touch screen and then moving your fingers together.
- Zoom in by placing two fingers together on the TouchPad zone or touch screen and then moving your fingers apart.



## Two-finger scroll (TouchPad only)

Use the two-finger scroll to move up, down, or sideways on a page or image.

- Place two fingers slightly apart on the TouchPad zone and then drag them up, down, left, or right.

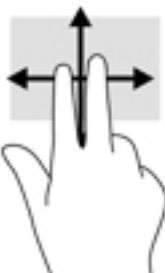

## Two-finger tap (TouchPad only)

Use the two-finger tap to open the menu for an object on the screen.

 **NOTE:** The two-finger tap performs the same function as right-clicking with the mouse.

- Tap two fingers on the TouchPad zone to open the options menu for the selected object.



## One-finger slide (touch screen only)

Use the one-finger slide to pan or scroll through lists and pages, or to move an object.

- To scroll across the screen, lightly slide one finger across the screen in the direction you want to move.
- To move an object, press and hold your finger on an object, and then drag your finger to move the object.

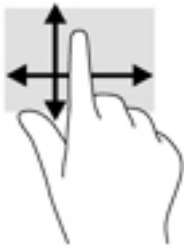

---

## 5 Entertainment features

Use your HP computer for business or pleasure to meet with others via the webcam, mix audio and video, or connect external devices like a projector, monitor, TV, or speakers. See [Components on page 4](#) to locate the audio, video and camera features on your computer.

### Using a webcam (select products only)

Your computer has a webcam (integrated camera) that records video and captures photographs. Some models allow you to video conference and chat online using streaming video.

- ▲ To access the camera, type `camera` in the taskbar search box, and then select **Camera** from the list of applications.

### Using audio

You can download and listen to music, stream audio content (including radio) from the web, record audio, or mix audio and video to create multimedia. You can also play music CDs on the computer (on select models) or attach an external optical drive to play CDs. To enhance your listening enjoyment, attach headphones or speakers.

### Connecting speakers

You can attach wired speakers to your computer by connecting them to a USB port or to the audio-out (headphone)/audio-in (microphone) combo jack on your computer or on a docking station.

To connect wireless speakers to your computer, follow the device manufacturer's instructions. To connect high-definition speakers to the computer, see [Setting up HDMI audio on page 41](#). Before connecting speakers, lower the volume setting.

### Connecting headsets

---

 **WARNING!** To reduce the risk of personal injury, lower the volume setting before putting on headphones, earbuds, or a headset. For additional safety information, see the *Regulatory, Safety and Environmental Notices*.

To access this document:

1. Type `support` in the taskbar search box, and then select the **HP Support Assistant** app.  
– or –  
Click the question mark icon in the taskbar.
  2. Select **My PC**, select the **Specifications** tab, and then select **User Guides**.
- 

Headphones combined with a microphone are called headsets. You can connect wired headsets to the audio-out (headphone)/audio-in (microphone) combo jack on your computer.

To connect wireless headsets to your computer, follow the device manufacturer's instructions.



## Using sound settings

Use sound settings to adjust system volume, change system sounds, or manage audio devices.

To view or change sound settings:

- ▲ Type `control panel` in the taskbar search box, select **Control Panel**, select **Hardware and Sound**, and then select **Sound**.

– or –

Right-click the **Start** button, select **Control Panel**, select **Hardware and Sound**, and then select **Sound**.

Your computer may include an enhanced sound system by Bang & Olufsen, DTS, Beats audio, or another provider. As a result, your computer may include advanced audio features that can be controlled through an audio control panel specific to your audio system.

Use the audio control panel to view and control audio settings.

- ▲ Type `control panel` in the taskbar search box, select **Control Panel**, select **Hardware and Sound**, and then select the audio control panel specific to your system.

– or –

Right-click the **Start** button, select **Control Panel**, select **Hardware and Sound**, and then select the audio control panel specific to your system.

## Using video

Your computer is a powerful video device that enables you to watch streaming video from your favorite websites and download video and movies to watch on your computer when you are not connected to a network.

To enhance your viewing enjoyment, use one of the video ports on the computer to connect an external monitor, projector, or TV.



---

**IMPORTANT:** Be sure that the external device is connected to the correct port on the computer, using the correct cable. Follow the device manufacturer's instructions.

---

For information on using your video features, refer to HP Support Assistant.

## Connecting video devices by using a VGA cable



---

**NOTE:** To connect a VGA video device to your computer, you need a VGA cable, purchased separately.

---

To see the computer screen image on an external VGA monitor or projected for a presentation, connect a monitor or projector to the computer's VGA port.

1. Connect the VGA cable from the monitor or projector to the VGA port on the computer as shown.

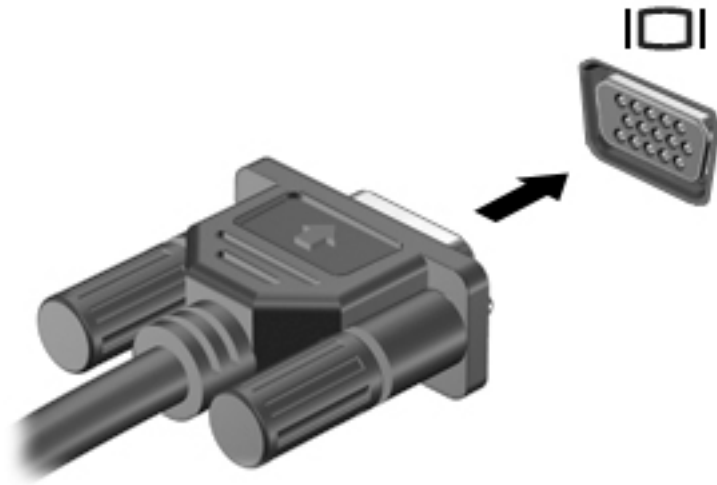

2. Press **fn+f4** to alternate the screen image between 4 display states:

- **PC screen only:** View the screen image on the computer only.
- **Duplicate:** View the screen image simultaneously on both the computer and the external device.
- **Extend:** View the screen image extended across both the computer and the external device.
- **Second screen only:** View the screen image on the external device only.

Each time you press **fn+f4**, the display state changes.

---

 **NOTE:** For best results, especially if you choose the "Extend" option, increase the screen resolution of the external device, as follows. Type `control panel` in the taskbar search box, select **Control Panel**, select **Appearance and Personalization**. Under **Display**, select **Adjust resolution**.

---

## Connecting video devices using an HDMI cable

---

 **NOTE:** To connect an HDMI device to your computer, you need an HDMI cable, purchased separately.

---

To see the computer screen image on a high-definition TV or monitor, connect the high-definition device according to the following instructions:

1. Connect one end of the HDMI cable to the HDMI port on the computer.

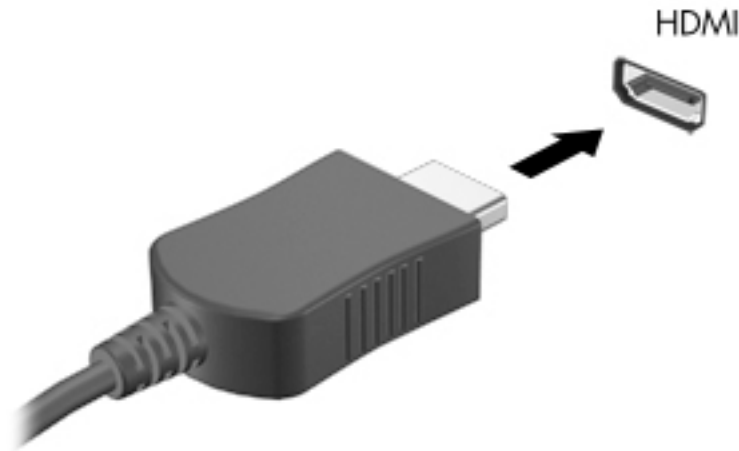

2. Connect the other end of the cable to the high-definition TV or monitor.
3. Press **fn+f4** to alternate the computer screen image between 4 display states:
  - **PC screen only:** View the screen image on the computer only.
  - **Duplicate:** View the screen image simultaneously on both the computer and the external device.
  - **Extend:** View the screen image extended across both the computer and the external device.
  - **Second screen only:** View the screen image on the external device only.

Each time you press **fn+f4**, the display state changes.

 **NOTE:** For best results, especially if you choose the "Extend" option, increase the screen resolution of the external device, as follows. Type `control panel` in the taskbar search box, select **Control Panel**, select **Appearance and Personalization**. Under **Display**, select **Adjust resolution**.

## Setting up HDMI audio

HDMI is the only video interface that supports high-definition video and audio. After you connect an HDMI TV to the computer, you can then turn on HDMI audio by following these steps:

1. Right-click the **Speakers** icon in the notification area, at the far right of the taskbar, and then select **Playback devices**.
2. On the **Playback** tab, select the name of the digital output device.
3. Click **Set Default**, and then click **OK**.

To return the audio stream to the computer speakers:

1. Right-click the **Speakers** icon in the notification area, at the far right of the taskbar, and then click **Playback devices**.
2. On the Playback tab, click **Speakers**.
3. Click **Set Default**, and then click **OK**.

---

# 6 Power management

 **NOTE:** A computer may have a power button or a power switch. The term *power button* is used throughout this guide to mean both types of power controls.

---

## Shutting down (turning off) the computer

 **CAUTION:** Unsaved information is lost when the computer shuts down.

---

The shutdown command closes all open programs, including the operating system, and then turns off the display and computer.

Shut down the computer under any of the following conditions:

- When you need to replace the battery or access components inside the computer
- When you are connecting an external hardware device that does not connect to a Universal Serial Bus (USB) port
- When the computer will be unused and disconnected from external power for an extended period

Although you can turn off the computer with the power button, the recommended procedure is to use the Windows shutdown command:

 **NOTE:** If the computer is in the Sleep state or in Hibernation, you must first exit Sleep or Hibernation before shutdown is possible by briefly pressing the power button.

---

1. Save your work and close all open programs.
2. Select the **Start** button, select the **Power** icon, and then select **Shut down**.

If the computer is unresponsive and you are unable to use the preceding shutdown procedure, try the following emergency procedures in the sequence provided:

- Press **ctrl+alt+delete**. Select the **Power** icon, and then select **Shut Down**.
- Press and hold the power button for at least 5 seconds.
- Disconnect the computer from external power.
- Remove the battery.

## Setting power options

### Using power-saving states

Sleep is enabled at the factory. When Sleep is initiated, the power lights blink and the screen clears. Your work is saved to memory.

 **CAUTION:** To reduce the risk of possible audio and video degradation, loss of audio or video playback functionality, or loss of information, do not initiate Sleep while reading from or writing to a disc or an external memory card.

 **NOTE:** You cannot initiate any type of networking connection or perform any computer functions while the computer is in the Sleep state.

---

## Initiating and exiting Sleep

With the computer on, you can initiate Sleep in any of the following ways:

- Briefly press the power button.
- Select the **Start** button, select the **Power** icon, and then select **Sleep**.

From the Start screen, point to the upper-right or lower-right corner of the screen. When the charms list opens, click **Settings**, click the **Power** icon, and then click **Sleep**.

To exit Sleep, briefly press the power button.

When the computer exits Sleep, the power lights turn on and the computer returns to the screen where you stopped working.



**NOTE:** If you have set a password to be required on wakeup, you must enter your Windows password before the computer will return to the screen.

## Enabling and exiting user-initiated Hibernation (select products only)

You can enable user-initiated Hibernation and change other power settings and timeouts using Power Options:

1. Type `power options` in the taskbar search box, and then select **Power Options**.

– or –

Right-click the **Power meter** icon , and then select **Power Options**.

2. In the left pane, select **Choose what the power buttons do**.
3. Select **Change Settings that are currently unavailable**, and then, in the **When I press the power button** or **When I press the sleep button** area, select **Hibernate**.

– or –

Under **Shutdown settings**, select the **Hibernate** box to show the Hibernate option in the Power menu.

4. Select **Save changes**.



To exit Hibernation, briefly press the power button. The power lights turn on and your work returns to the screen where you stopped working.



**NOTE:** If you have set a password to be required on wakeup, you must enter your Windows password before your work will return to the screen.

## Using the power meter and power settings

The power meter is located on the Windows desktop. The power meter allows you to quickly access power settings and view the remaining battery charge.

- To view the percentage of remaining battery charge and the current power plan, place the mouse pointer over the power meter icon .
- To use Power Options, right-click the power meter icon , and then select an item from the list. You can also type `power options` in the task bar search box, and then select **Power Options**.

Different power meter icons indicate whether the computer is running on battery or external power. The icon also reveals a message if the battery has reached a low or critical battery level.

## Setting password protection on wakeup

To set the computer to prompt for a password when the computer exits Sleep or Hibernation, follow these steps:

1. Type `power options` in the taskbar search box, and then select **Power Options**.

– or –

Right-click the **Power meter icon** , and then select **Power Options**.

2. In the left pane, select **Require a password on wakeup**.
3. Select **Change Settings that are currently unavailable**.
4. Select **Require a password (recommended)**.

---

 **NOTE:** To create a user account password or change your current user account password, select **Create or change your user account password**, and then follow the on-screen instructions. If you do not need to create or change a user account password, go to step 5.

---

5. Select **Save changes**.

## Using battery power

---

 **WARNING!** To reduce potential safety issues, use only the battery provided with the computer, a replacement battery provided by HP, or a compatible battery purchased from HP.

---

The computer runs on battery power whenever it is not plugged into external AC power. Computer battery life varies, depending on power management settings, running programs, display brightness, external devices connected to the computer, and other factors. Keeping the battery in the computer whenever the computer is plugged into AC power charges the battery and also protects your work in case of a power outage. If the computer contains a charged battery and is running on external AC power, the computer automatically switches to battery power if the AC adapter is disconnected on the computer or an AC power loss occurs.

---

 **NOTE:** When you disconnect AC power, the display brightness is automatically decreased to save battery life. Select computer products can switch between graphic modes to increase battery life.

---

## Finding additional battery information

To access battery information:

1. Type `support` in the taskbar search box, and then select the **HP Support Assistant app**.

– or –

Click the question mark icon in the taskbar.

2. Select **My PC**, select the **Diagnostics and Tools** tab, and then select **HP Battery Check**. If HP Battery Check indicates that your battery should be replaced, contact support.

HP Support Assistant provides the following tools and information about the battery.

- Battery Check tool to test battery performance
- Information on calibration, power management, and proper care and storage to maximize battery life
- Information on battery types, specifications, life cycles, and capacity

## Using HP Battery Check

HP Support Assistant provides information on the status of the battery installed in the computer.

To run HP Battery Check:

1. Connect the AC adapter to the computer.



**NOTE:** The computer must be connected to external power for HP Battery Check to work properly.

2. Type `support` in the taskbar search box, and then select the **HP Support Assistant** app.

– or –

Click the question mark icon in the taskbar.

3. Select **My PC**, select the **Diagnostics and Tools** tab, and then select **HP Battery Check**. If HP Battery Check indicates that your battery should be replaced, contact support.

HP Battery Check examines the battery and its cells to see if they are functioning properly, and then reports the results of the examination.

## Displaying the remaining battery charge



Move the pointer over the **Power meter** icon .

## Maximizing battery discharge time

Battery discharge time varies depending on features you use while on battery power. Maximum discharge time gradually decreases as the battery storage capacity naturally degrades.

Tips for maximizing battery discharge time:

- Lower the brightness on the display.
- Remove the battery on the computer when it is not being used or charged.
- Store the battery in a cool, dry location.
- Select the **Power saver** setting in Power Options.

## Managing low battery levels

The information in this section describes the alerts and system responses set at the factory. Some low-battery alerts and system responses can be changed using Power Options. Preferences set using Power Options do not affect lights.

Type `power options` in the taskbar search box, and then select **Power Options**.

## Identifying low battery levels

When a battery that is the sole power source for the computer reaches a low or critical battery level, the following behavior occurs:

- The battery light (select products only) indicates a low or critical battery level.

– or –

- The **Power meter** icon  shows a low or critical battery notification.

If the computer is on or in the Sleep state, the computer remains briefly in the Sleep state and then shuts down and loses any unsaved information.

## Resolving a low battery level

### Resolving a low battery level when external power is available

- ▲ Connect one of the following devices:
  - AC adapter
  - Optional docking or expansion device
  - Optional power adapter purchased as an accessory from HP

### Resolving a low battery level when no power source is available

To resolve a low battery level when no power source is available, save your work and shut down the computer.

## Removing the battery

 **NOTE:** Refer to the illustration that most closely matches your computer.

To remove the battery (with lock latch):

 **CAUTION:** Removing a battery that is the sole power source for the computer can cause loss of information. To prevent loss of information, save your work and shut down the computer through Windows before removing the battery.

1. Turn the computer upside down on a flat surface, with the battery bay toward you.
2. Slide the battery lock latch **(1)** to unlock the battery, and then slide the battery release latch **(2)** to release the battery.
3. Pivot the battery **(3)** upward, and then remove the battery **(4)** from the computer.

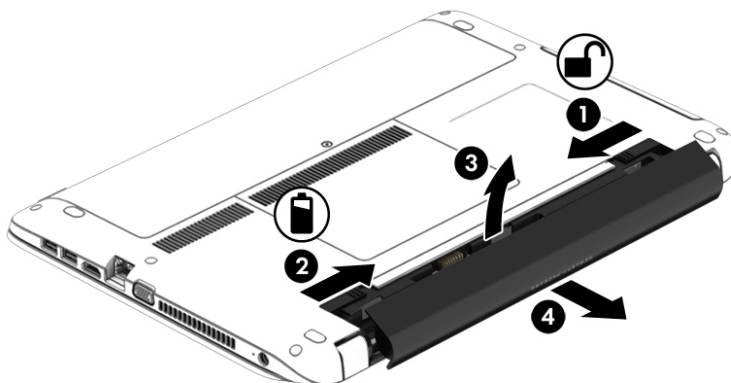

To remove the battery (without lock latch):

 **CAUTION:** Removing a battery that is the sole power source for the computer can cause loss of information. To prevent loss of information, save your work and shut down the computer through Windows before removing the battery.



1. Turn the computer upside down on a flat surface, with the battery bay toward you.
2. Slide the right battery release latch **(1)** and slide the left battery release latch **(2)** to release the battery.

 **NOTE:** You can slide the battery release latches simultaneously or you can slide them one at a time.

3. Pivot the battery **(3)** upward, and then remove the battery **(4)** from the computer.

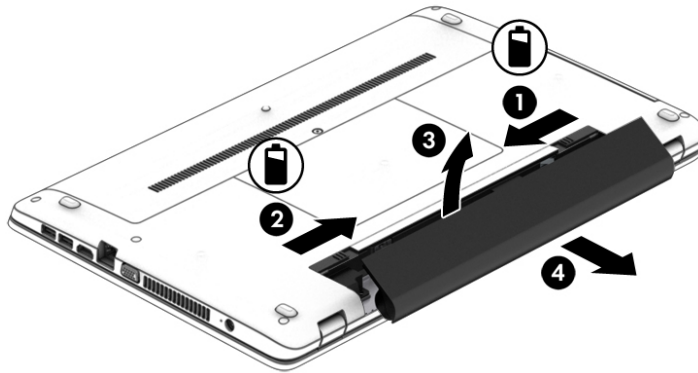

## Conserving battery power

- Type `power options` in the taskbar search box, and then select **Power Options**.
- or –
- Select low power-use settings through Power Options.
- Turn off wireless and LAN connections and exit modem applications when you are not using them.
- Disconnect unused external devices that are not plugged into an external power source.
- Stop, disable, or remove any external memory cards that you are not using.
- Decrease screen brightness.
- Before you leave your work, initiate Sleep, or shut down the computer.

## Storing a battery

 **CAUTION:** To reduce the risk of damage to a battery, do not expose it to high temperatures for extended periods of time.

If a computer will be unused and unplugged from external power for more than 2 weeks, remove the user-replaceable battery and store it separately.

To prolong the charge of a stored battery, place it in a cool, dry place.

 **NOTE:** A stored battery should be checked every 6 months. If the capacity is less than 50 percent, recharge the battery before returning it to storage.

Calibrate a battery before using it if it has been stored for one month or more.

## Disposing of a battery

---

 **WARNING!** To reduce the risk of fire or burns, do not disassemble, crush, or puncture; do not short external contacts; do not dispose of in fire or water.

---

See the *Regulatory, Safety and Environmental Notices* for proper battery disposal.

To access this document:

▲ Type `support` in the taskbar search box, and then select the **HP Support Assistant** app.

– or –

Click the question mark icon in the taskbar.

## Replacing a battery

HP Battery Check notifies you to replace the battery when an internal cell is not charging properly or when the battery storage capacity has reached a weak condition. If the battery is possibly covered by an HP warranty, instructions include a warranty ID. A message refers you to the HP website for more information about ordering a replacement battery.

## Using external AC power

---

 **WARNING!** Do not charge the computer battery while you are onboard aircraft.

 **WARNING!** To reduce potential safety issues, use only the AC adapter provided with the computer, a replacement AC adapter provided by HP, or a compatible AC adapter purchased from HP.

 **NOTE:** For information on connecting to AC power, see the *Setup Instructions* poster provided in the computer box.

---

External AC power is supplied through an approved AC adapter or an optional docking or expansion device.

Connect the computer to external AC power under any of the following conditions:

- When charging or calibrating a battery
- When installing or modifying system software
- When writing information to a CD, a DVD, or a BD (select products only)
- When running Disk Defragmenter
- When performing a backup or recovery

When you connect the computer to external AC power, the following events occur:

- The battery begins to charge.
- If the computer is turned on, the power meter icon in the taskbar changes appearance.

When you disconnect external AC power, the following events occur:

- The computer switches to battery power.
- The display brightness is automatically decreased to save battery life.

## Testing an AC adapter

Test the AC adapter if the computer exhibits any of the following symptoms when it is connected to AC power:

- The computer does not turn on.
- The display does not turn on.
- The power lights are off.

To test the AC adapter:





1. Shut down the computer.
2. Remove the battery on the computer.
3. Connect the AC adapter to the computer, and then plug it into an AC outlet.
4. Turn on the computer.
  - If the power lights turn *on*, the AC adapter is working properly.
  - If the power lights remain *off*, the AC adapter is not functioning and should be replaced.

Contact support for information on obtaining a replacement AC power adapter.

# 7 Security

## Protecting the computer

Standard security features provided by the Windows operating system and the non-Windows Computer Setup utility (BIOS) can protect your personal settings and data from a variety of risks.

-  **NOTE:** Security solutions are designed to act as deterrents. These deterrents may not prevent a product from being mishandled or stolen.
-  **NOTE:** Before you send your computer for service, back up and delete confidential files, and remove all password settings.
-  **NOTE:** Some features listed in this chapter may not be available on your computer.
-  **NOTE:** Your computer supports Computrace, which is an online security-based tracking and recovery service available in select regions. If the computer is stolen, Computrace can track the computer if the unauthorized user accesses the Internet. You must purchase the software and subscribe to the service in order to use Computrace. For information about ordering the Computrace software, go to <http://www.hp.com>.

Computer risk	Security feature
Unauthorized use of the computer	HP Client Security, in combination with a password, smart card, contactless card, registered fingerprints, or other authentication credential
Unauthorized access to Computer Setup (BIOS)	BIOS Administrator password in Computer Setup*
Unauthorized access to the contents of a hard drive	DriveLock password (select products only) in Computer Setup*
Unauthorized startup from an optional external optical drive (select products only), optional external hard drive (select products only), or internal network adapter	Boot options feature in Computer Setup*
Unauthorized access to a Windows user account	Windows user password
Unauthorized access to data	<ul style="list-style-type: none"><li>• HP Drive Encryption software</li><li>• Windows Defender</li></ul>
Unauthorized access to Computer Setup settings and other system identification information	BIOS Administrator password in Computer Setup*
Unauthorized removal of the computer	Security cable slot (used with an optional security cable on select products only)

\*Computer Setup is a preinstalled, ROM-based utility that can be used even when the operating system is not working or will not load. You can use a pointing device (TouchPad, pointing stick, or USB mouse) or the keyboard to navigate and make selections in Computer Setup.

**NOTE:** On tablets without keyboards, you can use the touchscreen.

# Using passwords

A password is a group of characters that you choose to secure your computer information. Several types of passwords can be set, depending on how you want to control access to your information. Passwords can be set in Windows or in Computer Setup, which is preinstalled on the computer.

- BIOS administrator and DriveLock passwords are set in Computer Setup and are managed by the system BIOS.
- Windows passwords are set only in the Windows operating system.
- If you forget both the DriveLock user password and the DriveLock master password set in Computer Setup, the hard drive that is protected by the passwords is permanently locked and can no longer be used.

You can use the same password for a Computer Setup feature and for a Windows security feature. You can also use the same password for more than one Computer Setup feature.

Use the following tips for creating and saving passwords:

- When creating passwords, follow requirements set by the program.
- Do not use the same password for multiple applications or websites, and do not reuse your Windows password for any other application or website.
- Use the Password Manager feature of HP Client Security to store your user names and passwords for your websites and applications. You can securely read them in the future if they cannot be remembered.
- Do not store passwords in a file on the computer.

The following tables list commonly used Windows and BIOS administrator passwords and describe their functions.

## Setting passwords in Windows

Password	Function
Administrator password*	Protects access to a Windows administrator-level account. <b>NOTE:</b> Setting the Windows administrator password does not set the BIOS Administrator password.
User password*	Protects access to a Windows user account.

\*For information about setting a Windows administrator password or a Windows user password, type `support` in the taskbar search box, and then select the **HP Support Assistant** app.

## Setting passwords in Computer Setup

Password	Function
BIOS administrator password*	Protects access to Computer Setup. <b>NOTE:</b> If features have been enabled to prevent removing the BIOS administrator password, you may not be able to remove it until those features have been disabled.
DriveLock master password*	Protects access to the internal hard drive that is protected by DriveLock. It is also used to remove DriveLock protection. <b>NOTE:</b> For select products, a BIOS administrator password must be set before you can set a DriveLock password.
DriveLock user password*	Protects access to the internal hard drive that is protected by DriveLock, and is set under DriveLock Passwords during the enable process. <b>NOTE:</b> For select products, a BIOS administrator password must be set before you can set a DriveLock password.

\*For details about each of these passwords, see the following topics.

## Managing a BIOS administrator password

To set, change, or delete this password, follow these steps:

### Setting a new BIOS administrator password

1. Start Computer Setup.
  - Computers or tablets with keyboards:
    - ▲ Turn on or restart the computer, and when the HP logo appears, press **F10** to enter Computer Setup.
  - Tablets without keyboards:
    - ▲ Turn off the tablet. Press the power button in combination with the volume down button until the Startup menu is displayed, and then tap **F10** to enter Computer Setup.
2. Select **Security**, select **Create BIOS Administrator password** or **Set Up BIOS Administrator Password** (select products only), and then press **enter**.
3. When prompted, type a password.
4. When prompted, type the new password again to confirm.
5. To save your changes and exit Computer Setup, select the **Save** icon and then follow the on-screen instructions.  
– or –  
Select **Main**, select **Save Changes and Exit**, and then press **enter**.

Your changes go into effect when the computer restarts.

### Changing a BIOS administrator password

1. Start Computer Setup.
  - Computers or tablets with keyboards:

- ▲ Turn on or restart the computer, and when the HP logo appears, press **f10** to enter Computer Setup.
- Tablets without keyboards:
  - ▲ Turn off the tablet. Press the power button in combination with the volume down button until the Startup menu is displayed, and then tap **F10** to enter Computer Setup.
- 2. Select **Security**, select **Change BIOS Administrator Password** or **Change Password** (select products only), and then press **enter**.
- 3. When prompted, type your current password.
- 4. When prompted, type your new password.
- 5. When prompted, type your new password again to confirm.
- 6. To save your changes and exit Computer Setup, select the **Save** icon, and then follow the on-screen instructions.

– or –

Select **Main**, select **Save Changes and Exit**, and then press **enter**.

Your changes go into effect when the computer restarts.

### Deleting a BIOS administrator password

1. Start Computer Setup.
  - Computers or tablets with keyboards:
    - ▲ Turn on or restart the computer, and when the HP logo appears, press **f10** to enter Computer Setup.
  - Tablets without keyboards:
    - ▲ Turn off the tablet. Press the power button in combination with the volume down button until the Startup menu is displayed, and then tap **F10** to enter Computer Setup.
2. Select **Security**, select **Change BIOS Administrator Password** or **Change Password** (select products only), and then press **enter**.
3. When prompted, type your current password.
4. When prompted for the new password, leave the field empty, and then press **enter**.
5. When prompted to type your new password again, leave the field empty, and then press **enter**.
6. To save your changes and exit Computer Setup, select the **Save** icon, and then follow the on-screen instructions.

– or –

Select **Main**, select **Save Changes and Exit**, and then press **enter**.

Your changes go into effect when the computer restarts.

### Entering a BIOS administrator password

At the **BIOS Administrator password** prompt, type your password (using the same kind of keys you used to set the password), and then press **enter**. After two unsuccessful attempts to enter the BIOS administrator password, you must restart the computer and try again.

## Managing a Computer Setup DriveLock password (select products only)

---

 **CAUTION:** To prevent a DriveLock-protected hard drive from becoming permanently unusable, record the DriveLock user password and the DriveLock master password in a safe place away from your computer. If you forget both DriveLock passwords, the hard drive will be permanently locked and can no longer be used.

---

DriveLock protection prevents unauthorized access to the contents of a hard drive. DriveLock can be applied only to the internal hard drive(s) of the computer. After DriveLock protection is applied to a drive, a password must be entered to access the drive. The drive must be inserted into the computer or an advanced port replicator in order for it to be accessed by the DriveLock passwords.

To apply DriveLock protection to an internal hard drive, a user password and a master password must be set in Computer Setup. Note the following considerations about using DriveLock protection:

- After DriveLock protection is applied to a hard drive, the hard drive can be accessed only by entering either the user password or the master password.
- The owner of the user password should be the day-to-day user of the protected hard drive. The owner of the master password may be either a system administrator or the day-to-day user.
- The user password and the master password can be identical.
- You can delete a user password or master password only by removing DriveLock protection from the drive.



---

**NOTE:** For select products, a BIOS administrator password must be set before you can access the DriveLock features.

---

### Setting a DriveLock password

To set a DriveLock password in Computer Setup, follow these steps:

1. Start Computer Setup.
  - Computers or tablets with keyboards:
    1. Turn off the computer.
    2. Press the power button, and when the HP logo appears, press **f10** to enter Computer Setup.
  - Tablets without keyboards:
    1. Turn off the tablet.
    2. Press the power button in combination with the volume down button until the Startup menu is displayed, and then tap **F10** to enter Computer Setup.
2. Select **Security**, make the selection for **Hard Drive Utilities** or **Hard Drive Tools** (select products only), select **DriveLock**, and then press **enter**.



---

**NOTE:** For select products, you may be required to set a DriveLock password and enter the BIOS administrator password.

---

3. Select the hard drive you want to protect, and then press **enter**.
4. Select **Set DriveLock Master Password** or **Set DriveLock Password** (select products only), and then press **enter**.
5. Carefully read the warning.
6. Follow the on-screen instructions to set a DriveLock password.
7. To exit Computer Setup, select **Main**, select **Save Changes and Exit**, and then select **Yes**.



## Enabling DriveLock (select products only)

For select products, you may need to follow these instructions to enable DriveLock.

1. Start Computer Setup.
  - Computers or tablets with keyboards:
    1. Turn off the computer.
    2. Press the power button, and when the HP logo appears, press **F10** to enter Computer Setup.
  - Tablets without keyboards:
    1. Turn off the tablet.
    2. Press the power button in combination with the volume down button until the Startup menu is displayed, and then tap **F10** to enter Computer Setup.
2. Select **Security**, select **Hard Drive Utilities** or **Hard Drive Tools** (select products only), select **DriveLock**, and then press **enter**.

---

 **NOTE:** For select products, you may be required to enter the BIOS Administrator password and select **Set DriveLock Password**.

---

3. Select the hard drive you want to protect, and then press **enter**.
4. Follow the on-screen instructions to make the selections to enable DriveLock and to enter passwords when prompted.

---

 **NOTE:** For select products, you may be prompted to type `DriveLock`. The field is case sensitive.

---

5. To exit Computer Setup, select **Main**, select **Save Changes and Exit**, and then select **Yes**.

## Disabling DriveLock (select products only)

1. Start Computer Setup.
  - Computers or tablets with keyboards:
    1. Turn off the computer.
    2. Press the power button, and when the HP logo appears, press **F10** to enter Computer Setup.
  - Tablets without keyboards:
    1. Turn off the tablet.
    2. Press the power button in combination with the volume down button until the Startup menu is displayed, and then tap **F10** to enter Computer Setup.
2. Select **Security**, select **Hard Drive Utilities** or **Hard Drive Tools** (select products only), select **DriveLock**, and then press **enter**.

---

 **NOTE:** For select products, you may be required to enter the BIOS Administrator password and select **Set DriveLock Password**.

---

3. Select the hard drive you want to manage, and then press **enter**.
4. Follow the on-screen instructions to disable DriveLock.
5. To exit Computer Setup, select **Main**, select **Save Changes and Exit**, and then select **Yes**.

## Entering a DriveLock password (select products only)

Be sure that the hard drive is inserted into the computer (not into an optional docking device or external MultiBay).

At the **DriveLock Password** prompt, type your user or master password (using the same kind of keys you used to set the password), and then press [enter](#).

After three incorrect attempts to enter the password, you must shut down the computer and try again.

## Changing a DriveLock password (select products only)

To change a DriveLock password in Computer Setup, follow these steps:

1. Turn off the computer.
2. Press the power button.
3. At the **DriveLock Password** prompt, type the current DriveLock user password or master password that you are changing, press [enter](#), and then press or tap **F10** to enter Computer Setup.
4. Select **Security**, select **Hard Drive Utilities** or **Hard Drive Tools** (select products only), select **DriveLock**, and then press [enter](#).



---

**NOTE:** For select products, you may be required to enter the BIOS Administrator password and select **Set DriveLock Password**.

---

5. Select the hard drive you want to manage, and then press [enter](#).
6. Make the selection to change the password, and then follow the on-screen prompts to enter passwords.



---

**NOTE:** The **Change DriveLock Master Password** option is visible only if the master password was provided at the DriveLock Password prompt in step 3.

---

7. To exit Computer Setup, select **Main**, select **Save Changes and Exit**, and then follow the on-screen instructions.

## Using Computer Setup Automatic DriveLock (select products only)

In a multiple-user environment, you can set an Automatic DriveLock password. When the Automatic DriveLock password is enabled, a random user password and a DriveLock master password will be created for you. When any user passes the password credential, the same random user and DriveLock master password will be used to unlock the drive.



---

**NOTE:** A BIOS Administrator password must be set before you can access the Automatic DriveLock features.

---

## Entering an Automatic DriveLock password (select products only)

To enable an Automatic DriveLock password in Computer Setup, follow these steps:

1. Turn on or restart the computer, and then press [esc](#) while the “Press the ESC key for Startup Menu” message is displayed at the bottom of the screen.
2. Press **F10** to enter Computer Setup.
3. Select **Security**, select **Hard Drive Tools**, select **Automatic DriveLock**, and then press [enter](#).
4. Enter the BIOS Administrator password, and then press [enter](#).
5. Select an internal hard drive, and then press [enter](#).

6. Read the warning. To continue, select **YES**.
7. To save your changes and exit Computer Setup, select the **Save** icon and then follow the on-screen instructions.  
– or –  
Select **Main**, select **Save Changes and Exit**, and then press [enter](#).

## Removing Automatic DriveLock protection (select products only)

To remove DriveLock protection in Computer Setup, follow these steps:

1. Turn on or restart the computer, and then press [esc](#) while the “Press the ESC key for Startup Menu” message is displayed at the bottom of the screen.
2. Press [f10](#) to enter Computer Setup.
3. Select **Security**, select **Hard Drive Tools**, select **Automatic DriveLock**, and then press [enter](#).
4. Enter the BIOS Administrator password, and then press [enter](#).
5. Select an internal hard drive, and then press [enter](#).
6. Select **Disable protection**.
7. To save your changes and exit Computer Setup, select the **Save** icon, and then follow the on-screen instructions.  
– or –  
Select **Main**, select **Save Changes and Exit**, and then press [enter](#).

## Using antivirus software

When you use the computer to access e-mail, a network, or the Internet, you potentially expose it to computer viruses. Computer viruses can disable the operating system, programs, or utilities, or cause them to function abnormally.

Antivirus software can detect most viruses, destroy them, and, in most cases, repair any damage they have caused. To provide ongoing protection against newly discovered viruses, antivirus software must be kept up to date.

Windows Defender is preinstalled on your computer. It is strongly recommended that you continue to use an antivirus program in order to fully protect your computer.

For more information about computer viruses, access the HP Support Assistant.

## Using firewall software

Firewalls are designed to prevent unauthorized access to a system or network. A firewall can be a software program you install on your computer and/or network, or it can be a solution made up of both hardware and software.

There are two types of firewalls to consider:

- Host-based firewalls—Software that protects only the computer it is installed on.
- Network-based firewalls—Installed between your DSL or cable modem and your home network to protect all the computers on the network.

When a firewall is installed on a system, all data sent to and from the system is monitored and compared with a set of user-defined security criteria. Any data that does not meet those criteria is blocked.

Your computer or networking equipment may already have a firewall installed. If not, firewall software solutions are available.

---

 **NOTE:** Under some circumstances a firewall can block access to Internet games, interfere with printer or file sharing on a network, or block authorized e-mail attachments. To temporarily resolve the problem, disable the firewall, perform the task that you want to perform, and then reenabling the firewall. To permanently resolve the problem, reconfigure the firewall.

---

## Installing critical security updates

---

 **CAUTION:** Microsoft® sends out alerts regarding critical updates. To protect the computer from security breaches and computer viruses, install all critical updates from Microsoft as soon as you receive an alert.

---

You can choose whether updates are installed automatically. To change the settings, type `control panel` in the taskbar search box, and then select **Control Panel**. Select **System and Security**, select **Windows Update**, select **Change settings**, and then follow the on-screen instructions.

## Using HP Client Security (select products only)

HP Client Security software is preinstalled on your computer. This software can be accessed through the HP Client Security icon at the far right of the taskbar or Windows Control Panel. It provides security features that help protect against unauthorized access to the computer, networks, and critical data. For more information, see the HP Client Security software Help.

## Using HP Touchpoint Manager (select products only)

HP Touchpoint Manager is a cloud-based IT solution that enables businesses to effectively manage and secure their company assets. HP Touchpoint Manager helps protect devices against malware and other attacks, monitors device health, and enables customers to reduce time spent solving end-user device and security issues. Customers can quickly download and install the software, which is highly cost effective relative to traditional in-house solutions. For more information, see <http://www.hptouchpointmanager.com>.

## Installing an optional security cable (select products only)

---

 **NOTE:** A security cable is designed to act as a deterrent, but it may not prevent the computer from being mishandled or stolen.

 **NOTE:** The security cable slot on your computer may look slightly different from the illustration in this section.

---

1. Loop the security cable around a secured object.
2. Insert the key **(1)** into the cable lock **(2)**.
3. Insert the cable lock into the security cable slot on the computer **(3)**, and then lock the cable lock with the key.

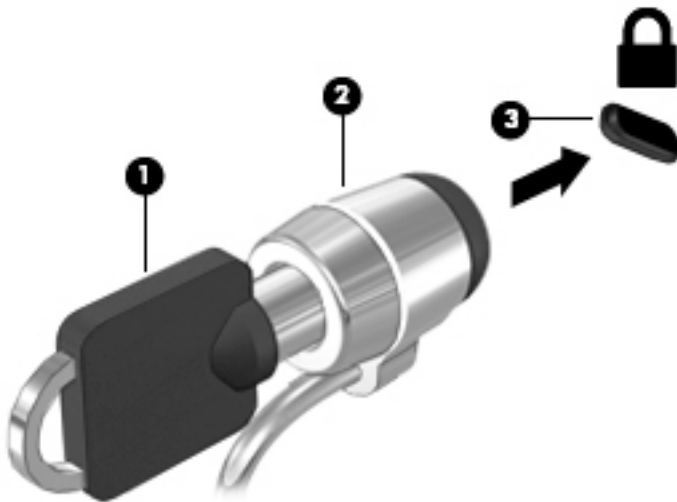

## Using a fingerprint reader (select products only)

Integrated fingerprint readers are available on select products. In order to use the fingerprint reader, you must enroll your fingerprints in HP Client Security's Credential Manager. Refer to the HP Client Security software Help.

After you enroll your fingerprints in Credential Manager, you can use HP Client Security's Password Manager to store and fill in your user names and passwords in supported websites and applications.

### Locating the fingerprint reader

The fingerprint reader is a small metallic sensor that is located in one of the following areas of your computer:

- Near the bottom of the TouchPad
- On the right side of the keyboard
- On the upper-right side of the display
- On the left side of the display

Depending on your product, the reader may be oriented horizontally or vertically. Both orientations require that you swipe your finger perpendicular to the metallic sensor.

---

# 8 Maintenance

It is important to perform regular maintenance to keep your computer in optimal condition. This chapter explains how to use tools like Disk Defragmenter and Disk Cleanup. It also provides instructions for updating programs and drivers, steps to clean the computer, and tips for traveling with (or shipping) the computer.

## Improving performance

You can improve the performance of your computer by performing regular maintenance tasks with tools such as Disk Defragmenter and Disk Cleanup.

### Using Disk Defragmenter

HP recommends using Disk Defragmenter to defragment your hard drive at least once a month.



**NOTE:** It is not necessary to run Disk Defragmenter on solid-state drives.

To run Disk Defragmenter:

1. Connect the computer to AC power.
2. Type `defragment` in the taskbar search box, and then select **Defragment and optimize your drives**.
3. Follow the on-screen instructions.

For additional information, access the Disk Defragmenter software Help.

### Using Disk Cleanup

Use Disk Cleanup to search the hard drive for unnecessary files that you can safely delete to free up disk space and help the computer run more efficiently.

To run Disk Cleanup:

1. Type `disk` in the taskbar search box, and then select **Free up disk space by deleting unnecessary files** or **Uninstall apps to free up disk space**.
2. Follow the on-screen instructions.

### Using HP 3D DriveGuard (select products only)

HP 3D DriveGuard protects a hard drive by parking the drive and halting data requests under either of the following conditions:

- You drop the computer.
- You move the computer with the display closed while the computer is running on battery power.

A short time after the end of one of these events, HP 3D DriveGuard returns the hard drive to normal operation.



**NOTE:** Only internal hard drives are protected by HP 3D DriveGuard. A hard drive installed in an optional docking device or connected to a USB port is not protected by HP 3D DriveGuard.

 **NOTE:** Because solid-state drives (SSDs) lack moving parts, HP 3D DriveGuard is unnecessary for these drives.

---

For more information, see the HP 3D DriveGuard software Help.

## Identifying HP 3D DriveGuard status

The hard drive light on the computer changes color to show that the drive in a primary hard drive bay and/or the drive in a secondary hard drive bay (select products only) is parked. To determine whether a drive is currently protected or whether it is parked, view the icon on the Windows desktop in the notification area, at the far right of the taskbar.

## Updating programs and drivers

HP recommends that you update your programs and drivers on a regular basis. Updates can resolve issues and bring new features and options to your computer. For example, older graphics components might not work well with the most recent gaming software. Without the latest driver, you would not be getting the most out of your equipment.

Go to <http://www.hp.com/support> to download the latest versions of HP programs and drivers. In addition, register to receive automatic notifications when updates become available.

If you would like to update your programs and drivers, follow these instructions:

1. Type `support` in the taskbar search box, and then select the **HP Support Assistant** app.  
- or -  
Click the question mark icon in the taskbar.
2. Select **My PC**, select the **Updates** tab, and then select **Check for updates and messages**.
3. Follow the on-screen instructions.

## Cleaning your computer

Use the following products to safely clean your computer:

- Dimethyl benzyl ammonium chloride 0.3 percent maximum concentration (for example, disposable wipes, which come in a variety of brands)
- Alcohol-free glass-cleaning fluid
- Solution of water and mild soap
- Dry microfiber cleaning cloth or a chamois (static-free cloth without oil)
- Static-free cloth wipes

 **CAUTION:** Avoid strong cleaning solvents that can permanently damage your computer. If you are not sure that a cleaning product is safe for your computer, check the product contents to make sure that ingredients such as alcohol, acetone, ammonium chloride, methylene chloride, and hydrocarbons are not included in the product.

---

Fibrous materials, such as paper towels, can scratch the computer. Over time, dirt particles and cleaning agents can get trapped in the scratches.

## Cleaning procedures

Follow the procedures in this section to safely clean your computer.

---

 **WARNING!** To prevent electric shock or damage to components, do not attempt to clean your computer while it is on.

1. Turn off the computer.
2. Disconnect AC power.
3. Disconnect all powered external devices.

 **CAUTION:** To prevent damage to internal components, do not spray cleaning agents or liquids directly on any computer surface. Liquids dripped on the surface can permanently damage internal components.

---

## Cleaning the display

Gently wipe the display using a soft, lint-free cloth moistened with an alcohol-free glass cleaner. Be sure that a display is dry before you close the computer.

## Cleaning the sides or cover

To clean the sides or cover, use a soft microfiber cloth or chamois moistened with one of the cleaning solutions listed previously, or use an acceptable disposable wipe.

 **NOTE:** When cleaning the cover of the computer, use a circular motion to aid in removing dirt and debris.

---

## Cleaning the TouchPad, keyboard, or mouse (select products only)

 **WARNING!** To reduce the risk of electric shock or damage to internal components, do not use a vacuum cleaner attachment to clean the keyboard. A vacuum cleaner can deposit household debris on the keyboard surface.

 **CAUTION:** To prevent damage to internal components, do not allow liquids to drip between the keys.

---

- To clean the TouchPad, keyboard, or mouse, use a soft microfiber cloth or a chamois moistened with one of the cleaning solutions listed previously or use an acceptable disposable wipe.
- To prevent keys from sticking and to remove dust, lint, and particles from the keyboard, use a can of compressed air with a straw extension.

## Traveling with or shipping your computer

If you have to travel with or ship your computer, follow these tips to keep your equipment safe.

- Prepare the computer for traveling or shipping:
  - Back up your information to an external drive.
  - Remove all discs and all external media cards, such as memory cards.
  - Turn off and then disconnect all external devices.
  - Shut down the computer.
- Take along a backup of your information. Keep the backup separate from the computer.
- When traveling by air, carry the computer as hand luggage; do not check it in with the rest of your luggage.

 **CAUTION:** Avoid exposing a drive to magnetic fields. Security devices with magnetic fields include airport walk-through devices and security wands. Airport conveyer belts and similar security devices that check carry-on baggage use X-rays instead of magnetism and do not damage drives.

---



- If you plan to use the computer during a flight, listen for the in-flight announcement that tells you when you are allowed to use your computer. In-flight computer use is at the discretion of the airline.
- If you are shipping the computer or a drive, use suitable protective packaging and label the package “FRAGILE.”
- The use of wireless devices may be restricted in some environments. Such restrictions may apply aboard aircraft, in hospitals, near explosives, and in hazardous locations. If you are uncertain of the policy that applies to the use of a wireless device in your computer, ask for authorization to use your computer before you turn it on.
- If you are traveling internationally, follow these suggestions:
  - Check the computer-related customs regulations for each country or region on your itinerary.
  - Check the power cord and adapter requirements for each location in which you plan to use the computer. Voltage, frequency, and plug configurations vary.

---

 **WARNING!** To reduce the risk of electric shock, fire, or damage to the equipment, do not attempt to power the computer with a voltage converter kit sold for appliances.

---

---

## 9 Backup and recovery

This chapter provides information about the following processes. The information in the chapter is standard procedure for most products.

- Creating recovery media and backups
- Restoring and recovering your system

For additional information, refer to the HP support assistant app.

▲ Type `support` in the taskbar search box, and then select the **HP Support Assistant** app.

– or –

Click the question mark icon in the taskbar.

---

 **IMPORTANT:** If you will be performing recovery procedures on a tablet, the tablet battery must be at least 70% charged before you start the recovery process.

**IMPORTANT:** For a tablet with a detachable keyboard, connect the keyboard to the keyboard dock before beginning any recovery process.

---

### Creating recovery media and backups

The following methods of creating recovery media and backups are available on select products only. Choose the available method according to your computer model.

- Use HP Recovery Manager to create HP Recovery media after you successfully set up the computer. This step creates a backup of the HP Recovery partition on the computer. The backup can be used to reinstall the original operating system in cases where the hard drive is corrupted or has been replaced. For information on creating recovery media, see [Creating HP Recovery media \(select products only\) on page 64](#). For information on the recovery options that are available using the recovery media, see [Using Windows tools on page 65](#).
- Use Windows tools to create system restore points and create backups of personal information.

For more information, see [Recovering using HP Recovery Manager on page 66](#).

---

 **NOTE:** If storage is 32 GB or less, Microsoft System Restore is disabled by default.

---

### Creating HP Recovery media (select products only)

If possible, check for the presence of the Recovery partition and the Windows partition. From the **Start** menu, select **File Explorer**, and then select **This PC**.

- If your computer does not list the Windows partition and the Recovery partition, you can obtain recovery media for your system from support. See the *Worldwide Telephone Numbers* booklet included with the computer. You can also find contact information on the HP website. Go to <http://www.hp.com/support>, select your country or region, and follow the on-screen instructions.

You can use Windows tools to create system restore points and create backups of personal information, see [Using Windows tools on page 65](#).

- If your computer does list the Recovery partition and the Windows partition, you can use HP Recovery Manager to create recovery media after you successfully set up the computer. HP Recovery media can be used to perform system recovery if the hard drive becomes corrupted. System recovery reinstalls the original operating system and software programs that were installed at the factory and then configures the settings for the programs. HP Recovery media can also be used to customize the system or restore the factory image if you replace the hard drive.
  - Only one set of recovery media can be created. Handle these recovery tools carefully, and keep them in a safe place.
  - HP Recovery Manager examines the computer and determines the required storage capacity for the media that will be required.
  - To create recovery discs, your computer must have an optical drive with DVD writer capability, and you must use only high-quality blank DVD-R, DVD+R, DVD-R DL, or DVD+R DL discs. Do not use rewritable discs such as CD±RW, DVD±RW, double-layer DVD±RW, or BD-RE (rewritable Blu-ray) discs; they are not compatible with HP Recovery Manager software. Or, instead, you can use a high-quality blank USB flash drive.
  - If your computer does not include an integrated optical drive with DVD writer capability, but you would like to create DVD recovery media, you can use an external optical drive (purchased separately) to create recovery discs. If you use an external optical drive, it must be connected directly to a USB port on the computer; the drive cannot be connected to a USB port on an external device, such as a USB hub. If you cannot create DVD media yourself, you can obtain recovery discs for your computer from HP. See the *Worldwide Telephone Numbers* booklet included with the computer. You can also find contact information on the HP website. Go to <http://www.hp.com/support>, select your country or region, and follow the on-screen instructions.
  - Be sure that the computer is connected to AC power before you begin creating the recovery media.
  - The creation process can take an hour or more. Do not interrupt the creation process.
  - If necessary, you can exit the program before you have finished creating all of the recovery DVDs. HP Recovery Manager will finish burning the current DVD. The next time you start HP Recovery Manager, you will be prompted to continue.

To create HP Recovery media:



---

**IMPORTANT:** For a tablet with a detachable keyboard, connect the keyboard to the keyboard dock before beginning these steps.

---

1. Type `recovery` in the taskbar search box, and then select **HP Recovery Manager**.
2. Select **Create recovery media**, and then follow the on-screen instructions.

If you ever need to recover the system, see [Recovering using HP Recovery Manager on page 66](#).

## Using Windows tools

You can create recovery media, system restore points, and backups of personal information using Windows tools.



---

**NOTE:** If storage is 32 GB or less, Microsoft System Restore is disabled by default.

---

For more information and steps, see the Get started app.

- ▲ Select the **Start** button, and then select the **Get started** app.

## Restore and recovery

There are several options for recovering your system. Choose the method that best matches your situation and level of expertise:



---

**IMPORTANT:** Not all methods are available on all products.

---

- Windows offers several options for restoring from backup, refreshing the computer, and resetting the computer to its original state. For more information see the Get started app.
  - ▲ Select the **Start** button, and then select the **Get started** app.
- If you need to correct a problem with a preinstalled application or driver, use the Reinstall drivers and/or applications option (select products only) of HP Recovery Manager to reinstall the individual application or driver.
  - ▲ Type `recovery` in the taskbar search box, select **HP Recovery Manager**, select **Reinstall drivers and/or applications**, and then follow the on-screen instructions.
- If you want to recover the Windows partition to original factory content, you can choose the System Recovery option from the HP Recovery partition (select products only) or use the HP Recovery media. For more information, see [Recovering using HP Recovery Manager on page 66](#). If you have not already created recovery media, see [Creating HP Recovery media \(select products only\) on page 64](#).
- On select products, if you want to recover the computer's original factory partition and content, or if you have replaced the hard drive, you can use the Factory Reset option of HP Recovery media. For more information, see [Recovering using HP Recovery Manager on page 66](#).
- On select products, if you want to remove the recovery partition to reclaim hard drive space, HP Recovery Manager offers the Remove Recovery Partition option.

For more information, see [Removing the HP Recovery partition \(select products only\) on page 68](#).

## Recovering using HP Recovery Manager

HP Recovery Manager software allows you to recover the computer to its original factory state by using the HP Recovery media that you either created or that you obtained from HP, or by using the HP Recovery partition (select products only). If you have not already created recovery media, see [Creating HP Recovery media \(select products only\) on page 64](#).

### What you need to know before you get started

- HP Recovery Manager recovers only software that was installed at the factory. For software not provided with this computer, you must either download the software from the manufacturer's website or reinstall the software from the media provided by the manufacturer.



---

**IMPORTANT:** Recovery through HP Recovery Manager should be used as a final attempt to correct computer issues.

---

- HP Recovery media must be used if the computer hard drive fails. If you have not already created recovery media, see [Creating HP Recovery media \(select products only\) on page 64](#).
- To use the Factory Reset option (select products only), you must use HP Recovery media. If you have not already created recovery media, see [Creating HP Recovery media \(select products only\) on page 64](#).
- If your computer does not allow the creation of HP Recovery media or if the HP Recovery media does not work, you can obtain recovery media for your system from support. See the *Worldwide Telephone Numbers* booklet included with the computer. You can also find contact information from the HP

website. Go to <http://www.hp.com/support>, select your country or region, and follow the on-screen instructions.

---

 **IMPORTANT:** HP Recovery Manager does not automatically provide backups of your personal data. Before beginning recovery, back up any personal data you want to retain.

---

Using HP Recovery media, you can choose from one of the following recovery options:

---

 **NOTE:** Only the options available for your computer display when you start the recovery process.

---

- System Recovery—Reinstalls the original operating system, and then configures the settings for the programs that were installed at the factory.
- Factory Reset—Restores the computer to its original factory state by deleting all information from the hard drive and re-creating the partitions. Then it reinstalls the operating system and the software that was installed at the factory.

The HP Recovery partition (select products only) allows System Recovery only.

## Using the HP Recovery partition (select products only)

The HP Recovery partition allows you to perform a system recovery without the need for recovery discs or a recovery USB flash drive. This type of recovery can be used only if the hard drive is still working.

To start HP Recovery Manager from the HP Recovery partition:

---

 **IMPORTANT:** For a tablet with a detachable keyboard, connect the keyboard to the keyboard dock before beginning these steps (select products only).

---

1. Type `recovery` in the taskbar search box, select **Recovery Manager**, and then select **HP Recovery Environment**.

- or -

For computers or tablets with keyboards attached, press **f11** while the computer boots, or press and hold **f11** as you press the power button.

For tablets without keyboards:

Turn on or restart the tablet, and then quickly hold down the volume down button; then select **f11**.

- or -

Turn on or restart the tablet, and then quickly hold down the Windows button; then select **f11**.

2. Select **Troubleshoot** from the boot options menu.
3. Select **Recovery Manager**, and then follow the on-screen instructions.

## Using HP Recovery media to recover

You can use HP Recovery media to recover the original system. This method can be used if your system does not have an HP Recovery partition or if the hard drive is not working properly.

1. If possible, back up all personal files.
2. Insert the HP Recovery media, and then restart the computer.

---

 **NOTE:** If the computer does not automatically restart in HP Recovery Manager, change the computer boot order. See [Changing the computer boot order on page 68](#).

---

3. Follow the on-screen instructions.

## Changing the computer boot order

If your computer does not restart in HP Recovery Manager, you can change the computer boot order, which is the order of devices listed in BIOS where the computer looks for startup information. You can change the selection to an optical drive or a USB flash drive.

To change the boot order:

---

 **IMPORTANT:** For a tablet with a detachable keyboard, connect the keyboard to the keyboard dock before beginning these steps.

---

1. Insert the HP Recovery media.
2. Access BIOS:

For computers or tablets with keyboards attached:

- ▲ Turn on or restart the computer or tablet, quickly press **esc**, and then press **f9** for boot options.

For tablets without keyboards:

- ▲ Turn on or restart the tablet, and then quickly hold down the volume down button; then select **f9**.

- or -

Turn on or restart the tablet, and then quickly hold down the Windows button; then select **f9**.

3. Select the optical drive or USB flash drive from which you want to boot.
4. Follow the on-screen instructions.

## Removing the HP Recovery partition (select products only)

HP Recovery Manager software allows you to remove the HP Recovery partition to free up hard drive space.

---

 **IMPORTANT:** After you remove the HP Recovery partition, you will not be able to perform System Recovery or create HP recovery media from the HP Recovery partition. So before you remove the Recovery partition, create HP Recovery media; see [Creating HP Recovery media \(select products only\) on page 64](#).

---

 **NOTE:** The Remove Recovery Partition option is only available on products that support this function.

---

Follow these steps to remove the HP Recovery partition:

1. Type `recovery` in the taskbar search box, and then select **HP Recovery Manager**.
2. Select **Remove Recovery Partition**, and then follow the on-screen instructions.

---

# 10 Computer Setup (BIOS), TPM, and HP Sure Start

## Using Computer Setup

Computer Setup, or Basic Input/Output System (BIOS), controls communication between all the input and output devices on the system (such as disk drives, display, keyboard, mouse, and printer). Computer Setup includes settings for the types of devices installed, the startup sequence of the computer, and the amount of system and extended memory.

---

 **NOTE:** Use extreme care when making changes in Computer Setup. Errors can prevent the computer from operating properly.

---

## Starting Computer Setup

---

 **NOTE:** An external keyboard or mouse connected to a USB port can be used with Computer Setup only if USB legacy support is enabled.

---

To start Computer Setup, follow these steps:

- ▲ Start Computer Setup.
  - Computers or tablets with keyboards:
    - ▲ Turn on or restart the computer, and when the HP logo appears, press **F10** to enter Computer Setup.
  - Tablets without keyboards:
    - ▲ Turn off the tablet. Press the power button in combination with the volume down button until the Startup menu is displayed, and then tap **F10** to enter Computer Setup.

## Navigating and selecting in Computer Setup

- To select a menu or a menu item, use the **tab** key and the keyboard arrow keys and then press **enter**, or use a pointing device to select the item.

---

 **NOTE:** On tablets without keyboards, you can use your finger to make selections.

---

- To scroll up and down, select the up arrow or the down arrow in the upper-right corner of the screen, or use the up arrow key or the down arrow key on the keyboard.
- To close open dialog boxes and return to the main Computer Setup screen, press **esc**, and then follow the on-screen instructions.

To exit Computer Setup menus, choose one of the following methods:

- To exit Computer Setup menus without saving your changes:  
Select the **Exit** icon in the lower-right corner of the screen, and then follow the on-screen instructions.  
– or –  
Select **Main**, select **Ignore Changes and Exit**, and then press [enter](#).
- To save your changes and exit Computer Setup menus:  
Select the **Save** icon in the lower-right corner of the screen, and then follow the on-screen instructions.  
– or –  
Select **Main**, select **Save Changes and Exit**, and then press [enter](#).

Your changes go into effect when the computer restarts.

## Restoring factory settings in Computer Setup

---

 **NOTE:** Restoring defaults will not change the hard drive mode.

---

To return all settings in Computer Setup to the values that were set at the factory, follow these steps:

1. Start Computer Setup. See [Starting Computer Setup on page 69](#).
2. Select **Main**, and then select **Apply Factory Defaults and Exit**.

---

 **NOTE:** On select products, the selections may display **Restore Defaults** instead of **Apply Factory Defaults and Exit**.

---

3. Follow the on-screen instructions.
4. To save your changes and exit, select the **Save** icon in the lower-right corner of the screen, and then follow the on-screen instructions.  
– or –  
Select **Main**, select **Save Changes and Exit**, and then press [enter](#).

Your changes go into effect when the computer restarts.

---

 **NOTE:** Your password settings and security settings are not changed when you restore the factory settings.

---

## Updating the BIOS

Updated versions of the BIOS may be available on the HP website.

Most BIOS updates on the HP website are packaged in compressed files called *SoftPaqs*.

Some download packages contain a file named *Readme.txt*, which contains information regarding installing and troubleshooting the file.

## Determining the BIOS version

To decide whether you need to update Computer Setup (BIOS), first determine the BIOS version on your computer.

BIOS version information (also known as *ROM date* and *System BIOS*) can be accessed by pressing [fn+esc](#) (if you are already in Windows) or by using Computer Setup.



1. Start Computer Setup. See [Starting Computer Setup on page 69](#).
2. Select **Main**, and then select **System Information**.
3. To exit Computer Setup without saving your changes, select the **Exit** icon in the lower-right corner of the screen, and then follow the on-screen instructions.

– or –

Select **Main**, select **Ignore Changes and Exit**, and then press [enter](#).

To check for later BIOS versions, see [Downloading a BIOS update on page 71](#).

## Downloading a BIOS update

---

 **CAUTION:** To reduce the risk of damage to the computer or an unsuccessful installation, download and install a BIOS update only when the computer is connected to reliable external power using the AC adapter. Do not download or install a BIOS update while the computer is running on battery power, docked in an optional docking device, or connected to an optional power source. During the download and installation, follow these instructions:

Do not disconnect power on the computer by unplugging the power cord from the AC outlet.

Do not shut down the computer or initiate Sleep.

Do not insert, remove, connect, or disconnect any device, cable, or cord.

---

1. Type `support` in the taskbar search box, and then select the HP Support Assistant app.  
– or –  
Select the question mark icon in the taskbar.
2. Select **Updates**, and then select **Check for updates and messages**.
3. Follow the on-screen instructions.
4. At the download area, follow these steps:
  - a. Identify the most recent BIOS update and compare it to the BIOS version currently installed on your computer. Make a note of the date, name, or other identifier. You may need this information to locate the update later, after it has been downloaded to your hard drive.
  - b. Follow the on-screen instructions to download your selection to the hard drive.  
  
Make a note of the path to the location on your hard drive where the BIOS update is downloaded. You will need to access this path when you are ready to install the update.

---

 **NOTE:** If you connect your computer to a network, consult the network administrator before installing any software updates, especially system BIOS updates.

---

BIOS installation procedures vary. Follow any instructions that are revealed on the screen after the download is complete. If no instructions are revealed, follow these steps:

1. Type `file` in the taskbar search box, and then select **File Explorer**.
2. Select your hard drive designation. The hard drive designation is typically Local Disk (C:).
3. Using the hard drive path you recorded earlier, open the folder that contains the update.
4. Double-click the file that has an `.exe` extension (for example, `filename.exe`).  
  
The BIOS installation begins.
5. Complete the installation by following the on-screen instructions.



---

**NOTE:** After a message on the screen reports a successful installation, you can delete the downloaded file from your hard drive.

---

## Changing the boot order using the f9 prompt

To dynamically choose a boot device for the current startup sequence, follow these steps:

1. Access the Boot Device Options menu:
  - Computers or tablets with keyboards:
    - ▲ Turn on or restart the computer, and when the HP logo appears, press **f9** to enter the Boot Device Options menu.
  - Tablets without keyboards:
    - ▲ Turn off the tablet. Press the power button in combination with the volume down button until the Startup menu is displayed, and then tap **F9** to enter the Boot Device Options menu.
2. Select a boot device, then press **enter**.

## TPM BIOS settings (select products only)



---

**IMPORTANT:** Before enabling Trusted Platform Module (TPM) functionality on this system, you must ensure that your intended use of TPM complies with relevant local laws, regulations and policies, and approvals or licenses must be obtained if applicable. For any compliance issues arising from your operation/usage of TPM which violates the above mentioned requirement, you shall bear all the liabilities wholly and solely. HP will not be responsible for any related liabilities.

---

TPM provides additional security for your computer. You can modify the TPM settings in Computer Setup (BIOS).



---

**NOTE:** If you change the TPM setting to Hidden, TPM is not visible in the operating system.

---

To access TPM settings in Computer Setup:

1. Start Computer Setup. See [Starting Computer Setup on page 69](#).
2. Select **Security**, select **TPM Embedded Security**, and then follow the on-screen instructions.

## Using HP Sure Start (select products only)

Select computer models are configured with HP Sure Start, a technology that continuously monitors the computer's BIOS for attacks or corruption. If the BIOS becomes corrupted or is attacked, HP Sure Start automatically restores the BIOS to its previously safe state, without user intervention.

HP Sure Start is configured and already enabled so that most users can use the HP Sure Start default configuration. The default configuration can be customized by advanced users.

To access the latest documentation on HP Sure Start, go to <http://www.hp.com/support>, and select your country. Select **Drivers & Downloads**, and then follow the on-screen instructions.

---

# 11 HP PC Hardware Diagnostics (UEFI)

HP PC Hardware Diagnostics is a Unified Extensible Firmware Interface (UEFI) that allows you to run diagnostic tests to determine whether the computer hardware is functioning properly. The tool runs outside the operating system so that it can isolate hardware failures from issues that are caused by the operating system or other software components.

---

 **NOTE:** To start BIOS on a convertible computer, your computer must be in notebook mode and you must use the keyboard attached to your tablet. The on-screen keyboard, which displays in tablet mode, cannot access BIOS.

---

To start HP PC Hardware Diagnostics UEFI:

1. Start BIOS:
  - Computers or tablets with keyboards:
    - ▲ Turn on or restart the computer, quickly press **esc**.
  - Tablets without keyboards:
    - ▲ Turn on or restart the tablet, and then quickly hold down the volume down button.
    - or -
    - Turn on or restart the tablet, and then quickly hold down the Windows button.

2. Press or tap **f2**.

The BIOS searches three places for the diagnostic tools, in the following order:

- a. Connected USB drive

---

 **NOTE:** To download the HP PC Hardware Diagnostics (UEFI) tool to a USB drive, see [Downloading HP PC Hardware Diagnostics \(UEFI\) to a USB device on page 74](#).

---

- b. Hard drive
- c. BIOS

3. When the diagnostic tool opens, select the type of diagnostic test you want to run, and then follow the on-screen instructions. On a tablet, press the volume down button to stop a diagnostic test.

---

 **NOTE:** If you need to stop a diagnostic test on computers or tablets with a keyboard, press **esc**.

---

# Downloading HP PC Hardware Diagnostics (UEFI) to a USB device

There are two options to download HP PC Hardware Diagnostics to a USB device:

## Download the latest UEFI version:

1. Go to <http://www.hp.com/go/techcenter/pcdiags>. The HP PC Diagnostics home page is displayed.
2. In the HP PC Hardware Diagnostics section, click the **Download** link, and then select **Run**.

## Download any version of UEFI for a specific product:

1. Go to <http://www.hp.com/support>, and then select your country. The HP Support page is displayed.
2. Click **Drivers & Downloads**.
3. In the text box, enter the product name, and then click **Go**.

– or –

Click **Find Now** to let HP automatically detect your product.

4. Select your computer, and then select your operating system.
5. In the **Diagnostic** section, follow the on-screen instructions to select and download the UEFI version you want.

# 12 Specifications

## Input power

The power information in this section may be helpful if you plan to travel internationally with the computer.

The computer operates on DC power, which can be supplied by an AC or a DC power source. The AC power source must be rated at 100–240 V, 50–60 Hz. Although the computer can be powered from a standalone DC power source, it should be powered only with an AC adapter or a DC power source supplied and approved by HP for use with this computer.

The computer can operate on DC power within the following specifications.

Input Power	Rating
Operating voltage and current	19.5 V dc @ 2.31 A – 45 W
	19.5 V dc @ 3.33 A – 65 W
	19.5 V dc @ 4.62 A – 90 W

 **NOTE:** This product is designed for IT power systems in Norway with phase-to-phase voltage not exceeding 240 V rms.

 **NOTE:** The computer operating voltage and current can be found on the system regulatory label.

## Operating environment

Factor	Metric	U.S.
<b>Temperature</b>		
Operating (writing to optical disc)	<b>5°C to 35°C</b>	41°F to 95°F
Nonoperating	<b>-20°C to 60°C</b>	-4°F to 140°F
<b>Relative humidity</b> (noncondensing)		
Operating	<b>10% to 90%</b>	10% to 90%
Nonoperating	<b>5% to 95%</b>	5% to 95%
<b>Maximum altitude</b> (unpressurized)		
Operating	<b>-15 m to 3,048 m</b>	-50 ft to 10,000 ft
Nonoperating	<b>-15 m to 12,192 m</b>	-50 ft to 40,000 ft

---

# 13 Electrostatic Discharge

Electrostatic discharge is the release of static electricity when two objects come into contact—for example, the shock you receive when you walk across the carpet and touch a metal door knob.

A discharge of static electricity from fingers or other electrostatic conductors may damage electronic components.

To prevent damage to the computer, damage to a drive, or loss of information, observe these precautions:

- If removal or installation instructions direct you to unplug the computer, first be sure that it is properly grounded.
- Keep components in their electrostatic-safe containers until you are ready to install them.
- Avoid touching pins, leads, and circuitry. Handle electronic components as little as possible.
- Use nonmagnetic tools.
- Before handling components, discharge static electricity by touching an unpainted metal surface.
- If you remove a component, place it in an electrostatic-safe container.

---

# 14 Accessibility

HP designs, produces, and markets products and services that can be used by everyone, including people with disabilities, either on a stand-alone basis or with appropriate assistive devices.

## Supported assistive technologies

HP products support a wide variety of operating system assistive technologies and can be configured to work with additional assistive technologies. Use the Search feature on your device to locate more information about assistive features.

---

 **NOTE:** For additional information about a particular assistive technology product, contact customer support for that product.

---

## Contacting support

We are constantly refining the accessibility of our products and services and welcome feedback from users. If you have an issue with a product or would like to tell us about accessibility features that have helped you, please contact us at +1 (888) 259-5707, Monday through Friday, 6 a.m. to 9 p.m. North American Mountain Time. If you are deaf or hard-of-hearing and use TRS/VRS/WebCapTel, contact us if you require technical support or have accessibility questions by calling +1 (877) 656-7058, Monday through Friday, 6 a.m. to 9 p.m. North American Mountain Time.

---

 **NOTE:** Support is in English only.

---

# Index

- A**
  - AC adapter, testing 49
  - accessibility 77
  - administrator password 51
  - airplane mode key 30
  - antivirus software 57
  - Audio 39
  - audio-out (headphone)/audio-in (microphone) combo jack, identifying 5, 6
  - Automatic Drivelock 56
  - Automatic DriveLock password
    - entering 56
    - removing 57
- B**
  - backups 64
  - battery
    - conserving power 47
    - discharging 45
    - displaying remaining charge 45
    - disposing 48
    - low battery levels 45
    - removing 46
    - replacing 48
    - storing 47
  - Battery Check 45
  - battery cover, identifying 24, 25, 27
  - battery information, finding 44
  - battery light 8, 9, 10
  - battery lock latch 25
  - battery power 44
  - battery release latch 25
  - battery release latches 23, 26
  - battery temperature 47
  - BIOS
    - determining version 70
    - downloading an update 71
    - updating 70
  - Bluetooth device 30, 32
  - Bluetooth label 28
  - boot order
    - changing 68
  - bottom 28
- buttons
  - left TouchPad 14
  - optical drive eject 5, 6, 7
  - power 17, 18, 42
  - right TouchPad 14
- C**
  - caps lock light, identifying 15, 16
  - caring for your computer 61
  - cleaning your computer 61
  - components
    - bottom 23
    - display 11
    - front 27
    - left side 8
    - right side 5
    - top 14
  - Computer Setup
    - BIOS administrator password 52
    - DriveLock password 54
    - navigating and selecting 69
    - restoring factory settings 70
  - computer, traveling 47
  - connecting to a WLAN 31
  - connector, power 8, 9, 10
  - conservation, power 47
  - corporate WLAN connection 31
  - critical battery level 42
  - critical updates, software 58
- D**
  - Disk Cleanup software 60
  - Disk Defragmenter software 60
  - display image, switching 22
  - drive light 27
  - drive media 42
  - DriveLock
    - disabling 55
    - enabling 55
  - DriveLock master password
    - changing 56
  - DriveLock password
    - changing 56
    - description 54
    - entering 56
    - setting 54
- E**
  - electrostatic discharge 76
  - embedded numeric keypad, identifying 20
  - esc key, identifying 20, 21
  - external AC power, using 48
  - external monitor port 8, 9, 10, 39
- F**
  - fingerprint reader 59
  - fingerprint reader, identifying 18, 19
  - firewall software 57
  - fn key, identifying 20, 21
  - function keys, identifying 20, 21
- G**
  - GPS 32
- H**
  - hard drive, identifying 23, 25, 26
  - HDMI port
    - connecting 40
  - HDMI port, identifying 8, 9, 10
  - HDMI, configuring audio 41
  - headsets, connecting 38
  - Hibernation
    - exiting 43
    - initiating 43
  - high-definition devices, connecting 40
  - hot keys
    - microphone mute 22
    - Sleep 22
    - switching screen image 22
    - using 22
  - HP 3D DriveGuard 60
  - HP Client Security 58
  - HP Mobile Connect 32
  - HP PC Hardware Diagnostics (UEFI) using 73



HP Recovery Manager  
  correcting boot problems 68  
  starting 67  
HP Recovery media  
  creating 64  
  recovery 67  
HP Recovery partition  
  recovery 67  
  removing 68  
HP resources 2  
HP Touchpoint Manager 58

**I**  
input power 75  
integrated numeric keypad,  
  identifying 21  
integrated webcam light,  
  identifying 11, 12, 13  
internal microphones, identifying  
  11, 12, 13

**J**  
jacks  
  audio-out (headphone)/audio-in  
  (microphone) combo 5, 6  
  network 8, 9, 10  
  RJ-45 (network) 8, 9, 10

**K**  
keypad  
  embedded numeric 20  
  integrated numeric 21  
keys  
  esc 20, 21  
  fn 20, 21  
  function 20, 21  
  Windows application 20  
  Windows key 20, 21

**L**  
labels  
  Bluetooth 28  
  regulatory 28  
  serial number 28  
  service 28  
  wireless certification 28  
  WLAN 28  
latch, battery lock 25  
latch, battery release 25  
latches, battery release 23, 26  
legacy support, USB 69

lights  
  battery 8, 9, 10  
  caps lock 15, 16  
  drive 27  
  microphone mute 15, 16  
  num lock 15, 16  
  power 15, 16  
  RJ-45 (network) 8, 9, 10  
  TouchPad 15, 16  
  webcam 11, 12, 13  
  wireless 15, 16  
locating information  
  hardware 4  
  software 4  
low battery level 45

**M**  
maintenance  
  Disk Cleanup 60  
  Disk Defragmenter 60  
  HP 3D DriveGuard 60  
  updating programs and drivers  
  61  
memory card 42  
memory card reader, identifying 27  
memory module  
  identifying 23, 25, 26  
microphone mute key, identifying  
  22  
microphone mute light, identifying  
  15, 16  
minimized image recovery 67  
minimized image, creating 66

**N**  
network jack, identifying 8, 9, 10  
num lock light 15, 16

**O**  
one-finger slide touch screen  
  gesture 37  
operating environment 75  
optical drive eject button,  
  identifying 5, 6, 7  
optical drive, identifying 5, 6, 7  
original system recovery 66

**P**  
passwords  
  administrator 51  
  BIOS administrator 52

DriveLock 54  
  user 51  
ports  
  external monitor 8, 9, 10, 39  
  HDMI 8, 9, 10, 40  
  USB 5, 6, 7  
  VGA 39  
power  
  battery 44  
  conserving 47  
  options 42  
power button 42  
power button, identifying 17, 18  
power connector, identifying 8, 9,  
  10  
power lights 15, 16  
power switch 42  
power-saving states 42  
product name and number,  
  computer 28  
public WLAN connection 31

**R**  
readable media 42  
recover  
  options 66  
recovery  
  discs 65, 67  
  HP Recovery Manager 66  
  media 67  
  starting 67  
  supported discs 65  
  system 66  
  USB flash drive 67  
  using HP Recovery media 65  
recovery media  
  creating 64  
  creating using HP Recovery  
  Manager 65  
recovery partition  
  removing 68  
regulatory information  
  regulatory label 28  
  wireless certification labels 28  
RJ-45 (network) jack, identifying 8,  
  9, 10  
RJ-45 (network) lights, identifying  
  8, 9, 10

- S**
  - screen image, switching 22
  - security cable slot, identifying 6, 7, 8
  - serial number 28
  - serial number, computer 28
  - service labels, locating 28
  - setting password protection on
    - wakeup 44
  - setting power options 42
  - setup utility
    - navigating and selecting 69
    - restoring factory settings 70
  - shipping the computer 62
  - shutdown 42
  - SIM card
    - inserting 29
  - SIM card slot, identifying 24, 25
  - Sleep
    - exiting 43
    - initiating 43
  - slots
    - security cable 6, 7, 8
    - SIM card 24, 25
  - software
    - antivirus 57
    - critical updates 58
    - Disk Cleanup 60
    - Disk Defragmenter 60
    - firewall 57
    - HP 3D DriveGuard 60
  - sound settings, using 39
  - speakers
    - connecting 38
  - speakers, identifying 17, 19
  - storing a battery 47
  - supported discs, recovery 65
  - Sure Start
    - using 72
  - switch, power 42
  - system recovery 66
  - system restore point
    - creating 65
  - system restore point, creating 64
- T**
  - tap TouchPad and touch screen
    - gesture 36
  - temperature 47
  - testing an AC adapter 49
  - touch screen gestures
    - one-finger slide 37
  - TouchPad
    - buttons 14
    - using 35
  - TouchPad and touch screen gestures
    - tap 36
    - two-finger pinch zoom 36
  - TouchPad gestures
    - two-finger scroll 36
    - two-finger tap 37
  - TouchPad light, identifying 15, 16
  - TouchPad zone
    - identifying 14
  - TPM settings 72
  - traveling with the computer 28, 47, 62
  - turning off the computer 42
  - two-finger pinch zoom TouchPad and touch screen gesture 36
  - two-finger scroll TouchPad gesture 36
  - two-finger tap TouchPad gesture 37
- U**
  - unresponsive system 42
  - updating programs and drivers 61
  - USB 3.0 port 8, 9, 10
  - USB legacy support 69
  - USB ports, identifying 5, 6, 7, 8, 9, 10
  - user password 51
  - using
    - external AC power 48
    - power-saving states 42
  - using sound settings 39
  - using the TouchPad 35
- V**
  - vents, identifying 8, 9, 10, 23, 24, 26
  - VGA port, connecting 39
  - video 39
- W**
  - webcam 11, 12, 13
    - using 38
  - webcam light, identifying 11, 12, 13
  - webcam, identifying 11, 12, 13
  - Windows
    - Windows application key, identifying 20
    - Windows key, identifying 20, 21
    - Windows tools
      - using 65
    - wireless antennas, identifying 11, 12
    - wireless button 30
    - wireless certification label 28
    - wireless controls
      - button 30
      - operating system 30
    - wireless key 30
    - wireless light 15, 16, 30
    - wireless network (WLAN)
      - connecting 31
      - corporate WLAN connection 31
      - functional range 31
      - public WLAN connection 31
    - WLAN antennas, identifying 11, 12, 13
    - WLAN device 28
    - WLAN label 28
    - WLAN, identifying 23, 25, 26
    - writable media 42
    - WWAN
      - identifying 23, 25, 26
    - WWAN antennas, identifying 11, 12
    - WWAN device 30, 31