



User Guide

© 2015 Hewlett-Packard Development
Company, L.P.

Microsoft and Windows are U.S. registered
trademarks of the Microsoft group of
companies.

The information contained herein is subject to
change without notice. The only warranties for
HP products and services are set forth in the
express warranty statements accompanying
such products and services. Nothing herein
should be construed as constituting an
additional warranty. HP shall not be liable for
technical or editorial errors or omissions
contained herein.

First Edition: March 2015

Document Part Number: 816835-001

About This Guide

This guide provides information on setting up the monitor, installing drivers, using the on-screen display menu, troubleshooting and technical specifications.

 **WARNING!** Text set off in this manner indicates that failure to follow directions could result in bodily harm or loss of life.

 **CAUTION:** Text set off in this manner indicates that failure to follow directions could result in damage to equipment or loss of information.

 **NOTE:** Text set off in this manner provides important supplemental information.

Table of contents

1 Product features	1
2 Safety and maintenance guidelines	2
Important safety information	2
Maintenance guidelines	3
Cleaning the monitor	3
Shipping the monitor	3
3 Setting up the monitor	4
Attaching the monitor stand	4
Identifying rear connectors	5
Connecting the cables	6
Installing the touchscreen drivers	7
Installing drivers from the disc	7
Downloading drivers from the Web	7
Mounting the monitor	8
VESA mounting	8
Desktop mounting	9
Flat surface mounting	9
Tilting the monitor	10
Locating the rating labels	10
4 Operating the monitor	11
Installing the monitor driver	11
The Information file	11
The Image Color Matching file	11
Installing the .INF and .ICM files	12
Installing from the disc	12
Downloading from the Web	12
Adjusting the monitor	12
Power	13

Touch	13
Video	13
On-Screen Display (OSD)	14
OSD and power lockouts	15
Appendix A Troubleshooting	16
Solving problems	16
Product support	17
Preparing to call technical support	17
Appendix B Technical specifications	18
Acoustic Pulse Recognition technology	20
Recognizing preset display resolutions	21
Entering user modes	21
Energy saver feature	22
Appendix C Accessibility	23
Supported assistive technologies	23
Contacting support	23

1 Product features

The LCD (liquid crystal display) monitor has an active matrix TFT LCD with LED backlighting. The monitor features include:

- 38.1 cm/15.0 in diagonal display with a maximum resolution of XGA 1024 x 768. Compatible with VGA, SVGA and XGA (non-interlace) color video cards
- Integrated Acoustic Pulse Recognition (APR) technology
- Sealed touchscreen responds to touch with finger, finger nail, solid stylus or gloved hand (cloth, leather or rubber) activation
- Tilt capability
- Power, video and USB cables provided
- Video input supports analog signal inputs
- Plug and play capability if supported by the system
- On-Screen Display (OSD) adjustments in several languages for easy setup and screen optimization
- Software and documentation disc that includes the USB touch driver, HP monitor driver software and product documentation
- Detachable stand for wall mounting application



NOTE: For safety and regulatory information, refer to the *Product Notices* provided on your media disc, if one is included, or in your documentation kit. To locate updates to the user guide for your product, go to <http://www.hp.com/support>, and select your country. Select **Drivers & Downloads**, and then follow the on-screen instructions.

2 Safety and maintenance guidelines

Important safety information

A power cord is included with the monitor. If another cord is used, use only a power source and connection appropriate for this monitor. For information on the correct power cord set to use with the monitor, refer to the *Product Notices* provided on your media disc, if one is included, or in your documentation kit.

 **WARNING!** To reduce the risk of electric shock or damage to the equipment:

- Plug the power cord into an AC outlet that is easily accessible at all times.
- Disconnect power from the monitor by unplugging the power cord from the AC outlet.
- If provided with a 3-pin attachment plug on the power cord, plug the cord into a grounded (earthed) 3-pin outlet. Do not disable the power cord grounding pin, for example, by attaching a 2-pin adapter. The grounding pin is an important safety feature.

For your safety, do not place anything on power cords or cables. Arrange them so that no one may accidentally step on or trip over them. Do not pull on a cord or cable. When unplugging from the electrical outlet, grasp the cord by the plug.

To reduce the risk of serious injury, read the *Safety and Comfort Guide*. It describes proper workstation, setup, posture, and health and work habits for computer users, and provides important electrical and mechanical safety information. This guide is located on the Web at <http://www.hp.com/ergo>.

 **CAUTION:** For the protection of the monitor, as well as the computer, connect all power cords for the computer and its peripheral devices (such as a monitor, printer, scanner) to some form of surge protection device such as a power strip or Uninterruptible Power Supply (UPS). Not all power strips provide surge protection; the power strips must be specifically labeled as having this ability. Use a power strip whose manufacturer offers a Damage Replacement Policy so you can replace the equipment, if surge protection fails.

Use the appropriate and correctly sized furniture designed to properly support your HP LCD monitor.

 **WARNING!** LCD monitors that are inappropriately situated on dressers, bookcases, shelves, desks, speakers, chests, or carts may fall over and cause personal injury.

Care should be taken to route all cords and cables connected to the LCD monitor so that they cannot be pulled, grabbed, or tripped over.

 **NOTE:** This product is suitable for entertainment purposes. Consider placing the display in a controlled luminous environment to avoid interference from surrounding light and bright surfaces that may cause disturbing reflections from the screen.

Maintenance guidelines

To enhance the performance and extend the life of the monitor:

- Do not open the monitor cabinet or attempt to service this product yourself. Adjust only those controls that are covered in the operating instructions. If the monitor is not operating properly or has been dropped or damaged, contact an authorized HP dealer, reseller, or service provider.
- Use only a power source and connection appropriate for this monitor, as indicated on the label/back plate of the monitor.
- Be sure the total ampere rating of the products connected to the outlet does not exceed the current rating of the electrical outlet, and the total ampere rating of the products connected to the cord does not exceed the rating of the cord. Look on the power label to determine the ampere rating (AMPS or A) for each device.
- Install the monitor near an outlet that you can easily reach. Disconnect the monitor by grasping the plug firmly and pulling it from the outlet. Never disconnect the monitor by pulling the cord.
- Turn the monitor off when not in use. You can substantially increase the life expectancy of the monitor by using a screen saver program and turning off the monitor when not in use.



NOTE: Monitors with a “burned-in image” are not covered under the HP warranty.

- Slots and openings in the cabinet are provided for ventilation. These openings must not be blocked or covered. Never push objects of any kind into cabinet slots or other openings.
- Do not drop the monitor or place it on an unstable surface.
- Do not allow anything to rest on the power cord. Do not walk on the cord.
- Keep the monitor in a well-ventilated area, away from excessive light, heat or moisture.
- When removing the monitor stand, you must lay the monitor face down on a soft area to prevent it from getting scratched, defaced, or broken.

Cleaning the monitor

1. Turn off the monitor and unplug the power cord from the back of the unit.
2. Dust the monitor by wiping the screen and the cabinet with a soft, clean antistatic cloth.
3. For more difficult cleaning situations, use a 50/50 mix of water and Isopropyl alcohol.

CAUTION: Spray the cleaner onto a cloth and use the damp cloth to gently wipe the screen surface. Never spray the cleaner directly on the screen surface. It may run behind the bezel and damage the electronics.

CAUTION: Do not use cleaners that contain any petroleum based materials such as benzene, thinner, or any volatile substance to clean the monitor screen or cabinet. These chemicals may damage the monitor.

Shipping the monitor

Keep the original packing box in a storage area. You may need it later if you move or ship the monitor.

3 Setting up the monitor

To set up the monitor, ensure that the power is turned off to the monitor, computer system, and other attached devices, then follow the instructions below.

Attaching the monitor stand

The base comes detached; the neck of the monitor is attached. To mount the base:

1. Unpack the display head and place it face down on a table or flat surface covered by a protective cloth or cushion.
2. Tilt the neck of the stand up and away from the back of the display enclosure.
3. Remove two rubber feet from the bottom of the neck. Two square posts will be revealed.
4. Unpack the base.
5. Align the two square posts into the mating recesses in the stand and then seat the stand against the neck of the monitor.



6. Use the pre-installed D-screw to tighten the base to the neck.



7. Set the monitor upright in preparation for use.

Identifying rear connectors

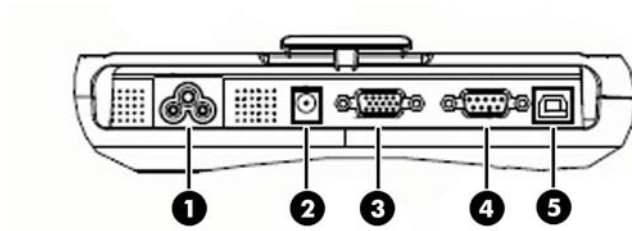

Connector	Function
1 AC Power Input	Connects the AC power cord to the monitor.
2 DC Power Input	Connects an optional DC power adapter to the monitor. (The AC power adapter is purchased separately.)
3 VGA	Connects the VGA video cable to the monitor.
4 Serial	The APR touch technology is NOT supported by the serial port on this model. Use the USB port for APR touch technology.
5 USB	Connects the touchscreen USB cable to the monitor.

Connecting the cables

1. Connect the VGA video cable between the monitor's VGA input connector and your VGA video source, respectively. Tighten the video cable's screws for best performance.
2. Connect the USB touch cable between the monitor's USB connector and your PC's USB port.
3. Select the correct power cable for your region. Connect the power cable between the AC power source and the monitor's AC input power jack.
4. The monitor ships in an OFF state. Press the power button to turn it on.

 **WARNING!** To reduce the risk of electric shock or damage to the equipment:

Do not disable the power cord grounding plug. The grounding plug is an important safety feature.

Plug the power cord into a grounded (earthed) electrical outlet that is easily accessible at all times.

Disconnect power from the equipment by unplugging the power cord from the electrical outlet.

For your safety, do not place anything on power cords or cables. Arrange them so that no one may accidentally step on or trip over them. Do not pull on a cord or cable. When unplugging from the electrical outlet, grasp the cord by the plug.

Installing the touchscreen drivers

The Touch driver software can be downloaded from the Internet or from the HP software and documentation disc included with the monitor.

Installing drivers from the disc

1. Insert the HP software and documentation disc in the computer's optical drive.
2. Select **Install Touchscreen Driver Software** from the disc menu.
3. Install the USB touchscreen driver to begin your touchscreen setup.
4. Click **Next** and follow the on screen instructions to complete the touchscreen setup process.

Downloading drivers from the Web

To download the latest version of touchscreen driver from the HP monitors support Web site:

1. Go to <http://www.hp.com/support> and select the appropriate country and language.
2. Select **Drivers & Downloads** or **Support > Download Drivers**, type your monitor model in the **Find my product** search field, and click **Go**.
3. If necessary, select your monitor from the list.
4. Select your operating system, and then click **Next**.
5. Click **Driver - Display/Monitor** to open the list of drivers.
6. Click on the driver.
7. Click the **System Requirements** tab, and then verify that your system meets the program minimum requirements.
8. Click **Download** and follow the on-screen instructions to download the software.

Mounting the monitor

VESA mounting

If you are mounting the panel to a wall or other mounting fixture, you must remove the monitor stand from the panel. The monitor has four mounting holes on the back side of the panel that adheres to the VESA mounting standard.

 **CAUTION:** This monitor supports the VESA industry standard 75mm mounting holes. To attach a third party mounting solution to the monitor, four 4mm, 0.7 pitch, and 10mm long screws are required (not provided with the monitor). Longer screws should not be used because they may damage the monitor. It is important to verify that the manufacturer's mounting solution is compliant with the VESA standard and is rated to support the weight of the monitor display panel. For best performance, it is important to use the power and video cable provided with the monitor.

To remove the stand and mount the panel:

1. Turn off the monitor and computer.
2. Disconnect the power, USB, and video cables from the monitor and the computer.
3. Lay the monitor face down on a flat surface covered with soft protective cloth.
4. Using a Phillips screwdriver, remove the two screws that secure the stand to the back of the monitor.
5. Follow the instructions from the manufacturer to install the panel to the manufacturer's mounting fixture.
6. Reconnect the power, USB, and video cables to the monitor and the computer.
7. Turn on the computer, then turn on the monitor.

 **NOTE:** A filler plate is included with the monitor to use with the VESA mount.

Desktop mounting

The monitor with the stand attached can be screwed down on a desktop or a tabletop to provide security.

A threaded three-hole mounting pattern for M4 screws is provided on the bottom of the stand base for mounting or securing (1). An additional two-hole pattern is available under small caps on the top of the base (2).

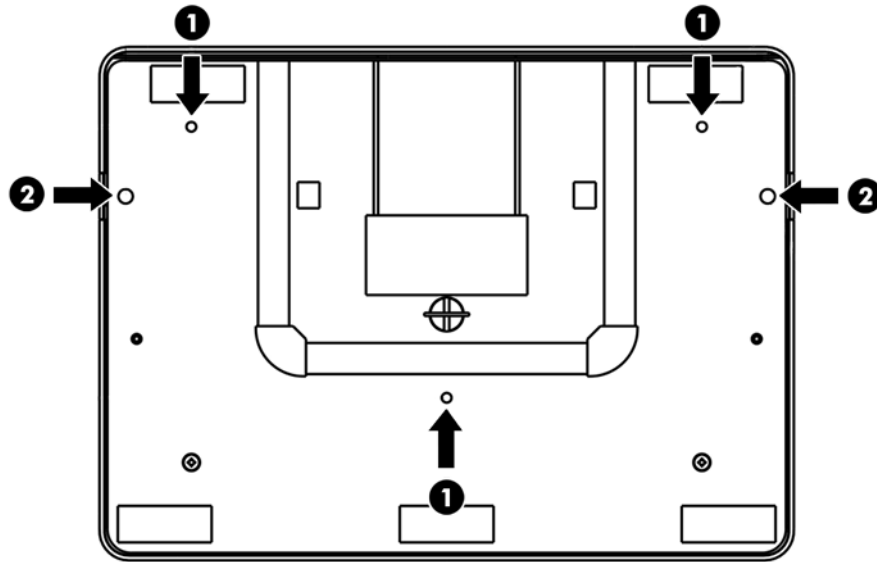

Flat surface mounting

The monitor's stand has covered mounting holes for securing the stand to a flat surface using M4 flathead screws. To use these mounting holes, unsnap the access covers from the outside, install the screws into the holes, and then snap the cover back into place.

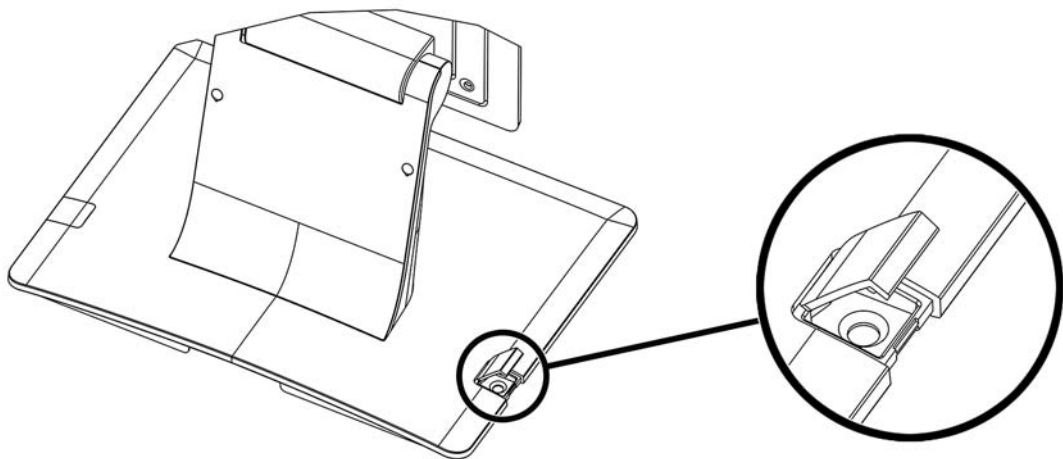

Tilting the monitor

For viewing clarity, tilt the monitor forward (up to -5 degrees) or backward (up to 90 degrees).

 **CAUTION:** In order to protect the monitor, be sure to hold the base when adjusting the LCD, and take care not to touch the screen.

Locating the rating labels

The rating labels on the monitor provide the spare part number, product number, and serial number. You may need these numbers when contacting HP about the monitor model. The rating labels are located on the rear panel of the monitor display head.

4 Operating the monitor

Installing the monitor driver

The disc that comes with the monitor contains monitor driver files you can install on your computer:

- an .INF (Information) file
- an .ICM (Image Color Matching) file



NOTE: If the monitor does not include a disc, the .INF and .ICM files can be downloaded from the HP monitors support Web site. See [Downloading from the Web on page 12](#) in this chapter.

The Information file

The .INF file defines monitor resources used by Microsoft Windows operating systems to ensure monitor compatibility with the computer's graphics adapter.

This monitor is Microsoft Windows Plug and Play compatible and the monitor will work correctly without installing the .INF file. Monitor Plug and Play compatibility requires that the computer's graphic card is VESA DDC2 compliant and that the monitor connects directly to the graphics card. Plug and Play does not work through separate BNC type connectors or through distribution buffers/boxes.

The Image Color Matching file

The .ICM files are data files that are used in conjunction with graphics programs to provide consistent color matching from monitor screen to printer, or from scanner to monitor screen. The .ICM file contains a monitor color system profile. This file is activated from within graphics programs that support this feature.



NOTE: The ICM color profile is written in accordance with the International Color Consortium (ICC) Profile Format specification.

Installing the .INF and .ICM files

After you determine that you need to update, you can install the .INF and .ICM files from the disc or download them.

Installing from the disc

To install the .INF and .ICM files on the computer from the disc:

1. Insert the disc in the computer optical drive. The disc menu is displayed.
2. View the **HP Monitor Software Information** file.
3. Select **Install Monitor Driver Software**.
4. Follow the on-screen instructions.
5. Ensure that the proper resolution and refresh rates appear in the Windows Display control panel.



NOTE: You may need to install the digitally signed monitor .INF and .ICM files manually from the disc in the event of an installation error. Refer to the HP Monitor Software Information file on the disc.

Downloading from the Web

To download the latest version of .INF and .ICM files from the HP monitors support Web site:

1. Go to <http://www.hp.com/support> and select the appropriate country and language.
2. Select **Drivers & Downloads** or **Support > Download Drivers**, type your monitor model in the **Find my product** search field, and click **Go**.
3. If necessary, select your monitor from the list.
4. Select your operating system, and then click **Next**.
5. Click **Driver - Display/Monitor** to open the list of drivers.
6. Click on the driver.
7. Click the **System Requirements** tab, and then verify that your system meets the program minimum requirements.
8. Click **Download** and follow the on-screen instructions to download the software.

Adjusting the monitor

The monitor will unlikely require adjustment. However, variations in video output and application may require adjustments to optimize the quality of the display.

For best performance, the monitor should be operating in native resolution, that is 1024 x 768 at 60 -75 Hz. Use the Display control panel in Windows to choose 1024 x 768 resolution. Operating in other resolutions will degrade video performance.

All adjustments you make to the controls are automatically memorized. This feature saves you from having to reset your choices every time you unplug or power your monitor off and on. If there is a power failure, the monitor settings will not default to the factory specifications.

Power

To turn the monitor on or off, press the monitor power button once.

The Power Status LED on the bottom of the monitor functions according to the following table.

Monitor status	LED status
OFF	OFF
SLEEP	PULSING
ON	ON

The system consumes low power when in SLEEP and OFF modes.

Touching the screen will bring the attached host PC out of SLEEP mode (similar to moving the mouse or pressing a keyboard key).

To improve reliability and reduce wasteful power consumption, disconnect the power adapter when long periods of disuse are planned.

Touch

Your monitor is factory-calibrated and should not need manual calibration (unless the input video is not fully scaled to the native resolution, or the touch experience needs to be calibrated to a specific user).

The touch function is not active until the USB cable is connected to the PC.

Video

A display's native resolution is its width and height measured in number of pixels. Generally, for best performance, an image displayed on this monitor will look best when your computer's output resolution matches this monitor's native resolution, which is 1024 x 768.

For computer output resolutions at non-native resolutions, the monitor will scale the video to its panel's native resolution. This involves stretching or compressing the input image as needed in the X- and Y-dimensions to fit the display's native resolution. An unavoidable byproduct of the scaling algorithms is a loss of fidelity when the computer's output video image is scaled by the monitor to fit the display. This loss of fidelity is most apparent when viewing feature-rich images at close distances (for example images containing small-font text).

Your monitor will likely not require video adjustments. However, for analog VGA video, variations in video graphic card outputs may require user adjustments through the OSD to optimize the quality of the monitor's displayed image. These adjustments are "remembered" by the monitor. Also, to reduce the need for adjustments for different video mode timings, the monitor correctly scales and displays some of the video industry's most common video timing modes.

On-Screen Display (OSD)

Four OSD buttons are on the bottom of the monitor. These can be used to adjust various display parameters.



The buttons and their functionality are:

Button	Function when OSD is not displayed:	Function when OSD is displayed:
Menu	Display OSD main menu	Return to previous OSD menu
◀	Display OSD Brightness menu	Decrease value of selected parameter / select previous menu item
▶	Display OSD Contrast submenu	Increase value of selected parameter / select next menu item
Select	Auto Adjust	Select parameter for adjustment / select submenu to enter

The OSD buttons control an on-screen graphical user interface, which displays on top of your input video. This allows for intuitive adjustment of the following display parameters:

Parameter	Available Adjustment
Brightness	Increase/decrease monitor brightness Default: Maximum
Contrast	Increase/decrease monitor contrast Default: Best gray-shade performance
Clock	Allows fine adjustments of the panel's pixel dot clock <i>Only applicable for VGA input video</i>
Phase	Allows fine adjustments of the panel's pixel dot clock phase <i>Only applicable for VGA input video</i>
Auto Adjust	Automatically adjusts the system clock to the input analog VGA video signal, affecting the H-position, V-position, Clock, and Phase menu items <i>Only applicable for VGA input video</i>
H-position	Moves the image horizontally on the display in single-pixel increments Default: Centered <i>Only applicable for VGA input video</i>
V-position	Moves the image vertically on the display in single-pixel increments Default: Centered <i>Only applicable for VGA input video</i>

Parameter	Available Adjustment
Aspect Ratio	<p>Switches the scaling method between Full Screen and Maintain Aspect Ratio</p> <p>Default: Full Screen</p> <p>Full Screen – scales the X- and Y-dimensions of the input video (up or down as needed) to the display's native resolution.</p> <p>Fill To Aspect Ratio – Assuming a landscape orientation and an input video with aspect ratio smaller than 1024 x 768, scales the Y-dimension of the input video (up or down as needed) to the display's Y-resolution, and scales the X-dimension to maintain the input video's aspect ratio (and fills the rest of the display with equal black bars on the left and right).</p> <p><i>The touchscreen may need recalibration when switching between Aspect Ratio options</i></p>
Sharpness	<p>Adjusts sharpness of the displayed images</p> <p>Default: No sharpness adjustment</p> <p><i>Only applicable at non-native input video resolutions</i></p>
Color Temperature	<p>Selects the display's color temperature. The available color temperatures are 9300K, 7500K, 6500K, 5500K, and User Defined. If the User Defined option is selected, the user can change the color temperature by changing individual R, G, and B gains on a scale from 0 to 100.</p> <p>Default: User Defined with R, G, and B all set to 100</p>
OSD Timeout	<p>Adjusts how long a period of OSD button inactivity the monitor will wait before closing the OSD. The adjustable range is between 5 and 60 seconds.</p> <p>Default: 15 seconds</p>
OSD Language	<p>Selects which language the OSD information is displayed in. The available languages are: English, French, Italian, German, Spanish, Simplified Chinese, Traditional Chinese, and Japanese</p> <p>Default: English</p>
Recall Defaults	<p>Selecting "Recall Defaults" restores all factory default settings for OSD-adjustable parameters (except OSD Language) and for Preset Video Mode timings.</p>
Video Source	<p>The monitor continually scans for active video on the VGA connector.</p>

All monitor adjustments made through the OSD are automatically memorized as soon as they are entered. This feature saves you from having to reset your choices every time the monitor is unplugged or powered off and on. If there is a power failure, the monitor settings will not default to the factory specifications

OSD and power lockouts

Press and hold the Menu and Right Arrow buttons for two seconds to enable/disable the OSD Locking feature. When the OSD Locking is enabled, pressing any of the Menu, Right Arrow, Left Arrow, or Select buttons will have no effect on the system.

Press and hold the Menu and Left Arrow buttons for two seconds to enable/disable the Power Locking feature. When the Power Locking is enabled, pressing the power switch will have no effect on the system.

A Troubleshooting

Solving problems

The following table lists possible problems, the possible cause of each problem, and the recommended solutions.

Problem	Suggested Troubleshooting
The monitor does not respond when turning on the system	Check that the AC power cord is properly connected
Monitor display is dim	Use the OSD to increase the brightness Use the OSD to increase the contrast
Monitor display is blank	If the Power Status LED is blinking, the monitor may be in SLEEP mode. Press any key / move the mouse / touch the Touchscreen to see if the image reappears Check that the signal source device is turned on Check that there are no loose cable connections
Monitor displays an "Out Of Range" message	Adjust your computer's resolution/timing mode to be within the allowable timing ranges specified for your monitor (see website for specifications)
Monitor display image looks abnormal	Adjust your computer's resolution/timing mode to be within the allowable timing ranges specified for your monitor (see website for specifications) Use the Auto Adjust function in the OSD
Touch functionality doesn't work	Verify your PC has the latest drivers installed Perform the calibration routine provided with the latest drivers
The OSD buttons or power button does not respond when pressed	Check to see if the OSD lock or power lock functions are on

Product support

For additional information on using your monitor, go to <http://www.hp.com/support>. Select your country or region, select **Troubleshooting**, and then enter your model in the search window and click the **Go** button.



NOTE: The monitor user guide, reference material, and drivers are available at <http://www.hp.com/support>.

If the information provided in the guide does not address your questions, you can contact support. For U.S. support, go to <http://www.hp.com/go/contactHP>. For worldwide support, go to http://welcome.hp.com/country/us/en/wwcontact_us.html.

Here you can:

- Chat online with an HP technician



NOTE: When support chat is not available in a particular language, it is available in English.

- Find support telephone numbers
- Locate an HP service center

Preparing to call technical support

If you cannot solve a problem using the troubleshooting tips in this section, you may need to call technical support. Have the following information available when you call:

- The monitor
- Monitor model number
- Serial number for the monitor
- Purchase date on invoice
- Conditions under which the problem occurred
- Error messages received
- Hardware configuration
- Hardware and software you are using

B Technical specifications



NOTE: All performance specifications are provided by the component manufacturers. Performance specifications represent the highest specification of all HP's component manufacturers' typical level specifications for performance. Actual performance may vary either higher or lower.

Active Display Area	304 x 228 mm / 11.97 x 8.98 inches
Monitor Dimensions (with stand)	358 x 197 x 319 mm / 14.1 x 7.8 x 12.5 inches (dimensions vary with stand position and options selected)
Monitor Thickness	43 mm / 1.7 inches panel depth
LCD Technology	Active matrix TFT LCD with LED backlighting
Diagonal Size	38.1 cm/15.0 in
Aspect Ratio	4:3
Native (Optimal) Resolution	1024 x 768
Other Supported Resolutions	640 x 480 @ 60Hz, 75Hz; 720 x 400 @ 70Hz; 800 x 600 @ 56Hz, 60Hz, 75Hz; 1024 x 768 @ 60Hz, 75Hz
Colors	16.2 million
Brightness (typical)	225 nits
Response Time – Total (typical)	16 msec
Viewing Angle (typical)	Horizontal: +/-80° or 160° total; Vertical: +/-70° or 140° total
Contrast Ratio (typical)	700:1
Video	Analog VGA on Female DE-15 connector Input Video Horizontal Sync frequency range: 31.5-60KHz. Input Video Vertical Sync (frame rate) frequency range: 56-75Hz
Power	Monitor input power connector – AC: IEC 60320 C6. Monitor input power signal specifications: 100-240VAC, 50/60Hz Monitor input power connector – DC: Coaxial power jack (2.1mm pin outer diameter, 6.4mm barrel inner diameter) Monitor input power signal specifications: 12VDC ±5% Note: Optional AC-DC power adapter sold for this monitor. Adapter input connector: IEC 60320 C14 Adapter input voltage range: 100-240VAC, 50/60Hz Power Consumption (Typical): ON (monitor): 12W; SLEEP (monitor): 1.7W; OFF (monitor): 1.3W
Weight (with stand)	Unpackaged: 4.3 kg / 9.5 lb; Packaged: 7.3 kg / 16.0 lb.

Shipping Dimensions	487 x 231 x 485 mm / 19.2 x 9.1 x 19.1 inches
Mounting Options	75 mm VESA mount, capped through-mount holes
On-Screen Display (OSD) Controls (Accessible through switches along the bottom)	<p>Controls: Menu, Left, Right, Select</p> <p>Settings: Brightness, Contrast, Clock , Phase, H- position, V-Position, Auto-Adjust, Aspect Ratio, Sharpness, Color Temperature, OSD Timeout, OSD Language, Recall Defaults</p> <p>Languages: English, French, Italian, German, Spanish, Simplified Chinese, Traditional Chinese, Japanese</p> <p>Lockouts: OSD, Power</p>
Temperature	Operating: 0 °C to 40 °C /32 °F to 104 °F; Storage: -20 °C to 60 °C /-4 °F to 140 °F
Humidity (non-condensing)	Operating: 20%-80%; Storage: 10%-90%
Touch Interface	USB
MTBF	50,000 hours demonstrated

Acoustic Pulse Recognition technology

Input Method	Finger, finger nail, solid stylus or gloved hand (cloth, leather or rubber) activation
Mechanical Positional Accuracy	1% maximum error
Resolution Accuracy	Touchpoint density is based on controllers resolution of 4096 x 4096
Touch Activation Force	Typically 2 to 3 ounces (55 to 85 grams)
Controller	Board: USB 1.1
Optical Light Transmission	90% +/- 5%
Environmental Chemical Resistance	<p>The touch activation area of the touchscreen is resistant to chemicals such as:</p> <ul style="list-style-type: none">• Acetone• Toluene• Methy ethyl ketone• Isopropyl alcohol• Methyl alcohol• Ethyl Acetate• Ammonia-based glass cleaners• Gasoline• Kerosene• Vinegar
Surface Durability Expected Life	Surface durability is that of glass, Hobs' hardness rating of 7. No known wear-out mechanism, as there are no layers, coatings or moving parts. APR technology has been operationally tested to more than 50 million touches in one location without failure, using a stylus similar to a finger.

Recognizing preset display resolutions

The display resolutions listed below are the most commonly used modes and are set as factory defaults. This monitor automatically recognizes these preset modes and they will appear properly sized and centered on the screen.

Preset	Pixel Format	Horz Freq (kHz)	Band Width (MHz)
1	VGA 640 x 350 70Hz	31.5	28.322
2	VGA 720 x 400 70Hz	31.47	28.322
3	VGA 640 x 480 60Hz	31.47	25.175
4	MAC 640 x 480 66Hz	35.00	32.24
5	VESA 640 x 480 72Hz	37.86	31.5
6	VESA 640 X 480 75Hz	37.50	31.5
7	VESA 800 X 600 56Hz	35.16	36
8	VESA 800 X 600 60Hz	37.88	40
9	VESA 800 X 600 75Hz	46.88	49.5
10	VESA 800 x 600 72Hz	48.08	50
11	MAC 832 x 624 75Hz	49.72	57.283
12	VESA 1024 x 768 65Hz	48.36	65
13	SUN 1024 x 768 65Hz	52.45	70.49
14	VESA 1024 x 768 70Hz	56.48	75
15	VESA 1024 x 768 75Hz	60.02	78.75

Entering user modes

The video controller signal may occasionally call for a mode that is not preset if:

- You are not using a standard graphics adapter.
- You are not using a preset mode.

If this occurs, you may need to readjust the parameters of the monitor screen by using the on-screen display. Your changes can be made to any or all of these modes and saved in memory. The monitor automatically stores the new setting, then recognizes the new mode just as it does a preset mode. In addition to the factory preset modes, there are 7 user modes that can be entered and stored.

The only condition to store as a user mode is the new display information must have 1 KHz difference for horizontal frequency or 1 Hz for vertical frequency or the sync signal polarities are different from the default modes.

Energy saver feature

When the monitor is in its normal operating mode, the monitor uses less than 21 watts and the Power light is green.

The monitor also supports a reduced power state. The reduced power state will be entered into if the monitor detects the absence of either the horizontal sync signal and/or the vertical sync signal. Upon detecting the absence of these signals, the monitor screen is blanked, the backlight is turned off, and the power light is turned amber. When the monitor is in the reduced power state, the monitor will utilize less than 2 watts of power. There is a brief warm up period before the monitor will return to its normal operating mode.

Refer to the computer manual for instructions on setting energy saver features (sometimes called power management features).



NOTE: The above power saver feature only works when connected to computers that have energy saver features.

By selecting the settings in the monitor's Energy Saver utility, you can also program the monitor to enter into the reduced power state at a predetermined time. When the monitor's Energy Saver utility causes the monitor to enter the reduced power state, the power light blinks amber.

C Accessibility

HP designs, produces, and markets products and services that can be used by everyone, including people with disabilities, either on a stand-alone basis or with appropriate assistive devices.

Supported assistive technologies

HP products support a wide variety of operating system assistive technologies and can be configured to work with additional assistive technologies. Use the Search feature on your device to locate more information about assistive features.



NOTE: For additional information about a particular assistive technology product, contact customer support for that product.

Contacting support

We are constantly refining the accessibility of our products and services and welcome feedback from users. If you have an issue with a product or would like to tell us about accessibility features that have helped you, please contact us at (888) 259-5707, Monday through Friday, 6 a.m. to 9 p.m. Mountain Time. If you are deaf or hard-of-hearing and use TRS/VRS/WebCapTel, contact us if you require technical support or have accessibility questions by calling (877) 656-7058, Monday through Friday, 6 a.m. to 9 p.m. Mountain Time.