



f555g

Car Camcorder
User Manual

Contents

About this Guide	3
FCC Statement	3
WEEE Notice.....	4
CE Regulatory Notice	4
Battery warning.....	4
Notes on Installation	5
Caution	5
1 Introduction	7
1.1 Features.....	7
1.2 Package Contents	7
1.3 Product Overview.....	8
2 Getting Started	9
2.1 Inserting the Memory Card	9
2.2 Installing in Vehicles	10
2.2.1 Mount to Windshield	10
2.2.2 Adjust the camcorder position	11
2.3 Connecting to Power	12
2.4 LED Indicator.....	13
2.5 Powering the Camcorder On / Off	14
2.5.1 Auto Power On/Off	14
2.5.2 Manual Power On/Off and Reset.....	14
2.5.2.1 Manual Power On	14
2.5.2.2 Power Off	14
2.5.2.3 Reset the camcorder	14
2.6 Initial Settings.....	15
2.6.1 Set the Date / Time	15
2.6.2 Set Automatic Record.....	15
2.6.3 Set the Satellite Synchronization.....	16

2.6.4	Set Timezone	16
2.6.5	Setting the Universal Time Code (UTC)	17
3	Using the Car Camcorder	18
3.1	Recording Videos	18
3.1.1	The Recording Screen.....	18
3.1.2	Record videos while driving	19
3.1.3	Emergency Recording	19
3.1.4	Stop/Start recording	20
3.1.5	Taking Snapshot.....	20
3.1.6	HDR (High Dynamic Range)	20
3.1.7	Headlight Warning	21
3.1.8	Driver Fatigue Alert	21
3.1.9	LDWS (Lane Departure Warning Systems)	22
3.1.10	FCWS (Forward Collision Warning System)	23
3.1.11	FCMD (Front Car Move Detection).....	24
3.1.12	Parking Mode	25
3.1.13	Speed Cam Alert.....	27
3.1.14	4 GRID FUNCTION CHART	28
3.2	Playback Videos and Photos.....	29
3.2.1	Video Playback.....	29
3.2.2	Viewing Photos	30
3.2.3	The Playback Screen	30
3.2.4	Deleting Files	31
4	Adjusting the settings.....	32
4.1	Using the menu.....	32
4.2	Menu Items	33
5	Installing the Software	37
6	SuperCar	38
7	Specifications	39

About this Guide

The content in this document is for information purpose and is subject to change without prior notice. We made every effort to ensure that this User Guide is accurate and complete.

However, no liability is assumed for any errors and omissions that may have occurred.

The manufacturer reserves the right to change the technical specifications without prior notice.

FCC Statement

This equipment has been tested and found to comply with the limits for a Class B digital camcorder, pursuant to Part 15 of the FCC Rules. These limits are designed to provide reasonable protection against harmful interference in a residential installation. This equipment generates, uses and can radiate radio frequency energy and, if not installed and used in accordance with the instructions, may cause harmful interference to radio communications. However, there is no guarantee that interference will not occur in a particular installation. If this equipment does cause harmful interference to radio or television reception, which can be determined by turning the equipment off and on, the user is encouraged to try to correct the interference by one or more of the following measures:

- Reorient or relocate the receiving antenna.
- Increase the separation between the equipment and receiver.
- Connect the equipment into an outlet on a circuit different from that to which the receiver is connected.
- Consult the dealer or an experienced radio/TV technician for help.

This camcorder complies with Part 15 of the FCC Rules. Operation is subject to the following two conditions: (1) This camcorder may not cause harmful interference, and (2) this camcorder must accept any interference received, including interference that may cause undesired operation.

FCC Caution: Any changes or modifications not expressly approved by the party responsible for compliance could void the user's authority to operate this equipment.

WEEE Notice

Disposal of Waste Electrical and Electronic Equipment and/or Battery by users in private households in the European Union



This symbol on the product or on the packaging indicates that this cannot be disposed of as a household waste. You must dispose of your waste equipment and/or battery by handing it over to the applicable take-back scheme for the recycling of electrical and electronic equipment and/or battery. For more information about recycling of this equipment and/or battery, please contact your city office, the shop

where you purchased the equipment or your household waste disposal service. The recycling of materials will help to conserve natural resources and ensure that it is recycled in a manner that protects human health and environment.

CE Regulatory Notice

The product herewith complies with the requirements of the Low Voltage Directive 2006/95/EC, the EMC Directive 2014/30/EU, the R&TTE Directive 1999/5/EC and the RoHS Directive 2011/65/EC.

Battery warning

- ❖ Always charge using the provided system. Improper handling of the battery may result in explosion.
- ❖ Never dismantle or pierce the battery or allow the battery to short-circuit.
- ❖ Keep the battery out of reach of children.
- ❖ Batteries may explode if exposed to open fire. Never dispose of batteries in a fire.
- ❖ Do not place or expose the battery under extreme heat.
- ❖ Disposed of used batteries observing local regulations.
- ❖ **Never replace the battery on your own; have the dealer do it for you.**

Notes on Installation

1. This product shall be installed near the rear view mirror, at the center and top of windshield for optimal viewing.
2. Make sure that the lens is within the wiping range of the windshield wiper to ensure a clear view even when it rains.
3. Do not touch the lens with your fingers. Finger grease may be left on the lens and will result in unclear videos or snapshots. Clean the lens on a regular basis.
4. Do not install the camcorder on a tinted window. Doing so may damage the tint film.
5. Make sure that the installation position is not hindered by the tinted window.
6. To use the products of the attached power charger only, please do not use other brand power charger, in order to avoid equipment burn or cause the battery explosion.

Caution

- ❖ Due to local laws and vehicles safety considerations, do not operate the camcorder while driving.
- ❖ Set up time and date accurately before you use this camcorder.
- ❖ Please use SuperCar software in condition that Electronic Map is function normally.
- ❖ The firmware function in the camcorder is for reference only, please follow the actual road condition.
- ❖ The results of GPS positioning are only for reference, and should not affect the actual driving situation. The system also cannot ensure the positioning accuracy.
- ❖ GPS positioning accuracy may differ depending on weather and location such as high buildings, tunnels, undergrounds, or forests. GPS satellite signals cannot pass through solid materials (except

glass). Tinted window will also affect the performance of the GPS satellite reception.

- ❖ GPS reception performance on each camcorder may differ. The system cannot determine the accuracy of the positioning results from different camcorders.
- ❖ The values displayed in this system, such as speed, position, and the distance warning to the speed camera set points, may be inaccurate due to the influence of surrounding environment. They are for your reference only.
- ❖ The system is used only for non-commercial use, within the maximum limits permitted by applicable law. Our company does not accept any responsibility for any data loss during the operation.
- ❖ This product gets warm when in use; this is normal.
- ❖ Improper use or operation of the product may result in damage of the product or its accessories and void the warranty.

Before you start using the system, it is assumed that you agree to the above statement.

1 Introduction

Thank you for purchasing this advanced Car Recorder. This camcorder is specifically designed for real time video recording when driving.

1.1 Features

- Full HD recording videos (1920x1440@30fps)
- 2.31" LCD color screen
- Wide angle lens
- Multifunction traffic safety reminder
- Automatic Emergency recording for collision detection
- Supports micro SDHC memory cards class 10 speed or greater up to 32GB.

1.2 Package Contents

The package contains the following items. In case there is any missing or damaged item, contact your dealer immediately.

Car Recorder



Quick start guide



CD-ROM

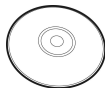

Bracket



Car adapter



1.3 Product Overview

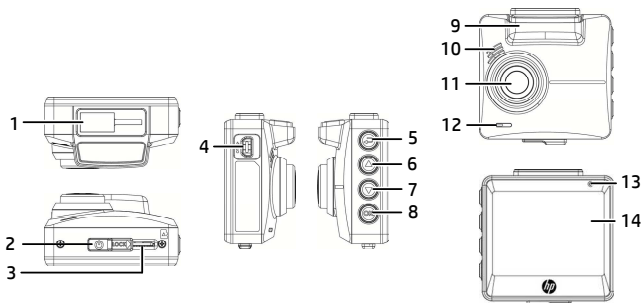

No.	Item
1	Bracket Socket
2	Power Switch
3	Memory Card Slot
4	USB / Power Connector
5	Back Button (↶)
6	Up Button (▲)
7	Down Button (▼)

No.	Item
8	Enter Button (OK)
9	GPS Antenna
10	Speaker
11	Wide Angle Lens
12	Microphone
13	LED Indicator
14	LCD Panel

2 Getting Started

2.1 Inserting the Memory Card

Insert memory card with the gold section facing upward and the screen of the camcorder facing upward too, as illustrated. Push the memory card in until a click sound is heard, indicating the card is in position.

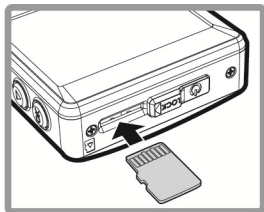

To remove the memory card

Push to eject the memory card out of the slot.

Note:

1. Do not remove or insert the memory card when the camcorder is turned on. This may damage the memory card.
2. Please use a Class 10 or higher rating Micro SD card, max. up to 32GB.
3. Please format the micro SD cards before the initial use.
4. When removing the memory card, please take note that the memory card will be ejected quickly and may get lost. This is a characteristic of the memory card ejection slot to facilitate easy removal by the user.

2.2 Installing in Vehicles

2.2.1 Mount to Windshield

1. Attach the bracket to the camcorder. Slide it into the bracket holder until you hear a click.

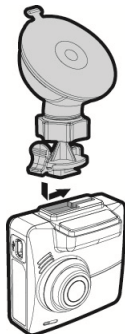

2. Before installing the bracket, please use alcohol to clean the windshield and suction cup of the bracket. Wait for dry and press suction-cup on the windshield.



3. Hold the base firmly on the windshield and press down the clamp to mount the car holder to the windshield. Make sure the base is securely locked in place.

2.2.2 Adjust the camcorder position

1. Loosen the knob to swivel the camcorder vertically or horizontally.

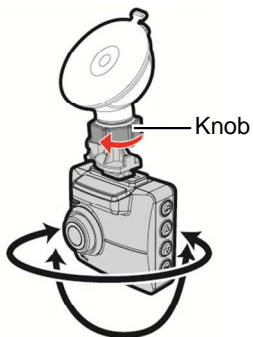

2. Then tighten the knob to make sure the camcorder is securely locked in place.

2.3 Connecting to Power

Use only the attached power connector for activating the camcorder and charging the built-in battery.

1. Connect one end of power connector to USB/Power connector port on the camcorder.

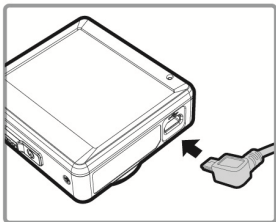



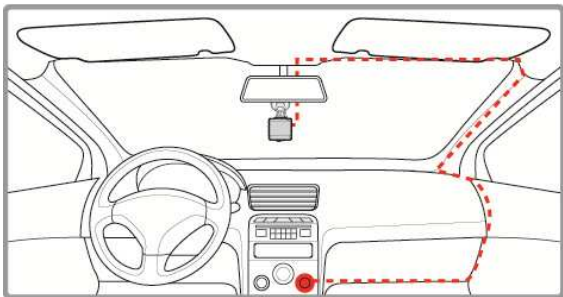



2. Plug the other end of the car adapter to the cigarette lighter socket of your vehicle. Once the vehicle engine is started, the camcorder automatically turns on.



Note:

This camcorder shall be installed near the rear view mirror, at the center and top of windshield for optimal viewing.

Battery Status Indicator :

Icon	Description
	Full battery power.
	2/3 battery power.
	1/3 battery power.
	Out of battery power.
	Battery is charging.
	Connect the car adapter to charge the battery, battery is full charged.

Note:

1. Please take note if the environment temperature reaches 45°C or above, the car adapter still can supply power to camcorder, but it will not charge the Lithium-ion battery. This is the characteristic of Lithium-ion and is not a malfunction.
2. If the operation temperature is below 0 °C, the camcorder still can power on but unable to operate. The camcorder will start Automatic Record when the operation temperatures above 0 °C

2.4 LED Indicator

Status Explanation	LED Indicator Color
Power off, battery charging	Red
Power off, battery full charged	LED light off
Power on, battery charging	Red
Power on, battery full charged	Green
Standby / Standby and screen off	Green
Recording/ Recording and screen off	Red

2.5 Powering the Camcorder On / Off

2.5.1 Auto Power On/Off

Once the vehicle engine is started, the camcorder automatically turns on. If the **Automatic Record** function is enabled, the recording will automatically start right after the camcorder turns on. Please refer to **Set Automatic Record** (2.6.2)

2.5.2 Manual Power On/Off and Reset

2.5.2.1 Manual Power On

Push the **power switch** and make sure that the power switch locks on the memory card slot.

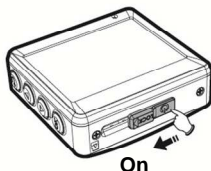

2.5.2.2 Power Off

Push the **power switch** and make sure that the memory slot is released and the camcorder starts power off sequence. Do not power on the camcorder when it is in the power-off sequence, or the recorded file may become corrupt.

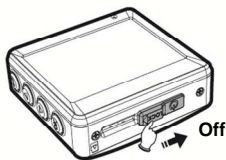

2.5.2.3 Reset the camcorder

In case the camcorder fails to function normally due to unknown causes, push the **power switch** and verify the memory card is in the removable state; wait for 7 seconds and push the power switch again to restart the camcorder.

2.6 Initial Settings

Before using the camcorder, we recommend you to set up the correct **Date and Time** and **Automatic Record**. ◦

2.6.1 Set the Date / Time

To set the correct date and time, do the following:

1. If recording is in progress, press the ▼ button to stop recording.
2. Press the ↶ button to enter the OSD menu.
3. Press the ▲/▼ button to select **Date / Time** and press the OK button.
4. Press the ▲/▼ button to adjust the value and press the OK button to move to another field.
5. Repeat step 4 until the date and time setting is complete.

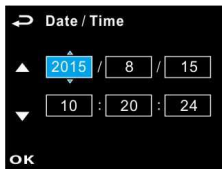

2.6.2 Set Automatic Record

Default setting of Automatic Record is enabled. The camcorder will automatically start recording when powered on. In case Automatic Record is disabled, enable it by the following steps:

1. If recording is in progress, press the ▼ button to stop recording.
2. Press the ↶ button to enter the OSD menu.
3. Press the ▲/▼ button to select **Automatic Record** and press the OK button.
4. Press the ▲/▼ button to select **On** and press the OK button.
5. Press the ↶ button to exit the menu.



2.6.3 Set the Satellite Synchronization

To set the proper satellite time zone (satellite synchronization), follow the steps below:

1. If recording is in progress, press the ▼ button to stop recording.
2. Press the ↶ button to enter the OSD menu.
3. Press ▲/▼ to select **Satellite Synchronization** and press OK into the function.
4. Press ▲/▼ to select **On**, then press OK to turn on the function.

2.6.4 Set Timezone

1. If recording is in progress, press the ▼ button to stop recording.
2. Press the ↶ button to enter the OSD menu.
3. Press the ▲ / ▼ button, select the **Set Timezone** and then press the OK button, then press the ▲ / ▼ button to select the correct time zone that the country is located and then press the OK button. After this, the time synchronization setting is completed.

Note:

1. If **Satellite Synchronization** is on, camcorder clock will be calibrated via satellite clock signal based on **Set Timezone**. Please refer to (4.2)
2. If satellite positioning is not successful, camcorder clock will run based on user defined time.

2.6.5 Setting the Universal Time Code (UTC)

Depending on your location, you may need to change the current UTC setting of the camcorder so that the correct date and time are updated when a GPS signal is detected.

1. If recording is in progress, press the ▼ button to stop recording.
2. Press the ↶ button to open the OSD menu.
3. Use the ▲ or ▼ buttons to navigate to the **Satellite Synchronization** option and press the **OK** button. Ensure that the **On** setting is selected and press the **OK** button again to view the UTC setting.
4. Refer to the UTC Map below and use the ▲ or ▼ button to select the desired setting and press the **OK** button to confirm the setting.
5. Press the ↶ button to exit the menu.

City	UTC	City	UTC	City	UTC	City	UTC	City	UTC
Accra	0	Budapest *	+1	Houston *	-6	Melbourne	+10	Santiago	-4
Addis Ababa	+3	Buenos Aires	-3	Indianapolis *	-5	Mexico City *	-6	Santo Domingo	-4
Adelaide **	+9	Cairo	+2	Islamabad	+5	Miami	-5	São Paulo	-3
Algiers	+1	Calgary *	-7	Istanbul *	+2	Minneapolis *	-6	Seattle *	-8
Almaty	+6	Canberra	+10	Jakarta	+7	Minsk	+3	Seoul	+9
Amman *	+2	Cape Town	+2	Jerusalem *	+2	Montevideo	-3	Shanghai	+8
Amsterdam *	+1	Caracas **	-4	Johannesburg	+2	Montréal *	-5	Singapore	+8
Anadyr	+12	Casablanca *	0	Kabul **	+4	Moscow	+4	Sofia *	+2
Anchorage *	-9	Chicago *	-6	Karachi	+5	Mumbai **	+5	St. John's **	-3
Ankara *	+2	Columbus *	-5	Kathmandu **	+5	Nairobi	+3	Stockholm *	+1
Antananarivo	+3	Copenhagen *	+1	Khartoum	+3	Nassau *	-5	Suva	+12
Asuncion	-4	Dallas *	-6	Kingston	-5	New Delhi **	+5	Sydney	+10
Athens *	+2	Dar es Salaam	+3	Kinshasa	+1	New Orleans *	-6	Taipei	+8
Atlanta *	-5	Darwin **	+9	Kiritimati	+14	New York *	-5	Tallinn *	+2
Auckland	+12	Denver *	-7	Kolkata **	+5	Oslo *	+1	Tashkent	+5
Baghdad	+3	Detroit *	-5	Kuala Lumpur	+8	Ottawa *	-5	Tegucigalpa	-6
Bangalore	+5	Dhaka	+6	Kuwait City	+3	Paris *	+1	Tehran **	+3
Bangkok	+7	Doha	+3	Kyiv *	+2	Perth	+8	Tokyo	+9
Barcelona *	+1	Dubai	+4	La Paz	-4	Philadelphia *	-5	Toronto *	-5
Beijing	+8	Dublin *	0	Lagos	+1	Phoenix	-7	Vancouver *	-8
Beirut *	+2	Edmonton *	-7	Lahore	+5	Prague *	+1	Vienna *	+1
Belgrade *	+1	Frankfurt *	+1	Las Vegas *	-8	Reykjavik	0	Warsaw *	+1
Berlin *	+1	Guatemala	-6	Lima	-5	Rio de Janeiro	-3	Washington DC *	-5
Bogota	-5	Halifax *	-4	Lisbon *	0	Riyadh	+3	Winnipeg *	-6
Boston *	-5	Hanoi	+7	London *	0	Rome *	+1	Yangon **	+6
Brasilia	-3	Harare	+2	Los Angeles *	-8	Salt Lake City *	-7	Zagreb *	+1
Brisbane	+10	Havana *	-5	Madrid *	+1	San Francisco *	-8	Zürich *	+1
Brussels *	+1	Hong Kong	+8	Managua	-6	San Juan	-4		
Bucharest *	+2	Honolulu	-10	Manila	+8	San Salvador	-6		

* Be sure to adjust for daylight saving time (DST) by adding +1 hour to the UTC offset.





** These areas may observe half hour increments and daylight saving time (DST).

3 Using the Car Camcorder

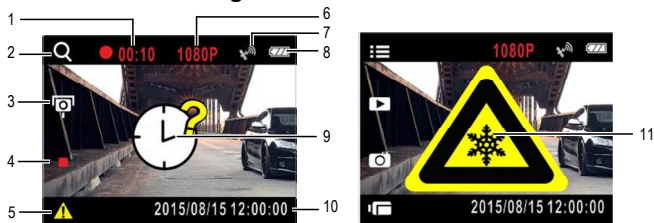
3.1 Recording Videos

3.1.1 The Recording Screen



No.	Item	Description
1	Duration	Indicates the recording duration.
2	4 GRID FUNCTION CHART	You will see the 4 GRID FUNCTION CHART in the LCD screen after you push  button.
3	Add speed point	Press the  button to add speed point.
4	Stop recording	Press the  button to stop recording.
5	Emergency recording	Press the OK button to start manual emergency recording.
6	Resolution	Indicates the video resolution.
7	GPS icon	After the GPS is positioned, a  icon will be displayed on the screen.
8	Battery	Indicates the remaining battery power.
9	Date/Time setting reminder	Reminds that the date and time have not been set up yet.

10	Date/Time	Refers to the prevailing date and time of recording.
11	Temperature	Refers to when the operation temperature is below 0 ° C, the camcorder cannot be operated.

3.1.2 Record videos while driving

When the vehicle engine starts up and the **Automatic Record** function is enabled, the camcorder automatically turns on and starts recording. Recording stops and shut down after the engine is switched off.

Note:

On some cars, the recording will continue when the engine is switched off. If this happens, please manually turn off the cigarette lighter or remove the car adapter from the cigarette lighter.

3.1.3 Emergency Recording

To start Emergency Recording, do the following:

1. During the recording period, press the **OK** button to enter emergency recording mode. The wordings, **“Emergency”**, will be displayed on the top right-hand corner of the display screen. Files that are saved during the emergency recording mode will be protected.
2. Press the ▼ to stop recording immediately.



Note:

1. If the **Collision Detection** function is enabled and a collision is detected, the camcorder will automatically trigger the emergency recording. Please refer to (4.2).
2. The emergency recording file is created as a new file, which will be protected to avoid being overwritten by normal cycling recording. 8G (or above) memory card can save up to 10 emergency video files. The alert message of **“Emergency files are full”** will pop up on the screen when the emergency recording files are full, and the oldest emergency file will be automatically deleted when a new emergency recording file is created.

3.1.4 Stop/Start recording

1. Press the ▼ button to stop recording.
2. Press the OK button to start recording.

Note:

1. It can be configured to save a video file for every 3 or 5 minutes of recording. Please refer to (4.2).
2. The camcorder saves the recording in the memory card. If the memory card capacity is full, the oldest file in the memory card is overwritten.

3.1.5 Taking Snapshot

You can also use this camcorder to take snapshots of the current scene.

1. If recording is in progress, press the ▼ button to stop recording.
2. Press the ▼ button to take a snapshot.



3.1.6 HDR (High Dynamic Range)

HDR (High Dynamic Range) will be activated under the HDR 1920 x 1080 @30fps mode of the camcorder. Its purpose is to provide clear images even under backlighting, when there are very bright and very dark areas simultaneously in the camera's field of view.

3.1.7 Headlight Warning

The **Headlight Warning** function produces voice and screen message alerts when it detects poor lighting conditions through the recording displays of this product, including driving in rainy or cloudy weather, at night, and in basements, parking lots, and tunnels.

1. If recording is in progress, press the ▼ button to stop recording.
2. Press the ↶ button to enter the OSD menu.
3. Press the ▲/▼ button, select **Headlight Warning**, and then press the **OK** button.
4. Press the ▲/▼ button, select **On**, and press the **OK** button.
5. Press the ↶ button to exit the menu.



3.1.8 Driver Fatigue Alert

If the **Driver Fatigue Alert** function is enabled, this product produces voice and screen message alerts one hour after it has begun recording and repeats the alerts every half an hour afterwards.

1. If recording is in progress, press the ▼ button to stop recording.
2. Press the ↶ button to enter the OSD menu.
3. Press the ▲/▼ button, select **Driver Fatigue Alert**, and then press the **OK** button.
4. Press the ▲/▼ button, select **On**, and press the **OK** button.
5. Press the ↶ button to exit the menu.



3.1.9 LDWS (Lane Departure Warning Systems)

Once your car's location is determined by GPS and the **LDWS** function is enabled, this product produces voice and screen message alerts when you drive off of or change lanes at speeds over 50 km/h (31 mile/h).

1. If recording is in progress, press the ▼ button to stop recording.
2. Press the ↶ button to enter the OSD menu.
3. Press the ▲/▼ button, select **LDWS**, and then press the **OK** button.
4. Press the ▲/▼ button, select **On**, and press the **OK** button.
5. Press the ↶ button to exit the menu.
6. After enabling **LDWS**, the screen will display align icon



please adjust the camcorder so that the horizontal line and the eye level are overlapped and the slash lines are centered in the driving lane. Make sure that align icon will not be obscured (e.g. hood) during installation, it may cause misjudgment if the endpoint is obscured.

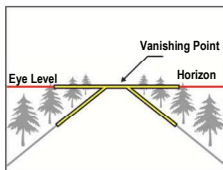

Note:

1. **LDWS** is only applicable when satellite positioning is in ready state. Make sure satellite positioning of your camcorder is ready if you want to activate this function. Satellite positioning function is dependent on the model purchased.
2. When enable the **LDWS**, **FWDS** and **FCMD**, please follow this self-aligned approach in order to increase the accuracy.
3. The detections of **LDWS** may be inaccurate when used in rain, at night or in environments of insufficient lighting. Drivers are advised to exercise discretion based on actual road conditions.
4. Feature is only applicable under the following resolutions: 1080P/60fps, 1080P/30fps.

3.1.10 FCWS (Forward Collision Warning System)

Once your car's location is determined by GPS and the **FCWS** function is enabled, this product produces voice and screen message alerts when you drive at speeds over 60 km/h (37 mile/h) and are less than 20m away from the car in front of you.

1. If recording is in progress, press the ▼ button to stop recording.
2. Press the ↶ button to enter the OSD menu.
3. Press the ▲/▼ button, select **FCWS**, and then press the **OK** button.
4. Press the ▲/▼ button, select **On**, and press the **OK** button.
5. Press the ↶ button to exit the menu.
6. After enabling **FCWS**, the screen will display align icon , please adjust the camcorder so that the horizontal line and the eye level are overlapped and the slash lines are centered in the driving lane. Make sure that align icon will not be obscured (e.g. hood) during installation, it may cause misjudgment if the endpoint is obscured.

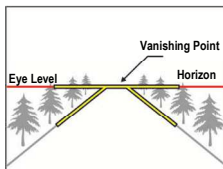

Note:

1. **FCWS** is only applicable when satellite positioning is in ready state. Make sure satellite positioning of your camcorder is ready if you want to activate this function. Satellite positioning function is dependent on the model purchased.
2. The detections of **FCWS** may be inaccurate when used in rain, at night or in environments of insufficient lighting. Drivers are advised to exercise discretion based on actual road conditions.
3. Feature is only applicable under the following resolutions: 1080P/60fps, 1080P/30fps.

3.1.11 FCMD (Front Car Move Detection)

Once your car's location is determined by GPS and the **FCMD** function is enabled, this product starts to detect the motion of cars in front of you after your car remains motionless for 20 seconds. It produces voice and screen message alerts when the movement of the car in front of you changes its images in the camera.

1. If recording is in progress, press the ▼ button to stop recording.
2. Press the ↶ button to enter the OSD menu.
3. Press the ▲/▼ button, select **FCMD**, and then press the OK button.
4. Press the ▲/▼ button, select **On**, and press the OK button.
5. Press the ↶ button to exit the menu.



6. After enabling **FCMD**, the screen will display align icon , please adjust the camcorder so that the horizontal line and the eye level are overlapped and the slash lines are centered in the driving lane. Make sure that align icon will not be obscured (e.g. hood) during installation, it may cause misjudgment if the endpoint is obscured.

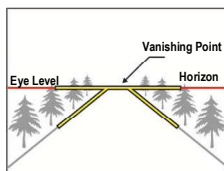

Note:

1. Once your car at waiting zone, it produces voice and screen message alerts when the movement of the motorcycles in front of you changes its images in the camera, and it will alert again in 30 seconds.
2. **FCMD** is only applicable when satellite positioning is in ready state. Make sure satellite positioning of your camcorder is ready if you want to activate this function. Satellite positioning function is dependent on the model purchased.

3. The detections of **FCMD** may be inaccurate when used in rain, at night or in environments of insufficient lighting. Drivers are advised to exercise discretion based on actual road conditions.
4. The product will recalibrate 30 seconds later after the initial alert if the **FCMD** function has been activated. If the vehicle remains in a stationary mode and the product detects image changes in the front lens, the product will once again trigger the voice and screen message alerts.
5. Feature is only applicable under the following resolutions: 1080P/60fps, 1080P/30fps.

3.1.12 Parking Mode

To monitor the vehicle when it is parked, you can activate **Motion Detection** or **Vibration Detection**.

1. If recording is in progress, press the ▼ button to stop recording.
2. Press the ↶ button to enter the OSD menu.
3. Press the ▲/▼ button, select **Parking Mode**, and then press the **OK** button.
4. Press the ▲/▼ button, select **Vibration Detection** or **Motion Detection**, and then press the **OK** button.
5. Press the ↶ button to exit the menu.

Item	Description
Vibration Detection	If disconnected from power when the camcorder is powered on, the system alert message “Wait for 60 seconds to enter Vibration Detection or press OK to cancel and power off.” This means the system will enter Vibration Detection automatically in 60 seconds; when the camcorder detects any external vibration applied to the vehicle after three minutes when all passengers have alighted, Video Record will be 90 seconds and the recording will be protected. If press OK within 60 seconds, the camcorder will be powered off instead of entering Vibration Detection mode.
Motion Detection	If disconnected from power when the camcorder is powered on, the system alert message “Wait for 10 seconds to enter Motion Detection, or press OK to power off.” This means the system will be displayed on the screen. This

	means the system will enter Motion Detection automatically in 10 seconds, when the camcorder detects any motion in front of lens or detects any external vibration, Video Record will be 10 seconds, if the screen detects any vibration, the camcorder will keep recording next 10 seconds until the vibration stops. If press OK within 10 seconds, the camcorder will be powered off instead of entering Motion Detection mode.
Off	No parking monitoring activated.

Note:

1. When the battery is fully charged and is in good condition, Motion Detection can record continuously for about 20 minutes
2. As the camcorder is used, the battery storage capacity will decrease gradually. This is a normal phenomenon for the battery.
3. The recording under parking mode will be all saved in emergency recording file.

3.1.13 Speed Cam Alert

The **Speed Cam Alert** function is enabled by default. Once your car's location is determined by GPS and approaches a speed cam, this product produces voice and screen message alerts.

To enable the disabled Speed Cam Alert function:



1. If recording is in progress, press the ▼ button to stop recording.
2. Press the ↶ button to enter the OSD menu.
3. Press the ▲/▼ button, select **Speed Cam Alert**, and then press the OK button.
4. Press the ▲/▼ button, select **On**, and press the OK button.
5. Press the ↶ button to exit the menu.
6. Once your car's location is determined by GPS and approaches a speed cam, this product produces voice and screen message alerts. The alarm screen turns red to remind you to slow down if you are driving faster than the speed limit.



Note:

The speed cam alert function must have the speed cam datum from the country you use. The function will be void if the product are used in any others countries. Please consult with the shop you purchased if the function is void. The product never guarantee the speed cam datum will be included for the worldwide countries.

3.1.14 4 GRID FUNCTION CHART

When the camcorder is recording, press  button will enter 4 GRID FUNCTION CHART in the LCD screen, users can check vehicular informations here. Press  button once again will go back into your recording.

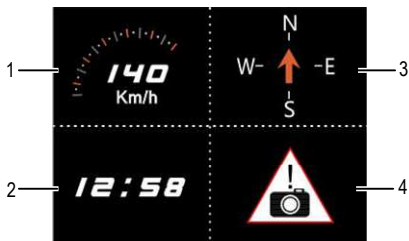

No.	Item
1	Driving Speed
2	Time

No.	Item
3	Driving direction
4	Speed Cam Alert

Note:

Driving Speed, Driving Direction and Speed Cam Alert are only applicable when satellite positioning of the camcorder is ready; otherwise, they will be displayed in gray scale only. Satellite positioning function is dependent on the model purchased.

3.2 Playback Videos and Photos

If recording is in progress, press the ▼ button to stop recording.

1. Press the ↶ button to enter the OSD menu.
2. Press the ▲/▼ button, select the **File Playback** and then press the **OK** button.
3. Press the ▲/▼ button, select the file type that you wish to view, and then press the **OK** button.
4. Press the ▲/▼ button to view the previous/next file and then press the **OK** button to view the file on full screen.



Note:

You can press the ▲ button from the standby screen and directly enter the playback mode. The final recording will be shown on the screen.

3.2.1 Video Playback

If recording is in progress, press the ▼ button to stop recording.

1. Press the ↶ button to enter the OSD menu.
2. Press the ▲/▼ button, select **File Playback** and then press the **OK** button.
3. Press the ▲/▼ button, select **Video** or **Emergency**, and then press the **OK** button.
4. Press the ▲/▼ button to view the required video recording file and then press the **OK** button, playback the video.
5. Press the ▼ button to stop playback. Press it again to resume playback.
6. Press ▲ up to 4 times fast-forward. Press ▼ to resume normal mode.
7. Press **OK** up to 4 times rewind speed. Press ▼ to resume normal mode.



3.2.2 Viewing Photos

If recording is in progress, press the ▼ button to stop recording.

1. Press the ↶ button to enter the OSD menu.
2. Press the ▲/▼ button, select **File Playback**, and then press the **OK** button.
3. Press the ▲/▼ button, select **Picture**, and then press the **OK** button.
4. Press the ▲/▼ button to view the required picture files, and then press the **OK** button to view the files on full screen.

3.2.3 The Playback Screen

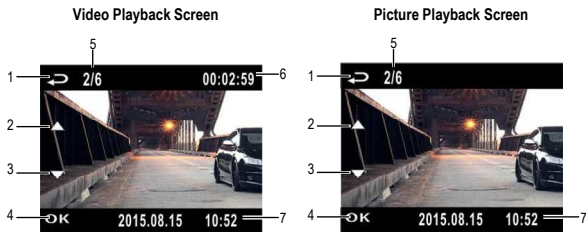

No.	Item	Description
1	File selection (back)	Press the ↶ button to return back to file selection display.
2	Previous File	Press the ▲ button to review the previous picture/video.
3	Next File	Press the ▼ button to view the next video/picture.
4	File Playback	Press OK to play video (photo).
5	Playback page no. of the file	Instructs the current file being played and the total no. of playback files.
6	Current Duration	Indicates the elapsed time.
7	Date and time	Indicates the recorded date and time.

3.2.4 Deleting Files

If recording is in progress, press the ▼ button to stop recording.

1. Press the ↶ button to enter the OSD menu.
2. Press the ▲/▼ button, select “**File Deletion**”, and press the **OK** button.
3. Press the ▲/▼ button, select file type and press the **OK** button.
4. Press the ▲/▼ button, select the file that you wish to delete and then press the **OK** button to enter the deletion menu.
5. Press the ▲/▼ button to select an item.

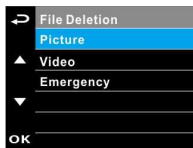

Item	Description
Delete One	Delete the current file.
Delete All	Delete all files.

6. Press the **OK** button, please confirm deletion.

Note:

Deleted files cannot be restored. Please ensure that files have been backed up before deleting.

4 Adjusting the settings

4.1 Using the menu

You can customize the general settings via the on-screen display (OSD) menus.

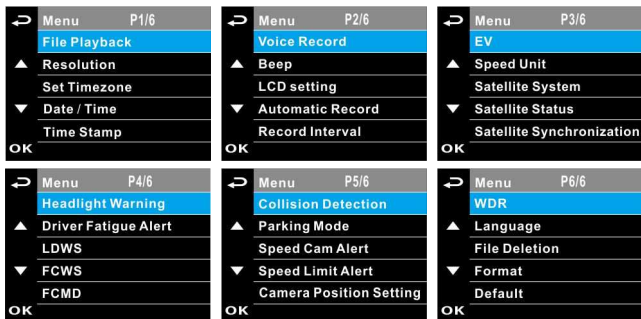

If recording is in progress, press the ▼ button to stop recording.

1. Press the ↶ button to open up the OSD menu. ◦
2. Press the ▲/▼ button, select menu item and press the OK button, then enter the selected menu.
3. Press the ▲/▼ button to select to required setting and press the OK button to confirm setting.
4. Press the ↶ button to exit the menu.

4.2 Menu Items

Refer to the below table for details of main menu and function list.

Menu Item	Description	Available Option
File Playback	Select the file type that you wish to view.	Picture / Video / Emergency
Resolution	Set up resolution of video recording.	1920 x 1440 / 30 fps 1920 x 1080 / 60 fps 1920 x 1080 / 30 fps 1920 x 1080 / 30 fps HDR 1280 x 720 / 120 fps
Set Time zone	Select the correct time zone that the country is located.	Factory default time zone is set as "+08"
Date / Time	Set up date and time.	Press the ▲/▼ button to adjust the value, and press the OK button to switch the field and confirm.
Time Stamp	Activate/suspend the use of the date stamp.	On / Off
Voice Record	Activate/suspend the use of voice recording.	On / Off
Beep	Activate/suspend use of sound effects setting.	VOLUME 1 / VOLUME 2 / VOLUME 3 / Off
LCD Setting	Set the screen auto shutdown time after video recording has started.	On / Turn Off After 30 sec. / Turn Off After 3 min. / Off
Automatic Record	Activate/suspend use of the automatic record function after the camcorder is turned on.	On / Off
Record Interval	Set the record interval for each video recording file.	1 min. / 3 min.

Menu Item	Description	Available Option
EV	Setting of exposure value.	Press the ▲/▼ button to set the exposure value. It can be set between +1.0 to -1.0.
Speed Unit	Select the unit for speed display.	KM/H / mph
Satellite System	Select the satellite system where the user is located	GPS / GLONASS
Satellite Status	Displays the status of current satellite signal reception.	
Satellite Synchronization	Automatically synchronize with the local satellite time. Satellite time will be displayed by the system as a first priority after this function is activated, and the time cannot be manually changed subsequently (recommend that the time zone is not changed deliberately).	On / Off
Headlight Warning	The Headlight Warning function produces voice and screen message alerts when it detects poor lighting conditions through the recording displays of this product, including driving in rainy or cloudy weather, at night, and in basements, parking lots, and tunnels.	On / Off
Driver Fatigue Alert	If the Driver Fatigue Alert function is enabled, this product produces voice and screen message alerts one hour after it has begun recording and repeats the alerts every half an hour afterwards.	On / Off

Menu Item	Description	Available Option
LDWS	Once your car's location is determined by GPS and the LDWS function is enabled, this product produces voice and screen message alerts when you drive off of or change lanes at speeds over 50 km/h (31 mile/h).	On / Off
FCWS	Once your car's location is determined by GPS and the FCWS function is enabled, this product produces voice and screen message alerts when you drive at speeds over 60 km/h (37 mile/h) and are less than 20m away from the car in front of you.	On / Off
FCMD	Once your car's location is determined by GPS and the FCMD function is enabled, this product starts to detect the motion of cars in front of you after your car remains motionless for 20 seconds. It produces voice and screen message alerts when the movement of the car in front of you changes its images in the camera.	On / Off
Collision Detection	Activate/suspend use of the collision detection function. Emergency recording will be activated automatically when any collision is detected.	High Sensitivity / Normal Sensitivity / Low Sensitivity / Off
Parking Mode	To monitor the vehicle when it is parked.	Vibration Detection / Motion Detection / Off

Menu Item	Description	Available Option
Speed Cam Alert	This product begins emergency recording once it detects any vibrations caused by a collision.	On / Off
Speed Limit Alert	Setup of speed limit, when the vehicle speed exceeds the value set in the system, a sound and display alert will be triggered. When the Metric to Imperial has being setting up ready , the function will automatically shut down and be restarted again to set up car speed	Press the ▲/▼ button to set the speed limit. When you select Metric units(KM/H), can be set between 50km/h to 200 km/h.; When you select Imperial units(mph), can be set between 10mph to 85mph.
Camera Position setting	Add speed point: A new camera position can be added manually after the satellite positioning is completed, and up to 200 camera positions can be added. Delete speed point: Delete the last camera position of all newly added camera position information / delete all camera positions.	Add speed point / Delete Last Position / Delete All Position
WDR	Present a crisp and clear picture quality with harmonious contrast in a high contrast, high discrepancy environment.	On / Off
Language	Setting of display language menu.	According to the actual shipping regions
File Deletion	Delete files.	Picture / Video / Emergency
Format	Formatting of memory card	Yes / No
Default	Reset all and restore to factory default settings.	Yes / No

5 Installing the Software

1. Place the attached CD ROM into the CD player.
2. If the CD does not execute automatically, please use Windows File Manager to execute the **Install_CD.exe** file in the CD.

The following screen will be shown up.



3. Press the [Menu] item to start the installation process according to the instructions on-screen.

6 SuperCar

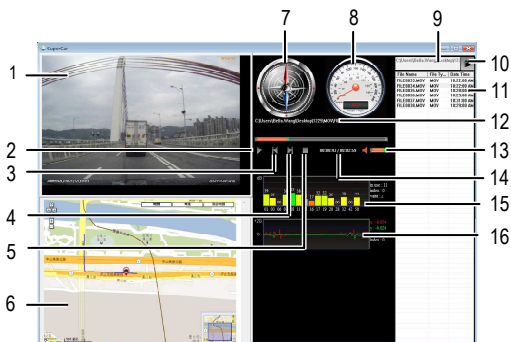

No.	Item
1	Video Player
2	Play / Pause
3	Previous
4	Next
5	Stop
6	Electronic Map
7	Compass
8	Speed Meter

No.	Item
9	File Path
10	Browser File
11	File List
12	File Name
13	Volume
14	Current Duration / Total Duration
15	Signal Noise Ratio (SNR)
16	G-Sensor

Note :

1. To display the route on Electronic Map, please make sure the internet is connected before starting the video playback.
2. Video files (MOV / TS) and GPS/G-Sensor files (NMEA) must be stored in the same folder before starting the playback.
3. The SuperCar software is only applicable to a Windows operating system.

7 Specifications

Item	Description
Image sensor	1/3" CMOS sensor
Effective pixels	2688 (H) x 1512 (V)
Storage media	Support Micro SDHC Class 10, max. up to 32GB
LCD display	2.31" LCD color screen
Lens	Wide Angle Fixed Focus lens F1.8, f=2.94mm
Focus range	1.5m ~ Infinity
Satellite System	GPS / GLONASS
Movie Clip	Resolution: 1440P/30fps ; 1080P/60fps ; 1080P/30fps ; 1080P/30fps HDR ; 720P/120fps
	Format: MOV
Still image (Snapshot)	Resolution: 4M (2688 x 1512)
	Format: JPEG
Shutter	Electronic shutter Auto: 1/2 ~1/2000 sec
G-Sensor	3-Axis G-Force sensor
ISO	Auto
White Balance	Auto
Microphone	Support
Speaker	Support
Interface	Mini USB

Item	Description
Battery	Built-in 470mAh Li-polymer rechargeable
Operating Temperature	0° ~ 60° C
Operating Humidity	20 ~ 70% RH
Storage Temperature	-20° ~ 70° C
Dimensions	57 x 30 x 58 mm
Weight	Approx. 75g (without memory card)