



English

IMPORTANT: Follow these part replacement instructions:

- 1 Match the part you received to the illustration on the next page.
- 2 Go to the page number indicated (→ #) for that part.
- 3 Complete only the part replacement steps in that section.

WARNING:

- **Keep your hands away from the moving fan.**
- **Keep fingers and tools clear of the fan when power is applied.**
- **Never open the cover with the power cord attached or power applied. You may damage your computer or be injured from the spinning fan blades.**
- **Avoid touching sharp edges inside the computer.**

CAUTION: This product contains components that are easily damaged by electrostatic discharge (ESD). To reduce the chance of ESD damage, work over a non-carpeted floor, use a static dissipative work surface (like a conductive foam pad), and wear an ESD wrist strap that is connected to a grounded surface, like the metal frame of the computer.

IMPORTANT: A hard disk drive is extremely sensitive to shock and impact. Do not bang or drop it. Do not touch the circuit board. Static electricity can damage the drive.

The memory performance may vary due to different system configurations.

NOTE: Computer features may vary by model.

Español

IMPORTANTE: Siga estas instrucciones para el reemplazo de piezas:

- 1 Compare la pieza que usted recibió con l'illustración en la página siguiente.
- 2 Vaya al número de la página indicada (→ #) para esa pieza.
- 3 Ejecute solamente los pasos para el reemplazo de la pieza en esa sección.

ADVERTENCIA:

- **Mantenga sus manos alejadas del ventilador en funcionamiento.**
- **Mantenga los dedos y las herramientas lejos del ventilador cuando lo encienda.**
- **Nunca abra la cubierta cuando el cable de alimentación esté conectado o el ventilador esté encendido. Puede dañarlo o lastimarse con las aspas en movimiento del ventilador.**
- **Evite tocar los bordes filosos ubicados en el interior del equipo.**

PRECAUCIÓN: Este producto contiene componentes que se pueden dañar con facilidad si se someten a descargas electrostáticas (ESD). Para reducir las posibilidades de daños por ESD, trabaje sobre un piso no alfombrado, utilice una superficie de trabajo estática disipativa (como una goma espuma conductora) y use una muñequera contra ESD que esté conectada a una superficie con conexión a tierra, como el marco de metal de su equipo.

IMPORTANTE: La unidad de disco duro es extremadamente sensible a los golpes. No la golpee ni la deje caer. No toque la tarjeta de circuito. La electricidad estática puede dañar la unidad.

El rendimiento de la memoria puede variar dependiendo de las configuraciones del sistema.

NOTA: Las características del equipo pueden variar según el modelo.

Português

IMPORTANTE: Siga estas instruções sobre substituição de peças:

- 1 Compare a peça que você recebeu com a ilustração na próxima página.
- 2 Vá para o número da página indicada (→ #) para esta peça.
- 3 Conclua apenas as etapas de substituição de peças nesta sessão.

AVISO:

- **Mantenha suas mãos longe do ventilador.**
- **Mantenha os dedos e ferramentas longe do ventilador quando o mesmo estiver ligado.**
- **Nunca abra a tampa com o fio de alimentação conectado ou quando estiver ligado. Você pode danificar seu computador ou se machucar com as lâminas do ventilados.**
- **Evite tocar em bordas pontiagudas dentro do computador.**

AVISO: Este produto contém componentes que podem ser facilmente danificados por descarga eletrostática (ESD - Electrostatic Discharge). Para reduzir o risco de danos por ESD, não trabalhe sobre carpetes, use uma área de trabalho antiestática (semelhante a um revestimento de espuma condutora), e utilize uma pulseira própria para evitar descargas eletrostáticas que esteja conectada a uma superfície aterrada, como a estrutura metálica do computador.

IMPORTANTE: A unidade de disco rígido é extremamente sensível a choques e impacto. Não bata ou derrube a unidade. Não toque na placa de circuito. Eletricidade estática pode danificar a unidade.

O desempenho da memória pode variar devido a diferenças de configuração no sistema.

OBSERVAÇÃO: Os recursos do computador podem variar de acordo com o modelo.

Français

IMPORTANT : Suivez ces instructions relatives au remplacement des pièces :

- 1 Repérez la pièce que vous avez reçue sur l'illustration de la page suivante.
- 2 Accédez à la page (→ #) de cette pièce.
- 3 Procédez uniquement à la procédure de remplacement détaillée dans cette section.

AVERTISSEMENT :

- **Gardez vos mains à l'écart du ventilateur en mouvement.**
- **N'approchez pas vos doigts ou des outils du ventilateur lorsque l'ordinateur est alimenté.**
- **N'ouvrez jamais le capot lorsque le cordon d'alimentation est branché ou lorsque l'ordinateur est sous tension. Vous pourriez endommager votre ordinateur.**
- **Évitez de toucher les bords tranchants à l'intérieur du châssis.**

ATTENTION : Ce produit contient des composants qui peuvent être endommagés facilement par des décharges électrostatiques. Pour diminuer les risques de dommages par décharges électrostatiques, travaillez au-dessus d'un plancher non revêtu de moquette, utilisez une surface de travail antistatique (un tapis conducteur en mousse par exemple), et portez un bracelet antistatique relié à une surface mise à la terre, comme le cadre métallique de l'ordinateur.

IMPORTANT : Un disque dur est extrêmement sensible aux chocs. Ne le laissez pas tomber et ne le heurtez pas. Ne touchez pas la carte de circuit intégré. L'électricité statique peut endommager le disque.

La capacité de mémoire peut varier selon les différentes configurations du système.

REMARQUE : Les caractéristiques de l'ordinateur peuvent varier selon le modèle.

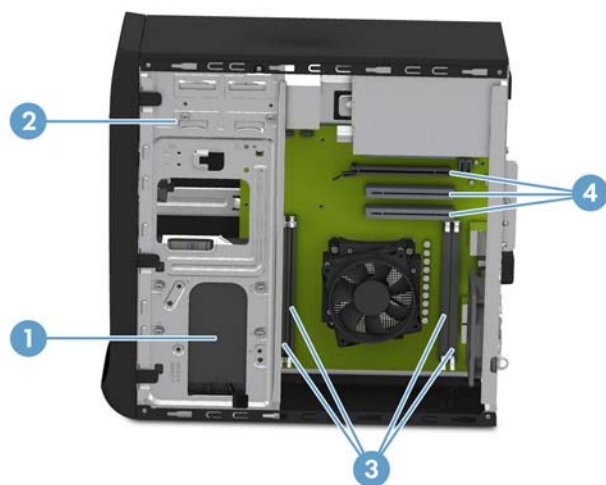

1 Hard Drive → **3**
Unidad de disco duro
Unidade de disco rígido
Disque dur

3 Memory Modules → **11**
Módulos de memoria
Módulos da memória
Modules mémoire

2 CD/DVD Drive → **7**
Unidad de CD/DVD
Unidade de CD/DVD
Lecteur de CD/DVD

4 Add-In Card → **14**
Tarjeta adicional
Placa de Expansão
Cartes d'extension

Hard Drive

Unidad de disco duro

Unidade de disco rígido

Disque dur

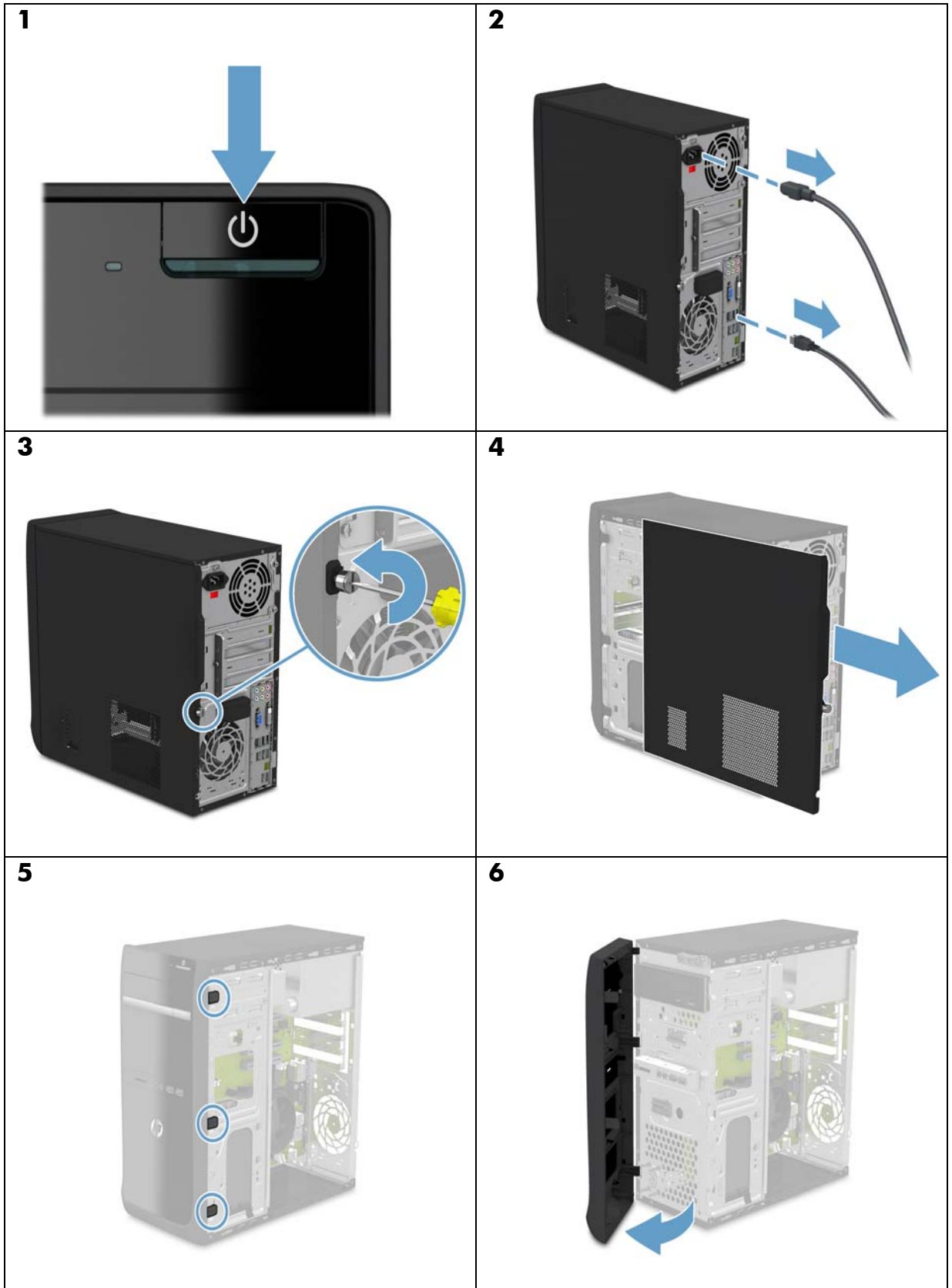

Hard Drive

Unidad de disco duro

Unidade de disco rígido

Disque dur

7



8



9

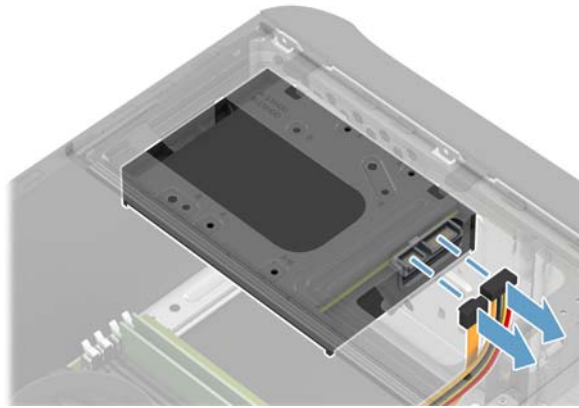

10

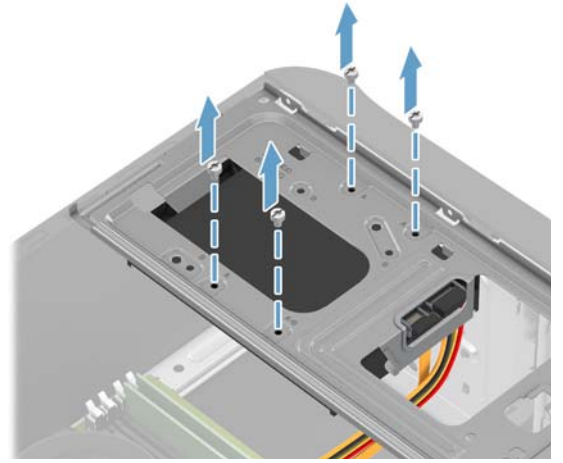

11

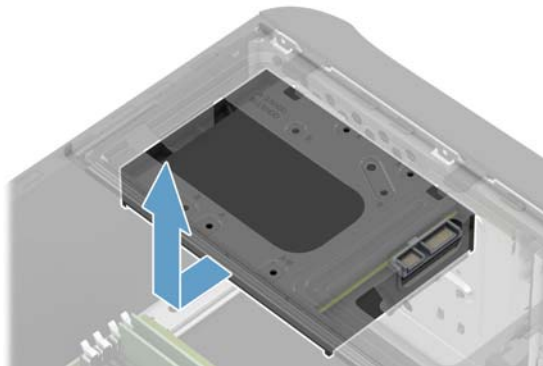

12

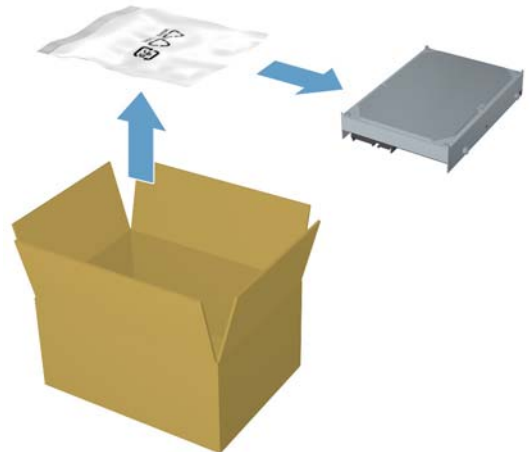

Hard Drive

Unidad de disco duro

Unidade de disco rígido

Disque dur

13

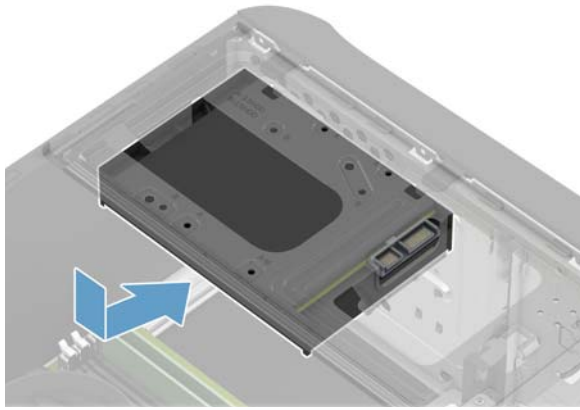

14

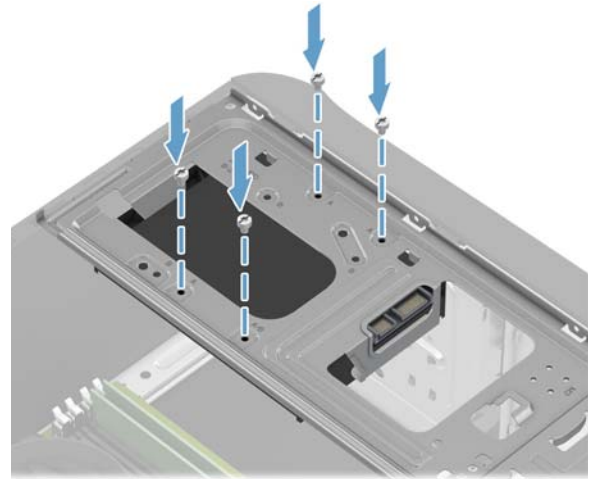

15

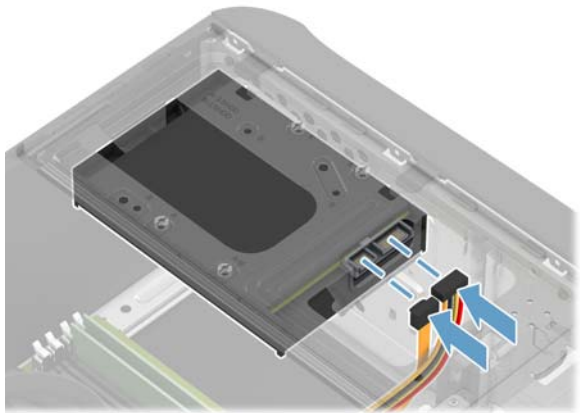

16

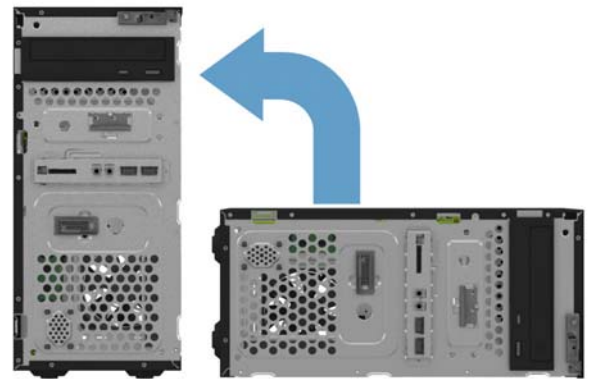

17

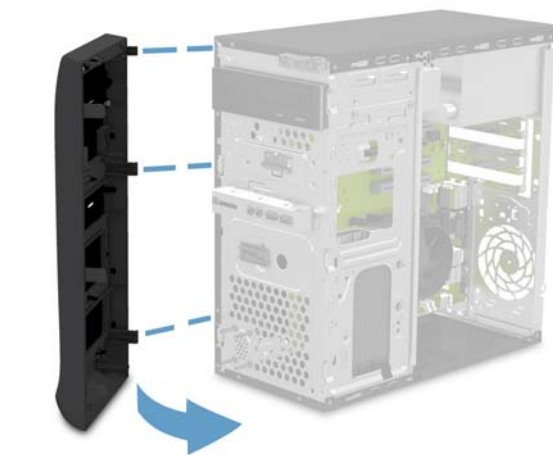

18



Hard Drive

Unidad de disco duro

Unidade de disco rigido

Disque dur

19

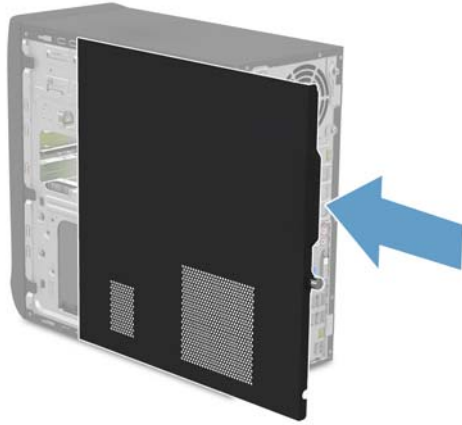

20

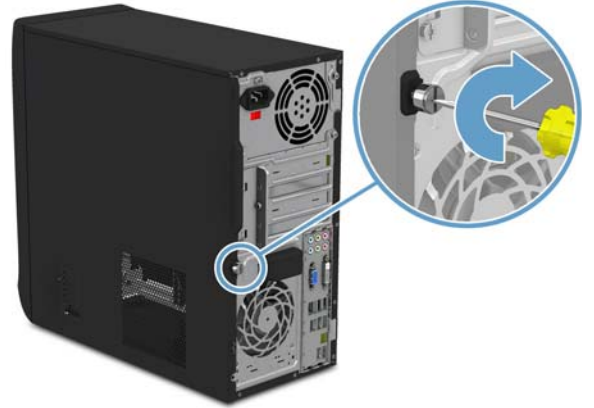

21

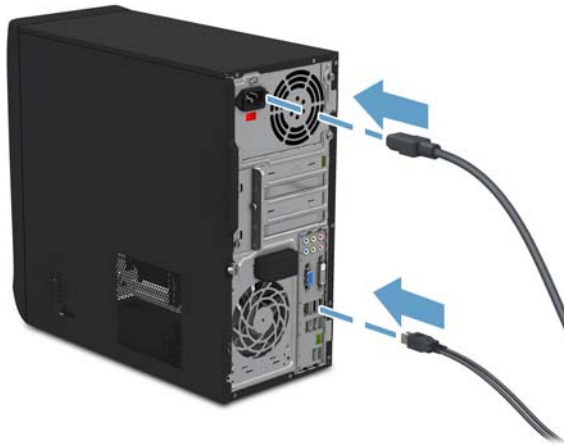

22

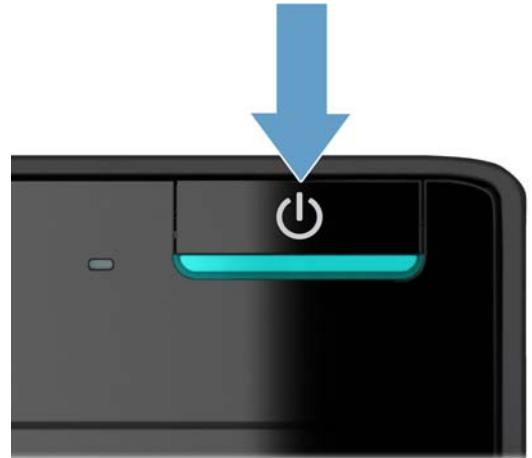

**CD/DVD
Drive**

**Unidad de
CD/DVD**

**Unidade de
CD/DVD**

**Lecteur de
CD/DVD**

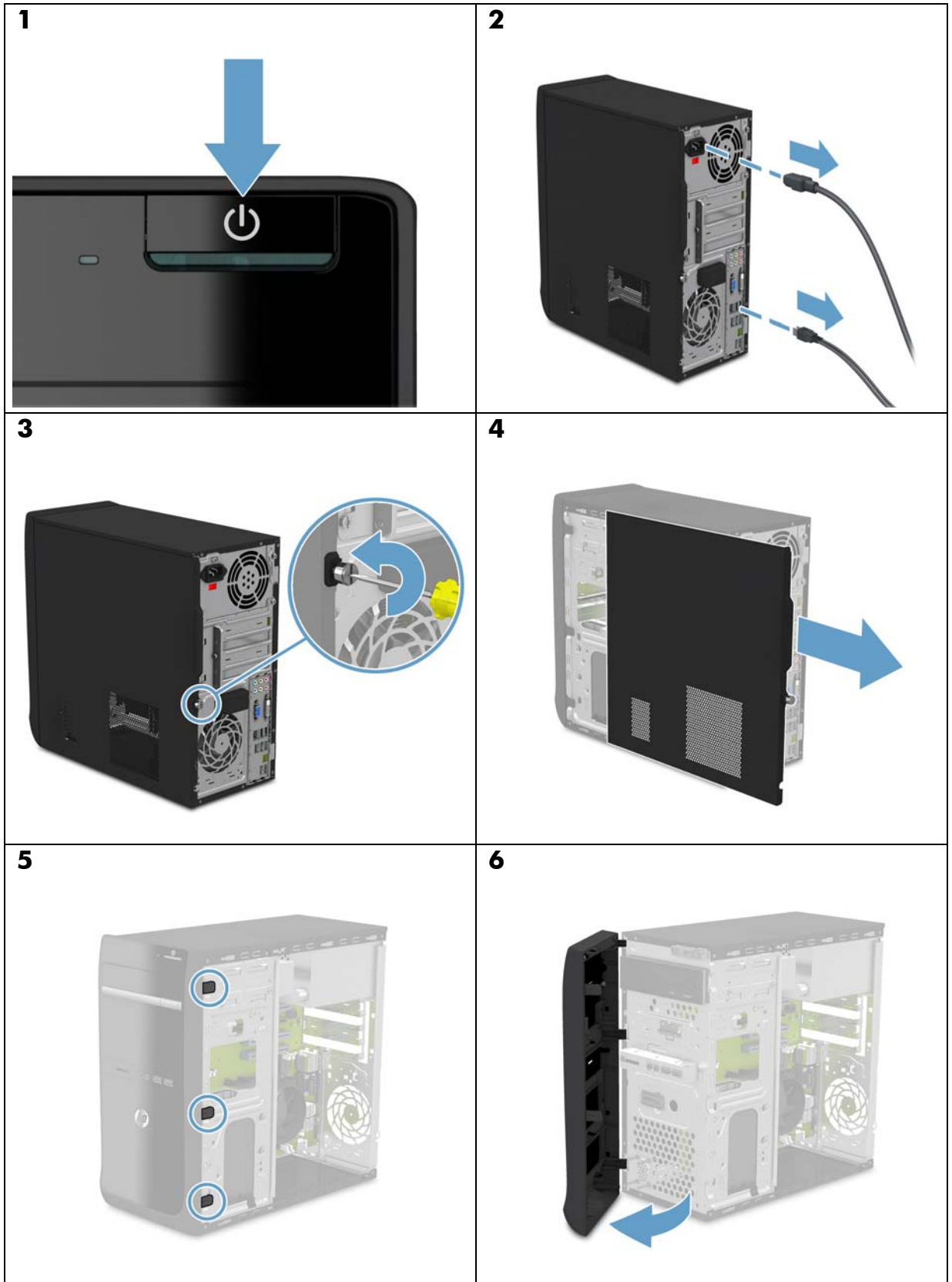

**CD/DVD
Drive**

**Unidad de
CD/DVD**

**Unidade de
CD/DVD**

**Lecteur de
CD/DVD**

7



8

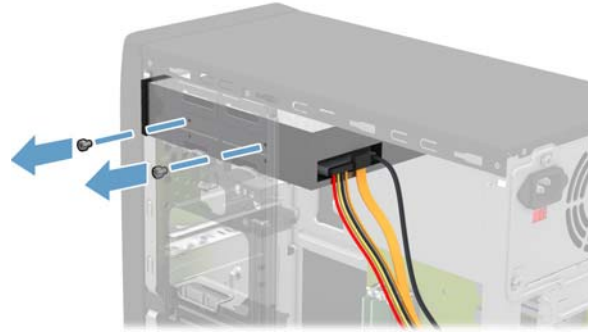

9

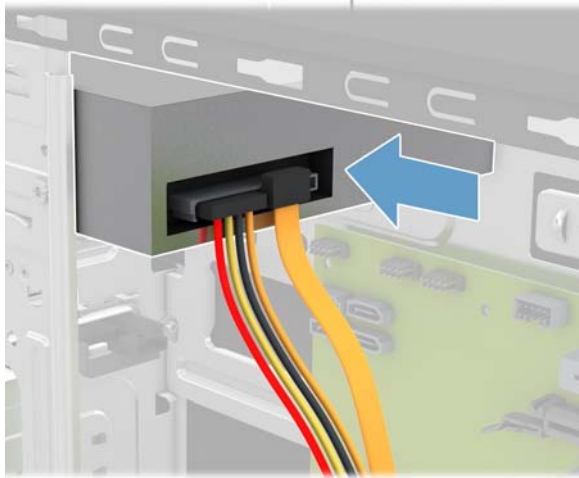

10

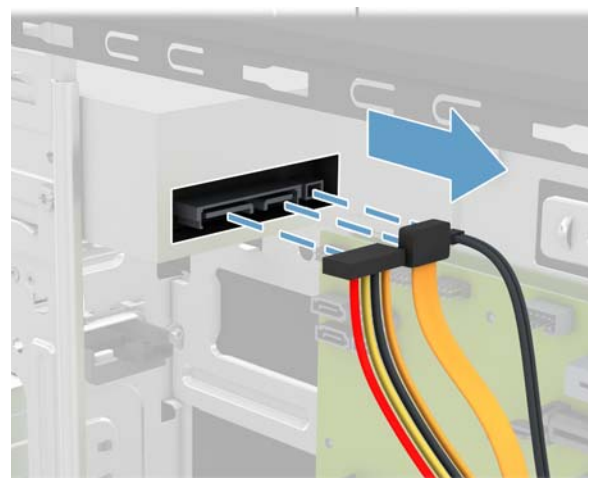

11



12

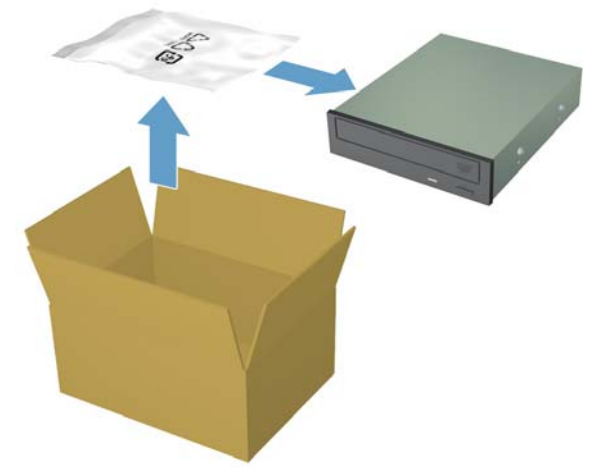

CD/DVD Drive

Unidad de CD/DVD

Unidade de CD/DVD

Lecteur de CD/DVD

13



14



15

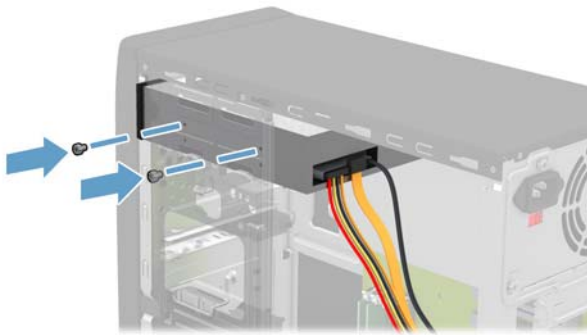

16

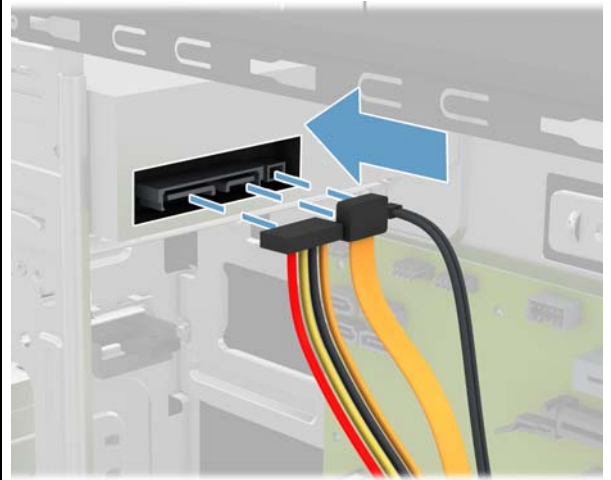

17

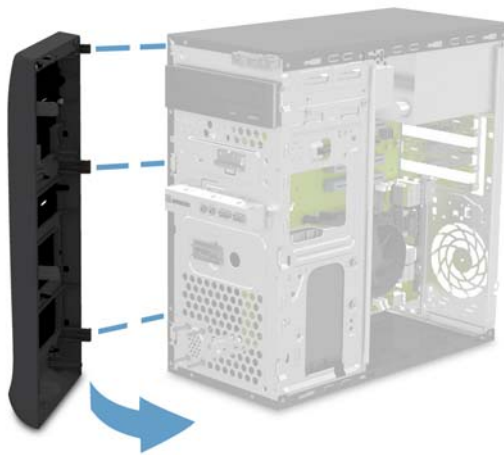

18



**CD/DVD
Drive**

**Unidad de
CD/DVD**

**Unidade de
CD/DVD**

**Lecteur de
CD/DVD**

19

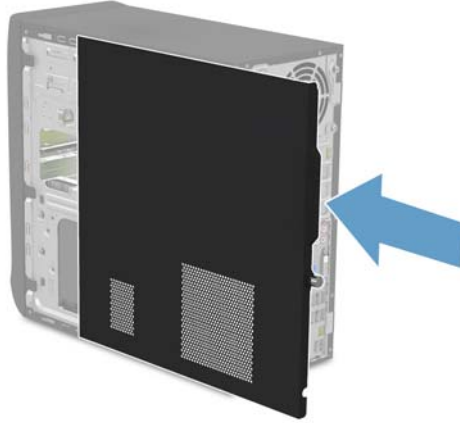

20

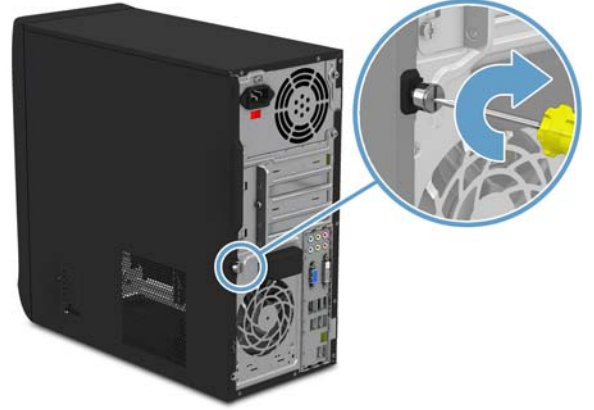

21

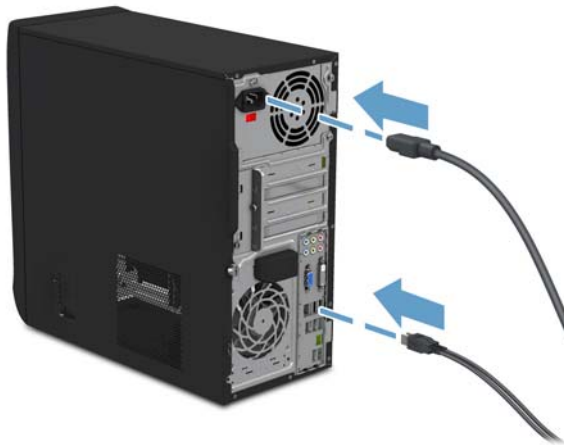

22

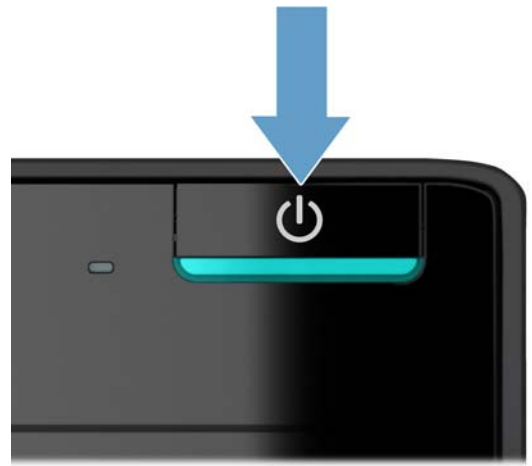

**Memory
Modules**

**Módulos de
memória**

**Módulos da
memória**

**Modules
mémoire**

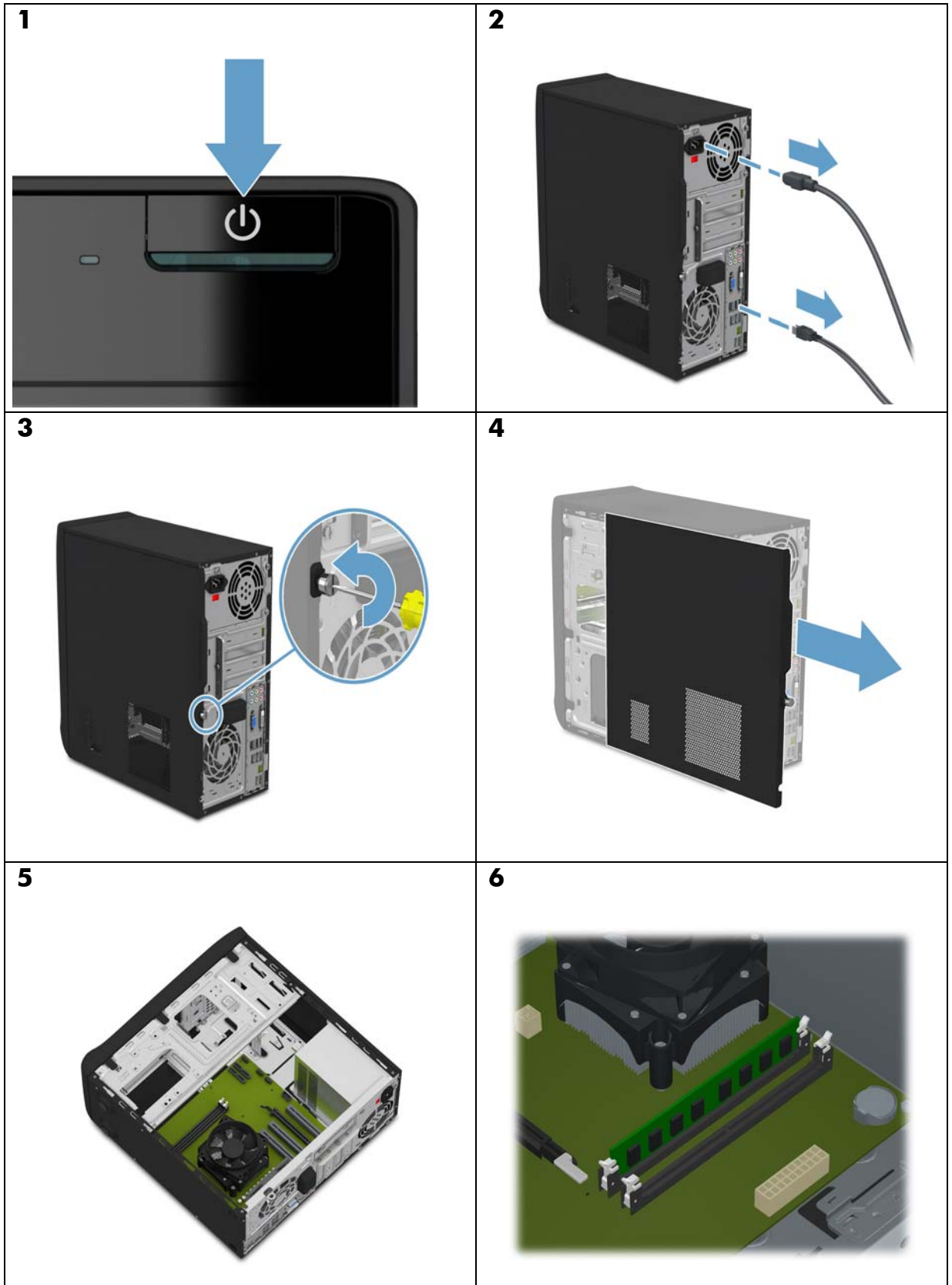

**Memory
Modules**

**Módulos de
memória**

**Módulos da
memória**

**Modules
mémoire**

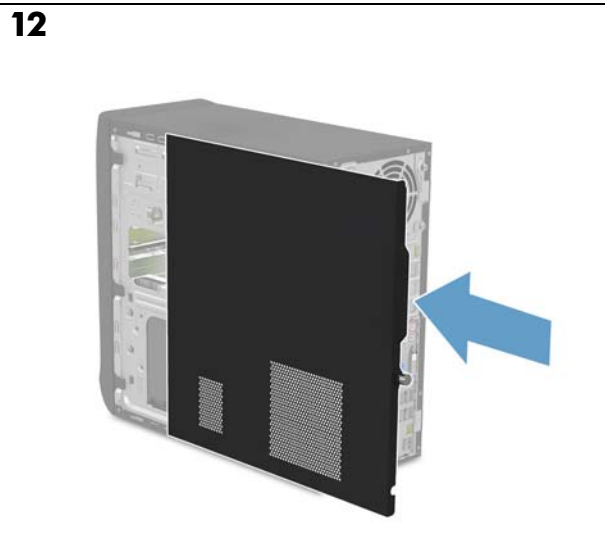
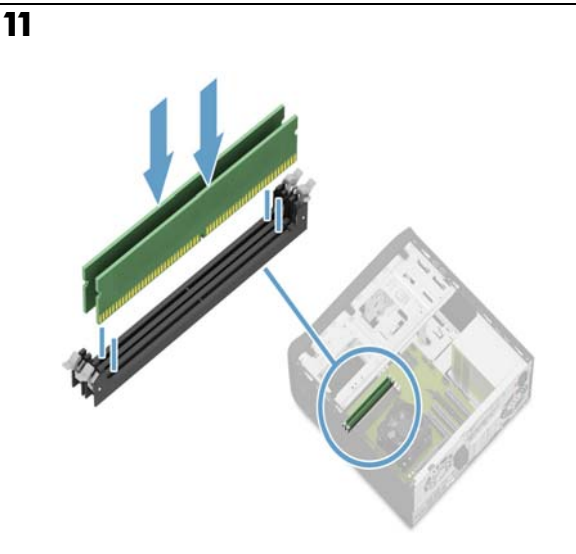
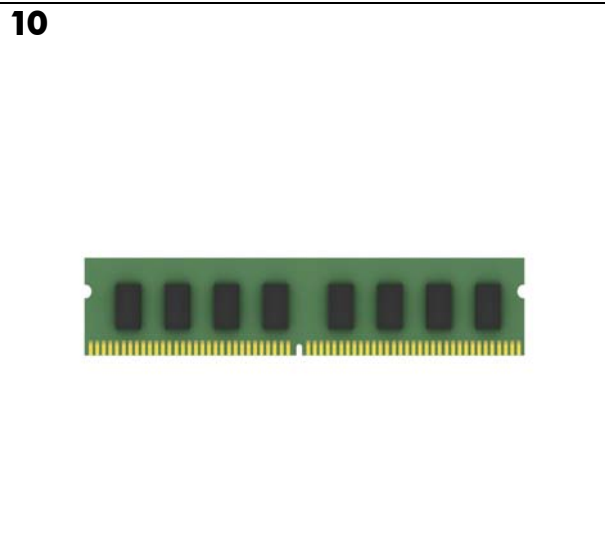
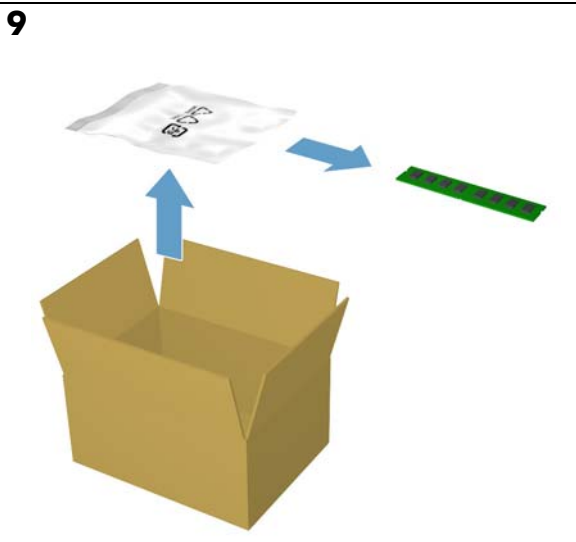
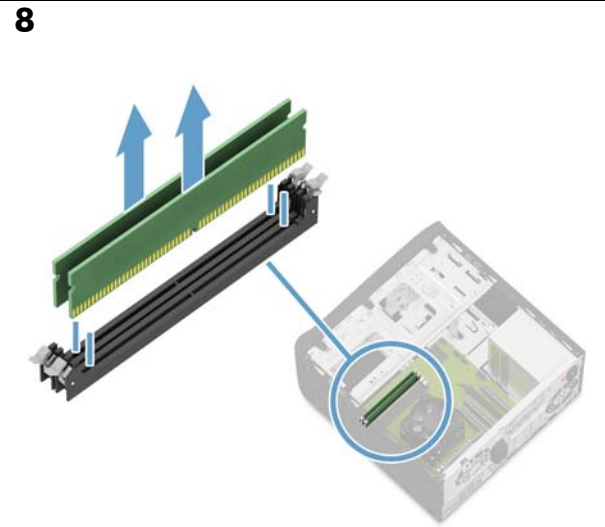
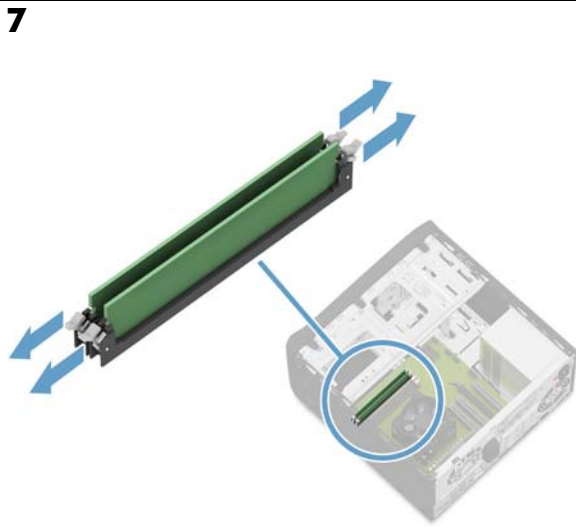

**Memory
Modules**

**Módulos de
memória**

**Módulos da
memória**

**Modules
mémoire**

13

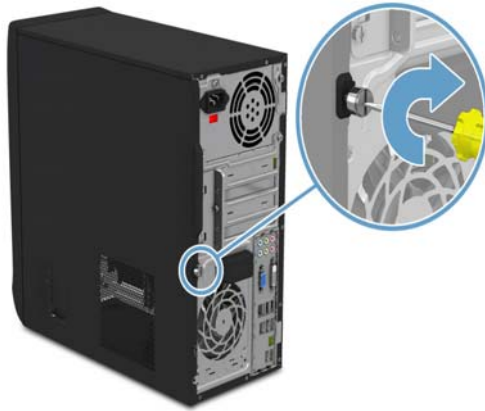

14

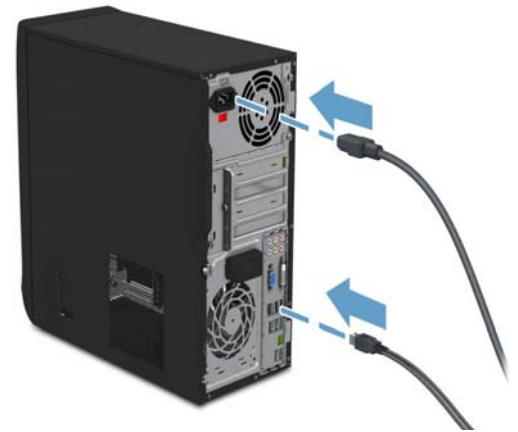

15

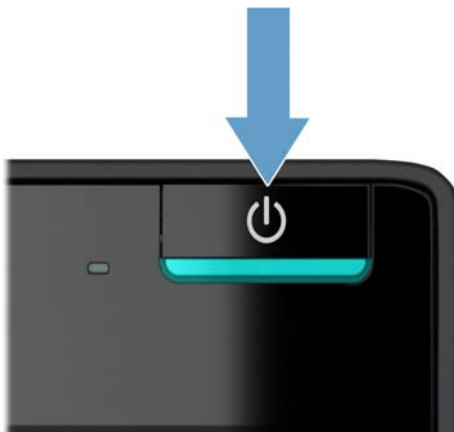

Add-in card

Tarjeta adicional

Placa de Expansão

Cartes d'extension

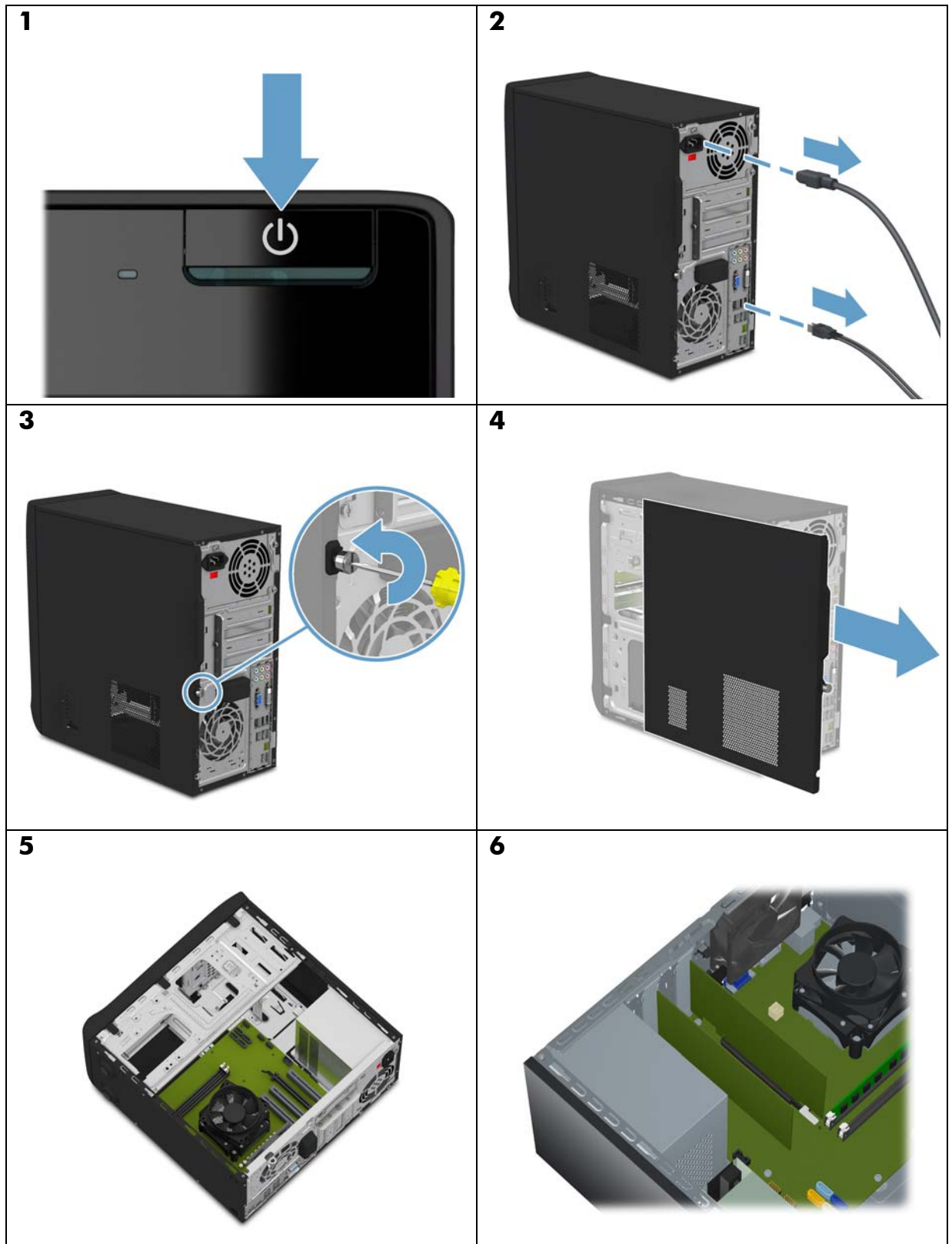

Add-in card

Tarjeta adicional

Placa de Expansão

Cartes d'extension

7

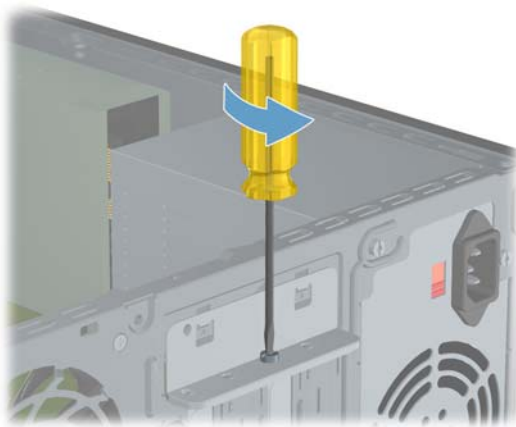

8

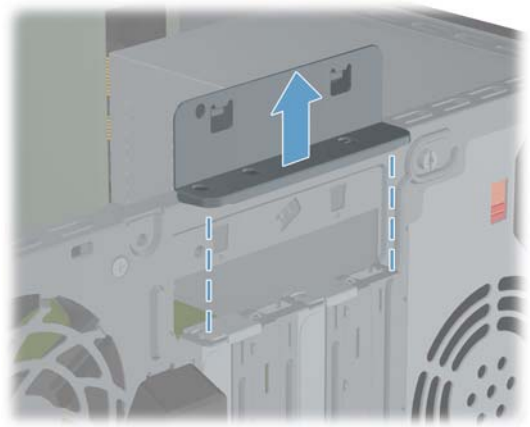

9

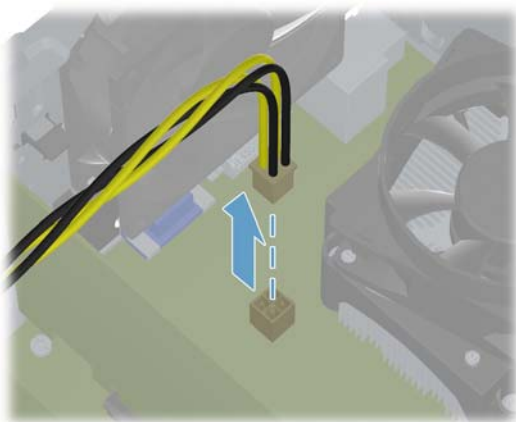

10



11

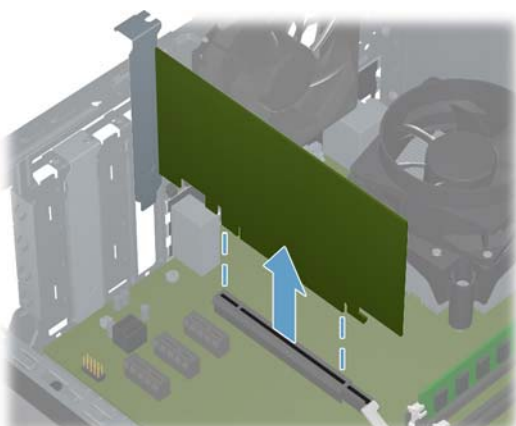

12

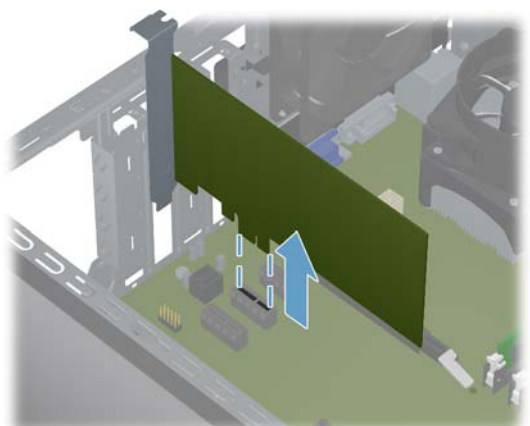

Add-in card

Tarjeta adicional

Placa de Expansão

Cartes d'extension

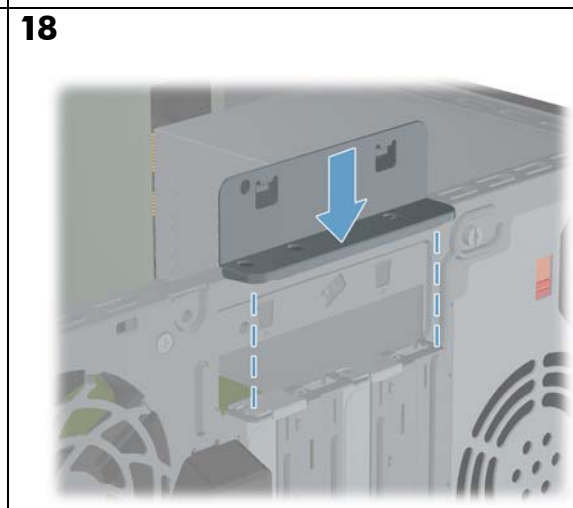
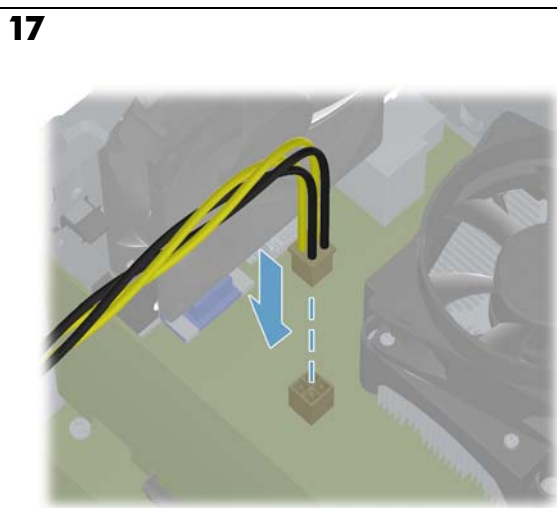
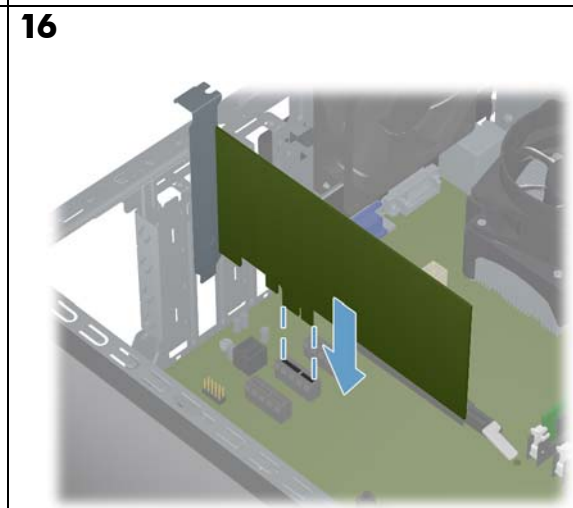
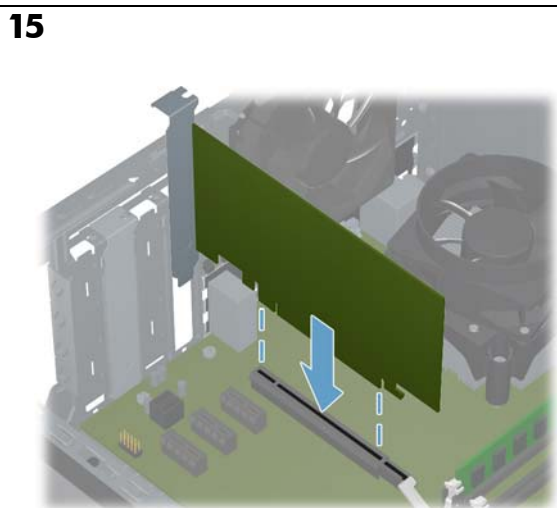
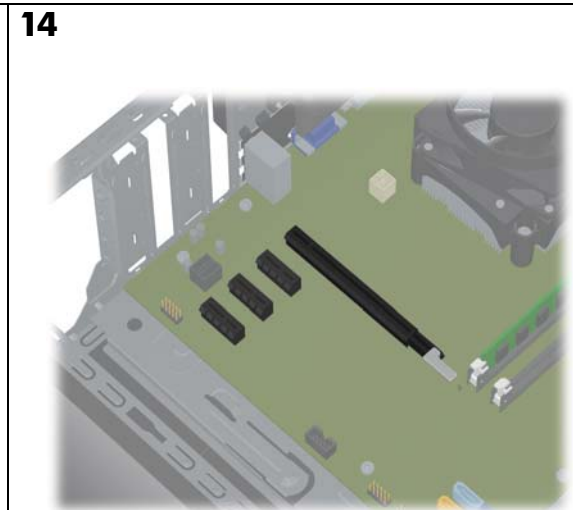
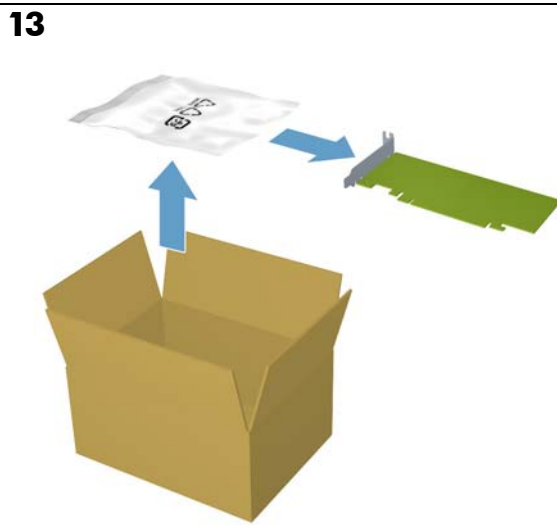

Add-in card

Tarjeta adicional

Placa de Expansão

Cartes d'extension

19

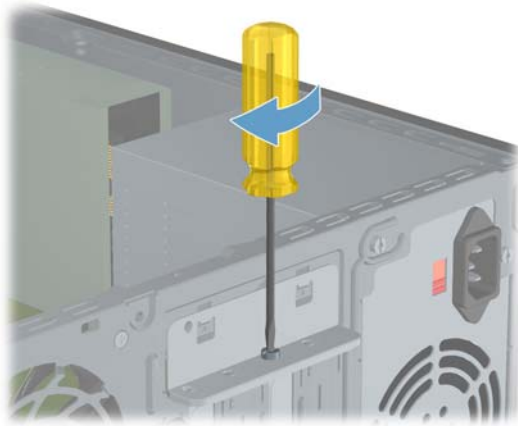

20

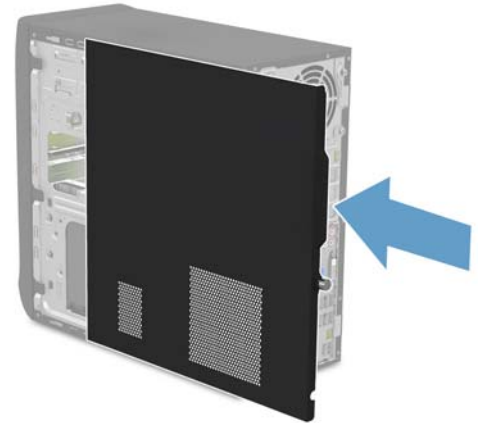

21

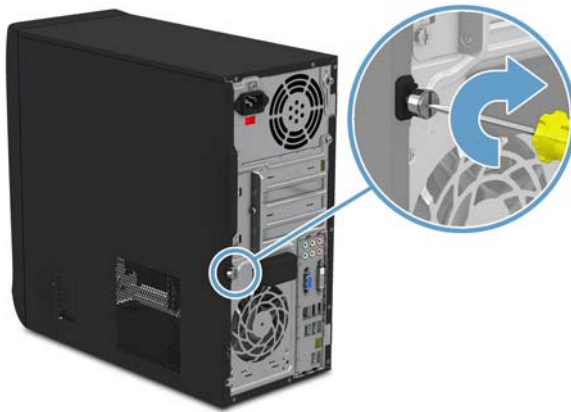

22

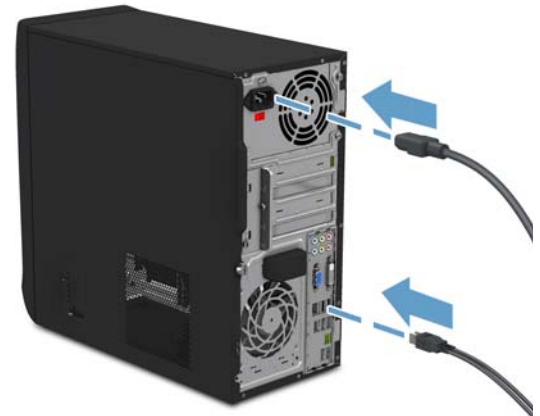

23

