



# HP Pavilion Notebook PC

## Maintenance and Service Guide

© Copyright 2016 HP Development Company, L.P.

Bluetooth is a trademark owned by its proprietor and used by HP Inc. under license. Intel is a trademark of Intel Corporation in the U.S. and other countries. Windows is either a registered trademark or trademark of Microsoft Corporation in the United States and/or other countries.

#### Product notice

This guide describes features that are common to most models. Some features may not be available on your computer.

Not all features are available in all editions of Windows. This computer may require upgraded and/or separately purchased hardware, drivers and/or software to take full advantage of Windows functionality. See <http://www.microsoft.com> for details.

The information contained herein is subject to change without notice. The only warranties for HP products and services are set forth in the express warranty statements accompanying such products and services. Nothing herein should be construed as constituting an additional warranty. HP shall not be liable for technical or editorial errors or omissions contained herein.

First Edition: April 2016

Document Part Number: 854538-001

## Important Notice about Customer Self-Repair Parts

---

 **CAUTION:** Your computer includes Customer Self-Repair parts and parts that should only be accessed by an authorized service provider. See Chapter 5, "Removal and replacement procedures for Customer Self-Repair parts," for details. Accessing parts described in Chapter 6, "Removal and replacement procedures for authorized service provider parts," can damage the computer or void your warranty.

---



## Safety warning notice

---

 **WARNING!** To reduce the possibility of heat-related injuries or of overheating the device, do not place the device directly on your lap or obstruct the device air vents. Use the device only on a hard, flat surface. Do not allow another hard surface, such as an adjoining optional printer, or a soft surface, such as pillows or rugs or clothing, to block airflow. Also, do not allow the AC adapter to contact the skin or a soft surface, such as pillows or rugs or clothing, during operation. The device and the AC adapter comply with the user-accessible surface temperature limits defined by the International Standard for Safety of Information Technology Equipment (IEC 60950-1).

---



---

# Table of contents

<b>1 Product description .....</b>	<b>1</b>
<b>2 External component identification .....</b>	<b>5</b>
Right side .....	5
Left side .....	6
Display .....	7
Top .....	8
TouchPad .....	8
Lights .....	9
Button and speakers .....	10
Keys .....	11
Using the action keys .....	11
Bottom .....	12
Rear .....	13
Locating system information .....	13
<b>3 Illustrated parts catalog .....</b>	<b>15</b>
Computer major components .....	15
Display assembly subcomponents .....	18
Miscellaneous parts .....	19
<b>4 Removal and replacement procedures preliminary requirements .....</b>	<b>21</b>
Tools required .....	21
Service considerations .....	21
Plastic parts .....	21
Cables and connectors .....	22
Drive handling .....	22
Grounding guidelines .....	23
Electrostatic discharge damage .....	23
Packaging and transporting guidelines .....	24
Workstation guidelines .....	24
Equipment guidelines .....	25
<b>5 Removal and replacement procedures for Customer Self-Repair parts .....</b>	<b>26</b>
Component replacement procedures .....	26
Optical drive (select products only) .....	26

<b>6 Removal and replacement procedures for authorized service provider parts .....</b>	<b>28</b>
Component replacement procedures .....	28
Base enclosure .....	28
Battery .....	30
Hard drive .....	31
SSD (M.2) .....	33
Memory .....	34
WLAN module .....	37
Display assembly .....	39
Fan .....	41
Heat sink .....	43
I/O board .....	45
Power button board .....	46
System board .....	48
SD card reader .....	50
Speakers .....	53
Power connector .....	54
TouchPad .....	55
Display panel .....	59
Webcam .....	63
WLAN antenna .....	65
<b>7 Using HP PC Hardware Diagnostics (UEFI) .....</b>	<b>67</b>
Downloading HP PC Hardware Diagnostics (UEFI) to a USB device .....	67
<b>8 Backing up, restoring, and recovering .....</b>	<b>69</b>
Creating recovery media and backups .....	69
Creating HP Recovery media (select products only) .....	69
Using Windows tools .....	70
Restore and recovery .....	71
Recovering using HP Recovery Manager .....	71
What you need to know before you get started .....	71
Using the HP Recovery partition (select products only) .....	72
Using HP Recovery media to recover .....	72
Changing the computer boot order .....	73
Removing the HP Recovery partition (select products only) .....	74
<b>9 Specifications .....</b>	<b>75</b>
Computer specifications .....	75



39.62 cm (15.6-in) display specifications .....	76
Hard drive specifications .....	76
Solid-state drive specifications .....	77
DVD±RW SuperMulti DL Drive specifications .....	78
<b>10 Power cord set requirements .....</b>	<b>79</b>
Requirements for all countries .....	79
Requirements for specific countries and regions .....	79
<b>11 Recycling .....</b>	<b>81</b>
<b>Index .....</b>	<b>82</b>



# 1 Product description

Category	Description
<b>Product Name</b>	HP Pavilion Notebook PC
<b>Processors</b>	<b>AMD Bristol Ridge</b> <b>AMD Quad-Core A-Series Accelerated Processor (Bristol Ridge, BGA)</b> A12-9700P (2.5GHz, up to 3.4GHz), 1866 MHz/2 MB L2, Quad 15W A10-9600P (2.4GHz, up to 3.3GHz), 1866 MHz/2 MB L2, Quad 15W <b>AMD Stoney Ridge</b> AMD A-Series Accelerated Processor (Stoney Ridge, BGA) A9-9410 (2.9GHz, up to 3.5GHz), 1866 MHz/1 MB L2, Dual 15W A6-9210 (2.4 GHz, up to 2.8 GHz), 1866 MHz/1 MB L2, Dual 15W
<b>Chipset</b>	AMD Integrated SOC FCH (Bristol Ridge) printed/laser etched service tag on D cover/xxx (internal service label required) (Stoney Ridge)
<b>Graphics</b>	<b>Internal graphics:</b> AMD Radeon™ R7 Graphics (Bristol Ridge A12) AMD Radeon™ R5 Graphics (Bristol Ridge A10/Stoney Ridge A9) AMD Radeon™ R4 Graphics (Stoney Ridge A6) <b>Switchable discrete graphics:</b> AMD Radeon™ R7 M440 R16M-M1-70 (Meso Pro DDR3) with up to 2048MB of dedicated video memory (256Mx16 DDR3 900MHz x 4 PCs, 1GHz bridge to 900MHz), TDP 25W AMD Radeon™ R7 M440 R16M-M1-70 (Meso Pro DDR3) with up to 4096MB of dedicated video memory (512Mx16 DDR3 900MHz x 4 PCs, 1GHz bridge to 900MHz), TDP 25W (Bristol Ridge only) Support HD Decode, DX12, and HDMI Support PX7 Support dynamic switching Support Freesync technology <b>Support Dual Graphics</b> AMD Radeon™ R6 M445DX Dual Graphics
<b>Panel</b>	16:9 Ultra Wide Aspect Ratio 15.6" HD WLED BrightView (1366x768) slim-flat (3.2mm) SVA, eDP, 220 nits 15.6" HD WLED BrightView (1366x768) slim-flat (3.2mm) SVA, eDP, TOP, 200 nits 15.6" FHD WLED AntiGlare (1920x1080) slim-flat (3.2mm) SVA, eDP, Special Deal, 220 nits 15.6" FHD WLED BrightView (1920x1080) slim-flat (3.2mm) UWVA, eDP, 250nits, bridged to 220nits FHD UWVA panel 15.6" FHD WLED BrightView (1920x1080) slim-flat (3.2mm) UWVA, eDP, TOP, 220 nits Touch solution with bezel, multitouch enabled

Category	Description
	Support eDP 1.4
<b>Memory</b>	<p>Two SODIMM slots - customer non-accessible/non-upgradeable</p> <p>DDR4-1866 Dual Channel Support (Bristol Ridge)</p> <p>DDR4-1866 Single Channel Support (Stoney Ridge)</p> <p>DDR4-2400 SO-DIMM Support</p> <p><b>Supports up to 16GB max system memory</b></p> <p>4096MB (4096MB x 1)</p> <p>6144MB (2048MB x 1 + 4096MB x 1)</p> <p>8192MB (4096MB x 2)</p> <p>8192MB (8192MB x 1)</p> <p>12288MB (8192MB + 4096MB)</p> <p>16384MB (8192MB x 2)</p>
<b>Hard drive</b>	<p><b>Supports all 7mm/9.5mm, SATA 2.5" HDDs</b></p> <p>Accelerometer / HDD protection support</p> <p><b>M.2 SATA configurations (Value)</b></p> <p>128GB Value SSD</p> <p>256GB Value SSD</p> <p><b>Single HDD configurations</b></p> <p>500GB (5400) 7.2mm</p> <p>1TB (5400) 9.5mm</p> <p>2TB (5400) 9.5mm</p> <p><b>SSHD configurations</b></p> <p>1TB 5400RPM 9.5mm SSHD w/8GB NAND</p>
<b>Optical drive (select models only)</b>	<p><b>9.0mm tray load - SATA - Fixed (not modular)</b></p> <p>DVD+/-RW Double-Layer SuperMulti</p> <p>Support Zero-Power ODD</p> <p>Support M-disc</p>
<b>Webcam and Microphone</b>	<p>HP Wide Vision HD: HD camera - indicator LED, USB2.0, BSI sensor, f2.0, 88° WFOV</p> <p>720p by 30 frames per second</p> <p>Dual array Digital Microphones w/ appropriate software - beam forming, echo cancellation, noise suppression</p> <p>Support Smart Amp</p> <p>Enable HP Noise Cancellation</p>
<b>Audio</b>	<p>B&amp;O Play</p> <p>Dual Speakers</p>
<b>Ethernet</b>	Integrated 10/100 NIC
<b>Sensors</b>	Accelerometer





Category	Description
<b>Wireless</b>	<b>Integrated Wireless options with single antenna (M.2/PCIe)</b>
	Realtek RTL8723BE-VB 802.11b/g/n 1x1 Wi-Fi + BT4.0 Combo Adapter
	Broadcom BCM43142 802.11 b/g/n 1x1 Wi-Fi + BT4.0 Combo Adapter
	<b>Integrated Wireless options with dual antennas (M.2/PCIe):</b>
	Intel Dual Band Wireless-AC 3165 802.11 ac 1x1 WiFi + BT 4.2 Combo Adapter
	Compatible with Miracast-certified devices
<b>External media cards</b>	<b>HP Multi-Format Digital Media Card Reader</b>
	Support SD/SDHC/SDXC
	Push-Push Insertion/Removal
<b>Internal card expansion</b>	One M.2 slot for WLAN
	One M.2 slot for SSD
<b>Ports</b>	<b>Video Ports on Unit:</b>
	Hot Plug / Unplug and auto detect for correct output to wide-aspect vs. standard aspect video (auto adjust panel resolution to fit embedded panel and external monitor connected)
	HDMI v1.4 supporting: up to 1920x1080 @ 60Hz
	Headphone / Line out
	Microphone input
	<b>USB 2.0 Ports on Unit:</b>
	1 (left side)
	<b>USB 3.0 Ports on Unit:</b>
	2 (1 on the left side ; 1 on the other)
	<b>USB 2.0/3.0 Allocation:</b>
	3 for the unit
	1 for Camera
	1 for WLAN + BT Combo
1 for HMC	
RJ-45 / Ethernet	
AC Smart Pin adapter plug	
<b>Keyboard/pointing devices</b>	Full Size Textured island-style Keyboard with numeric key pad in Ash Silver finish
	Full Size Standard 3 Coat Paint island-style backlit Keyboard with numeric keypad in Ash Silver finish
	Full Size Textured island-style Keyboard with numeric key pad in Winter White finish
	Full Size Backlit 3 Coat paint island-style Keyboard with numeric key pad in Winter White finish
	<b>Clickpad Requirements:</b>
	Clickpad with image sensor
	Multitouch gestures enabled
	Support Modern Trackpad Gestures

Category	Description
	Taps enabled as default
<b>Power requirements</b>	<p><b>Batteries:</b></p> <p>2 cell prismatic battery - 41 Whr (5360mAh)</p> <p>Supports battery fast charge (90min, 90% charge)</p> <p><b>AC Adapters:</b></p> <ul style="list-style-type: none"> <li>• 45W (Cupid)</li> <li>• 65W (Hera)</li> <li>• 65W Slim Travel Adapter (Smart-Pin)</li> <li>• 1M length power cord</li> </ul>
<b>Security</b>	<p>TPM 2.0</p> <p>Kensington Security Lock</p>
<b>Operating system</b>	<p><b>Preinstalled:</b></p> <p>Windows 10 Professional</p> <p>Windows 10</p> <p><b>For Developed Market (ML):</b></p> <p>Windows 10 Home ML</p> <p>Windows 10 Home High End ML</p> <p><b>For Emerging Market (EM/SL):</b></p> <p>Windows 10 Home Value NB</p> <p>SEAP Windows 10 Home Value Notebook</p> <p>Windows 10 Home EM/SL</p> <p>Windows 10 Home High End EM/SL/China</p> <p>SEAP Windows 10 Home Single Language Edition</p> <p>SEAP Windows 10 Home High End</p> <p>CPPP Windows 10 Home China Language Edition</p> <p>FreeDOS 2.0</p>
<b>Serviceability</b>	<p><b>End user replaceable parts:</b></p> <p>Optical drive (select products only)</p> <p>AC adapter</p> <p><b>Raw Panel Replacement</b></p>

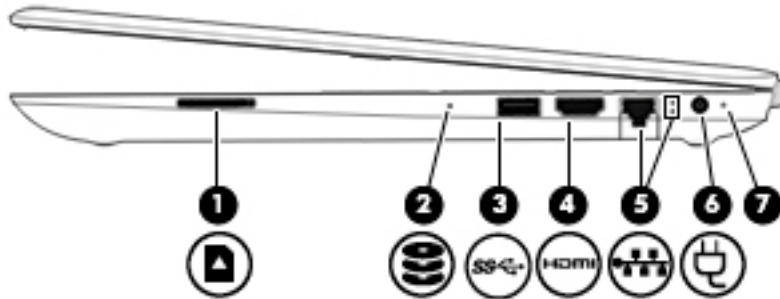
## 2 External component identification

### Right side



		Description
(1)		<p>Memory card reader (select products only)</p> <p>Reads optional memory cards that enable you to store, manage, share, or access information.</p> <p>To insert a card:</p> <ol style="list-style-type: none"> <li>1. Hold the card label-side up, with connectors facing the computer.</li> <li>2. Insert the card into the memory card reader, and then press in on the card until it is firmly seated.</li> </ol> <p>To remove a card:</p> <ul style="list-style-type: none"> <li>▲ Press in on the card, and then remove it from the memory card reader.</li> </ul>
(2)		<p>Drive light (select products only)</p> <ul style="list-style-type: none"> <li>• Blinking white: The hard drive is being accessed.</li> <li>• Amber: HP 3D DriveGuard has temporarily parked the hard drive (select products only).</li> </ul>
(3)		<p>USB 3.0 port</p> <p>Connects an optional USB device, such as a keyboard, mouse, external drive, printer, scanner or USB hub.</p>
(4)		<p>HDMI port</p> <p>Connects an optional video or audio device, such as a high-definition television, any compatible digital or audio component, or a high-speed High Definition Multimedia Interface (HDMI) device.</p>
(5)		<p>RJ-45 (network) jack/status lights</p> <p>Connects a network cable.</p> <ul style="list-style-type: none"> <li>• White: The network is connected.</li> <li>• Amber: Activity is occurring on the network.</li> </ul>
(6)		<p>Power connector</p> <p>Connects an AC adapter.</p>
(7)		<p>AC adapter and battery light</p> <ul style="list-style-type: none"> <li>• White: The AC adapter is connected and the battery is fully charged.</li> <li>• Blinking white: The AC adapter is disconnected and the battery has reached a low battery level.</li> </ul>

---

**Description**

---

- Amber: The AC adapter is connected and the battery is charging.
  - Off: The battery is not charging.
- 



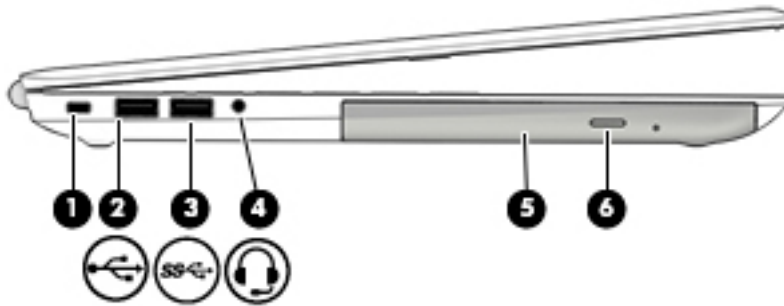



## Left side



---

**Description**

---

(1)		Security cable slot	Attaches an optional security cable to the computer. <b>NOTE:</b> The security cable is designed to act as a deterrent, but it may not prevent the computer from being mishandled or stolen.
(2)		USB 2.0 port	Connects an optional USB device, such as a keyboard, mouse, external drive, printer, scanner or USB hub.
(3)		USB 3.0 port	Connects an optional USB device, such as a keyboard, mouse, external drive, printer, scanner or USB hub.
(4)		Audio-out (headphone)/Audio-in (microphone) combo jack	Connects optional powered stereo speakers, headphones, earbuds, a headset, or a television audio cable. Also connects an optional headset microphone. This jack does not support optional standalone microphones. <b>WARNING!</b> To reduce the risk of personal injury, adjust the volume before putting on headphones, earbuds, or a headset. For additional safety information, refer to the <i>Regulatory, Safety, and Environmental Notices</i> . To access this guide: ▲ Select the <b>Start</b> button, select <b>All apps</b> , select <b>HP Help and Support</b> , and then select <b>HP Documentation</b> . <b>NOTE:</b> When a device is connected to the jack, the computer speakers are disabled.
(5)		Optical drive (select products only)	Depending on your computer, reads an optical disc or reads and writes to an optical disc. <b>NOTE:</b> For disc compatibility information, type <code>help</code> in the taskbar search box, select <b>Help and Support</b> , and then type <code>disc compatibility</code> in the search box.
(6)		Optical drive eject button (select products only)	Releases the optical drive disc tray.

---



# Display



Component	Description
(1) Internal microphones	Record sound.
(2) Camera light	On: The camera is in use.
(3) Camera	Allows you to video chat, record video, or record still images. Some also provide HD (high-definition) or 3D capability, apps for gaming, or facial recognition software like Windows Hello. For details about using Windows Hello, see “Securing your computer and information”.  To use your camera: <ul style="list-style-type: none"><li>Type <code>camera</code> in the taskbar search box, and then select <b>Camera</b>.</li><li>On select products, type <a href="#">Intel RealSense</a> in the taskbar search box to explore additional features, demos, and apps.</li></ul>
(4) WLAN antennas*	Send and receive wireless signals to communicate with wireless local area networks (WLANs).

\*The antennas are not visible from the outside of the computer. For optimal transmission, keep the areas immediately around the antennas free from obstructions.

For wireless regulatory notices, see the section of the *Regulatory, Safety, and Environmental Notices* that applies to your country or region.

To access this guide:

- ▲ Select the **Start** button, select **All apps**, select **HP Help and Support**, and then select **HP Documentation**.

# Top

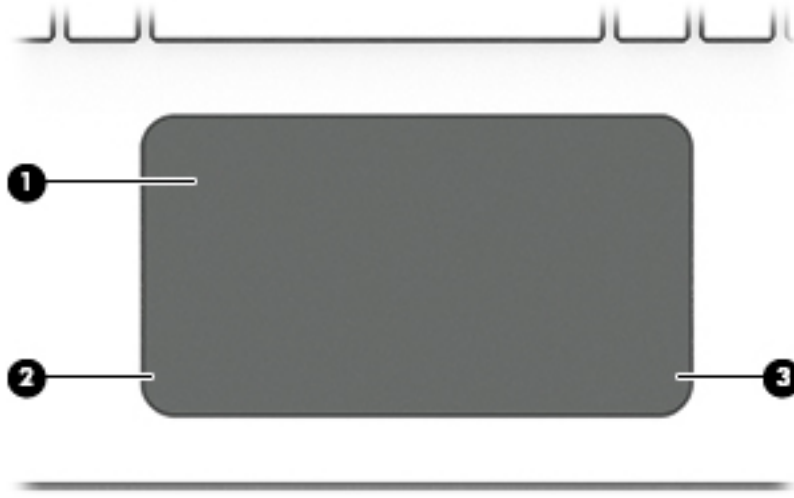

## TouchPad

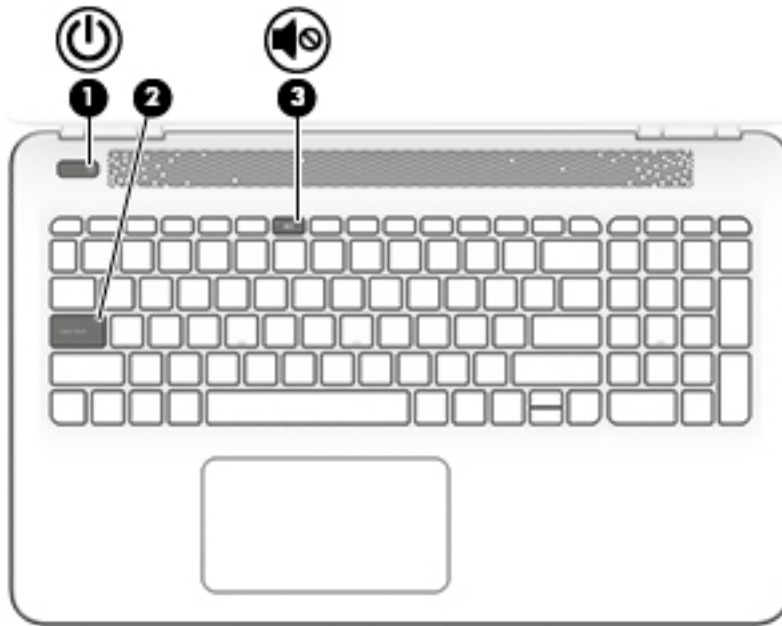

Component		Description
(1)	TouchPad zone	Reads your finger gestures to move the pointer or activate items on the screen.
(2)	Left TouchPad button	Functions like the left button on an external mouse.
(3)	Right TouchPad button	Functions like the right button on an external mouse.

## Lights



Component	Description
(1)  Power light	<ul style="list-style-type: none"><li>• On: The computer is on.</li><li>• Blinking: The computer is in the Sleep state, a power-saving state. The computer shuts off power to the display and other unneeded components.</li><li>• Off: The computer is off or in Hibernation. Hibernation is a power-saving state that uses the least amount of power.</li></ul>
(2) Caps lock light	On: Caps lock is on, which switches the key input to all capital letters.
(3)  Mute light	<ul style="list-style-type: none"><li>• Amber: Computer sound is off.</li><li>• Off: Computer sound is on.</li></ul>

## Button and speakers

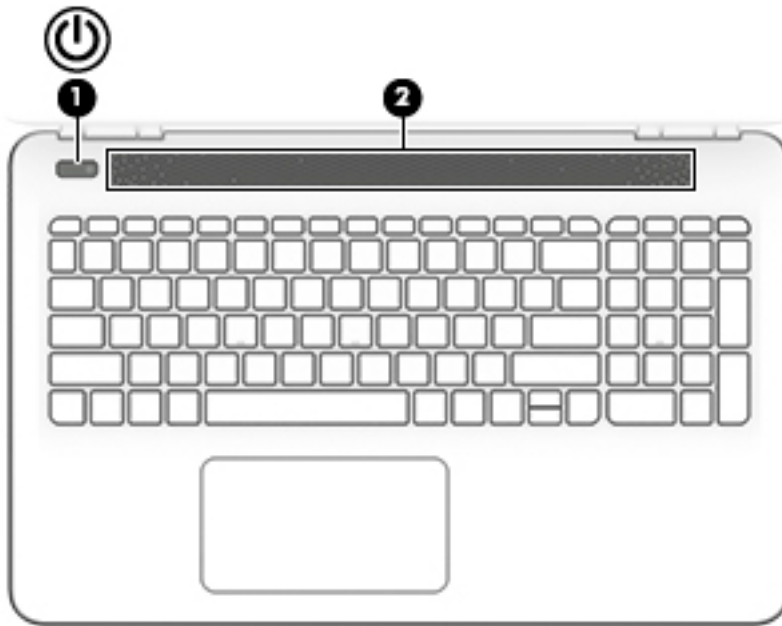





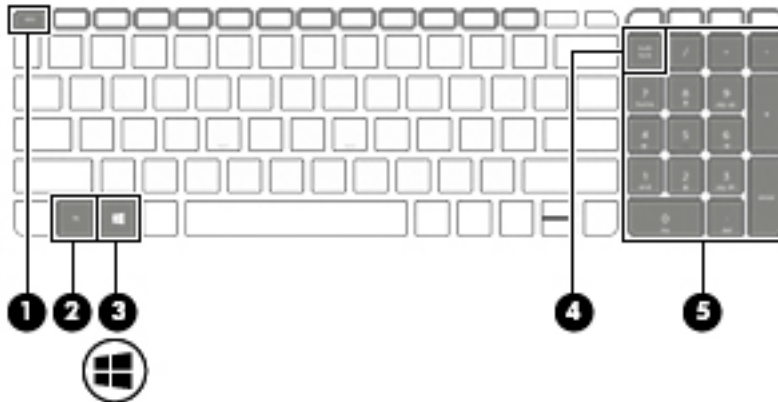

Component	Description
(1)  Power button	<ul style="list-style-type: none"><li>• When the computer is off, press the button to turn on the computer.</li><li>• When the computer is on, press the button briefly to initiate Sleep.</li><li>• When the computer is in the Sleep state, press the button briefly to exit Sleep.</li><li>• When the computer is in Hibernation, press the button briefly to exit Hibernation.</li></ul> <p><b>CAUTION:</b> Pressing and holding down the power button results in the loss of unsaved information.</p> <p>If the computer has stopped responding and shutdown procedures are ineffective, press and hold the power button down for at least 5 seconds to turn off the computer.</p> <p>To learn more about your power settings, see your power options.</p> <p>▲ Type <code>power</code> in the taskbar search box, and then select <b>Power and sleep settings</b>.</p> <p>– or –</p> <p>Right-click the <b>Start</b> button, and then select <b>Power Options</b>.</p>
(2) Speakers	Produce sound.

## Keys





**NOTE:** Refer to the illustration that most closely matches your computer.











Component	Description
(1)  <b>esc</b> key	Displays system information when pressed in combination with the <b>fn</b> key.
(2)  <b>fn</b> key	Executes frequently used system functions when pressed in combination with the <b>esc</b> key, action keys, or the <b>spacebar</b> .
(3)  Windows key	Opens the <b>Start</b> menu. <b>NOTE:</b> Pressing the Windows key again will close the <b>Start</b> menu.
(4)  <b>num lock</b> key (select products only)	Alternates between the navigational and numeric functions on the integrated numeric keypad.
(5)  Integrated numeric keypad (select products only)	When <b>num lock</b> is on, the keypad can be used like an external numeric keypad.

## Using the action keys

- An action key performs an assigned function.
- The icon on each action key illustrates the function for that key.
- To use an action key, press and hold the key.

Icon	Description
	Decreases the screen brightness incrementally as long as you hold down the key.
	Increases the screen brightness incrementally as long as you hold down the key.
	Switches the screen image between display devices connected to the system. For example, if a monitor is connected to the computer, repeatedly pressing this key alternates the screen image from the computer display to the monitor display to a simultaneous display on both the computer and the monitor.

Icon	Description
	Turns the keyboard backlight off or on. <b>NOTE:</b> To conserve battery power, turn off this feature.
	Mutes or restores speaker sound.
	Decreases speaker volume incrementally while you hold down the key.
	Increases speaker volume incrementally while you hold down the key.
	Plays the previous track of an audio CD or the previous section of a DVD or a Blu-ray Disc (BD).
	Starts, pauses, or resumes playback of an audio CD, a DVD, or a BD.
	Plays the next track of an audio CD or the next section of a DVD or a BD.
	Turns the airplane mode and wireless feature on or off. <b>NOTE:</b> The airplane mode key is also referred to as the wireless button. <b>NOTE:</b> A wireless network must be set up before a wireless connection is possible.

## Bottom

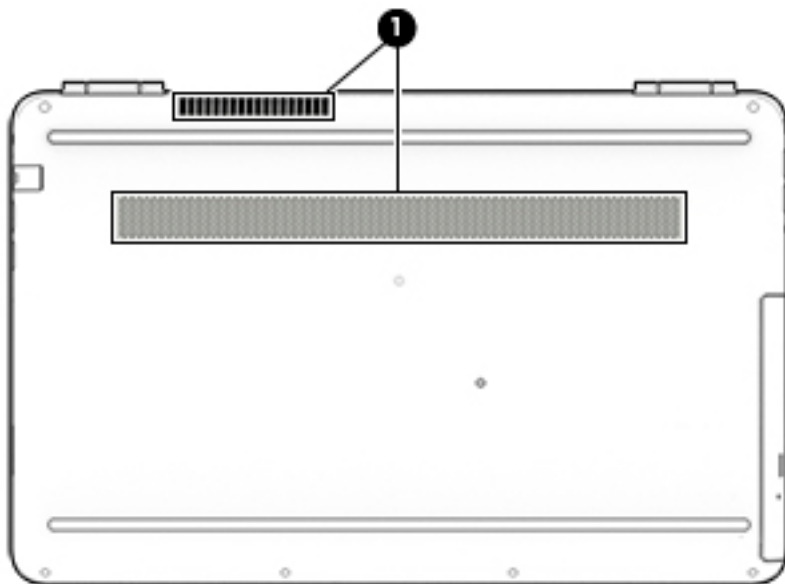

Description	
Vents (2)	Enable airflow to cool internal components.

---

**Description**

---

**NOTE:** The computer fan starts up automatically to cool internal components and prevent overheating. It is normal for the internal fan to cycle on and off during routine operation.

---

## Rear



---

**Description**

---

Vent

Enables airflow to cool internal components.

**NOTE:** The computer fan starts up automatically to cool internal components and prevent overheating. It is normal for the internal fan to cycle on and off during routine operation.

---

## Locating system information

Important system information is located on the bottom edge of the tablet or on the keyboard base. You may need the information when travelling internationally or when you contact support:

- (1):** Warranty period
- (2):** Serial number
- (3):** Product number
- (4):** Model number

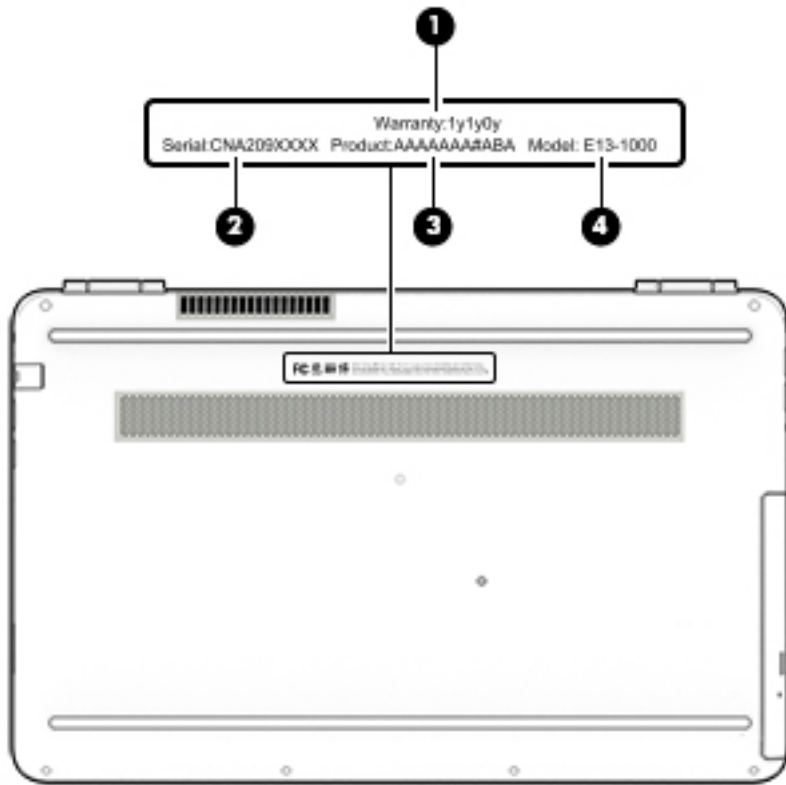

Using Windows, briefly press the **fn+esc** key combination to display the System Information screen, which provides the product name and serial number of your computer, as well as information about the memory, processor, BIOS, and keyboard.





---

## 3 Illustrated parts catalog

### Computer major components

---

 **NOTE:** HP continually improves and changes product parts. For complete and current information on supported parts for your computer, go to <http://partsurfer.hp.com>, select your country or region, and then follow the on-screen instructions.

 **NOTE:** Details about your computer, including model, serial number, product key, and length of warranty, are on the service tag at the bottom of your computer. See [Locating system information on page 13](#) for details.

---

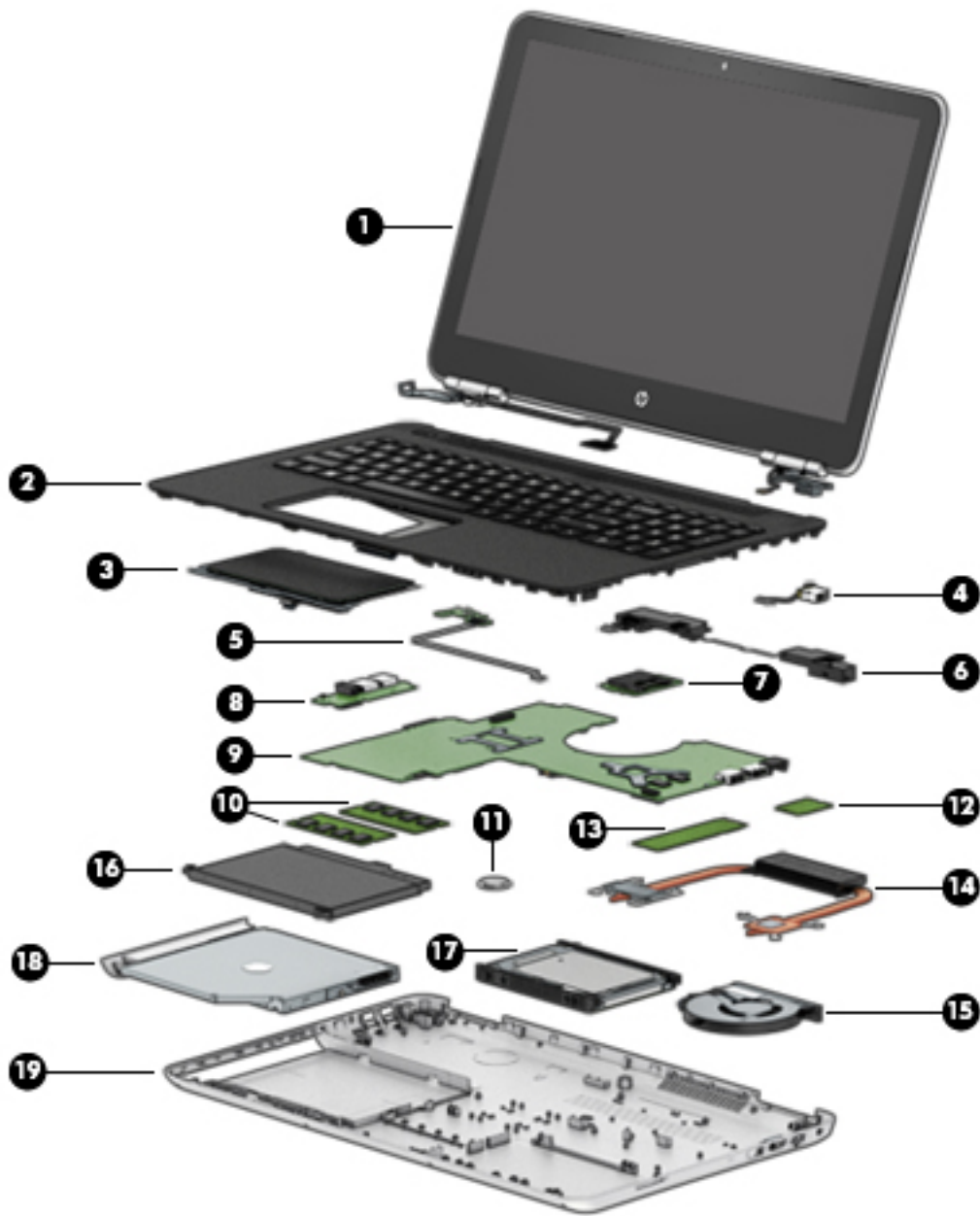

Item	Component	Spare part number
(1)	<b>Display panel</b> (see <a href="#">Display assembly subcomponents on page 18</a> )	
(2)	<b>Top cover with TouchPad and keyboard</b> (see <a href="#">TouchPad on page 55</a> for a detailed list of country codes)	
(3)	<b>TouchPad</b> (included with top cover)	
(4)	<b>Power connector</b> (includes cable)	808155-010
(5)	<b>Power button board</b> (includes cable)	856369-001
(6)	<b>Speaker Kit</b>	856383-001
(7)	<b>SD card reader board</b>	857791-001
(8)	<b>I/O board</b>	856370-001

Item	Component	Spare part number
<b>(9)</b>	<b>System board</b> (see <a href="#">System board on page 48</a> )	
<b>(10)</b>	<b>Memory</b>	
	4 GB 2133 MHz 1.2v DDR4 shared	820569-005
	8 GB 2133 MHz 1.2v DDR4 shared	820570-005
	2 GB 2133 MHz 1.2v DDR4 shared	851379-005
<b>(11)</b>	<b>RTC battery</b>	741976-001
<b>(12)</b>	<b>WLAN module</b>	
	WLAN 11AC INT 3165 M.2 MOW	806723-005
	WLAN assembly, RT 11BGN+BT4 1x1 SANJI2 CB	855106-855
<b>(13)</b>	<b>Solid-state drive</b>	
	GNRC SSD 256GB 2280 M2 SATA-3 Value Baba	865902-001
	GNRC SSD 128 GB 2280 M2 SATA-3 Value	827560-016
<b>(14)</b>	<b>Heat sink</b>	
	Heat sink for products with UMA graphics	857480-001
	Heat sink for products with discrete graphics	857481-001
<b>(15)</b>	<b>Fan</b>	856359-001
<b>(16)</b>	<b>Battery</b>	849909-855
<b>(17)</b>	<b>Hard drive</b>	
	1 TB 5400 RPM SATA RAW HYBRID 8 GB	731999-005
	500 GB 5400 RPM SATA RAW 2.5-in	778188-005
	1 TB 5400 RPM SATA RAW 2.5-in	778192-005
	2 TB 5400 RPM SATA RAW 9.5 mm	801808-005
<b>(18)</b>	<b>Optical drive</b>	803929-004
<b>(19)</b>	<b>Base enclosure</b>	
	In Natural Silver finish	856332-001
	In Onyx Black finish	856333-001
	In Modern Gold finish	856334-001
	In Cardinal Red finish	856335-001
	In Sport Purple finish	856336-001
	In Dragonfly Blue finish	856337-001
	In Blizzard White finish	856338-001

## Display assembly subcomponents

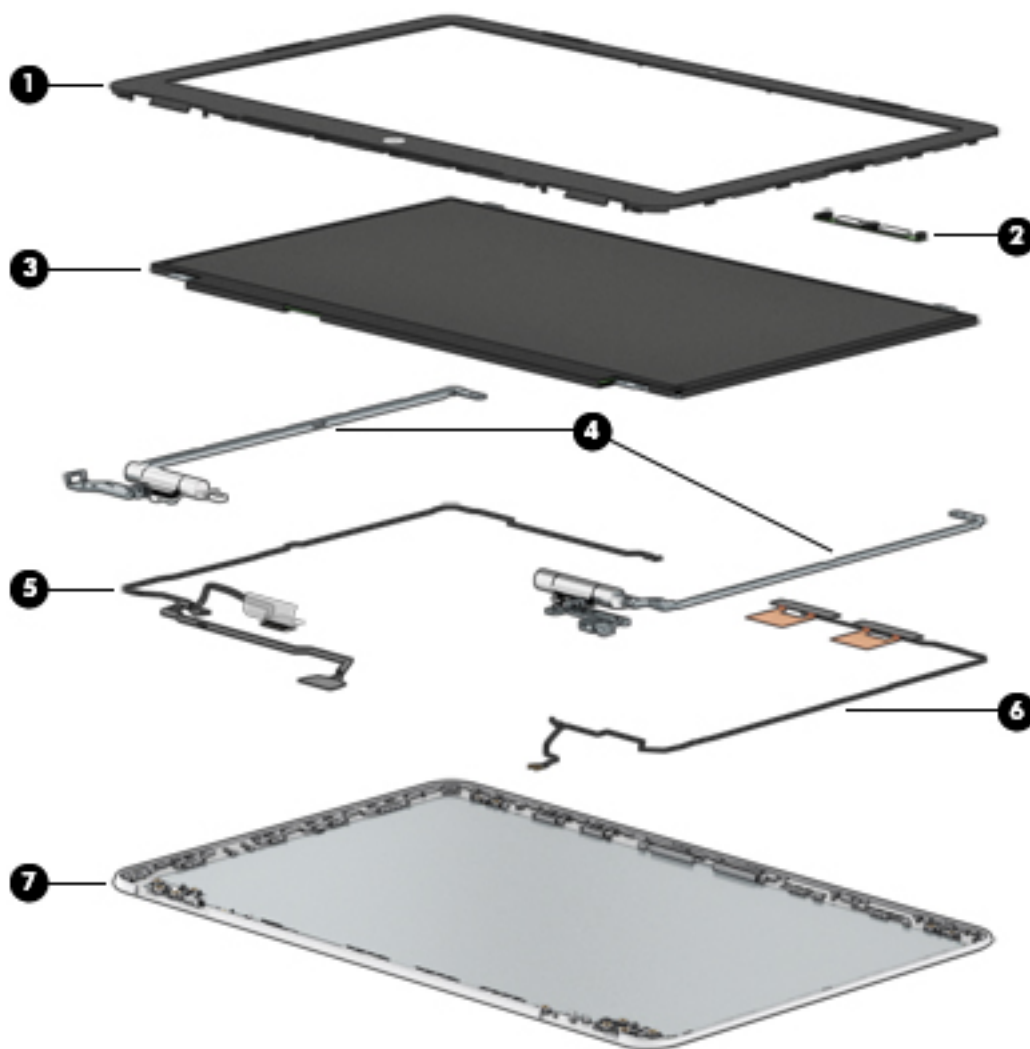

Item	Component	Spare part number
(1)	<b>Bezel</b>	856346-001
(2)	<b>Webcam</b>	846006-003
(3)	<b>Raw panel</b>	
	15.6 FHD AG SVA 220eDP Slim PF	798933-009
	15.6 HD BV WLED SVAeDPSlimTOP PF	809612-009
	15.6 FHD BV UWVA 220 eDP SlimPF	842463-005
	15.6HD BV WLED SVA220 eDPSlim PF	847654-002
	15.6 FHD BVUWVA220 eDPSlim TOPPF	848085-001
(4)	<b>Hinge assembly</b>	856367-001
(5)	<b>Display cable</b>	856346-001

Item	Component	Spare part number
<b>(6)</b>	<b>WLAN</b>	
	WLAN module	806723-005
	WLAN assembly	855106-855
<b>(7)</b>	<b>Back cover</b>	
	In Natural Silver finish, with dual antenna	856325-001
	In Onyx Black finish, with dual antenna	856326-001
	In Modern Gold finish, with dual antenna	856327-001
	In Cardinal Red finish, with dual antenna	856328-001
	In Sport Purple finish, with dual antenna	856329-001
	In Dragonfly Blue finish, with dual antenna	856330-001
	In Blizzard White finish, with dual antenna	856331-001
	In Natural Silver finish, with single antenna	859652-001
	In Onyx Black finish, with single antenna	859653-001
	In Modern Gold finish, with single antenna	859654-001
	In Cardinal Red finish, with single antenna	859655-001
	In Sport Purple finish, with single antenna	859656-001
	In Dragonfly Blue finish, with single antenna	859657-001
	In Blizzard White finish, with single antenna	859658-001

## Miscellaneous parts

Component	Spare part number
<b>AC adapter</b>	
65W adapter nPFC S-3P 4.5MM	710412-001
65W adapter nPFC SMART 4.5mm EM	714635-850
65W adapter nPFC SMART 4.5mm EM	741553-850
HP HDMI to VGA Adapter	701943-001
<b>Plastics Kit</b>	
Dummy optical drive, in Natural Silver finish	856361-001
Dummy optical drive, in Modern Gold finish	856363-001
Dummy optical drive, in Cardinal Red finish	856364-001
Dummy optical drive, in Blizzard White finish	860915-001
Hinge cap assembly	856372-001
Solid-state drive holder	856385-001

<b>Component</b>	<b>Spare part number</b>
<b>Power cord</b>	
For use in NEMA	213349-009
For use in Europe	213350-009
For use in the United Kingdom	213351-008
For use in Italy	213352-008
For use in Denmark	213353-008
For use in Switzerland	213354-008
For use in Australia	213356-008
For use in South Korea	267836-008
For use in Thailand	285096-006
For use in the People's Republic of China	286497-008
For use in Japan	349756-002
OPT-917 3-COND 1.0-M-LG ROHS	361240-002
For use in Taiwan	393313-003
For use in Israel	398063-003
For use in India	404827-003
<b>Rubber Kit</b>	
In Natural Silver finish	856375-001
In Onyx Black finish	856376-001
In Modern Gold finish	856377-001
In Cardinal Red finish	856378-001
In Sport Purple finish	856379-001
In Dragonfly Blue finish	856380-001
In Blizzard White finish	856381-001
<b>Screw Kit</b>	856382-001
<b>Sleeve, HP 15.6 Black/Red Chroma</b>	853427-001

---

## 4 Removal and replacement procedures preliminary requirements

### Tools required

You will need the following tools to complete the removal and replacement procedures:

- Flat-bladed screwdriver
- Magnetic screwdriver
- Phillips P0 and P1 screwdrivers

### Service considerations

The following sections include some of the considerations that you must keep in mind during disassembly and assembly procedures.

---

 **NOTE:** As you remove each subassembly from the computer, place the subassembly (and all accompanying screws) away from the work area to prevent damage.

---

### Plastic parts

---

 **CAUTION:** Using excessive force during disassembly and reassembly can damage plastic parts. Use care when handling the plastic

---

## Cables and connectors

---

**⚠ CAUTION:** When servicing the computer, be sure that cables are placed in their proper locations during the reassembly process. Improper cable placement can damage the computer.

---

Cables must be handled with extreme care to avoid damage. Apply only the tension required to unseat or seat the cables during removal and insertion. Handle cables by the connector whenever possible. In all cases, avoid bending, twisting, or tearing cables. Be sure that cables are routed in such a way that they cannot be caught or snagged by parts being removed or replaced. Handle flex cables with extreme care; these cables tear easily.

## Drive handling

---

**⚠ CAUTION:** Drives are fragile components that must be handled with care. To prevent damage to the computer, damage to a drive, or loss of information, observe these precautions:

Before removing or inserting a hard drive, shut down the computer. If you are unsure whether the computer is off or in Hibernation, turn the computer on, and then shut it down through the operating system.

Before handling a drive, be sure that you are discharged of static electricity. While handling a drive, avoid touching the connector.

Before removing an optical drive, be sure that a disc is not in the drive and be sure that the optical drive tray is closed.

Handle drives on surfaces covered with at least one inch of shock-proof foam.

Avoid dropping drives from any height onto any surface.

After removing a hard drive or an optical drive, place it in a static-proof bag.

Avoid exposing an internal hard drive to products that have magnetic fields, such as monitors or speakers.

Avoid exposing a drive to temperature extremes or liquids.

If a drive must be mailed, place the drive in a bubble pack mailer or other suitable form of protective packaging and label the package “FRAGILE.”

---



# Grounding guidelines

## Electrostatic discharge damage

Electronic components are sensitive to electrostatic discharge (ESD). Circuitry design and structure determine the degree of sensitivity. Networks built into many integrated circuits provide some protection, but in many cases, ESD contains enough power to alter device parameters or melt silicon junctions.

A discharge of static electricity from a finger or other conductor can destroy static-sensitive devices or microcircuitry. Even if the spark is neither felt nor heard, damage may have occurred.

An electronic device exposed to ESD may not be affected at all and can work perfectly throughout a normal cycle. Or the device may function normally for a while, then degrade in the internal layers, reducing its life expectancy.

**CAUTION:** To prevent damage to the computer when you are removing or installing internal components, observe these precautions:

Keep components in their electrostatic-safe containers until you are ready to install them.

Before touching an electronic component, discharge static electricity by using the guidelines described in this section.

Avoid touching pins, leads, and circuitry. Handle electronic components as little as possible.

If you remove a component, place it in an electrostatic-safe container.

The following table shows how humidity affects the electrostatic voltage levels generated by different activities.

**CAUTION:** A product can be degraded by as little as 700 V.

Typical electrostatic voltage levels			
Event	Relative humidity		
	10%	40%	55%
Walking across carpet	35,000 V	15,000 V	7,500 V
Walking across vinyl floor	12,000 V	5,000 V	3,000 V
Motions of bench worker	6,000 V	800 V	400 V
Removing DIPS from plastic tube	2,000 V	700 V	400 V
Removing DIPS from vinyl tray	11,500 V	4,000 V	2,000 V
Removing DIPS from plastic foam	14,500 V	5,000 V	3,500 V
Removing bubble pack from PCB	26,500 V	20,000 V	7,000 V
Packing PCBs in foam-lined box	21,000 V	11,000 V	5,000 V

## Packaging and transporting guidelines

Follow these grounding guidelines when packaging and transporting equipment:

- To avoid hand contact, transport products in static-safe tubes, bags, or boxes.
- Protect ESD-sensitive parts and assemblies with conductive or approved containers or packaging.
- Keep ESD-sensitive parts in their containers until the parts arrive at static-free workstations.
- Place items on a grounded surface before removing items from their containers.
- Always be properly grounded when touching a component or assembly.
- Store reusable ESD-sensitive parts from assemblies in protective packaging or nonconductive foam.
- Use transporters and conveyors made of antistatic belts and roller bushings. Be sure that mechanized equipment used for moving materials is wired to ground and that proper materials are selected to avoid static charging. When grounding is not possible, use an ionizer to dissipate electric charges.

## Workstation guidelines

Follow these grounding workstation guidelines:

- Cover the workstation with approved static-shielding material.
- Use a wrist strap connected to a properly grounded work surface and use properly grounded tools and equipment.
- Use conductive field service tools, such as cutters, screwdrivers, and vacuums.
- When fixtures must directly contact dissipative surfaces, use fixtures made only of static safe materials.
- Keep the work area free of nonconductive materials, such as ordinary plastic assembly aids and plastic foam.
- Handle ESD-sensitive components, parts, and assemblies by the case or PCM laminate. Handle these items only at static-free workstations.
- Avoid contact with pins, leads, or circuitry.
- Turn off power and input signals before inserting or removing connectors or test equipment.

## Equipment guidelines

Grounding equipment must include either a wrist strap or a foot strap at a grounded workstation.

- When seated, wear a wrist strap connected to a grounded system. Wrist straps are flexible straps with a minimum of one megohm  $\pm 10\%$  resistance in the ground cords. To provide proper ground, wear a strap snugly against the skin at all times. On grounded mats with banana-plug connectors, use alligator clips to connect a wrist strap.
- When standing, use foot straps and a grounded floor mat. Foot straps (heel, toe, or boot straps) can be used at standing workstations and are compatible with most types of shoes or boots. On conductive floors or dissipative floor mats, use foot straps on both feet with a minimum of one megohm resistance between the operator and ground. To be effective, the conductive equipment must be worn in contact with the skin.

The following grounding equipment is recommended to prevent electrostatic damage:

- Antistatic tape
- Antistatic smocks, aprons, and sleeve protectors
- Conductive bins and other assembly or soldering aids
- Nonconductive foam
- Conductive tabletop workstations with ground cords of one megohm resistance
- Static-dissipative tables or floor mats with hard ties to the ground
- Field service kits
- Static awareness labels
- Material-handling packages
- Nonconductive plastic bags, tubes, or boxes
- Metal tote boxes
- Electrostatic voltage levels and protective materials

The following table lists the shielding protection provided by antistatic bags and floor mats.

Material	Use	Voltage protection level
Antistatic plastics	Bags	1,500 V
Carbon-loaded plastic	Floor mats	7,500 V
Metallized laminate	Floor mats	5,000 V

# 5 Removal and replacement procedures for Customer Self-Repair parts

This chapter provides removal and replacement procedures for Customer Self-Repair parts.

 **NOTE:** The Customer Self-Repair program is not available in all locations. Installing a part not supported by the Customer Self-Repair program may void your warranty. Check your warranty to determine if Customer Self-Repair is supported in your location.

## Component replacement procedures

 **NOTE:** Details about your computer, including model, serial number, product key, and length of warranty, are on the service tag at the bottom of your computer. See [Locating system information on page 13](#) for details.

 **NOTE:** HP continually improves and changes product parts. For complete and current information on supported parts for your computer, go to <http://partsurfer.hp.com>, select your country or region, and then follow the on-screen instructions.

One screw must be removed, replaced, and/or loosened when servicing Customer Self-Repair parts. Make special note of each screw size and location during removal and replacement.

## Optical drive (select products only)

Description	Spare part number
Optical drive, SATA DVDSM 9.0mm tray	803929-004
Bezel, optical drive	
In Natural Silver finish	856339-001
In Onyx Black finish	856340-001
In Modern Gold finish	856341-001
In Cardinal Red finish	856342-001
In Sport Purple finish	856343-001
In Dragonfly Blue finish	856344-001
In Blizzard White finish	856345-001

 **IMPORTANT:** Make special note of each screw and screw lock size and location during removal and replacement.

Before removing the optical drive, follow these steps:

1. Shut down the computer.
2. Disconnect all external devices connected to the computer.

3. Disconnect the power from the computer by first unplugging the power cord from the AC outlet and then unplugging the AC adapter from the computer.
4. Remove the base enclosure (see [Base enclosure on page 28](#)), and then remove the following components:
  - ▲ Battery (see [Battery on page 30](#)).

Remove the optical drive:

- ▲ Remove 1 Phillips 2.0x2.5 screw **(1)**, push the optical drive eject button **(2)**, and then remove the optical drive **(3)**.

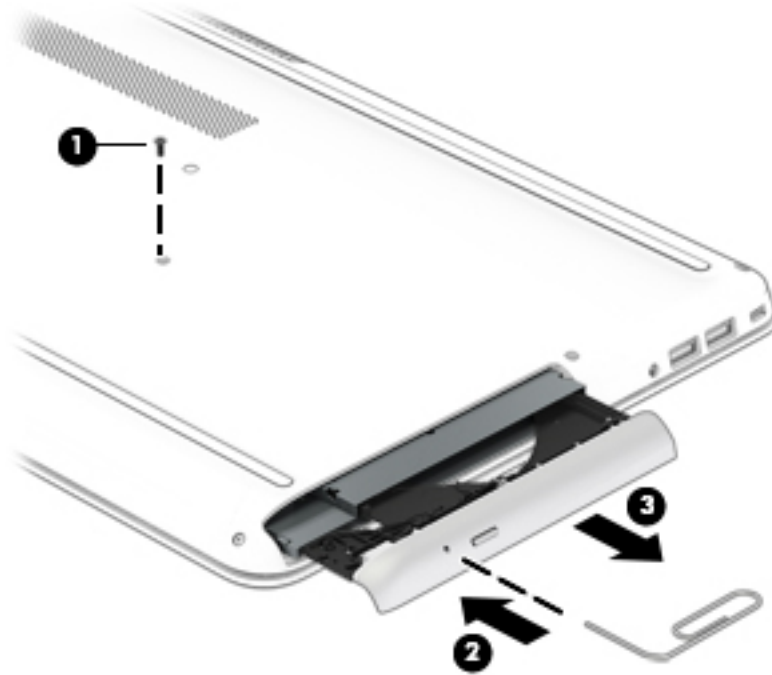

Reverse this procedure to install the optical drive.

# 6 Removal and replacement procedures for authorized service provider parts

**CAUTION:** Components described in this chapter should be accessed only by an authorized service provider. Accessing these parts can damage the computer or void the warranty.

**CAUTION:** This computer does not have user-replaceable parts. Only HP authorized service providers should perform the removal and replacement procedures described here. Accessing the internal part could damage the computer or void the warranty.

## Component replacement procedures

**NOTE:** Details about your computer, including model, serial number, product key, and length of warranty, are on the service tag at the bottom of your computer. See [Locating system information on page 13](#) for details.

**NOTE:** HP continually improves and changes product parts. For complete and current information on supported parts for your computer, go to <http://partsurfer.hp.com>, select your country or region, and then follow the on-screen instructions.

There are as many as 61 screws that must be removed, replaced, and/or loosened when servicing the parts described in this chapter. Make special note of each screw size and location during removal and replacement.

## Base enclosure

Description	Spare part number
Base enclosure	
In Natural Silver finish	856332-001
In Onyx Black finish	856333-001
In Modern Gold finish	856334-001
In Cardinal Red finish	856335-001
In Sport Purple finish	856336-001
In Dragonfly Blue finish	856337-001
In Blizzard White finish	856338-001

Before disassembling the computer, follow these steps:

1. Turn off the computer. If you are unsure whether the computer is off or in Hibernation, turn the computer on, and then shut it down through the operating system.
2. Disconnect the power from the computer by unplugging the power cord from the computer.
3. Disconnect all external devices from the computer.

Remove the base enclosure:

1. Position the computer upside down on a flat surface.
2. Remove the rubber strip (1), and then remove 8 Phillips 2x5 screws (2) and (3).

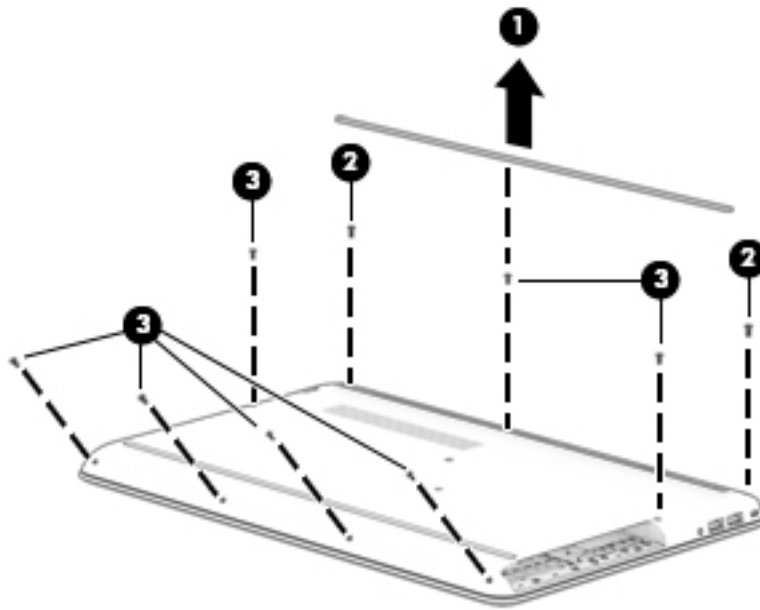

3. Slide a nylon flake tool around the edge of the base enclosure to loosen it, taking care not to damage the internal clips, and then remove the base enclosure.

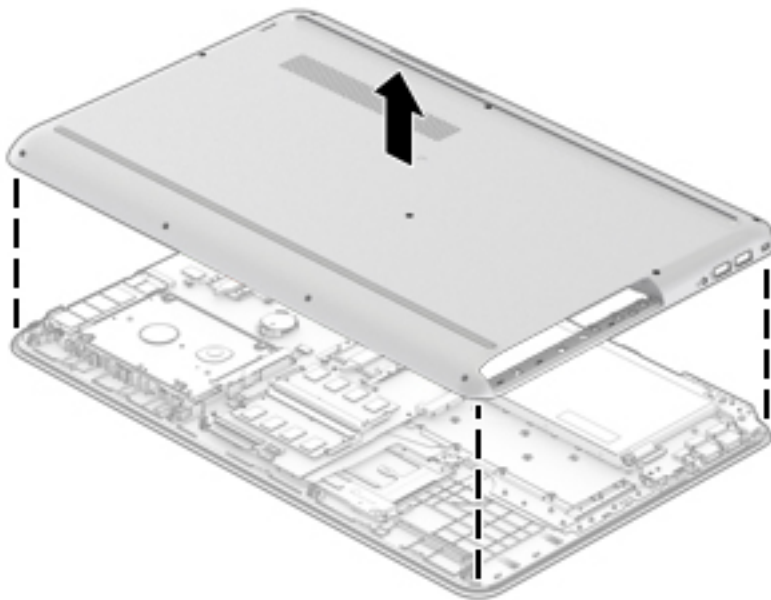

## Battery

Description	Spare part number
Battery 2C 41WH 5.36Ah LI BP02042XL-PR	849909-855
Battery cable	856351-001

Remove the battery:

**⚠ WARNING!** To reduce potential safety issues, use only the user-replaceable battery provided with the computer, a replacement battery provided by HP, or a compatible battery purchased from HP.

**⚠ CAUTION:** Removing a user-replaceable battery that is the sole power source for the computer can cause loss of information. To prevent loss of information, save your work or shut down the computer through Windows before removing the battery.

Before removing the battery, follow these steps:

1. Shut down the computer.
2. Disconnect all external devices connected to the computer.
3. Disconnect the power from the computer by first unplugging the power cord from the AC outlet and then unplugging the AC adapter from the computer.
4. Remove the base enclosure (see [Base enclosure on page 28](#)).
1. Disconnect the battery cable from the battery.

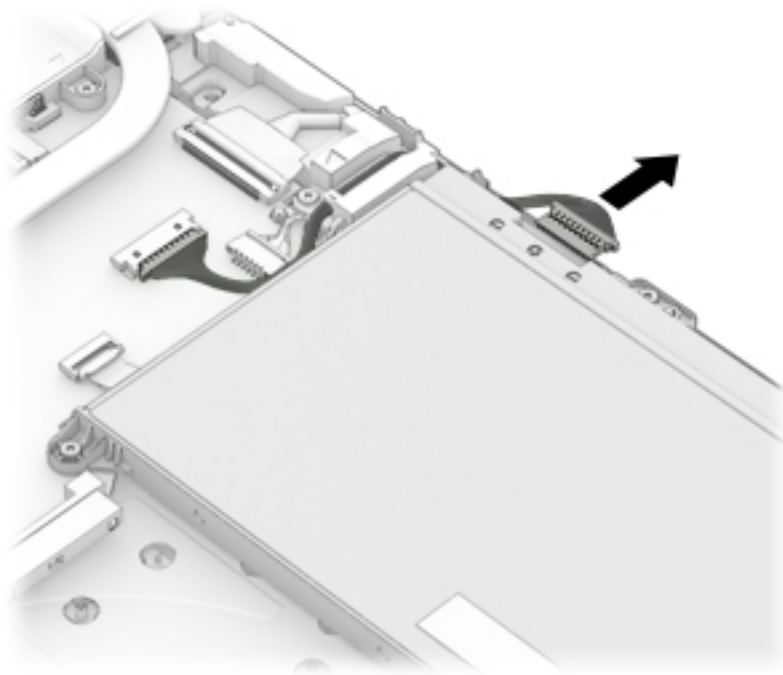



2. Remove 3 Phillips 2x5 screws (1), and then lift the battery to remove it (2).

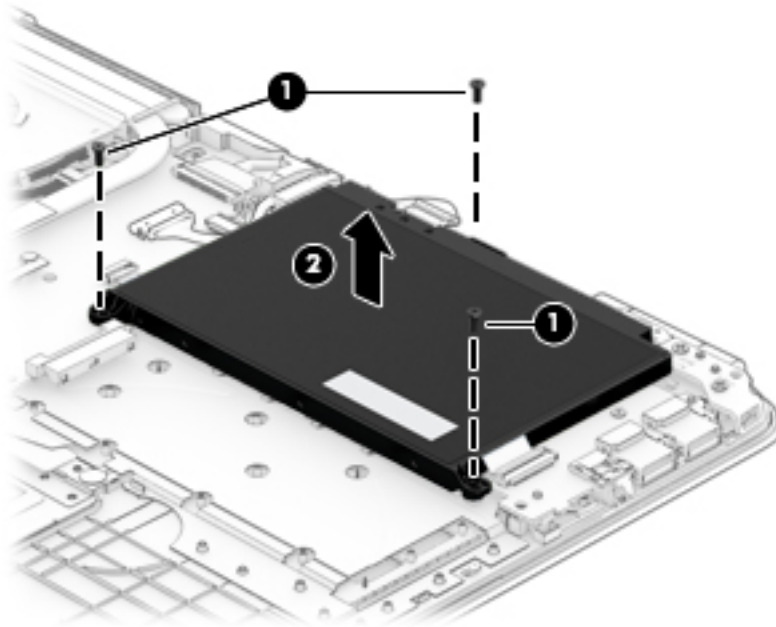

To insert the battery, reverse the removal procedures.

## Hard drive

Description	Spare part number
<b>Hard drive</b>	
1 TB 5400 RPM SATA RAW HYBRID 8 GB	731999-005
500 GB 5400 RPM SATA RAW 2.5-in	778188-005
1 TB 5400 RPM SATA RAW 2.5-in	778192-005
2 TB 5400 RPM SATA RAW 9.5 mm	801808-005
<b>Hard drive cable</b>	856352-001

 **IMPORTANT:** Make special note of each screw and screw lock size and location during removal and replacement.

Before removing the hard drive, follow these steps:

1. Shut down the computer.
2. Disconnect all external devices connected to the computer.
3. Disconnect the power from the computer by first unplugging the power cord from the AC outlet and then unplugging the AC adapter from the computer.
4. Remove the base enclosure (see [Base enclosure on page 28](#)), and then remove the following components:

- a. Battery (see [Battery on page 30](#)).
- b. Optical drive (see [Optical drive \(select products only\) on page 26](#)).

Remove the hard drive:

- ▲ Disconnect the hard drive cable (1), slide the hard drive horizontally (2), and then lift the hard drive to remove it (3).

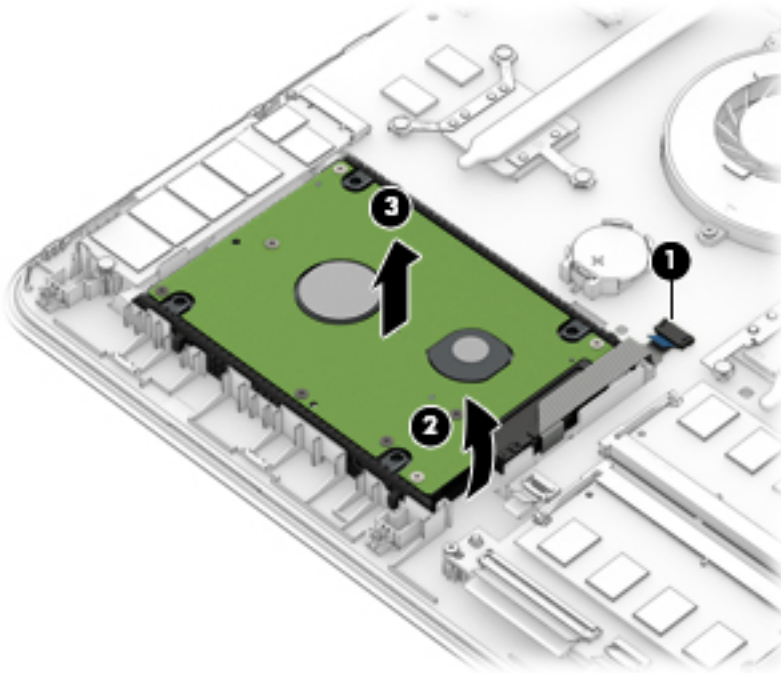

Reverse this procedure to install the hard drive.

If it is necessary to disassemble the hard drive, follow these steps:

- ▲ Remove the hard drive connector (1), and then remove the side brackets (2).

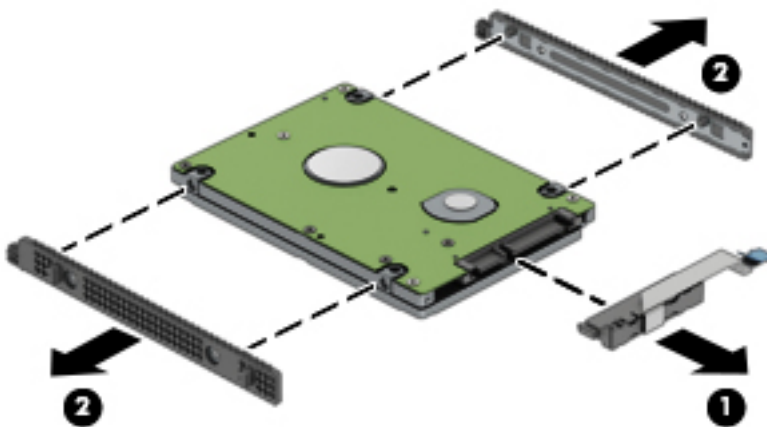

Reverse this procedure to reassemble the hard drive.

## SSD (M.2)

Description	Spare part number
Solid-state drive board	856210-001
GNRC SSD 256GB 2280 M2 SATA-3 Value	865902-001
GNRC SSD 128GB 2280 M2 SATA-3 Value	847110-002
Solid-state drive cable	856353-001

Before removing the SSD, follow these steps:

1. Turn off the computer. If you are unsure whether the computer is off or in Hibernation, turn the computer on, and then shut it down through the operating system.
2. Disconnect the power from the computer by unplugging the power cord from the computer.
3. Disconnect all external devices from the computer.
4. Remove the base enclosure (see [Base enclosure on page 28](#)), and then remove the following components:
  - a. Battery (see [Battery on page 30](#)).
  - b. Optical drive (see [Optical drive \(select products only\) on page 26](#)).
  - c. Hard drive (see [Hard drive on page 31](#)).

Remove the SSD:

1. Remove the Phillips M2.0 x 2.5 screw **(1)** that secures the SSD to the system board.
2. Remove the SSD **(2)** by pulling the drive away from the slot at an angle.

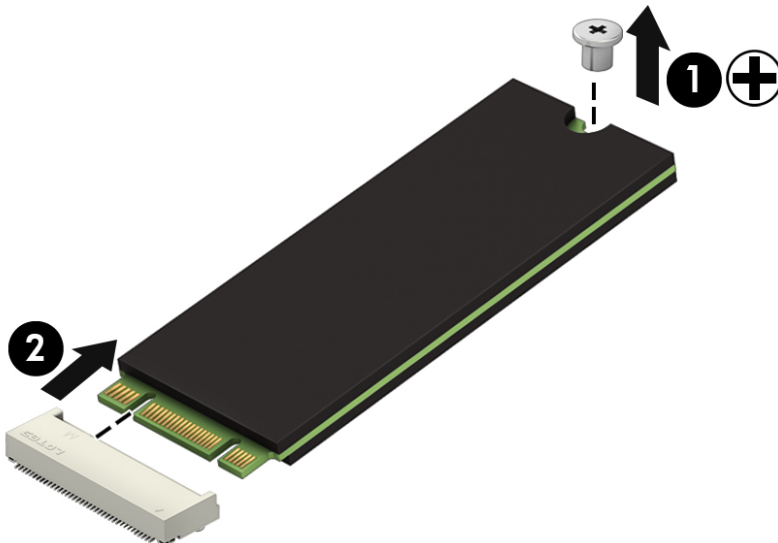

Reverse this procedure to install the SSD.

## Memory

Description	Spare part number
4 GB 2133 MHz 1.2v DDR4 shared	820569-005
8 GB 2133 MHz 1.2v DDR4 shared	820570-005
2 GB 2133 MHz 1.2v DDR4 shared	851379-005



**IMPORTANT:** Make special note of each screw and screw lock size and location during removal and replacement.

Before removing the memory, follow these steps:

1. Shut down the computer.
2. Disconnect all external devices connected to the computer.
3. Disconnect the power from the computer by first unplugging the power cord from the AC outlet and then unplugging the AC adapter from the computer.
4. Remove the base enclosure (see [Base enclosure on page 28](#)), and then remove the following components:
  - a. Battery (see [Battery on page 30](#)).
  - b. Optical drive (see [Optical drive \(select products only\) on page 26](#)).
  - c. Hard drive (see [Hard drive on page 31](#)).
  - d. Solid-state drive (see [SSD \(M.2\) on page 33](#)).

If you are replacing a memory module, remove the existing memory module:

1. Lift the clear film covering the memory module.
2. Pull away the retention clips **(1)** on each side of the memory module.  
The memory module tilts up.

3. Grasp the edge of the memory module **(2)**, and then gently pull the memory module out of the memory module slot.

---

**⚠ CAUTION:** To prevent damage to the memory module, hold the memory module by the edges only. Do not touch the components on the memory module.

---

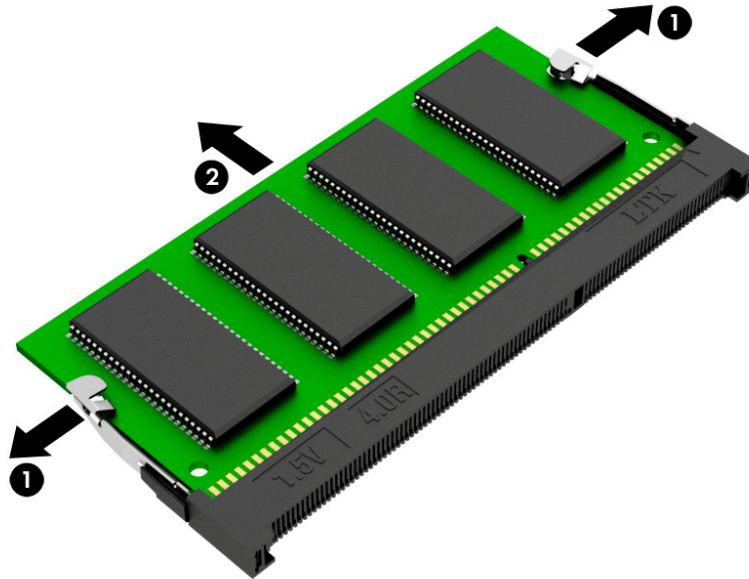

To protect a memory module after removal, place it in an electrostatic-safe container.

To install a memory module:

---

**⚠ CAUTION:** To prevent damage to the memory module, hold the memory module by the edges only. Do not touch the components on the memory module.

---

1. Align the notched edge **(1)** of the memory module with the tab in the memory module slot.

2. With the memory module at a 45-degree angle from the surface of the memory module compartment (2), press the module into the memory module slot until it is seated.

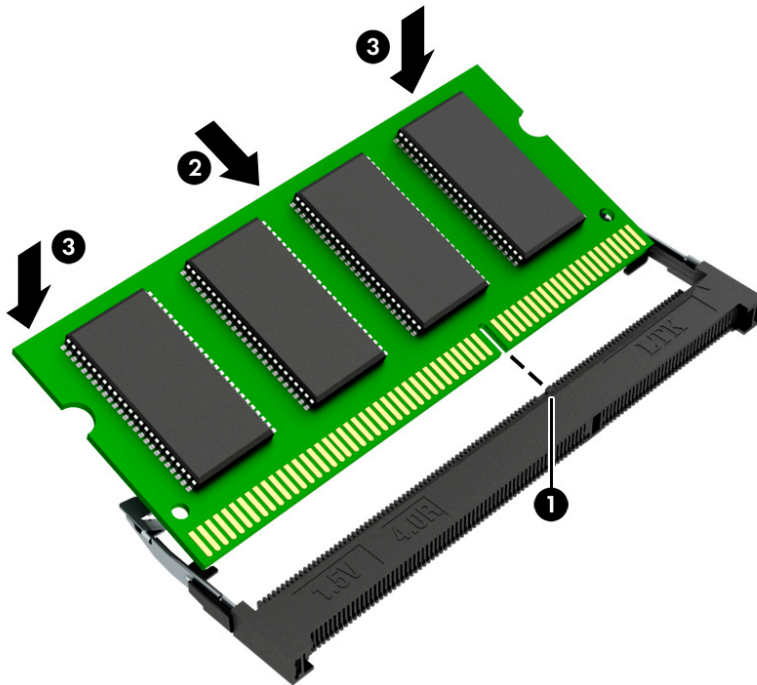

3. Gently press the memory module down (3), applying pressure to both the left and right edges of the memory module, until the retention clips snap into place.

---

**CAUTION:** To prevent damage to the memory module, be sure that you do not bend the memory module.

---

## WLAN module

Description	Spare part number
WLAN module, 11AC INT 3165 M.2 MOW	806723-005
WLAN assembly, RT 11BGN+BT4 1x1 SANJI2 CB	855106-855

 **IMPORTANT:** Make special note of each screw and screw lock size and location during removal and replacement.

Before removing the WLAN module, follow these steps:

1. Shut down the computer.
2. Disconnect all external devices connected to the computer.
3. Disconnect the power from the computer by first unplugging the power cord from the AC outlet and then unplugging the AC adapter from the computer.
4. Remove the base enclosure (see [Base enclosure on page 28](#)), and then remove the following components:
  - a. Battery (see [Battery on page 30](#)).
  - b. Optical drive (see [Optical drive \(select products only\) on page 26](#)).
  - c. Hard drive (see [Hard drive on page 31](#)).
  - d. Solid-state drive (see [SSD \(M.2\) on page 33](#)).
  - e. Memory (see [Memory on page 34](#)).

Remove the WLAN module:

1. Carefully disconnect 2 antenna cables **(1)**.

2. Remove 1 Phillips 2.0x2.5 screw **(2)**, and then remove the WLAN module **(3)**.

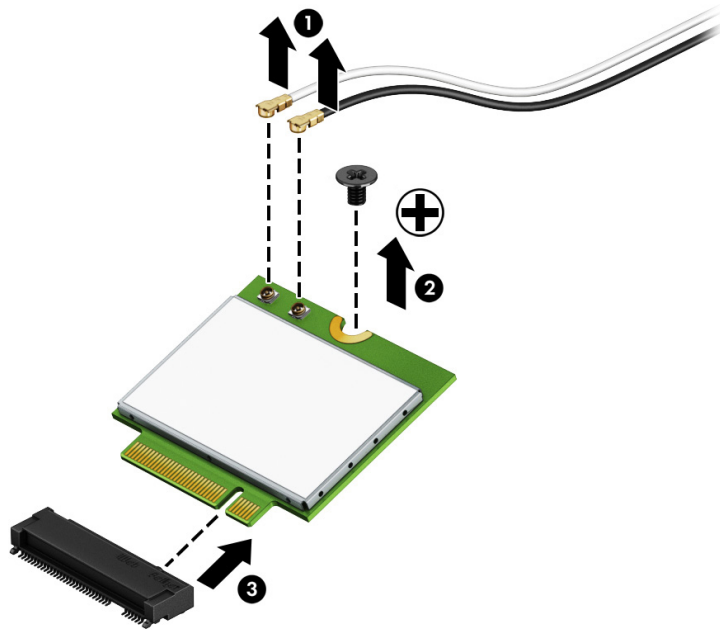

Reverse this procedure to install the WLAN module.



## Display assembly



**IMPORTANT:** Make special note of each screw and screw lock size and location during removal and replacement.

---

Before removing the display assembly, follow these steps:

1. Shut down the computer.
2. Disconnect all external devices connected to the computer.
3. Disconnect the power from the computer by first unplugging the power cord from the AC outlet and then unplugging the AC adapter from the computer.
4. Remove the base enclosure (see [Base enclosure on page 28](#)), and then remove the following components:
  - a. Battery (see [Battery on page 30](#)).
  - b. Optical drive (see [Optical drive \(select products only\) on page 26](#)).
  - c. Hard drive (see [Hard drive on page 31](#)).
  - d. Solid-state drive (see [SSD \(M.2\) on page 33](#)).
  - e. Memory (see [Memory on page 34](#)).
  - f. WLAN module (see [WLAN module on page 37](#)).
  - g. Fan (see [Fan on page 41](#)).
  - h. Heat sink (see [Heat sink on page 43](#)).
  - i. Speakers (see [Speakers on page 53](#)).
  - j. System board (see [System board on page 48](#)).
  - k. WLAN antenna (see [WLAN antenna on page 65](#)).

Remove the display assembly:

1. Disconnect the WLAN antenna cable **(1)** and the display cable **(2)**.

2. Remove 2 Phillips 2.5x6.0 screws from the left hinge and 2 Phillips screws 2.5x6.0 from the right hinge (3).

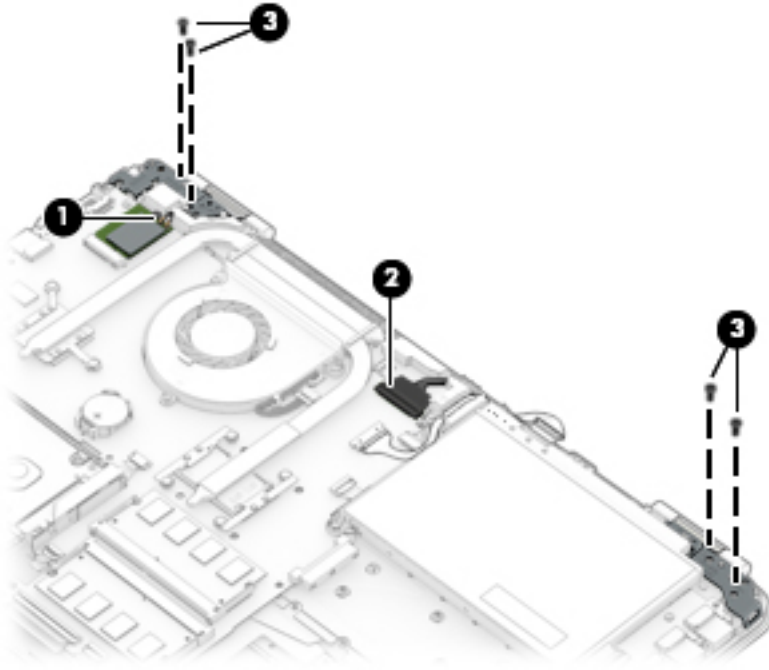

3. Rotate the display assembly (1), and then remove the display assembly from the base enclosure (2).

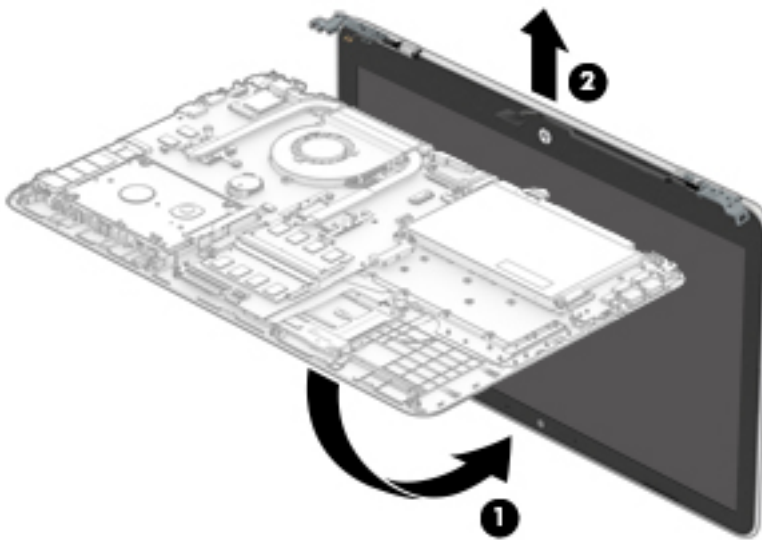

Reverse this procedure to install the display assembly.

## Fan

Description	Spare part number
Fan	856359-001

 **IMPORTANT:** Make special note of each screw and screw lock size and location during removal and replacement.

Before removing the heat sink and the fan, follow these steps:

1. Shut down the computer.
2. Disconnect all external devices connected to the computer.
3. Disconnect the power from the computer by first unplugging the power cord from the AC outlet and then unplugging the AC adapter from the computer.
4. Remove the base enclosure (see [Base enclosure on page 28](#)), and then remove the following components:
  - a. Battery (see [Battery on page 30](#)).
  - b. Optical drive (see [Optical drive \(select products only\) on page 26](#)).
  - c. Hard drive (see [Hard drive on page 31](#)).
  - d. Solid-state drive (see [SSD \(M.2\) on page 33](#)).
  - e. Memory (see [Memory on page 34](#)).
  - f. WLAN module (see [WLAN module on page 37](#)).
  - g. Display assembly (see [Display assembly on page 39](#)).

Remove the fan:

- ▲ Disconnect the fan cable (1), remove 3 Phillips 2x5 screws from the fan (2), and then lift the fan to remove it (3).

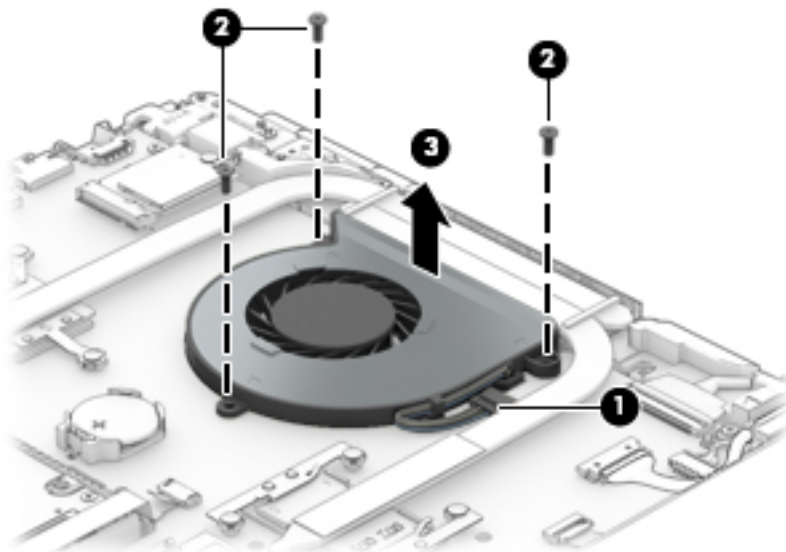

Reverse this procedure to install the fan.

## Heat sink

Description	Spare part number
Heat sink for products with UMA graphics	857480-001
Heat sink for products with discrete graphics	857481-001



**IMPORTANT:** Make special note of each screw and screw lock size and location during removal and replacement.

Before removing the heat sink, follow these steps:

1. Shut down the computer.
2. Disconnect all external devices connected to the computer.
3. Disconnect the power from the computer by first unplugging the power cord from the AC outlet and then unplugging the AC adapter from the computer.
4. Remove the base enclosure (see [Base enclosure on page 28](#)), and then remove the following components:
  - a. Battery (see [Battery on page 30](#)).
  - b. Optical drive (see [Optical drive \(select products only\) on page 26](#)).
  - c. Hard drive (see [Hard drive on page 31](#)).
  - d. Solid-state drive (see [SSD \(M.2\) on page 33](#)).
  - e. Memory (see [Memory on page 34](#)).
  - f. WLAN module (see [WLAN module on page 37](#)).
  - g. Display assembly (see [Display assembly on page 39](#)).
  - h. Fan (see [Fan on page 41](#)).

Remove the heat sink:

- ▲ Remove 7 Phillips 2.5x2.5 screws from the thermal module in numerical order **(1)**, and lift the heat sink to remove it **(2)**.

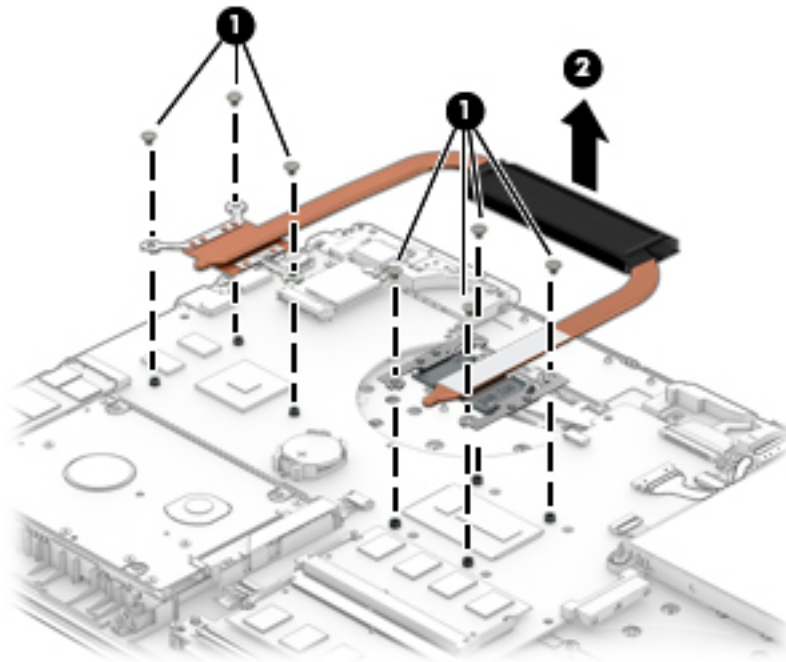

Reverse this procedure to install the heat sink.

The following illustration shows the replacement thermal material locations. The thermal material must be thoroughly cleaned from the surfaces of the heat sink and the system board components each time the heat sink is removed. Replacement thermal material is included with the heat sink and system board spare part kits.

Thermal paste is used on the system board components **(1)**, **(3)** and on the heat sink areas **(2)**, **(4)** that service them.

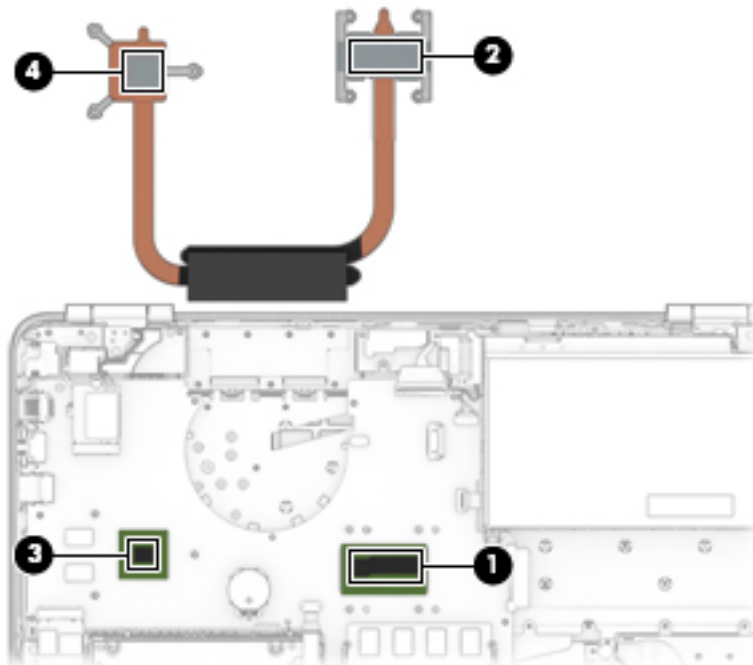

## I/O board

Description	Spare part number
I/O board	856370-001
I/O board cable	856349-001



**IMPORTANT:** Make special note of each screw and screw lock size and location during removal and replacement

Before removing the I/O board, follow these steps:

1. Shut down the computer.
2. Disconnect all external devices connected to the computer.
3. Disconnect the power from the computer by first unplugging the power cord from the AC outlet and then unplugging the AC adapter from the computer.
4. Remove the base enclosure (see [Base enclosure on page 28](#)), and then remove the following components:
  - a. Battery (see [Battery on page 30](#)).
  - b. Optical drive (see [Optical drive \(select products only\) on page 26](#)).
  - c. Hard drive (see [Hard drive on page 31](#)).
  - d. Solid-state drive (see [SSD \(M.2\) on page 33](#)).
  - e. Memory (see [Memory on page 34](#)).
  - f. WLAN module (see [WLAN module on page 37](#)).
  - g. Display assembly (see [Display assembly on page 39](#)).
  - h. Fan (see [Fan on page 41](#)).
  - i. Heat sink (see [Heat sink on page 43](#)).

Remove the I/O board:

- ▲ Disconnect the I/O board cable **(1)**, remove 1 Phillips 2.0x2.5 screw **(2)**, and then lift the I/O board to remove it **(3)**.

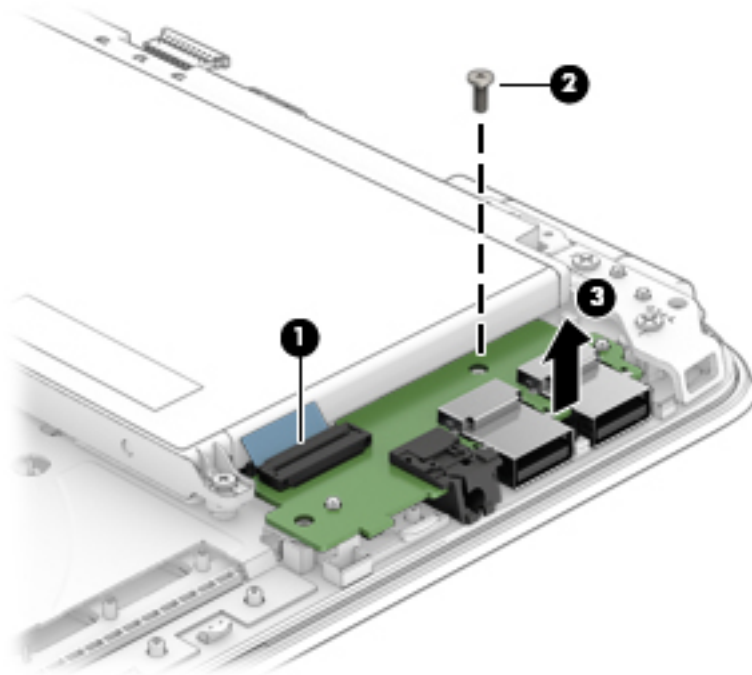

Reverse this procedure to install the I/O board.

## Power button board

Description	Spare part number
Power button board	856369-001
Power button board cable	856348-001

**IMPORTANT:** Make special note of each screw and screw lock size and location during removal and replacement

Before removing the power button board, follow these steps:

1. Shut down the computer.
2. Disconnect all external devices connected to the computer.
3. Disconnect the power from the computer by first unplugging the power cord from the AC outlet and then unplugging the AC adapter from the computer.
4. Remove the base enclosure (see [Base enclosure on page 28](#)), and then remove the following components:
  - a. Battery (see [Battery on page 30](#)).
  - b. Optical drive (see [Optical drive \(select products only\) on page 26](#)).
  - c. Hard drive (see [Hard drive on page 31](#)).
  - d. Solid-state drive (see [SSD \(M.2\) on page 33](#)).
  - e. Memory (see [Memory on page 34](#)).
  - f. WLAN module (see [WLAN module on page 37](#)).



- g. Display assembly (see [Display assembly on page 39](#)).
- h. Fan (see [Fan on page 41](#)).
- i. Heat sink (see [Heat sink on page 43](#)).
- j. Fan (see [Fan on page 41](#)).
- k. I/O board (see [I/O board on page 45](#)).

Remove the power button board:

- ▲ Disconnect the zero-insertion force (ZIF) connector **(1)**, remove the cable, which is held with tape **(2)**, remove 1 Phillips screw **(3)**, slide the power button board **(4)**, lift it at an angle **(5)**, and then remove it **(6)**.

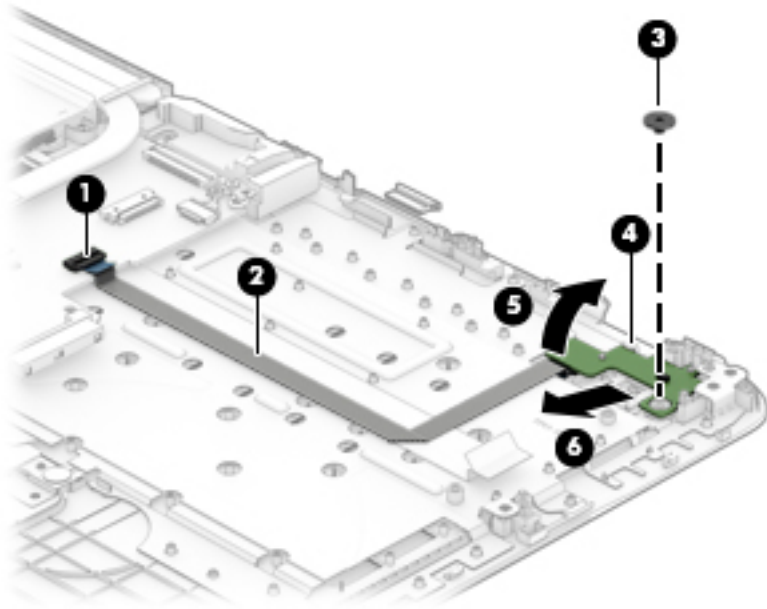

Reverse this procedure to install the power button board.

## System board

Description	Spare part number
System board	
AMD A10-9600P system board with UMA graphics and a non-Windows operating system	856269-001
AMD A10-9600P system board with UMA graphics and a Windows operating system	856269-601
AMD A9-9410P system board with UMA graphics and a non-Windows operating system	856270-001
AMD A9-9410P system board with UMA graphics and a Windows operating system	856270-601
AMD A6-9210P system board with UMA graphics and a non-Windows operating system	856271-001
AMD A6-9210P system board with UMA graphics and a Windows operating system	856271-601
AMD A10-9600P R16M M1-70 system board with 4 GB discrete graphics and a non-Windows operating system	856272-001
AMD A10-9600P R16M M1-70 system board with 4 GB discrete graphics and a Windows operating system	856272-601
AMD A10-9600P R16M M1-70 system board with 2GB discrete graphics and a non-Windows operating system	856273-001
AMD A10-9600P R16M M1-70 system board with 2 GB discrete graphics and a Windows operating system	856273-601
AMD A9-9410P R16M M1-70 system board with 2 GB discrete graphics and a non-Windows operating system	856274-001
AMD A9-9410P R16M M1-70 system board with 2 GB discrete graphics and a Windows operating system	856274-601
AMD A6-9210P R16M M1-70 system board with 2 GB discrete graphics and a non-Windows operating system	856275-001
AMD A6-9210P R16M M1-70 system board with 2 GB discrete graphics and a Windows operating system	856275-601
AMD A9-9410P R16M M1-70 system board with 4 GB discrete graphics and a non-Windows operating system	860280-001
AMD A9-9410P R16M M1-70 system board with 4GB discrete graphics and a Windows operating system	860280-601
AMD A12-9700P system board and a non-Windows operating system	862978-001
AMD A12-9700P system board and a Windows operating system	862978-601



**IMPORTANT:** Make special note of each screw and screw lock size and location during removal and replacement.

Before removing the system board, follow these steps:

1. Shut down the computer.
2. Disconnect all external devices connected to the computer.
3. Disconnect the power from the computer by first unplugging the power cord from the AC outlet and then unplugging the AC adapter from the computer.
4. Remove the base enclosure (see [Base enclosure on page 28](#)), and then remove the following components:
  - a. Battery (see [Battery on page 30](#)).
  - b. Optical drive (see [Optical drive \(select products only\) on page 26](#)).

- c. Hard drive (see [Hard drive on page 31](#)).
- d. Solid-state drive (see [SSD \(M.2\) on page 33](#)).
- e. Memory (see [Memory on page 34](#)).
- f. WLAN module (see [WLAN module on page 37](#)).
- g. Fan (see [Fan on page 41](#)).
- h. Heat sink (see [Heat sink on page 43](#)).
- i. I/O board (see [I/O board on page 45](#)).
- j. Power button board ([Power button board on page 46](#)).

Remove the system board:

1. Disconnect the following zero-insertion force (ZIF) connectors from the system board:
  - Speaker cable **(1)**
  - Display cable **(2)**
  - Battery cable **(3)**
  - Power button board connector **(4)**
  - Power button board cable **(5)**
  - I/O board cable **(6)**
  - I/O board connector **(7)**
  - TouchPad cable **(8)**
  - Keyboard cable **(9)**
  - Solid-state drive cable **(10)**
  - Hard drive cable **(11)**
  - SD card reader cable **(12)**

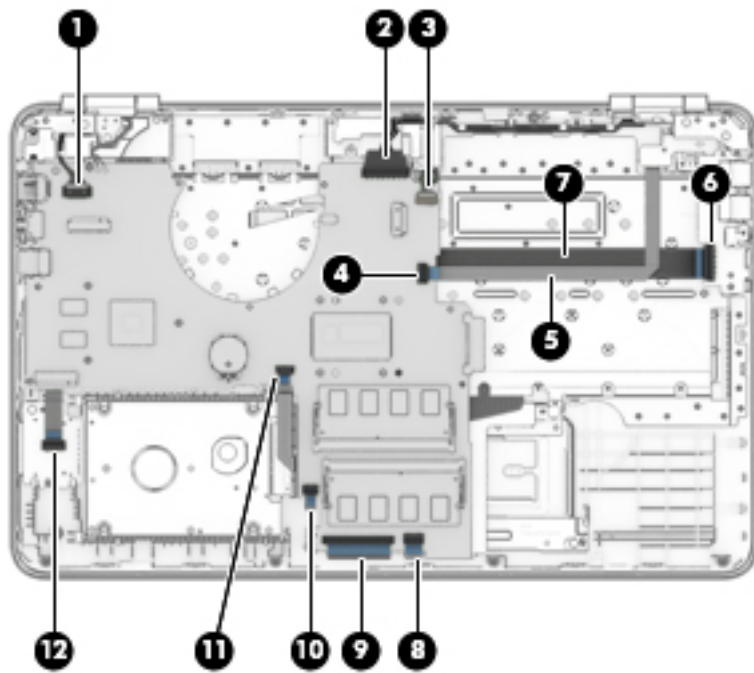

2. Remove 2 Phillips 2x5 screws (1), and then lift the system board to remove it (2).

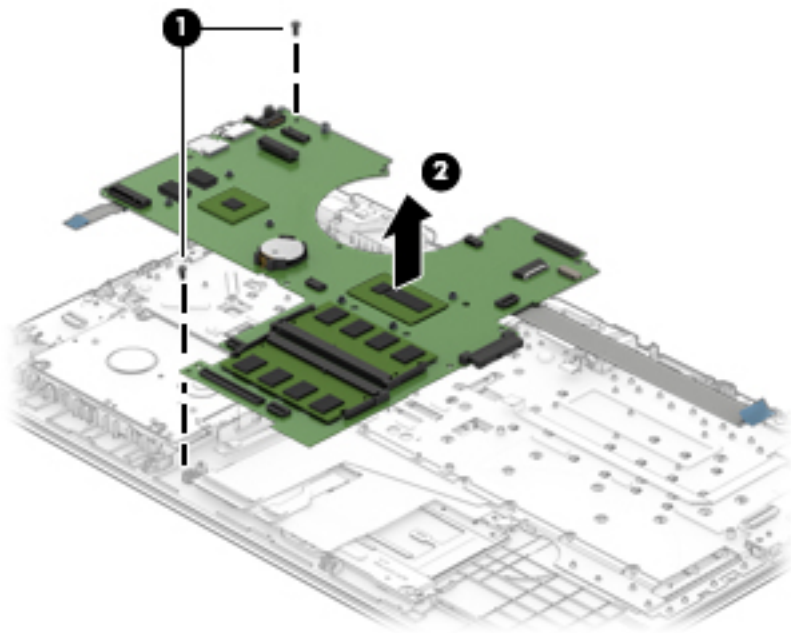

Reverse this procedure to install the system board.

## SD card reader

Description	Spare part number
SD card reader board	857791-001
SD card reader board cable	856347-001



---

**IMPORTANT:** Make special note of each screw and screw lock size and location during removal and replacement

---

Before removing the SD card reader board, follow these steps:

1. Shut down the computer.
2. Disconnect all external devices connected to the computer.
3. Disconnect the power from the computer by first unplugging the power cord from the AC outlet and then unplugging the AC adapter from the computer.
4. Remove the base enclosure (see [Base enclosure on page 28](#)), and then remove the following components:
  - a. Battery (see [Battery on page 30](#)).
  - b. Optical drive (see [Optical drive \(select products only\) on page 26](#)).
  - c. Hard drive (see [Hard drive on page 31](#)).
  - d. Solid-state drive (see [SSD \(M.2\) on page 33](#)).
  - e. Memory (see [Memory on page 34](#)).
  - f. WLAN module (see [WLAN module on page 37](#)).
  - g. Fan (see [Fan on page 41](#)).
  - h. Heat sink (see [Heat sink on page 43](#)).
  - i. I/O board (see [I/O board on page 45](#)).
  - j. Power button board (see [Power button board on page 46](#)).
  - k. System board (see [System board on page 48](#)).

Remove the SD card reader board:

- ▲ Disconnect the zero-insertion force (ZIF) connector **(1)**, remove 1 Phillips 2.0x2.5 screw **(2)**, remove the board from the clip **(3)**, lift the board **(4)**, and then remove it **(5)**.

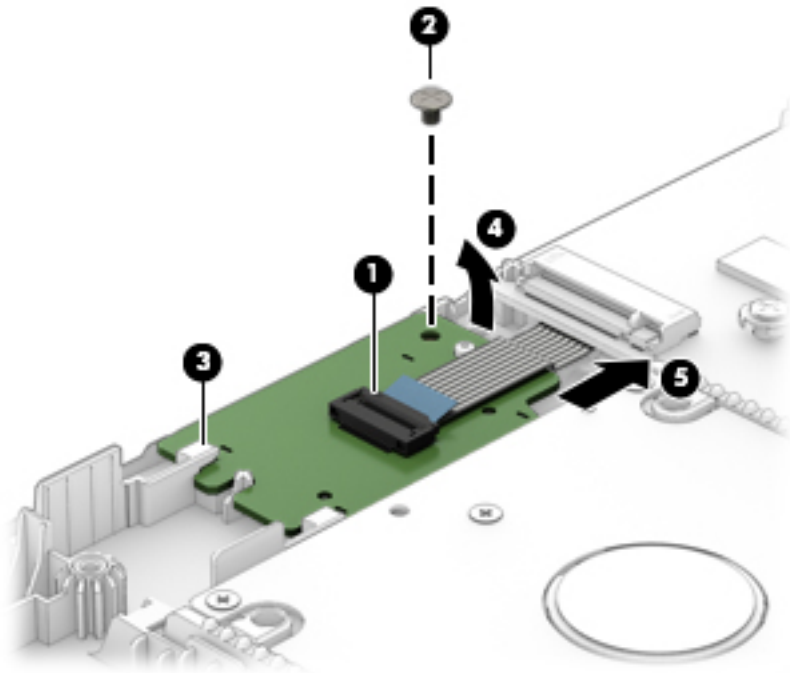

Reverse this procedure to install the SD card reader board.

## Speakers



**NOTE:** The speaker spare part kit includes the cable.

Description	Spare part number
Speaker Kit	856383-001



**IMPORTANT:** Make special note of each screw and screw lock size and location during removal and replacement.

Before removing the speaker, follow these steps:

1. Shut down the computer.
2. Disconnect all external devices connected to the computer.
3. Disconnect the power from the computer by first unplugging the power cord from the AC outlet and then unplugging the AC adapter from the computer.
4. Remove the base enclosure (see [Base enclosure on page 28](#)), and then remove the following components:
  - a. Battery (see [Battery on page 30](#)).
  - b. Optical drive (see [Optical drive \(select products only\) on page 26](#)).
  - c. Hard drive (see [Hard drive on page 31](#)).
  - d. Solid-state drive (see [SSD \(M.2\) on page 33](#)).
  - e. Memory (see [Memory on page 34](#)).
  - f. WLAN module (see [WLAN module on page 37](#)).
  - g. Fan (see [Fan on page 41](#)).
  - h. Heat sink (see [Heat sink on page 43](#)).
  - i. I/O board (see [I/O board on page 45](#)).
  - j. Power button board (see [Power button board on page 46](#)).
  - k. System board (see [System board on page 48](#)).
  - l. SD card reader board (see [SD card reader on page 50](#)).

Remove the speakers:

1. Disconnect the right speaker cable **(1)**.
2. Remove 1 Phillips 2x5 screw from the left speaker and 1 Phillips 2x5 screw from the right speaker **(2)**.
3. Disconnect the left speaker cable **(3)**.
4. Release the speaker cable from the routing channels **(4)** and **(5)**.

5. Lift the left speaker and the right speaker (6) and then remove them (7).

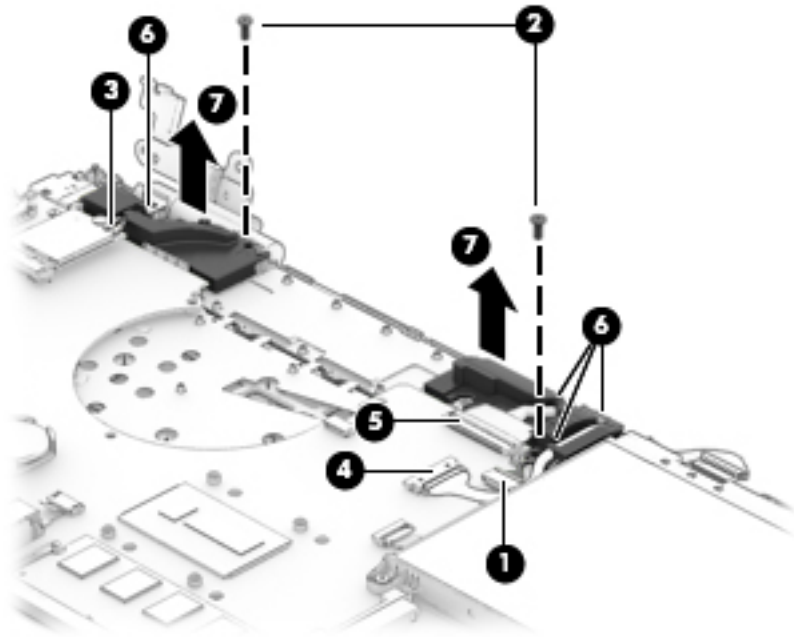

Reverse this procedure to install the speakers.

## Power connector

Description	Spare part number
Power connector, DCIN CAL50 8p 4.5mm90W 8P15 SF	808155-010

 **IMPORTANT:** Make special note of each screw and screw lock size and location during removal and replacement

Before removing the power connector, follow these steps:

1. Shut down the computer.
2. Disconnect all external devices connected to the computer.
3. Disconnect the power from the computer by first unplugging the power cord from the AC outlet and then unplugging the AC adapter from the computer.
4. Remove the base enclosure (see [Base enclosure on page 28](#)), and then remove the following components:
  - a. Battery (see [Battery on page 30](#)).
  - b. Optical drive (see [Optical drive \(select products only\) on page 26](#)).
  - c. Hard drive (see [Hard drive on page 31](#)).
  - d. Solid-state drive (see [SSD \(M.2\) on page 33](#)).
  - e. Memory (see [Memory on page 34](#)).
  - f. WLAN module (see [WLAN module on page 37](#)).



- g. Fan (see [Fan on page 41](#)).
- h. Heat sink (see [Heat sink on page 43](#)).
- i. I/O board (see [I/O board on page 45](#)).
- j. Power button board (see [Power button board on page 46](#)).
- k. System board (see [System board on page 48](#)).
- l. SD card reader board (see [SD card reader on page 50](#)).
- m. Speakers (see [Speakers on page 53](#)).

Remove the power connector:

1. Disconnect the zero-insertion force (ZIF) connector **(1)**.
2. Release the cable from the routing channels **(2)**.
3. Lift the power connector to remove it **(3)**.

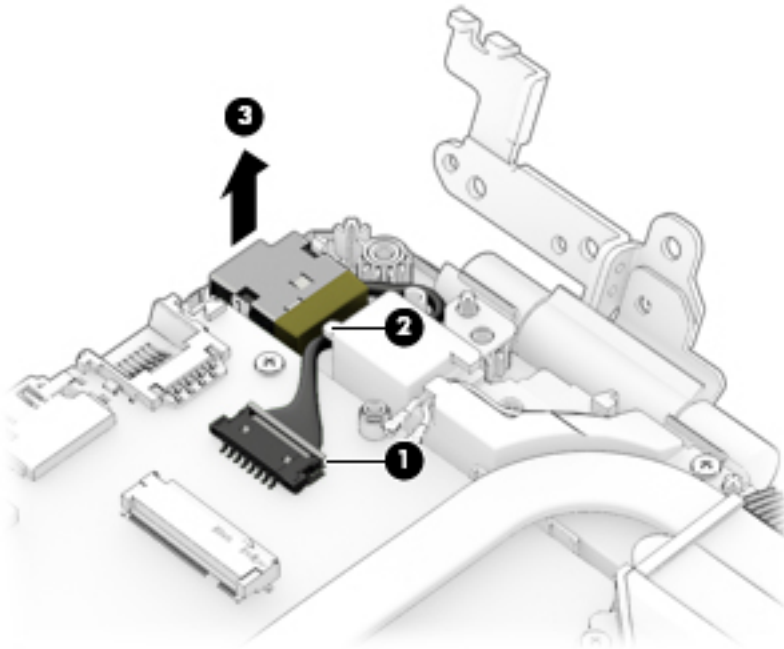

Reverse this procedure to install the power connector.

## TouchPad

Description	Spare part number
TouchPad board assembly	856905-001
TouchPad cable	856350-001
Top cover with TouchPad and Keyboard	
In Natural Silver finish	856026-001
In Modern Gold finish	856028-001
In Cardinal Red finish	856029-001

Description	Spare part number
In Sport Purple finish	856033-001
In Dragonfly Blue finish	856034-001
Top cover with TouchPad and Backlit Keyboard	
In Natural Silver finish	856035-001
In Modern Gold finish	856040-001
In Cardinal Red finish	856041-001
In Sport Purple finish	856042-001
In Dragonfly Blue finish	856043-001
In Blizzard White finish	856044-001

For use in country or region	Spare part number	For use in country or region	Spare part number	For use in country or region	Spare part number
Belgium	-A41	Italy	-061	Slovenia	-BA1
Bulgaria	-261	Japan	-291	South Korea	-AD1
Canada	-DB1	Latin America	-161	Spain	-071
Czech Republic and Slovakia	-FL1	The Netherlands	-B31	Sweden and Finland	-B71
Denmark, Norway, Finland, and Sweden	-DH1	Northern Africa	-FP1	Switzerland	-BG1
France	-051	Norway	-091	Taiwan	-AB1
Germany	-041	Portugal	-131	Thailand	-281
Greece	-151	Romania	-271	Turkey	-141
Hungary	-211	Russia	-251	United Kingdom	-031
India	-D61	Saudi Arabia	-171	United States	-001
Israel	-BB1				



**IMPORTANT:** Make special note of each screw and screw lock size and location during removal and replacement

Before removing the TouchPad, follow these steps:

1. Shut down the computer.
2. Disconnect all external devices connected to the computer.
3. Disconnect the power from the computer by first unplugging the power cord from the AC outlet and then unplugging the AC adapter from the computer.
4. Remove the base enclosure (see [Base enclosure on page 28](#)), and then remove the following components:

- a. Battery (see [Battery on page 30](#)).
- b. Optical drive (see [Optical drive \(select products only\) on page 26](#)).
- c. Hard drive (see [Hard drive on page 31](#)).
- d. Solid-state drive (see [SSD \(M.2\) on page 33](#)).
- e. Memory (see [Memory on page 34](#)).
- f. WLAN module (see [WLAN module on page 37](#)).
- g. Fan (see [Fan on page 41](#)).
- h. Heat sink (see [Heat sink on page 43](#)).
- i. I/O board (see [I/O board on page 45](#)).
- j. Power button board (see [Power button board on page 46](#)).
- k. System board (see [System board on page 48](#)).
- l. SD card reader board (see [SD card reader on page 50](#)).
- m. Speakers (see [Speakers on page 53](#)).

Remove the TouchPad:

1. Remove the film covering the TouchPad **(1)**.
2. Remove 3 Phillips 2.0x2.0 screws **(2)**, and then lift to remove the TouchPad bracket **(3)**.

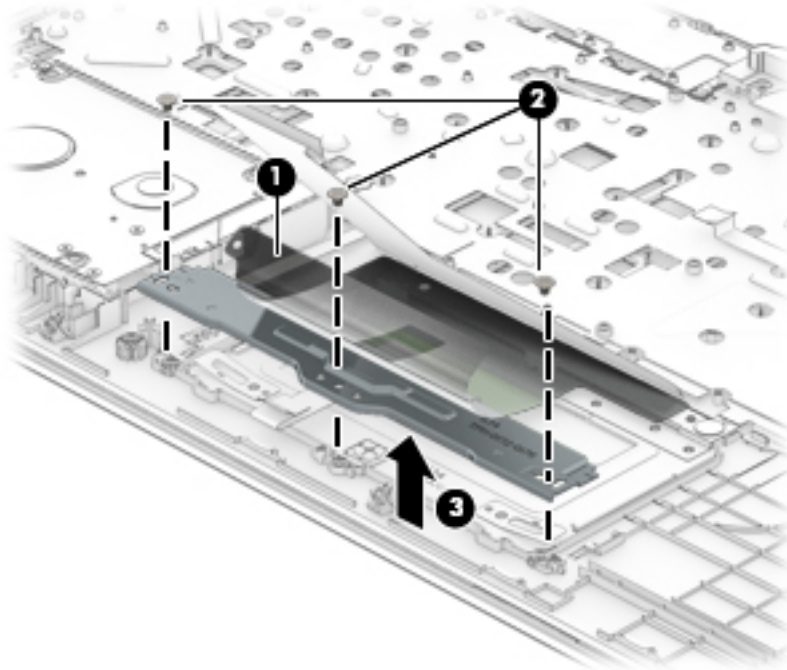

3. Disconnect the TouchPad cable, and then remove the metal shield covering the TouchPad **(1)**.

4. Remove 3 Phillips 2.0x2.5 screws **(2)**, and then lift the TouchPad to remove it **(3)**.

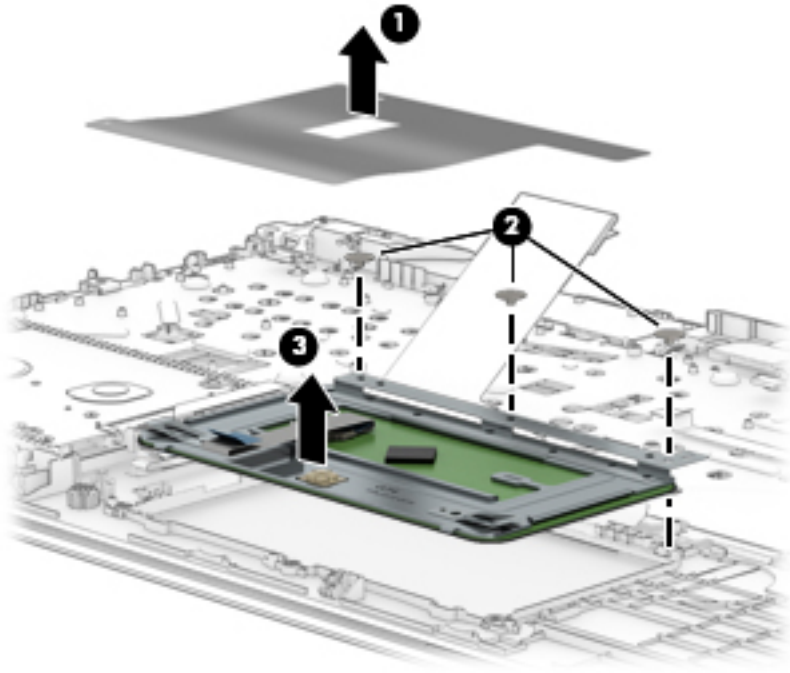

Reverse this procedure to install the TouchPad.

## Display panel

Description	Spare part number
<b>Bezel</b>	856346-001
<b>Webcam</b>	846006-003
<b>Display panel</b>	
15.6 FHD AG SVA 220eDP Slim PF	798933-006
15.6 HD BV WLED SVAeDPSlimTOP PF	809612-008
15.6 FHD BV UWVA 220 eDP SlimPF	842463-004
15.6HD BV WLED SVA220 eDPSlim PF	847654-001
15.6 FHD BVUWVA220 eDPSlim TOPPF	848085-001
<b>Hinge assembly</b>	856367-001
<b>Display cable</b>	
High-definition display cable for products not equipped with a touch screen	856354-001
High-definition display cable for products equipped with a touch screen	856357-001
Full high-definition/high-definition display cable for products equipped with a touch screen	856358-001
<b>WLAN</b>	
WLAN module	806723-005
WLAN assembly	855106-855
<b>Back cover</b>	
In Natural Silver finish, with dual antenna	856325-001
In Onyx Black finish, with dual antenna	856326-001
In Modern Gold finish, with dual antenna	856327-001
In Cardinal Red finish, with dual antenna	856328-001
In Sport Purple finish, with dual antenna	856329-001
In Dragonfly Blue finish, with dual antenna	856330-001
In Blizzard White finish, with dual antenna	856331-001
In Natural Silver finish, with single antenna	859652-001
In Onyx Black finish, with single antenna	859653-001
In Modern Gold finish, with single antenna	859654-001
In Cardinal Red finish, with single antenna	859655-001
In Sport Purple finish, with single antenna	859656-001
In Dragonfly Blue finish, with single antenna	859657-001
In Blizzard White finish, with single antenna	859658-001



---

**IMPORTANT:** Make special note of each screw and screw lock size and location during removal and replacement.

---

Before removing the display assembly, follow these steps:

1. Shut down the computer.
2. Disconnect all external devices connected to the computer.
3. Disconnect the power from the computer by first unplugging the power cord from the AC outlet and then unplugging the AC adapter from the computer.
4. Remove the base enclosure (see [Base enclosure on page 28](#)), and then remove the following components:
  - a. Battery (see [Battery on page 30](#)).
  - b. Optical drive (see [Optical drive \(select products only\) on page 26](#)).
  - c. Hard drive (see [Hard drive on page 31](#)).
  - d. Solid-state drive (see [SSD \(M.2\) on page 33](#)).
  - e. Memory (see [Memory on page 34](#)).
  - f. WLAN module (see [WLAN module on page 37](#)).
  - g. Fan (see [Fan on page 41](#)).
  - h. Heat sink (see [Heat sink on page 43](#)).
  - i. I/O board (see [I/O board on page 45](#)).
  - j. Power button board (see [Power button board on page 46](#)).
  - k. System board (see [System board on page 48](#)).
  - l. SD card reader board (see [SD card reader on page 50](#)).
  - m. Speakers (see [Speakers on page 53](#)).
  - n. TouchPad (see [TouchPad on page 55](#)).

Remove the display panel:

1. Slide a nylon flake tool **(1)** around the outer edge of the bezel to release the bezel from the screen **(2)**.

2. Starting on the top edge **(1)**, loosen the display bezel, disconnecting the plastic clips to release the edge of the bezel. Continue on the left and right edges **(2)** and then bottom edge **(3)**, and then lift the display bezel **(4)** to remove it.

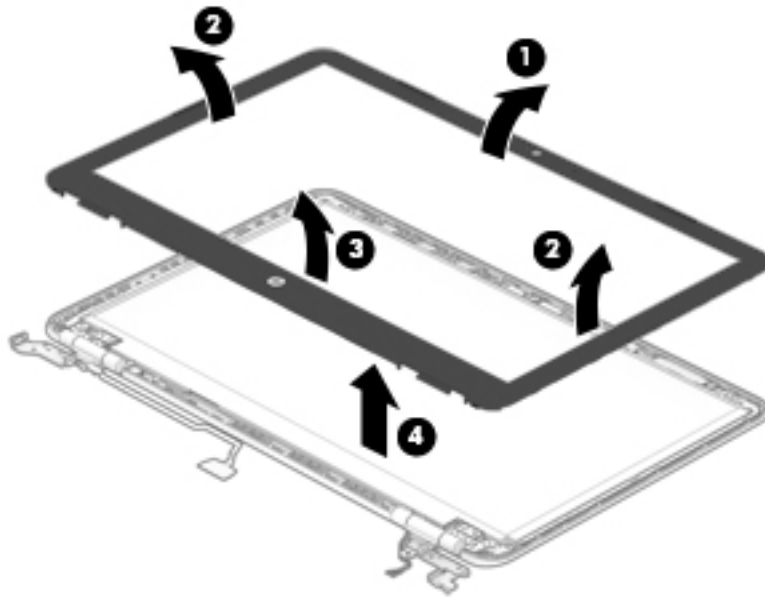

3. Remove 1 Phillips 2.5x6.0 screw from the top of each hinge bracket **(1)** and 3 Phillips 2.5x6.0 screws from each hinge **(2)**, remove the hinge brackets from the back cover **(3)**, and then lift the hinge brackets **(4)** to remove them.

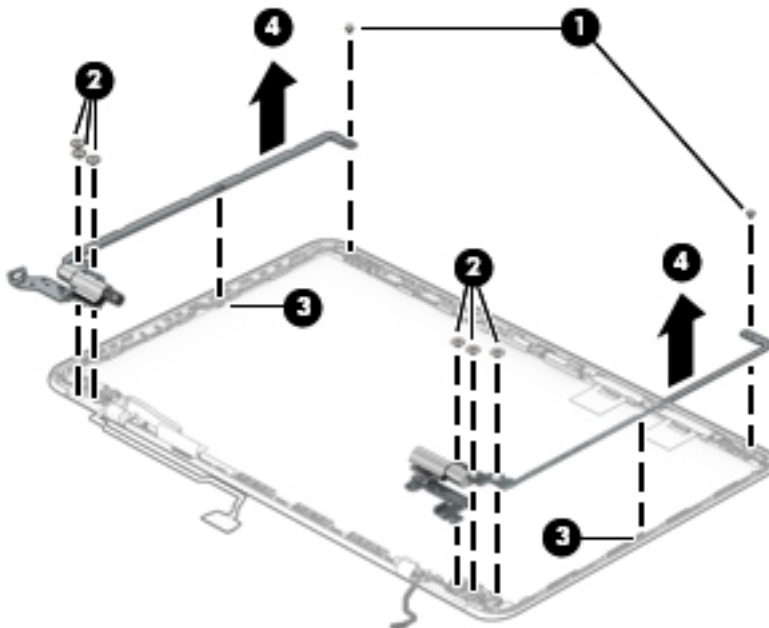

4. Remove 1 Phillips 2.0x2.0 screw from each hinge cover **(1)** separate the hinge covers **(2)** from the back cover **(3)**, and then lift the hinge covers **(4)** to remove them.

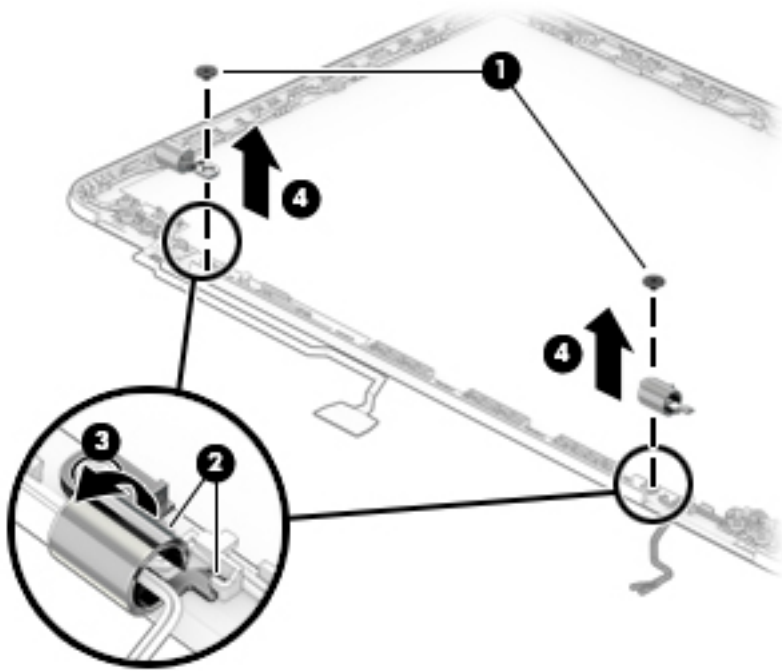

5. Remove 4 Phillips 2.0x2.5 screws from the display panel **(1)**, and then lift the display panel **(2)** to remove it.

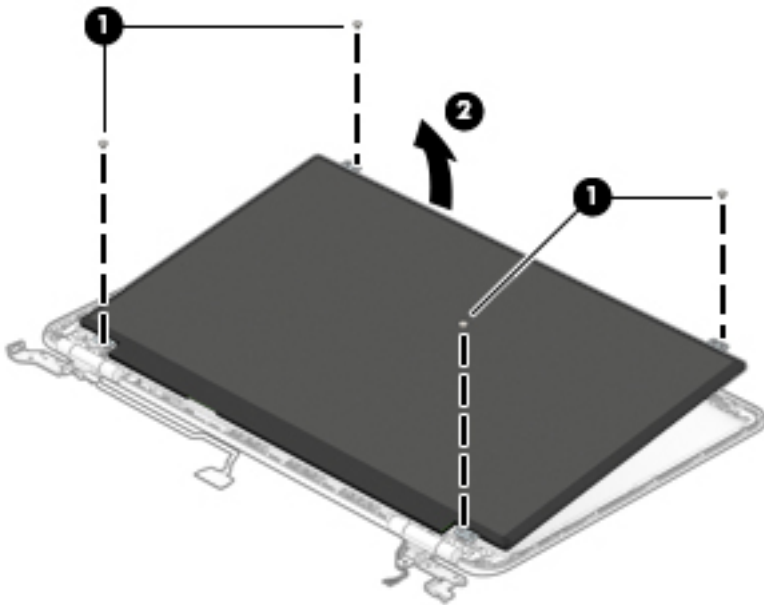

Reverse this procedure to install the display assembly.



## Webcam

Description	Spare part number
Webcam	846006-003



**IMPORTANT:** Make special note of each screw and screw lock size and location during removal and replacement.

Before removing the webcam, follow these steps:

1. Shut down the computer.
2. Disconnect all external devices connected to the computer.
3. Disconnect the power from the computer by first unplugging the power cord from the AC outlet and then unplugging the AC adapter from the computer.
4. Remove the base enclosure (see [Base enclosure on page 28](#)), and then remove the following components:
  - a. Battery (see [Battery on page 30](#)).
  - b. Optical drive (see [Optical drive \(select products only\) on page 26](#)).
  - c. Hard drive (see [Hard drive on page 31](#)).
  - d. Solid-state drive (see [SSD \(M.2\) on page 33](#)).
  - e. Memory (see [Memory on page 34](#)).
  - f. WLAN module (see [WLAN module on page 37](#)).
  - g. Fan (see [Fan on page 41](#)).
  - h. Heat sink (see [Heat sink on page 43](#)).
  - i. I/O board (see [I/O board on page 45](#)).
  - j. Power button board (see [Power button board on page 46](#)).
  - k. System board (see [System board on page 48](#)).
  - l. SD card reader board (see [SD card reader on page 50](#)).
  - m. Speakers (see [Speakers on page 53](#)).
  - n. TouchPad (see [TouchPad on page 55](#)).
  - o. Display panel (see [Display panel on page 59](#)).

Remove the webcam:

- ▲ Disconnect the webcam cable **(1)**, and then lift the webcam board to remove it **(2)**.

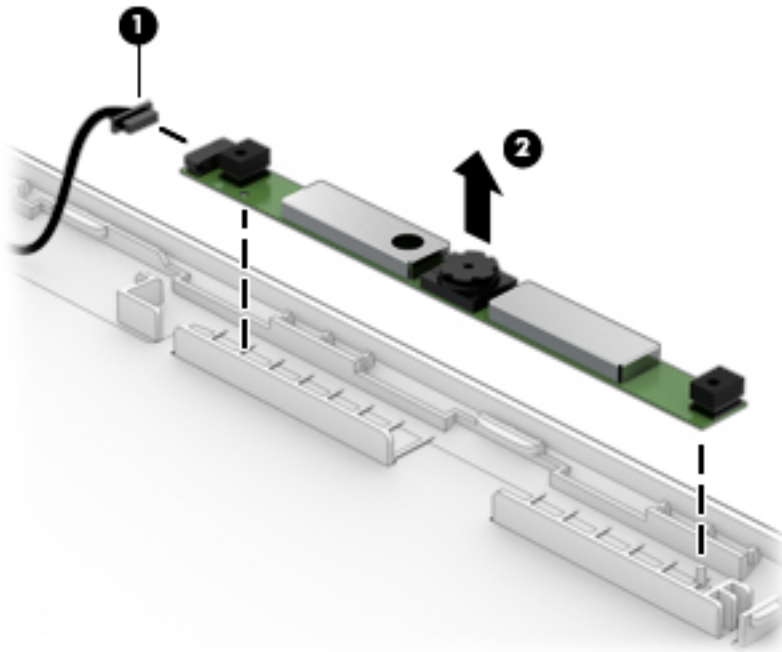

Reverse this procedure to install the webcam.

## WLAN antenna

Description	Spare part number
Antenna, dual	856324-001
Antenna, single	859651-001

 **IMPORTANT:** Make special note of each screw and screw lock size and location during removal and replacement.

Before removing the WLAN antenna cable, follow these steps:

1. Shut down the computer.
2. Disconnect all external devices connected to the computer.
3. Disconnect the power from the computer by first unplugging the power cord from the AC outlet and then unplugging the AC adapter from the computer.
4. Remove the base enclosure (see [Base enclosure on page 28](#)), and then remove the following components:
  - a. Battery (see [Battery on page 30](#)).
  - b. Optical drive (see [Optical drive \(select products only\) on page 26](#)).
  - c. Hard drive (see [Hard drive on page 31](#)).
  - d. Solid-state drive (see [SSD \(M.2\) on page 33](#)).
  - e. Memory (see [Memory on page 34](#)).
  - f. WLAN module (see [WLAN module on page 37](#)).
  - g. Fan (see [Fan on page 41](#)).
  - h. Heat sink (see [Heat sink on page 43](#)).
  - i. I/O board (see [I/O board on page 45](#)).
  - j. Power button board (see [Power button board on page 46](#)).
  - k. System board (see [System board on page 48](#)).
  - l. SD card reader board (see [SD card reader on page 50](#)).
  - m. Speakers (see [Speakers on page 53](#)).
  - n. TouchPad (see [TouchPad on page 55](#)).
  - o. Display panel (see [Display panel on page 59](#)).

Remove the WLAN antenna cable:

- ▲ Remove the WLAN antennas from the back cover **(1)**, release the WLAN antenna cable from the routing channels **(2)**, and then lift the antennas and cable to remove them**(3)**.

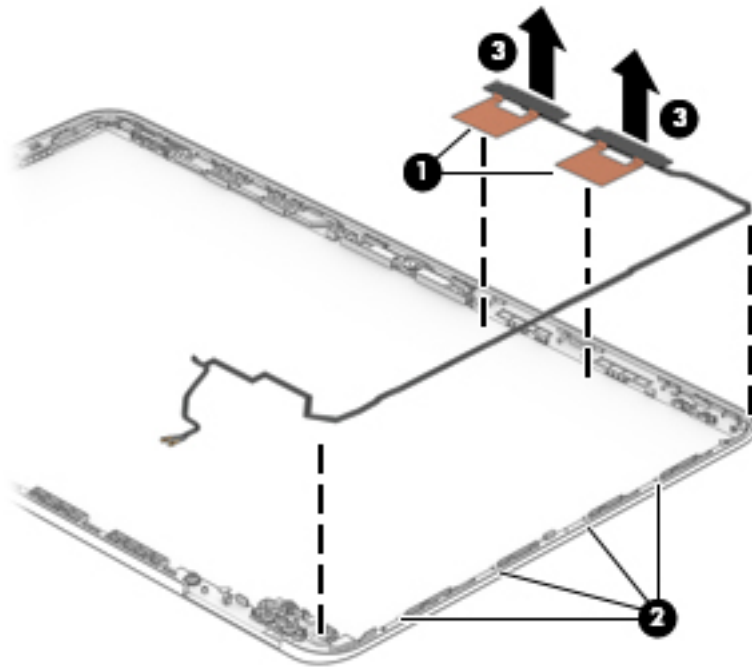

Reverse this procedure to install the WLAN antenna cable.

# 7 Using HP PC Hardware Diagnostics (UEFI)

HP PC Hardware Diagnostics is a Unified Extensible Firmware Interface (UEFI) that allows you to run diagnostic tests to determine whether the computer hardware is functioning properly. The tool runs outside the operating system so that it can isolate hardware failures from issues that are caused by the operating system or other software components.

When HP PC Hardware Diagnostics (UEFI) detects a failure that requires hardware replacement, a 24-digit Failure ID code is generated. This ID code can then be provided to support to help determine how to correct the problem.

---

 **NOTE:** To start diagnostics on a convertible computer, your computer must be in notebook mode and you must use the keyboard attached.

---

To start HP PC Hardware Diagnostics (UEFI), follow these steps:

1. Turn on or restart the computer, and quickly press [esc](#).
2. Press [f2](#).

The BIOS searches three places for the diagnostic tools, in the following order:

- a. Connected USB drive

---

 **NOTE:** To download the HP PC Hardware Diagnostics (UEFI) tool to a USB drive, see [Downloading HP PC Hardware Diagnostics \(UEFI\) to a USB device on page 67](#).

---

- b. Hard drive

- c. BIOS

3. When the diagnostic tool opens, select the type of diagnostic test you want to run, and then follow the on-screen instructions.

---

 **NOTE:** If you need to stop a diagnostic test, press [esc](#).

---

## Downloading HP PC Hardware Diagnostics (UEFI) to a USB device

---

 **NOTE:** The HP PC Hardware Diagnostics (UEFI) download instructions are provided in English only, and you must use a Windows computer to download and create the HP UEFI support environment because only .exe files are offered.

---

There are two options to download HP PC Hardware Diagnostics to a USB device.

### Download the latest UEFI version

1. Go to <http://www.hp.com/go/techcenter/pcdiags>. The HP PC Diagnostics home page is displayed.
2. In the HP PC Hardware Diagnostics section, select the **Download** link, and then select **Run**.

### Download any version of UEFI for a specific product

1. Go to <http://www.hp.com/support>.
2. Select **Get software and drivers**.

3. Enter the product name or number.

– or –

Select **Identify now** to let HP automatically detect your product.

4. Select your computer, and then select your operating system.
5. In the **Diagnostic** section, follow the on-screen instructions to select and download the UEFI version you want.

# 8 Backing up, restoring, and recovering

This chapter provides information about the following processes. The information in the chapter is standard procedure for most products.

- Creating recovery media and backups
- Restoring and recovering your system

For additional information, refer to the HP support assistant app.

▲ Type `support` in the taskbar search box, and then select the **HP Support Assistant** app.

– or –

Click the question mark icon in the taskbar.

 **IMPORTANT:** If you will be performing recovery procedures on a tablet, the tablet battery must be at least 70% charged before you start the recovery process.

**IMPORTANT:** For a tablet with a detachable keyboard, connect the keyboard to the keyboard dock before beginning any recovery process.

## Creating recovery media and backups

The following methods of creating recovery media and backups are available on select products only. Choose the available method according to your computer model.

- Use HP Recovery Manager to create HP Recovery media after you successfully set up the computer. This step creates a backup of the HP Recovery partition on the computer. The backup can be used to reinstall the original operating system in cases where the hard drive is corrupted or has been replaced. For information on creating recovery media, see [Creating HP Recovery media \(select products only\) on page 69](#). For information on the recovery options that are available using the recovery media, see [Using Windows tools on page 70](#).
- Use Windows tools to create system restore points and create backups of personal information.

For more information, see [Recovering using HP Recovery Manager on page 71](#).

 **NOTE:** If storage is 32 GB or less, Microsoft System Restore is disabled by default.

## Creating HP Recovery media (select products only)

If possible, check for the presence of the Recovery partition and the Windows partition. From the **Start** menu, select **File Explorer**, and then select **This PC**.

- If your computer does not list the Windows partition and the Recovery partition, you can obtain recovery media for your system from support. See the *Worldwide Telephone Numbers* booklet included with the computer. You can also find contact information on the HP website. Go to <http://www.hp.com/support>, select your country or region, and follow the on-screen instructions.

You can use Windows tools to create system restore points and create backups of personal information, see [Using Windows tools on page 70](#).

- If your computer does list the Recovery partition and the Windows partition, you can use HP Recovery Manager to create recovery media after you successfully set up the computer. HP Recovery media can be used to perform system recovery if the hard drive becomes corrupted. System recovery reinstalls the original operating system and software programs that were installed at the factory and then configures the settings for the programs. HP Recovery media can also be used to customize the system or restore the factory image if you replace the hard drive.
  - Only one set of recovery media can be created. Handle these recovery tools carefully, and keep them in a safe place.
  - HP Recovery Manager examines the computer and determines the required storage capacity for the media that will be required.
  - To create recovery discs, your computer must have an optical drive with DVD writer capability, and you must use only high-quality blank DVD-R, DVD+R, DVD-R DL, or DVD+R DL discs. Do not use rewritable discs such as CD±RW, DVD±RW, double-layer DVD±RW, or BD-RE (rewritable Blu-ray) discs; they are not compatible with HP Recovery Manager software. Or, instead, you can use a high-quality blank USB flash drive.
  - If your computer does not include an integrated optical drive with DVD writer capability, but you would like to create DVD recovery media, you can use an external optical drive (purchased separately) to create recovery discs. If you use an external optical drive, it must be connected directly to a USB port on the computer; the drive cannot be connected to a USB port on an external device, such as a USB hub. If you cannot create DVD media yourself, you can obtain recovery discs for your computer from HP. See the *Worldwide Telephone Numbers* booklet included with the computer. You can also find contact information on the HP website. Go to <http://www.hp.com/support>, select your country or region, and follow the on-screen instructions.
  - Be sure that the computer is connected to AC power before you begin creating the recovery media.
  - The creation process can take an hour or more. Do not interrupt the creation process.
  - If necessary, you can exit the program before you have finished creating all of the recovery DVDs. HP Recovery Manager will finish burning the current DVD. The next time you start HP Recovery Manager, you will be prompted to continue.

To create HP Recovery media:



---

**IMPORTANT:** For a tablet with a detachable keyboard, connect the keyboard to the keyboard dock before beginning these steps.

---

1. Type `recovery` in the taskbar search box, and then select **HP Recovery Manager**.
2. Select **Create recovery media**, and then follow the on-screen instructions.

If you ever need to recover the system, see [Recovering using HP Recovery Manager on page 71](#).

## Using Windows tools

You can create recovery media, system restore points, and backups of personal information using Windows tools.



---

**NOTE:** If storage is 32 GB or less, Microsoft System Restore is disabled by default.

---

For more information and steps, see the Get started app.

- ▲ Select the **Start** button, and then select the **Get started** app.



# Restore and recovery

There are several options for recovering your system. Choose the method that best matches your situation and level of expertise:

 **IMPORTANT:** Not all methods are available on all products.

- Windows offers several options for restoring from backup, refreshing the computer, and resetting the computer to its original state. For more information see the Get started app.
  - ▲ Select the **Start** button, and then select the **Get started** app.
- If you need to correct a problem with a preinstalled application or driver, use the Reinstall drivers and/or applications option (select products only) of HP Recovery Manager to reinstall the individual application or driver.
  - ▲ Type `recovery` in the taskbar search box, select **HP Recovery Manager**, select **Reinstall drivers and/or applications**, and then follow the on-screen instructions.
- If you want to recover the Windows partition to original factory content, you can choose the System Recovery option from the HP Recovery partition (select products only) or use the HP Recovery media. For more information, see [Recovering using HP Recovery Manager on page 71](#). If you have not already created recovery media, see [Creating HP Recovery media \(select products only\) on page 69](#).
- On select products, if you want to recover the computer's original factory partition and content, or if you have replaced the hard drive, you can use the Factory Reset option of HP Recovery media. For more information, see [Recovering using HP Recovery Manager on page 71](#).
- On select products, if you want to remove the recovery partition to reclaim hard drive space, HP Recovery Manager offers the Remove Recovery Partition option.

For more information, see [Removing the HP Recovery partition \(select products only\) on page 74](#).

## Recovering using HP Recovery Manager

HP Recovery Manager software allows you to recover the computer to its original factory state by using the HP Recovery media that you either created or that you obtained from HP, or by using the HP Recovery partition (select products only). If you have not already created recovery media, see [Creating HP Recovery media \(select products only\) on page 69](#).

### What you need to know before you get started

- HP Recovery Manager recovers only software that was installed at the factory. For software not provided with this computer, you must either download the software from the manufacturer's website or reinstall the software from the media provided by the manufacturer.

 **IMPORTANT:** Recovery through HP Recovery Manager should be used as a final attempt to correct computer issues.

- HP Recovery media must be used if the computer hard drive fails. If you have not already created recovery media, see [Creating HP Recovery media \(select products only\) on page 69](#).
- To use the Factory Reset option (select products only), you must use HP Recovery media. If you have not already created recovery media, see [Creating HP Recovery media \(select products only\) on page 69](#).
- If your computer does not allow the creation of HP Recovery media or if the HP Recovery media does not work, you can obtain recovery media for your system from support. See the *Worldwide Telephone Numbers* booklet included with the computer. You can also find contact information from the HP

website. Go to <http://www.hp.com/support>, select your country or region, and follow the on-screen instructions.

---

 **IMPORTANT:** HP Recovery Manager does not automatically provide backups of your personal data. Before beginning recovery, back up any personal data you want to retain.

---

Using HP Recovery media, you can choose from one of the following recovery options:

---

 **NOTE:** Only the options available for your computer display when you start the recovery process.

---

- System Recovery—Reinstalls the original operating system, and then configures the settings for the programs that were installed at the factory.
- Factory Reset—Restores the computer to its original factory state by deleting all information from the hard drive and re-creating the partitions. Then it reinstalls the operating system and the software that was installed at the factory.

The HP Recovery partition (select products only) allows System Recovery only.

## Using the HP Recovery partition (select products only)

The HP Recovery partition allows you to perform a system recovery without the need for recovery discs or a recovery USB flash drive. This type of recovery can be used only if the hard drive is still working.

To start HP Recovery Manager from the HP Recovery partition:

---

 **IMPORTANT:** For a tablet with a detachable keyboard, connect the keyboard to the keyboard dock before beginning these steps (select products only).

---

1. Type `recovery` in the taskbar search box, select **Recovery Manager**, and then select **HP Recovery Environment**.

- or -

For computers or tablets with keyboards attached, press **f11** while the computer boots, or press and hold **f11** as you press the power button.

For tablets without keyboards:

Turn on or restart the tablet, and then quickly hold down the volume down button; then select **f11**.

- or -

Turn on or restart the tablet, and then quickly hold down the Windows button; then select **f11**.

2. Select **Troubleshoot** from the boot options menu.
3. Select **Recovery Manager**, and then follow the on-screen instructions.

## Using HP Recovery media to recover

You can use HP Recovery media to recover the original system. This method can be used if your system does not have an HP Recovery partition or if the hard drive is not working properly.

1. If possible, back up all personal files.
2. Insert the HP Recovery media, and then restart the computer.

---

 **NOTE:** If the computer does not automatically restart in HP Recovery Manager, change the computer boot order. See [Changing the computer boot order on page 73](#).

---

3. Follow the on-screen instructions.

## Changing the computer boot order

If your computer does not restart in HP Recovery Manager, you can change the computer boot order, which is the order of devices listed in BIOS where the computer looks for startup information. You can change the selection to an optical drive or a USB flash drive.

To change the boot order:



---

**IMPORTANT:** For a tablet with a detachable keyboard, connect the keyboard to the keyboard dock before beginning these steps.

---

1. Insert the HP Recovery media.
2. Access BIOS:

For computers or tablets with keyboards attached:

- ▲ Turn on or restart the computer or tablet, quickly press **esc**, and then press **f9** for boot options.

For tablets without keyboards:

- ▲ Turn on or restart the tablet, and then quickly hold down the volume down button; then select **f9**.

- or -

Turn on or restart the tablet, and then quickly hold down the Windows button; then select **f9**.

3. Select the optical drive or USB flash drive from which you want to boot.
4. Follow the on-screen instructions.

## Removing the HP Recovery partition (select products only)

HP Recovery Manager software allows you to remove the HP Recovery partition to free up hard drive space.



**IMPORTANT:** After you remove the HP Recovery partition, you will not be able to perform System Recovery or create HP recovery media from the HP Recovery partition. So before you remove the Recovery partition, create HP Recovery media; see [Creating HP Recovery media \(select products only\) on page 69](#).



**NOTE:** The Remove Recovery Partition option is only available on products that support this function.

Follow these steps to remove the HP Recovery partition:

1. Type `recovery` in the taskbar search box, and then select **HP Recovery Manager**.
2. Select **Remove Recovery Partition**, and then follow the on-screen instructions.

# 9 Specifications

## Computer specifications

	Metric	U.S.
<b>Dimensions</b>		
Width	<b>382.6 mm</b>	15.06 in
Depth	<b>242.7 mm</b>	9.55 in
Height (front to back)	<b>22.5 mm</b>	.89 in
<b>Weight</b>	<b>&lt; 2100 g or &lt; 2175</b> (depending on configuration)	< 4.63 or < 4.80 lb. (depending on configuration)
<b>Input power</b>		
Operating voltage and current	19.5 V dc @ 2.31 A – 45 W 19.5 V dc @ 3.33 A – 65 W	
<b>Temperature</b>		
Operating	<b>5°C to 35°C</b>	41°F to 95°F
Nonoperating	<b>-20°C to 60°C</b>	-4°F to 140°F
<b>Relative humidity</b> (noncondensing)		
Operating	10% to 90%	
Nonoperating	5% to 95%	
<b>Maximum altitude</b> (unpressurized)		
Operating	<b>-15 m to 3,048 m</b>	-50 ft to 10,000 ft
Nonoperating	<b>-15 m to 12,192 m</b>	-50 ft to 40,000 ft
<b>NOTE:</b> Applicable product safety standards specify thermal limits for plastic surfaces. The device operates well within this range of temperatures.		

## 39.62 cm (15.6-in) display specifications

	Metric	U.S.
<b>Dimensions</b>		
Height	20.77 cm	8.175 in
Width	37.78 cm	14.875 in
Diagonal	39.62 cm	15.6 in
<b>Number of colors</b>	Up to 16.8 million	
<b>Contrast ratio</b>	500:1 (typical)	
<b>Brightness</b>	220 nits or 250 nits	
<b>Pixel resolution</b>		
Pitch	0.252mm x 0.252mm	
Format	1366x768	
Configuration	RGB vertical stripe	
<b>Backlight</b>	LED	
<b>Character display</b>	80 x 25	
<b>Total power consumption</b>	2.0 W	
<b>Viewing angle</b>	±65° horizontal, ±50° vertical (typical)	

## Hard drive specifications

	500 GB*	1 TB*	2TB*
<b>Dimensions</b>			
Height	7 mm	9.5 mm	9.5 mm
Width	70 mm	70 mm	70 mm
Weight	95 g max	102 g max	130 g max
<b>Interface type</b>	SATA 3.0		
<b>Transfer rate</b>	600 MB/sec		
<b>Security</b>	ATA-8 security		
<b>Seek times</b> (typical read, including setting)			
Single track	2 ms	2 ms	2 ms
Average	13.0 ms	13.0 ms	12.0 ms
Maximum	18.0 ms	15.0 ms	22.0 ms
<b>Logical blocks</b>	976,773,168	1,953,525,168	3,907,029,168
<b>Disk rotational speed</b>	5400 rpm		

	500 GB*	1 TB*	2TB*
<b>Operating temperature</b>	<b>0°C to 60°C</b> (32°F to 140°F)	<b>0°C to 60°C</b> (0°F to 140°F)	<b>0°C to 60°C</b> (0°F to 140°F)

\*Size refers to hard drive storage capacity. Actual accessible capacity is less. Actual drive specifications may differ slightly.

**NOTE:** Certain restrictions and exclusions apply. Contact support for details.

## Solid-state drive specifications

Internal Storage*
<b>Supports M.2 SATA-3 SSD</b>
128 GB SATA III Solid-state Drive
256 GB SATA III Solid-state Drive
256 GB SATA III Solid-state Drive NVMe
1 TB SATA III Solid-state Drive with 8 GB NAND

\*For solid-state drives, GB=1 billion bytes. TB=1 trillion bytes. Actual formatted capacity is less. Up to 16 GB (for Windows 7) and up to 30 GB (for Windows 8 and 10) of system disk is reserved for system recovery software.

## DVD±RW SuperMulti DL Drive specifications

<b>Applicable disc</b>	<b>Read:</b> CD-DA, CD+(E)G, CD-MIDI, CD-TEXT, CD-ROM, CD-ROM XA, MIXED MODE CD, CD-I, CD-I Bridge (Photo-CD, Video CD), Multisession CD (Photo-CD, CD-EXTRA, Portfolio, CD-R, CD-RW), CD-R, CD-RW, DVD-ROM (DVD-5, DVD-9, DVD-10, DVD-18), DVD-R, DVD-RW, DVD+R, DVD+RW, DVD-RAM	<b>Write:</b> CD-R and CD-RW DVD+R, DVD+RW, DVD-R, DVD-RW, DVD-RAM
<b>Center hole diameter</b>	1.5 cm (0.59 in)	
<b>Disc diameter</b>		
Standard disc	12 cm (4.72 in)	
Mini disc	8 cm (3.15 in)	
<b>Disc thickness</b>	1.2 mm (0.047 in)	
<b>Track pitch</b>	0.74 μm	
<b>Access time</b>	<b>CD</b>	<b>DVD</b>
Random	< 175 ms	< 230 ms
Full stroke	< 285 ms	< 335 ms
<b>Audio output level</b>	Line-out, 0.7 Vrms	
<b>Cache buffer</b>	2 MB	
<b>Data transfer rate</b>		
24X CD-ROM	3,600 KB/sec	
8X DVD-ROM	11,080 KB/sec	
24X CD-R	3,600 KB/sec	
10X CD-RW	1,500 KB/sec	
8X DVD+R	10,800 KB/sec	
4X DVD+RW	5,400 KB/sec	
8X DVD-R	10,800 KB/sec	
6X DVD-RW	8,000 KB/sec	
8X DVD+R	8,000 KB/sec	
5X DVD-RAM	6,750 KB/sec	
<b>Transfer mode</b>	Multiword DMA Mode	
<b>Startup time</b>	< 15 seconds	
<b>Stop time</b>	< 6 seconds	



# 10 Power cord set requirements

The wide-range input feature of the computer permits it to operate from any line voltage from 100 to 120 volts AC, or from 220 to 240 volts AC.

The 3-conductor power cord set included with the computer meets the requirements for use in the country or region where the equipment is purchased.

Power cord sets for use in other countries and regions must meet the requirements of the country or region where the computer is used.

## Requirements for all countries

The following requirements are applicable to all countries and regions:

- The length of the power cord set must be at least **1.0 m** (3.3 ft) and no more than **2.0 m** (6.5 ft).
- All power cord sets must be approved by an acceptable accredited agency responsible for evaluation in the country or region where the power cord set will be used.
- The power cord sets must have a minimum current capacity of 10 amps and a nominal voltage rating of 125 or 250 V AC, as required by the power system of each country or region.
- The appliance coupler must meet the mechanical configuration of an EN 60 320/IEC 320 Standard Sheet C13 connector for mating with the appliance inlet on the back of the computer.

## Requirements for specific countries and regions

Country/region	Accredited agency	Applicable note number
Australia	EANSW	1
Austria	OVE	1
Belgium	CEBC	1
Canada	CSA	2
Denmark	DEMKO	1
Finland	FIMKO	1
France	UTE	1
Germany	VDE	1
Italy	IMQ	1
Japan	METI	3
The Netherlands	KEMA	1
Norway	NEMKO	1
The People's Republic of China	COC	5
South Korea	EK	4

Country/region	Accredited agency	Applicable note number
Sweden	SEMKO	1
Switzerland	SEV	1
Taiwan	BSMI	4
The United Kingdom	BSI	1
The United States	UL	2

1. The flexible cord must be Type H05VV-F, 3-conductor, 1.0-mm<sup>2</sup> conductor size. Power cord set fittings (appliance coupler and wall plug) must bear the certification mark of the agency responsible for evaluation in the country or region where it will be used.
2. The flexible cord must be Type SPT-3 or equivalent, No. 18 AWG, 3-conductor. The wall plug must be a two-pole grounding type with a NEMA 5-15P (15 A, 125 V) or NEMA 6-15P (15 A, 250 V) configuration.
3. The appliance coupler, flexible cord, and wall plug must bear a “T” mark and registration number in accordance with the Japanese Dentori Law. The flexible cord must be Type VCT or VCTF, 3-conductor, 1.00-mm<sup>2</sup> conductor size. The wall plug must be a two-pole grounding type with a Japanese Industrial Standard C8303 (7 A, 125 V) configuration.
4. The flexible cord must be Type RVV, 3-conductor, 0.75-mm<sup>2</sup> conductor size. Power cord set fittings (appliance coupler and wall plug) must bear the certification mark of the agency responsible for evaluation in the country or region where it will be used.
5. The flexible cord must be Type VCTF, 3-conductor, 0.75-mm<sup>2</sup> conductor size. Power cord set fittings (appliance coupler and wall plug) must bear the certification mark of the agency responsible for evaluation in the country or region where it will be used.

---

# 11 Recycling

When a non-rechargeable or rechargeable battery has reached the end of its useful life, do not dispose of the battery in general household waste. Follow the local laws and regulations in your area for battery disposal.

HP encourages customers to recycle used electronic hardware, HP original print cartridges, and rechargeable batteries. For more information about recycling programs, see the HP Web site at <http://www.hp.com/recycle>.

# Index

- A**
  - AC adapter and battery 5
  - AC adapter, spare part numbers 19
  - action keys 11
  - airplane mode key 12
  - audio
    - product description 2
  - audio, product description 2
  - audio-out (headphone)/audio-in (microphone) jack, identifying 6
- B**
  - back cover
    - spare part number 19, 59
  - backups 69
  - base enclosure
    - removal 28
    - spare part number 17
  - base enclosure, spare part number 28
  - battery
    - removal 30
    - spare part number 17, 30
  - bezel
    - spare part number 18, 59
  - boot order
    - changing 73
  - buttons
    - left TouchPad 8
    - power 10
    - right TouchPad 8
- C**
  - camera
    - identifying 7
  - camera light, identifying 7
  - caps lock light, identifying 9
  - chipset, product description 1
  - components
    - bottom 12
    - display 7
    - left side 6
    - rear 13
    - right side 5
    - top 8
  - computer major components 15
  - computer specifications 75
  - connector, power 5
- D**
  - display
    - specifications 76
  - display assembly
    - removal 39, 59
    - spare part numbers 39, 59
    - subcomponents 18
  - display cable
    - spare part number 18, 59
  - Display panel
    - spare part numbers 16
  - display panel
    - product description 1
    - spare part number 59
  - drive light 5
  - DVD±RW SuperMulti DL Drive
    - specifications 78
- E**
  - esc key, identifying 11
  - Ethernet, product description 2
- F**
  - fan
    - removal 41
    - spare part number 17
    - spare part numbers 41
  - fn key, identifying 11
- G**
  - graphics, product description 1
- H**
  - hard drive
    - product description 2
    - removal 31
    - spare part number 17
    - spare part numbers 31
    - specifications 76
  - HDMI port, identifying 5
  - heat sink
    - removal 43
    - spare part number 17
    - spare part numbers 43
  - hinge assembly
    - spare part number 18, 59
  - HP PC Hardware Diagnostics (UEFI)
    - using 67
  - HP Recovery Manager
    - correcting boot problems 73
    - starting 72
  - HP Recovery media
    - creating 69
    - recovery 72
  - HP Recovery partition
    - recovery 72
    - removing 74
- I**
  - I/O board
    - removal 45
    - spare part number 16
    - spare part numbers 45
  - integrated numeric keypad, identifying 11
  - internal microphones, identifying 7
- J**
  - jacks
    - audio-out (headphone)/audio-in (microphone) 6
    - network 5
    - RJ-45 (network) 5
- K**
  - Keyboard
    - spare part numbers 16
  - keyboard
    - product description 3
  - keys
    - airplane mode 12
    - esc 11
    - fn 11
    - Windows 11

## L

### labels

serial number 13

### lights

AC adapter and battery light 5

caps lock 9

drive 5

mute 9

power 9

RJ-45 (network) status 5

## M

### memory

removal 34

spare part numbers 17, 34

memory card reader, identifying 5

memory card, identifying 5

### memory module

product description 2

### microphone

product description 2

minimized image recovery 72

minimized image, creating 71

model name 1

mute light, identifying 9

## N

network jack, identifying 5

## O

operating system, product description 4

### optical drive

product description 2

removal 26

spare part number 17

spare part numbers 26

specifications 78

optical drive eject button, identifying 6

optical drive, identifying 6

original system recovery 71

## P

Plastics Kit, spare part numbers 19

pointing device, product description 3

### ports

HDMI 5

product description 3

USB 2.0 6

USB 3.0 6

### power button board

removal 46

spare part number 16

spare part numbers 46

power button, identifying 10

### power connector

removal 54

spare part number 16

spare part numbers 54

power connector, identifying 5

### power cord

set requirements 79

spare part numbers 20

power lights, identifying 9

power requirements, product description 4

### processor

product description 1

product description 2

audio 2

chipset 1

display panel 1

Ethernet 2

external media cards 3

graphics 1

hard drive 2

keyboard 3

memory module 2

operating system 4

optical drive 2

pointing device 3

ports 3

power requirements 4

processors 1

product name 1

security 4

sensors 2

serviceability 4

webcam 2

wireless 3

product name 1

product name and number, computer 13

## R

### raw panel

spare part number 18

### recover

options 71

### recovery

discs 70, 72

HP Recovery Manager 71

media 72

starting 72

supported discs 70

system 71

USB flash drive 72

using HP Recovery media 70

### recovery media

creating 69

creating using HP Recovery Manager 70

### recovery partition

removing 74

regulatory information 13

### removal/replacement

procedures 26, 28

RJ-45 (network) jack, identifying 5

RJ-45 (network) status lights, identifying 5

### RTC battery

spare part number 17

Rubber Kit, spare part numbers 20

## S

screw kit 20

### SD card reader

removal 50

spare part numbers 50

### SD card reader board

spare part number 16

security cable slot, identifying 6

security, product description 4

sensors, product description 2

serial number 13

serial number, computer 13

serviceability, product description 4

sleeve 20

### slots

memory card reader 5

security cable 6

### solid-state drive

spare part numbers 17

specifications 77

### speaker

removal 53

spare part numbers 53

- speakers
  - identifying 10
  - spare part number 16
- specifications
  - computer 75
  - display 76
  - DVD±RW SuperMulti DL Drive 78
  - hard drive 76
  - optical drive 78
  - solid-state drive 77
- SSD
  - removal 33
  - spare part numbers 33
- supported discs, recovery 70
- system board
  - removal 48
  - spare part numbers 17, 48
- system information
  - locating 13
- system recovery 71
- system restore point
  - creating 70
- system restore point, creating 69

## T

- TouchPad
  - buttons 8
  - removal 55
  - spare part numbers 16, 55
- TouchPad zone, identifying 8

## U

- USB 2.0 port, identifying 6
- USB 3.0 port 5
- USB 3.0 port, identifying 6
- USB ports, identifying 5

## V

- vents, identifying 12, 13

## W

- warranty period 13
- webcam
  - product description 2
  - removal 63
  - spare part number 18, 59
  - spare part numbers 63
- Windows
  - system restore point 69, 70
- Windows key, identifying 11

- Windows tools
  - using 70
- wireless, product description 3
- WLAN antenna
  - removal 65
- WLAN antenna cable
  - spare part numbers 65
- WLAN antenna, spare part number 59
- WLAN antennas, identifying 7
- WLAN assembly
  - spare part number 19, 59
- WLAN module
  - removal 37
  - spare part number 17
  - spare part numbers 37
- WLAN module, spare part number 19