

Optical Drive Replacement Instructions



854125-001



Before you begin

Observe the following requirements before removing and replacing the optical drive.

WARNING: Never open the cover with the power cord attached or power applied. You might damage your computer or be injured by the spinning fan blades.

WARNING: Avoid touching sharp edges inside the computer.

WARNING: Keep your hands away from the moving fan.

WARNING: Keep fingers and tools clear of the fan when the power is applied.

CAUTION: Static electricity can damage the electronic components inside the computer. Discharge static electricity by touching the metal cage of the computer before touching any internal parts or electronic components.

Tools needed

Phillips #2 screwdriver

Small screws are easily lost. Remove screws over a surface that enables you to retrieve them if they fall.

NOTE: Computer appearance and features may vary by model.

Removing the optical drive

1. Disconnect the power cord and all attached cables from the back of the computer.
2. Remove the access panel by loosening the captive screw (1), sliding the access panel back, and then lifting it off the computer (2).

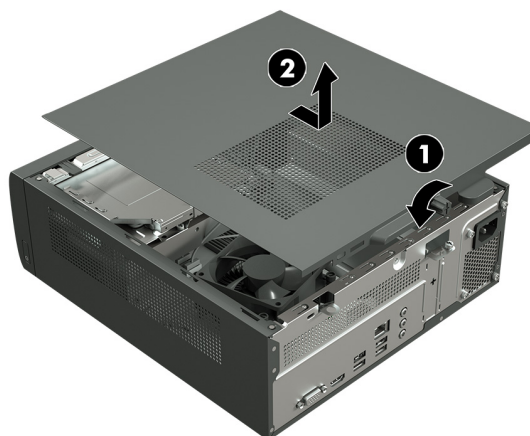

3. Locate the optical drive:

1. Memory modules

2. Optical drive

3. Hard drive

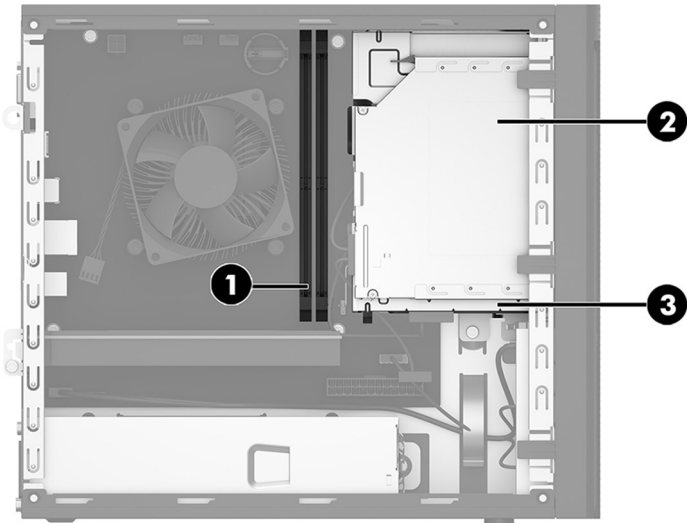

4. Disconnect the data and power cables from the rear of the drive (1), push the green release latch toward the center of the drive (2), and then slide the drive forward and out of the bay through the front bezel (3).

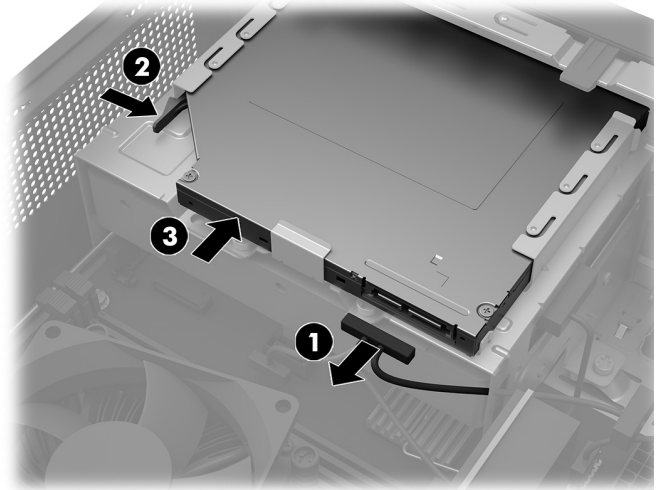

5. Touch the replacement optical drive bag to the metal of the computer, and then remove the replacement optical drive from the bag.

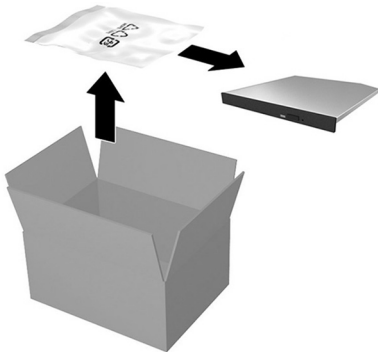

Replacing the optical drive

1. Slide the optical drive through the front bezel all the way into the bay so that it locks into place, and then connect the power and data cables to the rear of the drive.

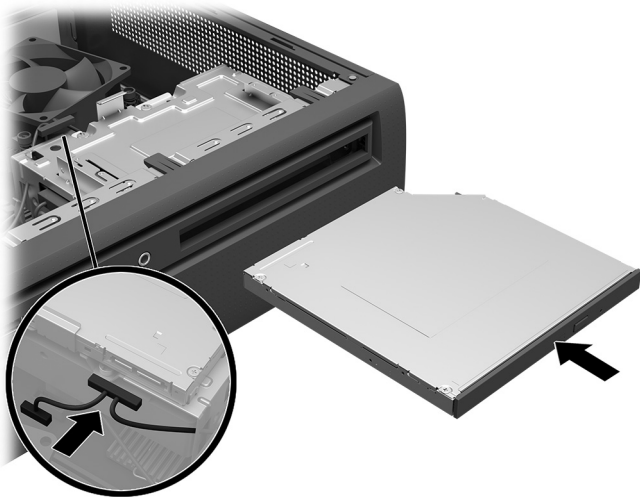

2. Position the access panel on the computer and slide it into place (1). Tighten the captive screw in the rear of the cover (2).

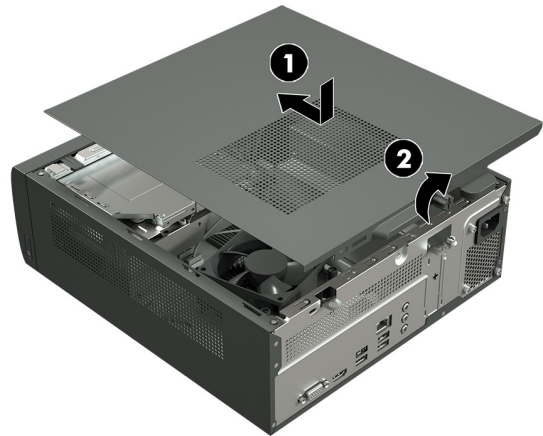

3. Plug the power cord and any additional cables into the back of the computer.



4. Press the power button to turn on the computer.

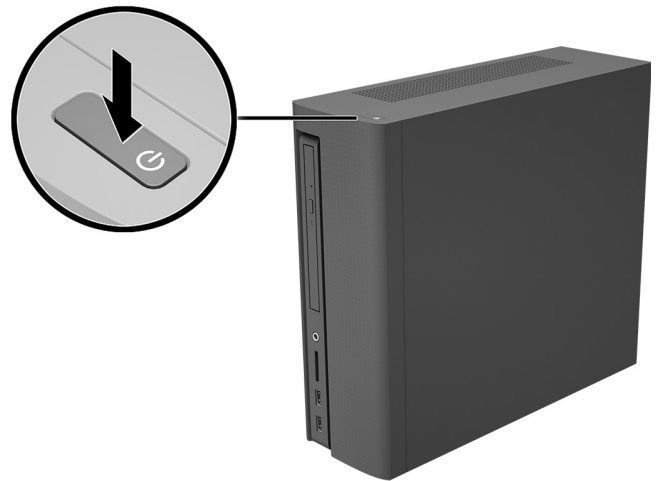

© Copyright 2016 HP Development Company, L.P.

The information contained herein is subject to change without notice. The only warranties for HP products and services are set forth in the express warranty statements accompanying such products and services. Nothing herein should be construed as constituting an additional warranty. HP shall not be liable for technical or editorial errors or omissions contained herein.



First Edition: March 2016

PRINTER: Replace this box with Printed-to-PI Statement(s) as per spec.
NOTE: This box is simply a placeholder. PI Statement(s) do not have to fit inside the box but should be placed in this area.