



Hardware Reference Guide

HP Elite Slice

© Copyright 2016 HP Development Company, L.P.

The information contained herein is subject to change without notice. The only warranties for HP products and services are set forth in the express warranty statements accompanying such products and services. Nothing herein should be construed as constituting an additional warranty. HP shall not be liable for technical or editorial errors or omissions contained herein.

First Edition: June 2016

Document part number: 900063-001

Product Notice

This guide describes features that are common to most models. Some features may not be available on your computer.

Software terms

By installing, copying, downloading, or otherwise using any software product preinstalled on this computer, you agree to be bound by the terms of the HP End User License Agreement (EULA). If you do not accept these license terms, your sole remedy is to return the entire unused product (hardware and software) within 14 days for a refund subject to the refund policy of your seller.

For any further information or to request a full refund of the computer, please contact your seller.

About This Book

This guide provides basic information for upgrading the HP Elite Slice.

 **WARNING!** Text set off in this manner indicates that failure to follow directions could result in bodily harm or loss of life.

 **CAUTION:** Text set off in this manner indicates that failure to follow directions could result in damage to equipment or loss of information.

 **NOTE:** Text set off in this manner provides important supplemental information.

Table of contents

1 Product features	1
HP Elite Slice features	1
HP Elite Slice	1
HP Collaboration Cover	3
HP Tri-Band Wireless Charging Cover	4
HP ODD Module	5
HP Audio Module	6
HP VESA Plate	6
Serial number location	7
2 Setup	8
Connecting or removing modules	8
Connecting modules	8
Removing modules	11
Connecting power	11
Attaching the Elite Slice to a mounting device	12
Installing a security cable	13
Synchronizing the optional wireless keyboard and mouse	14
3 Hardware upgrades	16
Serviceability features	16
Warnings and cautions	16
Removing and replacing the access panel	17
Removing the access panel	17
Replacing the access panel	17
Locating internal components	18
Upgrading system memory	19
Memory module specifications	19
Populating memory module slots	20
Installing system memory modules	21
Removing and replacing a hard drive	23

Appendix A Electrostatic discharge	25
Preventing electrostatic damage	25
Grounding methods	25
Appendix B Computer operating guidelines, routine care and shipping preparation	26
Computer operating guidelines and routine care	26
Shipping preparation	27
Appendix C Accessibility	28
Supported assistive technologies	28
Contacting support	28
Index	29

1 Product features

HP Elite Slice features



HP Elite Slice



The Elite Slice is the base module, the single essential module. The Elite Slice features an optional full-fingerprint reader: instead of swiping your finger across the reader, you press your finger on the reader. This reader is more accurate than the swipe readers.

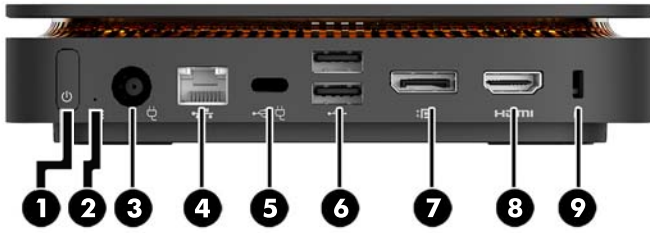

Item	Component	Item	Component
1	Power button	6	USB ports (2)
2	Drive light	7	Dual-Mode DisplayPort (D++)
3	Power connector	8	HDMI port
4	RJ-45 (network) jack	9	Security cable slot
5	USB Type-C port 60 W input, DisplayPort 15 W output		

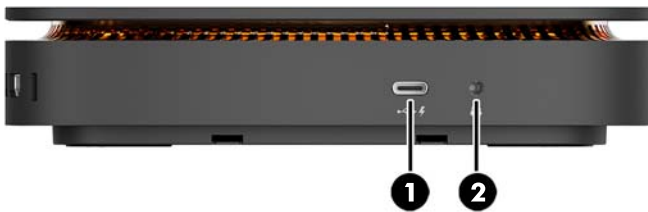

Item	Component	Item	Component
1	USB Type-C port 15 W output	3	Full-fingerprint reader (optional)
2	Universal audio jack		

HP Collaboration Cover

The Elite Slice may be ordered with the optional HP Collaboration Cover. The collaboration cover enables wireless communication with capacitive touch buttons for conference calls. This cover does not include speakers or microphones. Speakers and microphones are incorporated into the HP Audio Module, purchased separately.



Item	Component	Item	Component
1	Answer/Call	4	Volume up
2	Mute	5	Reject/Hang up
3	Volume down		

HP Tri-Band Wireless Charging Cover

The Elite Slice may be ordered with the optional HP Tri-Band Wireless Charging Cover. The charging cover provides a wireless charging area for compatible wireless charging devices. Three industry-standard charging technologies are supported: Qi, PMA, and A4WP.



Component	Description
Charging light	Solid white = Charge complete
	Solid amber = Charging
	Blinking amber = Error
	Blinking white = Firmware update in progress
	Off = Not charging

HP ODD Module



The optional HP ODD Module adds optical drive functionality. Additional optical drive modules may be connected to an Elite Slice configuration, depending upon the power supply and the total number of powered modules. For more information, see [Connecting or removing modules on page 8](#).

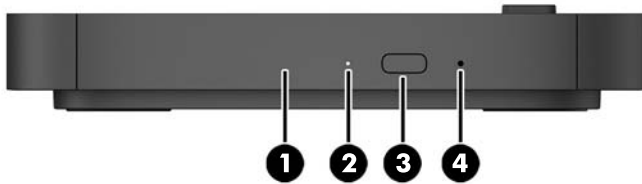

Item	Component	Item	Component
1	Optical drive disc tray	3	Optical drive eject button
2	Optical drive light	4	Manual eject hole

HP Audio Module



The optional HP Audio Module features an enhanced sound system. The audio module supplies speakers and microphones required to support features of the collaboration cover.

HP VESA Plate



The HP VESA Plate enables the Elite Slice assembly to be mounted on a monitor, wall, or desk.

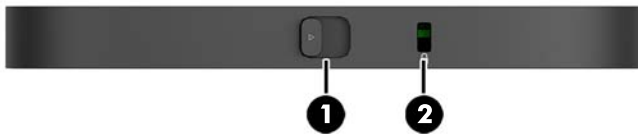

figure: back, bottom (VESA holes)

Item	Component	Item	Component
1	Quick release latch	2	Security cable slot

Serial number location

Each computer has a unique serial number and a product ID number laser-etched on the bottom of the Elite Slice. A copy of these labels is inside the case. Keep these numbers available for use when contacting support for assistance.



2 Setup

Connecting or removing modules

Three types of modules may be connected to the Elite Slice: optical drive module, audio module, and VESA plate. Modules should be attached to the base module in the following order:

- HP ODD Modules
- HP Audio Module
- HP VESA Plate

The optical drive module and the audio module are powered modules. Only one audio module may be connected to the Elite Slice. Depending on the AC adapter, however, you may be able to connect multiple optical drive modules.



NOTE: Check the label on the AC adapter to verify the power supplied.

- A 90 W AC adapter (which ships with the HP Tri-Band Wireless Charging Cover) allows up to four powered modules to be connected to the Elite Slice:
 - Up to three optical drive modules and one audio module
 - or —
 - Up to four optical drive modules (and no audio module)
- A 65 W AC adapter allows up to two powered modules to be connected to the Elite Slice:
 - One optical drive module and one audio module
 - or —
 - Up to two optical drive modules (and no audio module)

Connecting modules



CAUTION: Before connecting modules, turn off the Elite Slice and disconnect it from any power source.

Modules cannot be “hot-plugged” or “hot-swapped.”

1. Remove/disengage the security cable, if one is attached.
2. Remove all removable media, such as USB flash drives.
3. Turn off the Elite Slice properly through the operating system, and then turn off any external devices.

4. Disconnect the power cord from the Elite Slice and disconnect any external devices.
5. If the VESA plate is connected, slide the quick release latch to the unlocked position and remove the VESA plate.
6. Align the module connection port on the underside of the Elite Slice with the module expansion connector on another module and press the Elite Slice down firmly.

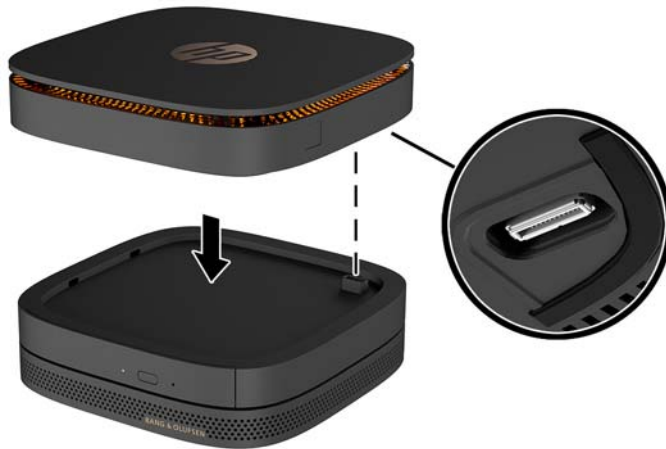

You should hear a quiet click when the modules lock together. Each module locks into place and hides the release latch of the module above it.

Repeat until all modules have been connected.

7. Slide the quick release latch on the VESA plate (1) to the unlocked position. Position the connected modules over the VESA plate.

The VESA plate does not have an module expansion connector. Be sure that the ports of Elite Slice and the quick release latch and security cable slot of the VESA plate are all on the same side.

8. Press the modules (2) down onto the VESA plate.



- Slide the quick release latch on the back of the VESA plate to the locked position to lock all modules together.

CAUTION: There are four tabs in the VESA plate. When you position the Elite Slice configuration correctly onto the VESA plate and slide the quick release latch to the locked position, the four tabs lock the VESA plate to the Elite Slice assembly. If the VESA plate is not correctly oriented, the quick release latch cannot be moved to the locked position and the modules are not secured.



- Install a security cable in the VESA plate security cable slot to prevent the quick release latch from being unlocked and the modules from being separated.

NOTE: The security cable is designed to act as a deterrent, but it may not prevent the computer from being mishandled or stolen.

Removing modules

CAUTION: Before disconnecting modules, turn off the Elite Slice and disconnect it from any power source.

Modules cannot be “hot-plugged” or “hot-swapped.”

Modules must be removed one at a time, starting at the bottom. Removing the bottom module exposes the release latch of the module above it.

1. Remove/disengage the security cable, if one is attached.
2. Remove all removable media, such as USB flash drives.
3. Turn off the Elite Slice properly through the operating system, and then turn off any external devices.
4. Disconnect the power cord from the Elite Slice and disconnect any external devices.
5. If the VESA plate is connected, slide the quick release latch on the back of the VESA plate to the unlocked position and lift the module stack off the VESA plate.
6. Beginning at the bottom, remove additional modules by pressing the release latch (1) on the underside of each module until it releases the module (2) above it.

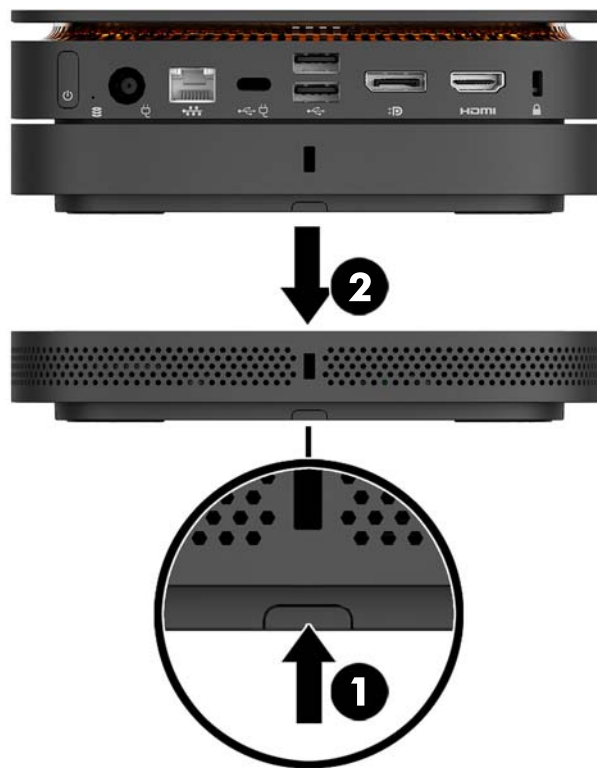

Connecting power

The Elite Slice can be connected to a powered port on an HP monitor or it can be connected to an AC outlet using the HP adapter that shipped with the Elite Slice. Power sources not obtained from HP will be rejected.

NOTE: Under certain power-loading conditions, some USB ports may be temporarily disabled to meet product safety regulations.

To connect to an AC outlet:

1. Connect the power cord to the AC adapter and the AC outlet.

 **IMPORTANT:** When connecting the Elite Slice to an AC outlet, you must use the HP adapter that shipped with the Elite Slice.

2. Connect the AC adapter to the power connector on the rear of the Elite Slice.

If you have an HP monitor with a charging port that can supply at least 60 W, you may connect the Elite Slice to the monitor instead of an AC outlet.

1. Disconnect Slice from AC power.

 **NOTE:** If the Elite Slice is connected to both a powered port and an AC outlet, the Elite Slice will use the AC power.

2. Connect one end of a US Type-C cable (purchased separately) to a rear USB Type-C port on the Elite Slice.
3. Connect the other end of the cable to a charging port on an HP monitor.

Attaching the Elite Slice to a mounting device

If the VESA plate is connected, the Elite Slice can be attached to a monitor, wall, or desk in either of two mounting positions:

- Vertical
- Horizontal with all cables attached to the rear of the computer and hanging straight down

To mount the Elite Slice:

1. Connect all modules except the VESA plate.
2. Use the four screws provided with the VESA plate to attach the VESA plate to the monitor or other surface.

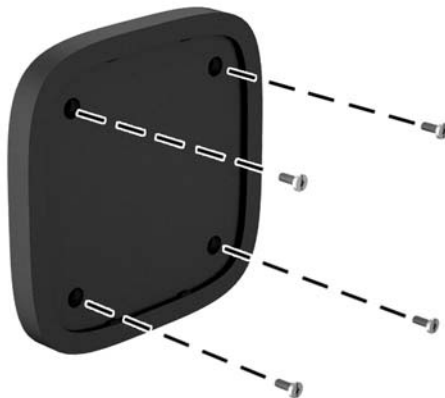

If the Elite Slice is to be mounted horizontally, be sure to position the VESA plate with the quick release latch facing down. All cords and cables should be hanging straight down from the connectors.

- Carefully connect the modules to the VESA plate.
- Slide the quick release latch on the rear of the VESA plate to the locked position to secure the VESA plate to the module above it.



NOTE: HP highly recommends that you secure the Elite Slice assembly by attaching a security cable to the rear of the VESA plate. This stops the quick release latch from being moved to the unlocked position and prevents accidental release of the modules.

The security cable is designed to act as a deterrent, but it may not prevent the computer from being mishandled or stolen.

Installing a security cable

The 10 mm ultra-slim cable lock displayed below can be used to secure the computer. When installed in the bottom module, the cable locks all modules together. If the VESA plate is installed, slide the quick release to the locked position and install a security cable to lock all modules together.

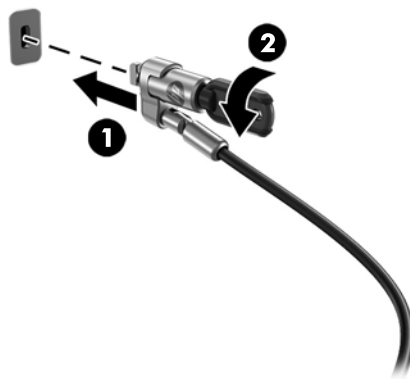

NOTE: The security cable is designed to act as a deterrent, but it may not prevent the computer from being mishandled or stolen.

Synchronizing the optional wireless keyboard and mouse

The mouse and keyboard are synchronized at the factory. If they do not work, remove and replace the batteries. If the mouse and keyboard still do not work, then follow this procedure to manually resynchronize the pair.

1.

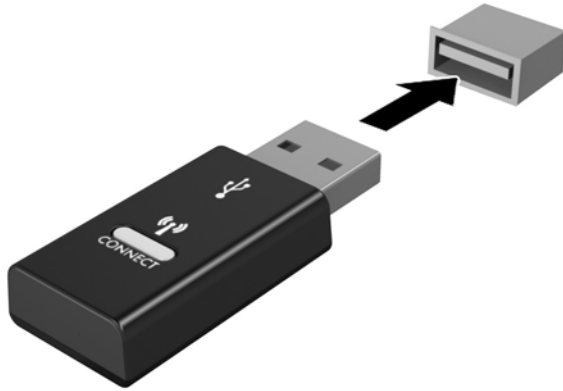

2.

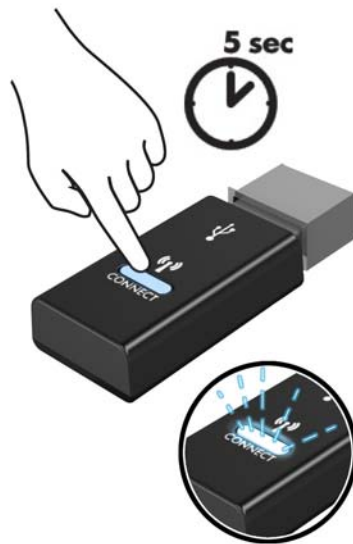

3.

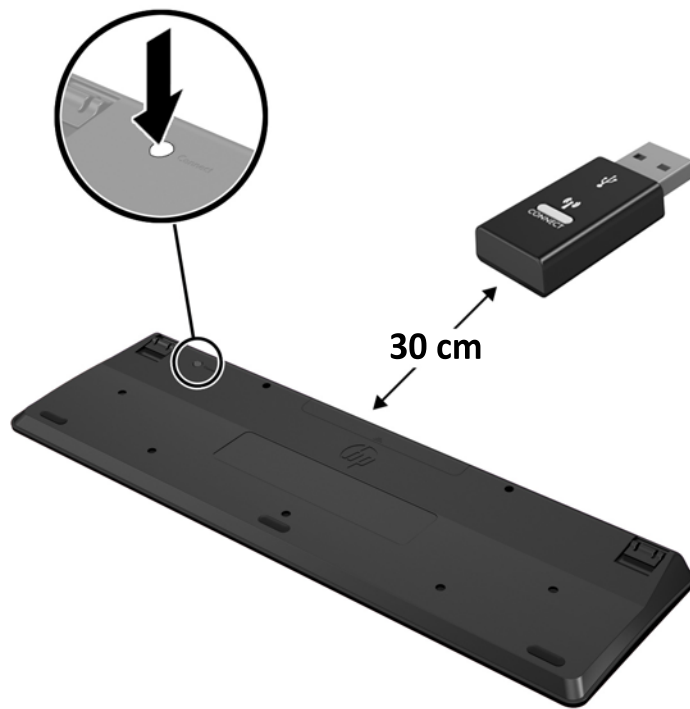

4.



 **NOTE:** If the mouse and keyboard still do not work, then remove and replace the batteries. If the mouse and keyboard are still not synchronized, then synchronize the keyboard and mouse again.

3 Hardware upgrades

Serviceability features

The computer includes features that make it easy to upgrade and service.

Warnings and cautions

Before performing upgrades, be sure to carefully read all of the applicable instructions, cautions, and warnings in this guide.

 **WARNING!** To reduce the risk of personal injury from electric shock, hot surfaces, or fire:

Disconnect the power cord from the AC outlet before removing the enclosure. Energized and moving parts are inside.

Allow the internal system components to cool before you touch them.

Replace and secure the enclosure before restoring power to the equipment.

Do not connect telecommunications or telephone connectors to the network interface controller (NIC) receptacles.

Do not disable the power cord grounding plug. The grounding plug is an important safety feature.

Plug the power cord into a grounded (earthed) AC outlet that is easily accessible at all times.

To reduce the risk of serious injury, read the *Safety & Comfort Guide*. It describes proper workstation setup and provides guidelines for posture and work habits that increase your comfort and decrease your risk of injury. It also provides electrical and mechanical safety information. This guide is located on the web at <http://www.hp.com/ergo>.

 **CAUTION:** Static electricity can damage the electrical components of the computer or optional equipment. Before beginning these procedures, ensure that you are discharged of static electricity by briefly touching a grounded metal object. See [Electrostatic discharge on page 25](#) for more information.

When the computer is plugged into an AC power source, voltage is always applied to the system board. You must disconnect the power cord from the power source before opening the computer to prevent damage to internal components.

Removing and replacing the access panel

Removing the access panel

The Elite Slice access panel must be removed to access the hard drive and system memory modules.

1. Remove the Elite Slice from any additional modules.

For instructions, see [Removing modules on page 11](#).

2. Place the computer upside down on a flat surface covered with a soft cloth to protect the computer from scratches or other damage.
3. Loosen the four captive screws (1) securing the access panel, and lift the panel off the computer (2).

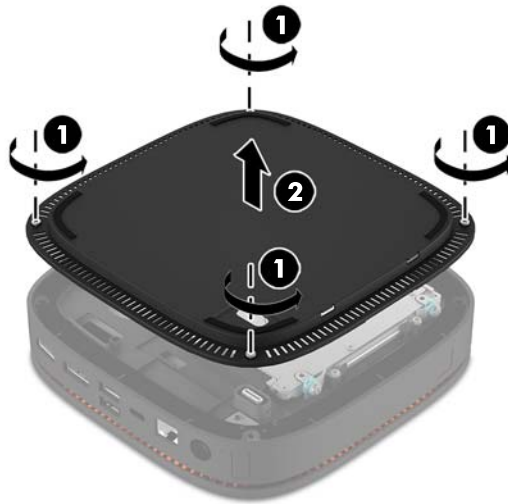

Replacing the access panel

1. Place the computer upside down on a flat surface covered with a soft cloth.
2. Align the access panel (1) with the computer so that the module connection port is clearly visible through the opening in the access panel.

3. Tighten the four captive screws (2) to secure the access panel to the computer.



4. Reconnect any additional modules.

For instructions, see [Connecting or removing modules on page 8](#).

Locating internal components

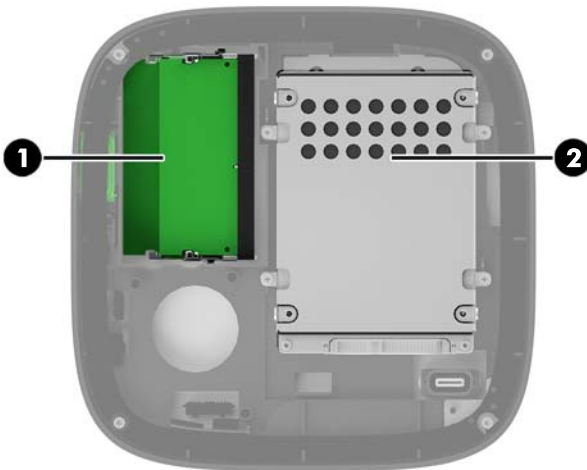

Item	Component	Item	Component
1	System memory modules	2	Hard drive

Upgrading system memory

The memory module slots on the system board can be populated with up to two industry-standard memory modules. At least one small outline, dual inline memory module (SODIMM) is preinstalled. To achieve the maximum memory support, you can populate the system board with up to 32 GB (16 GB x 2) of memory.

Memory module specifications

For proper system operation, the SODIMMs must adhere to the following specifications:

- industry-standard 288-pins
- unbuffered non-ECC PC4-17000 DDR4-2133 MHz-compliant
- 1.2 volt DDR4-SDRAM SODIMMs
- Support CAS latency 15 DDR4 2133 MHz (15-15-15 timing)
- Contain the mandatory Joint Electronic Device Engineering Council (JEDEC) specification

The computer supports the following:

- 512-Mbit, 1-Gbit, and 2-Gbit non-ECC memory technologies
- Single-sided and double-sided SODIMMS
- SODIMMs constructed with x8 and x16 devices



NOTE: To avoid compatibility issues, HP recommends that you use only HP memory modules in this computer. The system will not operate properly if you install unsupported DIMM memory. DIMMs constructed with x4 SDRAM are not supported.

Populating memory module slots

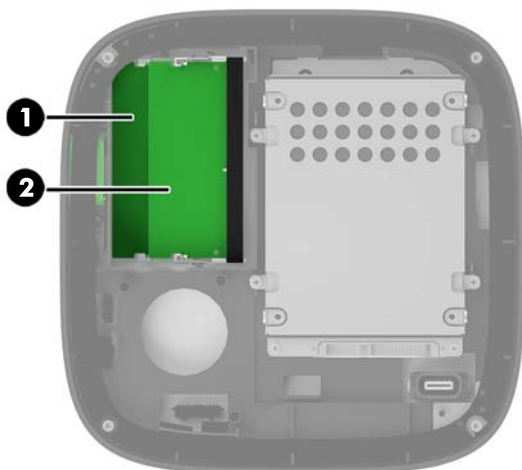

There are two memory module slots, one slot per channel. The slots are labeled DIMM1 and DIMM3. The DIMM1 slot operates in memory channel B. The DIMM3 slot operates in memory channel A.

Item	Description	System Board Label	Slot Color
1	Memory 1 slot, Channel B	DIMM1	Black
2	Memory 3 slot, Channel A	DIMM3	Black

The system automatically operates in single-channel mode, dual-channel mode, or flex mode, depending on how the memory modules are installed.

- The system operates in single-channel mode if only one memory module slot is populated.
- The system operates in higher-performing, dual-channel mode if the capacity of the memory modules in Channel A and Channel B are equal.
- The system operates in flex mode if the capacity of the memory modules in Channel A and Channel B are not equal. In flex mode, the channel populated with the least amount of memory determines the total amount of memory that is assigned to dual-channel operation, and the remainder is assigned to single-channel operation. In flex mode, install the memory module with the larger capacity in the DIMM3 slot (Channel A).
- In any mode, the maximum operational speed is determined by the slowest memory module in the system.

Installing system memory modules

⚠ CAUTION: You must disconnect the power cord and wait approximately 30 seconds for the power to drain before adding or removing memory modules. Regardless of the power-on state, voltage is always supplied to the memory modules as long as the computer is plugged into an active AC outlet. Adding or removing memory modules while voltage is present may cause irreparable damage to the memory modules or system board.

The memory module slots have gold-plated metal contacts. When upgrading the memory, it is important to use memory modules with gold-plated metal contacts to prevent corrosion and/or oxidation resulting from having incompatible metals in contact with each other.

Static electricity can damage the electronic components of the computer or optional cards. Before beginning these procedures, ensure that you are discharged of static electricity by briefly touching a grounded metal object. For more information, see [Electrostatic discharge on page 25](#).

When handling a memory module, be careful not to touch any of the contacts. Doing so may damage the module.

1. Remove the access panel.

For instructions, see [Removing the access panel on page 17](#).

2. To remove a memory module, press outward on the two latches on each side of the memory module (1), and then pull the memory module out of the slot (2).



3. Insert the new memory module into the slot at approximately a 30° angle (1), and then press the memory module (2) into the slot so that the latches lock it in place.



 **NOTE:** A memory module can be installed in only one way. Match the notch on the module with the tab on the memory module slot.

4. Replace the access panel.

For instructions, see [Replacing the access panel on page 17](#).

The computer automatically recognizes the additional memory when you turn on the computer.

Removing and replacing a hard drive

 **NOTE:** Back up the hard drive before you remove it so that you can transfer the data to the new hard drive.

1. Remove the access panel.
For instructions, see [Removing the access panel on page 17](#).
2. Pull the tab (1) to disconnect the hard drive power-and-data cable from the hard drive.
3. Remove the 4 screws (2) attaching the hard drive cage to the board and lift the cage (3) out of the chassis.

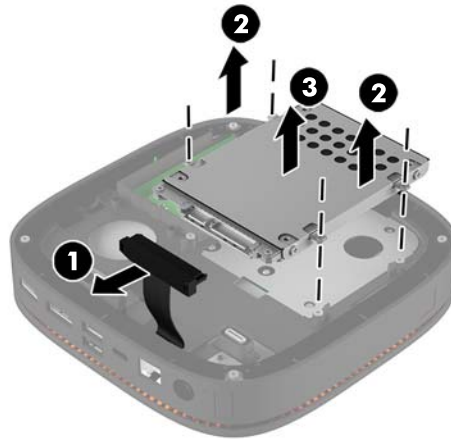

4. Remove the screws (1) securing the hard drive in the cage and lift the hard drive (2) out of the cage.

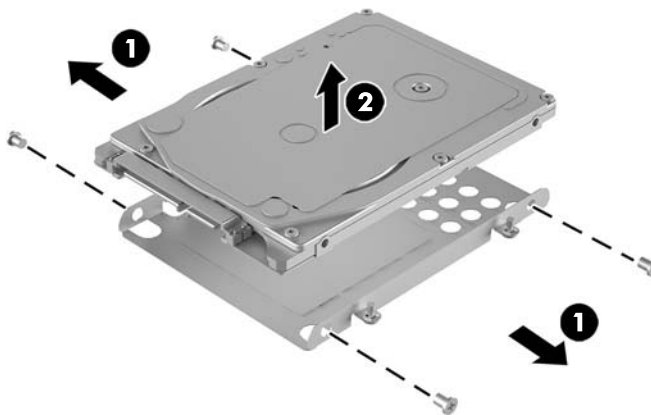

5. Position the new hard drive over the drive cage with the hard drive connectors at the end with the thermal patch and the circuit board side facing the closed side of the drive cage.
6. Set the new hard drive (1) into the cage. Be sure the label side of the hard drive is visible.

7. Fasten the four screws (2) to secure the hard drive in the cage.

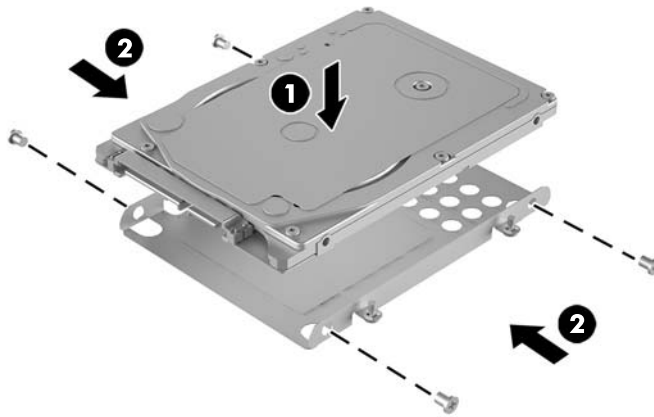

8. Replace the hard drive cage (1) in the chassis. Be sure that the hard drive connectors are facing the back of the chassis.
9. Align the drive cage tabs with the screw posts in the chassis and fasten the four screws (2) to secure the hard drive.
10. Reconnect the power-and-data cable (3) to the hard drive.

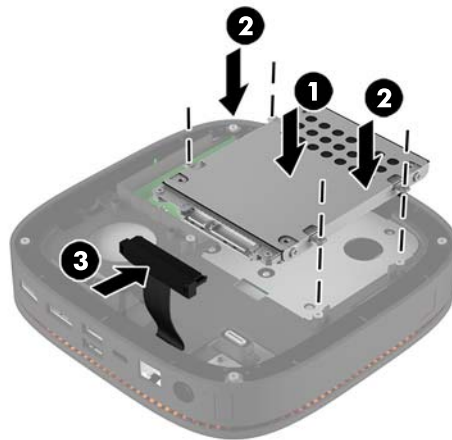

11. Replace the access panel.

For instructions, see [Replacing the access panel on page 17](#).

A Electrostatic discharge

A discharge of static electricity from a finger or other conductor may damage system boards or other static-sensitive devices. This type of damage may reduce the life expectancy of the device.

Preventing electrostatic damage

To prevent electrostatic damage, observe the following precautions:

- Avoid hand contact by transporting and storing products in static-safe containers.
- Keep electrostatic-sensitive parts in their containers until they arrive at static-free workstations.
- Place parts on a grounded surface before removing them from their containers.
- Avoid touching pins, leads, or circuitry.
- Always be properly grounded when touching a static-sensitive component or assembly.

Grounding methods

Use one or more of the following methods when handling or installing electrostatic-sensitive parts:

- Use a wrist strap connected by a ground cord to a grounded workstation or computer chassis. Wrist straps are flexible straps with a minimum of 1 megohm +/- 10 percent resistance in the ground cords. To provide proper ground, wear the strap snug against the skin.
- Use heelstraps, toestraps, or bootstraps at standing workstations. Wear the straps on both feet when standing on conductive floors or dissipating floor mats.
- Use conductive field service tools.
- Use a portable field service kit with a folding static-dissipating work mat.

If you do not have any of the suggested equipment for proper grounding, contact an HP authorized dealer, reseller, or service provider.



NOTE: For more information on static electricity, contact an HP authorized dealer, reseller, or service provider.

B Computer operating guidelines, routine care and shipping preparation

Computer operating guidelines and routine care

Follow these guidelines to properly set up and care for the computer and monitor:

- Keep the computer away from excessive moisture, direct sunlight, and extremes of heat and cold.
- Operate the computer on a sturdy, level surface. Leave a 10.2 cm (4 in) clearance on all vented sides of the computer and above the monitor to permit the required airflow.
- Never restrict the airflow into the computer by blocking any vents or air intakes. Do not place the keyboard, with the keyboard feet down, directly against the front of the desktop unit as this also restricts airflow.
- Never operate the computer with the access panel or any of the expansion card slot covers removed.
- Do not stack computers on top of each other or place computers so near each other that they are subject to each other's recirculated or preheated air.
- If the computer is to be operated within a separate enclosure, intake and exhaust ventilation must be provided on the enclosure, and the same operating guidelines listed above will still apply.
- Keep liquids away from the computer and keyboard.
- Never cover the ventilation slots on the monitor with any type of material.
- Install or enable power management functions of the operating system or other software, including sleep states.
- Turn off the computer before you do either of the following:
 - Wipe the exterior of the computer with a soft, damp cloth as needed. Using cleaning products may discolor or damage the finish.
 - Occasionally clean the air vents on all vented sides of the computer. Lint, dust, and other foreign matter can block the vents and limit the airflow.

Shipping preparation

Follow these suggestions when preparing to ship the computer:

1. Back up the hard drive files to an external storage device. Be sure that the backup media is not exposed to electrical or magnetic impulses while stored or in transit.



NOTE: The hard drive locks automatically when the system power is turned off.

2. Remove and store all removable media.
3. Turn off the computer and external devices.
4. Disconnect the power cord from the AC outlet and then from the computer.
5. Disconnect the system components and external devices from their power sources and then from the computer.



NOTE: Ensure that all boards are seated properly and secured in the board slots before shipping the computer.

6. Pack the system components and external devices in their original packing boxes or similar packaging, with sufficient packing material to protect them.

C Accessibility

HP designs, produces, and markets products and services that can be used by everyone, including people with disabilities, either on a stand-alone basis or with appropriate assistive devices.

Supported assistive technologies

HP products support a wide variety of operating system assistive technologies and can be configured to work with additional assistive technologies. Use the Search feature on your device to locate more information about assistive features.



NOTE: For additional information about a particular assistive technology product, contact customer support for that product.

Contacting support

We are constantly refining the accessibility of our products and services and welcome feedback from users. If you have an issue with a product or would like to tell us about accessibility features that have helped you, please contact us at (888) 259-5707, Monday through Friday, 6 a.m. to 9 p.m. Mountain Time. If you are deaf or hard-of-hearing and use TRS/VRS/WebCapTel, contact us if you require technical support or have accessibility questions by calling (877) 656-7058, Monday through Friday, 6 a.m. to 9 p.m. Mountain Time.

Index

A

- access panel
 - removing 17
 - replacing 17
- accessibility 28
- audio module features 6

B

- base module features 1

C

- cautions 16
- collaboration cover features 3
- computer operating guidelines 26
- connecting modules 8
- connecting power 11

E

- electrostatic discharge, preventing damage 25

F

- features
 - audio module 6
 - base module 1
 - collaboration cover 3
 - optical drive module 5
 - VESA plate 6
 - wireless charging cover 4

H

- hard drive
 - installing 23
 - removing 23
- HP Audio Module 6
- HP Collaboration Cover 3
- HP Elite Slice features 1
- HP ODD Module 5
- HP Tri-Band Wireless Charging Cover 4

- HP VESA Plate 6

I

- installation guidelines 16
- installing
 - hard drive 23
 - security cable 13
 - system memory 19, 21
- internal components 18

K

- keyboard, synchronizing wireless 14

M

- memory, system
 - installing 19, 21
 - replacing 21
 - slot population 20
 - slots 19
 - specifications 19
- module order 8
- module sequence 8
- modules
 - connecting 8
 - removing 11
- mounting HP Elite Slice 12
- mouse, synchronizing wireless 14

O

- optical drive module features 5

P

- product ID location 7

R

- removing
 - access panel 17
 - hard drive 23
 - modules 11

- replacing

- access panel 17
 - system memory 21

S

- security cable, installing 13
- serial number location 7
- setup 8
- shipping preparation 27
- specifications, system memory 19
- synchronizing wireless keyboard and mouse 14

V

- ventilation guidelines 26
- VESA plate features 6

W

- warnings 16
- wireless charging cover features 4