



## HP ENVY m7 Notebook PC

**Maintenance and Service Guide**  
**IMPORTANT! This document is intended for**  
**HP authorized service providers only.**

© Copyright 2016, 2017 HP Development Company, L.P.

Bluetooth is a trademark owned by its proprietor and used by HP Inc. under license. Intel and Core are U.S. registered trademarks of Intel Corporation. Microsoft and Windows are either registered trademarks or trademarks of Microsoft Corporation in the United States and/or other countries. SD Logo is a trademark of its proprietor.

In accordance with Microsoft's support policy, HP does not support the Windows 8 or Windows 7 operating system on products configured with Intel and AMD 7th generation and forward processors or provide any Windows 8 or Windows 7 drivers on <http://www.support.hp.com>.

The information contained herein is subject to change without notice. The only warranties for HP products and services are set forth in the express warranty statements accompanying such products and services. Nothing herein should be construed as constituting an additional warranty. HP shall not be liable for technical or editorial errors or omissions contained herein.

Third Edition: August 2017

Second Edition: July 2016

First Edition: April 2016

Document Part Number: 855521-003

## Safety warning notice

---

 **WARNING!** To reduce the possibility of heat-related injuries or of overheating the device, do not place the device directly on your lap or obstruct the device air vents. Use the device only on a hard, flat surface. Do not allow another hard surface, such as an adjoining optional printer, or a soft surface, such as pillows or rugs or clothing, to block airflow. Also, do not allow the AC adapter to contact the skin or a soft surface, such as pillows or rugs or clothing, during operation. The device and the AC adapter comply with the user-accessible surface temperature limits defined by the International Standard for Safety of Information Technology Equipment (IEC 60950-1).

---



---

# Table of contents

<b>1 Product description .....</b>	<b>1</b>
<b>2 Getting to know your computer .....</b>	<b>4</b>
Right side .....	4
Left side .....	5
Display .....	6
Top .....	7
TouchPad .....	7
Lights .....	8
Button, speakers, and vent .....	9
Keys .....	10
Bottom .....	11
Labels .....	12
<b>3 Illustrated parts catalog .....</b>	<b>13</b>
Computer major components .....	13
Optical drive components .....	17
Miscellaneous parts .....	18
<b>4 Removal and replacement procedures preliminary requirements .....</b>	<b>19</b>
Tools required .....	19
Service considerations .....	19
Plastic parts .....	19
Cables and connectors .....	20
Drive handling .....	20
Grounding guidelines .....	21
Electrostatic discharge damage .....	21
Packaging and transporting guidelines .....	22
Workstation guidelines .....	22
Equipment guidelines .....	23
<b>5 Removal and replacement procedures .....</b>	<b>24</b>
Component replacement procedures .....	24
Bottom cover .....	24
Battery .....	26
Solid-state drive .....	27

TouchPad cable .....	28
Memory module .....	29
RTC battery .....	30
Hard drive .....	31
WLAN module .....	33
Optical drive .....	35
TouchPad .....	37
Power connector cable .....	39
USB board .....	40
USB board cable .....	42
System board .....	43
Heat sink .....	47
Fan .....	49
Speakers .....	50
Display assembly .....	51
<b>6 Using Setup Utility (BIOS) .....</b>	<b>54</b>
Starting Setup Utility (BIOS) .....	54
Updating Setup Utility (BIOS) .....	54
Determining the BIOS version .....	54
Downloading a BIOS update .....	55
<b>7 Using HP PC Hardware Diagnostics (UEFI) .....</b>	<b>56</b>
Downloading HP PC Hardware Diagnostics (UEFI) to a USB device .....	56
<b>8 Specifications .....</b>	<b>58</b>
Computer specifications .....	58
<b>9 Backing up, restoring, and recovering .....</b>	<b>60</b>
Creating recovery media and backups .....	60
Creating HP Recovery media (select products only) .....	60
Using Windows tools .....	61
Restore and recovery .....	62
Recovering using HP Recovery Manager .....	62
What you need to know before you get started .....	62
Using the HP Recovery partition (select products only) .....	63
Using HP Recovery media to recover .....	63
Changing the computer boot order .....	64
Removing the HP Recovery partition (select products only) .....	64

<b>10 Power cord set requirements</b> .....	<b>65</b>
Requirements for all countries .....	65
Requirements for specific countries and regions .....	65
<b>11 Recycling</b> .....	<b>67</b>
<b>Index</b> .....	<b>68</b>





# 1 Product description

Category	Description	17-u200— 17-u299	17-u100— 17-u199	17-u000— 17-u099
<b>Product Name</b>	HP ENVY m7 Notebook PC (model numbers 17-u200 through 17-u299)	✓		
	HP ENVY m7 Notebook PC (model numbers 17-u100 through 17-u199)		✓	
	HP ENVY m7 Notebook PC (model numbers 17-u000 through 17-u099)			✓
<b>Processors</b>	Intel® Core™ i7-8550U 1.80-GHz (5C turbo up to 4.00-GHz) processor (2400-MHz front-side bus (FSB), 8.0-MB L3 cache, dual core, 15-W)	✓		
	Intel® Core™ i7-7500U 2.70-GHz (5C turbo up to 3.50-GHz) processor (2133-MHz front-side bus (FSB), 4.0-MB L3 cache, dual core, 15-W)		✓	
	Intel Core i7-6500U 2.50-GHz (5C turbo up to 3.10-GHz) processor (1600-MHz FSB, 4.0-MB L3 cache, dual core, 15-W)		✓	✓
<b>Graphics</b>	<b>Internal graphics</b>	✓		
	Intel UHD Graphics 620	✓		
	<b>Hybrid Graphics:</b>	✓	✓	✓
	nVIDIA N175-G1 (GeForce MX150) graphics subsystem with 4096-MB of dedicated video memory	✓		
	nVIDIA N165-GTR-S (GeForce 940MX) graphics subsystem with 2048-MB of dedicated video memory		✓	✓
	Support for HD decode, DX12, and high-definition multimedia interface (HDMI)	✓	✓	✓
	Support for Optimus	✓	✓	✓
	Support for GPU performance scaling (GPS)	✓	✓	✓
<b>Panel</b>	<b>17.3-in, 16:9 ultra wide aspect ratio, anti glare, flat-flat (4.0-mm), white light-emitting diode (WLED), UWVA, typical brightness: 300 nits</b>	✓	✓	✓
	Ultra high-definition (UHD)(3840×2160), eDP+PSR display assembly	✓	✓	✓
	Full high-definition (FHD)(1920×1080), eDP display assembly	✓	✓	✓
	Touch solution with flush glass, multitouch enabled	✓	✓	✓
<b>Memory module</b>	Two memory slots, non-accessible	✓	✓	✓
	Support for DDR4-2400 Dual Channel	✓		
	Support for DDR4-2133 Dual Channel		✓	✓
	Support for up to 16-GB maximum on-board system memory:	✓	✓	✓

Category	Description	17-u200— 17-u299	17-u100— 17-u199	17-u000— 17-u099
	<ul style="list-style-type: none"> <li>16384 MB (8192 MB × 2)</li> </ul>	√	√	√
	<ul style="list-style-type: none"> <li>12288 MB (8192 MB + 4096 MB)</li> </ul>	√	√	√
<b>Hard drive</b>	Support for all 9.5- and 7.0-mm, SATA, 2.5-in hard drives	√	√	√
	Support for 1-TB, 7200-rpm, 9.5-mm hard drive	√	√	√
	Support for Accelerometer hard drive protection	√	√	√
	Support for hard drive and solid-state drive in the following combinations:	√	√	√
<b>Solid-state drive</b>	Support for next generation form factor (NGFF), M.2 solid-state drive	√	√	√
	Support for the following solid-state drives:	√	√	√
	<ul style="list-style-type: none"> <li>512-MB, M.2, SATA solid-state drive supporting triple-level cell (TLC)</li> </ul>	√	√	√
	<ul style="list-style-type: none"> <li>256-MB, M.2, SATA solid-state drive supporting TLC</li> </ul>	√	√	√
<b>Optical drive</b>	Support for 9.0-mm tray load, SATA fixed (not modular)	√	√	√
	Support for DVD±RW DL SuperMulti Drive	√	√	√
	Support for zero-power optical drive	√	√	√
	Support M-disc	√	√	√
<b>Audio and video</b>	HP Wide Vision HD IR Camera - indicator LED and 2x IR LEDs, USB2.0, HD BSI sensor + IR sensor, f2.0, WDR, 88° WFOV	√	√	√
	720p by 30 frames per second	√	√	√
	Supports Windows Hello	√	√	√
	HP Noise Cancellation	√	√	√
	Support for B & O Play	√	√	√
	Dual speakers	√	√	√
	HP Audio Boost/ Conexant Smart amp (SW) (Conexant CX7700)	√	√	√
	Integrated dual-array microphones with appropriate beam-forming, echo-cancellation, and noise suppression software	√	√	√
Support for voice recognition	√	√	√	
<b>Ethernet</b>	Integrated 10/100/1000 network interface card (NIC)	√	√	√
<b>Sensors</b>	Accelerometer	√	√	√
<b>Wireless</b>	Integrated wireless local area network (WLAN) options by way of wireless module	√	√	√
	Two built-in M.2 / PCIe WLAN antennas	√	√	√
	Support for the Intel Dual Band Wireless-AC 7265 802.11 ac 2×2 WiFi + Bluetooth 4.2 Combo Adapter WLAN module	√	√	√
	Compatible with MiraCast-certified devices	√	√	√
<b>External media cards</b>	Micro-Secure Digital (SD™) media reader slot	√	√	√

Category	Description	17-u200— 17-u299	17-u100— 17-u199	17-u000— 17-u099
	Push-push insertion/removal	√	√	√
<b>Ports</b>	Audio-in (mono microphone)/audio-out (stereo headphone) combination	√	√	√
	AC Smart Pin adapter plug	√	√	√
	HDMI v1.4 supporting up to 1920×1080 @ 60 Hz	√	√	√
	RJ-45 network	√	√	√
	USB 3.0 ports (3)	√	√	√
	USB 3.0 port Type-C	√	√	√
<b>Keyboard/pointing devices</b>	<b>Keyboard</b>	√	√	√
	Full-sized, backlit, island-style, keyboard with numeric keypad			
	<b>TouchPad</b>	√	√	√
	TouchPad requirements:			
	• ClickPad with image sensor	√	√	√
	• Multitouch gestures enabled	√	√	√
• Support for Windows modern trackpad gestures	√	√	√	
• Taps enabled as default	√	√	√	
<b>Power requirements</b>	<b>Batteries</b>	√	√	√
	3-cell, 61-WHr, 5.36-WHr, Li-ion battery			
	3-cell, 41-WHr, 3.63-WHr, Li-ion battery		√	√
	<b>AC adapters</b>	√		
	• 90-W HP Smart AC adapter (PFC, S-3P, 4.5-mm)			
	• 65W with duck head or duck head power cords	√	√	√
	<b>Power cord</b>	√	√	√
	1 meter			
1 meter duck head power cord	√	√	√	
<b>Security</b>	Trusted platform module (TPM) 2.0	√	√	√
	Security cable lock	√	√	√
<b>Operating system</b>	<b>Preinstalled:</b>	√	√	√
	Windows 10 and Windows 10 Professional	√	√	√
	<b>For Developed Market (ML):</b>	√	√	√
	Windows 10 Home Plus ML	√	√	√
	<b>For Emerging Market (EM/SL):</b>		√	√
	Windows 10 Home Plus EM/SL		√	√
<b>Serviceability</b>	<b>End user replaceable part:</b> AC adapter	√	√	√

## 2 Getting to know your computer

### Right side

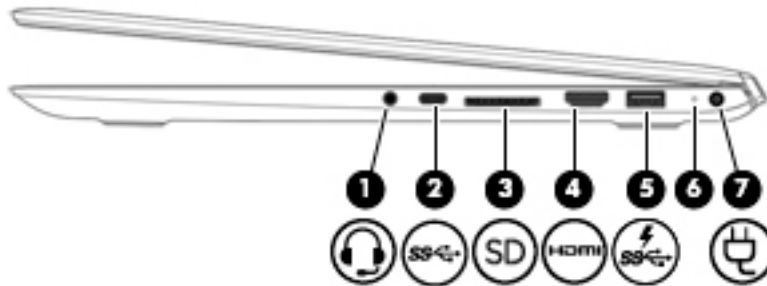

Component	Description
(1) Audio-out (headphone)/Audio-in (microphone) combo jack	<p>Connects optional powered stereo speakers, headphones, earbuds, a headset, or a television audio cable. Also connects an optional headset microphone. This jack does not support optional standalone microphones.</p> <p><b>WARNING!</b> To reduce the risk of personal injury, adjust the volume before putting on headphones, earbuds, or a headset. For additional safety information, refer to the <i>Regulatory, Safety, and Environmental Notices</i>.</p> <p>To access this guide:</p> <ul style="list-style-type: none"><li>▲ Select the <b>Start</b> button, select <b>HP Help and Support</b>, and then select <b>HP Documentation</b>.</li></ul> <p><b>NOTE:</b> When a device is connected to the jack, the computer speakers are disabled.</p>
(2) USB Type-C port	<p>Connects a USB device with a Type-C connector for high-speed data transfer.</p>
(3) Memory card reader	<p>Reads optional memory cards that enable you to store, manage, share, or access information.</p> <p>To insert a card:</p> <ol style="list-style-type: none"><li>1. Hold the card label-side up, with connectors facing the computer.</li><li>2. Insert the card into the memory card reader, and then press in on the card until it is firmly seated.</li></ol> <p>To remove a card:</p> <ul style="list-style-type: none"><li>▲ Press in on the card, and then remove it from the memory card reader.</li></ul>
(4) HDMI port	<p>Connects an optional video or audio device, such as a high-definition television, any compatible digital or audio component, or a high-speed High-Definition Multimedia Interface (HDMI) device.</p>
(5) USB 3.0 charging (powered) port	<p>Connects an optional USB device, such as a keyboard, mouse, external drive, printer, scanner or USB hub. Standard USB ports will not charge all USB devices or will charge using a low current. Some USB devices require power and require you to use a powered port.</p> <p><b>NOTE:</b> USB charging ports can also charge select models of cell phones and MP3 players, even when the computer is off.</p>

Component	Description
(6) AC adapter and battery light	<ul style="list-style-type: none"> <li>White: The AC adapter is connected and the battery is fully charged.</li> <li>Blinking white: The AC adapter is disconnected and the battery has reached a low battery level.</li> <li>Amber: The AC adapter is connected and the battery is charging.</li> <li>Off: The battery is not charging.</li> </ul>
(7) Power connector	Connects an AC adapter.

## Left side

 **NOTE:** Refer to the illustration that most closely matches your computer.

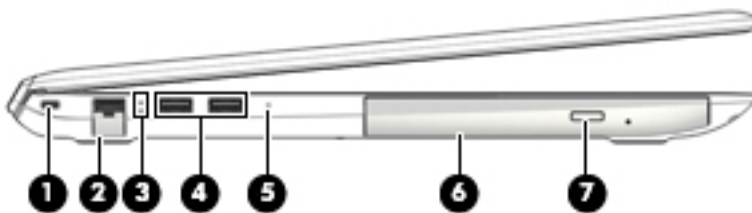

Component	Description
(1) Security cable slot	Attaches an optional security cable to the computer. <b>NOTE:</b> The security cable is designed to act as a deterrent, but it may not prevent the computer from being mishandled or stolen.
(2) RJ-45 (network) jack	Connects a network cable.
(3) RJ-45 (network) jack status lights	<ul style="list-style-type: none"> <li>White: The network is connected.</li> <li>Amber: Activity is occurring on the network.</li> </ul>
(4) USB 3.0 ports (2)	Connect optional USB devices, such as a keyboard, mouse, external drive, printer, scanner or USB hub.
(5) Drive light	<ul style="list-style-type: none"> <li>Blinking white: The hard drive is being accessed.</li> <li>Amber: HP 3D DriveGuard has temporarily parked the hard drive.</li> </ul>
(6) Optical drive	Depending on your computer, reads an optical disc or reads and writes to an optical disc.
(7) Optical drive eject button	Releases the optical disc drive tray.

# Display

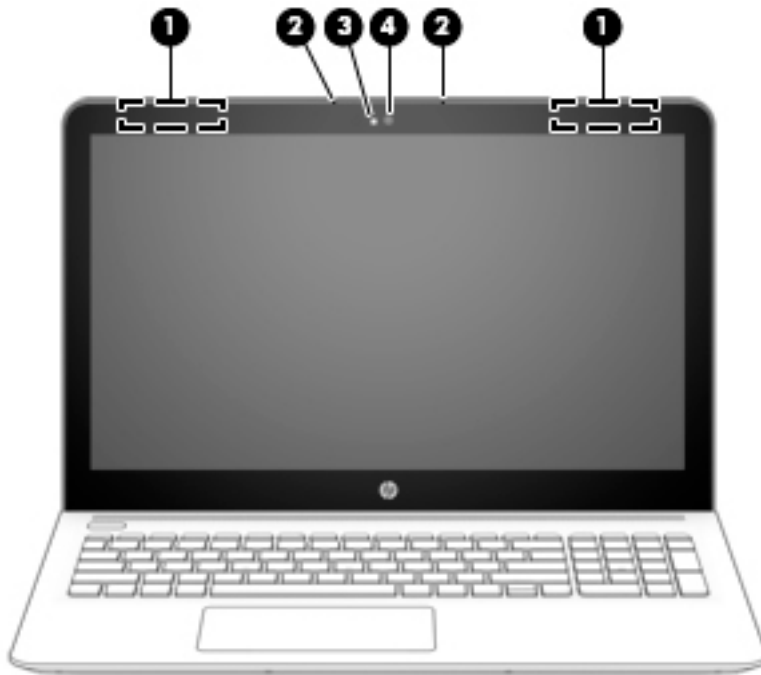

Component	Description
(1) WLAN antennas*	Send and receive wireless signals to communicate with wireless local area networks (WLANs).
(2) Internal microphones	Record sound.
(3) Camera lights	On: One or more cameras are in use.
(4) Camera(s)	Allow you to video chat, record video, and record still images. Some cameras also allow a facial recognition logon to Windows, instead of a password logon. <b>NOTE:</b> Camera functions vary depending on the camera hardware and software installed on your product.

\*The antennas are not visible from the outside of the computer, and the antenna location may vary. For optimal transmission, keep the areas immediately around the antennas free from obstructions.

For wireless regulatory notices, see the section of the *Regulatory, Safety, and Environmental Notices* that applies to your country or region.

To access this guide:

- ▲ Select the **Start** button, select **HP Help and Support**, and then select **HP Documentation**.

# Top

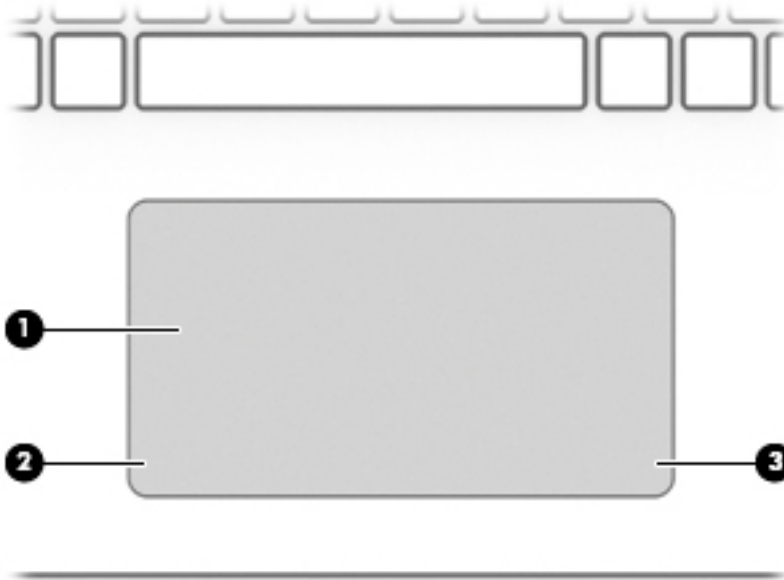

## TouchPad

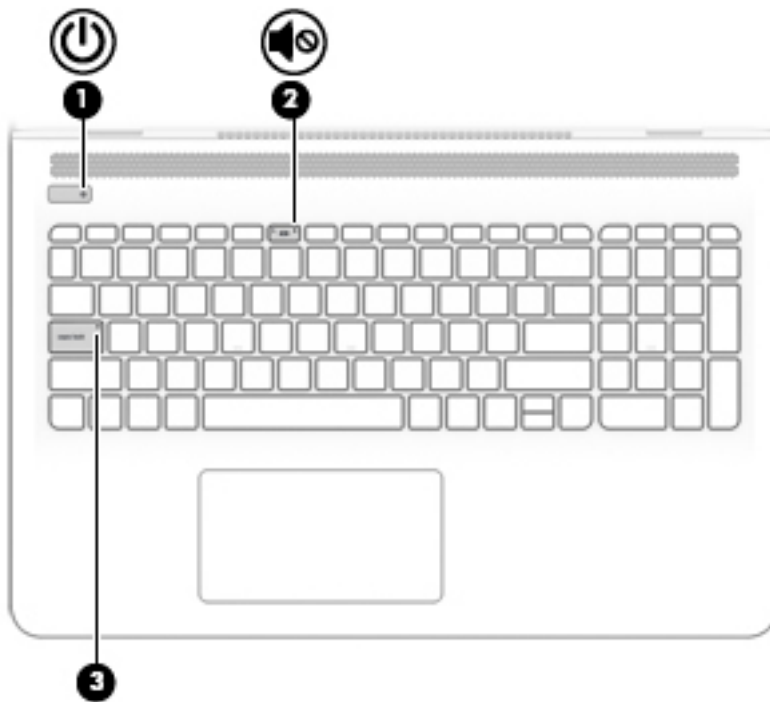

Component		Description
(1)	TouchPad zone	Reads your finger gestures to move the pointer or activate items on the screen.
(2)	Left TouchPad button	Functions like the left button on an external mouse.
(3)	Right TouchPad button	Functions like the right button on an external mouse.

## Lights





Component	Description
(1)  Power light	<ul style="list-style-type: none"><li>• On: The computer is on.</li><li>• Blinking: The computer is in the Sleep state, a power-saving state. The computer shuts off power to the display and other unneeded components.</li><li>• Off: The computer is off or in Hibernation. Hibernation is a power-saving state that uses the least amount of power.</li></ul>
(2)  Mute light	<ul style="list-style-type: none"><li>• Amber: Computer sound is off.</li><li>• Off: Computer sound is on.</li></ul>
(3) Caps lock light	On: Caps lock is on, which switches the key input to all capital letters.



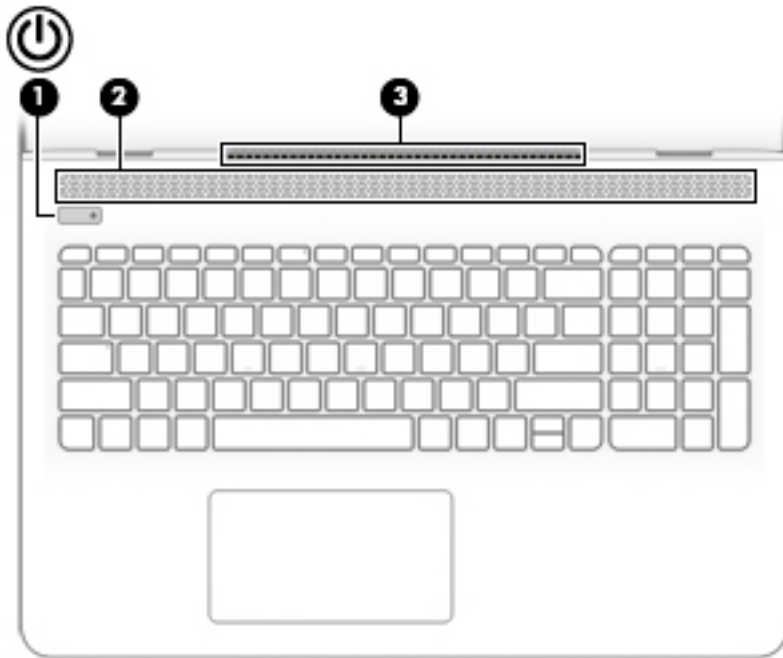

## Button, speakers, and vent

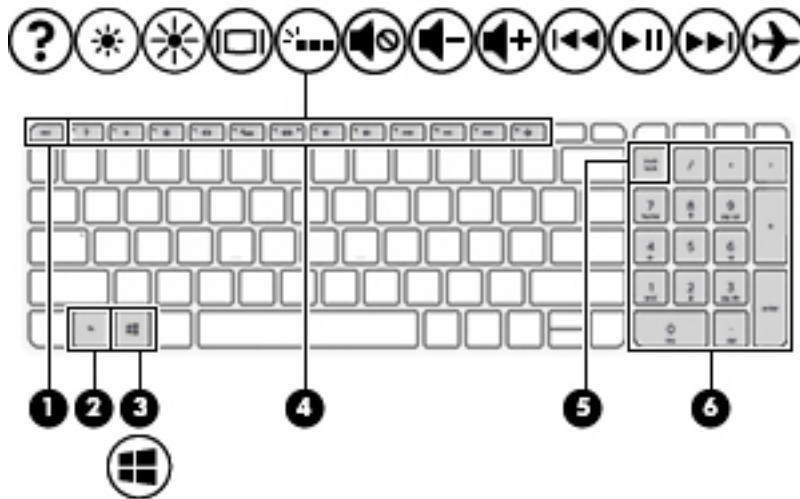

Component	Description
(1)  Power button	<ul style="list-style-type: none"> <li>When the computer is off, press the button to turn on the computer.</li> <li>When the computer is on, press the button briefly to initiate Sleep.</li> <li>When the computer is in the Sleep state, press the button briefly to exit Sleep.</li> <li>When the computer is in Hibernation, press the button briefly to exit Hibernation.</li> </ul> <p><b>CAUTION:</b> Pressing and holding down the power button results in the loss of unsaved information.</p> <p>If the computer has stopped responding and shutdown procedures are ineffective, press and hold the power button down for at least 5 seconds to turn off the computer.</p> <p>To learn more about your power settings, see your power options:</p> <ul style="list-style-type: none"> <li>▲ Right-click the <b>Power</b> icon , and then select <b>Power Options</b>.</li> </ul>
(2) Speakers	Produce sound.
(3) Vent	Enables airflow to cool internal components. <p><b>NOTE:</b> The computer fan starts up automatically to cool internal components and prevent overheating. It is normal for the internal fan to cycle on and off during routine operation.</p>

## Keys



Component	Description
(1) <span style="margin-left: 20px;">esc key</span>	Displays system information when pressed in combination with the <b>fn</b> key.
(2) <span style="margin-left: 20px;">fn key</span>	Executes specific functions when pressed in combination with the <b>esc</b> key.
(3) <span style="margin-left: 20px;">  Windows key         </span>	Opens the <b>Start</b> menu. <b>NOTE:</b> Pressing the Windows key again will close the <b>Start</b> menu.
(4) <span style="margin-left: 20px;">Action keys</span>	Execute frequently used system functions. <b>NOTE:</b> On select products, the <b>f5</b> action key turns the keyboard backlight feature off or on.
(5) <span style="margin-left: 20px;">num lock key</span>	Alternates between the navigational and numeric functions on the integrated numeric keypad.
(6) <span style="margin-left: 20px;">Integrated numeric keypad</span>	When <b>num lock</b> is on, the keypad can be used like an external numeric keypad.

## Bottom

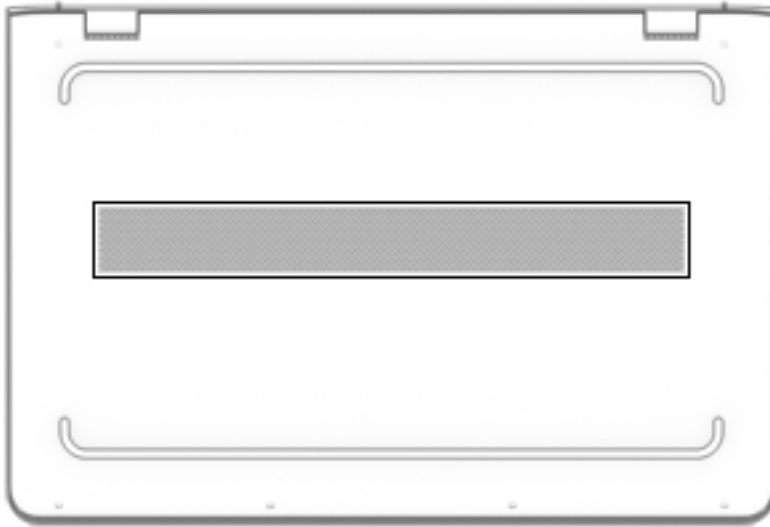

Component	Description
Vent	Enables airflow to cool internal components. <b>NOTE:</b> The computer fan starts up automatically to cool internal components and prevent overheating. It is normal for the internal fan to cycle on and off during routine operation.

# Labels

The labels affixed to the computer provide information you may need when you troubleshoot system problems or travel internationally with the computer.

 **IMPORTANT:** Check the following locations for the labels described in this section: the bottom of the computer, inside the battery bay, under the service door, or on the back of the display.

- **Service label**—Provides important information to identify your computer. When contacting support, you will probably be asked for the serial number, and possibly for the product number or the model number. Locate these numbers before you contact support.

Your service label will resemble one of the examples shown below. Refer to the illustration that most closely matches the service label on your computer.

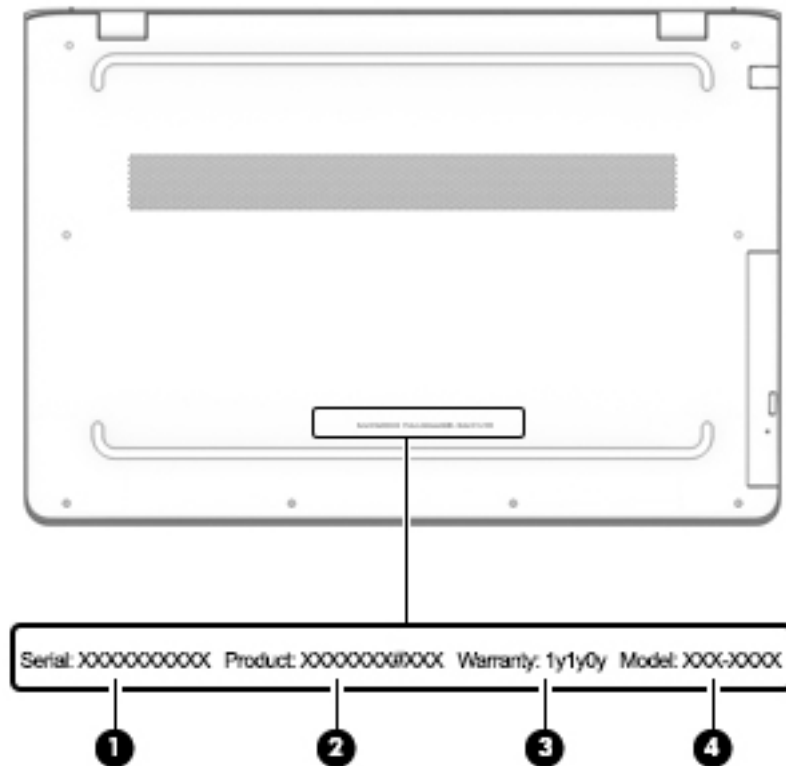

---

### Component

- 
- |     |                 |
|-----|-----------------|
| (1) | Serial number   |
| (2) | Product number  |
| (3) | Warranty period |
| (4) | Model number    |
- 

- **Regulatory label(s)**—Provide(s) regulatory information about the computer.
- **Wireless certification label(s)**—Provide(s) information about optional wireless devices and the approval markings for the countries or regions in which the devices have been approved for use.

# 3 Illustrated parts catalog

 **NOTE:** HP continually improves and changes product parts. For complete and current information on supported parts for your computer, go to <http://partsurfer.hp.com>, select your country or region, and then follow the on-screen instructions.

## Computer major components

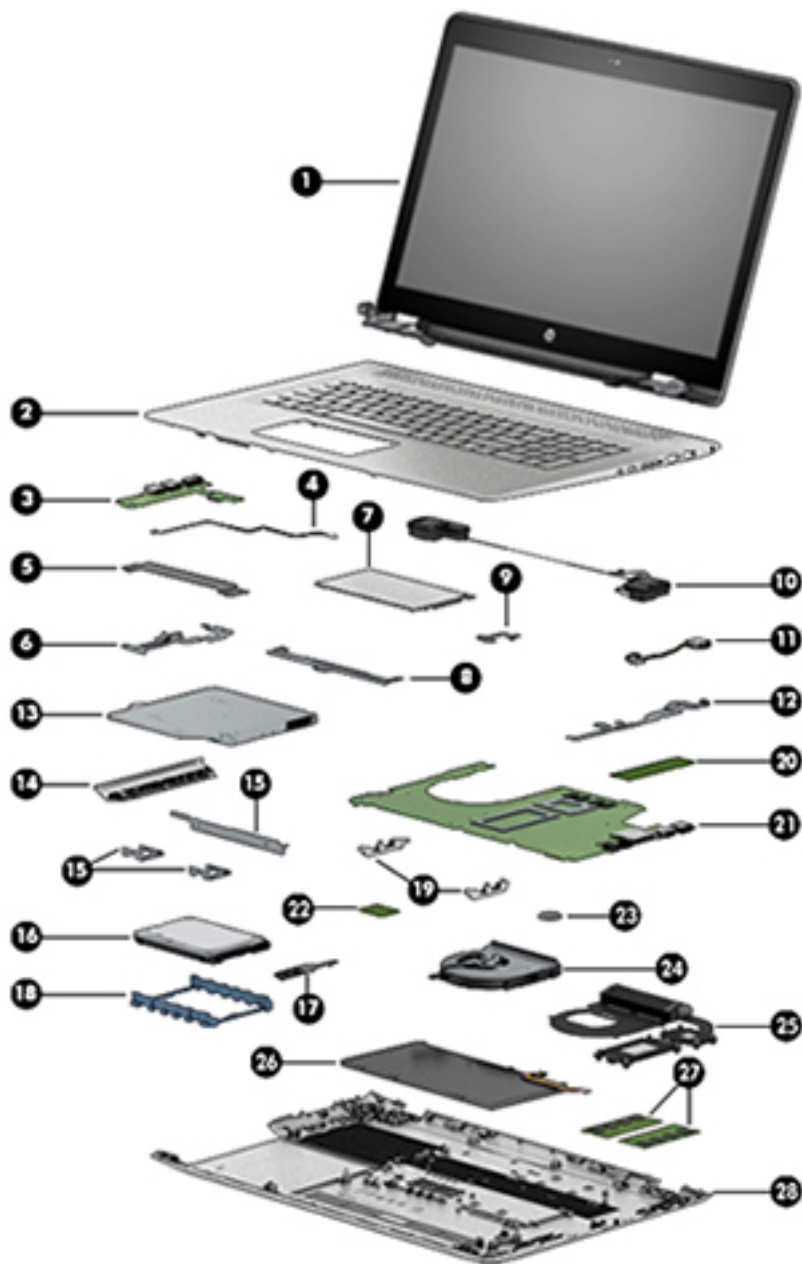

Item	Component	Spare part number
<b>(1)</b>	<b>Display assembly:</b> The display assembly is spared only as an entire assembly.	
	For use only on computer models with model numbers 17-u100 through 17-u199:	
	<ul style="list-style-type: none"> <li>17.3-in, UHD, WLED, AntiGlare (3840×2160), flat-flat (4.0-mm), UWVA, eDP+PSR, touch screen display assembly equipped with HDC and webcam</li> </ul>	857436-001
	<ul style="list-style-type: none"> <li>17.3-in, FHD, WLED, AntiGlare (1920×1080), flat-flat (4.0-mm), UWVA, eDP, touch screen display assembly equipped with HDC and webcam</li> </ul>	857435-001
	<ul style="list-style-type: none"> <li>17.3-in, UHD, WLED, AntiGlare (3840×2160), flat-flat (4.0-mm), UWVA, eDP+PSR non-touch scree, display assembly equipped with HDC and webcam</li> </ul>	933257-001
	<ul style="list-style-type: none"> <li>17.3-in, FHD, WLED, AntiGlare (1920×1080), flat-flat (4.0-mm), UWVA, eDP non-touch screen display assembly equipped with HDC and webcam</li> </ul>	933256-001
	For use on all computer models:	
	<ul style="list-style-type: none"> <li>17.3-in, UHD, WLED, AntiGlare (3840×2160), uslim-flat (2.68-mm), UWVA, eDP+PSR TouchScreen display assembly equipped with f3DC and webcam</li> </ul>	859440-001
	<ul style="list-style-type: none"> <li>17.3-in, FHD, WLED, BrightView (1920×1080), slim-flat (3.0-mm), UWVA, eDP TouchScreen display assembly equipped with f3DC and webcam</li> </ul>	859439-001
	For use only on computer models with model numbers 17-u200 through 17-u299:	
	<ul style="list-style-type: none"> <li>17.3-in, UHD, WLED, eDP+PSR, AntiGlare (3840×2160), flat-flat (4.0-mm), UWVA, TouchScreen display assembly equipped with HDC and IR webcam</li> </ul>	926687-001
	<ul style="list-style-type: none"> <li>17.3-in, FHD, WLED, eDP, AntiGlare (1920×1080), flat-flat (4.0-mm), UWVA, eDP TouchScreen display assembly equipped with HDC and IR webcam</li> </ul>	926686-001
	<ul style="list-style-type: none"> <li>17.3-in, UHD, WLED, AntiGlare (3840×2160), flat-flat (4.0-mm), UWVA, eDP+PSR non-touch scree, display assembly equipped with HDC and webcam</li> </ul>	933259-001
	<ul style="list-style-type: none"> <li>17.3-in, FHD, WLED, AntiGlare (1920×1080), flat-flat (4.0-mm), UWVA, eDP non-touch screen display assembly equipped with HDC and webcam</li> </ul>	933258-001
	<b>Display hinge covers</b> (2, not illustrated)	857831-001
<b>(2)</b>	<b>Keyboard/top cover</b> with backlight and pointing stick (includes backlight cable, keyboard cable, and pointing stick cable):	
	For use in Canada	857839-DB1
	For use in the United States	857839-001
<b>(3)</b>	<b>USB board</b> (includes USB board cable, USB board FFC cable, RJ45 jack, and 2 USB ports) for use in models with the following processors	
	<b>NOTE:</b> The USB board cable is also available using spare part number 857837-001. The USB board flexible folded cable (FFC) cable is also available using spare part number 857833-001.	
	For use in models with Intel Core i7-7500U and Intel Core i7-6500U processors	857823-001
	For use in models with Intel Core i7-8550U processors	L01126-001
<b>(4)</b>	<b>USB board cable</b>	857837-001
<b>(5)</b>	<b>USB board FFC cable</b>	857833-001
<b>(6)</b>	<b>USB board bracket</b> (not spared separately)	
<b>(7)</b>	<b>TouchPad</b>	857830-001

Item	Component	Spare part number
	<b>NOTE:</b> The TouchPad spare part kit does not include the TouchPad bracket or TouchPad cable. The TouchPad bracket is available using spare part number 857825-001. The TouchPad cable is available using spare part number 857836-001.	
(8)	<b>TouchPad bracket</b>	857825-001
(9)	<b>TouchPad cable</b> (includes double-sided adhesive)	857836-001
(10)	<b>Speakers</b> (includes left and right speakers and cables)	857834-001
(11)	<b>Power connector cable</b>	857437-001
(12)	<b>Power connector cable bracket</b> (not spared separately)	
(13)	<b>DVD±RW DL SuperMulti Drive</b>	857903-001
(14)	<b>Optical drive bezel</b>	857832-001
(15)	<b>Optical drive brackets</b> (3)	857827-001
(16)	<b>1-TB, 5400-rpm, SATA, 7.2-mm hard drive</b>	766457-856
	<b>NOTE:</b> The hard drive spare part kit does not include the hard drive rubber bracket or hard drive cable. The hard drive rubber bracket is available using spare part number 857826-001. The hard drive cable is available using spare part number 857835-001.	
(17)	<b>Hard drive cable</b> (includes double-sided adhesive)	857835-001
(18)	<b>Hard drive rubber bracket</b>	857826-001
	<b>I/O Bracket Kit</b> , includes:	857824-001
(19)	<b>System board support bridges</b> (2) (not spared)	
(20)	<b>Solid-state drive:</b>	
	512-GB, M2, SATA-3 solid-state drive supporting TLC	857899-001
	256-GB, M2, SATA-3 solid-state drive supporting TLC	857898-001
(21)	<b>System board:</b> Includes an nVIDIA N165-GTR-S (GeForce 940MX) graphics subsystem with 2048-MB of dedicated video memory, the processor, and replacement thermal material:	
	For use only on computer models with model numbers 17-u200 through 17-u299:	
	<ul style="list-style-type: none"> <li>Equipped with an Intel Core i7-8550U 1.80-GHz (SC turbo up to 4.00-GHz) processor (2400-MHz FSB, 8.0-MB L3 cache, dual core, 15-W), a hard drive connector, and the Windows 10 operating system</li> </ul>	924006-601
	<ul style="list-style-type: none"> <li>Equipped with an Intel Core i7-8550U 1.80-GHz (SC turbo up to 4.00-GHz) processor (2400-MHz FSB, 8.0-MB L3 cache, dual core, 15-W), a hard drive connector, and a non-Windows operating system</li> </ul>	924006-001
	<ul style="list-style-type: none"> <li>Equipped with an Intel Core i7-8550U 1.80-GHz (SC turbo up to 4.00-GHz) processor (2400-MHz FSB, 8.0-MB L3 cache, dual core, 15-W), a hard drive connector, and the Windows 10 operating system (for use in models with solid-state drives)</li> </ul>	924007-601
	<ul style="list-style-type: none"> <li>Equipped with an Intel Core i7-8550U 1.80-GHz (SC turbo up to 4.00-GHz) processor (2400-MHz FSB, 8.0-MB L3 cache, dual core, 15-W), a hard drive connector, and a non-Windows operating system (for use in models with solid-state drives)</li> </ul>	924007-001
	For use only on computer models with model numbers 17-u100 through 17-u199:	
	<ul style="list-style-type: none"> <li>Equipped with an Intel Core i7-7500U 2.70-GHz (SC turbo up to 3.50-GHz) processor (2133-MHz FSB, 4.0-MB L3 cache, dual core, 15-W), a hard drive connector, and the Windows 10 operating system</li> </ul>	859291-601

Item	Component	Spare part number
	<ul style="list-style-type: none"> <li>Equipped with an Intel Core i7-7500U 2.70-GHz (SC turbo up to 3.50-GHz) processor (2133-MHz FSB, 4.0-MB L3 cache, dual core, 15-W), a hard drive connector, and a non-Windows operating system</li> </ul>	859291-001
	<ul style="list-style-type: none"> <li>Equipped with an Intel Core i7-7500U 2.70-GHz (SC turbo up to 3.50-GHz) processor (2133-MHz FSB, 4.0-MB L3 cache, dual core, 15-W), a solid-state drive connector, and the Windows 10 operating system</li> </ul>	859292-601
	<ul style="list-style-type: none"> <li>Equipped with an Intel Core i7-7500U 2.70-GHz (SC turbo up to 3.50-GHz) processor (2133-MHz FSB, 4.0-MB L3 cache, dual core, 15-W), a solid-state drive connector, and a non-Windows operating system</li> </ul>	859292-001
	For use on all computer models:	
	<ul style="list-style-type: none"> <li>Equipped with an Intel Core i7-6500U 2.50-GHz (SC turbo up to 3.10-GHz) processor (1600-MHz FSB, 4.0-MB L3 cache, dual core, 15-W), a hard drive connector, and the Windows 10 operating system</li> </ul>	857297-601
	<ul style="list-style-type: none"> <li>Equipped with an Intel Core i7-6500U 2.50-GHz (SC turbo up to 3.10-GHz) processor (1600-MHz FSB, 4.0-MB L3 cache, dual core, 15-W), a hard drive connector, and a non-Windows operating system</li> </ul>	857297-001
	<ul style="list-style-type: none"> <li>Equipped with an Intel Core i7-6500U 2.50-GHz (SC turbo up to 3.10-GHz) processor (1600-MHz FSB, 4.0-MB L3 cache, dual core, 15-W), a solid-state drive connector, and the Windows 10 operating system</li> </ul>	857298-601
	<ul style="list-style-type: none"> <li>Equipped with an Intel Core i7-6500U 2.50-GHz (SC turbo up to 3.10-GHz) processor (1600-MHz FSB, 4.0-MB L3 cache, dual core, 15-W), a solid-state drive connector, and a non-Windows operating system</li> </ul>	857298-001
<b>(22)</b>	<b>WLAN modules</b>	
	Intel Dual Band Wireless-AC 7265 802.11 ac 2x2 WiFi + Bluetooth 4.2 Combo Adapter (non vPro) (D0)	793747-856
	Intel Dual Band Wireless-AC 7265 802.11 ac 2x2 WiFi + Bluetooth 4.2 Combo Adapter (non vPro) (D1)	901229-857
<b>(23)</b>	<b>RTC battery</b>	857828-001
<b>(24)</b>	<b>Fan</b> (includes cable)	862193-001
<b>(25)</b>	<b>Heat sink</b> (includes replacement thermal material)	857299-001
<b>(26)</b>	<b>Battery</b> (includes cable):	
	3-cell, 61-WHr, 5.36-WHr, Li-ion	849315-856
	3-cell, 41-WHr, 3.63-WHr, Li-ion	849314-856
<b>(27)</b>	<b>Memory modules (2):</b>	
	For use in models with an Intel Core i7-7500U or Intel Core i7-6500U processor	
	<ul style="list-style-type: none"> <li>8-GB (2133, 1.2-V, DDR4)</li> </ul>	820448-857
	<ul style="list-style-type: none"> <li>4-GB (2133, 1.2-V, DDR4)</li> </ul>	820447-857
	For use in models with an Intel Core i7-8550U processor	
	<ul style="list-style-type: none"> <li>8-GB (2400, 1.2-V, DDR4)</li> </ul>	862398-856
	<ul style="list-style-type: none"> <li>4-GB (2400, 1.2-V, DDR4)</li> </ul>	862397-856



Item	Component	Spare part number
(28)	<b>Bottom cover</b> (includes front rubber foot strip, RJ45 cover, shielding, and vents)	857829-001
	<b>Rubber Kit</b> (not illustrated; includes bottom cover rubber foot strip):	905983-001

## Optical drive components

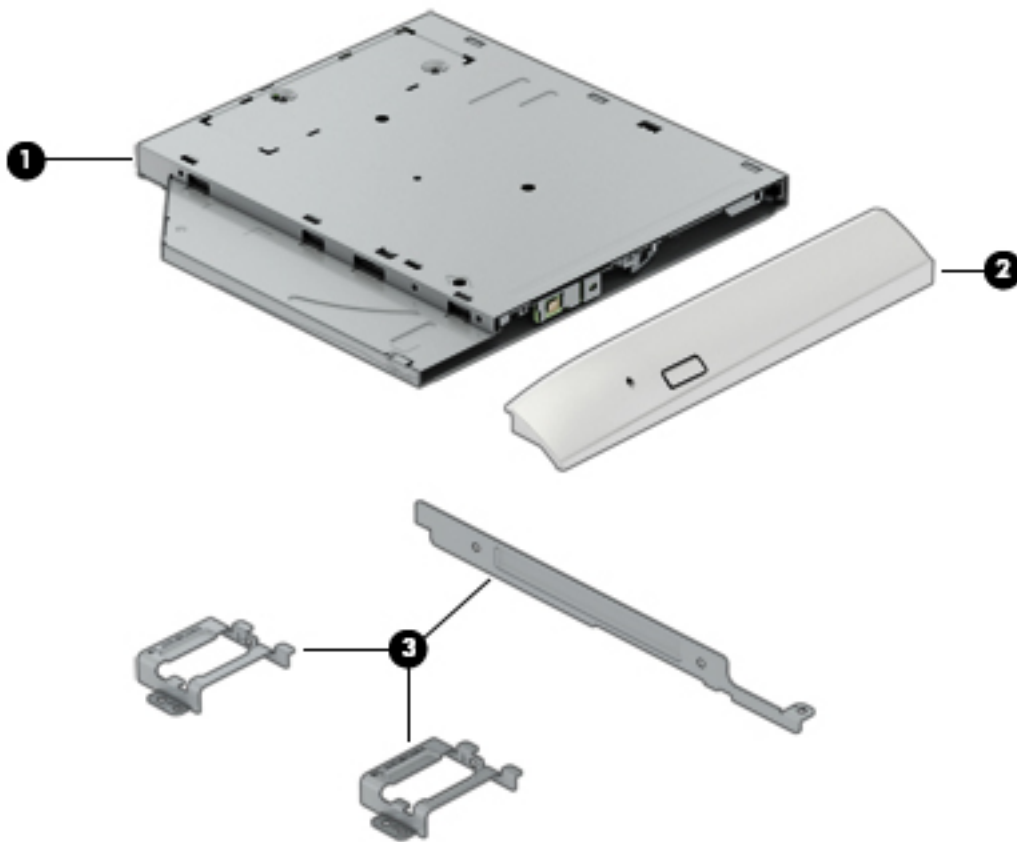

Item	Component	Spare part number
(1)	<b>DVD±RW DL SuperMulti Drive</b>	857903-001
(2)	<b>Optical drive bezel</b>	857832-001
(3)	<b>Optical drive brackets (3)</b>	857827-001

## Miscellaneous parts

Component	Spare part number
<b>AC adapter:</b>	
90-W HP Smart AC adapter (PFC, S-3P, 4.5-mm)	710413-001
65-W HP Smart AC adapter (non-PFC, S-3P, 4.5-mm)	710412-001
65-W HP Smart AC adapter (non-PFC, with mount, 4.5-mm)	854117-850
<b>Adapters:</b>	
HP HDMI-to-VGA adapter	701943-001
HP USB-Type C-to-USB 3.0 adapter	814618-001
<b>Power cord for use in North America</b> (C5 receptacle, 1.00-m (3.2-ft), 3-wire conductor):	
For use only on computer models with model numbers 17-u100—17-u199 and 17-u100—17-u199	213349-015
For use with all computer models	213349-009
<b>Screw Kit</b>	857838-001

---

## 4 Removal and replacement procedures preliminary requirements

### Tools required

You will need the following tools to complete the removal and replacement procedures:

- Case utility tool or similar plastic, flat-edged tool
- Flat-bladed screwdriver
- Magnetic screwdriver
- Phillips P00, P0, and P1 screwdrivers
- Torx T4 screwdriver

### Service considerations

The following sections include some of the considerations that you must keep in mind during disassembly and assembly procedures.



**NOTE:** As you remove each subassembly from the computer, place the subassembly (and all accompanying screws) away from the work area to prevent damage.

---

### Plastic parts



**CAUTION:** Using excessive force during disassembly and reassembly can damage plastic parts. Use care when handling the plastic parts. Apply pressure only at the points designated in the maintenance instructions.

---

## Cables and connectors

---

**⚠ CAUTION:** When servicing the computer, be sure that cables are placed in their proper locations during the reassembly process. Improper cable placement can damage the computer.

---

Cables must be handled with extreme care to avoid damage. Apply only the tension required to unseat or seat the cables during removal and insertion. Handle cables by the connector whenever possible. In all cases, avoid bending, twisting, or tearing cables. Be sure that cables are routed in such a way that they cannot be caught or snagged by parts being removed or replaced. Handle flex cables with extreme care; these cables tear easily.

## Drive handling

---

**⚠ CAUTION:** Drives are fragile components that must be handled with care. To prevent damage to the computer, damage to a drive, or loss of information, observe these precautions:

Before removing or inserting a hard drive, shut down the computer. If you are unsure whether the computer is off or in Hibernation, turn the computer on, and then shut it down through the operating system.

Before handling a drive, be sure that you are discharged of static electricity. While handling a drive, avoid touching the connector.

Before removing a diskette drive or optical drive, be sure that a diskette or disc is not in the drive and be sure that the optical drive tray is closed.

Handle drives on surfaces covered with at least one inch of shock-proof foam.

Avoid dropping drives from any height onto any surface.

Avoid exposing an internal hard drive to products that have magnetic fields, such as monitors or speakers.

Avoid exposing an internal hard drive to products that have magnetic fields, such as monitors or speakers.

Avoid exposing a drive to temperature extremes or liquids.

If a drive must be mailed, place the drive in a bubble pack mailer or other suitable form of protective packaging and label the package "FRAGILE."

---

# Grounding guidelines

## Electrostatic discharge damage

Electronic components are sensitive to electrostatic discharge (ESD). Circuitry design and structure determine the degree of sensitivity. Networks built into many integrated circuits provide some protection, but in many cases, ESD contains enough power to alter device parameters or melt silicon junctions.

A discharge of static electricity from a finger or other conductor can destroy static-sensitive devices or microcircuitry. Even if the spark is neither felt nor heard, damage may have occurred.

An electronic device exposed to ESD may not be affected at all and can work perfectly throughout a normal cycle. Or the device may function normally for a while, then degrade in the internal layers, reducing its life expectancy.

**CAUTION:** To prevent damage to the computer when you are removing or installing internal components, observe these precautions:

Keep components in their electrostatic-safe containers until you are ready to install them.

Before touching an electronic component, discharge static electricity by using the guidelines described in this section.

Avoid touching pins, leads, and circuitry. Handle electronic components as little as possible.

If you remove a component, place it in an electrostatic-safe container.

The following table shows how humidity affects the electrostatic voltage levels generated by different activities.

**CAUTION:** A product can be degraded by as little as 700 V.

Typical electrostatic voltage levels			
Event	Relative humidity		
	10%	40%	55%
Walking across carpet	35,000 V	15,000 V	7,500 V
Walking across vinyl floor	12,000 V	5,000 V	3,000 V
Motions of bench worker	6,000 V	800 V	400 V
Removing DIPS from plastic tube	2,000 V	700 V	400 V
Removing DIPS from vinyl tray	11,500 V	4,000 V	2,000 V
Removing DIPS from Styrofoam	14,500 V	5,000 V	3,500 V
Removing bubble pack from PCB	26,500 V	20,000 V	7,000 V
Packing PCBs in foam-lined box	21,000 V	11,000 V	5,000 V

## Packaging and transporting guidelines

Follow these grounding guidelines when packaging and transporting equipment:

- To avoid hand contact, transport products in static-safe tubes, bags, or boxes.
- Protect ESD-sensitive parts and assemblies with conductive or approved containers or packaging.
- Keep ESD-sensitive parts in their containers until the parts arrive at static-free workstations.
- Place items on a grounded surface before removing items from their containers.
- Always be properly grounded when touching a component or assembly.
- Store reusable ESD-sensitive parts from assemblies in protective packaging or nonconductive foam.
- Use transporters and conveyors made of antistatic belts and roller bushings. Be sure that mechanized equipment used for moving materials is wired to ground and that proper materials are selected to avoid static charging. When grounding is not possible, use an ionizer to dissipate electric charges.

## Workstation guidelines

Follow these grounding workstation guidelines:

- Cover the workstation with approved static-shielding material.
- Use a wrist strap connected to a properly grounded work surface and use properly grounded tools and equipment.
- Use conductive field service tools, such as cutters, screwdrivers, and vacuums.
- When fixtures must directly contact dissipative surfaces, use fixtures made only of static safe materials.
- Keep the work area free of nonconductive materials, such as ordinary plastic assembly aids and Styrofoam.
- Handle ESD-sensitive components, parts, and assemblies by the case or PCM laminate. Handle these items only at static-free workstations.
- Avoid contact with pins, leads, or circuitry.
- Turn off power and input signals before inserting or removing connectors or test equipment.

## Equipment guidelines

Grounding equipment must include either a wrist strap or a foot strap at a grounded workstation.

- When seated, wear a wrist strap connected to a grounded system. Wrist straps are flexible straps with a minimum of one megohm  $\pm 10\%$  resistance in the ground cords. To provide proper ground, wear a strap snugly against the skin at all times. On grounded mats with banana-plug connectors, use alligator clips to connect a wrist strap.
- When standing, use foot straps and a grounded floor mat. Foot straps (heel, toe, or boot straps) can be used at standing workstations and are compatible with most types of shoes or boots. On conductive floors or dissipative floor mats, use foot straps on both feet with a minimum of one megohm resistance between the operator and ground. To be effective, the conductive must be worn in contact with the skin.

The following grounding equipment is recommended to prevent electrostatic damage:

- Antistatic tape
- Antistatic smocks, aprons, and sleeve protectors
- Conductive bins and other assembly or soldering aids
- Nonconductive foam
- Conductive computerop workstations with ground cords of one megohm resistance
- Static-dissipative tables or floor mats with hard ties to the ground
- Field service kits
- Static awareness labels
- Material-handling packages
- Nonconductive plastic bags, tubes, or boxes
- Metal tote boxes
- Electrostatic voltage levels and protective materials

The following table lists the shielding protection provided by antistatic bags and floor mats.

Material	Use	Voltage protection level
Antistatic plastics	Bags	1,500 V
Carbon-loaded plastic	Floor mats	7,500 V
Metallized laminate	Floor mats	5,000 V

---

# 5 Removal and replacement procedures

 **CAUTION:** Components described in this chapter should only be accessed by an authorized service provider. Accessing these parts can damage the computer or void the warranty.

---

## Component replacement procedures

 **NOTE:** Details about the computer, including product number, warranty information, model number, and serial number, are included on the service tag on the bottom of the computer. See [Labels on page 12](#) for details.

---

This chapter provides removal and replacement procedures.

There are as many as 74 screws that must be removed, replaced, and/or loosened when servicing the computer. Make special note of each screw size and location during removal and replacement.

### Bottom cover

Description	Spare part number
Bottom cover (includes front rubber foot strip, RJ45 cover, shielding, and vents)	857829-001

Before disassembling the computer, follow these steps:

1. Turn off the computer. If you are unsure whether the computer is off or in Hibernation, turn the computer on, and then shut it down through the operating system.
2. Disconnect the power from the computer by unplugging the power cord from the computer.
3. Disconnect all external devices from the computer.

Remove the bottom cover:

1. Close the computer.
2. Turn the computer upside down with the front toward you.
3. Remove the rear rubber foot strip **(1)**.

The rear rubber foot strip is included in the Rubber Kits, spare part numbers 905983-001.



4. Remove the following screws that secure the bottom cover to the computer:
  - (2) Four Torx5 M2.0×11.9 screws
  - (3) Seven Torx5 M2.0×5.8 screws

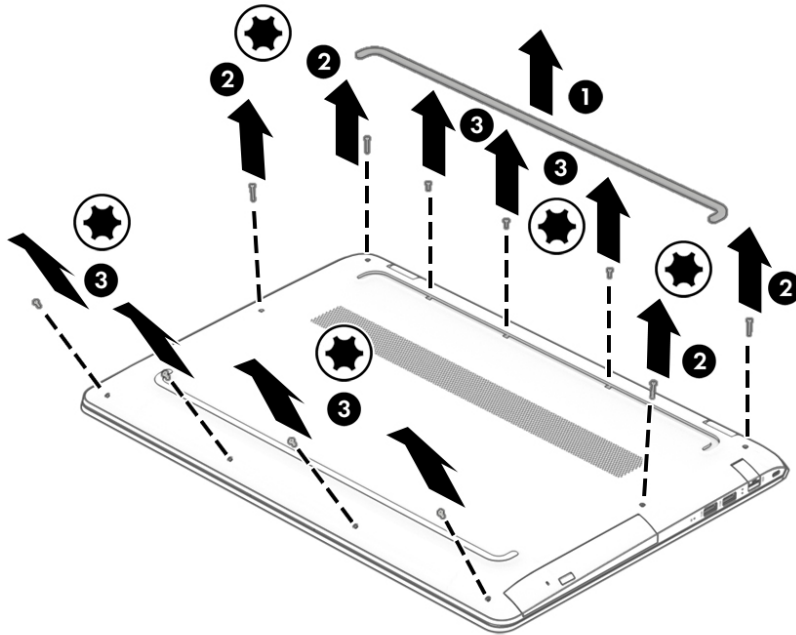

5. Insert a case utility tool (1) or similar plastic, flat-edged tool between the bottom cover and the computer near the display hinge areas.
6. Release the bottom cover rear edge (2) and swing it up and forward until it releases.
7. Remove the bottom cover (3).

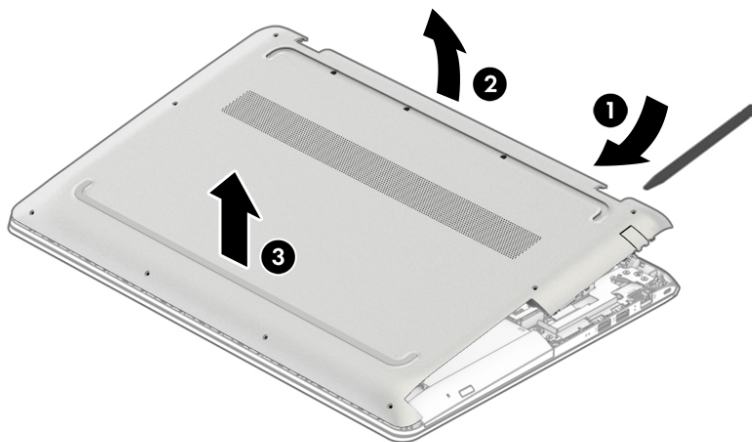

Reverse this procedure to install the bottom cover.

## Battery

 **NOTE:** The battery spare part kit includes the battery cable.

Description	Spare part number
3-cell, 61-WHr, 5.36-WHr, Li-ion	849315-856
3-cell, 41-WHr, 3.63-WHr, Li-ion	849314-856

Before removing the battery, follow these steps:

1. Turn off the computer. If you are unsure whether the computer is off or in Hibernation, turn the computer on, and then shut it down through the operating system.
2. Disconnect the power from the computer by unplugging the power cord from the computer.
3. Disconnect all external devices from the computer.
4. Remove the bottom cover (see [Bottom cover on page 24](#)).

Remove the battery:

1. Disconnect the battery cable **(1)** from the system board.
2. Remove the four Phillips M2.0×4.8 screws **(2)** that secure the battery to the keyboard/top cover.
3. Remove the battery **(3)**.

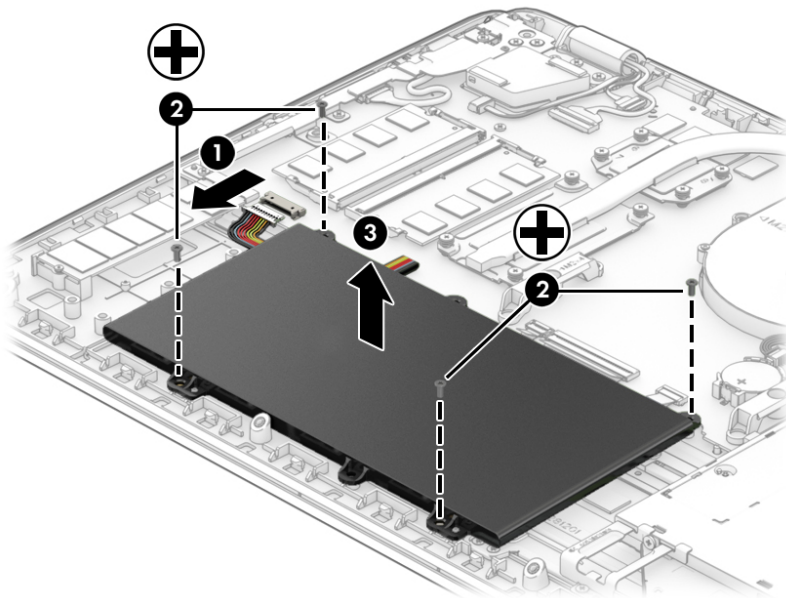

Reverse this procedure to install the battery.

## Solid-state drive

Description	Spare part number
512-GB, M2, SATA-3 solid-state drive supporting TLC	857899-001
256-GB, M2, SATA-3 solid-state drive supporting TLC	857898-001

Before removing the solid-state drive, follow these steps:

1. Turn off the computer. If you are unsure whether the computer is off or in Hibernation, turn the computer on, and then shut it down through the operating system.
2. Disconnect the power from the computer by unplugging the power cord from the computer.
3. Disconnect all external devices from the computer.
4. Remove the bottom cover (see [Bottom cover on page 24](#)).
5. Disconnect the battery cable from the system board (see [Battery on page 26](#)).

Remove the solid-state drive:

1. Remove the Phillips M2.0×3.7 screw **(1)** that secures the solid-state drive to the computer. (The solid-state drive tilts up.)
2. Remove the solid-state drive **(2)** by pulling the drive away from the slot at an angle.

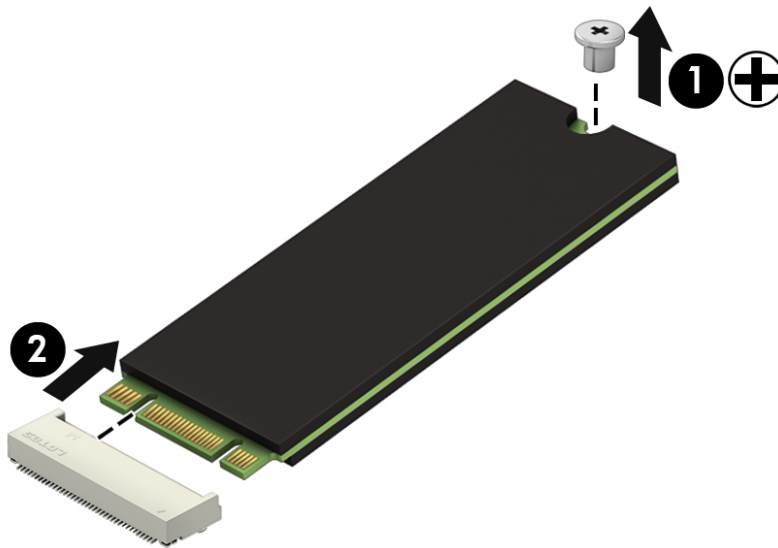

Reverse this procedure to install the solid-state drive.

## TouchPad cable

Description	Spare part number
TouchPad cable (includes double-sided adhesive)	857836-001

Before removing the TouchPad cable, follow these steps:

1. Turn off the computer. If you are unsure whether the computer is off or in Hibernation, turn the computer on, and then shut it down through the operating system.
2. Disconnect the power from the computer by unplugging the power cord from the computer.
3. Disconnect all external devices from the computer.
4. Remove the bottom cover (see [Bottom cover on page 24](#)).
5. Disconnect the battery cable from the system board (see [Battery on page 26](#)).

Remove the TouchPad cable:

1. Release the ZIF connector **(1)** to which the TouchPad cable is connected, and then disconnect the TouchPad cable from the system board.
2. Release the ZIF connector **(2)** to which the TouchPad cable is connected, and then disconnect the TouchPad cable from the TouchPad board.
3. Detach the TouchPad cable **(3)** from the TouchPad. (The TouchPad cable is attached to the TouchPad with double-sided adhesive.)
4. Remove the TouchPad cable **(4)**.

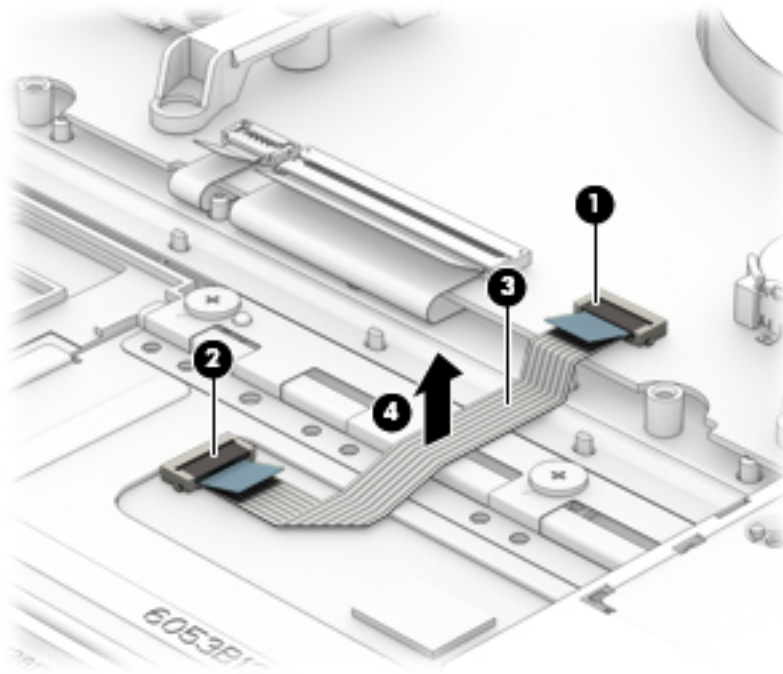

Reverse this procedure to install the TouchPad cable.

## Memory module

Description	Spare part number
<b>For use in models with an Intel Core i7-7500U or Intel Core i7-6500U processor</b>	
8-GB (2133, 1.2-V, DDR4)	820448-857
4-GB (2133, 1.2-V, DDR4)	820447-857
<b>For use in models with an Intel Core i7-8550U processor</b>	
8-GB (2400, 1.2-V, DDR4)	862398-856
4-GB (2400, 1.2-V, DDR4)	862397-856

Before removing a memory module, follow these steps:

1. Turn off the computer. If you are unsure whether the computer is off or in Hibernation, turn the computer on, and then shut it down through the operating system.
2. Disconnect the power from the computer by unplugging the power cord from the computer.
3. Disconnect all external devices from the computer.
4. Remove the bottom cover (see [Bottom cover on page 24](#)).
5. Disconnect the battery cable from the system board (see [Battery on page 26](#)).

Remove the memory module:

1. Spread the retaining tabs **(1)** on each side of the memory module slot to release the memory module. (The memory module tilts up.)
2. Remove the memory module **(2)** by pulling it away from the slot at an angle.

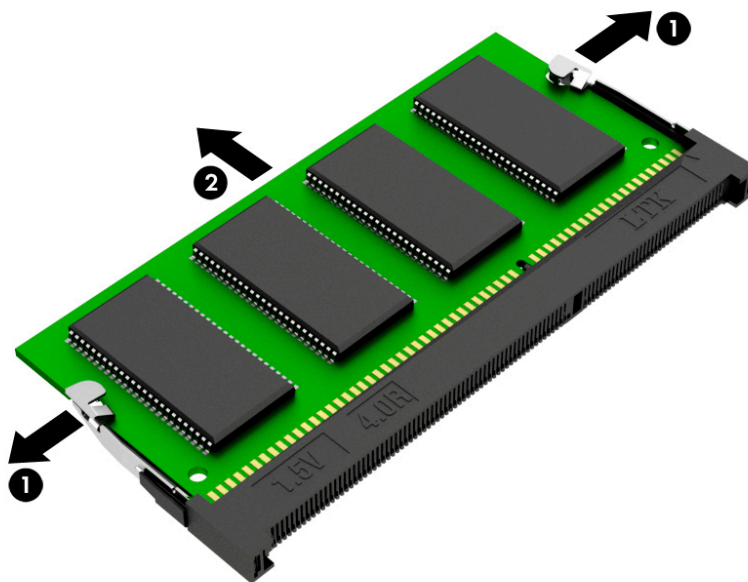

Reverse this procedure to install a memory module.

## RTC battery

Description	Spare part number
RTC battery	857828-001

Before removing the USB board, follow these steps:

1. Turn off the computer. If you are unsure whether the computer is off or in Hibernation, turn the computer on, and then shut it down through the operating system.
2. Disconnect the power from the computer by unplugging the power cord from the computer.
3. Disconnect all external devices from the computer.
4. Remove the bottom cover (see [Bottom cover on page 24](#)).
5. Disconnect the battery cable from the system board (see [Battery on page 26](#)).

Remove the RTC battery:

1. Insert a case utility tool **(1)** or similar plastic, flat-edged tool into the RTC battery socket.
2. Remove the RTC battery **(2)** from the RTC battery socket.

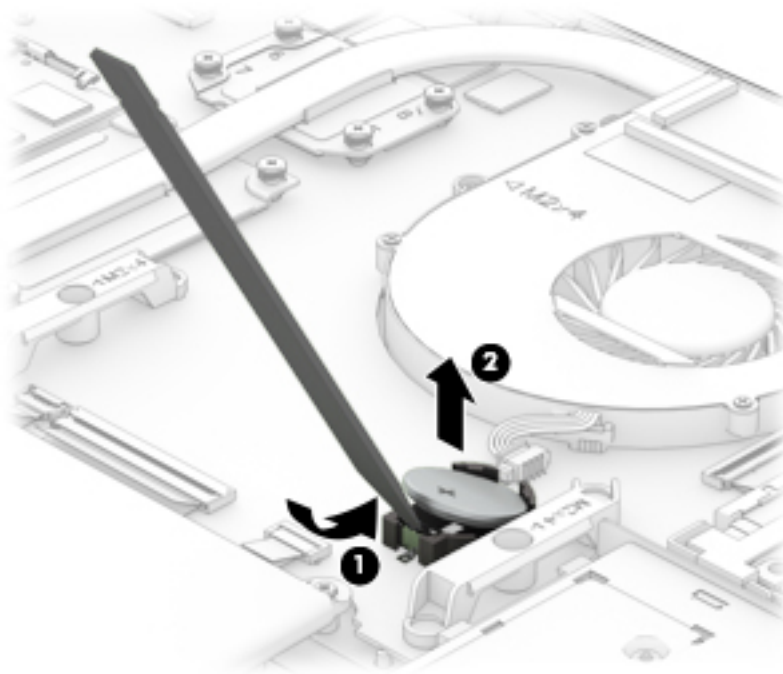

3. Remove the RTC battery.

Reverse this procedure to install the RTC battery.

## Hard drive

Description	Spare part number
1-TB, 5400-rpm, SATA, 7.2-mm hard drive	766457-856
<b>NOTE:</b> The hard drive spare part kit does not include the hard drive rubber bracket or hard drive cable. The hard drive rubber bracket is available using spare part number 857826-001. The hard drive cable is available using spare part number 857835-001.	

Before removing the hard drive, follow these steps:

1. Turn off the computer. If you are unsure whether the computer is off or in Hibernation, turn the computer on, and then shut it down through the operating system.
2. Disconnect the power from the computer by unplugging the power cord from the computer.
3. Disconnect all external devices from the computer.
4. Remove the bottom cover (see [Bottom cover on page 24](#)).
5. Disconnect the battery cable from the system board (see [Battery on page 26](#)).

Remove the hard drive:

1. Release the zero insertion force (ZIF) connector **(1)** to which the hard drive cable is connected, and then disconnect the hard drive cable **(2)** from the system board.
2. Lift the right side of the hard drive **(3)** until it rests at an angle.
3. Remove the hard drive **(4)**.

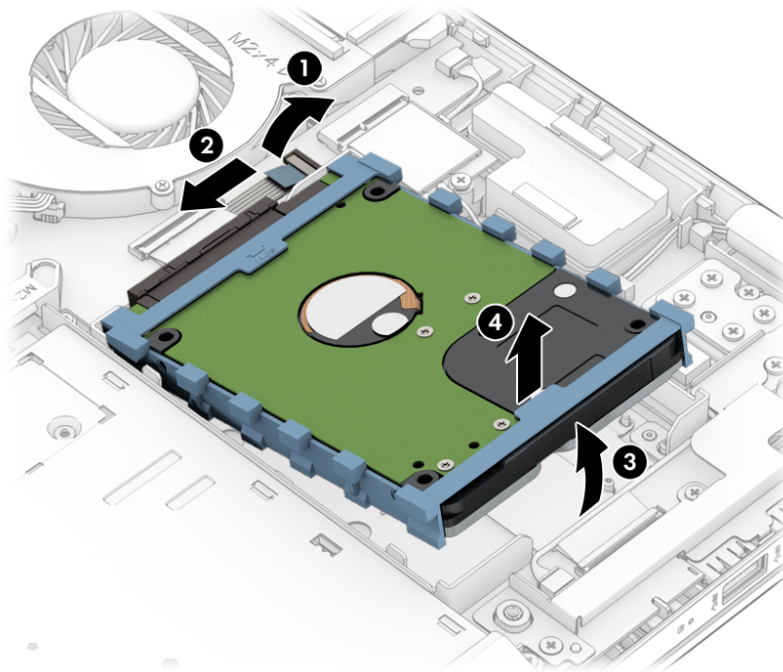

4. If it is necessary to replace the hard drive cable, disconnect the cable **(1)** from the hard drive.

5. If it is necessary to replace the hard drive rubber bracket, release the left and right sides (2) of the bracket from the hard drive, and then remove the bracket (3).

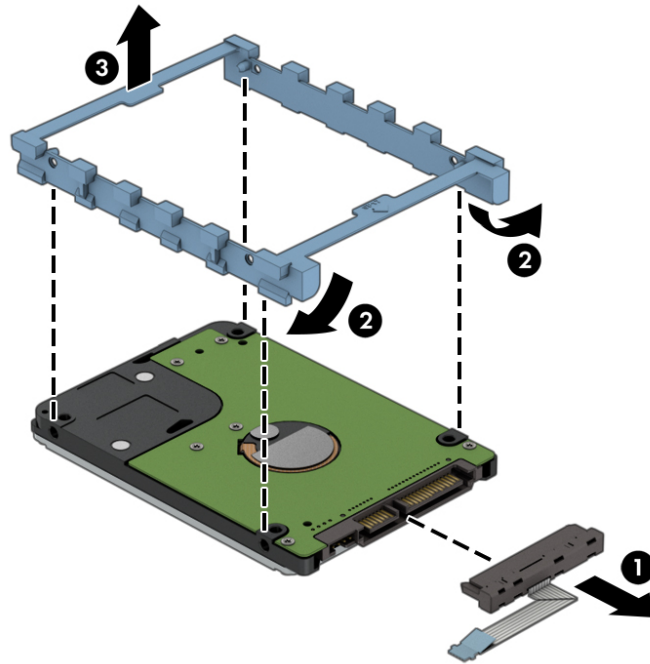

Reverse this procedure to reassemble and install the hard drive.



## WLAN module

Description	Spare part number
Intel Dual Band Wireless-AC 7265 802.11 ac 2×2 WiFi + Bluetooth 4.2 Combo Adapter (non-vPro) (D0)	793747-856
Intel Dual Band Wireless-AC 7265 802.11 ac 2×2 WiFi + Bluetooth 4.2 Combo Adapter (non-vPro) (D1)	901229-857

 **CAUTION:** To prevent an unresponsive system, replace the wireless module only with a wireless module authorized for use in the computer by the governmental agency that regulates wireless devices in your country or region. If you replace the module and then receive a warning message, remove the module to restore device functionality, and then contact technical support.

Before removing the WLAN module, follow these steps:

1. Turn off the computer. If you are unsure whether the computer is off or in Hibernation, turn the computer on, and then shut it down through the operating system.
2. Disconnect the power from the computer by unplugging the power cord from the computer.
3. Disconnect all external devices from the computer.
4. Remove the bottom cover (see [Bottom cover on page 24](#)).
5. Disconnect the battery cable from the system board (see [Battery on page 26](#)).

Remove the WLAN module:

1. Disconnect the WLAN antenna cables **(1)** from the terminals on the WLAN module.



**NOTE:** The WLAN antenna cable labeled “1/MAIN” connects to the WLAN module “Main” terminal. The WLAN antenna cable labeled “2/AUX” connects to the WLAN module “Aux” terminal.

2. Remove the Phillips M2.0×2.7 screw **(2)** that secures the WLAN module to the computer. (The WLAN module tilts up.)

3. Remove the WLAN module (3) by pulling the module away from the slot at an angle.

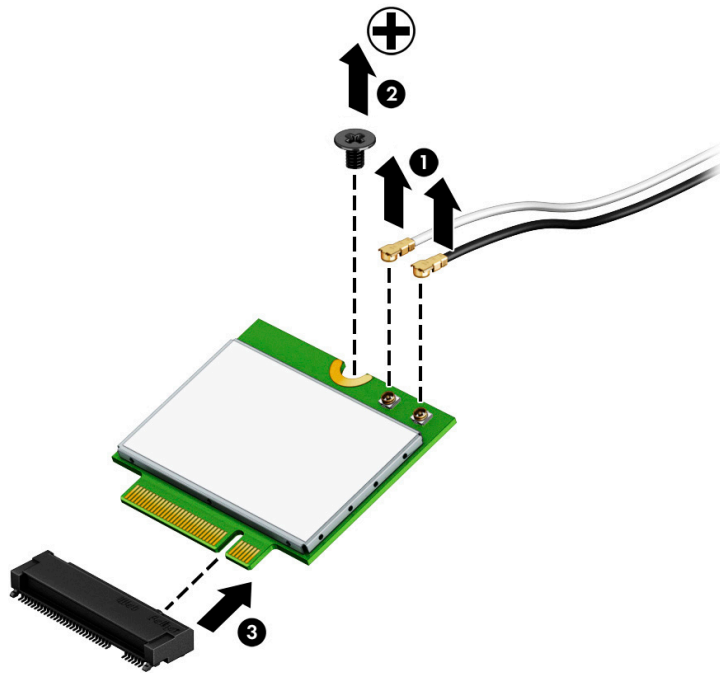

**NOTE:** If the WLAN antenna cables are not connected to the WLAN module terminal, the protective sleeves should be installed on the antenna connectors, as shown in the following illustration.

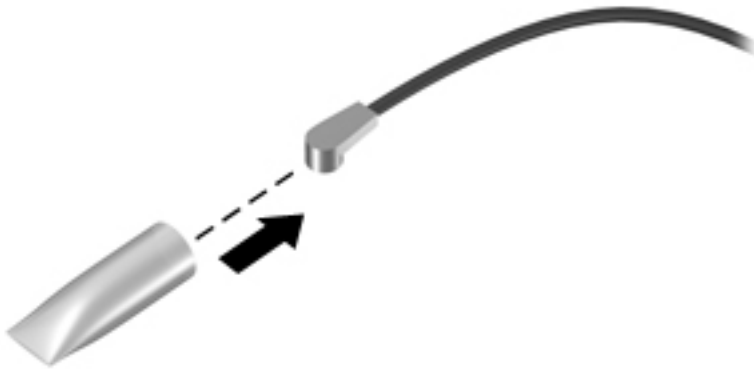

Reverse this procedure to install the WLAN module.

## Optical drive



**NOTE:** The optical drive spare part kit does not include the optical drive bezel or optical drive brackets. The optical drive bezel is available using spare part number 857832-001. The optical drive brackets are available using spare part number 857827-001.

Description	Spare part number
DVD±RW DL SuperMulti Drive	857903-001

Before removing the optical drive, follow these steps:

1. Turn off the computer. If you are unsure whether the computer is off or in Hibernation, turn the computer on, and then shut it down through the operating system.
2. Disconnect the power from the computer by unplugging the power cord from the computer.
3. Disconnect all external devices from the computer.
4. Remove the bottom cover (see [Bottom cover on page 24](#)).
5. Disconnect the battery cable from the system board (see [Battery on page 26](#)).

Remove the optical drive:

1. Remove the four Phillips M2.0×3.0 screws **(1)** that secure the optical drive to the keyboard/top cover.
2. Disconnect the optical drive **(2)** from the system board by sliding it to the left.
3. Remove the hard drive **(3)**.

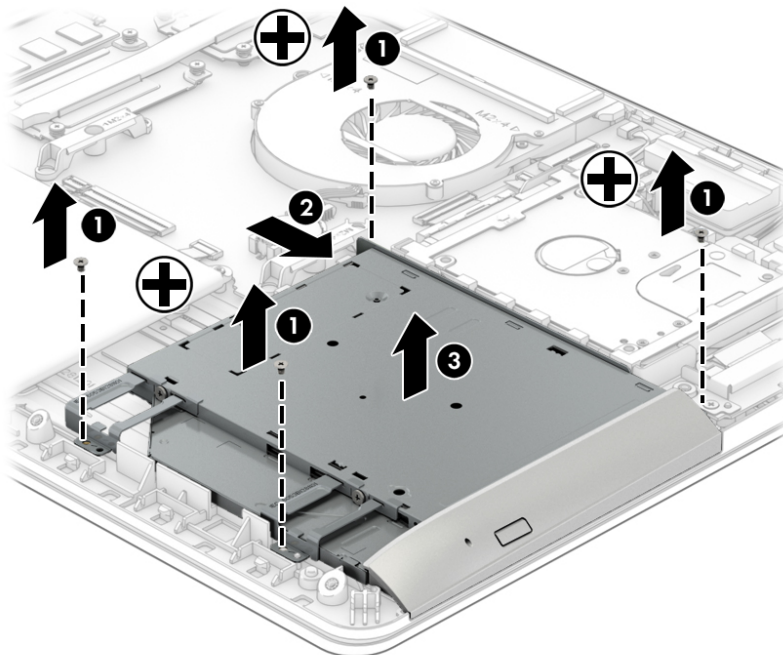

4. If it is necessary to replace the optical drive brackets, remove the four Phillips M2.0×2.6 screws **(1)** that secure the optical drive brackets to the optical drive.

5. Remove the optical drive brackets (2).

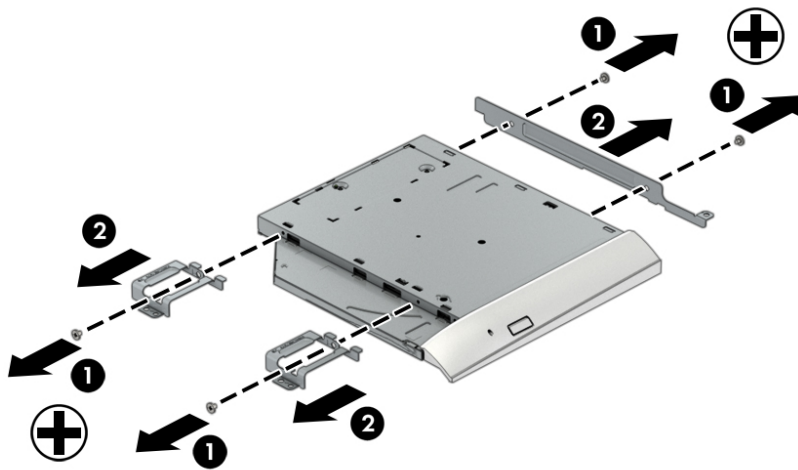

Reverse this procedure to reassemble and install the optical drive.

## TouchPad

Description	Spare part number
TouchPad	857830-001

**NOTE:** The TouchPad spare part kit does not include the TouchPad bracket or TouchPad cable. The TouchPad bracket is available using spare part number 857825-001. The TouchPad cable is available using spare part number 857836-001.

Before removing the TouchPad, follow these steps:

1. Turn off the computer. If you are unsure whether the computer is off or in Hibernation, turn the computer on, and then shut it down through the operating system.
2. Disconnect the power from the computer by unplugging the power cord from the computer.
3. Disconnect all external devices from the computer.
4. Remove the bottom cover (see [Bottom cover on page 24](#)).
5. Remove the battery (see [Battery on page 26](#)).
6. Remove the optical drive (see [Optical drive on page 35](#)).

Remove the TouchPad:

1. Release the ZIF connector **(1)** to which the TouchPad cable is connected, and then disconnect the TouchPad cable from the system board.
2. Detach the TouchPad cable **(2)** from the TouchPad. (The TouchPad cable is attached to the TouchPad with double-sided adhesive.)
3. Detach the pieces of grounding tape **(3)** that secure the TouchPad to the keyboard/top cover.
4. Remove the three Phillips M2.0×2.3 broad head screws **(4)** that secure the TouchPad and TouchPad bracket to the keyboard/top cover.
5. Remove the four Phillips M2.0×3.0 screws **(5)** that secure the TouchPad and TouchPad bracket to the keyboard/top cover.
6. Remove the TouchPad bracket **(6)**.

The TouchPad bracket is available using spare part number 857825-001.

7. Remove the TouchPad (7).

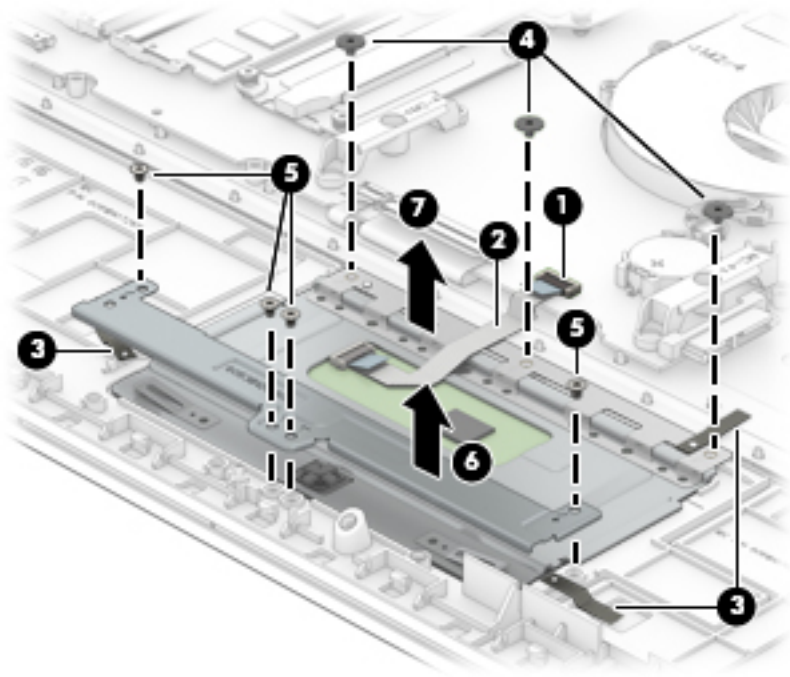

Reverse this procedure to install the TouchPad.

## Power connector cable

Description	Spare part number
Power connector cable	857437-001

Before removing the power connector cable, follow these steps:

1. Turn off the computer. If you are unsure whether the computer is off or in Hibernation, turn the computer on, and then shut it down through the operating system.
2. Disconnect the power from the computer by unplugging the power cord from the computer.
3. Disconnect all external devices from the computer.
4. Remove the bottom cover (see [Bottom cover on page 24](#)).
5. Disconnect the battery cable from the system board (see [Battery on page 26](#)).

Remove the power connector cable:

1. Remove the three Phillips M2.0×4.8 screws **(1)** that secure the power connector cable bracket to the keyboard/top cover.
2. Remove the power connector cable bracket **(2)**.
3. Disconnect the power connector cable **(3)** from the system board.
4. Remove the power connector cable **(4)**.

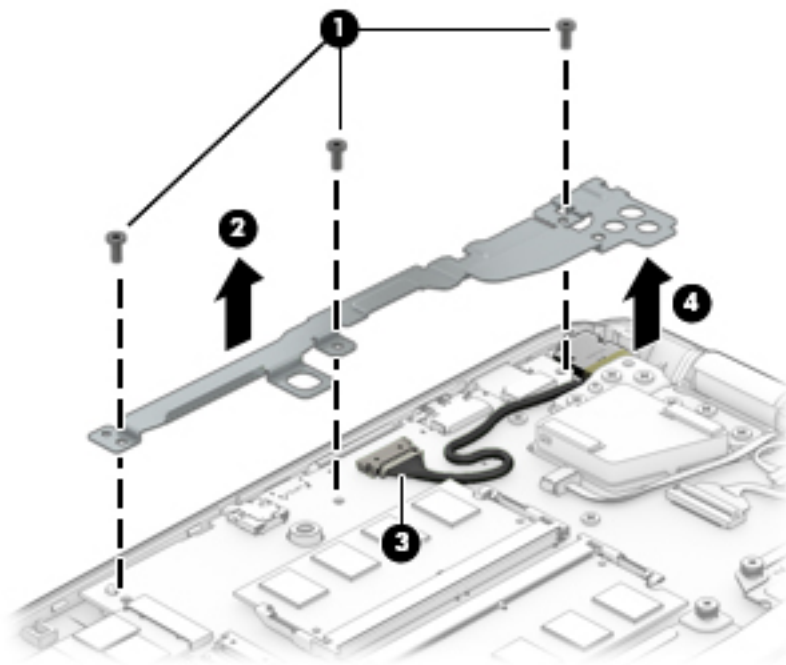

Reverse this procedure to install the power connector cable.

## USB board

Description	Spare part number
USB board (includes USB board cable, USB board FFC cable, RJ45 jack, and 2 USB ports) for use in models with Intel Core i7-7500U and Intel Core i7-6500U processors	857823-001
<b>NOTE:</b> The USB board cable is also available using spare part number 857837-001. The USB board FFC cable is also available using spare part number 857833-001.	
USB board (includes USB board cable, USB board FFC cable, RJ45 jack, and 2 USB ports) for use in models with Intel Core i7-8550U processors	L01126-001

Before removing the USB board, follow these steps:

1. Turn off the computer. If you are unsure whether the computer is off or in Hibernation, turn the computer on, and then shut it down through the operating system.
2. Disconnect the power from the computer by unplugging the power cord from the computer.
3. Disconnect all external devices from the computer.
4. Remove the bottom cover (see [Bottom cover on page 24](#)).
5. Disconnect the battery cable from the system board (see [Battery on page 26](#)).
6. Remove the hard drive (see [Hard drive on page 31](#)).
7. Remove the WLAN module (see [WLAN module on page 33](#)).

Remove the USB board:

1. Remove the Phillips M2.0×4.8 screw **(1)** and the Phillips M2.0×3.8 screw **(2)** that secure the USB board bracket to the keyboard/top cover.
2. Remove the USB board bracket **(3)**.

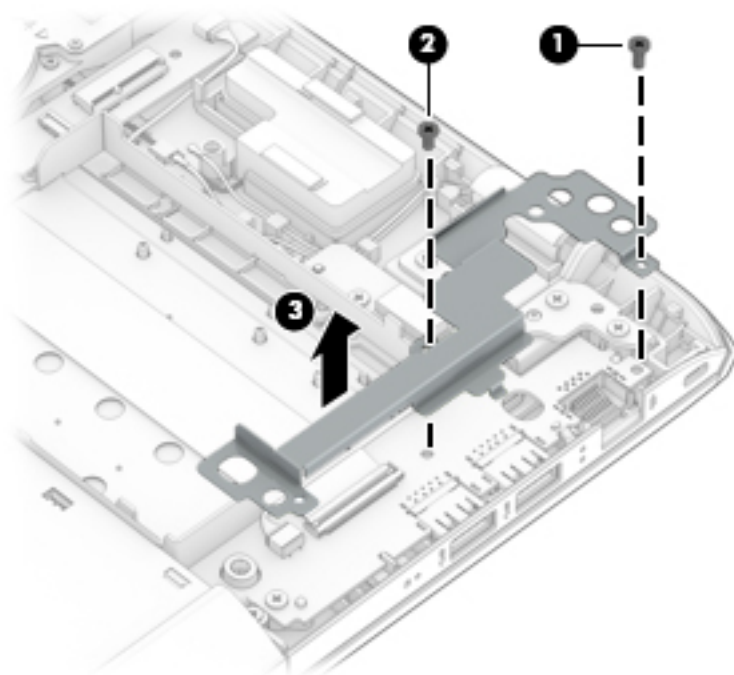



3. Release the ZIF connector **(1)** to which the USB board FFC cable is connected, and then disconnect the USB board FFC cable from the system board.
4. Disconnect the USB board cable **(2)** from the system board.
5. Release the USB board cable from the routing clips **(3)** and channel built into the keyboard/top cover.
6. Remove the two Phillips M2.0×3.8 screws **(4)** and the Phillips M2.0×4.8 screw **(5)** that secure the USB board to the keyboard/top cover.
7. Remove the USB board **(6)**.

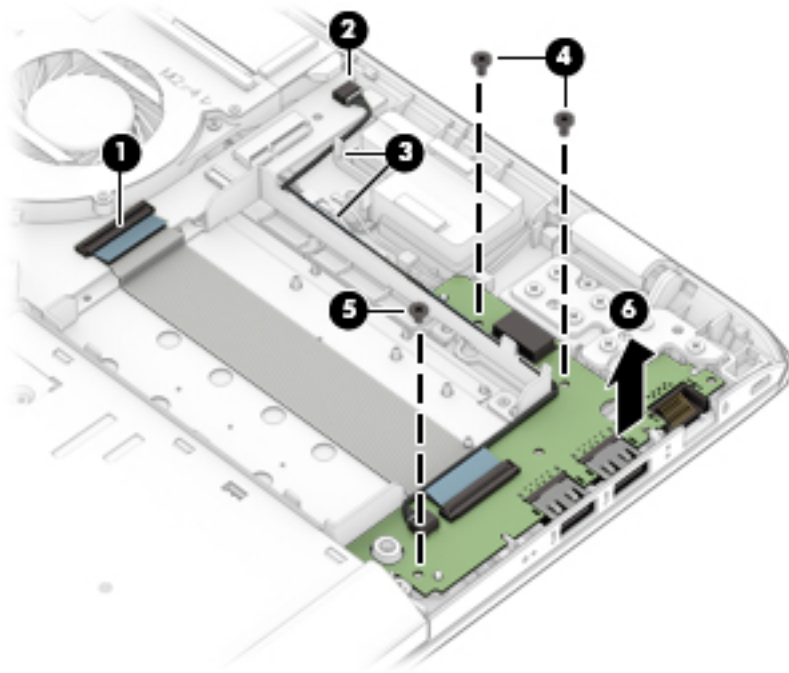

Reverse this procedure to install the USB board.

## USB board cable

Description	Spare part number
USB board cable	857837-001
USB board FFC cable	857833-001

Before removing the USB board cables, follow these steps:

1. Turn off the computer. If you are unsure whether the computer is off or in Hibernation, turn the computer on, and then shut it down through the operating system.
2. Disconnect the power from the computer by unplugging the power cord from the computer.
3. Disconnect all external devices from the computer.
4. Remove the bottom cover (see [Bottom cover on page 24](#)).
5. Disconnect the battery cable from the system board (see [Battery on page 26](#)).
6. Remove the hard drive (see [Hard drive on page 31](#)).
7. Remove the WLAN module (see [WLAN module on page 33](#)).
8. Remove the USB board (see [USB board on page 40](#)).

Remove the USB board cables:

1. Release the ZIF connector **(1)** to which the USB board FFC cable is connected, and then disconnect the USB board FFC cable **(2)** from the system board.
2. Disconnect the USB board cable **(3)** from the system board.

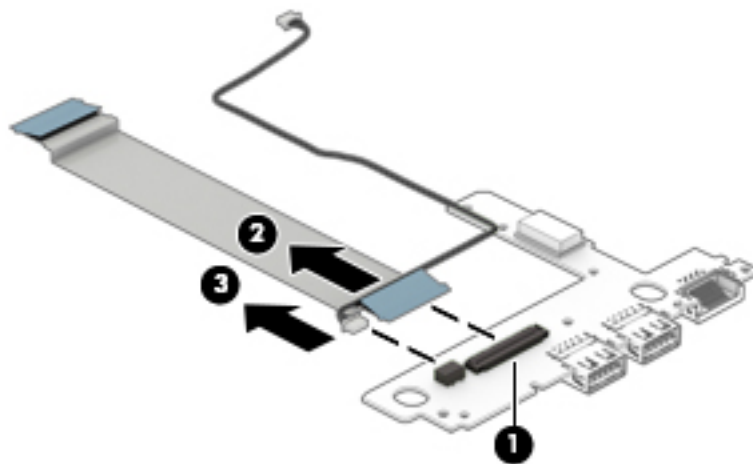

Reverse this procedure to install the USB board cables.

## System board



**NOTE:** The system board spare part kit includes an nVIDIA N16S-GTR-S (GeForce 940MX) graphics subsystem with 2048-MB of dedicated video memory, the processor, and replacement thermal material.

Description	Spare part number
System board for use only on computer models with model numbers 17-u200 through 17-u299:	
<ul style="list-style-type: none"><li>Equipped with an Intel Core i7-8550U 1.80-GHz (SC turbo up to 4.00-GHz) processor (2400-MHz FSB, 8.0-MB L3 cache, dual core, 15-W), a hard drive connector, and the Windows 10 operating system</li></ul>	924006-601
<ul style="list-style-type: none"><li>Equipped with an Intel Core i7-8550U 1.80-GHz (SC turbo up to 4.00-GHz) processor (2400-MHz FSB, 8.0-MB L3 cache, dual core, 15-W), a hard drive connector, and a non-Windows operating system</li></ul>	924006-001
<ul style="list-style-type: none"><li>Equipped with an Intel Core i7-8550U 1.80-GHz (SC turbo up to 4.00-GHz) processor (2400-MHz FSB, 8.0-MB L3 cache, dual core, 15-W), a hard drive connector, and the Windows 10 operating system (for use in models with solid-state drives)</li></ul>	924007-601
<ul style="list-style-type: none"><li>Equipped with an Intel Core i7-8550U 1.80-GHz (SC turbo up to 4.00-GHz) processor (2400-MHz FSB, 8.0-MB L3 cache, dual core, 15-W), a hard drive connector, and a non-Windows operating system (for use in models with solid-state drives)</li></ul>	924007-001
System board for use only on computer models with model numbers 17-u100 through 17-u199:	
<ul style="list-style-type: none"><li>Equipped with an Intel Core i7-7500U 2.70-GHz (SC turbo up to 3.50-GHz) processor (2133-MHz FSB, 4.0-MB L3 cache, dual core, 15-W), a hard drive connector, and the Windows 10 operating system</li></ul>	859291-601
<ul style="list-style-type: none"><li>Equipped with an Intel Core i7-7500U 2.70-GHz (SC turbo up to 3.50-GHz) processor (2133-MHz FSB, 4.0-MB L3 cache, dual core, 15-W), a hard drive connector, and a non-Windows operating system</li></ul>	859291-001
<ul style="list-style-type: none"><li>Equipped with an Intel Core i7-7500U 2.70-GHz (SC turbo up to 3.50-GHz) processor (2133-MHz FSB, 4.0-MB L3 cache, dual core, 15-W), a solid-state drive connector, and the Windows 10 operating system</li></ul>	859292-601
<ul style="list-style-type: none"><li>Equipped with an Intel Core i7-7500U 2.70-GHz (SC turbo up to 3.50-GHz) processor (2133-MHz FSB, 4.0-MB L3 cache, dual core, 15-W), a solid-state drive connector, and a non-Windows operating system</li></ul>	859292-001
System board for use on all computer models:	
<ul style="list-style-type: none"><li>Equipped with an Intel Core i7-6500U 2.50-GHz (SC turbo up to 3.10-GHz) processor (1600-MHz FSB, 4.0-MB L3 cache, dual core, 15-W), a hard drive connector, and the Windows 10 operating system</li></ul>	857297-601
<ul style="list-style-type: none"><li>Equipped with an Intel Core i7-6500U 2.50-GHz (SC turbo up to 3.10-GHz) processor (1600-MHz FSB, 4.0-MB L3 cache, dual core, 15-W), a hard drive connector, and a non-Windows operating system</li></ul>	857297-001
<ul style="list-style-type: none"><li>Equipped with an Intel Core i7-6500U 2.50-GHz (SC turbo up to 3.10-GHz) processor (1600-MHz FSB, 4.0-MB L3 cache, dual core, 15-W), a solid-state drive connector, and the Windows 10 operating system</li></ul>	857298-601
<ul style="list-style-type: none"><li>Equipped with an Intel Core i7-6500U 2.50-GHz (SC turbo up to 3.10-GHz) processor (1600-MHz FSB, 4.0-MB L3 cache, dual core, 15-W), a solid-state drive connector, and a non-Windows operating system</li></ul>	857298-001

Before removing the system board, follow these steps:

1. Turn off the computer. If you are unsure whether the computer is off or in Hibernation, turn the computer on, and then shut it down through the operating system.
2. Disconnect the power from the computer by unplugging the power cord from the computer.
3. Disconnect all external devices from the computer.
4. Remove the bottom cover (see [Bottom cover on page 24](#)).
5. Disconnect the battery cable from the system board (see [Battery on page 26](#)).
6. Remove the following components:
  - a. Solid-state drive (see [Solid-state drive on page 27](#))
  - b. Optical drive (see [Optical drive on page 35](#))
  - c. WLAN module (see [WLAN module on page 33](#))



**NOTE:** When replacing the system board, be sure that the following components are removed from the defective system board and installed on the replacement system board:

- Memory module(s) (see [Memory module on page 29](#))
- RTC battery (see [RTC battery on page 30](#))
- Heat sink (see [Heat sink on page 47](#))
- Fan (see [Fan on page 49](#))

Remove the system board:

1. Disconnect the following cables from the system board:
  - (1) Power connector cable
  - (2) Speaker cable
  - (3) Display panel ZIF connector cable
  - (4) Webcam/microphone module ZIF connector cable
  - (5) USB board cable
  - (6) Hard drive ZIF connector cable
  - (7) USB board ZIF connector cable
  - (8) TouchPad ZIF connector cable
  - (9) Keyboard ZIF connector cable
  - (10) Keyboard backlight ZIF connector cable

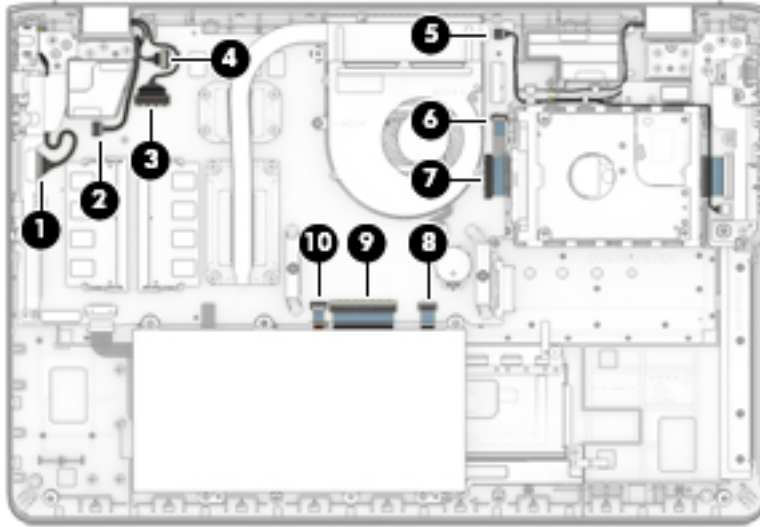

2. Remove the three Phillips M2.0×4.8 screws **(1)** that secure the power connector cable bracket to the keyboard/top cover.
3. Remove the power connector cable bracket **(2)**.
4. Remove the two Phillips M2.0×3.8 screws **(3)** that secure the system board to the keyboard/top cover.
5. Remove the four Phillips M2.0×4.8 screws **(4)** that secure the plastic support bridges and the heat sink to the keyboard/top cover.
6. Remove the plastic support bridges **(5)**.

The plastic support bridges are included in the I/O Bracket Kit, spare part number 857824-001.

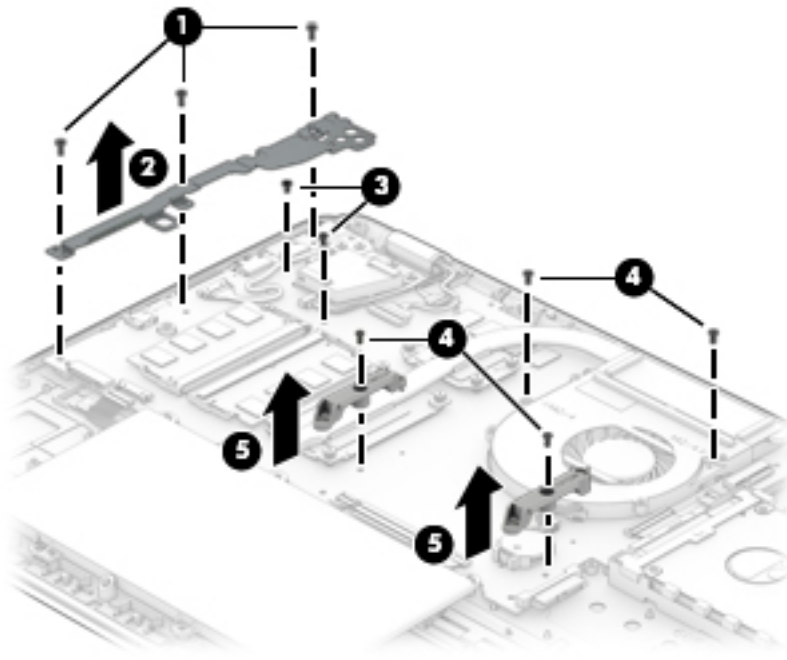

7. Release the system board **(1)** by lifting the right side and swinging it up and to the left until it rests at an angle.

8. Remove the system board **(2)** by sliding it up and to the right at an angle.

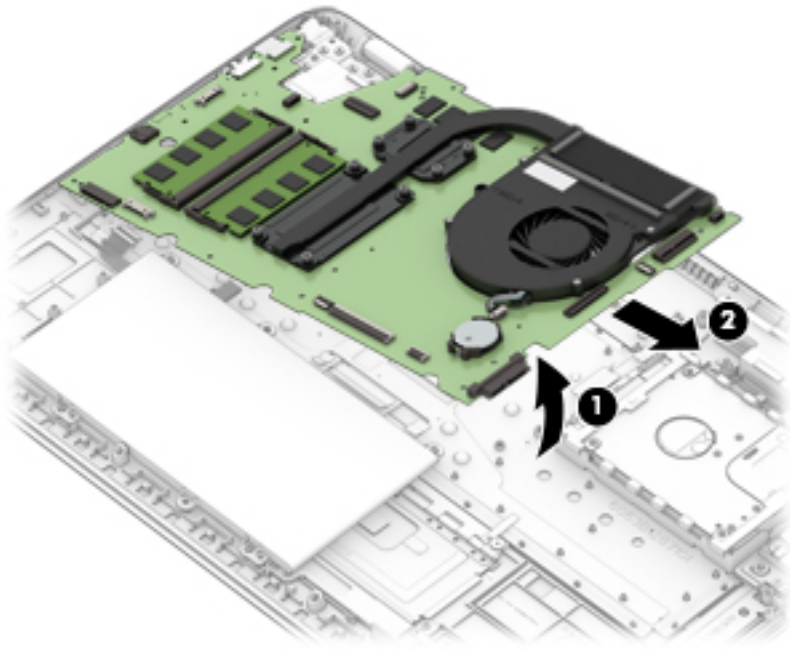

Reverse this procedure to install the system board.

## Heat sink

Description	Spare part number
Heat sink (includes replacement thermal material)	857299-001

Before removing the heat sink, follow these steps:

1. Turn off the computer. If you are unsure whether the computer is off or in Hibernation, turn the computer on, and then shut it down through the operating system.
2. Disconnect the power from the computer by unplugging the power cord from the computer.
3. Disconnect all external devices from the computer.
4. Remove the bottom cover (see [Bottom cover on page 24](#)).
5. Disconnect the battery cable from the system board (see [Battery on page 26](#)).
6. Remove the following components:
  - a. Solid-state drive (see [Solid-state drive on page 27](#))
  - b. Optical drive (see [Optical drive on page 35](#))
  - c. WLAN module (see [WLAN module on page 33](#))
  - d. System board (see [System board on page 43](#))





**NOTE:** When replacing the heat sink, be sure that the fan (see [Fan on page 49](#)) is removed from the defective heat sink and installed on the replacement heat sink.

Remove the heat sink:

1. Disconnect the fan cable **(1)** from the system board.
2. Loosen the eight Phillips M2.0×8.1 captive screws **(2)** that secure the fan and heat sink to the system board.

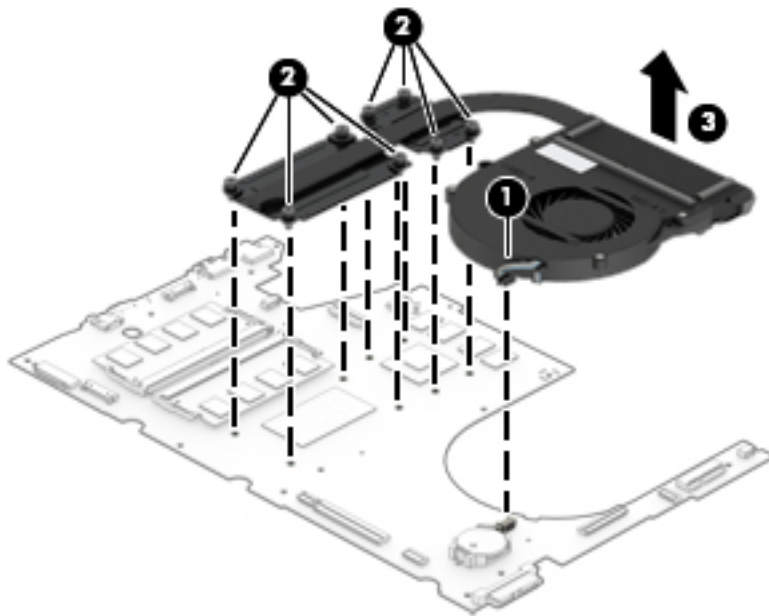
3. Remove the fan and heat sink (3).



 **NOTE:** The thermal material must be thoroughly cleaned from the surfaces of the heat sink and the system board each time the heat sink is removed.

Thermal material is used on the processor (1) and the heat sink section (2) that services it. Thermal material is also used on the graphics subsystem component (3) and the heat sink section (4) that services it.

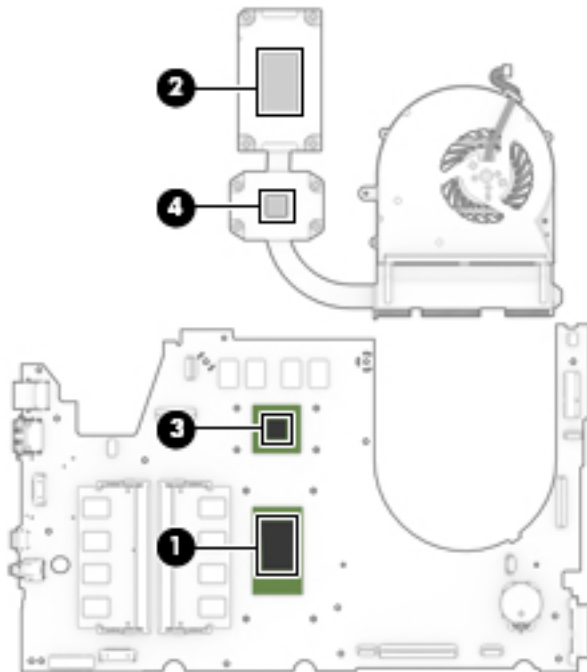

Reverse this procedure to install the heat sink.



## Fan

Description	Spare part number
Fan (includes fan cable)	862193-001

Before removing the fan, follow these steps:

1. Turn off the computer. If you are unsure whether the computer is off or in Hibernation, turn the computer on, and then shut it down through the operating system.
2. Disconnect the power from the computer by unplugging the power cord from the computer.
3. Disconnect all external devices from the computer.
4. Remove the bottom cover (see [Bottom cover on page 24](#)).
5. Disconnect the battery cable from the system board (see [Battery on page 26](#)).
6. Remove the following components:
  - a. Solid-state drive (see [Solid-state drive on page 27](#))
  - b. Optical drive (see [Optical drive on page 35](#))
  - c. WLAN module (see [WLAN module on page 33](#))
  - d. System board (see [System board on page 43](#))
  - e. Heat sink (see [Heat sink on page 47](#))

Remove the fan:

1. Remove the four Phillips M2.0×2.1 screws **(1)** that secure the fan to the heat sink.
2. Lift the front of the heat sink housing **(2)** until the fan is accessible.
3. Remove the fan **(3)** by sliding it forward.

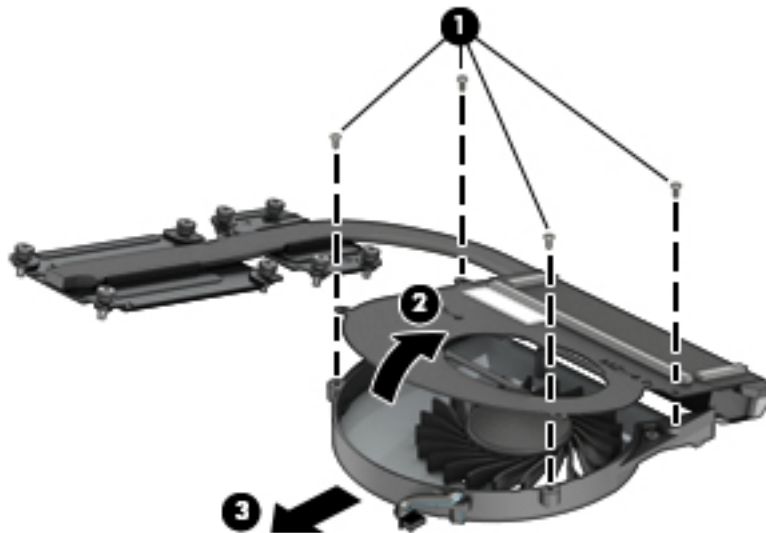

Reverse this procedure to install the fan.

## Speakers

Description	Spare part number
Speakers (includes left and right speakers and cables)	857834-001

Before removing the speakers, follow these steps:

1. Turn off the computer. If you are unsure whether the computer is off or in Hibernation, turn the computer on, and then shut it down through the operating system.
2. Disconnect the power from the computer by unplugging the power cord from the computer.
3. Disconnect all external devices from the computer.
4. Remove the bottom cover (see [Bottom cover on page 24](#)).
5. Disconnect the battery cable from the system board (see [Battery on page 26](#)).
6. Remove the following components:
  - a. Solid-state drive (see [Solid-state drive on page 27](#))
  - b. Optical drive (see [Optical drive on page 35](#))
  - c. WLAN module (see [WLAN module on page 33](#))
  - d. System board (see [System board on page 43](#))

Remove the speakers:

1. Detach the piece of tape **(1)** that secures the speaker cable to the keyboard/top cover.
2. Release the speaker cable from the routing clips **(2)** and channel built into the keyboard/top cover.
3. Remove the speakers **(3)**.

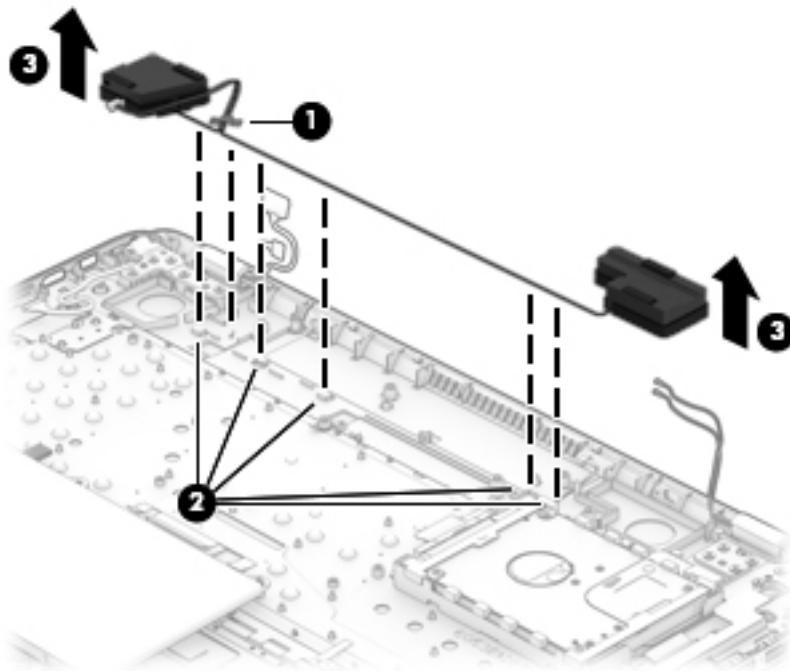

Reverse this procedure to install the speakers.

## Display assembly

Description	Spare part number
<b>Display assemblies for use only on computer models with model numbers 17-u100 through 17-u199:</b>	
17.3-in, UHD, WLED, AntiGlare (3840×2160), flat-flat (4.0-mm), UWVA, eDP+PSR, touch screen display assembly equipped with HDC and webcam	857436-001
17.3-in, FHD, WLED, AntiGlare (1920×1080), flat-flat (4.0-mm), UWVA, eDP, touch screen display assembly equipped with HDC and webcam	857435-001
17.3-in, UHD, WLED, AntiGlare (3840×2160), flat-flat (4.0-mm), UWVA, eDP+PSR non-touch scree, display assembly equipped with HDC and webcam	933257-001
17.3-in, FHD, WLED, AntiGlare (1920×1080), flat-flat (4.0-mm), UWVA, eDP non-touch screen display assembly equipped with HDC and webcam	933256-001
<b>Display assemblies for use on all computer models:</b>	
17.3-in, UHD, WLED, AntiGlare (3840×2160), uslim-flat (2.68-mm), UWVA, eDP+PSR TouchScreen display assembly equipped with f3DC and webcam	859440-001
17.3-in, FHD, WLED, BrightView (1920×1080), slim-flat (3.0-mm), UWVA, eDP TouchScreen display assembly equipped with f3DC and webcam	859439-001
<b>Display assemblies for use only on computer models with model numbers 17-u200 through 17-u299:</b>	
17.3-in, UHD, WLED, eDP+PSR, AntiGlare (3840×2160), flat-flat (4.0-mm), UWVA, TouchScreen display assembly equipped with HDC and IR webcam	926687-001
17.3-in, FHD, WLED, eDP, AntiGlare (1920×1080), flat-flat (4.0-mm), UWVA, eDP TouchScreen display assembly equipped with HDC and IR webcam	926686-001
17.3-in, UHD, WLED, AntiGlare (3840×2160), flat-flat (4.0-mm), UWVA, eDP+PSR non-touch scree, display assembly equipped with HDC and webcam	933259-001
17.3-in, FHD, WLED, AntiGlare (1920×1080), flat-flat (4.0-mm), UWVA, eDP non-touch screen display assembly equipped with HDC and webcam	933258-001

Before removing the display assembly, follow these steps:

1. Turn off the computer. If you are unsure whether the computer is off or in Hibernation, turn the computer on, and then shut it down through the operating system.
2. Disconnect the power from the computer by unplugging the power cord from the computer.
3. Disconnect all external devices from the computer.
4. Remove the bottom cover (see [Bottom cover on page 24](#)).
5. Disconnect the battery cable from the system board (see [Battery on page 26](#)).

Remove the display assembly:

1. Release the ZIF connector **(1)** to which the display panel cable is connected, and then disconnect the display panel cable from the system board.
2. Release the ZIF connector **(2)** to which the webcam/microphone module cable is connected, and then disconnect the webcam/microphone module cable from the system board.

3. Disconnect the WLAN antenna cables **(3)** from the terminals on the WLAN module.

 **NOTE:** The WLAN antenna cable labeled “1/MAIN” connects to the WLAN module “Main” terminal. The WLAN antenna cable labeled “2/AUX” connects to the WLAN module “Aux” terminal.

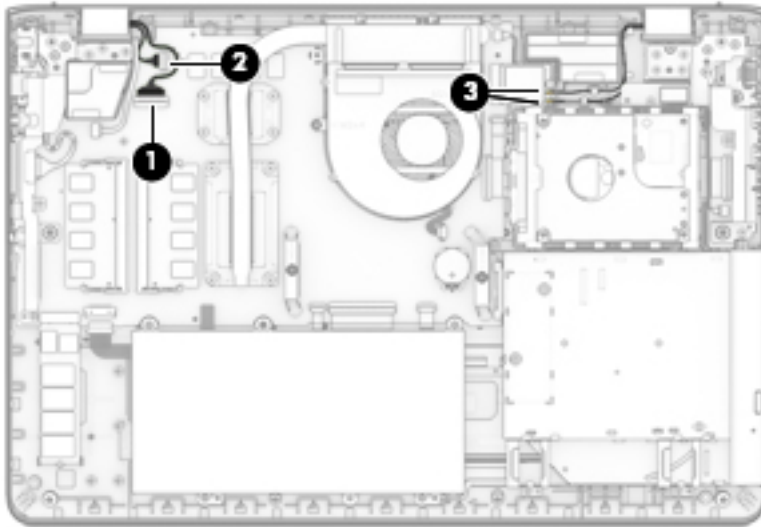

4. Remove the four Phillips M2.0×4.8 screws **(1)** and the Phillips M2.0×3.8 screw **(2)** that secure the power connector cable bracket and the USB board bracket to the keyboard/top cover.
5. Remove the power connector cable bracket **(3)**.
6. Remove the USB board bracket **(4)**.

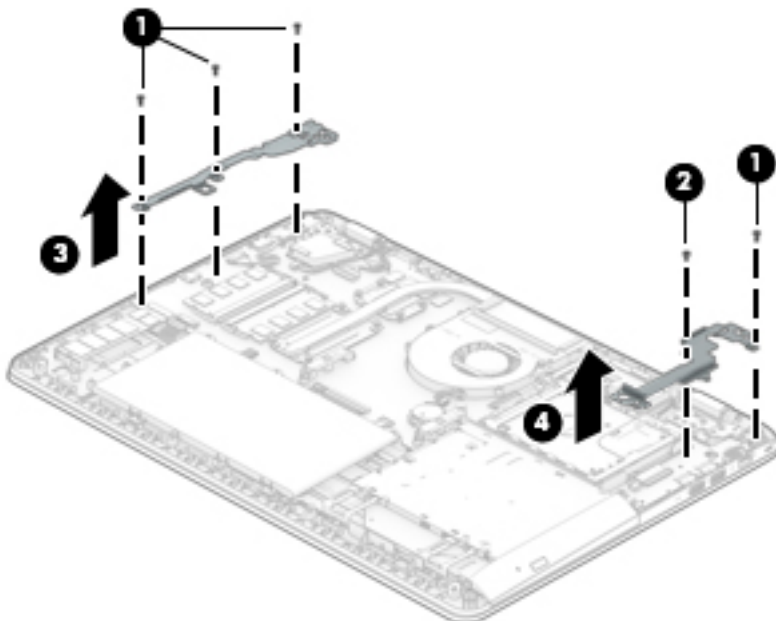

7. Remove the 13 Phillips M2.5×6.7 screws **(1)** that secure the display assembly to the keyboard/top cover.

8. Release the display hinges (2) by swinging them up and back.

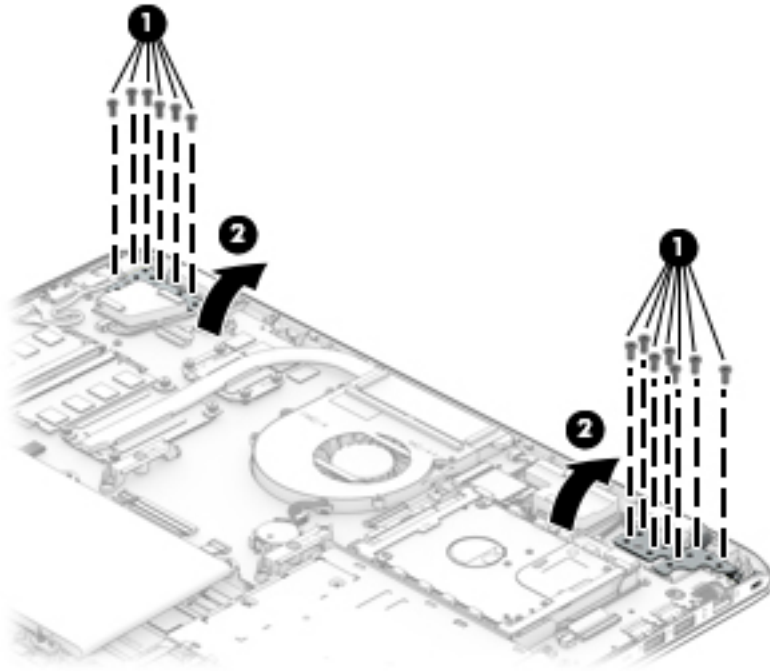

9. Swing the keyboard/top cover (1) up and away from the display assembly.
10. Slide the keyboard/top cover (2) forward and separate it from the display assembly.

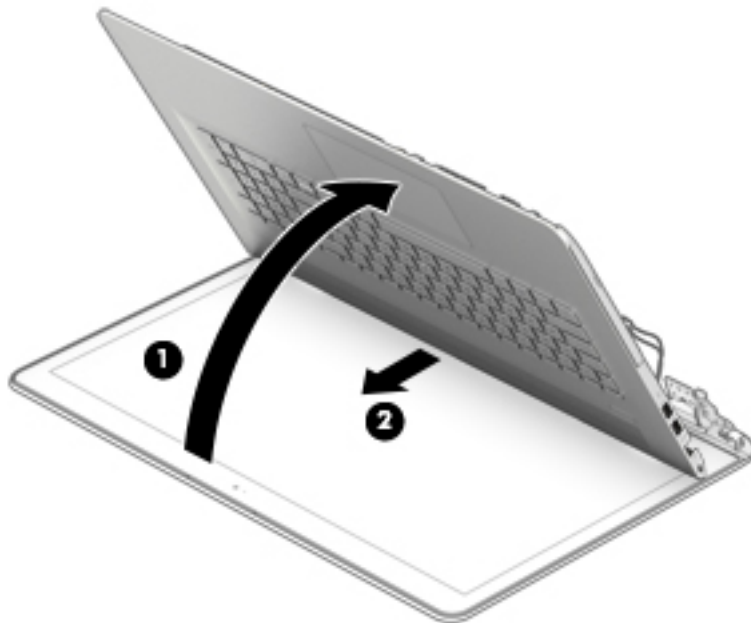

Reverse this procedure to reassemble and install the display assembly.

---

## 6 Using Setup Utility (BIOS)

Setup Utility, or Basic Input/Output System (BIOS), controls communication between all the input and output devices on the system (such as disk drives, display, keyboard, mouse, and printer). Setup Utility (BIOS) includes settings for the types of devices installed, the startup sequence of the computer, and the amount of system and extended memory.

---

 **NOTE:** To start Setup Utility on convertible computers, your computer must be in notebook mode and you must use the keyboard attached to your notebook.

---

### Starting Setup Utility (BIOS)

---

 **CAUTION:** Use extreme care when making changes in Setup Utility (BIOS). Errors can prevent the computer from operating properly.

---

- ▲ Turn on or restart the computer, quickly press `esc`, and then press `f10`.

### Updating Setup Utility (BIOS)

Updated versions of Setup Utility (BIOS) may be available on the HP website.

Most BIOS updates on the HP website are packaged in compressed files called *SoftPaqs*.

Some download packages contain a file named `Readme.txt`, which contains information regarding installing and troubleshooting the file.

### Determining the BIOS version

To decide whether you need to update Setup Utility (BIOS), first determine the BIOS version on your computer.

To reveal the BIOS version information (also known as *ROM date* and *System BIOS*), use one of these options.

- HP Support Assistant
  1. Type `support` in the taskbar search box, and then select the **HP Support Assistant** app.  
– or –  
Click the question mark icon in the taskbar.
  2. Select **My PC**, and then select **Specifications**.
- Setup Utility (BIOS)
  1. Start Setup Utility (BIOS) (see [Starting Setup Utility \(BIOS\) on page 54](#)).
  2. Select **Main**, select **System Information**, and then make note of the BIOS version.
  3. Select **Exit**, select **No**, and then follow the on-screen instructions.

To check for later BIOS versions, see [Downloading a BIOS update on page 55](#).

## Downloading a BIOS update

---

 **CAUTION:** To reduce the risk of damage to the computer or an unsuccessful installation, download and install a BIOS update only when the computer is connected to reliable external power using the AC adapter. Do not download or install a BIOS update while the computer is running on battery power, docked in an optional docking device, or connected to an optional power source. During the download and installation, follow these instructions:

- Do not disconnect power from the computer by unplugging the power cord from the AC outlet.
- Do not shut down the computer or initiate Sleep.
- Do not insert, remove, connect, or disconnect any device, cable, or cord.

 **NOTE:** If your computer is connected to a network, consult the network administrator before installing any software updates, especially system BIOS updates.

---

1. Type `support` in the taskbar search box, and then select the **HP Support Assistant** app.  
– or –  
Click the question mark icon in the taskbar.
2. Click **Updates**, and then click **Check for updates and messages**.
3. Follow the on-screen instructions.
4. At the download area, follow these steps:
  - a. Identify the most recent BIOS update and compare it to the BIOS version currently installed on your computer. If the update is more recent than your BIOS version, make a note of the date, name, or other identifier. You may need this information to locate the update later, after it has been downloaded to your hard drive.
  - b. Follow the on-screen instructions to download your selection to the hard drive.  
  
Make a note of the path to the location on your hard drive where the BIOS update is downloaded. You will need to access this path when you are ready to install the update.

BIOS installation procedures vary. Follow any instructions that appear on the screen after the download is complete. If no instructions appear, follow these steps:

1. Type `file` in the taskbar search box, and then select **File Explorer**.
2. Click your hard drive designation. The hard drive designation is typically Local Disk (C:).
3. Using the hard drive path you recorded earlier, open the folder that contains the update.
4. Double-click the file that has an `.exe` extension (for example, `filename.exe`).  
  
The BIOS installation begins.
5. Complete the installation by following the on-screen instructions.

---

 **NOTE:** After a message on the screen reports a successful installation, you can delete the downloaded file from your hard drive.

---

---

# 7 Using HP PC Hardware Diagnostics (UEFI)

HP PC Hardware Diagnostics is a Unified Extensible Firmware Interface (UEFI) that allows you to run diagnostic tests to determine whether the computer hardware is functioning properly. The tool runs outside the operating system so that it can isolate hardware failures from issues that are caused by the operating system or other software components.

When HP PC Hardware Diagnostics (UEFI) detects a failure that requires hardware replacement, a 24-digit Failure ID code is generated. This ID code can then be provided to support to help determine how to correct the problem.

---

 **NOTE:** To start diagnostics on a convertible computer, your computer must be in notebook mode and you must use the keyboard attached.

---

To start HP PC Hardware Diagnostics (UEFI), follow these steps:

1. Turn on or restart the computer, and quickly press *esc*.
2. Press *f2*.

The BIOS searches three places for the diagnostic tools, in the following order:

- a. Connected USB drive

---

 **NOTE:** To download the HP PC Hardware Diagnostics (UEFI) tool to a USB drive, see [Downloading HP PC Hardware Diagnostics \(UEFI\) to a USB device on page 56](#).

---

- b. Hard drive

- c. BIOS

3. When the diagnostic tool opens, select the type of diagnostic test you want to run, and then follow the on-screen instructions.

---

 **NOTE:** If you need to stop a diagnostic test, press *esc*.

---

## Downloading HP PC Hardware Diagnostics (UEFI) to a USB device

---

 **NOTE:** The HP PC Hardware Diagnostics (UEFI) download instructions are provided in English only, and you must use a Windows computer to download and create the HP UEFI support environment because only .exe files are offered.

---

There are two options to download HP PC Hardware Diagnostics to a USB device.

### Download the latest UEFI version

1. Go to <http://www.hp.com/go/techcenter/pcdiags>. The HP PC Diagnostics home page is displayed.
2. In the HP PC Hardware Diagnostics section, select the **Download** link, and then select **Run**.

### Download any version of UEFI for a specific product

1. Go to <http://www.hp.com/support>.
2. Select **Get software and drivers**.



3. Enter the product name or number.

– or –

Select **Identify now** to let HP automatically detect your product.

4. Select your computer, and then select your operating system.
5. In the **Diagnostic** section, follow the on-screen instructions to select and download the UEFI version you want.

#### **Additional BIOS crisis recovery tool**

HP provides a BIOS crisis recovery tool through the HP PC Hardware Diagnostics 3-in-1 USB key. This tool can be used by HP authorized service providers to recover systems that have failed due to a corrupted BIOS. For more information about using the 3-in-1 USB key for BIOS crisis recovery, go to <http://www.hp.com/go/techcenter/pcdiags>. Additional information is included in the web-based training offered by HP University. See the modules that cover HP PC Hardware Diagnostics (UEFI).

# 8 Specifications

## Computer specifications

The power information in this section may be helpful if you plan to travel internationally with the computer.

The computer operates on DC power, which can be supplied by an AC or a DC power source. The AC power source must be rated at 100–240 V, 50–60 Hz. Although the computer can be powered from a standalone DC power source, it should be powered only with an AC adapter or a DC power source that is supplied and approved by HP for use with this computer.

The computer can operate on DC power within the following specifications. Operating voltage and current varies by platform. The voltage and current for your computer is located on the regulatory label.

	Metric	U.S.
<b>Dimensions</b>		
Width	41.60 cm	16.38 in
Depth	28.5 cm	11.22 in
Height	2.50 cm	0.98 in
Weight (equipped with a hard drive)	3.05 kg	6.72 lbs
Weight (equipped with a solid-state drive)	2.90 kg	6.39 lbs
<b>Input power</b>		
Operating voltage and current	5 V dc @ 2 A / 12 V dc @ 3 A / 15 V dc @ 3 A – 45 W USB-C 5 V dc @ 3 A / 9 V dc @ 3 A / 10 V dc @ 3.75 A / 12 V dc @ 3.75 A / 15 V dc @ 3 A / 20 V dc @ 2.25 A - 45 W USB-C 5 V dc @ 3 A / 9 V dc @ 3 A / 10 V dc @ 5.0 A / 12 V dc @ 5.0 A / 15 V dc @ 4.33 A / 20 V dc @ 3.25 A - 65 W USB-C 5 V dc @ 3 A / 9 V dc @ 3 A / 10 V dc @ 5.0 A / 12 V dc @ 5.0 A / 15 V dc @ 5.0 A / 20 V dc @ 4.5 A - 90 W USB-C 19.5 V dc @ 2.31 A – 45 W 19.5 V dc @ 3.33 A – 65 W 19.5 V dc @ 4.62 A – 90 W 19.5 V dc @ 6.15 A – 120 W 19.5 V dc @ 7.70 A – 150 W 19.5 V dc @ 10.3 A – 200 W	
<b>NOTE:</b> This product is designed for IT power systems in Norway with phase-to-phase voltage not exceeding 240 V rms.		
<b>Temperature</b>		
Operating	5°C to 35°C	41°F to 95°F
Non-operating	-20°C to 60°C	-4°F to 140°F
<b>Relative humidity</b> (non-condensing)		

	<b>Metric</b>	<b>U.S.</b>
Operating	10% to 90%	
Non-operating	5% to 95%	
<b>Maximum altitude</b> (unpressurized)		
Operating	<b>-15 m to 3,048 m</b>	-50 ft to 10,000 ft
Non-operating	<b>-15 m to 12,192 m</b>	-50 ft to 40,000 ft
<b>NOTE:</b> Applicable product safety standards specify thermal limits for plastic surfaces. The device operates well within this range of temperatures.		

---

# 9 Backing up, restoring, and recovering

This chapter provides information about the following processes. The information in the chapter is standard procedure for most products.

- Creating recovery media and backups
- Restoring and recovering your system

For additional information, refer to the HP Support Assistant app.

▲ Type `support` in the taskbar search box, and then select the **HP Support Assistant** app.

– or –

Select the question mark icon in the taskbar.

---

 **IMPORTANT:** If you will be performing recovery procedures on a tablet, the tablet battery must be at least 70% charged before you start the recovery process.

**IMPORTANT:** For a tablet with a detachable keyboard, connect the tablet to the keyboard base before beginning any recovery process.

---

## Creating recovery media and backups

The following methods of creating recovery media and backups are available on select products only. Choose the available method according to your computer model.

- Use HP Recovery Manager to create HP Recovery media after you successfully set up the computer. This step creates a backup of the HP Recovery partition on the computer. The backup can be used to reinstall the original operating system in cases where the hard drive is corrupted or has been replaced. For information on creating recovery media, see [Creating HP Recovery media \(select products only\) on page 60](#). For information on the recovery options that are available using the recovery media, see [Using Windows tools on page 61](#).
- Use Windows tools to create system restore points and create backups of personal information.

For more information, see [Recovering using HP Recovery Manager on page 62](#).

---

 **NOTE:** If storage is 32 GB or less, Microsoft System Restore is disabled by default.

---

## Creating HP Recovery media (select products only)

If possible, check for the presence of the Recovery partition and the Windows partition. From the **Start** menu, select **File Explorer**, and then select **This PC**.

- If your computer does not list the Windows partition and the Recovery partition, you can obtain recovery media for your system from support. See the *Worldwide Telephone Numbers* booklet included with the computer. You can also find contact information on the HP website. Go to <http://www.hp.com/support>, select your country or region, and follow the on-screen instructions.

You can use Windows tools to create system restore points and create backups of personal information, see [Using Windows tools on page 61](#).

- If your computer does list the Recovery partition and the Windows partition, you can use HP Recovery Manager to create recovery media after you successfully set up the computer. HP Recovery media can be used to perform system recovery if the hard drive becomes corrupted. System recovery reinstalls the original operating system and software programs that were installed at the factory and then configures the settings for the programs. HP Recovery media can also be used to customize the system or restore the factory image if you replace the hard drive.
  - Only one set of recovery media can be created. Handle these recovery tools carefully, and keep them in a safe place.
  - HP Recovery Manager examines the computer and determines the required storage capacity for the media that will be required.
  - To create recovery discs, your computer must have an optical drive with DVD writer capability, and you must use only high-quality blank DVD-R, DVD+R, DVD-R DL, or DVD+R DL discs. Do not use rewritable discs such as CD±RW, DVD±RW, double-layer DVD±RW, or BD-RE (rewritable Blu-ray) discs; they are not compatible with HP Recovery Manager software. Or, instead, you can use a high-quality blank USB flash drive.
  - If your computer does not include an integrated optical drive with DVD writer capability, but you would like to create DVD recovery media, you can use an external optical drive (purchased separately) to create recovery discs. If you use an external optical drive, it must be connected directly to a USB port on the computer; the drive cannot be connected to a USB port on an external device, such as a USB hub. If you cannot create DVD media yourself, you can obtain recovery discs for your computer from HP. See the *Worldwide Telephone Numbers* booklet included with the computer. You can also find contact information on the HP website. Go to <http://www.hp.com/support>, select your country or region, and follow the on-screen instructions.
  - Be sure that the computer is connected to AC power before you begin creating the recovery media.
  - The creation process can take an hour or more. Do not interrupt the creation process.
  - If necessary, you can exit the program before you have finished creating all of the recovery DVDs. HP Recovery Manager will finish burning the current DVD. The next time you start HP Recovery Manager, you will be prompted to continue.

To create HP Recovery media:

---

 **IMPORTANT:** For a tablet with a detachable keyboard, connect the tablet to the keyboard base before beginning these steps.

---

1. Type `recovery` in the taskbar search box, and then select **HP Recovery Manager**.
2. Select **Create recovery media**, and then follow the on-screen instructions.

If you ever need to recover the system, see [Recovering using HP Recovery Manager on page 62](#).

## Using Windows tools

You can create recovery media, system restore points, and backups of personal information using Windows tools.

---

 **NOTE:** If storage is 32 GB or less, Microsoft System Restore is disabled by default.

---

For more information and steps, see the Get help app.

- ▲ Select the **Start** button, and then select the **Get help** app.

## Restore and recovery

There are several options for recovering your system. Choose the method that best matches your situation and level of expertise:

---

 **IMPORTANT:** Not all methods are available on all products.

---

- Windows offers several options for restoring from backup, refreshing the computer, and resetting the computer to its original state. For more information see the Get help app.
  - ▲ Select the **Start** button, and then select the **Get help** app.
- If you need to correct a problem with a preinstalled application or driver, use the Reinstall drivers and/or applications option (select products only) of HP Recovery Manager to reinstall the individual application or driver.
  - ▲ Type `recovery` in the taskbar search box, select **HP Recovery Manager**, select **Reinstall drivers and/or applications**, and then follow the on-screen instructions.
- If you want to recover the Windows partition to original factory content, you can choose the System Recovery option from the HP Recovery partition (select products only) or use the HP Recovery media. For more information, see [Recovering using HP Recovery Manager on page 62](#). If you have not already created recovery media, see [Creating HP Recovery media \(select products only\) on page 60](#).
- On select products, if you want to recover the computer's original factory partition and content, or if you have replaced the hard drive, you can use the Factory Reset option of HP Recovery media. For more information, see [Recovering using HP Recovery Manager on page 62](#).
- On select products, if you want to remove the Recovery partition to reclaim hard drive space, HP Recovery Manager offers the Remove Recovery Partition option.

For more information, see [Removing the HP Recovery partition \(select products only\) on page 64](#).

## Recovering using HP Recovery Manager

HP Recovery Manager software allows you to recover the computer to its original factory state by using the HP Recovery media that you either created or that you obtained from HP, or by using the HP Recovery partition (select products only). If you have not already created recovery media, see [Creating HP Recovery media \(select products only\) on page 60](#).

### What you need to know before you get started

- HP Recovery Manager recovers only software that was installed at the factory. For software not provided with this computer, you must either download the software from the manufacturer's website or reinstall the software from the media provided by the manufacturer.

---

 **IMPORTANT:** Recovery through HP Recovery Manager should be used as a final attempt to correct computer issues.

---

- HP Recovery media must be used if the computer hard drive fails. If you have not already created recovery media, see [Creating HP Recovery media \(select products only\) on page 60](#).
- To use the Factory Reset option (select products only), you must use HP Recovery media. If you have not already created recovery media, see [Creating HP Recovery media \(select products only\) on page 60](#).
- If your computer does not allow the creation of HP Recovery media or if the HP Recovery media does not work, you can obtain recovery media for your system from support. See the *Worldwide Telephone Numbers* booklet included with the computer. You can also find contact information from the HP

website. Go to <http://www.hp.com/support>, select your country or region, and follow the on-screen instructions.

---

 **IMPORTANT:** HP Recovery Manager does not automatically provide backups of your personal data. Before beginning recovery, back up any personal data you want to retain.

---

Using HP Recovery media, you can choose from one of the following recovery options:

---

 **NOTE:** Only the options available for your computer display when you start the recovery process.

---

- System Recovery—Reinstalls the original operating system, and then configures the settings for the programs that were installed at the factory.
- Factory Reset—Restores the computer to its original factory state by deleting all information from the hard drive and re-creating the partitions. Then it reinstalls the operating system and the software that was installed at the factory.

The HP Recovery partition (select products only) allows System Recovery only.

## Using the HP Recovery partition (select products only)

The HP Recovery partition allows you to perform a system recovery without the need for recovery discs or a recovery USB flash drive. This type of recovery can be used only if the hard drive is still working.

To start HP Recovery Manager from the HP Recovery partition:

---

 **IMPORTANT:** For a tablet with a detachable keyboard, connect the tablet to the keyboard base before beginning these steps (select products only).

---

1. Type `recovery` in the taskbar search box, select **HP Recovery Manager**, and then select **Windows Recovery Environment**.

– or –

For computers or tablets with keyboards attached, press **f11** while the computer boots, or press and hold **f11** as you press the power button.

For tablets without keyboards:

- Turn on or restart the tablet, and then quickly hold down the volume up button; then select **f11**.
- or –
- Turn on or restart the tablet, and then quickly hold down the volume down button; then select **f11**.
2. Select **Troubleshoot** from the boot options menu.
  3. Select **Recovery Manager**, and then follow the on-screen instructions.

## Using HP Recovery media to recover

You can use HP Recovery media to recover the original system. This method can be used if your system does not have an HP Recovery partition or if the hard drive is not working properly.

1. If possible, back up all personal files.
2. Insert the HP Recovery media, and then restart the computer.

---

 **NOTE:** If the computer does not automatically restart in HP Recovery Manager, change the computer boot order. See [Changing the computer boot order on page 64](#).

---

3. Follow the on-screen instructions.

## Changing the computer boot order

If your computer does not restart in HP Recovery Manager, you can change the computer boot order, which is the order of devices listed in BIOS where the computer looks for startup information. You can change the selection to an optical drive or a USB flash drive.

To change the boot order:



---

**IMPORTANT:** For a tablet with a detachable keyboard, connect the tablet to the keyboard base before beginning these steps.

---

1. Insert the HP Recovery media.
2. Access the system **Startup** menu.

For computers or tablets with keyboards attached:

- ▲ Turn on or restart the computer or tablet, quickly press **esc**, and then press **f9** for boot options.

For tablets without keyboards:

- ▲ Turn on or restart the tablet, and then quickly hold down the volume up button; then select **f9**.

– or –

Turn on or restart the tablet, and then quickly hold down the volume down button; then select **f9**.

3. Select the optical drive or USB flash drive from which you want to boot.
4. Follow the on-screen instructions.

## Removing the HP Recovery partition (select products only)

HP Recovery Manager software allows you to remove the HP Recovery partition to free up hard drive space.



---

**IMPORTANT:** After you remove the HP Recovery partition, you will not be able to perform System Recovery or create HP Recovery media from the HP Recovery partition. So before you remove the Recovery partition, create HP Recovery media; see [Creating HP Recovery media \(select products only\) on page 60](#).

---



---

**NOTE:** The Remove Recovery Partition option is only available on products that support this function.

---

Follow these steps to remove the HP Recovery partition:

1. Type `recovery` in the taskbar search box, and then select **HP Recovery Manager**.
2. Select **Remove Recovery Partition**, and then follow the on-screen instructions.



# 10 Power cord set requirements

The wide-range input feature of the computer permits it to operate from any line voltage from 100 to 120 volts AC, or from 220 to 240 volts AC.

The 3-conductor power cord set included with the computer meets the requirements for use in the country or region where the equipment is purchased.

Power cord sets for use in other countries and regions must meet the requirements of the country or region where the computer is used.

## Requirements for all countries

The following requirements are applicable to all countries and regions:

- The length of the power cord set must be at least **1.0 m** (3.2 ft) and no more than **1.8 m** (6 ft).
- All power cord sets must be approved by an acceptable accredited agency responsible for evaluation in the country or region where the power cord set will be used.
- The power cord sets must have a minimum current capacity of 10 amps and a nominal voltage rating of 125 or 250 V AC, as required by the power system of each country or region.
- The appliance coupler must meet the mechanical configuration of an EN 60 320/IEC 320 Standard Sheet C13 connector for mating with the appliance inlet on the back of the computer.

## Requirements for specific countries and regions

Country/region	Accredited agency	Applicable note number
Australia	EANSW	1
Austria	OVE	1
Belgium	CEBC	1
Canada	CSA	2
Denmark	DEMKO	1
Finland	FIMKO	1
France	UTE	1
Germany	VDE	1
Italy	IMQ	1
Japan	METI	3
The Netherlands	KEMA	1
Norway	NEMKO	1
The People's Republic of China	COC	5
South Korea	EK	4

Country/region	Accredited agency	Applicable note number
Sweden	SEMKO	1
Switzerland	SEV	1
Taiwan	BSMI	4
The United Kingdom	BSI	1
The United States	UL	2

1. The flexible cord must be Type H05VV-F, 3-conductor, 1.0-mm<sup>2</sup> conductor size. Power cord set fittings (appliance coupler and wall plug) must bear the certification mark of the agency responsible for evaluation in the country or region where it will be used.
2. The flexible cord must be Type SPT-3 or equivalent, No. 18 AWG, 3-conductor. The wall plug must be a two-pole grounding type with a NEMA 5-15P (15 A, 125 V) or NEMA 6-15P (15 A, 250 V) configuration.
3. The appliance coupler, flexible cord, and wall plug must bear a “T” mark and registration number in accordance with the Japanese Dentori Law. The flexible cord must be Type VCT or VCTF, 3-conductor, 1.00-mm<sup>2</sup> conductor size. The wall plug must be a two-pole grounding type with a Japanese Industrial Standard C8303 (7 A, 125 V) configuration.
4. The flexible cord must be Type RVV, 3-conductor, 0.75-mm<sup>2</sup> conductor size. Power cord set fittings (appliance coupler and wall plug) must bear the certification mark of the agency responsible for evaluation in the country or region where it will be used.
5. The flexible cord must be Type VCTF, 3-conductor, 0.75-mm<sup>2</sup> conductor size. Power cord set fittings (appliance coupler and wall plug) must bear the certification mark of the agency responsible for evaluation in the country or region where it will be used.

---

# 11 Recycling

When a non-rechargeable or rechargeable battery has reached the end of its useful life, do not dispose of the battery in general household waste. Follow the local laws and regulations in your area for battery disposal.

HP encourages customers to recycle used electronic hardware, HP original print cartridges, and rechargeable batteries. For more information about recycling programs, see the HP Web site at <http://www.hp.com/recycle>.

# Index

- A**
  - AC adapter and battery 5
  - AC adapter, spare part numbers 18
  - action keys
    - identifying 10
  - adapter, spare part numbers 18
  - audio, product description 2
  - audio-out (headphone)/audio-in (microphone) jack, identifying 4
- B**
  - backups 60
  - battery
    - removal 26
    - spare part numbers 16, 26
  - BIOS
    - determining version 54
    - downloading an update 55
    - starting the Setup Utility 54
    - updating 54
  - Bluetooth label 12
  - boot order
    - changing 64
  - bottom 12
  - bottom cover
    - removal 24
    - spare part number 17, 24
  - buttons
    - left TouchPad 7
    - power 9
    - right TouchPad 7
- C**
  - camera lights, identifying 6
  - cameras
    - identifying 6
  - caps lock light, identifying 8
  - components
    - bottom 11
    - display 6
    - left side 5
    - right side 4
    - top 7
- computer**
  - major components 13
  - specifications 58
  - connector, power 5
- D**
  - display assembly
    - removal 51
    - spare part numbers 14
  - display panel
    - product description 1
  - drive light, identifying 5
  - DVD±RW DL SuperMulti Drive
    - removal 35
    - spare part number 15, 17, 35
- E**
  - esc key, identifying 10
- F**
  - fan
    - removal 49
    - spare part number 16, 49
  - fn key, identifying 10
  - foot strip
    - removal 24
    - spare part numbers 17, 24
- G**
  - graphics, product description 1
- H**
  - hard drive
    - product description 2
    - removal 31
    - spare part number 15, 31
  - hard drive cable
    - removal 31
    - spare part number 15, 31
  - hard drive rubber bracket
    - removal 32, 36
    - spare part number 15, 31
  - HDMI port
    - identifying 4
  - HDMI-to-VGA adapter, spare part number 18
  - heat sink
    - removal 47
    - spare part number 16, 47
  - hinge cover, spare part number 14
  - HP PC Hardware Diagnostics (UEFI) using 56
  - HP Recovery Manager
    - correcting boot problems 64
    - starting 63
  - HP Recovery media
    - creating 60
    - recovery 63
  - HP Recovery partition
    - recovery 63
    - removing 64
- I**
  - I/O Bracket Kit
    - contents 15
    - spare part number 15
  - integrated numeric keypad, identifying 10
  - internal microphones, identifying 6
- J**
  - jacks
    - audio-out (headphone)/audio-in (microphone) 4
    - network 5
    - RJ-45 (network) 5
- K**
  - keyboard
    - product description 3
  - keyboard/top cover, spare part numbers 14
  - keys
    - action 10
    - esc 10
    - fn 10
    - Windows 10

## L

### labels

- Bluetooth 12
- regulatory 12
- serial number 12
- service 12
- wireless certification 12
- WLAN 12

### lights

- AC adapter and battery light 5
- caps lock 8
- drive 5
- mute 8
- power 8
- RJ-45 (network) status 5

## M

- memory card reader, identifying 4
- memory card, identifying 4
- memory module
  - product description 1
  - removal 29
  - spare part numbers 16, 29
- microphone
  - product description 2
- minimized image recovery 63
- minimized image, creating 62
- model name 1
- mute light, identifying 8

## N

- network jack, identifying 5

## O

- operating system, product description 3
- optical drive
  - product description 2
  - removal 35
  - spare part number 15, 17, 35
- optical drive bezel, spare part number 15, 17, 35
- optical drive bracket
  - removal 35
  - spare part number 15, 17, 35
- optical drive eject button, identifying 5
- optical drive, identifying 5
- original system recovery 62

## P

- plastic support bridge
  - removal 45
  - spare part number 45
- pointing device, product description 3
- ports
  - HDMI 4
  - product description 3
  - USB 3.0 5
  - USB 3.0 (powered) charging 4
  - USB Type-C 4
- power button, identifying 9
- power connector cable
  - removal 39
  - spare part number 15, 39
- power connector cable bracket, removal 39, 45
- power connector, identifying 5
- power cord
  - set requirements 65
  - spare part numbers 18
- power lights, identifying 8
- power requirements, product description 3
- processor
  - product description 1
- product description
  - audio 2
  - display panel 1
  - external media cards 2
  - graphics 1
  - hard drive 2
  - keyboard 3
  - memory module 1
  - microphone 2
  - operating system 3
  - optical drive 2
  - pointing device 3
  - ports 3
  - power requirements 3
  - processors 1
  - product name 1
  - security 3
  - sensors 2
  - serviceability 3
  - solid-state drive 2
  - video 2
  - wireless 2
- product name 1

- product name and number, computer 12

## R

- recover
    - options 62
  - recovery
    - discs 61, 63
    - HP Recovery Manager 62
    - media 63
    - starting 63
    - supported discs 61
    - system 62
    - USB flash drive 63
    - using HP Recovery media 61
  - recovery media
    - creating 60
    - creating using HP Recovery Manager 61
  - recovery partition
    - removing 64
  - regulatory information
    - regulatory label 12
    - wireless certification labels 12
  - removal/replacement procedures 24
  - RJ-45 (network) jack, identifying 5
  - RJ-45 (network) status lights, identifying 5
  - RTC battery
    - removal 30
    - spare part number 16, 30
  - Rubber Kit, spare part numbers 17, 24
- ## S
- Screw Kit, spare part number 18
  - security cable slot, identifying 5
  - security, product description 3
  - sensors, product description 2
  - serial number 12
  - serial number, computer 12
  - service labels, locating 12
  - serviceability, product description 3
  - slots
    - memory card reader 4
    - security cable 5
  - solid-state drive
    - product description 2

- removal 27
- spare part numbers 15, 27
- speakers
  - identifying 9
  - removal 50
  - spare part number 15, 50
- specifications 58
- supported discs, recovery 61
- system board
  - removal 43
  - spare part numbers 15, 43
- system recovery 62
- system restore point
  - creating 61
- system restore point, creating 60

## T

- TouchPad
  - buttons 7
  - removal 37
  - spare part number 14, 37
- TouchPad bracket
  - removal 37
  - spare part number 15, 37
- TouchPad cable
  - removal 28
  - spare part number 15, 28
- TouchPad zone, identifying 7
- traveling with the computer 12

## U

- USB 3.0 charging (powered) port,
  - identifying 4
- USB 3.0 port, identifying 5
- USB board
  - removal 40
  - spare part number 40
- USB board bracket, removal 40
- USB board cable
  - removal 42
  - spare part numbers 14, 42
- USB Type-C port, identifying 4
- USB-Type C-to-USB 3.0 adapter,
  - spare part number 18

## V

- vents, identifying 9, 11
- video, product description 2

## W

- Windows
  - system restore point 60, 61
- Windows key, identifying 10
- Windows tools
  - using 61
- wireless certification label 12
- wireless, product description 2
- WLAN antennas, identifying 6
- WLAN device 12
- WLAN label 12
- WLAN module
  - removal 33
  - spare part number 16, 33