



# HP ZBook 15 G4 Mobile Workstation

**Maintenance and Service Guide**  
**IMPORTANT! This document is intended for**  
**HP authorized service providers only.**

© Copyright 2017 HP Development Company, L.P.

AMD is a trademark of Advanced Micro Devices, Inc. Bluetooth is a trademark owned by its proprietor and used by HP Inc. under license. Intel, Celeron, and Pentium are trademarks of Intel Corporation in the U.S. and other countries. Microsoft and Windows are trademarks of the Microsoft group of companies.

In accordance with Microsoft's support policy, HP does not support the Windows 8 or Windows 7 operating system on products configured with Intel and AMD 7th generation and forward processors or provide any Windows 8 or Windows 7 drivers on <http://www.support.hp.com>.

The information contained herein is subject to change without notice. The only warranties for HP products and services are set forth in the express warranty statements accompanying such products and services. Nothing herein should be construed as constituting an additional warranty. HP shall not be liable for technical or editorial errors or omissions contained herein.

First Edition: April 2017

Document Part number: 915575-001

## Product notice

This guide describes features that are common to most models. Some features may not be available on your computer.

Not all features are available in all editions or versions of Windows. Systems may require upgraded and/or separately purchased hardware, drivers, software or BIOS update to take full advantage of Windows functionality. Windows 10 is automatically updated, which is always enabled. ISP fees may apply and additional requirements may apply over time for updates. Go to <http://www.microsoft.com> for details.

To access the latest user guides or manuals for your product, go to <http://www.hp.com/support>, and select your country. Select **Find your product**, and then follow the on-screen instructions.

## Software terms

By installing, copying, downloading, or otherwise using any software product preinstalled on this computer, you agree to be bound by the terms of the HP End User License Agreement (EULA). If you do not accept these license terms, your sole remedy is to return the entire unused product (hardware and software) within 14 days for a full refund subject to the refund policy of your seller.

For any further information or to request a full refund of the price of the computer, please contact your seller.

## Safety warning notice

---

 **WARNING!** To reduce the possibility of heat-related injuries or of overheating the computer, do not place the computer directly on your lap or obstruct the computer air vents. Use the computer only on a hard, flat surface. Do not allow another hard surface, such as an adjoining optional printer, or a soft surface, such as pillows or rugs or clothing, to block airflow. Also, do not allow the AC adapter to contact the skin or a soft surface, such as pillows or rugs or clothing, during operation. The computer and the AC adapter comply with the user-accessible surface temperature limits defined by the International Standard for Safety of Information Technology Equipment (IEC 60950-1).

---



---

# Table of contents

<b>1 Product description .....</b>	<b>1</b>
<b>2 Components .....</b>	<b>6</b>
Right .....	6
Left .....	8
Display .....	9
Keyboard area .....	10
TouchPad .....	10
Lights .....	11
Buttons and fingerprint reader .....	12
Special keys .....	13
Action keys .....	14
Bottom .....	15
Front .....	16
Labels .....	17
<b>3 Illustrated parts catalog .....</b>	<b>18</b>
Computer major components .....	18
Bracket Kit .....	21
Display assembly subcomponents .....	22
Cable Kit .....	23
Plastics Kit .....	24
Mass storage devices .....	25
Miscellaneous parts .....	26
<b>4 Removal and replacement procedures preliminary requirements .....</b>	<b>27</b>
Tools required .....	27
Service considerations .....	27
Plastic parts .....	27
Cables and connectors .....	28
Drive handling .....	28
Grounding guidelines .....	28
Electrostatic discharge damage .....	28
Packaging and transporting guidelines .....	30
Workstation guidelines .....	30

<b>5 Removal and replacement procedures for Authorized Service Provider parts .....</b>	<b>32</b>
Component replacement procedures .....	32
Display subcomponents (bezel, panel, camera) .....	32
Bottom cover .....	36
Battery .....	37
Memory module .....	38
Solid-state drive (M.2) .....	40
WLAN module .....	41
WWAN module .....	43
Smart card reader .....	45
Hard drive .....	46
RTC battery .....	48
Keyboard .....	49
Heat sink assembly .....	52
Graphics board .....	56
Speakers .....	57
TouchPad module .....	58
LED board .....	59
Fans .....	60
Fingerprint reader board .....	61
System board .....	62
Display assembly .....	65
Lock bracket .....	73
<b>6 Troubleshooting guide .....</b>	<b>74</b>
Resources .....	75
General troubleshooting steps .....	75
Identify the issue .....	76
1. Understand the issue .....	76
Boot up sequence .....	76
Failure classification .....	76
2. Examine the environment .....	78
3. Perform a visual inspection of hardware .....	79
4. Update BIOS and drivers .....	79
Manually updating BIOS and drivers .....	79
Remotely deploying BIOS and drivers .....	79
Analyze the issue .....	79
5. Remove or uninstall recently added hardware, software .....	79
6. HP Hardware Diagnostics and Tools .....	80
HP PC Hardware Diagnostics (UEFI) .....	80
HP Support Assistant (HPSA) .....	82

HP BIOS Configuration Utility (BCU) .....	83
HP Image Diagnostic Tool .....	83
HP Thermal Monitor .....	83
Non HP diagnostics tools .....	83
7. Status lights, blinking light codes, troubleshooting lights, and POST error messages .....	84
Status lights .....	84
Interpreting system validation diagnostic front panel LEDs and audible codes .....	85
POST error messages .....	86
Power Good (Troubleshooting) lights .....	88
Resolve the issue .....	89
8. Hard reset .....	89
9. Soft reset (Default Settings) .....	90
10. Reseat cables and connections .....	90
11. Test with minimum configuration .....	91
Essential hardware configuration .....	91
Safe mode .....	92
12. Test with verified working configuration (hardware and/or operating system) .....	92
13. Replace the system board .....	92
Verify solution .....	93
Helpful Hints .....	93
At startup .....	93
During operation .....	94
Consulting with HP Service .....	94
Common issues and possible solutions .....	95
Power-on issues .....	95
No Power .....	95
Intermittent power-on, shutdown, reboot .....	97
AC adapter issue .....	98
Battery not recognized, not charging .....	99
Battery discharges too fast .....	100
Burnt smell .....	101
POST .....	101
No video (with power) .....	101
Blinking lights .....	102
Diagnostics error messages .....	103
BIOS password .....	104
Performance (OS) .....	104
Intermittent shutdown .....	105
Blue screen .....	106

Freeze at Windows Logo (hang/lockup) .....	108
Electromagnetic Interference (EMI) .....	109
No wake up .....	110
Unresponsive .....	111
Slow performance .....	111
HP Smart Adapter warning message .....	112
Incorrect time and date .....	112
Display .....	113
Display anomalies .....	113
Symptom .....	113
Quick check .....	114
HP PC Hardware Diagnostics (UEFI) for video test .....	114
Display assembly diagram .....	115
Dead pixel .....	115
No video (internal) .....	115
No video (external) .....	116
DisplayPort/VGA .....	116
HDMI .....	116
No or bad external video via docking .....	117
Incorrect or missing color/distorted image .....	117
Touch screen .....	118
I/O devices .....	119
Keyboard .....	119
Keyboard point stick .....	120
Keyboard backlight .....	120
TouchPad .....	121
Network Connectivity Ethernet (RJ-45 jack) .....	121
Network connectivity wireless (WLAN) .....	122
WWAN .....	123
USB .....	124
Smart card reader .....	125
Speaker, headphone - audio issues .....	126
Thunderbolt (TB) .....	127
Thunderbolt 3 dock .....	128
Storage .....	129
Hard drive/solid-state drive not recognized .....	130
No boot to operating system (no read/write error) .....	130
Read-write error .....	131
Slow performance .....	131
Blue screen (BSOD) error .....	131
Noisy hard drive .....	132



Mechanical .....	133
Fan error message - 90B .....	133
Noise (sound) .....	134
Fan runs constantly .....	135
Thermal shutdown (hot) .....	136
Stuck power button .....	137
Additional information .....	137
Acronyms .....	137
Blinking lights and boot error codes .....	138
Processor not executing code .....	138
BIOS recovery code unable to find valid BIOS recovery image .....	138
Memory module error .....	139
Graphics Controller Error (No Controller) .....	139
Failure - System Board Error .....	139
Intel Trusted Execution Technology (TXT) Error .....	139
Sure Start unable to find valid BIOS Boot Block image .....	139
Sure Start has identified a problem (Manual Recovery Policy Set) .....	140
POST Error Messages and User Actions .....	140
Routine Maintenance for Performance Improvement .....	141
Common Blue Screen Error Messages .....	142
Error message list .....	142
Bug check symbolic names .....	142
Microsoft general troubleshooting of Windows bug check codes .....	143
Use Windows Debugging Tool .....	143
Windows Software Development Kit (SDK) .....	144
Display Issue: Pixel Anomalies .....	148
Cable management .....	149
Connector types .....	150
<b>7 Computer Setup (BIOS), TPM, and HP Sure Start .....</b>	<b>152</b>
Using Computer Setup .....	152
Starting Computer Setup .....	152
Using a USB keyboard or USB mouse to start Computer Setup (BIOS) .....	152
Navigating and selecting in Computer Setup .....	152
Restoring factory settings in Computer Setup .....	153
Updating the BIOS .....	153
Determining the BIOS version .....	153
Downloading a BIOS update .....	154
Changing the boot order using the f9 prompt .....	155
TPM BIOS settings (select products only) .....	155
Using HP Sure Start (select products only) .....	155

<b>8 Using HP PC Hardware Diagnostics (UEFI) .....</b>	<b>156</b>
Downloading HP PC Hardware Diagnostics (UEFI) to a USB device .....	156
<b>9 Backing up, restoring, and recovering .....</b>	<b>158</b>
Creating recovery media and backups .....	158
Creating HP Recovery media (select products only) .....	158
Using Windows tools .....	159
Restore and recovery .....	160
Recovering using HP Recovery Manager .....	160
What you need to know before you get started .....	160
Using the HP Recovery partition (select products only) .....	161
Using HP Recovery media to recover .....	161
Changing the computer boot order .....	162
Removing the HP Recovery partition (select products only) .....	163
<b>10 Specifications .....</b>	<b>164</b>
Computer specifications .....	164
Hard drive specifications .....	165
M.2 solid-state drive specifications .....	166
M.2 PCIe solid-state drive specifications .....	167
<b>11 Statement of memory volatility .....</b>	<b>168</b>
Nonvolatile memory usage .....	170
Questions and answers .....	172
Using HP Sure Start (select models only) .....	173
<b>12 Power cord set requirements .....</b>	<b>174</b>
Requirements for all countries .....	174
Requirements for specific countries and regions .....	175
<b>13 Recycling .....</b>	<b>177</b>
<b>Index .....</b>	<b>178</b>

# 1 Product description

Category	Description
<b>Product Name</b>	HP ZBook 15 G4 Mobile Workstation
<b>Processors</b>	<p><b>7th Generation Intel® Core™ processors</b></p> <p>Intel Core i7-7820HQ 2.9-GHz (turbo up to 3.9-GHz) processor (2400-MHz front-side bus (FSB), 8.0-MB L3 cache, 45 W)</p> <p>Intel Core i7-7700HQ 2.8-GHz (turbo up to 3.8-GHz) processor (2400-MHz FSB, 6.0-MB L3 cache, 45 W)</p> <p>Intel Core i5-7440HQ 2.8-GHz (turbo up to 3.8-GHz) processor (2400-MHz FSB, 6.0-MB L3 cache, 45 W)</p> <p>Intel Core i5-7300HQ 2.5-GHz (turbo up to 3.5-GHz) processor (2400-MHz FSB, 6.0-MB L3 cache, 45 W)</p> <p><b>7th Generation Intel Xeon processors</b></p> <p>Intel Xeon E3-1535M v6, 3.1-GHz (turbo up to 4.2-GHz) processor (2400-MHz front-side bus (FSB), 8.0-MB L3 cache, 45 W)</p> <p>Intel Xeon E3-1505M v6, 3.0-GHz (turbo up to 4.0-GHz) processor (2133-MHz front-side bus (FSB), 8.0-MB L3 cache, 45 W)</p>
<b>Chipset</b>	Mobile Intel CM238 chipset
<b>Graphics</b>	<p><b>Intel UMA Graphics - with shared video memory</b></p> <p>GT2 Integrated Graphics</p> <p><b>Discrete MXM daughter card</b></p> <ul style="list-style-type: none"><li>• NVIDIA® Quadro® M2200M (N17P-Q3 with 4-GB GDDR5 graphics subsystem memory (256-MB×32, 1.35-V, 6Gbps, Qty 4)</li><li>• NVIDIA Quadro M1200M (N17P-Q1 with 4-GB GDDR5 graphics subsystem memory (256-MB×32, 1.35-V, 6Gbps, Qty 4)</li><li>• NVIDIA Quadro M620 (N17M-Q3 with 2-GB GDDR5 graphics subsystem memory (128-MB×32, 1.35-V, 6 or 7 Gbps, Qty 4)</li><li>• AMD Radeon Pro™ WX4150 (256-MB×32, 1.35-V, 1500 MHz, Qty 4)</li></ul> <p>Support "No Discrete Graphics" option</p> <p>Support for hybrid (switchable) graphics</p> <p>Support NVIDIA Optimus Technology</p> <p>Support AMD Enduro Technology</p> <p>Support for open GL</p> <p>Support for DisplayPort 1.2 (supported through Thunderbolt 3)</p> <p>Support for up to 4 total displays (discrete); 3 displays (UMA) through docking station</p> <p>Support for NVIDIA Mosaic Technology</p> <p>Support AMD Eyefinity Technology</p>

Category	Description
<b>Panel</b>	<p><b>39.6 cm</b> (15.6 in), antiglare, LED backlight, 16:9 aspect ratio</p> <ul style="list-style-type: none"> <li>FHD (1920×1080), SVA, 60% CG, slim, 300 nits with or without camera</li> <li>FHD (1920×1080), UWVA, 72% CG, slim, 300 nits with or without camera</li> <li>FHD (1920×1080), UWVA, 72% CG, slim, 300 nits, touch screen, with camera</li> <li>UHD (3840×2160), UWVA, Dream Color 3, 95% NTSC, 340 nits with or without camera</li> </ul>
<b>Memory</b>	<p>Four customer-accessible/upgradable memory module slots</p> <p>Support for DDR4 2133-MHz, dual channel memory</p> <p>Support for DDR4 2400-MHz, single channel memory</p> <p>Support for 64-GB of system RAM in the following configurations:</p> <p>DDR4-2400 (for use in models with Core processors):</p> <ul style="list-style-type: none"> <li>65536-MB total system memory (16384-MB×4)</li> <li>32768-MB total system memory (16384-MB×2 or 8192-MB×4)</li> <li>16384-MB total system memory (16384-MB×1, 8192-MB×2, or 4096-MB×4)</li> <li>8192-MB total system memory (8192-MB×1, 4096-MB×2)</li> </ul> <p>ECC DDR4-2400 (for use in models with Xeon processors):</p> <ul style="list-style-type: none"> <li>65536-MB total system memory (16384-MB×4)</li> <li>32768-MB total system memory (16384-MB×2 or 8192-MB×4)</li> <li>16384-MB total system memory (16384-MB×1, 8192-MB×2)</li> <li>8192-MB total system memory (8192-MB×1)</li> </ul>
<b>Primary M.2</b>	<p><b>M.2 (NGFF) SS/DS Solid State Drive (2280)</b></p> <p><b>SATA</b></p> <p>512-GB SATA-3 SS TLC FIPS-140-2</p> <p>256-GB SATA-3 Self-Encrypting Drive (Opal 2) TLC</p> <p><b>PCIe</b></p> <p>1-TB, NVMe, MLC (Z Turbo Drive)</p> <p>512-GB, NVMe, MLC (Z Turbo Drive)</p> <p>512-GB, NVMe, Opal 2, TLC (Z Turbo Drive)</p> <p>256-GB, NVMe, MLC (Z Turbo Drive)</p> <p>256-GB, NVMe, TLC (Z Turbo Drive)</p>
<b>Secondary M.2</b>	<p><b>M.2 (NGFF) SS/DS Solid State Drive (2280) (only available if primary M.2 drive is selected):</b></p> <p><b>SATA</b></p> <p>512-GB SATA-3 SS TLC FIPS-140-2</p> <p>256-GB SATA-3 Self-Encrypting Drive (Opal 2) TLC</p> <p><b>PCIe</b> (not available if primary M.2 SATA drive is selected)</p> <p>1-TB, NVMe, MLC (Z Turbo Drive)</p> <p>512-GB, NVMe, MLC (Z Turbo Drive)</p> <p>512-GB, NVMe, Opal 2, TLC (Z Turbo Drive)</p>

Category	Description
	256-GB, NVMe, MLC (Z Turbo Drive)
	256-GB, NVMe, TLC (Z Turbo Drive)
<b>Primary 2.5-in SATA hard drive</b>	<p>Primary 2.5-in storage not required if PCIe SSD selected</p> <p>Support for 6.35-cm (2.5-in) hard drives in 7.0-mm (.28-in) thickness</p> <p>Support for 3D DriveGuard hard drive protection</p> <p>Support for the following hard drives:</p> <ul style="list-style-type: none"> <li>• 1-TB, 5400-rpm</li> <li>• 500-GB, 7200-rpm</li> <li>• 500-GB, 7200-rpm, self-encrypting drive, OPAL 2</li> <li>• 500-GB, 5400-rpm, self-encrypting drive, FIPS</li> <li>• 500-GB, 5400-rpm, hybrid SSD 8 GB cache</li> </ul> <p>Support for the following 6.35-cm (2.5-in) solid-state drives:</p> <ul style="list-style-type: none"> <li>• 1-TB SATA-3, TLC</li> <li>• 256-GB SATA-3, TLC</li> </ul>
<b>Audio and video</b>	<p>Stereo speakers (2)</p> <p>Dual array microphone (dual mic configuration tied to camera)</p> <p>HP Bang &amp; Olufsen Audio</p> <p>HD 720p camera</p> <p>Intel SST Audio</p> <p>Support for no camera option</p>
<b>Ethernet</b>	<p>Intel I219-LM Gigabit Network Connection (10/100/1000 Ethernet)</p> <p>S3/S4/S5 wake on LAN</p>
<b>Wireless</b>	<p><b>WLAN</b></p> <p>WLAN options via minicard</p> <p>Two WLAN antennas built into display assembly</p> <p>Support "No WLAN/No Bluetooth" option</p> <p>Bluetooth Disabled IOPT</p> <p>Support for Miracast</p> <p>Support for the following WLAN formats:</p> <ul style="list-style-type: none"> <li>• Intel Dual band wireless-AC 8265 802.11AC 2x2 WiFi + BT 4.2 Combo Adaptor (vPro)</li> <li>• Intel Dual band wireless-AC 8265 802.11AC 2x2 WiFi + BT 4.2 Combo Adaptor (non-vPro)</li> </ul> <p><b>WPAN</b></p> <p>Bluetooth® 4.2 only supported via combo card</p> <p><b>WWAN</b></p> <p>SIM Module (3FF/mini SIM) (user accessible behind battery)</p> <p>Two WWAN antennas built into display assembly</p> <p>WWAN antennas (2) (world wide 5 band, configured at top of panel on all units except UHD)</p>

Category	Description
	<p>Supports "No WWAN" option</p> <p>Supports WWAN after market option</p> <p>Support for the following WWAN formats:</p> <ul style="list-style-type: none"> <li>• Huawei HP It4132, LTE/HSPA+ 4G w/GPS M.2</li> <li>• Fibocom HP hs3210 WW HSPA+ w/o GPS</li> </ul>
<b>External media cards</b>	Integrated SD UHS-II flash media slot (Realtek) - supports SD, SDHC, SDXC
<b>Ports</b>	<p>Multi-Pin AC Port</p> <p>Combination mic-in/stereo headphone jack</p> <p>(2) USB Type-C (Thunderbolt 3)</p> <p>RJ-45 (Ethernet)</p> <p>(1) USB 3.0 Charging Port (S3/S5)</p> <p>(2) USB 3.0 Ports</p> <p>HDMI</p> <p>VGA (Dsub 15 pin) supporting: 1920×1200 external resolution @ 75 Hz, hot plug and unplug and auto detection for correct output to wide-aspect vs. standard aspect video</p>
<b>Docking</b>	Support for HP Thunderbolt Docking Station
<b>Keyboard/pointing devices</b>	<p><b>Keyboard</b></p> <p>Full-size, chiclet, island-style, backlit (and non-backlit) keyboard with numeric keypad</p> <p>DuraKeys</p> <p>Spill resistant with drain</p> <p>Windows 10 Dual Point (3 pick buttons point stick x 3 pick buttons TouchPad)</p> <p><b>TouchPad</b></p> <p>On/off button</p> <p>Glass with chemical etched surface (DuraPad)</p> <p>Support for 2-way scroll</p> <p>Taps enabled by default</p> <p>Gestures enabled by default:</p> <ul style="list-style-type: none"> <li>• 2-finger scrolling</li> <li>• 2-finger zoom (pinch)</li> </ul> <p>Image sensor TouchPad</p>
<b>Power requirements</b>	<p><b>AC adapter</b></p> <p>150-W HP Smart Adapter, slim</p> <p><b>Battery</b></p> <p>9-cell, 90-WHr, 2.635-AHr, Li-ion battery (long-life)</p> <p><b>Power cord (localized)</b></p> <p>3-wire plug (with ground pin) (C5) 1.0m with tags</p>
<b>Security</b>	Support security lock





<b>Category</b>	<b>Description</b>
	Trusted platform module (TPM 9670) 2.0 (Infineon; soldered down) Fingerprint reader Support "No Fingerprint Reader" option Integrated smart card reader BIOS preboot power on - BIOS option (password, fingerprint) Drive encryption preboot option - (password; fingerprint; selected smart cards)
<b>Operating system</b>	<b>Preinstalled</b> Windows 10 Home 64 High-end Windows 10 Home 64 High-end Single Language Windows 10 Home 64 Chinese Market CPPP Windows 10 Professional 64 FreeDOS 2.0  <b>Restore media</b> Windows 10 DRUSB Windows 10 DRDVD Win 10 Pro 64 OSUSB Win 10 Pro 64 OSDVD  <b>Supported</b> Red Hat Enterprise Linux (RHEL) 7.x 64 bit  <b>Web-only support</b> Windows 10 Enterprise 64 Windows 10 Enterprise 64 LTSB 1507  <b>Tested and documented</b> Windows 7 Professional 64 Windows 7 Enterprise 64
<b>Serviceability</b>	<b>End user replaceable parts</b> AC adapter

# 2 Components

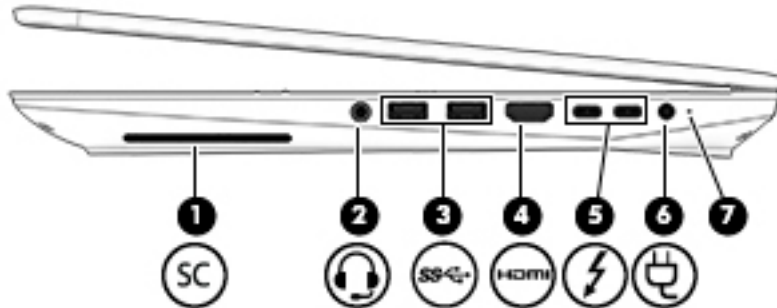

## Right

 **NOTE:** The term “hard drive”, “hard disk”, and/or “solid-state drive (SSD)” is used to generically refer the computer’s primary mass storage.









Component	Description
(1) 	Smart card reader Supports optional smart cards.
(2) 	Audio-out (headphone)/Audio-in (microphone) combo jack Connects optional powered stereo speakers, headphones, earbuds, a headset, or a television audio cable. Also connects an optional headset microphone. This jack does not support optional standalone microphones. <b>WARNING!</b> To reduce the risk of personal injury, adjust the volume before putting on headphones, earbuds, or a headset. For additional safety information, refer to the <i>Regulatory, Safety, and Environmental Notices</i> . To access this guide: <ol style="list-style-type: none"><li>1. Type <code>support</code> in the taskbar search box, and then select the <b>HP Support Assistant</b> app. – or – Click the question mark icon in the taskbar.</li><li>2. Select <b>My PC</b>, select the <b>Specifications</b> tab, and then select <b>User Guides</b>.</li></ol> <b>NOTE:</b> When a device is connected to the jack, the computer speakers are disabled.
(3) 	USB 3.x SuperSpeed ports (2) Connect a USB device, such as a cell phone, camera, activity tracker, or smartwatch, and provides high-speed data transfer.
(4) 	HDMI port Connects an optional video or audio device, such as a high-definition television, any compatible digital or audio component, or a high-speed High Definition Multimedia Interface (HDMI) device.

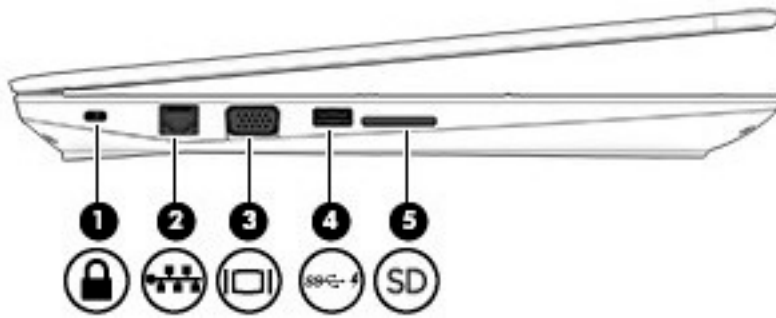

Component	Description
(5) 	<p>USB Type-C SuperSpeed and Thunderbolt ports (2)</p> <p>When the computer is on, connect and charge USB devices that have Type-C connectors, such as cell phones, cameras, activity trackers, or smartwatches, and provide high-speed data transfer.</p> <p>– or –</p> <p>Connect to various USB, video, HDMI, and LAN devices.</p> <p><b>NOTE:</b> Cables and/or adapters (purchased separately) may be required.</p> <p>– or –</p> <p>Connect a display device that has a USB Type-C connector, providing display output.</p> <p><b>NOTE:</b> Your computer may also support a Thunderbolt docking station.</p> <p>– or –</p> <p>Connect a DisplayPort device that has a USB Type-C connector, providing display output.</p>
(6) 	<p>Power connector</p> <p>Connects an AC adapter.</p>
(7)	<p>Battery light</p> <p>When AC power is connected:</p> <ul style="list-style-type: none"> <li>• White: The battery charge is greater than 90 percent.</li> <li>• Amber: The battery charge is from 0 to 90 percent.</li> <li>• Off: The battery is not charging.</li> </ul> <p>When AC power is disconnected (battery not charging):</p> <ul style="list-style-type: none"> <li>• Blinking amber: The battery has reached a low battery level. When the battery has reached a critical battery level, the battery light begins blinking rapidly.</li> <li>• Off: The battery is not charging.</li> </ul>

## Left



Component	Description
(1)  Security cable slot	Attaches an optional security cable to the computer. <b>NOTE:</b> The security cable is designed to act as a deterrent, but it may not prevent the computer from being mishandled or stolen.
(2)  RJ-45 (network) jack/status lights	Connects a network cable. <ul style="list-style-type: none"><li>• Green (right): The network is connected.</li><li>• Blinking amber (left): Activity is occurring on the network.</li></ul>
(3)  External monitor port	Connects an external VGA monitor or projector.
(4)  USB 3.x charging port	When the computer is on, connects and charges a USB device, such as a cell phone, camera, activity tracker, or smartwatch, and provides high-speed data transfer.
(5)  Memory card reader (select products only)	Reads optional memory cards that store, manage, share, or access information. To insert a card: <ol style="list-style-type: none"><li>1. Hold the card label-side up, with the connectors facing the computer.</li><li>2. Insert the card into the memory card reader, and then press in on the card until it is firmly seated.</li></ol> To remove a card: <ul style="list-style-type: none"><li>▲ Press in on the card, and then remove it from the memory card reader.</li></ul>

# Display

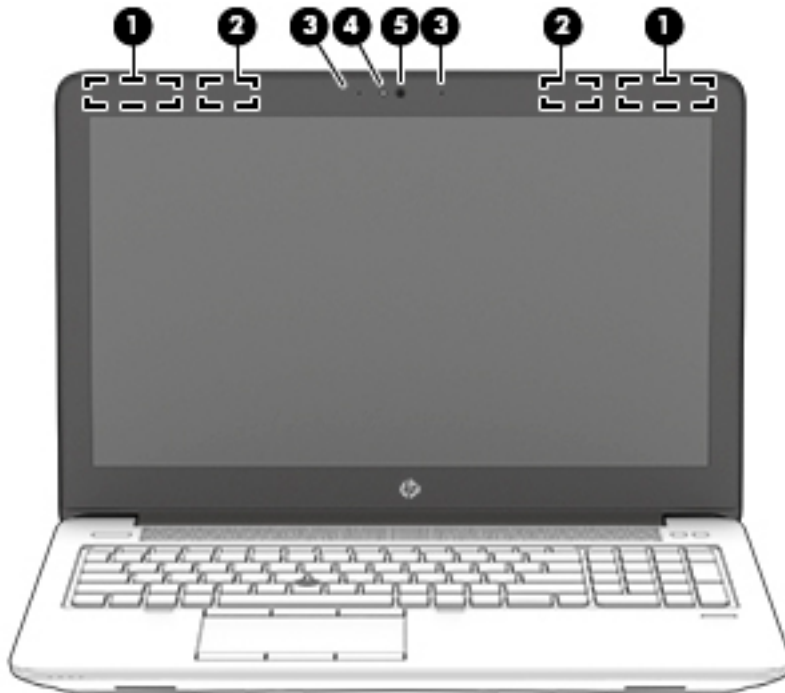

Component	Description
(1) WLAN antennas* (2) (internal; select products only)	Send and receive wireless signals to communicate with wireless local area networks (WLANs).
(2) WWAN antennas* (2) (internal; select products only)	Send and receive wireless signals to communicate with wireless wide area networks (WWANs).
(3) Internal microphones (2) (select products only)	Record sound.
(4) Camera light (select products only)	On: The camera is in use.
(5) Camera (select products only)	Records video and captures photographs. Some models allow you to video conference and chat online using streaming video.  To use the camera: ▲ Type <code>camera</code> in the taskbar search box, and then select <b>Camera</b> .

\*The antennas are not visible from the outside of the computer. For optimal transmission, keep the areas immediately around the antennas free from obstructions.

For wireless regulatory notices, see the section of the *Regulatory, Safety, and Environmental Notices* that applies to your country or region.

To access this guide:

1. Type `support` in the taskbar search box, and then select the **HP Support Assistant** app.  
– or –  
Click the question mark icon in the taskbar.
2. Select **My PC**, select the **Specifications** tab, and then select **User Guides**.

# Keyboard area



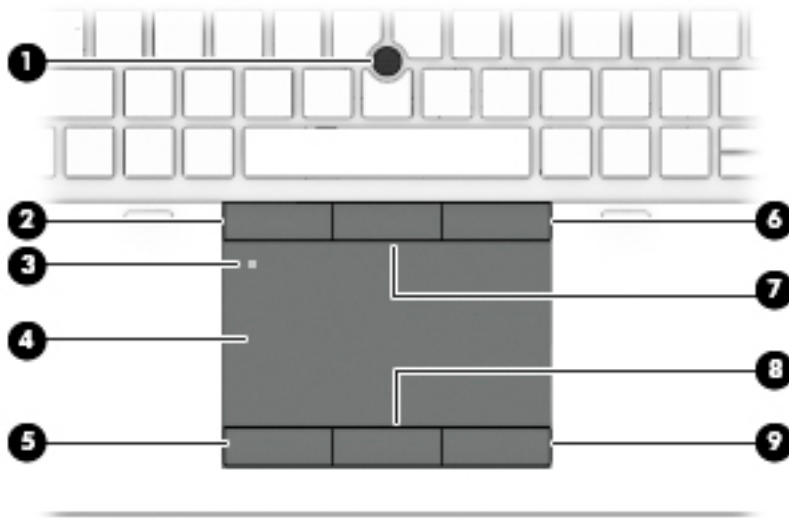

## TouchPad

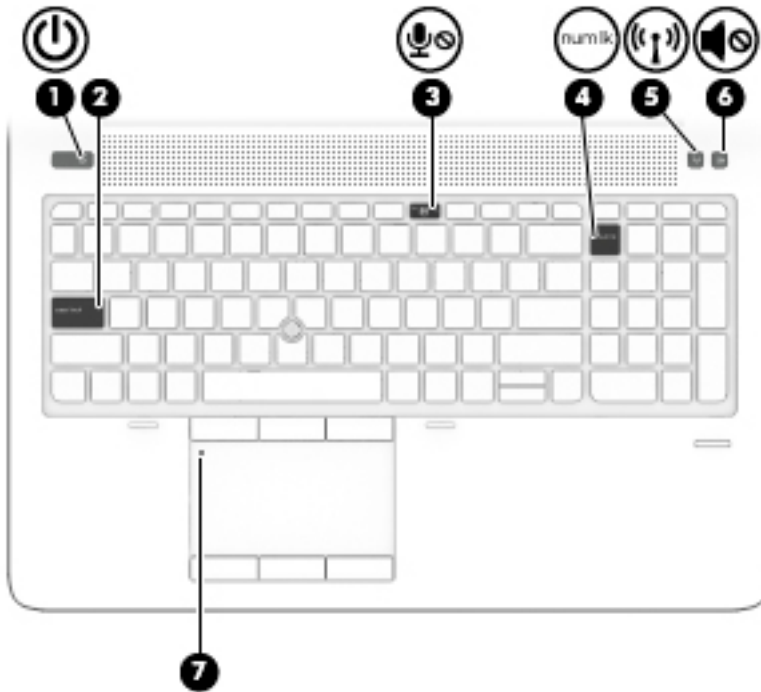

Component	Description
(1) Pointing stick	Moves the pointer on the screen.
(2) Left pointing stick button	Functions like the left button on an external mouse.
(3) TouchPad on/off button/TouchPad light	Turns the TouchPad on and off. <ul style="list-style-type: none"><li>• Amber: The TouchPad is off.</li><li>• Off: The TouchPad is on.</li></ul>
(4) TouchPad zone	Reads your finger gestures to move the pointer or activate items on the screen.
(5) Left TouchPad button	Functions like the left button on an external mouse.
(6) Right pointing stick button	Functions like the right button on an external mouse.
(7) Center pointing stick button	Functions like the center button on an external mouse.
(8) Center TouchPad button	Functions like the center button on an external mouse.
(9) Right TouchPad button	Functions like the right button on an external mouse.



## Lights

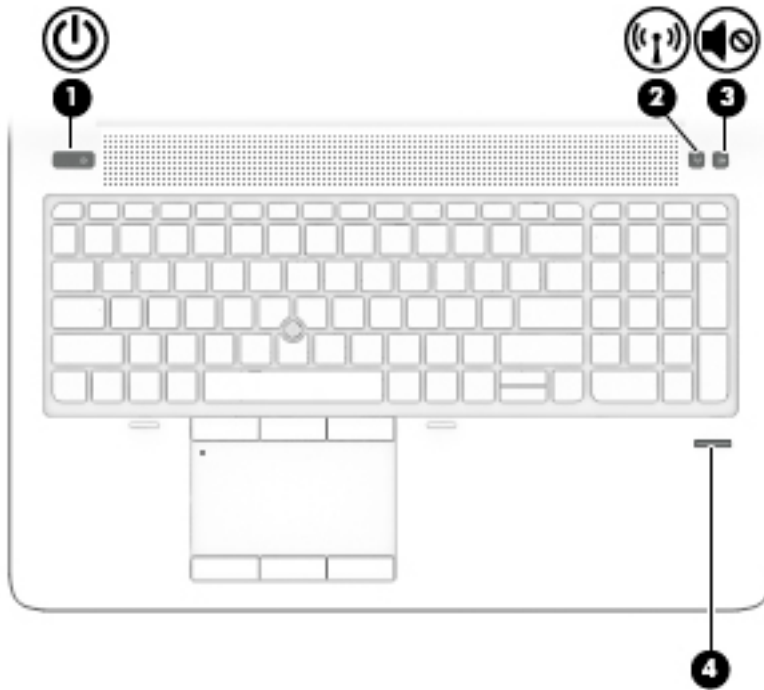

Component	Description
(1)  Power light	<ul style="list-style-type: none"> <li>On: The computer is on.</li> <li>Blinking: The computer is in the Sleep state, a power-saving state. The computer shuts off power to the display and other unneeded components.</li> <li>Off: The computer is off or in Hibernation. Hibernation is a power-saving state that uses the least amount of power.</li> </ul>
(2) Caps lock light	On: Caps lock is on, which switches the key input to all capital letters.
(3)  Microphone mute light	<ul style="list-style-type: none"> <li>Amber: Microphone is off.</li> <li>White: Microphone is on.</li> </ul>
(4) num lk Num lk light	On: Num lock is on.
(5)  Wireless light	<ul style="list-style-type: none"> <li>White: An integrated wireless device, such as a wireless local area network (WLAN) device and/or a Bluetooth® device, is on.</li> <li>Amber: All wireless devices are off.</li> </ul>
(6)  Mute light	<ul style="list-style-type: none"> <li>Amber: Computer sound is off.</li> <li>White: Computer sound is on.</li> </ul>
(7) TouchPad light	<ul style="list-style-type: none"> <li>Amber: The TouchPad is off.</li> <li>Off: The TouchPad is on.</li> </ul>

## Buttons and fingerprint reader



Component	Description
<p>(1)  Power button</p>	<ul style="list-style-type: none"><li>• When the computer is off, press the button to turn on the computer.</li><li>• When the computer is on, press the button briefly to initiate Sleep.</li><li>• When the computer is in the Sleep state, press the button briefly to exit Sleep.</li><li>• When the computer is in Hibernation, press the button briefly to exit Hibernation.</li></ul> <p><b>CAUTION:</b> Pressing and holding down the power button results in the loss of unsaved information.</p> <p>If the computer has stopped responding and shutdown procedures are ineffective, press and hold the power button for at least 5 seconds to turn off the computer.</p> <p>To learn more about your power settings, see your power options.</p> <p>▲ Type <code>power options</code> in the taskbar search box, and then select <b>Power Options</b>.</p> <p>– or –</p> <p>Right-click the <b>Power meter</b> icon  and then select <b>Power Options</b>.</p>
<p>(2)  Wireless button</p>	<p>Turns the wireless feature on or off but does not establish a wireless connection.</p> <p>A wireless network must be set up before a wireless connection is possible.</p>

Component	Description
(3)  Volume mute button	Mutes and restores speaker sound.
(4) Fingerprint reader (select products only)	Allows a fingerprint logon to Windows, instead of a password logon.

## Special keys

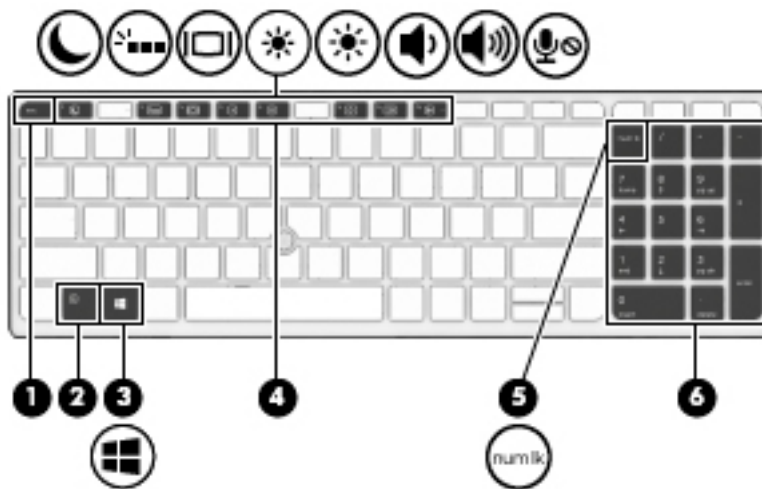









Component	Description
(1) <code>esc</code> key	Displays system information when pressed in combination with the <code>fn</code> key.
(2) <code>fn</code> key	Executes frequently used system functions when pressed in combination with a function key, the <code>num lk</code> key, the <code>esc</code> key, or other key.  See <a href="#">Action keys on page 14</a> .
(3)  Windows key	Opens the <b>Start</b> menu.  <b>NOTE:</b> Pressing the Windows key again will close the <b>Start</b> menu.
(4) Action keys	Execute frequently used system functions.  See <a href="#">Action keys on page 14</a> .
(5) <code>num lk</code> <code>num lk</code> key	Alternates between the navigational and numeric functions on an integrated numeric keypad.
(6) Integrated numeric keypad	A separate keypad to the right of the alphabet keyboard. When <code>num lk</code> is pressed, the integrated keypad can be used like an external numeric keypad.  <b>NOTE:</b> If the keypad function is active when the computer is turned off, that function is reinstated when the computer is turned back on.

## Action keys

An action key performs the function indicated by the icon on the key. To determine which keys are on your product, see [Special keys on page 13](#).

▲ To use an action key, press and hold the key.

Icon	Description
	Initiates Sleep, which saves your information in system memory. The display and other system components turn off and power is conserved. To exit Sleep, briefly press the power button. <b>CAUTION:</b> To reduce the risk of information loss, save your work before initiating Sleep.
	Turns the keyboard backlight off or on. <b>NOTE:</b> To conserve battery power, turn off this feature.
	Switches the screen image among display devices connected to the system. For example, if a monitor is connected to the computer, repeatedly pressing the hot key alternates the screen image from computer display to monitor display to simultaneous display on both the computer and monitor.
	Decreases the screen brightness incrementally as long as you hold down the key.
	Increases the screen brightness incrementally as long as you hold down the key.
	Decreases speaker volume incrementally while you hold down the key.
	Increases speaker volume incrementally while you hold down the key.
	Mutes the microphone.

 **NOTE:** The action key feature is enabled at the factory. You can disable this feature by pressing and holding the **fn** key and the left **shift** key. The fn lock light will turn on. After you have disabled the action key feature, you can still perform each function by pressing the **fn** key in combination with the appropriate action key.





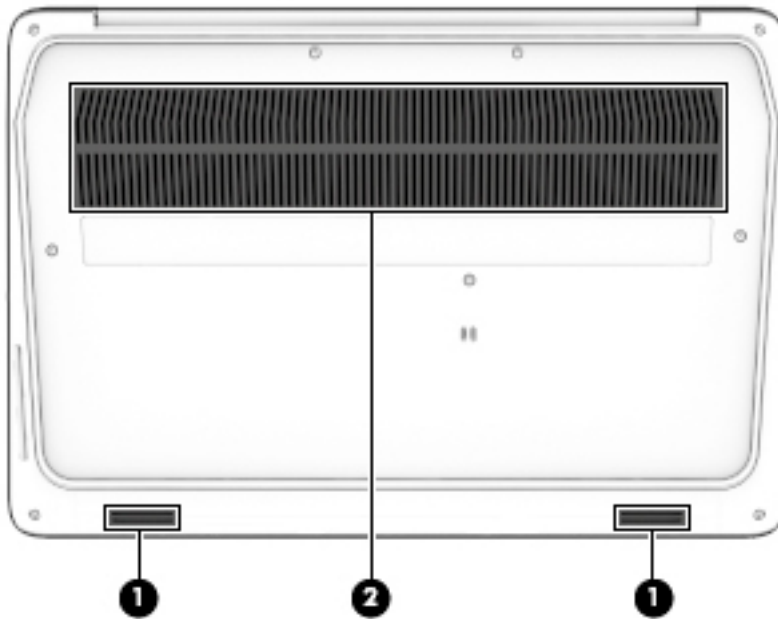

## Bottom

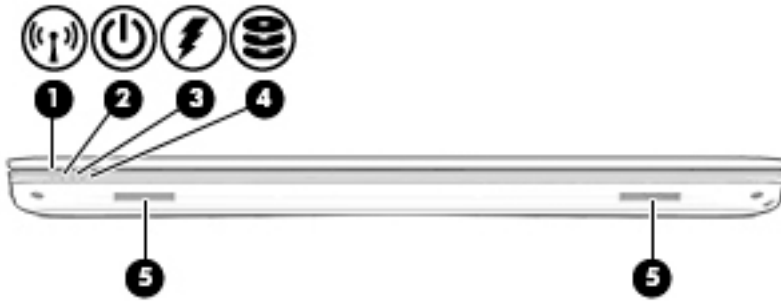

Component		Description
(1)	Speakers (2)	Produce sound.
(2)	Vents (2)	Enable airflow to cool internal components. <b>NOTE:</b> The computer fan starts up automatically to cool internal components and prevent overheating. It is normal for the internal fan to cycle on and off during routine operation.

# Front



Component	Description
<b>(1)</b>  Wireless light	<ul style="list-style-type: none"> <li>White: An integrated wireless device, such as a wireless local area network (WLAN) device and/or a Bluetooth® device, is on.</li> <li>Amber: All wireless devices are off.</li> </ul>
<b>(2)</b>  Power light	<ul style="list-style-type: none"> <li>On: The computer is on.</li> <li>Blinking: The computer is in the Sleep state, a power-saving state. The computer shuts off power to the display and other unneeded components.</li> <li>Off: The computer is off or in Hibernation. Hibernation is a power-saving state that uses the least amount of power.</li> </ul>
<b>(3)</b>  Battery light	<p>When AC power is connected:</p> <ul style="list-style-type: none"> <li>White: The battery charge is greater than 90 percent.</li> <li>Amber: The battery charge is from 0 to 90 percent.</li> <li>Off: The battery is not charging.</li> </ul> <p>When AC power is disconnected (battery not charging):</p> <ul style="list-style-type: none"> <li>Blinking amber: The battery has reached a low battery level. When the battery has reached a critical battery level, the battery light begins blinking rapidly.</li> <li>Off: The battery is not charging.</li> </ul>
<b>(4)</b>  Drive light	<ul style="list-style-type: none"> <li>Blinking white: The hard drive is being accessed.</li> <li>Amber: HP 3D DriveGuard has temporarily parked the hard drive.</li> </ul>
<b>(5)</b> Speakers (2)	Produce sound.

# Labels

The labels affixed to the computer provide information you may need when you troubleshoot system problems or travel internationally with the computer.

**IMPORTANT:** Check the following locations for the labels described in this section: the bottom of the computer, inside the battery bay, under the service door, or on the back of the display.

- Service label—Provides important information to identify your computer. When contacting support, you will probably be asked for the serial number, and possibly for the product number or the model number. Locate these numbers before you contact support.

Your service label will resemble one of the examples shown below. Refer to the illustration that most closely matches the service label on your computer.

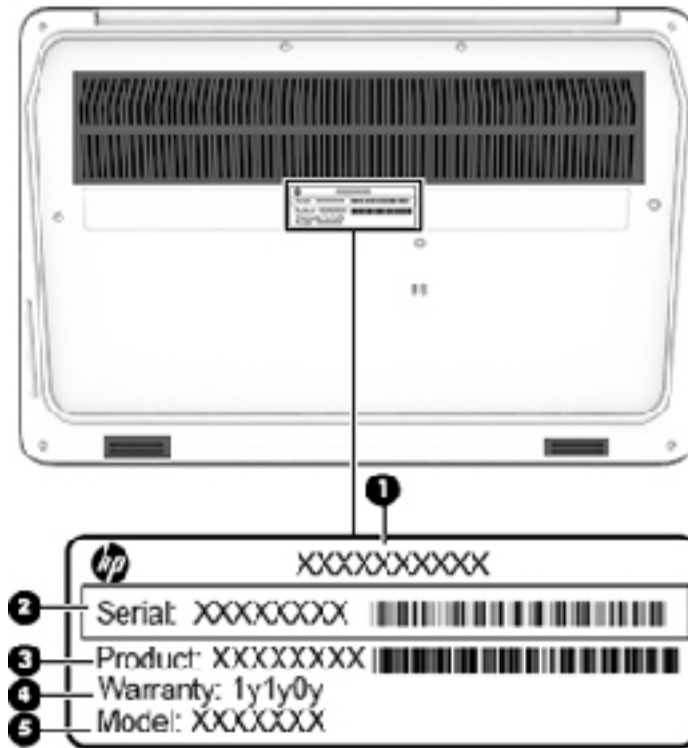

---

### Component

- 
- (1) Model name (select products only)

---

  - (2) Serial number

---

  - (3) Product number

---

  - (4) Warranty period

---

  - (5) Model number
- 

- Regulatory label(s)—Provide(s) regulatory information about the computer.
- Wireless certification label(s)—Provide(s) information about optional wireless devices and the approval markings for the countries or regions in which the devices have been approved for use.

# 3 Illustrated parts catalog

## Computer major components

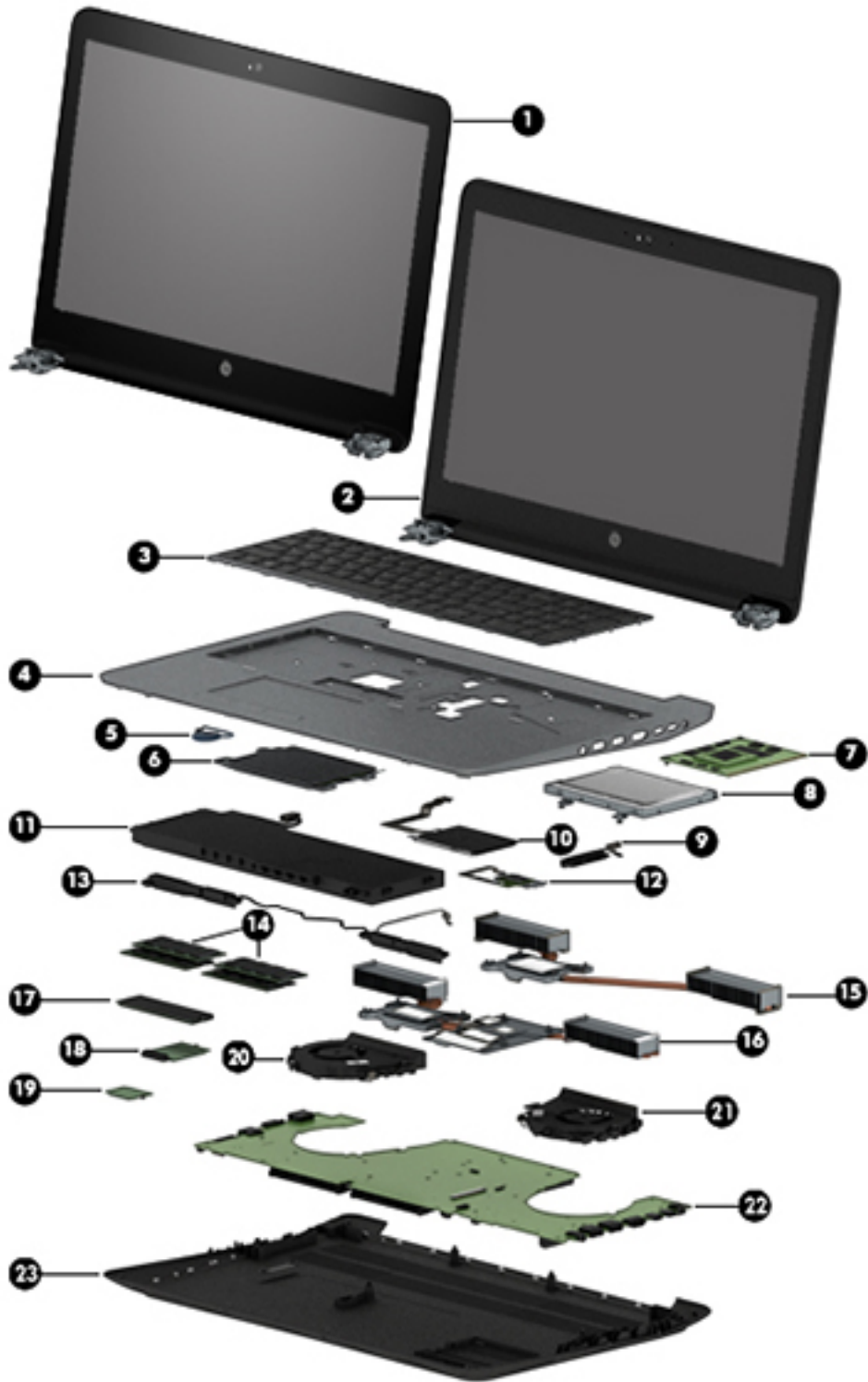

Item	Component	Spare part number
(1)	<b>Display assembly</b> (Touch screen; FHD, UWVA; includes camera)	921058-001
(2)	<b>Display assembly</b> (Non-touch; UHD, UWVA) For more display assembly spare part information, see <a href="#">Display assembly subcomponents on page 22</a>	
	Without camera	921059-001
	With camera	921060-001
(3)	<b>Keyboard</b> (backlit; includes TouchPad and keyboard cables) For a list of keyboard country codes, see <a href="#">Keyboard on page 49</a> . The pointing stick cable is available in the Cable Kit using spare part number 848244-001.	848311-xx1
(4)	<b>Top cover</b> (includes thermal pad)	928426-001
(5)	<b>RTC battery</b> (includes cable and double-sided adhesive)	922939-001
(6)	<b>TouchPad module</b> The TouchPad module cable is available in the Cable Kit using spare part number 848244-001.	850944-001
(7)	<b>Graphics board</b> (includes replacement thermal material)	
	NVIDIA Quadro M2200 graphics board	924955-001
	NVIDIA Quadro M1200 graphics board	924954-001
	NVIDIA Quadro M620 graphics board	924953-001
	AMD Radeon Pro WX 4150	924956-001
(8)	<b>Hard drives or solid-state drives, 2.5-inch</b> (does not include hard drive bracket or screws)	
	1-TB, solid-state drive	924027-001
	1-TB, 5400-rpm	762990-002
	500-GB, 5400-rpm, hybrid 8 GB	732000-002
	500-GB, 7200-rpm	703267-002
	500-GB, 5400-rpm, FIPS	820572-002
	500-GB, 7200-rpm, self-encrypting	820573-002
	<b>Hard Drive Hardware Kit</b> (not illustrated, includes hard drive bracket and screws)	848231-001
(9)	<b>LED board</b>	848246-001
(10)	<b>Smart card reader</b> The smart card reader bracket is available in the Bracket Kit, spare part number 848232-001.	848245-001
(11)	<b>Battery</b> (9-cell, 90-WHr, 2.635-AHr, li-ion)	808452-002
(12)	<b>Fingerprint reader board</b> (includes cable) The fingerprint reader bracket is available in the Bracket Kit, spare part number 848232-001.	850151-001
(13)	<b>Speakers</b> (include cable)	848233-001
(14)	<b>Memory module</b> (DDR4-2400) For use in models with Intel Core processors	

Item	Component	Spare part number
	<ul style="list-style-type: none"> <li>16-GB</li> </ul>	862396-852
	<ul style="list-style-type: none"> <li>8-GB</li> </ul>	862398-852
	<ul style="list-style-type: none"> <li>4-GB</li> </ul>	862397-852
	For use in models with Xeon Core processors	
	<ul style="list-style-type: none"> <li>16-GB</li> </ul>	835886-002
	<ul style="list-style-type: none"> <li>8-GB</li> </ul>	835887-002
	<b>Heat sink assembly</b> (includes replacement thermal material)	
<b>(15)</b>	For use only in models with UMA graphics memory	922938-001
<b>(16)</b>	For use only in models with Nvidia Quadro M1200 and M620 graphics boards	922935-001
<b>(16)</b>	For use only in models with Nvidia Quadro M2200 graphics boards	922936-001
<b>(16)</b>	For use only in models with the AMD Radeon Pro graphics board	922937-001
<b>(17)</b>	<b>Solid-state drive (SSD); M.2</b>	
	SATA-3 drives, TLC:	
	<ul style="list-style-type: none"> <li>512-GB, FIPS</li> </ul>	921052-001
	<ul style="list-style-type: none"> <li>256-GB, TLC</li> </ul>	932478-001
	<ul style="list-style-type: none"> <li>256-GB, self-encrypting drive (SED), OPAL 2</li> </ul>	921053-001
	Z Turbo drives; PCIe:	
	<ul style="list-style-type: none"> <li>1-TB, MLC</li> </ul>	921057-001
	<ul style="list-style-type: none"> <li>512-GB, self-encrypting drive (SED), OPAL 2, TLC</li> </ul>	921054-001
	<ul style="list-style-type: none"> <li>512-GB, MLC</li> </ul>	921056-001
	<ul style="list-style-type: none"> <li>256-GB, TLC</li> </ul>	921055-001
	<ul style="list-style-type: none"> <li>256-GB, MLC</li> </ul>	921051-001
<b>(18)</b>	<b>WWAN module</b>	
	HP It4120 LTE/EVDO/HSPA+ Gobi 4G Mobile Broadband Module	800870-002
	Fibocom HP hs3210 WW HSPA+ w/o GPS	918670-852
	Huawei HP It4132, LTE/HSPA+ 4G w/GPS M.2	918671-852
<b>(19)</b>	<b>WLAN module</b>	
	Intel Dual band wireless-AC 8265 802.11AC 2x2 WiFi + BT 4.2 Combo Adaptor (non-vPro)	910264-852
	Intel Dual band wireless-AC 8265 802.11AC 2x2 WiFi + BT 4.2 Combo Adaptor (vPro)	918855-852
	<b>Fan</b>	
<b>(20)</b>	Fan for use near the processor	848251-001
<b>(21)</b>	Fan for use near the graphics board	848252-001
<b>(22)</b>	<b>System board</b> (includes replacement thermal material)	
	All system boards use the following part numbers:	

Item	Component	Spare part number
	xxxxxx-001: Windows 7 or non-Windows operating systems	
	xxxxxx-601: Windows 10 operating system	
	Equipped with an Intel Core i7-7820HQ processor	921048-xxx
	Equipped with an Intel Core i7-7700HQ processor	921047-xxx
	Equipped with an Intel Core i7-7440HQ processor	921046-xxx
	Equipped with an Intel Core i7-7300HQ processor	921045-xxx
	Equipped with an Xeon E3-1535M processor	921050-xxx
	Equipped with an Xeon E3-1505M processor	921049-xxx
<b>(23)</b>	<b>Bottom cover</b> (includes SSD thermal pad)	928423-001

## Bracket Kit



Item	Component	Spare part number
	<b>Bracket Kit</b> , includes:	848232-001
<b>(1)</b>	USB-C bracket	
<b>(2)</b>	EDP bracket (display cable bracket)	
<b>(3)</b>	Fingerprint reader board bracket	
<b>(4)</b>	Smart card bracket	

## Display assembly subcomponents

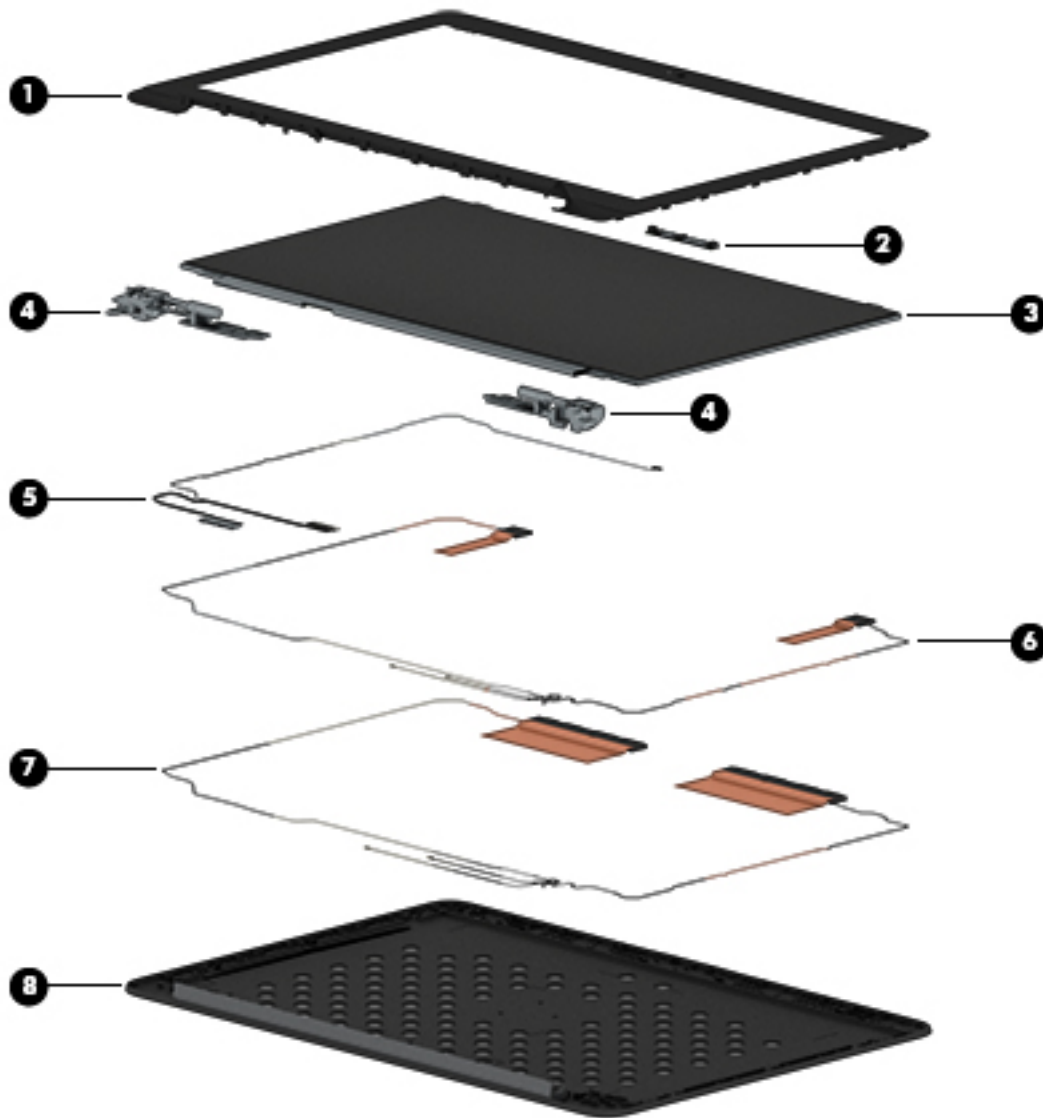

Item	Component	Spare part number
<b>(1)</b>	<b>Display bezel</b>	
	For use only on computer models not equipped with a camera	848241-001
	For use only on computer models equipped with a camera	850154-001
<b>(2)</b>	<b>Camera/microphone module</b> (includes double-sided adhesive)	819336-006
	<b>Microphone module</b> (includes double-sided adhesive)	854110-001
<b>(3)</b>	<b>Display panel</b>	
	Includes display cable:	
	• SVA	936518-001
	• UWVA	936519-001



Item	Component	Spare part number
	Does not include display cable:	
	<ul style="list-style-type: none"> <li>SVA</li> </ul>	819354-004
	<ul style="list-style-type: none"> <li>UWVA</li> </ul>	819355-005
(4)	<b>Display hinges</b> (includes left and right hinges)	848242-001
(5)	<b>Display/Camera Cable Kit</b>	848253-001
(6)	<b>Antenna Kit, WWAN</b>	848229-001
(7)	<b>Antenna Kit, WLAN</b>	848228-001
(8)	<b>Display rear cover</b>	928422-001

## Cable Kit

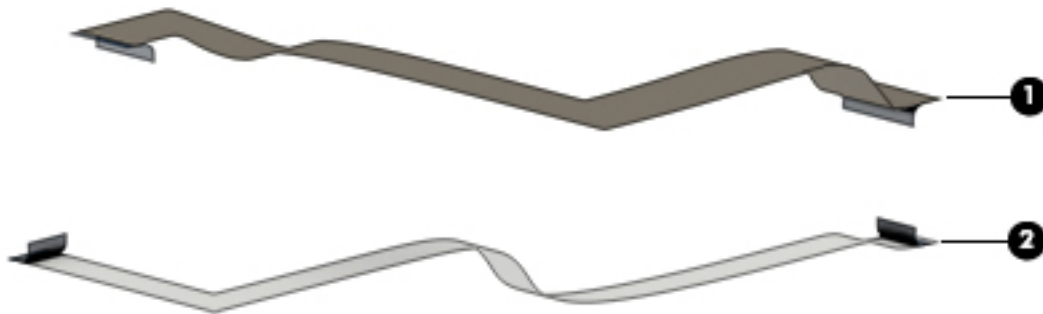

Item	Component	Spare part number
	<b>Cable Kit</b> , includes:	848244-001
(1)	TouchPad cable	
(2)	Pointing stick cable	

## Plastics Kit

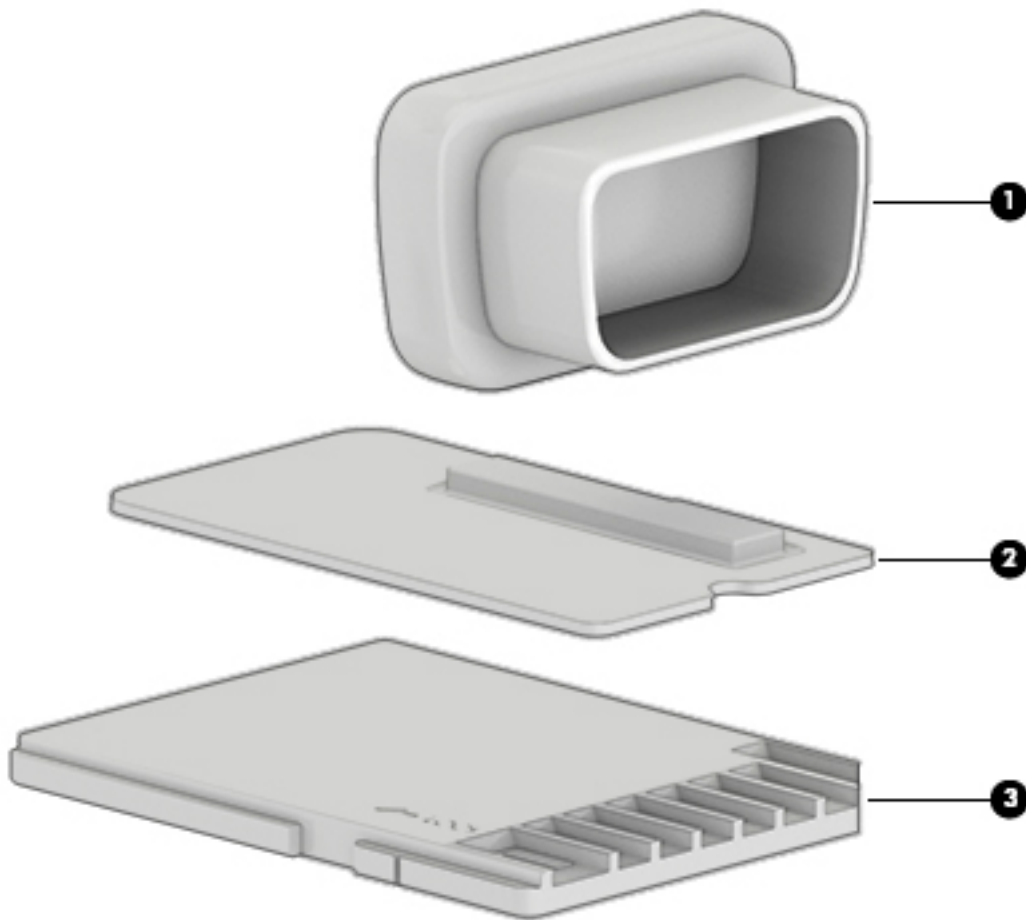

Item	Component	Spare part number
	<b>Plastics Kit</b> , includes:	850152-001
(1)	VGA cap	
(2)	Fingerprint reader bezel	
(3)	SD card reader insert	

# Mass storage devices

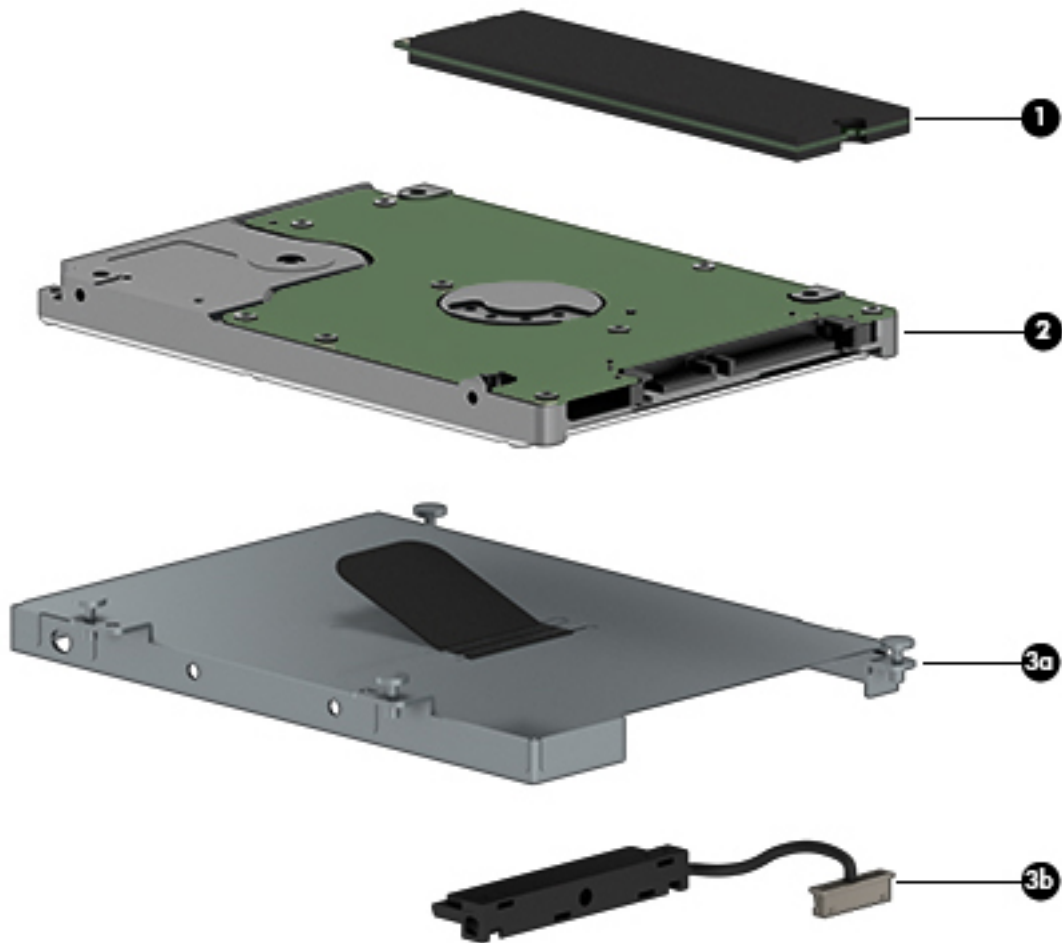

Item	Component	Spare part number
<b>(1)</b>	<b>Solid-state drive, M.2</b>	
	SATA-3 drives, TLC:	
	• 512-GB, FIPS	921052-001
	• 256-GB, TLC	932478-001
	• 256-GB, self-encrypting drive (SED), OPAL 2	921053-001
	Z Turbo drives; PCIe:	
	• 1-TB, MLC	921057-001
	• 512-GB, self-encrypting drive (SED), OPAL 2, TLC	921054-001
	• 512-GB, MLC	921056-001
	• 256-GB, TLC	921055-001
	• 256-GB, MLC	921051-001
<b>(2)</b>	<b>Hard drives and solid-state drives 2.5-inch (does not include hard drive bracket or screws)</b>	
	1 TB, solid-state drive	924027-001

Item	Component	Spare part number
	1-TB, 5400-rpm	762990-002
	500-GB, 5400-rpm, hybrid 8 GB	732000-002
	500-GB, 7200-rpm	703267-002
	500-GB, 5400-rpm, FIPS	820572-002
	500-GB, 7200-rpm, self-encrypting	820573-002
	<b>Hard Drive Hardware Kit</b> , includes:	848231-001
<b>(3a)</b>	Hard drive bracket	
<b>(3b)</b>	Hard drive cable	

## Miscellaneous parts

Component	Spare part number
<b>AC adapter</b>	
150-W HP Smart adapter (slim, 4.5-mm)	776620-001
<b>Power cord</b> (3-pin, black, 1.83-m)	
For use in Europe	213350-012
For use in North America	213349-013
For use in Switzerland	213354-011
For use in Taiwan	393313-006
For use in Thailand	285096-010
For use in the United Kingdom and Singapore	213351-011
<b>Screw Kit</b>	848266-001

---

# 4 Removal and replacement procedures preliminary requirements

## Tools required

You will need the following tools to complete the removal and replacement procedures:

- Torx driver
- Magnetic screwdriver
- Phillips P0 and P1 screwdrivers

## Service considerations

The following sections include some of the considerations that you must keep in mind during disassembly and assembly procedures.

---

 **NOTE:** As you remove each subassembly from the computer, place the subassembly (and all accompanying screws) away from the work area to prevent damage.

---

## Plastic parts

---

 **CAUTION:** Using excessive force during disassembly and reassembly can damage plastic parts. Use care when handling the plastic parts. Apply pressure only at the points designated in the maintenance instructions.

---

## Cables and connectors

---

**⚠ CAUTION:** When servicing the computer, be sure that cables are placed in their proper locations during the reassembly process. Improper cable placement can damage the computer.

---

Cables must be handled with extreme care to avoid damage. Apply only the tension required to unseat or seat the cables during removal and insertion. Handle cables by the connector whenever possible. In all cases, avoid bending, twisting, or tearing cables. Be sure that cables are routed in such a way that they cannot be caught or snagged by parts being removed or replaced. Handle flex cables with extreme care; these cables tear easily.

## Drive handling

---

**⚠ CAUTION:** Drives are fragile components that must be handled with care. To prevent damage to the computer, damage to a drive, or loss of information, observe these precautions:

Before removing or inserting a hard drive, shut down the computer. If you are unsure whether the computer is off or in Hibernation, turn the computer on, and then shut it down through the operating system.

Before handling a drive, be sure that you are discharged of static electricity. While handling a drive, avoid touching the connector.

Before removing a diskette drive or optical drive, be sure that a diskette or disc is not in the drive and be sure that the optical drive tray is closed.

Handle drives on surfaces covered with at least one inch of shock-proof foam.

Avoid dropping drives from any height onto any surface.

After removing a hard drive, an optical drive, or a diskette drive, place it in a static-proof bag.

Avoid exposing an internal hard drive to products that have magnetic fields, such as monitors or speakers.

Avoid exposing a drive to temperature extremes or liquids.

If a drive must be mailed, place the drive in a bubble pack mailer or other suitable form of protective packaging and label the package "FRAGILE."

---

## Grounding guidelines

### Electrostatic discharge damage

Electronic components are sensitive to electrostatic discharge (ESD). Circuitry design and structure determine the degree of sensitivity. Networks built into many integrated circuits provide some protection, but in many cases, ESD contains enough power to alter device parameters or melt silicon junctions.

A discharge of static electricity from a finger or other conductor can destroy static-sensitive devices or microcircuitry. Even if the spark is neither felt nor heard, damage may have occurred.

An electronic device exposed to ESD may not be affected at all and can work perfectly throughout a normal cycle. Or the device may function normally for a while, then degrade in the internal layers, reducing its life expectancy.

**⚠ CAUTION:** To prevent damage to the computer when you are removing or installing internal components, observe these precautions:

Keep components in their electrostatic-safe containers until you are ready to install them.

Before touching an electronic component, discharge static electricity by using the guidelines described in this section.

Avoid touching pins, leads, and circuitry. Handle electronic components as little as possible.

If you remove a component, place it in an electrostatic-safe container.

The following table shows how humidity affects the electrostatic voltage levels generated by different activities.

**⚠ CAUTION:** A product can be degraded by as little as 700 V.

Typical electrostatic voltage levels			
Event	Relative humidity		
	10%	40%	55%
Walking across carpet	35,000 V	15,000 V	7,500 V
Walking across vinyl floor	12,000 V	5,000 V	3,000 V
Motions of bench worker	6,000 V	800 V	400 V
Removing DIPs from plastic tube	2,000 V	700 V	400 V
Removing DIPs from vinyl tray	11,500 V	4,000 V	2,000 V
Removing DIPs from Styrofoam	14,500 V	5,000 V	3,500 V
Removing bubble pack from PCB	26,500 V	20,000 V	7,000 V
Packing PCBs in foam-lined box	21,000 V	11,000 V	5,000 V

## Packaging and transporting guidelines

Follow these grounding guidelines when packaging and transporting equipment:

- To avoid hand contact, transport products in static-safe tubes, bags, or boxes.
- Protect ESD-sensitive parts and assemblies with conductive or approved containers or packaging.
- Keep ESD-sensitive parts in their containers until the parts arrive at static-free workstations.
- Place items on a grounded surface before removing items from their containers.
- Always be properly grounded when touching a component or assembly.
- Store reusable ESD-sensitive parts from assemblies in protective packaging or nonconductive foam.
- Use transporters and conveyors made of antistatic belts and roller bushings. Be sure that mechanized equipment used for moving materials is wired to ground and that proper materials are selected to avoid static charging. When grounding is not possible, use an ionizer to dissipate electric charges.

## Workstation guidelines

Follow these grounding workstation guidelines:

- Cover the workstation with approved static-shielding material.
- Use a wrist strap connected to a properly grounded work surface and use properly grounded tools and equipment.
- Use conductive field service tools, such as cutters, screw drivers, and vacuums.
- When fixtures must directly contact dissipative surfaces, use fixtures made only of static-safe materials.
- Keep the work area free of nonconductive materials, such as ordinary plastic assembly aids and Styrofoam.
- Handle ESD-sensitive components, parts, and assemblies by the case or PCM laminate. Handle these items only at static-free workstations.
- Avoid contact with pins, leads, or circuitry.
- Turn off power and input signals before inserting or removing connectors or test equipment.



## Equipment guidelines

Grounding equipment must include either a wrist strap or a foot strap at a grounded workstation.

- When seated, wear a wrist strap connected to a grounded system. Wrist straps are flexible straps with a minimum of one megohm  $\pm 10\%$  resistance in the ground cords. To provide proper ground, wear a strap snugly against the skin at all times. On grounded mats with banana-plug connectors, use alligator clips to connect a wrist strap.
- When standing, use foot straps and a grounded floor mat. Foot straps (heel, toe, or boot straps) can be used at standing workstations and are compatible with most types of shoes or boots. On conductive floors or dissipative floor mats, use foot straps on both feet with a minimum of one megohm resistance between the operator and ground. To be effective, the conductive must be worn in contact with the skin.

The following grounding equipment is recommended to prevent electrostatic damage:

- Antistatic tape
- Antistatic smocks, aprons, and sleeve protectors
- Conductive bins and other assembly or soldering aids
- Nonconductive foam
- Conductive tabletop workstations with ground cords of one megohm resistance
- Static-dissipative tables or floor mats with hard ties to the ground
- Field service kits
- Static awareness labels
- Material-handling packages
- Nonconductive plastic bags, tubes, or boxes
- Metal tote boxes
- Electrostatic voltage levels and protective materials

The following table lists the shielding protection provided by antistatic bags and floor mats.

Material	Use	Voltage protection level
Antistatic plastics	Bags	1,500 V
Carbon-loaded plastic	Floor mats	7,500 V
Metallized laminate	Floor mats	5,000 V

# 5 Removal and replacement procedures for Authorized Service Provider parts

 **CAUTION:** Components described in this chapter should only be accessed by an authorized service provider. Accessing these parts can damage the computer or void the warranty.

## Component replacement procedures

This chapter provides removal and replacement procedures for Authorized Service Provider only parts.

There are as many as 75 screws that must be removed, replaced, and/or loosened when servicing the computer. Make special note of each screw size and location during removal and replacement.

## Display subcomponents (bezel, panel, camera)

 **NOTE:** Touch display assemblies are spared as whole unit assemblies only. Non-touch display assemblies are spared at the subcomponent level and as whole unit assemblies.

This section illustrates how to remove the display bezel, display panel, and camera module without removing the display from the computer. The [Display assembly on page 65](#) section illustrates removing all display subcomponents.

Description	Spare part number
Display assembly, non-touch, UHD, UWVA, without camera	921059-001
Display assembly, non-touch, UHD, UWVA, with camera	921060-001
Display assembly, touch screen, FHD, UWVA, with camera	921058-001

To remove the display assembly subcomponents, follow these steps:

1. Turn off the computer. If you are unsure whether the computer is off or in Hibernation, turn the computer on, and then shut it down through the operating system.
2. Disconnect the power from the computer by unplugging the power cord from the computer.
3. Disconnect all external devices from the computer.

Remove the display assembly subcomponents:

1. Open the computer as far as it will open.
2. If it is necessary to replace the display bezel:
  - a. Flex the inside edges of the top edge **(1)**, the left and right sides **(2)**, and the bottom edge **(3)** of the display bezel until the bezel disengages from the display enclosure.

- b.** Remove the display bezel.

The display bezel is available using the following spare part numbers:

848241-001: Models without a camera

850154-001: Models with a camera

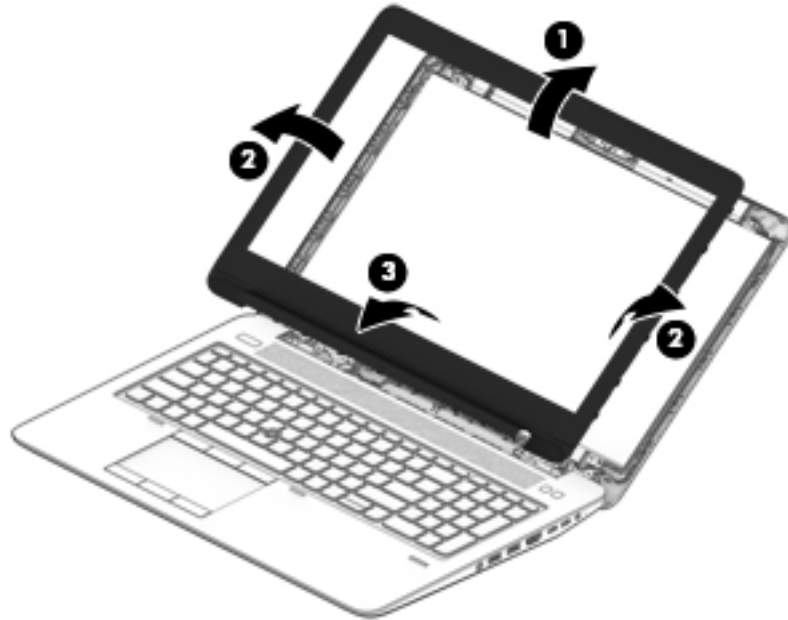

- 3.** If it is necessary to replace the display panel:

- a.** Remove the four Phillips PM2.0×3.0 screws that secure the display panel to the display enclosure.

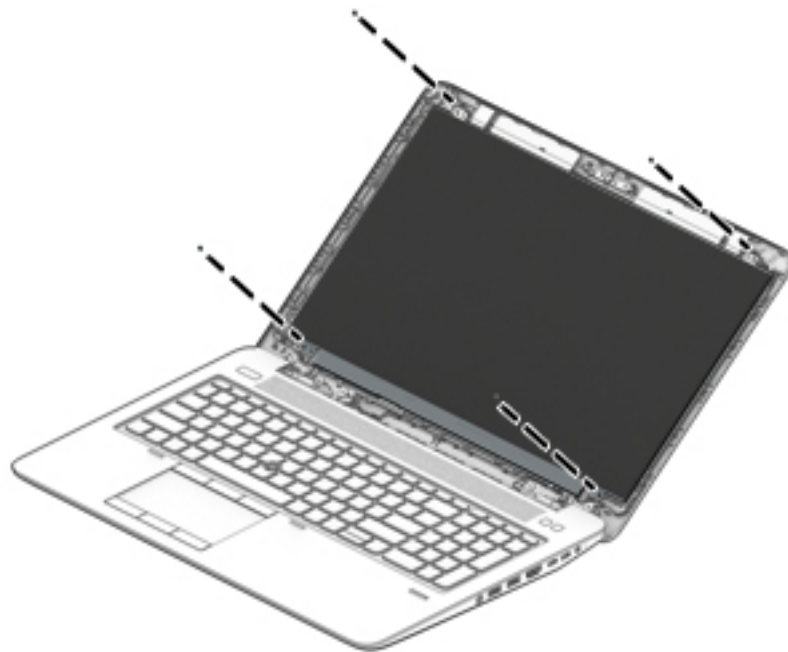

---

**⚠ CAUTION:** Make sure the work surface is clear of tools, screws, and any other foreign objects. Failure to follow this caution can result in damage to the display panel.

---

- b.** Lift the top edge of the display panel **(1)** and swing it up and forward until it rests upside down in front of the display enclosure.
- c.** Release the adhesive strip that secures the display panel cable connector to the rear of the display panel, and then disconnect the display panel cable from the display panel **(2)**.
- d.** Remove the display panel from the computer **(3)**.

The display panel is available using the following spare part numbers:

SVA panel with display cable: 936518-001

UWVA panel with display cable: 936519-001

SVA panel without display cable: 819354-004

UWVA panel without display cable: 819355-005

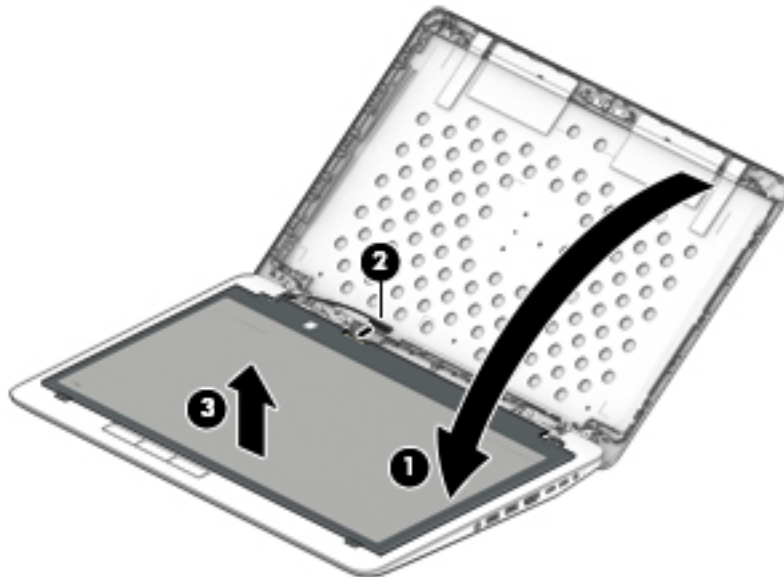

- 4.** If it is necessary to replace the camera/microphone module or microphone module:

---

**⚠ CAUTION:** Handle the camera/microphone module and microphone module with caution. These modules have a thin profile and are susceptible to damage when not handled carefully.

---

- a.** Detach the camera/microphone module **(1)** from the display enclosure. (The camera/microphone module is attached to the display enclosure with double-sided adhesive.)
- b.** Disconnect the camera/microphone module cable **(2)** from the module.

- c. Remove the camera/microphone module (3).

The camera/microphone module is available using spare part number 819336-006. The microphone module is available using spare part number 854110-001.

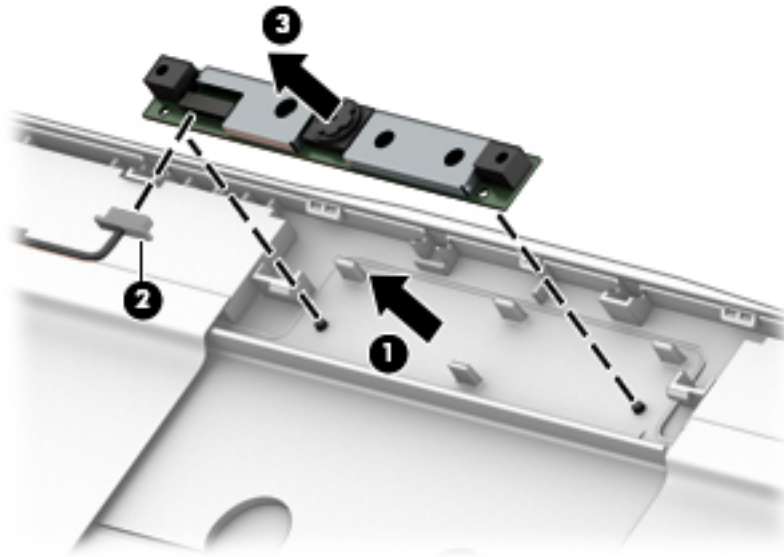

Reverse this procedure to reassemble and install the display assembly components.

## Bottom cover

Description	Spare part number
Bottom cover (includes SSD thermal pad)	928423-001

Before removing the bottom cover, follow these steps:

1. Turn off the computer. If you are unsure whether the computer is off or in Hibernation, turn the computer on, and then shut it down through the operating system.
2. Disconnect the power from the computer by unplugging the power cord from the computer.
3. Disconnect all external devices from the computer.

Remove the bottom cover:

1. Position the computer upside down.
2. Loosen the nine captive Torx screws (1) that secure the bottom cover to the computer.
3. Lift the bottom cover off the computer (2).

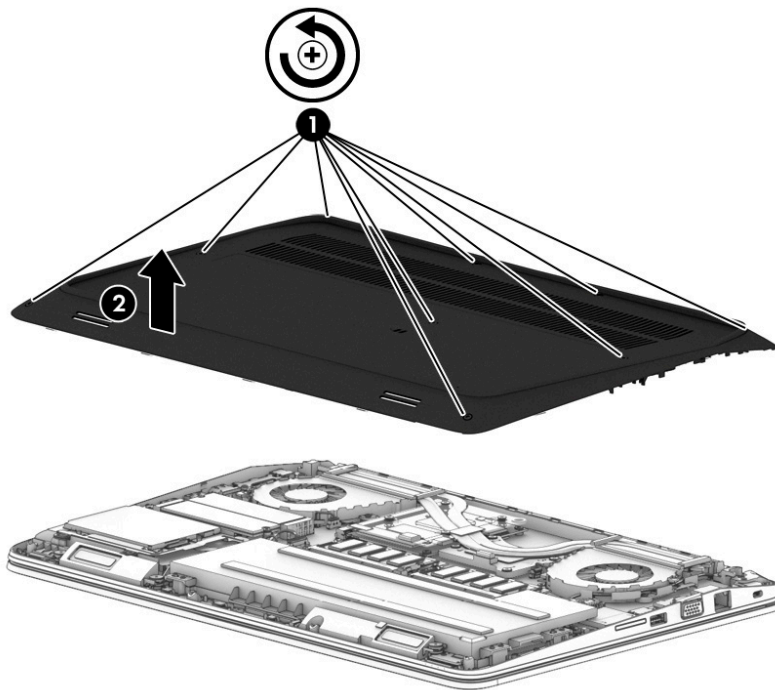

Reverse this procedure to install the bottom cover.

## Battery

Description	Spare part number
9-cell, 90-WHr, 2.635-AHr, li-ion battery	808452-002

Before removing the battery, follow these steps:

1. Turn off the computer. If you are unsure whether the computer is off or in Hibernation, turn the computer on, and then shut it down through the operating system.
2. Disconnect the power from the computer by unplugging the power cord from the computer.
3. Disconnect all external devices from the computer.
4. Remove the bottom cover (see [Bottom cover on page 36](#)).

Remove the battery:

- WARNING!** To reduce potential safety issues, use only the user-replaceable battery provided with the computer, a replacement battery provided by HP, or a compatible battery purchased from HP.
- CAUTION!** Removing a user-replaceable battery that is the sole power source for the computer can cause loss of information. To prevent loss of information, save your work or shut down the computer through Windows before removing the battery.

1. Disconnect the battery cable from the system board **(1)**.
2. Loosen the three Phillips screws **(2)** that secure the battery to the computer.
3. Remove the battery **(3)** from the computer.

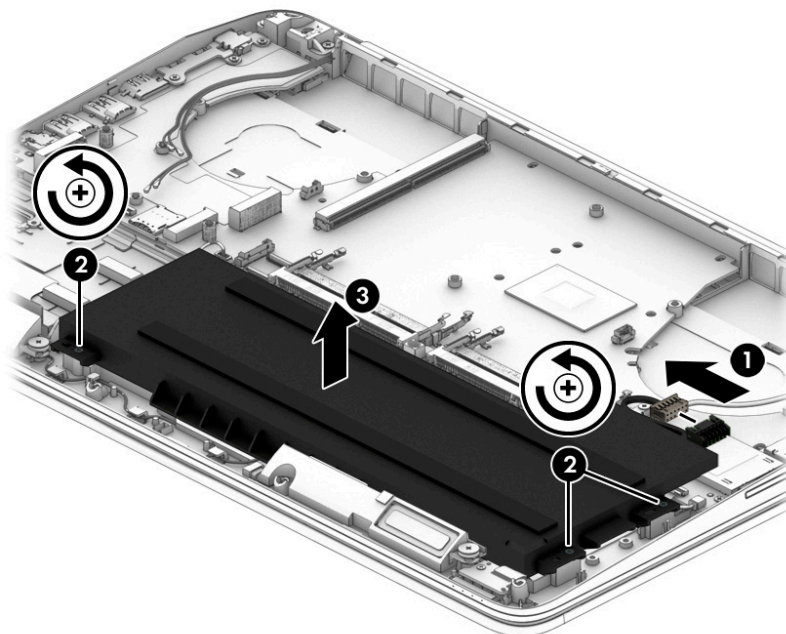

Reverse this procedure to install the battery.

## Memory module

Description	Spare part number
<b>Memory module for use in models with Intel Core processors</b>	
16-GB	862396-852
8-GB	862398-852
4-GB	862397-852
<b>Memory module for use in models with Xeon Core processors</b>	
16-GB	835886-002
8-GB	835887-002

### Update BIOS before adding memory modules

Before adding new memory, make sure you update the computer to the latest BIOS.

 **CAUTION:** Failure to update the computer to the latest BIOS prior to installing new memory may result in various system problems.

To update BIOS:

1. Navigate to [www.hp.com](http://www.hp.com).
2. Click **Support & Drivers** > **click Drivers & Software**.
3. In the **Enter a product name/number box**, type the computer model information, and then click **Search**.
4. Click the link for the computer model.
5. Select the operating system, and then click **Next**.
6. Under **Step 2: Select a Download**, click the **BIOS** link.
7. Click the link for the most recent BIOS.
8. Click the **Download** button, and then follow the on-screen instructions.

Before removing a memory module, follow these steps:

1. Turn off the computer. If you are unsure whether the computer is off or in Hibernation, turn the computer on, and then shut it down through the operating system.
2. Disconnect the power from the computer by unplugging the power cord from the computer.
3. Disconnect all external devices from the computer.
4. Remove the bottom cover (see [Bottom cover on page 36](#)).
5. Disconnect the battery (see [Battery on page 37](#)).

The computer includes two double-stacked memory module sockets. Use the following image to determine the correct order to install memory modules. Memory installation order only matters if there are less than four SODIMMs.



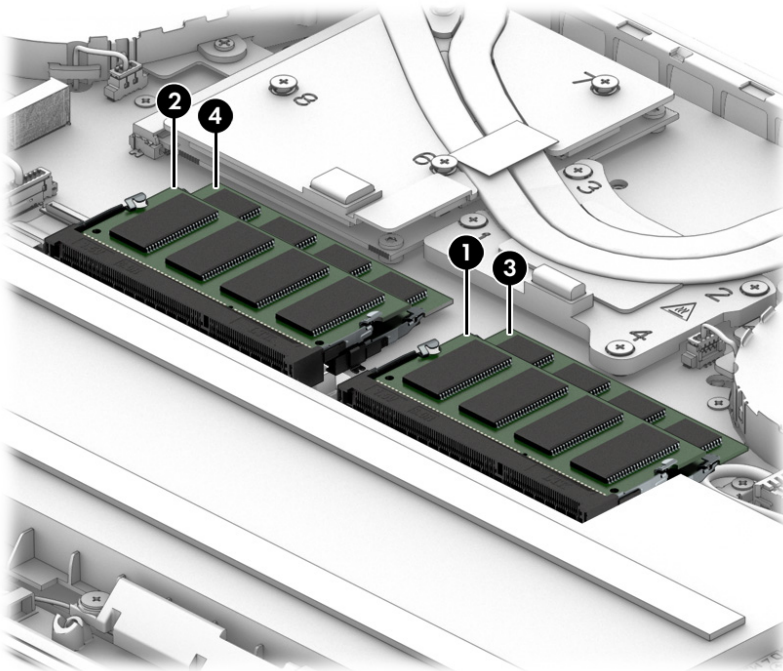

Remove the memory module:

1. Spread the retaining tabs **(1)** on each side of the memory module slot to release the memory module. (The memory module tilts up.)
2. Remove the memory module **(2)** by pulling the module away from the slot at an angle.

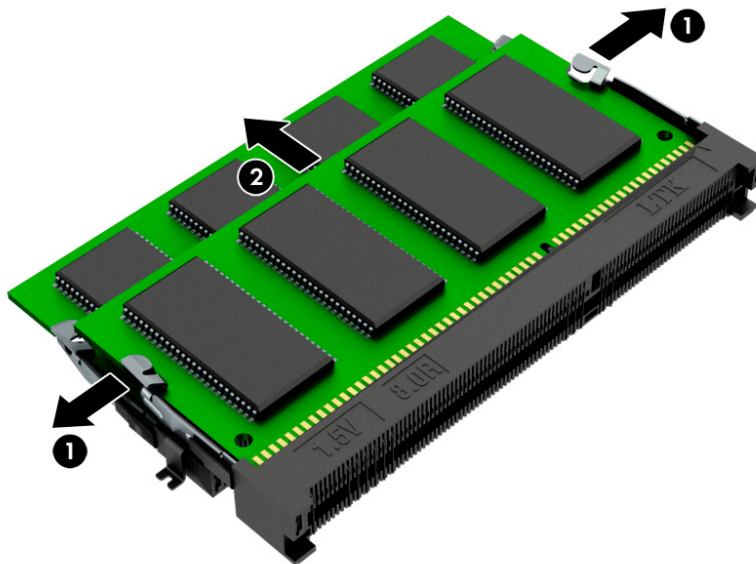

Reverse this procedure to install a memory module.

 **NOTE:** Memory modules are notched to prevent incorrect installation.

## Solid-state drive (M.2)

Description	Spare part number
M.2 solid-state drives (SATA-3, TLC):	
• 512-GB, FIPS	921052-001
• 256-GB, TLC	932478-001
• 256-GB, self-encrypting drive (SED), OPAL 2	921053-001
M.2 solid-state drives (Z Turbo, PCI):	
• 1-TB, MLC	921057-001
• 512-GB, self-encrypting drive (SED), OPAL 2, TLC	921054-001
• 512-GB, MLC	921056-001
• 256-GB, TLC	921055-001
• 256-GB, MLC	921051-001

Before removing the solid-state drive, follow these steps:

1. Turn off the computer. If you are unsure whether the computer is off or in Hibernation, turn the computer on, and then shut it down through the operating system.
2. Disconnect the power from the computer by unplugging the power cord from the computer.
3. Disconnect all external devices from the computer.
4. Remove the bottom cover (see [Bottom cover on page 36](#)).
5. Disconnect the battery (see [Battery on page 37](#)).

Remove the solid-state drive:

1. Remove the Phillips PM2.0×3.5 screw (1) that secures the solid-state drive to the system board.
2. Remove the solid-state drive (2) by pulling the drive away from the slot at an angle.

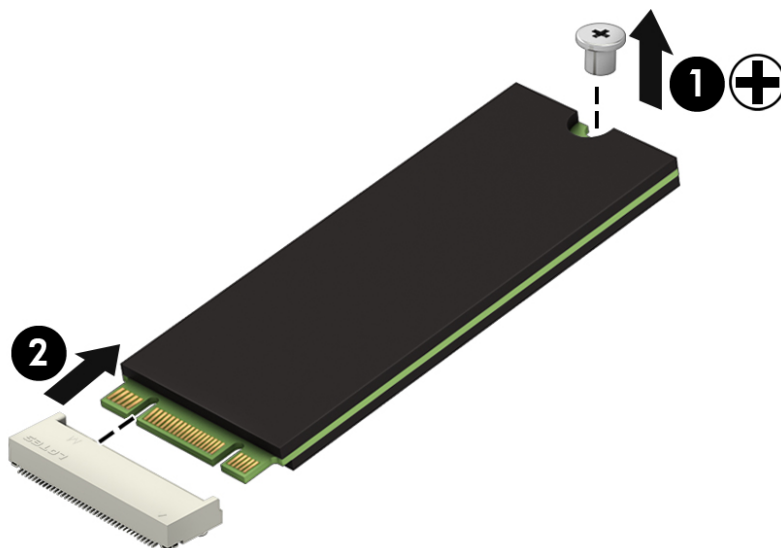

Reverse this procedure to install the solid-state drive.

## WLAN module

Description	Spare part number
Intel Dual band wireless-AC 8265 802.11AC 2x2 WiFi + BT 4.2 Combo Adaptor (non-vPro)	910264-852
Intel Dual band wireless-AC 8265 802.11AC 2x2 WiFi + BT 4.2 Combo Adaptor (vPro)	918855-852

 **CAUTION:** To prevent an unresponsive system, replace the wireless module only with a wireless module authorized for use in the computer by the governmental agency that regulates wireless devices in your country or region. If you replace the module and then receive a warning message, remove the module to restore device functionality, and then contact technical support.

Before removing the WLAN module, follow these steps:

1. Turn off the computer. If you are unsure whether the computer is off or in Hibernation, turn the computer on, and then shut it down through the operating system.
2. Disconnect the power from the computer by unplugging the power cord from the computer.
3. Disconnect all external devices from the computer.
4. Remove the bottom cover (see [Bottom cover on page 36](#)).
5. Disconnect the battery (see [Battery on page 37](#)).

Remove the WLAN module:

1. Disconnect the WLAN antenna cables **(1)** from the terminals on the WLAN module.



**NOTE:** The WLAN antenna cable labeled “1” connects to the WLAN module “Main” terminal labeled “1”. The WLAN antenna cable labeled “2” connects to the WLAN module “Aux” terminal labeled “2”.

2. Remove the Phillips PM2.0×3.0 screw **(2)** that secures the WLAN module to the system board. (The WLAN module tilts up.)

3. Remove the WLAN module **(3)** by pulling the module away from the slot at an angle.

---

 **NOTE:** WLAN modules are notched to prevent incorrect installation.

---

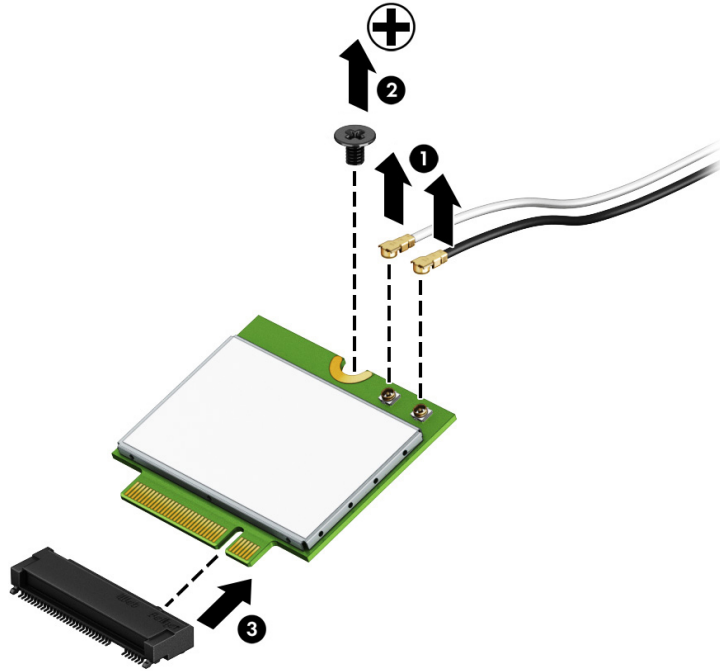

---

 **NOTE:** If the WLAN antenna cables are not connected to the terminals on the WLAN module, protective sleeves should be installed on the antenna connectors, as shown in the following illustration.

---

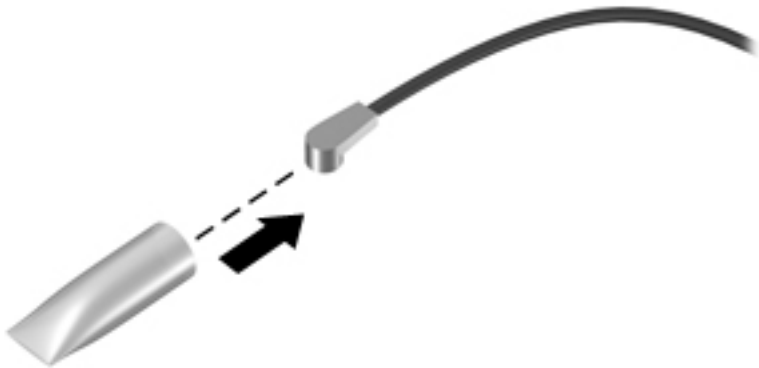

Reverse this procedure to install the WLAN module.

## WWAN module

Description	Spare part number
HP It4120 LTE/EVDO/HSPA+ Gobi 4G Mobile Broadband Module	800870-002
Fibocom HP hs3210 WW HSPA+ w/o GPS	918670-852
Huawei HP It4132, LTE/HSPA+ 4G w/GPS M.2	918671-852

 **CAUTION:** To prevent an unresponsive system, replace the wireless module only with a wireless module authorized for use in the computer by the governmental agency that regulates wireless devices in your country or region. If you replace the module and then receive a warning message, remove the module to restore device functionality, and then contact technical support.

Before removing the WWAN module, follow these steps:

1. Turn off the computer. If you are unsure whether the computer is off or in Hibernation, turn the computer on, and then shut it down through the operating system.
2. Disconnect the power from the computer by unplugging the power cord from the computer.
3. Disconnect all external devices from the computer.
4. Remove the bottom cover (see [Bottom cover on page 36](#)).
5. Disconnect the battery (see [Battery on page 37](#)).

Remove the WWAN module:

1. Disconnect the WWAN antenna cables **(1)** from the terminals on the WWAN module.





**NOTE:** The WWAN antenna cable labeled “5” connects to the “Main” terminal labeled “5”. The WWAN antenna cable labeled “6” connects to the “Aux/GPS” terminal labeled “6”.

2. Remove the Phillips PM2.0×3.25 screw **(2)** that secures the WWAN module to the system board. (The WWAN module tilts up.)

3. Remove the WWAN module (3) by pulling the module away from the slot at an angle.

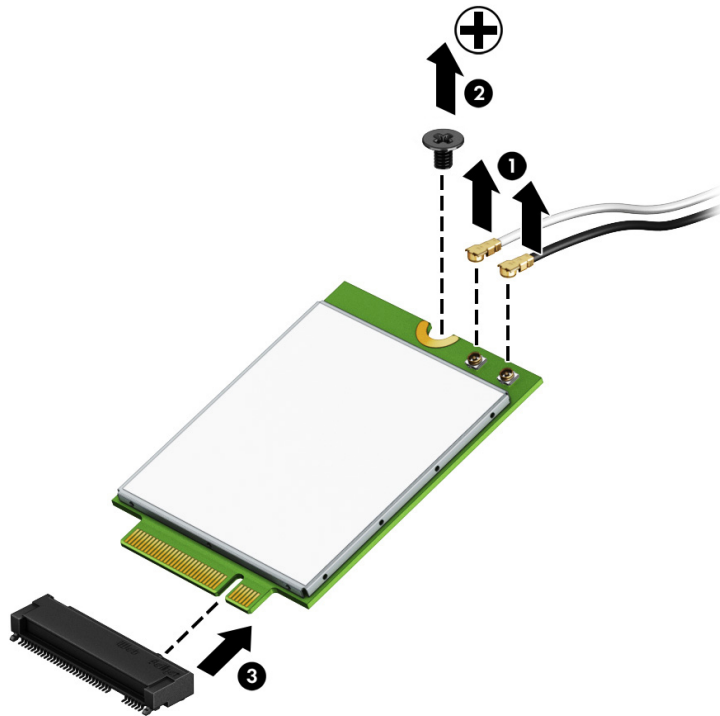
 **NOTE:** WWAN modules are notched to prevent incorrect installation.



 **NOTE:** If the WWAN antenna cables are not connected to the terminals on the WWAN module, protective sleeves should be installed on the antenna connectors, as shown in the following illustration.

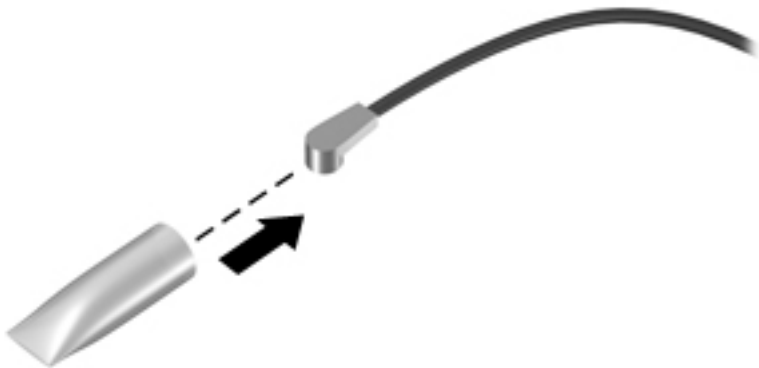

Reverse this procedure to install the WWAN module.

## Smart card reader

Description	Spare part number
Smart card reader (includes cable)	848245-001
The smart card reader bracket is available in the Bracket Kit, spare part number 848232-001.	

Before removing the smart card reader, follow these steps:

1. Turn off the computer. If you are unsure whether the computer is off or in Hibernation, turn the computer on, and then shut it down through the operating system.
2. Disconnect the power from the computer by unplugging the power cord from the computer.
3. Disconnect all external devices from the computer.
4. Remove the bottom cover (see [Bottom cover on page 36](#)).
5. Disconnect the battery (see [Battery on page 37](#)).

Remove the smart card reader:

1. Release the ZIF connector **(1)** to which the smart card reader cable is attached, and then disconnect the smart card reader cable from the system board.



**NOTE:** The smart card reader system board connector is under the WLAN module.

2. Loosen the four captive Torx screws **(2)** that secure the smart card reader to the base enclosure.
3. Remove the smart card reader **(3)**.

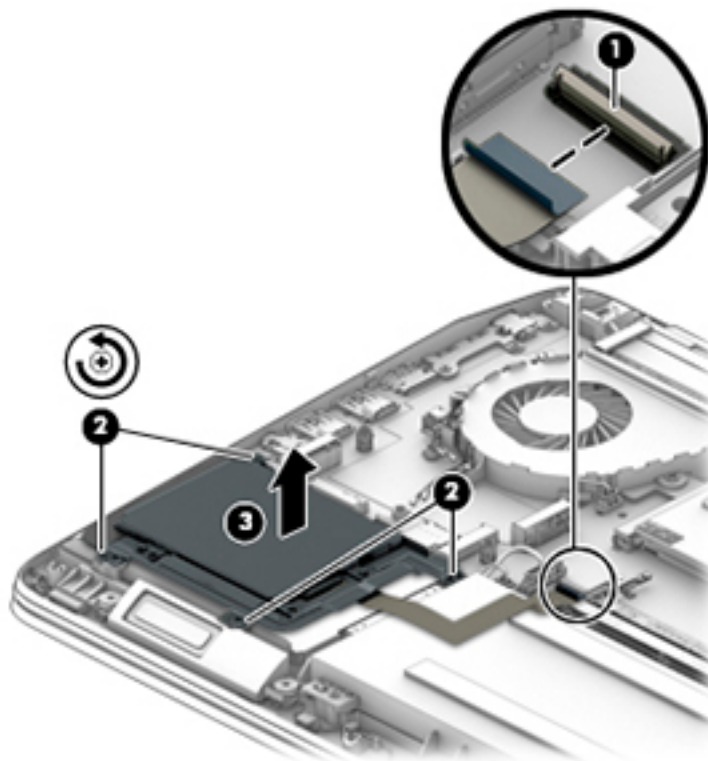

Reverse this procedure to install the smart card reader and cable.

## Hard drive



**NOTE:** The hard drive spare part kit does not include the hard drive bracket or screws. These components are included in the Hard Drive Hardware Kit, spare part number 848231-001.

Description	Spare part number
<b>Hard drive or solid-state drive</b>	
1-TB, solid-state drive	924027-001
1-TB, 5400-rpm,	762990-002
500-GB, 5400-rpm, hybrid 8 GB	732000-002
500-GB, 7200-rpm	703267-002
500-GB, 5400-rpm, FIPS	820572-002
500-GB, 7200-rpm, self-encrypting	820573-002

Before removing the hard drive, follow these steps:

1. Turn off the computer. If you are unsure whether the computer is off or in Hibernation, turn the computer on, and then shut it down through the operating system.
2. Disconnect the power from the computer by unplugging the power cord from the computer.
3. Disconnect all external devices from the computer.
4. Remove the bottom cover (see [Bottom cover on page 36](#)).
5. Disconnect the battery (see [Battery on page 37](#)).
6. Remove the smart card reader (see [Smart card reader on page 45](#)).

Remove the hard drive:

1. Disconnect the hard drive cable from the system board **(1)**.



2. Lift the hard drive from the computer **(2)**.

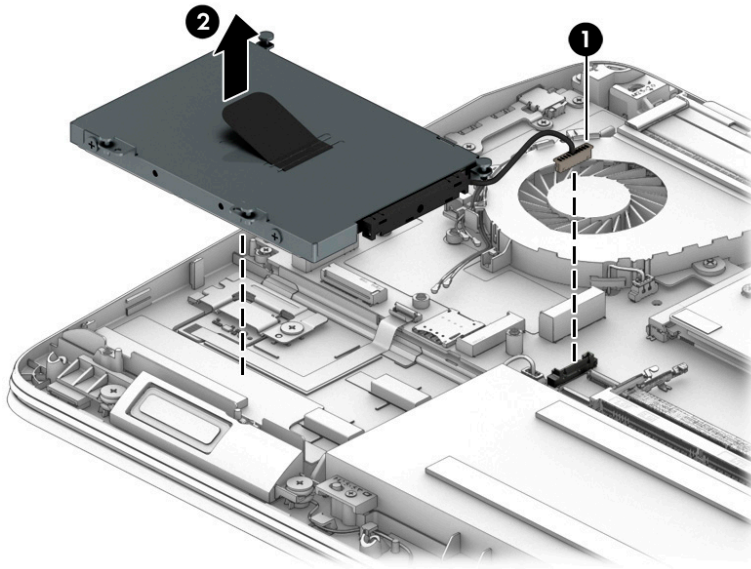

3. If it is necessary to disassemble the hard drive, perform the following steps:

- a. Remove the four Phillips PM3.0×3.0 screws **(1)** that secure the hard drive bracket to the hard drive.
- b. Remove the hard drive bracket from the hard drive **(2)**.
- c. Remove the hard drive connector and cable from the hard drive **(3)**.

The hard drive bracket and screws are available in the Hard Drive Hardware Kit, spare part number 848231-001.

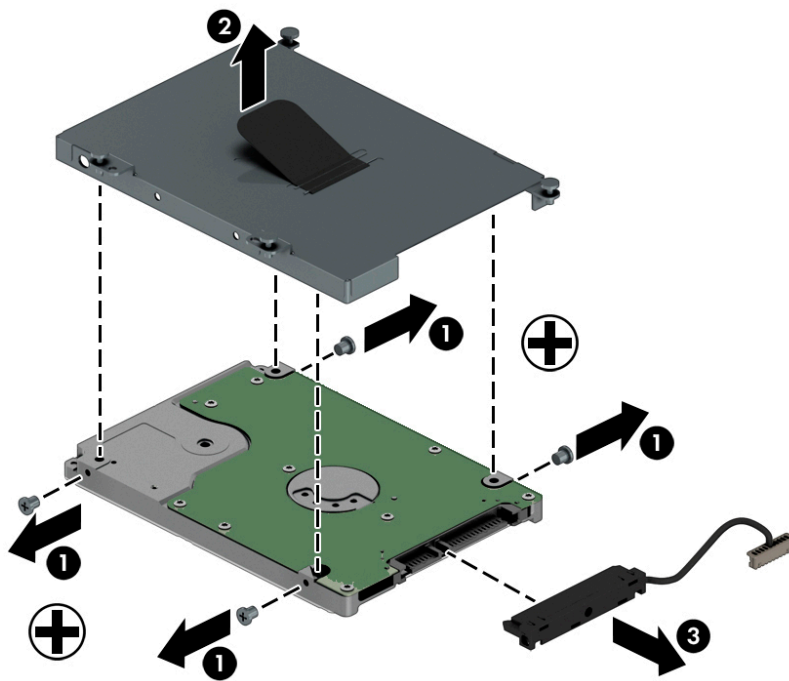

Reverse this procedure to install the hard drive.

## RTC battery

Description	Spare part number
RTC battery (includes cable and double-sided adhesive)	922939-001

Before removing the RTC battery, follow these steps:

1. Turn off the computer. If you are unsure whether the computer is off or in Hibernation, turn the computer on, and then shut it down through the operating system.
2. Disconnect the power from the computer by unplugging the power cord from the computer.
3. Disconnect all external devices from the computer.
4. Remove the bottom cover (see [Bottom cover on page 36](#)).
5. Disconnect the battery (see [Battery on page 37](#)).

Remove the RTC battery:

1. Disconnect the RTC battery cable **(1)** from the system board.
2. Detach the RTC battery **(2)** from the base enclosure. (The RTC battery is attached to the base enclosure with double-sided adhesive.)

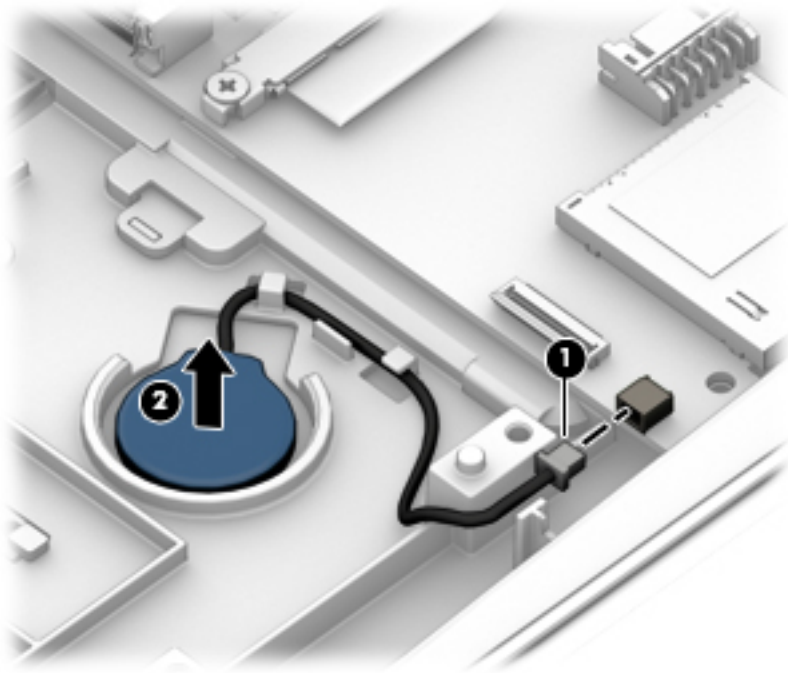

3. Remove the RTC battery and cable.

Reverse this procedure to install the RTC battery.

## Keyboard

For use in country or region	Spare part number	For use in country or region	Spare part number
<b>Keyboard with backlight and pointing stick (includes keyboard cable and backlight cable:</b>			
The pointing stick cable is available in the Cable Kit using spare part number 848244-001.			
For use in Belgium	848311-A41	For use in Northwest Africa	848311-FP1
For use in Brazil	848311-201	For use in Norway	848311-091
For use in Bulgaria	848311-261	For use in Portugal	848311-131
For use in Canada	848311-DB1	For use in Romania	848311-271
For use in the Czech Republic and Slovakia	848311-FL1	For use in Russia	848311-251
For use in Denmark	848311-081	For use in Saudi Arabia	848311-171
For use in France	848311-051	For use in Slovenia	848311-BA1
For use in Germany	848311-041	For use in South Korea	848311-AD1
For use in Greece	848311-151	For use in Spain	848311-071
For use in Hungary	848311-211	For use in Sweden and Finland	848311-B71
For use in Iceland	848311-DD1	For use in Switzerland	848311-BG1
For use in India	848311-D61	For use in Taiwan	848311-AB1
For use in Israel	848311-BB1	For use in Thailand	848311-281
For use in Italy	848311-061	For use in Turkey	848311-141
For use in Japan	848311-291	For use in the United Kingdom and Singapore	848311-031
For use in Latin America	848311-161	For use in the United States	848311-001
For use in the Netherlands	848311-B31		

Before removing the keyboard, follow these steps:

1. Turn off the computer. If you are unsure whether the computer is off or in Hibernation, turn the computer on, and then shut it down through the operating system.
2. Disconnect the power from the computer by unplugging the power cord from the computer.
3. Disconnect all external devices from the computer.
4. Remove the bottom cover (see [Bottom cover on page 36](#)).
5. Disconnect the battery (see [Battery on page 37](#)).

Remove the keyboard:

1. Remove the two Phillips PM2.0×4.0 screws (1) that secure the keyboard to the computer.

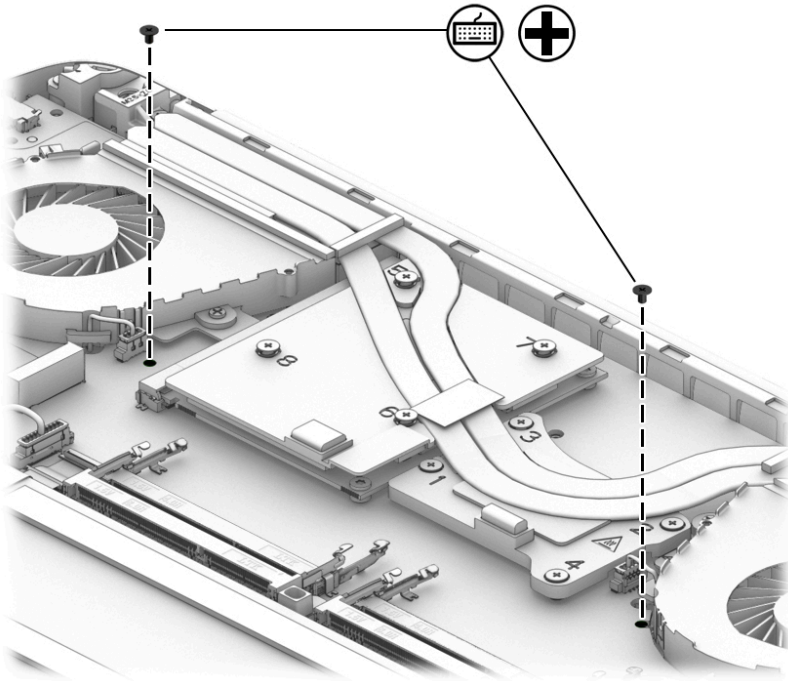

2. Partially open the computer.
3. Rest and secure the computer on its left side.
4. Insert a thin tool into the keyboard release hole near the fan, and then press on the back of the keyboard until the keyboard disengages from the computer.

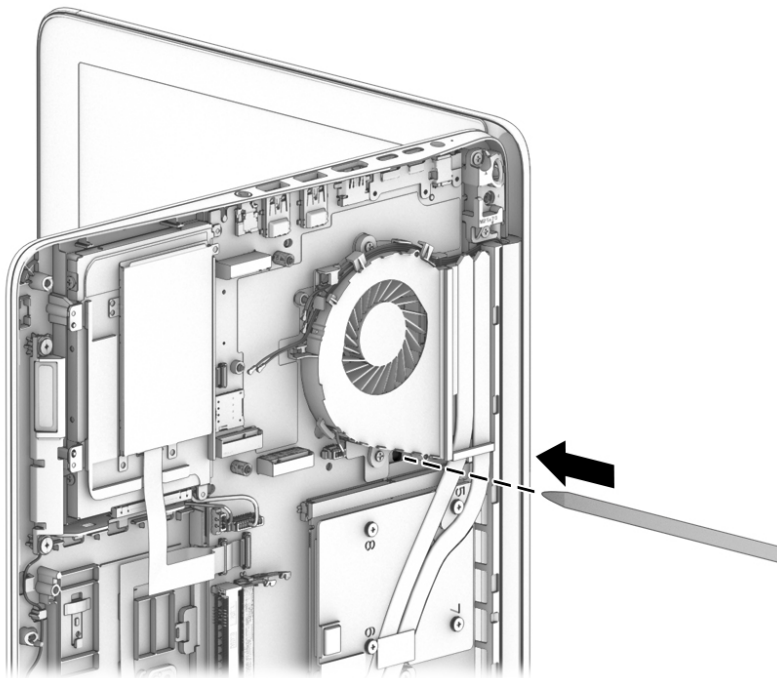

5. Turn the computer right-side up, with the front toward you.
6. Open the computer as far as it will open.
7. Swing the rear edge of the keyboard (1) up and forward until it rests upside down on the palm rest.

8. Release the zero insertion force (ZIF) connector **(2)** to which the keyboard cable is attached, and then disconnect the keyboard cable from the system board **(3)**.
9. Release the ZIF connector **(4)** to which the pointing stick cable is attached, and then disconnect the pointing stick cable from the system board **(5)**.
10. Release the ZIF connector **(6)** to which the backlight cable is attached, and then disconnect the backlight cable from the system board **(7)**.
11. Remove the keyboard **(8)**.

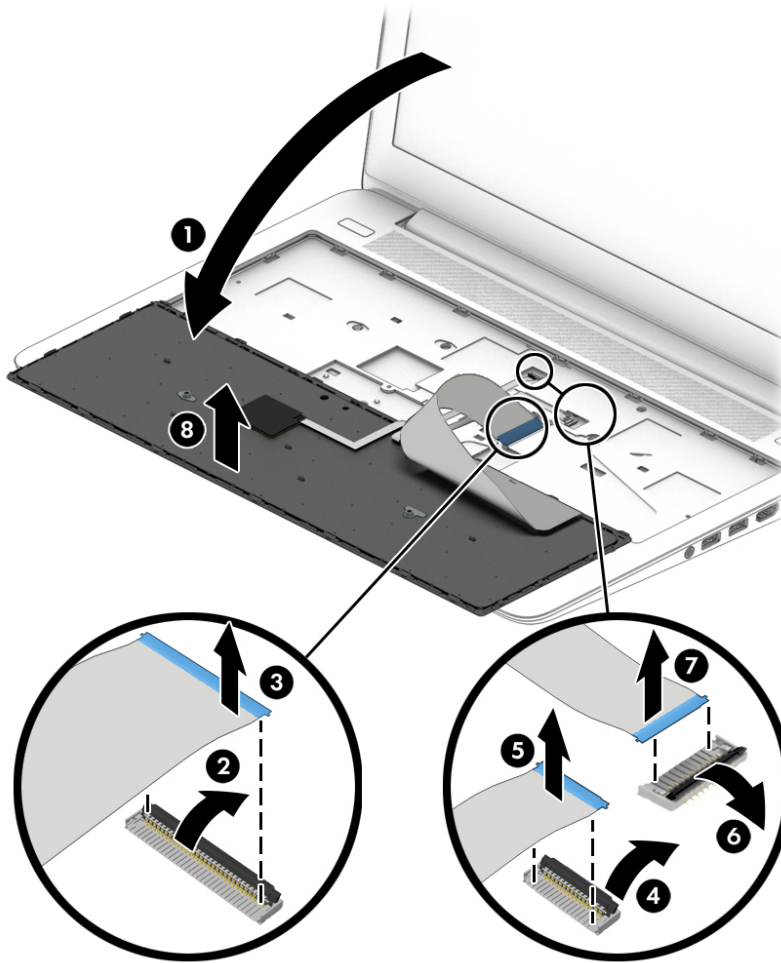

Reverse this procedure to install the keyboard.

## Heat sink assembly

 **NOTE:** Only remove the heat sink from the system board if its removal is required to remove other components. It is preferred to leave the heat sink connected to the system board when possible to preserve the thermal materials used between the heat sink and system board. Removal of the heat sink requires reapplication of this thermal material.

 **NOTE:** The heat sink assembly spare part kit includes replacement thermal material.

Description	Spare part number
Heat sink for use only in models with UMA graphics memory	922938-001
Heat sink for use only in models with Nvidia Quadro M1200 and M620 graphics boards	922935-001
Heat sink for use only in models with Nvidia Quadro M2200 graphics boards	922936-001
Heat sink for use only in models with the AMD Radeon Pro graphics board	922937-001

Before removing the heat sink, follow these steps:

1. Turn off the computer. If you are unsure whether the computer is off or in Hibernation, turn the computer on, and then shut it down through the operating system.
2. Disconnect the power from the computer by unplugging the power cord from the computer.
3. Disconnect all external devices from the computer.
4. Remove the bottom cover (see [Bottom cover on page 36](#)).
5. Disconnect the battery (see [Battery on page 37](#)).

Remove the heat sink:

1. On models with discrete graphics memory:
  - a. Following the sequence stamped into the processor heat sink, loosen the eight Phillips captive screws **(1)** that secure the processor heat sink to the system board.

- b.** Remove the heat sink **(2)**.

 **NOTE:** Due to the adhesive quality of the thermal material located between the heat sink assembly and the system board components, it may be necessary to move the heat sink assembly from side to side to detach it.

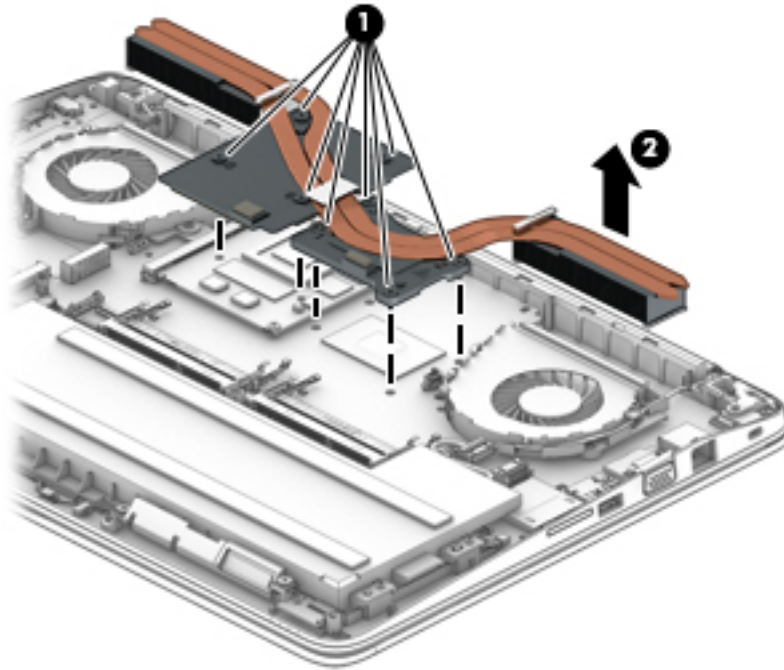



- 2.** On models with UMA graphics memory:

- a.** Following the sequence stamped into the processor heat sink, loosen the four Phillips captive screws **(1)** that secure the heat sink to the system board.

b. Remove the heat sink (2).

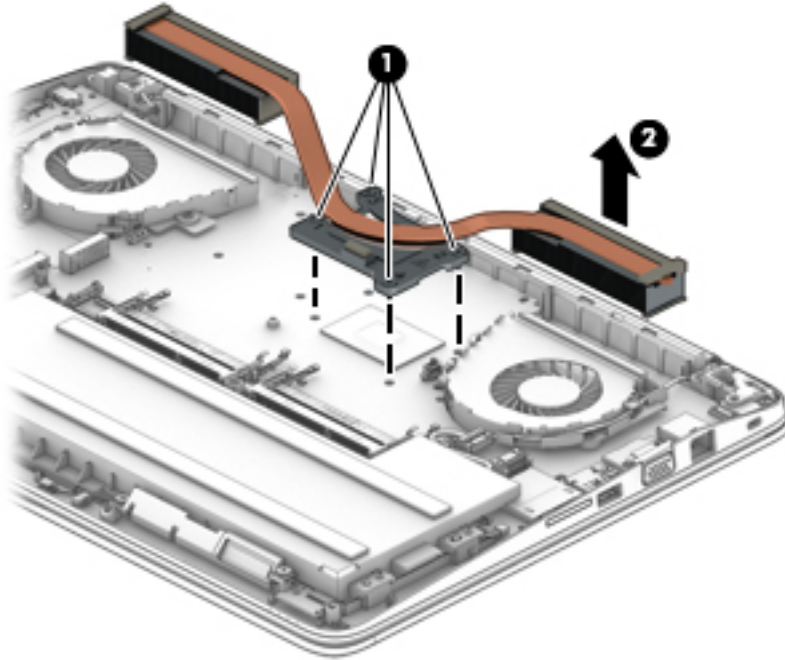
 **NOTE:** Due to the adhesive quality of the thermal material located between the heat sink assembly and the system board components, it may be necessary to move the heat sink assembly from side to side to detach it.



 **NOTE:** The thermal material must be thoroughly cleaned from the surfaces of the heat sink assembly and the system board components each time the heat sink assembly is removed. Replacement thermal material is included with the heat sink assembly, processor, and system board spare part kits.

- On models with discrete graphics memory, thermal pads are used on the processor (1) and the graphics board (3) and the heat sink sections (2) and (4), respectively, that service them

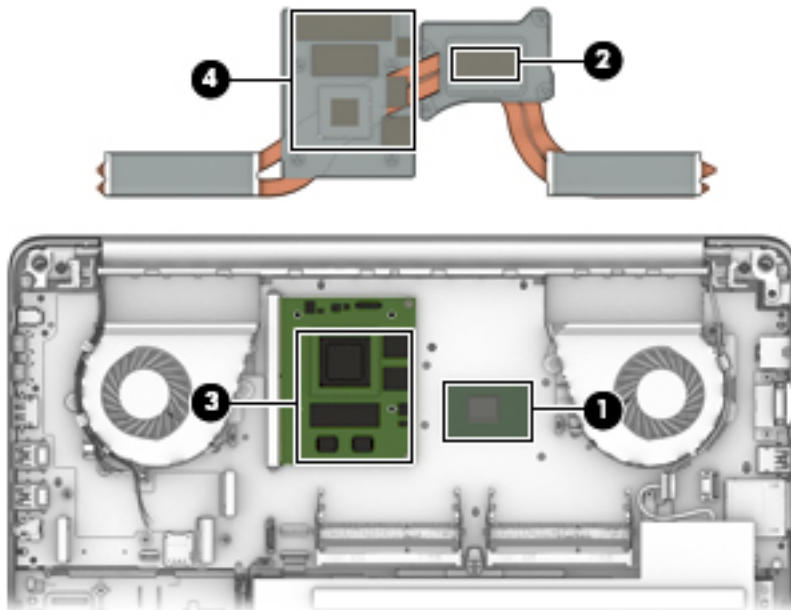



- On models with UMA graphics memory, thermal pads are used on the processor **(1)** and the heat sink section **(2)** that services it

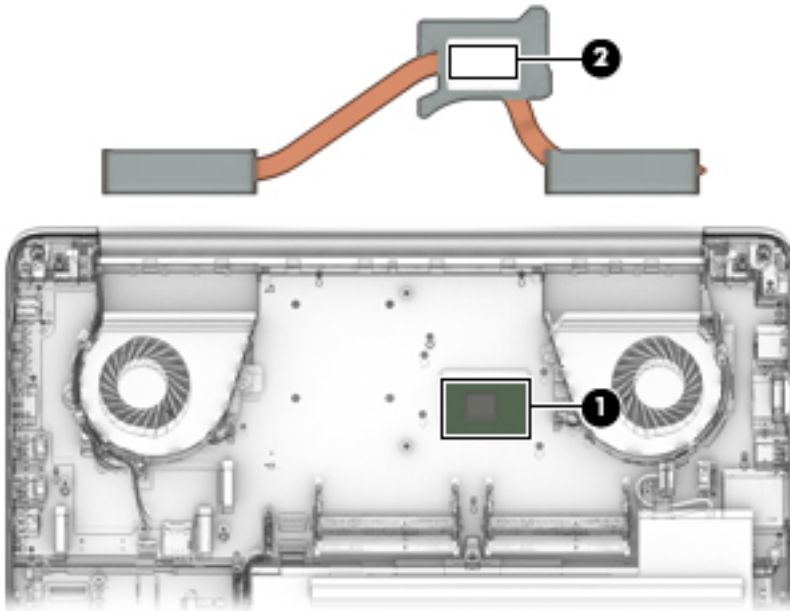

Reverse this procedure to install the heat sink assembly.

## Graphics board



**NOTE:** The graphics board spare part kit includes replacement thermal material.

Description	Spare part number
NVIDIA Quadro M2200 graphics board	924955-001
NVIDIA Quadro M1200 graphics board	924954-001
NVIDIA Quadro M620 graphics board	924953-001
AMD Radeon Pro WX 4150	924956-001

Before removing the graphics board, follow these steps:

1. Turn off the computer. If you are unsure whether the computer is off or in Hibernation, turn the computer on, and then shut it down through the operating system.
2. Disconnect the power from the computer by unplugging the power cord from the computer.
3. Disconnect all external devices from the computer.
4. Remove the bottom cover (see [Bottom cover on page 36](#)).
5. Disconnect the battery (see [Battery on page 37](#)).
6. Remove the heat sink (see [Heat sink assembly on page 52](#)).

Remove the graphics board:

1. Remove the two Torx T8M3.0×5.5 screws **(1)** that secure the graphics board to the system board.
2. Lift the edge of graphics board upward until it sits at an angle **(2)**, and then remove the board from the socket **(3)**.

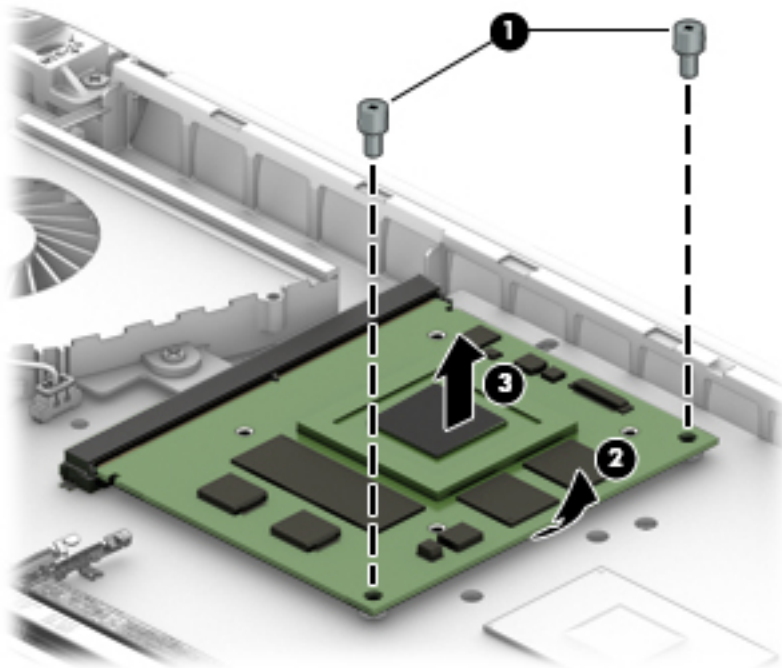

Reverse this procedure to install the graphics board.

## Speakers

Description	Spare part number
Speakers (includes cable)	848233-001

Before removing the speakers, follow these steps:

1. Turn off the computer. If you are unsure whether the computer is off or in Hibernation, turn the computer on, and then shut it down through the operating system.
2. Disconnect the power from the computer by unplugging the power cord from the computer.
3. Disconnect all external devices from the computer.
4. Remove the bottom cover (see [Bottom cover on page 36](#)).
5. Remove the battery (see [Battery on page 37](#)).

Remove the speakers:

1. Disconnect the speaker cable **(1)** from the system board.
2. Remove the three Phillips PM2.5×5.0 screws **(2)** that secure the speakers to the base enclosure.
3. Remove the cable from the clips built into the chassis **(3)**, and then remove the speakers **(4)**.

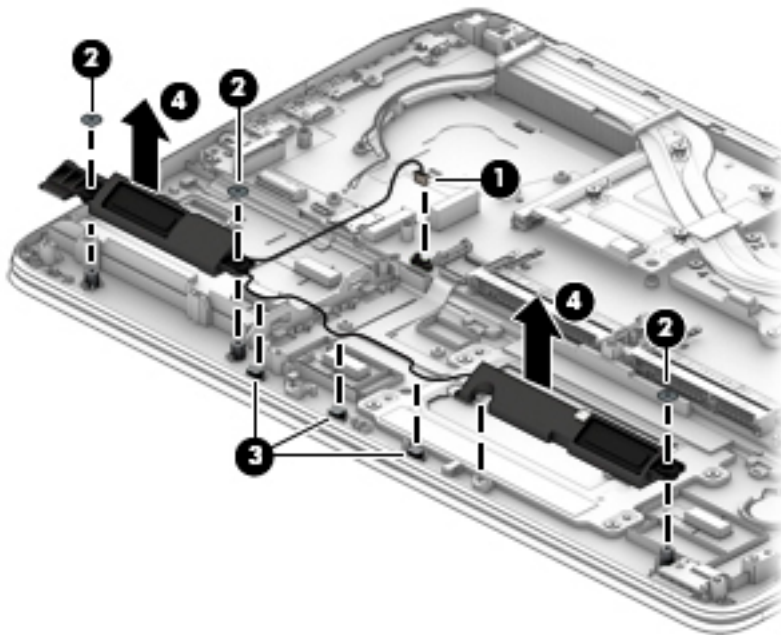

Reverse this procedure to install the speakers.

## TouchPad module

Description	Spare part number
TouchPad module	850944-001
The TouchPad module cable is available in the Cable Kit using spare part number 848244-001.	

Before removing the TouchPad module, follow these steps:

1. Turn off the computer. If you are unsure whether the computer is off or in Hibernation, turn the computer on, and then shut it down through the operating system.
2. Disconnect the power from the computer by unplugging the power cord from the computer.
3. Disconnect all external devices from the computer.
4. Remove the bottom cover (see [Bottom cover on page 36](#)).
5. Disconnect the battery (see [Battery on page 37](#)).
6. Remove the left speaker (see [Speakers on page 57](#)).

Remove the TouchPad module:

1. Disconnect the TouchPad cable from the TouchPad board **(1)**.
2. Remove the four Phillips PM2.5×3.0 screws **(2)** that secure the TouchPad module to the top cover.
3. Pull the TouchPad out from under the lip near the system board **(3)**.
4. Remove the TouchPad module **(4)** and cable

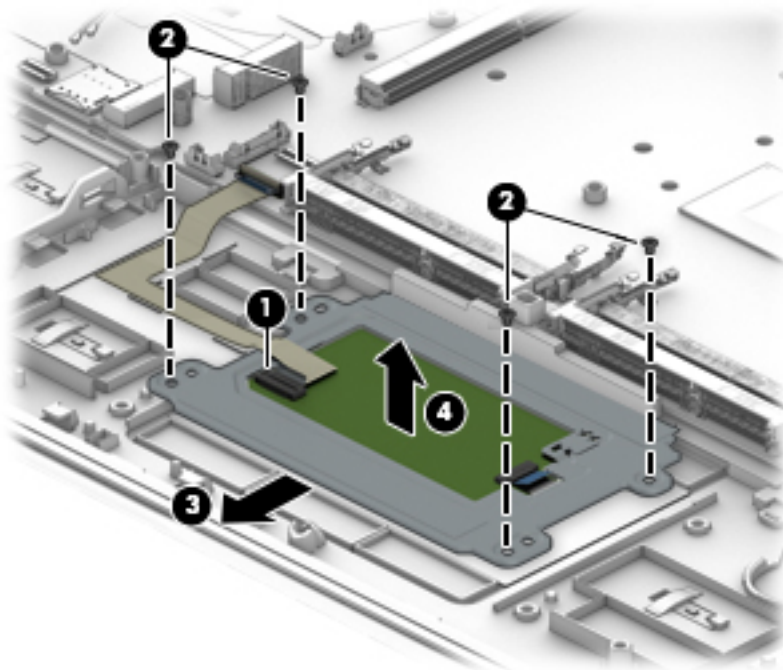

Reverse this procedure to install the TouchPad module.

## LED board

Description	Spare part number
LED board (includes cable)	848246-001

Before removing the LED board, follow these steps:

1. Turn off the computer. If you are unsure whether the computer is off or in Hibernation, turn the computer on, and then shut it down through the operating system.
2. Disconnect the power from the computer by unplugging the power cord from the computer.
3. Disconnect all external devices from the computer.
4. Remove the bottom cover (see [Bottom cover on page 36](#)).
5. Remove the battery (see [Battery on page 37](#)).

Remove the LED board:

1. Disconnect the LED board from the system board **(1)**.
2. Lift to release the LED board cable from the adhesive that secures it to the computer **(2)**.
3. Remove the Phillips PM2.5×3.0 screw **(3)** that secures the LED board to the computer.
4. Remove the LED board and cable from the computer **(4)**.

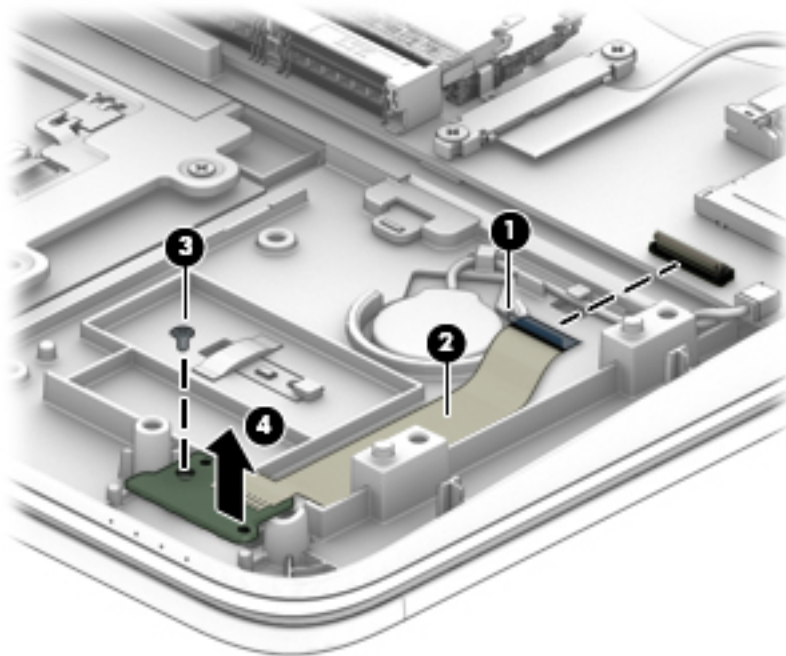

Reverse this procedure to install the LED board.

## Fans

Description	Spare part number
Fan for use over the processor	848251-001
Fan for use over the graphics card	848252-001

Before removing the fan, follow these steps:

1. Turn off the computer. If you are unsure whether the computer is off or in Hibernation, turn the computer on, and then shut it down through the operating system.
2. Disconnect the power from the computer by unplugging the power cord from the computer.
3. Disconnect all external devices from the computer.
4. Remove the bottom cover (see [Bottom cover on page 36](#)).
5. Disconnect the battery (see [Battery on page 37](#)).

Remove the fans:

- ▲ To remove the fans:
  - a. Remove the display cable from the clips in the left fan **(1)**.
  - b. Remove the antenna cables from the clips in the right fan **(2)**.
  - c. Disconnect the fan cables from the system board **(3)**.
  - d. Loosen the two captive Phillips screws that secure each fan to the computer **(4)**.
  - e. Remove the fans **(5)**.

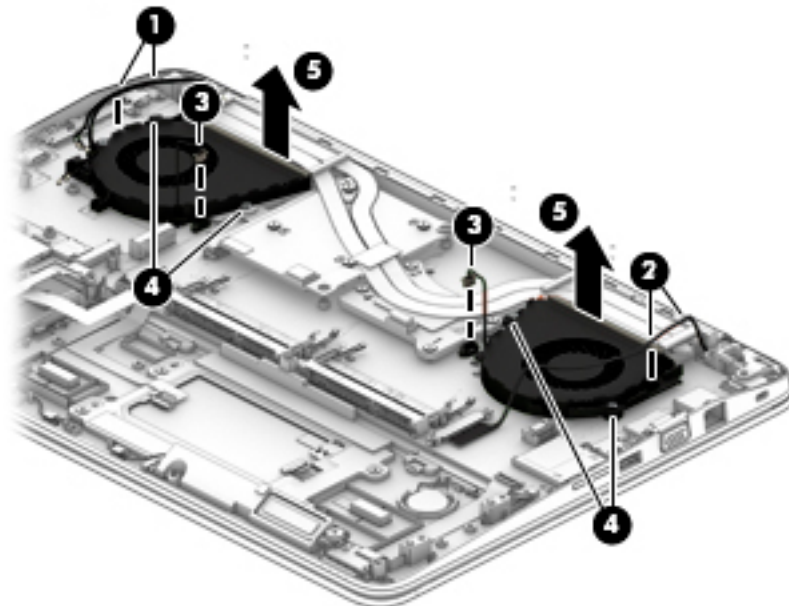

Reverse this procedure to install the fans.

## Fingerprint reader board

Description	Spare part number
Fingerprint reader board (includes cable)	850151-001
The fingerprint reader bracket is available in the Bracket Kit, spare part number 848232-001.	

Before removing the fingerprint reader board, follow these steps:

1. Turn off the computer. If you are unsure whether the computer is off or in Hibernation, turn the computer on, and then shut it down through the operating system.
2. Disconnect the power from the computer by unplugging the power cord from the computer.
3. Disconnect all external devices from the computer.
4. Remove the bottom cover (see [Bottom cover on page 36](#)).
5. Remove the battery (see [Battery on page 37](#)).
6. Remove the solid-state drive (see [Solid-state drive \(M.2\) on page 40](#)).
7. Remove the smart card reader (see [Smart card reader on page 45](#)).
8. Remove the hard drive (see [Hard drive on page 46](#)).
9. Remove the WLAN module (see [WLAN module on page 41](#)).

Remove the fingerprint reader board:

1. Turn the top cover upside down with the front toward you.
2. Remove the Phillips PM2.0×2.0 screw **(1)** that secures the fingerprint reader board and bracket to the top cover.
3. Lift the fingerprint reader board bracket off the fingerprint reader board **(2)**.  
The fingerprint reader board bracket is available in the Bracket Kit, spare part number 848232-001.
4. Detach the fingerprint reader board cable **(3)** from the system board.

5. The fingerprint reader board cable is attached to the top cover with double-sided adhesive. Use a tool to pry the fingerprint reader board up (4), and then remove the board and cable.

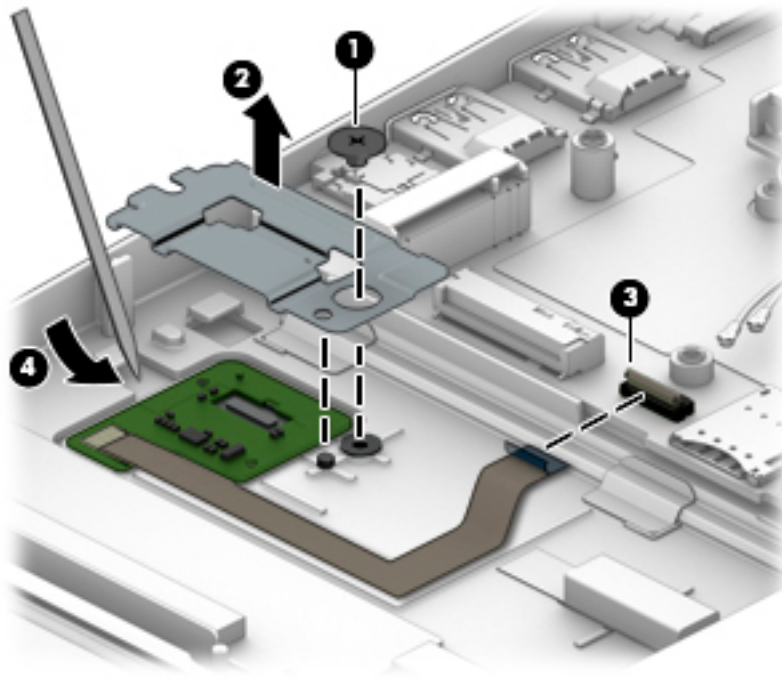

Reverse this procedure to install the fingerprint reader board.

## System board

**NOTE:** The system board spare part kit includes replacement thermal material.

All system boards use the following part numbers:

xxxxxx-001: Windows 7 or non-Windows operating systems

xxxxxx-601: Windows 10 operating system

Description	Spare part number
System board, equipped with an Intel Core i7-7820HQ processor	921048-xxx
System board, equipped with an Intel Core i7-7700HQ processor	921047-xxx
System board, equipped with an Intel Core i7-7440HQ processor	921046-xxx
System board, equipped with an Intel Core i7-7300HQ processor	921045-xxx
System board, equipped with an Xeon E3-1535M processor	921050-xxx
System board, equipped with an Xeon E3-1505M processor	921049-xxx

Before removing the system board, follow these steps:

1. Turn off the computer. If you are unsure whether the computer is off or in Hibernation, turn the computer on, and then shut it down through the operating system.
2. Disconnect the power from the computer by unplugging the power cord from the computer.
3. Disconnect all external devices from the computer.



4. Remove the bottom cover (see [Bottom cover on page 36](#)).
5. Remove the battery (see [Battery on page 37](#)).
6. Remove the hard drive (see [Hard drive on page 46](#)).
7. Remove the keyboard (see [Keyboard on page 49](#)).
8. Remove the fans (see [Fans on page 60](#)).
9. Remove the smart card reader (see [Smart card reader on page 45](#)).

 **NOTE:** When replacing the system board, be sure that the following components are removed from the defective system board and installed on the replacement system board:

- Solid-state drive (see [Solid-state drive \(M.2\) on page 40](#))
- WLAN module (see [WLAN module on page 41](#))
- WWAN module (see [WWAN module on page 43](#))
- Memory modules (see [Memory module on page 38](#))
- Graphics board (see [Graphics board on page 56](#))

Remove the system board:

1. Remove the two Phillips PM2.0×3.0 screws from the bracket atop the display connector **(1)**, and then remove the bracket **(2)**.
2. Disconnect the display cable **(3)**.
3. Disconnect the remaining cables from the system board:
  - (4)** Fingerprint reader cable
  - (5)** TouchPad cable
  - (6)** RTC battery cable
  - (7)** Speaker cable
  - (8)** LED board cable

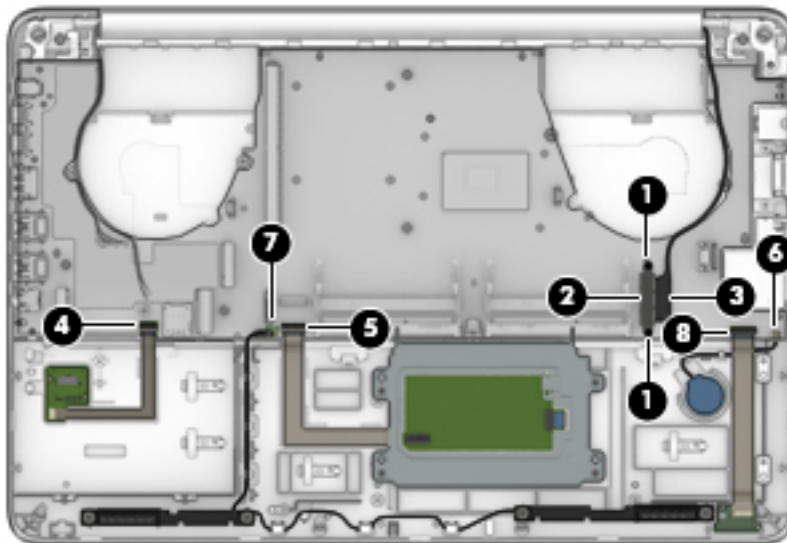

4. Remove the two Phillips PM2.5×7.0 screws **(1)** from the VGA bracket, and then remove the bracket **(2)**.
5. Remove the three Phillips PM2.5×7.0 screws **(3)** from the USB-C bracket, and then remove the bracket **(4)**.

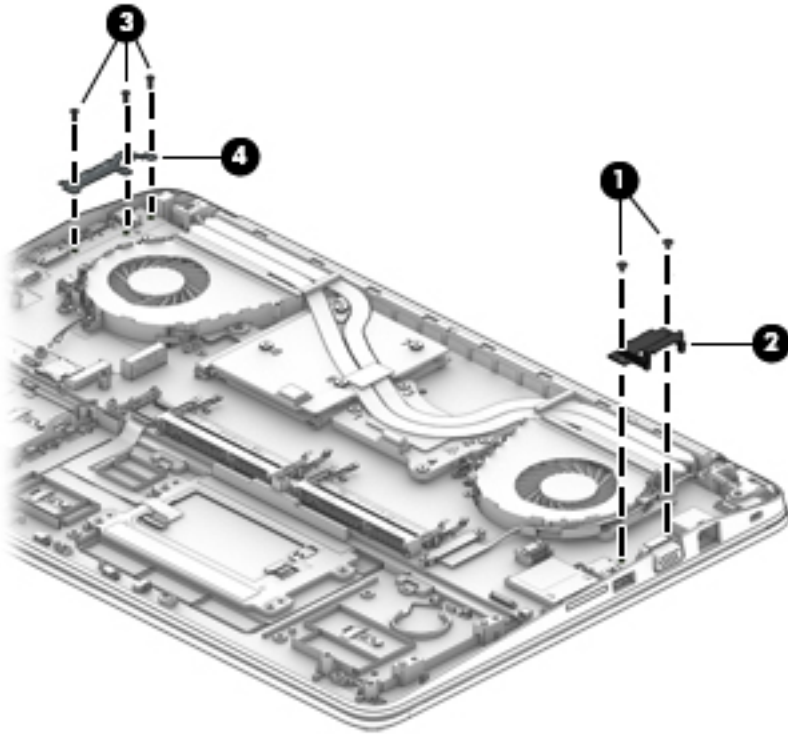

6. Remove the four Phillips PM2.5×5.0 screws **(1)** that secure the system board to the computer.
7. Lift up on the left side of the system board **(2)** until it rests at an angle.
8. Remove the system board **(3)** by sliding it up and to the left.

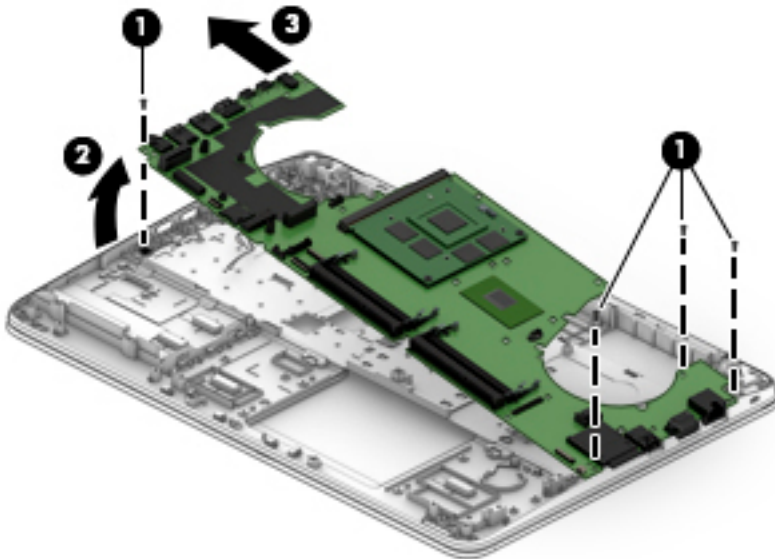

Reverse this procedure to install the system board.

## Display assembly

 **NOTE:** Touch display assemblies are spared as a whole unit assemblies only. Non-touch display assemblies are spared at the subcomponent level and as whole units.

To remove the display assembly and non-touch display subcomponents, follow these steps:

1. Turn off the computer. If you are unsure whether the computer is off or in Hibernation, turn the computer on, and then shut it down through the operating system.
2. Disconnect the power from the computer by unplugging the power cord from the computer.
3. Disconnect all external devices from the computer.
4. Remove the bottom cover (see [Bottom cover on page 36](#)).
5. Disconnect the battery (see [Battery on page 37](#)).

Remove the display assembly:

1. Close the computer.
2. Position the computer upside down.
3. Remove the antenna cables from the clips in the graphics card fan **(1)** and disconnect the antenna cables from the WLAN module **(2)**.
4. Remove the two Phillips PM2.0×3.0 screws **(3)** that secure bracket atop the display panel cable on the system board.
5. Remove the display panel cable bracket **(4)**.

The display panel cable bracket is included in the Bracket Kit, spare part number 848232-001.

6. Remove the display cable from the side of the processor fan and disconnect the cable **(5)** from the system board.

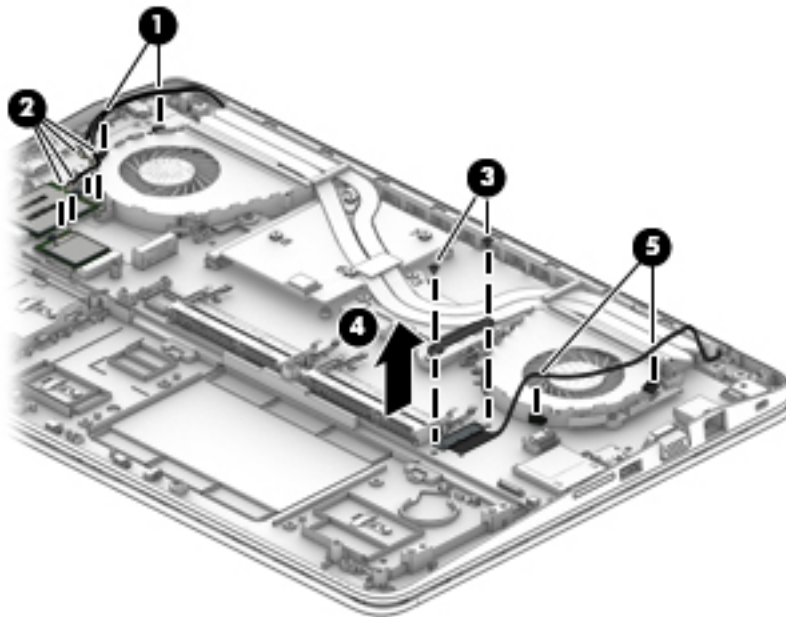

7. Open the computer with the display at a 90 degree angle as shown in the following image.
8. Remove the six Phillips PM2.5×7.0 screws **(1)** that secure the hinges to the computer.

9. Open the display all as far as possible **(2)**.
10. Separate the display from the computer **(3)**.

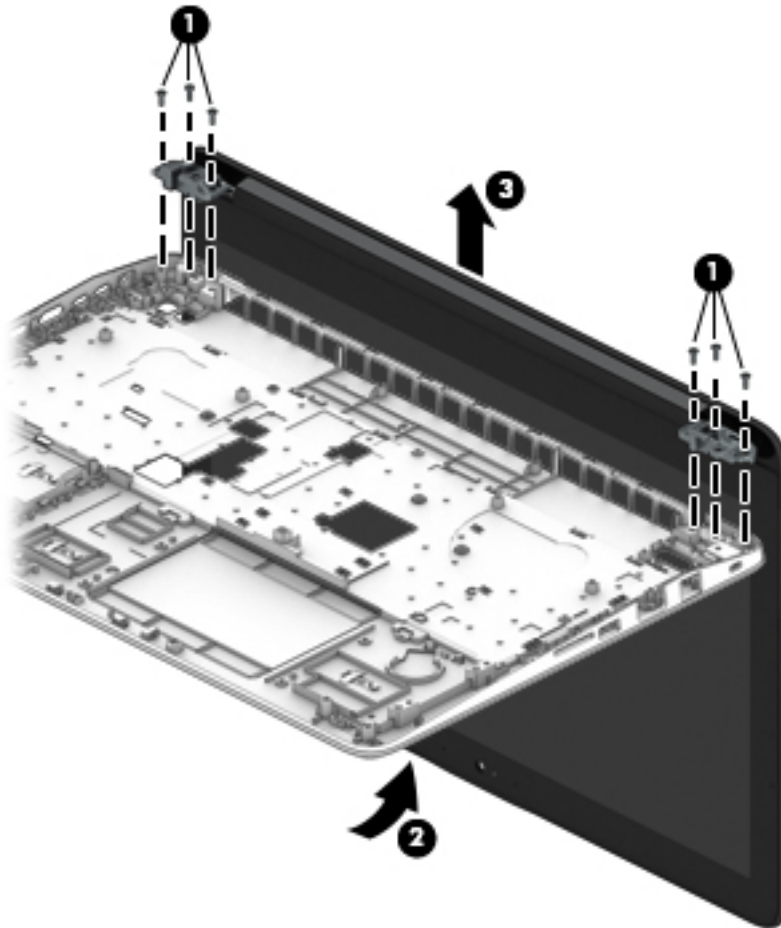

11. If it is necessary to replace the display assembly subcomponents:
  - a. Flex the inside edges of the top edge **(1)**, the left and right sides **(2)**, and the bottom edge **(3)** of the display bezel until the bezel disengages from the display enclosure.

- b. Remove the display bezel.

The display bezel is available using the following spare part numbers:

848241-001: Models without a camera

850154-001: Models with a camera

---

 **NOTE:** The display assembly will not be connected to the computer as shown in the following image.

---

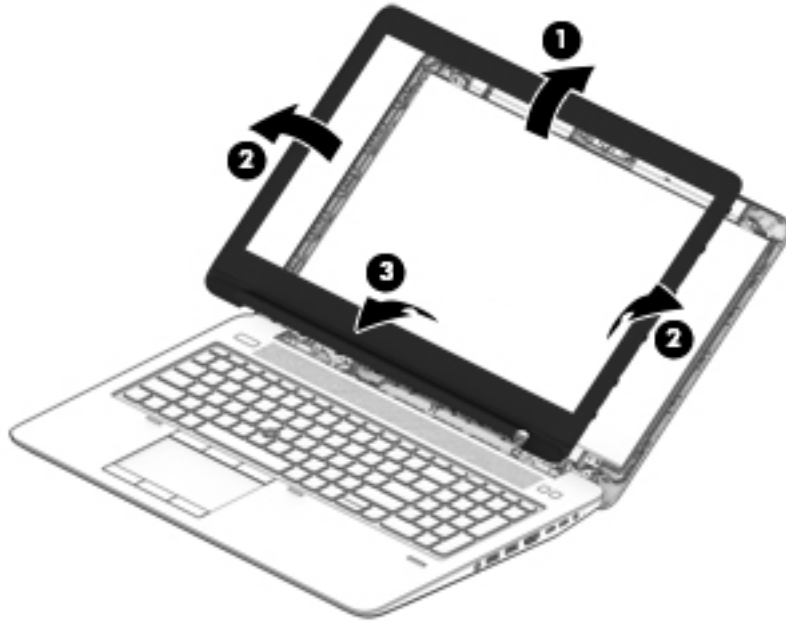

- 12. If it is necessary to replace the display panel:

- a. Remove the four Phillips PM2.0×3.0 screws that secure the display panel to the display enclosure.

---

 **NOTE:** The display assembly will not be connected to the computer as shown in the following image.

---

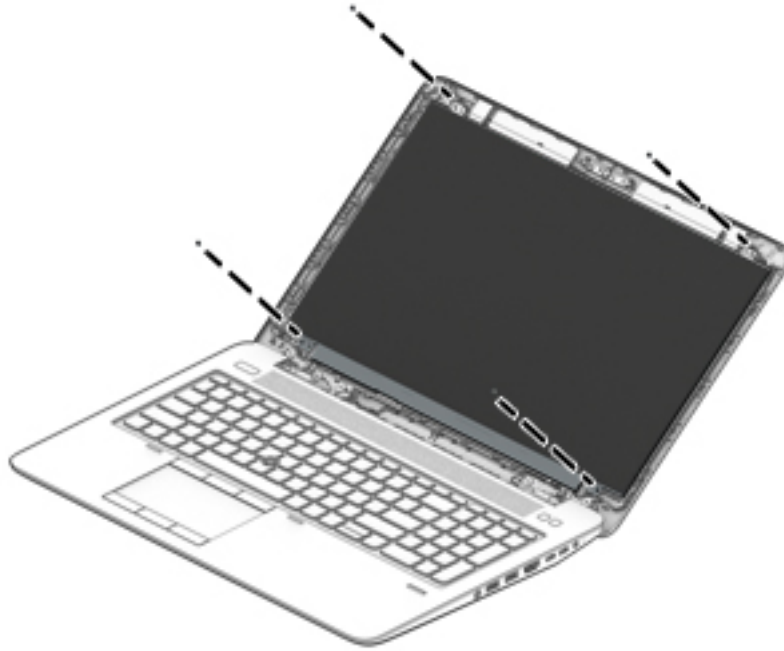

---

**⚠ CAUTION:** Before turning the display panel upside down, make sure the work surface is clear of tools, screws, and any other foreign objects. Failure to follow this caution can result in damage to the display panel.

---

- b.** Lift the top edge of the display panel **(1)** and swing it up and forward until it rests upside down in front of the display enclosure.
- c.** Release the adhesive strip that secures the display panel cable connector to the rear of the display panel, and then disconnect the display panel cable from the display panel **(2)**.

- d. Remove the display panel from the display enclosure **(3)**.

---

 **NOTE:** The display assembly will not be connected to the computer as shown in the following image.

---

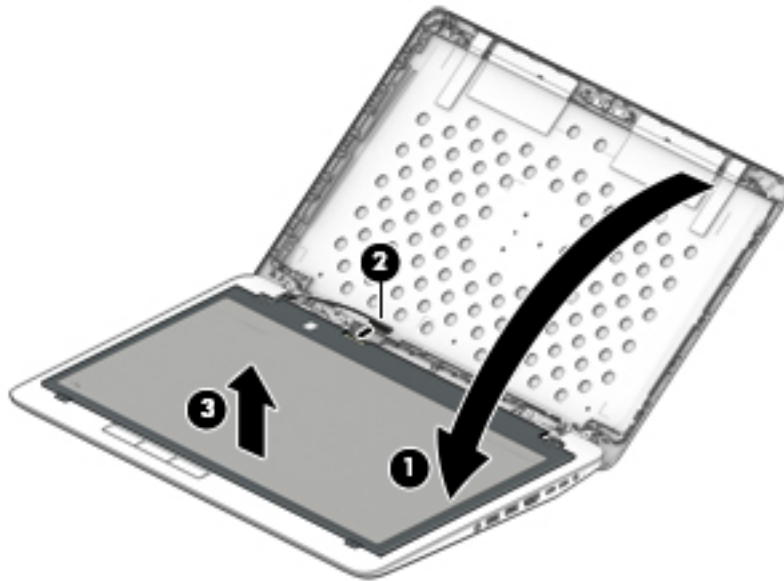

- e. Remove the display panel.

The display panel is available using the following spare part numbers:

SVA panel with display cable: 936518-001

UWVA panel with display cable: 936519-001

SVA panel without display cable: 819354-004

UWVA panel without display cable: 819355-005

13. If it is necessary to replace the camera/microphone module or microphone module:

---

 **CAUTION:** Handle the camera/microphone module and microphone module with caution. These modules have a thin profile and are susceptible to damage when not handled carefully.

---

- a. Detach the camera/microphone module **(1)** from the display enclosure. (The camera/microphone module is attached to the display enclosure with adhesive.)
- b. Disconnect the cable **(2)** from the camera/microphone module.

- c. Remove the camera/microphone module **(3)** from the display enclosure.

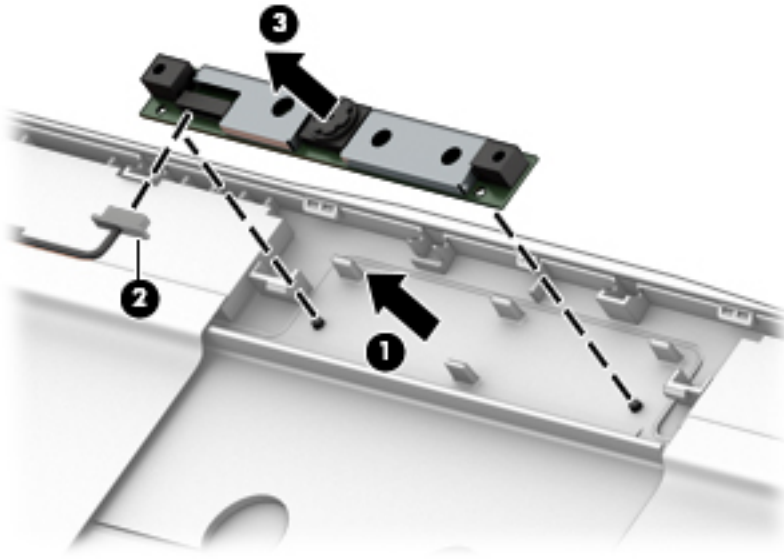

- d. Remove the camera/microphone module.

The camera/microphone module is available using spare part number 819336-006. The microphone module is available using spare part number 854110-001.

- 14. If it is necessary to replace the display hinges:

- a. Remove the display cable from the left hinge **(1)**.
- b. Remove the antenna cables from the right hinge **(2)**.
- c. Remove the eight Phillips PM2.5×2.5 screws **(3)**, and then remove the display hinges from the enclosure.

The display hinges are available using spare part number 848242-001 and include the left and right hinges.

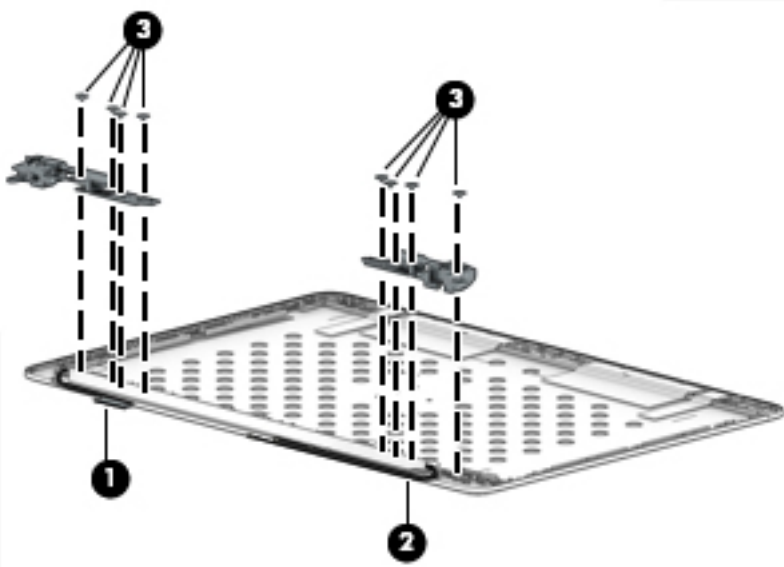

- 15. If it is necessary to replace the display/camera cable:



- a. Remove the cable from under the tape on the left side of the display enclosure (1).
- b. Remove the display/camera cable from the enclosure (2).

The display/camera cable is available using spare part number 848253-001.

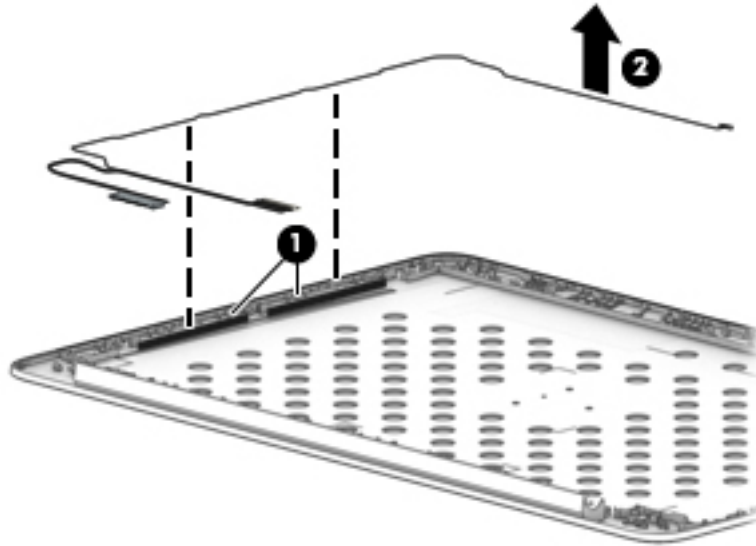

16. If it is necessary to replace the WLAN antennas, release the WLAN antenna cables from the routing channels built into the display enclosure (1), and then lift the cables from the display enclosure (2).

The WLAN antennas are available using spare part number 848228-001

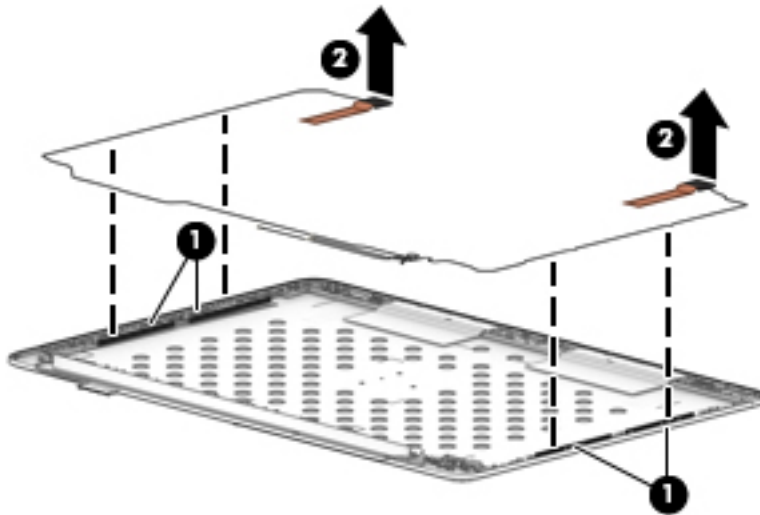

17. If it is necessary to replace the WWAN antennas, release the WWAN antenna cables from the routing channels built into the display enclosure (1), and then lift the cables from the display enclosure (2).

The WWAN antennas are available using spare part number 848229-001

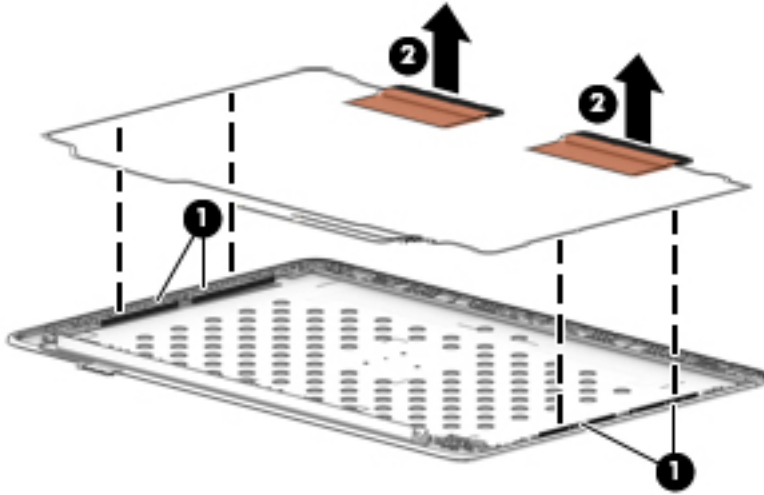

Reverse this procedure to reassemble and install the display assembly.

## Lock bracket

Before removing the lock bracket, follow these steps:

1. Turn off the computer. If you are unsure whether the computer is off or in Hibernation, turn the computer on, and then shut it down through the operating system.
2. Disconnect the power from the computer by unplugging the power cord from the computer.
3. Disconnect all external devices from the computer.
4. Remove the bottom cover (see [Bottom cover on page 36](#)).
5. Disconnect the battery (see [Battery on page 37](#)).
6. Disconnect the display assembly (see [Display assembly on page 65](#)).

Remove the lock bracket:

1. Remove the Phillips PM2.5×5.0 screw **(1)** that secures the lock bracket to the base enclosure.
2. Remove the bracket **(2)**.

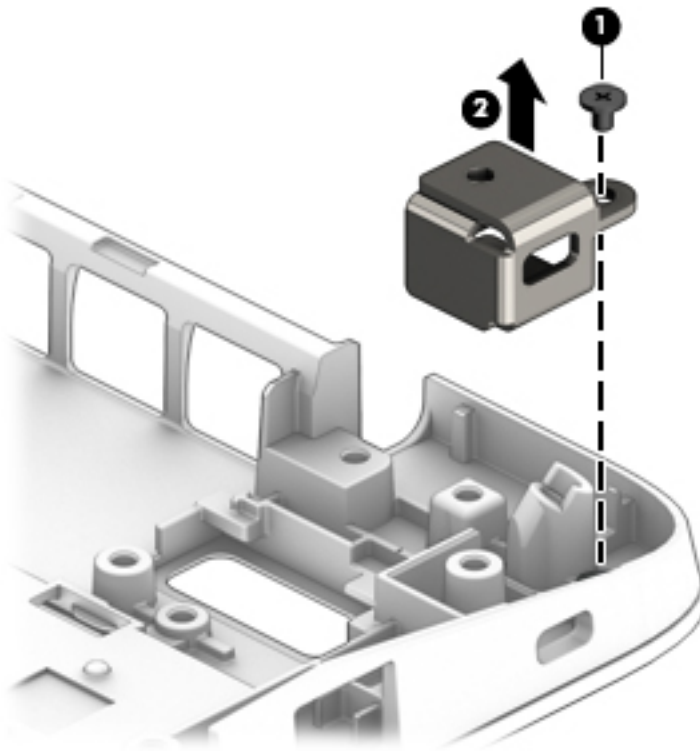

Reverse this procedure to install the lock bracket.

---

## 6 Troubleshooting guide

This chapter is primarily focused on troubleshooting HP Mobile Workstations and HP Notebooks. The information is provided so that you can solve problems yourself or at least narrow down what may be causing the problem. Based on some of the most common symptoms, this chapter helps to identify logical steps and available resources or tools for resolving an issue. HP recommends that you follow the instructions carefully, observe safety precautions, and note any observations or results. Capturing this information may help identify and resolve the problem faster.

---

**⚠ WARNING!** To reduce the risk of electric shock or damage to the equipment:

- Do not disable the power cord grounding plug. The grounding plug is an important safety feature.
- Plug the power cord into a grounded (earthed) outlet that is easily accessible at all times.
- Disconnect power from the equipment by unplugging the power cord from the AC outlet.
- Before disassembling notebooks, always disconnect power and remove the battery.

**⚠ CAUTION:** Static electricity can damage the electronic components of the computer. To prevent damage to the computer, carefully observe the electrostatic discharge precautions.

- Discharge static electricity by briefly touching a grounded metal object before you begin.
- Work on a static-free mat.
- Wear a static strap to ensure that any accumulated electrostatic charge is discharged from your body to the ground.
- Create a common ground for the equipment you are working on by connecting the static-free mat, static strap, and peripheral units to that piece of equipment.
- Refer to the Electrostatic Discharge Section of the Maintenance & Service Guide for more information.

**CAUTION:** The computer includes customer self-repair parts and parts that should only be accessed by an authorized service provider. See the chapter titled "Removal and replacement procedures for Customer Self-Repair parts," for details. Accessing parts described in the chapter titled "Removal and replacement procedures for authorized service provider only parts" can damage the computer or void the computer warranty.

---

# Resources

HP Resource Tool	Description	Link
HP Elite Support	Provides live HP Premium support (available 24/7) to Elite computers.	<a href="http://www8.hp.com/us/en/ads/elite-products/overview.html">http://www8.hp.com/us/en/ads/elite-products/overview.html</a>
HP Support Center	Provides important support, such as warranty, support cases, drivers, Customer Advisories, Customer and Security Bulletins, and Product Change Notices.	<a href="http://h20565.www2.hp.com/portal/site/hpsc">http://h20565.www2.hp.com/portal/site/hpsc</a>
HP Troubleshooting Support page	Provides troubleshooting information for your specific HP computer.	<a href="http://www8.hp.com/us/en/troubleshooting.html">http://www8.hp.com/us/en/troubleshooting.html</a>
Troubleshooting Problems with Docking Stations	Provides troubleshooting information for HP docking stations.	<a href="http://support.hp.com/us-en/document/c03247469">http://support.hp.com/us-en/document/c03247469</a>
Subscribers Choice	Allows you to sign up for HP product updates.	<a href="http://www8.hp.com/us/en/subscribe/">http://www8.hp.com/us/en/subscribe/</a>
HP Support Forums	Provide discussions about HP products and issues.	<a href="http://h30434.www3.hp.com/psg/">http://h30434.www3.hp.com/psg/</a>
Service Access Workbench (SAW) (Available for technicians and Business Partners only)	Provides navigable content intended for use by internal and outsourced call center staff and can be a resource for support and product division professionals.	<a href="http://sawpro.atlanta.hp.com/km/saw/home.do">http://sawpro.atlanta.hp.com/km/saw/home.do</a>
Vendors' web sites	Provide additional information for associated components such as Intel (processor, WLAN), Microsoft (Windows 7/8/10), AMD/NVidia (GPU), and so on.	<a href="http://www.intel.com/content/www/us/en/homepage.html">http://www.intel.com/content/www/us/en/homepage.html</a> <a href="http://www.microsoft.com">http://www.microsoft.com</a> <a href="http://www.amd.com">http://www.amd.com</a> <a href="http://www.nvidia.com">http://www.nvidia.com</a>

## General troubleshooting steps

A basic logic should be used when troubleshooting computer issues. This section will help you become familiar with troubleshooting methodology and efficiently resolve problems. Proceed through the steps in the following table until the issue is resolved, and then move on to the next step that is relevant to the issue. For example, if you resolve a memory issue using the HP PC Diagnostics (UEFI) tool in step 6, you can then move on to step 10 to reseal the memory into its memory slot.



**NOTE:** General troubleshooting steps do not have to be followed in a specific order.

**Table 6-1 Troubleshooting methodology and general troubleshooting steps**

Identify issue	Analyze issue	Resolve issue	Verify solution
<a href="#">1. Understand the issue on page 76</a>	<a href="#">5. Remove or uninstall recently added hardware, software on page 79</a>	<a href="#">8. Hard reset on page 89</a>	<a href="#">Verify solution on page 93</a>
<a href="#">2. Examine the environment on page 78</a>	<a href="#">6. HP Hardware Diagnostics and Tools on page 80</a>	<a href="#">9. Soft reset (Default Settings) on page 90</a>	
<a href="#">3. Perform a visual inspection of hardware on page 79</a>	<a href="#">7. Status lights, blinking light codes, troubleshooting lights, and POST error messages on page 84</a>	<a href="#">10. Reseat cables and connections on page 90</a>	
<a href="#">4. Update BIOS and drivers on page 79</a>		<a href="#">11. Test with minimum configuration on page 91</a>	

**Table 6-1 Troubleshooting methodology and general troubleshooting steps**

Identify issue	Analyze issue	Resolve issue	Verify solution
		<a href="#">12. Test with verified working configuration (hardware and/or operating system) on page 92</a>	
		<a href="#">13. Replace the system board on page 92</a>	

## Identify the issue

### 1. Understand the issue

It is important to understand the issue that occurred, including related symptoms. It helps to understand the basic computer boot-up sequence as well as the failure itself. The boot-up sequence and associated failures are described below.

#### *Boot up sequence*

The computer performs several steps after you press the power button or restart the computer.

It is important to understand where in the boot-up sequence the symptoms occur. The following table lists the phases of the boot-up sequence and explains the symptoms that may occur in each phase. For example, a blue screen error (BSOD) often occurs during the performance phase.

**Table 6-2 Boot-up sequence**

Item	Description
<b>Power-on</b>	<p>After power button is pressed, the computer boots after all internal power rails (i.e., 5V, 3.3V) are stable.</p> <p>Confirm that power lights are on fan is spinning.</p> <p>Next step: If the computer experiences a power-on issue, see “Verify Power Good (Troubleshooting) lights” in <a href="#">No Power on page 95</a>.</p> <p>Common issues: all lights are off; troubleshooting lights are on; does not boot; video is absent.</p>
<b>POST (UEFI/BIOS)</b>	<p>Power-On Self-Test (POST) verifies that hardware components (processor, hard drive, memory, etc.) are functional. When POST is complete, the HP logo displays briefly and then disappears.</p> <p>If there are errors, the computer may exhibit blinking lights and POST error messages</p> <p>Common issues: lights blink, error message appears, hangs.</p>
<b>Performance (operating system)</b>	<p>System boots to operating system, and Windows logo screen appears..</p> <p>Common issues: hangs (lock up/freezes), blue screen, video distorted, driver conflict, slow performance, display issue (dead pixel), I/O issue (no speaker sound), wireless/audio unavailable, noise.</p> <p>See <a href="#">Analyze the issue on page 79</a> table below for detailed troubleshooting information).</p>

#### *Failure classification*

Failure classification is a breakdown of different types of failures and symptoms that could occur during the boot-up sequence. Table 3 and table 4 represent the failure classification for common notebook failures.

Table 3 categorizes failures by the boot-up sequence.

1. Power-on: Common issues are No Power, Recycle/Reboot, etc.
2. POST: Common issues are No Boot (have power), Light Flash or Diagnostics Error.
3. Performance: Common issues are Intermittent Loss of Power, Blue Screen, Hang, etc. In many cases, issues may be identified and associated with a particular hardware (i.e., display, storage).

Table 4 categorizes failures by hardware.

4. Display
5. I/O devices (Input/Output)
6. Storage
7. Mechanical

A single symptom can be listed under different groups. For example, No Video can belong to (1) Power-on or (4) Display; but Flickering when powered should be listed in (4) Display. Or, in another example, a blue screen can be caused by a driver conflict in Performance (4), but it can also be caused by a defective hard drive under (6) Storage. Therefore, failures that share similar symptoms are noted..

If possible, make a record of the failure symptom, the phase of the boot-up sequence where the failure occurs, and the most likely location in the failure tree ([Table 6-3 Failure classification by boot-up sequence on page 77](#) and [Table 6-4 Failure classification by hardware devices and mechanical on page 78](#)). This will help isolate the issue and indicate the next steps. For example, when the computer is running the operating system, it may experience an issue with (4) Display, (5) I/O devices (keyboard, wireless, and so on), (6) Storage, or (7) Mechanical components (stuck buttons, thermal shutdown, and so on).



**NOTE:** “Uncategorized” is used if an issue found is not listed. For example, Bluetooth is offered on certain hardware configurations; therefore, a Bluetooth issue can be classified under “I/O Device” if needed.

## Failure classification by boot-up sequence

**Table 6-3 Failure classification by boot-up sequence**

1. Power-on	2. POST	3. Performance
1. <a href="#">No Power on page 95</a>	1. <a href="#">No video (with power) on page 101</a>	1. <a href="#">Intermittent shutdown on page 105<sup>a</sup></a>
2. <a href="#">Intermittent power-on, shutdown, reboot on page 97<sup>a</sup></a>	2. <a href="#">Blinking lights on page 102</a>	2. <a href="#">Blue screen (BSOD) error on page 131<sup>b</sup></a>
3. <a href="#">AC adapter issue on page 98</a>	3. <a href="#">Diagnostics error messages on page 103</a>	3. <a href="#">Freeze at Windows Logo (hang/lockup) on page 108</a>
4. <a href="#">Battery not recognized, not charging on page 99</a>	4. <a href="#">BIOS password on page 104</a>	4. <a href="#">Electromagnetic Interference (EMI) on page 109</a>
5. <a href="#">Battery discharges too fast on page 100</a>		5. <a href="#">No wake up on page 110</a>
6. <a href="#">Burnt smell on page 101</a>		6. <a href="#">Unresponsive on page 111</a>
		7. <a href="#">Slow performance on page 111<sup>c</sup></a>
		8. <a href="#">HP Smart Adapter warning message on page 112</a>
		9. <a href="#">Incorrect time and date on page 112</a>

<sup>a,b,c</sup> similar symptoms

## Failure classification by hardware devices and mechanical

**Table 6-4 Failure classification by hardware devices and mechanical**

4. Display	5. I/O devices	6. Storage	7. Mechanical
1. <a href="#">Display anomalies on page 113</a>	1. <a href="#">Keyboard on page 119</a>	1. <a href="#">Hard drive/solid-state drive not recognized on page 130</a>	1. <a href="#">Fan error message - 90B on page 133</a>
2. <a href="#">Dead pixel on page 115</a>	2. <a href="#">Keyboard point stick on page 120</a>	2. <a href="#">No boot to operating system (no read/write error) on page 130</a>	2. <a href="#">Noise (sound) on page 134</a>
3. <a href="#">No video (internal) on page 115<sup>d</sup></a>	3. <a href="#">Keyboard backlight on page 120</a>	3. <a href="#">Read-write error on page 131</a>	3. <a href="#">Fan runs constantly on page 135</a>
4. <a href="#">No video (external) on page 116<sup>d</sup></a>	4. <a href="#">TouchPad on page 121</a>	4. <a href="#">Slow performance on page 111<sup>c</sup></a>	4. <a href="#">HP Thermal Monitor on page 83</a>
5. <a href="#">DisplayPort/VGA on page 116</a>	5. <a href="#">Network Connectivity Ethernet (RJ-45 jack) on page 121</a>	5. <a href="#">Blue screen (BSOD) error on page 131<sup>b</sup></a>	5. <a href="#">Stuck power button on page 137</a>
6. <a href="#">HDMI on page 116</a>	6. <a href="#">Network connectivity wireless (WLAN) on page 122</a>	6. <a href="#">Noisy hard drive on page 132</a>	
7. <a href="#">No or bad external video via docking on page 117</a>	7. <a href="#">WWAN on page 123</a>		
8. <a href="#">Incorrect or missing color/distorted image on page 117</a>	8. <a href="#">USB on page 124</a>		
9. <a href="#">Touch screen on page 118</a>	9. <a href="#">Smart card reader on page 125</a>		
	10. <a href="#">Speaker, headphone - audio issues on page 126</a>		
	11. <a href="#">Thunderbolt (TB) on page 127</a>		
	12. <a href="#">Thunderbolt 3 dock on page 128</a>		

<sup>b,c,d</sup> similar symptoms

## 2. Examine the environment

It is important to examine the computer's environment. If you can quickly identify the cause of the issue, fewer resolution steps may be needed. Perform the following environment inspections:

- Check all cables and connections to be sure that there are no loose connections.
- Confirm that power sources are good, such as wall power type/adapter (110V/220V ac), power strip. Test with a verified working AC outlet.
- Check for compatibility issues between the computer and third-party devices, peripherals, noncertified devices, incompatible hardware (i.e., Mac OS device). Incompatibility can result in blue screen errors, improper operation, and so on.
- Isolate the computer from sources of electromagnetic interference (EMI), such as cell phones, 2-way radios, floor mats, fans (and other electronic motors). EMI may contribute to a display freeze issue or lock-up.



### 3. Perform a visual inspection of hardware

It is important to do a visual inspection of the hardware itself. Perform physical inspection of the computer:

- Look for abnormalities such as a cracked display, dented battery, broken latches for battery bay, keyboard key caps popped out, dust over connectors, liquid spill over keyboard, etc.
- Look for signs of drop, movement, or vibration that may cause internal and external loose connections.

### 4. Update BIOS and drivers



**IMPORTANT:** Whenever possible, update to the latest BIOS, firmware, and drivers before troubleshooting.

Note that some customer company policies prohibit updates. Check your company policy before taking action.

The updates may include fixes for your computer issues, and they may also enhance system performance. HP continually improves the update process to make it easier. The BIOS update can be done locally through a manual process, through an automatic installation, or through a remote installation on multiple units.

#### *Manually updating BIOS and drivers*

- See the Computer Setup chapters to manually update BIOS and drivers.
- Refer to specific BIOS update installation instructions that accompany the download.

#### *Remotely deploying BIOS and drivers*

Instead of manually searching for and downloading each SoftPaq, users and IT personnel can use two tools to identify and download all appropriate SoftPaqs for the selected HP models.

- HP SoftPaq Download Manager (SDM) is a software tool designed to streamline the download, extraction, and installation process of SoftPaqs, including BIOS and drivers.
- HP System Software Manager (SSM) is a software tool designed to simplify the deployment of SoftPaqs to HP computers.

## Analyze the issue

### 5. Remove or uninstall recently added hardware, software

HP has designed this computer and validated it using a full-range hardware and software qualification matrix. If an issue appears to have started recently, it may be related to the recent addition of hardware or software. A good method to determine the root cause is to remove recently added components or uninstall applications one at a time and restart the computer when necessary.



**IMPORTANT:** After you have completed the process of uninstalling hardware or software and are ready to reinstall, when installing a new device be sure that it is seated properly and all cables are correctly connected. After installing the device, restart the computer and make sure the new device is powered on. In addition, if the new device is a root cause of a problem, it could cause a conflict in drivers or incompatibility issues with other programs installed. For any new hardware you have added, be sure to install the latest drivers available from the device vendor website.

## 6. HP Hardware Diagnostics and Tools

HP offers different diagnostics and tools to diagnose hardware failure. This section describes how to use some of these tools. Make sure to check for the latest versions before use.

### HP PC Hardware Diagnostics (UEFI)

HP PC Hardware Diagnostics is a Unified Extensible Firmware Interface (UEFI) that allows you to run diagnostic tests to determine whether the computer hardware is functioning properly. The HP PC Hardware Diagnostics (UEFI) tool is built within BIOS (basic memory and hard drive diagnostics only), or within new hard drives themselves. These drives contain more advanced versions of the diagnostic tool than the BIOS-based version.

In addition, for HP authorized service partners and IT professionals who need to support a mixed environment of older and newer HP/Compaq PCs, the HP PC Diagnostics 3-in-1 USB Key at [http://www8.hp.com/us/en/campaigns/hpsupportassistant/pc-diags.html?jumpid=va\\_r602\\_us/en/any/pps/pl\\_ot\\_ob\\_ds\\_pd/HP\\_PC\\_Hardware\\_Diagnostics\\_cc/dt](http://www8.hp.com/us/en/campaigns/hpsupportassistant/pc-diags.html?jumpid=va_r602_us/en/any/pps/pl_ot_ob_ds_pd/HP_PC_Hardware_Diagnostics_cc/dt) is a diagnostic tool that supports a wide range of HP Desktop and Notebook computers.

The tool runs outside the operating system so that it can isolate hardware failures from issues that are caused by the operating system or other software components. In reality, many problems can be determined using this tool if the issue is a defective part or a loose connection (i.e., reseating keyboard cable after the tool reports a keyboard error).

The tool has three major functions:

- **System Tests** - Check the computer's hardware to assure everything is functioning properly. If your system won't boot into Windows, try the Quick System Test. For more comprehensive testing, use the Extensive System Test option. If the System Test did not detect a hardware problem, continue with the Component Tests.
- **Component Tests** – Focus on selected hardware components in your computer.
- **Firmware Management** – Update your computer's BIOS to the latest version (available separately) or roll back to a previous version.

To start HP PC Hardware Diagnostics (UEFI):

1. Turn on or restart the computer, quickly press the **esc** button on the computer, and then press **F2**. The BIOS searches three places for the diagnostic tools, in the following order:
  - a. Connected USB drive
  - b. Hard drive
  - c. BIOS

2. When the diagnostic tool opens, use the keyboard arrow keys to select the type of diagnostic test you want to run, and then follow the on-screen instructions.

Screen shot appearance may vary.

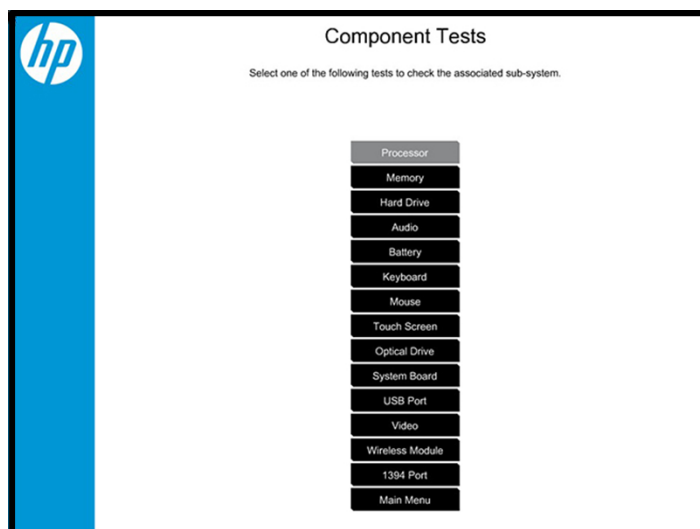
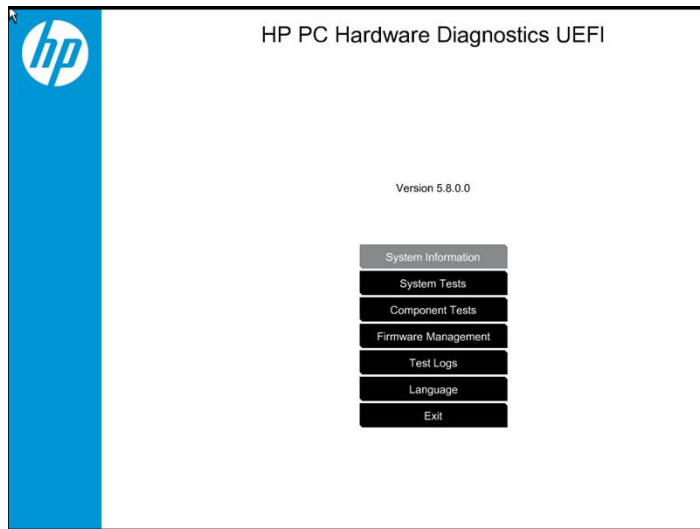

---

 **NOTE:** Users should utilize this tool, especially when the computer cannot boot to Windows.

 **NOTE:** If a component fails a test, write down the information so it is available when contacting support. The information is also available in **Test Logs** on the Main Menu.

---

For more information, see the chapter titled “Using HP PC Hardware Diagnostics (UEFI).”

## HP Support Assistant (HPSA)

HP Support Assistant (HPSA) helps you maintain peak performance and resolve problems through automatic updates, built-in diagnostics, and a variety of assistance options. HPSA is preinstalled on every new HP PC with Windows 7, Windows 8, or Windows 10. HP is continually improving this tool. Please verify the latest version is installed to receive the most benefit. For more information, see <http://www.hp.com/go/hpsupportassistant>.

 **NOTE:** HPSA can be used only if the computer boots into Windows. If the computer does not boot into Windows, use HP PC Hardware Diagnostics (UEFI) instead.

HPSA also integrates diagnostics and tools that help resolve issues. See example screen shots as follows.

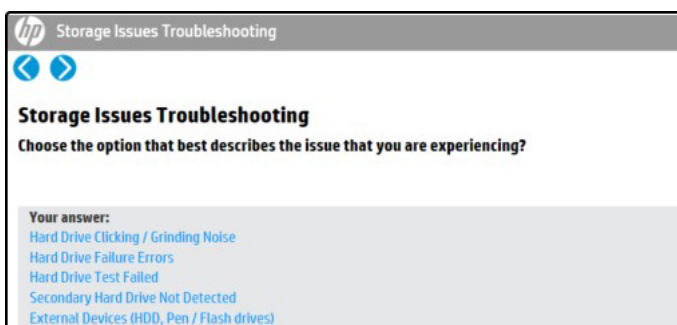
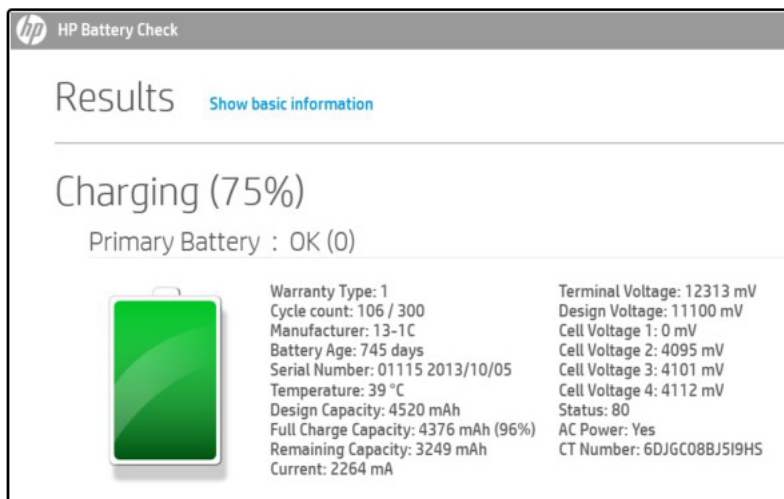
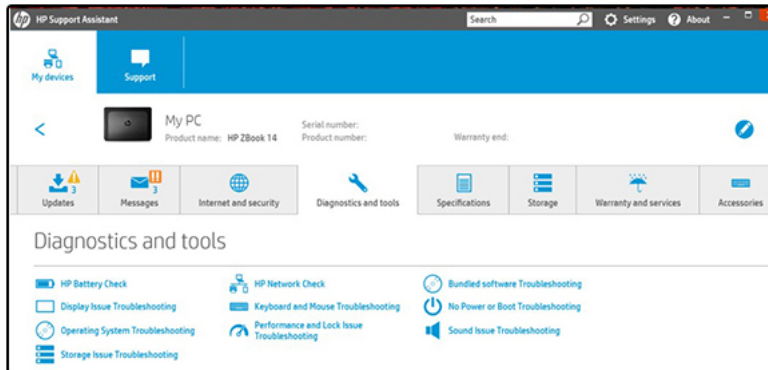

## HP BIOS Configuration Utility (BCU)

HP BCU is a free utility that captures the BIOS settings and their values. This tool provides a text file of the computer's BIOS configuration. This can help identify any settings that may be contributing to an issue.

In some cases, it may help to compare this BIOS text file to the default settings of the computer.

For more information, see the HP BIOS Configuration Utility (BCU) User guide at [http://ftp.hp.com/pub/caps-softpaq/cmit/whitepapers/BIOS\\_Configuration\\_UTILITY\\_User\\_Guide.pdf](http://ftp.hp.com/pub/caps-softpaq/cmit/whitepapers/BIOS_Configuration_UTILITY_User_Guide.pdf).



**NOTE:** HP recommends that you reset BIOS before trying BCU. Resetting the BIOS is always available and relatively quick to try, whereas BCU takes extra time and effort.

---

## HP Image Diagnostic Tool

Available to HP Authorized Support Partners (ASPs) and users from the HP public ftp site at <ftp://ftp.hp.com/pub/idr/ImageDiags/>, this tool collects information about the current state of the computer, including product serial number, platform and BIOS information, and information about user-installed software and hardware components. HP encourages you to review the report before sending it to support. The report may assist you with diagnostics and solutions to problems you encounter.

## HP Thermal Monitor



**NOTE:** Available only to authorized service providers/technicians.

---

Available only for HP internal use, HP Thermal Monitor can be used to stress the processor and GPU and monitor the temperature values of various components in the system. The components that are currently monitored include the processor, GPU, ACPI thermal zones, hard drive, and battery. The tool reads the temperatures of the components, logs the data, and helps to determine whether the computer would overheat in the event of thermal shutdown, fan spinning loud, etc.

## Non HP diagnostics tools

### *Windows-to-Go USB*

Windows-To-Go USB is a Microsoft-based tool for Enterprise editions of Windows that can help in troubleshooting. You can find a process online about how to create a live Windows USB drive. For more information, see <https://technet.microsoft.com/en-us/library/hh831833.aspx>.

### *Intel Processor Diagnostic Tool*

Determine what processor is in your computer and verify the processor operating frequency. The tool also tests specific processor features and performs a stress test on the processor. For more information, see [http://www.intel.com/support/processors/sb/CS-031726.htm?iid=subhdr+tools\\_procdiagtool](http://www.intel.com/support/processors/sb/CS-031726.htm?iid=subhdr+tools_procdiagtool).

## 7. Status lights, blinking light codes, troubleshooting lights, and POST error messages

Carefully observe any behavior the computer may be exhibiting: status lights, blinking lights, and POST error messages during boot. It is important to understand what these indicators mean.

### Status lights

See the chapter titled “External Component Identification” for light locations. The following table describes basic lights on the computer.

Component	Description
Power button	<p>When the computer is off, press the button to turn on the computer.</p> <p>When the computer is on, press the button briefly to initiate Sleep (Windows) or Suspend (Linux).</p> <p>When the computer is in the Sleep state, press the button briefly to exit Sleep (Windows) or Suspend (Linux).</p> <p>When the computer is in Hibernation, press the button briefly to exit Hibernation.</p> <p><b>CAUTION:</b> Pressing and holding down the power button results in the loss of unsaved information.</p> <p>If the computer has stopped responding and operating system shutdown procedures are ineffective, press and hold the power button.</p>
Front power light	<p>On: The computer is on.</p> <p>Blinking: The computer is in the Sleep state.</p> <p>Off: The computer is off.</p>
Battery light	<p>White: The computer is connected to external power and the battery is charged from 90 to 99 percent.</p> <p>Amber: The computer is connected to external power and the battery is charged from 0 to 90 percent.</p> <p>Blinking amber: A battery that is the only available power source has reached a low battery level. When the battery reaches a critical battery level, the battery light begins blinking rapidly. By default, the critical battery level is defined in Power Options as 5%.</p> <p>Off: The battery is fully charged.</p>
Front hard drive light	<p>Blinking white: The hard drive is being accessed.</p> <p>Amber: HP 3D DriveGuard has temporarily parked the hard drive.</p>
Rear AC adapter light	<p>White: The computer is connected to external power.</p> <p>Off: The computer is not connected to external power.</p>

## Interpreting system validation diagnostic front panel LEDs and audible codes

During the system validation phase that occurs at system startup, the BIOS validates the functionality of the following subsystems and conditions:

- AC adapter
- System board power
- Processor failure
- BIOS corruption
- Memory failure
- Graphics failure
- System board failure
- BIOS authentication failure

If an error is detected, specific patterns of long and short blinks, accompanied by long and short beeps (where applicable) are used to identify the error. These patterns will make up a two part code:

- Major – the category of the error
- Minor – the specific error within the category



**NOTE:** Single beep/blink codes are not used.

Number of long beeps/blinks	Error category
1	Not used
2	BIOS
3	Hardware
4	Thermal
5	System board

Patterns of blink/beep codes are determined by using the following parameters:

- 1 second pause occurs after the last major blink.
- 2 second pause occurs after the last minor blink.
- Beep error code sequences occur for the first 5 iterations of the pattern and then stop.
- Blink error code sequences continue until the computer is unplugged or the power button is pressed.



**NOTE:** Not all diagnostic lights and audible codes are available on all models.

The red LED blinks to represent the major error category (long blinks). The white LED blinks to represent the minor error category (short blinks). For example, '2.3' indicates 2 long red blinks and 3 short white blinks to communicate the processor is not detected. CAP/NUM Blink = 2 indicates CAP/NUM will blink 2 cycles, each cycle has one 2.3 sequence.

Component tested	Major/minor code	Error condition	Caps Lock/Num Lock LED	Action
BIOS	2.2	The main area (DXE) of BIOS has become corrupted and there is no recovery binary image available	CAP/NUM Blink = 2	Contact service for system board replacement.
	2.3	The embedded controller policy requires the user to enter a key sequence (SureStart 2.0)	CAP/NUM Blink = 8	Perform SureStart manual recovery if boot block: Up Arrow + Down Arrow + ESC.
	2.4	The embedded controller is recovering the boot block or DXE.	Battery LED White and Amber blinking	Wait for DXE recovery to complete.
Hardware	3.2	The embedded controller has timed out waiting for BIOS to return from memory initialization	CAP/NUM Blink = 3	Reseat the memory modules. If the issue persists, try replacing the memory modules. Possible RAM or system board failure.
	3.3	The embedded controller has timed out waiting for BIOS to return from graphics initialization	CAP/NUM Blink = 4	If the system has an MXM module, try a different MXM module. Otherwise, the board most likely needs to be replaced.
	3.4	The system board displays a power failure (crowbar)	CAP/NUM Blink = 5	Check power cable connections, or verify that any external power adapter has sufficient capacity for system.
System board	5.2	The embedded controller cannot find valid firmware	CAP/NUM Blink = 7 (2 BB failure) Battery LED Blinking = 1 Hz (3 B failure)	Contact service for system board replacement.
	5.3	The embedded controller has timed out waiting for the BIOS	CAP/NUM Blink = 1	Contact service for system board replacement.

### POST error messages

The Power-On Self-Test (POST) is a series of diagnostic tests that runs automatically when the computer is powered on. If the POST encounters a problem, visual error messages are displayed before the operating system starts. POST checks the following items to ensure that the computer system is functioning properly:

- Memory
- Processors
- BIOS
- Mass storage devices
- Fans

The following table describes key Post Error messages. For more detailed information, see [POST Error Messages and User Actions on page 140](#).



**Table 6-5 System diagnostics failure codes and user actions**

Test description	Failure description	Error code	Suggested user actions
Wireless Module not supported	The system has detected a wireless module installed in the system that is not supported and has been disabled.  WLAN Module ID (702)  WWAN Module ID (703)  Bluetooth Module ID (704)  GPS Module ID (705)	70x	Remove non-supported component.
Front Audio Not Connected	Front audio cable has been detached or unseated from the system motherboard.	100	Reseat the front audio cable on the system board.
Startup Test	Hard Disk 1 SMART	301	Attempt to reseat the hard drive and repeat the test. The hard drive may have failed.
Boot Device Manager	Boot device not found	3F0	Reset BIOS. Then reseat the hard drive and repeat the test.
BIOS Recovery	BIOS Recovery Occurred	500	This message indicates that BIOS recovery was completed successfully. No further action is required.
BIOS Application	BIOS Application Error	501	The BIOS installation may have become corrupted. Download the latest version of the BIOS and install it.  If reinstalling the BIOS fails, contact support for further assistance.
CMOS Recovery	CMOS Recovery Occurred	502	This message indicates that CMOS recovery was completed successfully. No further action is required.
Battery Check	Primary Battery Replace	601	This message indicates that the primary battery has very low capacity. See "Checking the Status of the Battery" <a href="http://h20566.www2.hp.com/hpsc/doc/public/display?docLocale=en_US&amp;docId=emr_na-c00821536">http://h20566.www2.hp.com/hpsc/doc/public/display?docLocale=en_US&amp;docId=emr_na-c00821536</a> for details on using the HP Support Assistant to verify the battery capacity and, if necessary, order a replacement.
Wireless Modules	Not installed or responding	701	Reseat the wireless LAN adapter module and antennas.  Because seating or reseating a wireless LAN adapter is unique to each computer model, see the WLAN module removal section in the removal and replacement chapter for further details.  Contact support if third-party wireless adapters are installed in the computer.
Keyboard Error	Keyboard has malfunctioned.	800	Replace the keyboard.
CPU Fan Not Detected	CPU fan is not connected or may have malfunctioned.	900	Check the fan connection. If properly connected, replace the fan.
Chassis Fan Not Detected	Chassis fan is not connected or may have malfunctioned.	901	Check the fan connection. If properly connected, replace the fan.
Chassis Fan Not Detected (Rear)			

**Table 6-5 System diagnostics failure codes and user actions (continued)**

Test description	Failure description	Error code	Suggested user actions
Chassis Fan Not Detected (Front)			
Fan	Fan not operating correctly	90B	The system fan may be malfunctioning. Replace the fan.
System Temperature	Thermal shutdown has occurred.	90D	The System BIOS has detected your machine was previously shut down to avoid overheating. Overheating may occur if the cooling vents are blocked or the operating temperature exceeds the system specifications. The machine should return to normal operation once the situation is resolved.
Fan Speed Failure	The system has detected that a cooling fan may not be working properly.	90F	<p>Try the following:</p> <ul style="list-style-type: none"> <li>• Press <b>Enter</b> to clear the message and boot to the Windows desktop.</li> <li>• Shut down Windows.</li> <li>• Clean the exterior of the vents to remove dust build-up while the computer is Off.</li> <li>• Check for a BIOS update.</li> </ul>

**Power Good (Troubleshooting) lights**

HP has added troubleshooting power lights to mobile workstations to help troubleshoot power-on issues. The lights indicate when the system board power rails are unstable and/or the system needs a hardware reset.

**Power good lights**

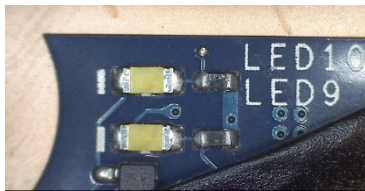

**Power good lights, HP ZBook 15 G4 model location**

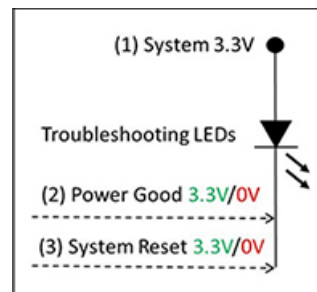
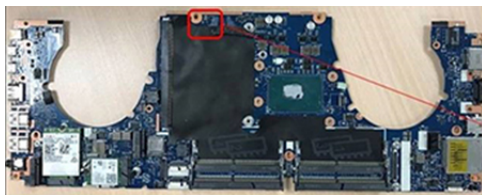

Troubleshooting lights diagram

These lights should be visible after removing the service door or bottom cover. Consult with support for platform-specific locations of the lights.

- Example: System board is good. Lights that turn on briefly (< 1 second) and immediately turn off indicate normal function. In this case, system (3.3V), power good (3.3V), and system reset (3.3V) are all good and

troubleshooting lights should not be lit. However, other external lights should be lit as normal afterward.

Troubleshooting lights	External lights	Action	Note
Off	On	Do not replace system board	No power-on issue
On	Off	Replace board	Power-on issue

- Example: System board needs replacement. When (1) system 3.3V exists, but one power rail is bad then (2) power good is low (0V), and troubleshooting lights will turn on.

After you press the system power button, troubleshooting lights will turn on for 5 seconds and turn off. The system external lights will not light up. Follow general troubleshooting steps (i.e., remove recently added hardware, test with minimum configuration, etc.) prior to replacing the system board.

## Resolve the issue

### 8. Hard reset

A hard reset or forced reset (<http://support.hp.com/us-en/document/c01684768>) erases all information in the computer's memory and may restore functionality. Resetting the computer forces the system to clear and reestablish the connections between the BIOS and the hardware.



**IMPORTANT:** Battery removal is NOT necessary for a hard reset on G3 or G4 mobile workstations. Follow the instructions for a computer with a non-removable battery.

Performing a hard reset might fix the following common conditions:

- Windows stops responding.
- Computer stops before Windows loads, indicated by incomplete boot-up, blinking cursor on a black background, and errors relating to operating system not found or a missing drive.
- Display suddenly goes blank and stays blank.
- Software freezes.
- Keyboard stops responding.
- The computer does not exit Sleep or Suspend state.
- An external device stops responding. Turn off the power to that device in addition to performing the steps in this document.

Before performing a hard reset, you must disconnect or remove all peripheral devices. You should start and test the computer by itself, and if the problem is not resolved, reconnect one peripheral device at a time. To resolve the startup or operational problem, run HP Support Assistant, or manually install all updated drivers from Microsoft and HP.

Before beginning, turn the computer over and look for a battery compartment door (service door). For 2015 platforms, the battery is considered removable but not accessible. See the battery section for how to remove/unplug the battery.

To perform a hard reset on a computer with a sealed or non removable battery, use the following steps:

1. Turn off the computer.
2. Remove the computer from any port replicator or docking station.

3. Disconnect all external connected peripheral devices such as USB storage devices, external displays, and printers.
4. Unplug the AC adapter from the computer.
5. Press and hold the power button for at least 15 seconds to drain residual power.
6. Plug the AC adapter back into the computer, but do not connect any of the peripheral devices.
7. Press the power button to turn on the computer.
8. If a startup menu appears, use the arrow keys to select **Start Windows Normally**, and then press the **Enter** key.
9. After reconnecting each of the peripheral devices, run Windows Update and HP Support Assistant to update all device drivers.

### Clear CMOS

CMOS refers to the battery-powered, semiconductor chip located on computer's system board. Notebooks store low-level settings like the system time and hardware settings in CMOS. Sometimes it is necessary to clear CMOS, which requires removing and reinserting the 3V RTC battery for a short period of time (a few minutes before reinserting), in addition to removing the AC adapter and battery.

---

 **NOTE:** Clearing the CMOS should only be performed for troubleshooting purposes. There is no reason to clear CMOS if the computer is working properly.

The notebook service door must be removed to access the CMOS battery. See the RTC battery replacement section for the battery removal/replacement.

---

## 9. Soft reset (Default Settings)

---

 **NOTE:** Some company policies prohibit updates or changes. Check whether the computer has custom BIOS settings before taking action.

---

If your computer is having issues booting, has errors during boot, is running into issues after adding hardware, or you are having other abnormal system behaviors that cannot be resolved through any other methods (i.e., hard reset), it may be necessary to reset the system BIOS to default settings.

To load BIOS to default settings: Reboot the computer, and then press **F10 > Main > Restore defaults**. For more information, see the BIOS F10 Setup technical white paper at <http://support.hp.com>, enter your computer model, and then go to **Manuals > White papers > HP PC BIOS F10 Setup Guide**.

## 10. Reseat cables and connections

---

 **NOTE:** Before disassembling the computer to reseat cables and connections, always disconnect power and remove the battery or disconnect a non removable battery.

---

Many problems are caused by improper connections or loose connections due to abnormal movement and vibration. See [Cable management on page 149](#) and [Connector types on page 150](#) for suggested cable management practices when removing and installing components.

You can access and reseat connections for Customer Self-Repair (CSR) parts (see the “Removal and replacement procedures for Customer Self-Repair parts” chapter for details). Examples of reseating hardware include:

- Reseating the battery into the battery bay can resolve no-battery found and no-charging issues.
- Reseating memory modules can resolve memory error, no-boot, and blue screen issues.

- Reseating the hard drive can resolve a POST error 3F0 (no boot device) issue (see [POST Error Messages and User Actions on page 140](#)).
- Reseating the keyboard cable can resolve an unrecognized keys error.
- Reseating the wireless module and antenna cable can resolve a wireless connection issue.

For field replaceable units (FRUs), authorized service providers can try the following steps (for more information, see the "Removal and replacement procedures for authorized service provider parts" chapter).

- Reseating the fan cable can fix POST error 90B (no fan detected) issue (see [POST Error Messages and User Actions on page 140](#)).
- Reseating the power cable can fix a no boot issue.
- Reseating the daughterboards (some models may have a power button board, VGA board, etc.) can resolve their functional issues.
- Reseating graphics cables and panel connectors can fix distorted/flickering video.
- Replacing thermal pads may resolve thermal power-down issue.

## 11. Test with minimum configuration

The factory-shipped computer (hardware configuration and preinstalled operating system image) is well tested and ready for use. Therefore, using the original factory hardware configuration and/or booting to operating system safe mode often resolves issues quickly.

- Disconnect any external USB storage, remove any discs in optical drives, remove the computer from a docking station, remove external video, etc.
- In addition to removing recently added components, the issue can be narrowed down further with a minimum configuration. For example, if HP PC Diagnostics reports a memory error, test one memory module at a time to isolate the defective module.
- If the computer does not successfully boot the operating system, booting to safe mode may help identify what may be causing the issue as described below.

### Essential hardware configuration



**NOTE:** This step is to be used by authorized service providers only. HP will not honor the warranty for a system tested with the system board removed without the heat sink, fan, etc.

If none of the steps above resolve the issue, start the computer with essential hardware only. The purpose is to remove as much as hardware as possible while still maintaining the computer's ability to turn on.

This essential configuration is often used to troubleshoot power-on related issues, such as no-boot, reboot, and freezing issues.

The essential hardware consists of the following:

- System board
- AC adapter (unplug nonremovable battery or remove battery)
- Processor (and heat sink/fan). (Processor may be integrated into the system board.)
- Memory (one verified working memory DIMM)
- Graphics card (if no VGA port is available on the system board). Platform may have both Intel integrated graphics and discrete graphics. Therefore, discrete graphics card may not be needed.
- External VGA monitor

- External USB keyboard
- External mouse

 **NOTE:** After the service door is removed, disconnect all connections (internal keyboard, display, discrete GPU, hard drive/solid-state drive, daughterboards, etc.) to achieve the essential hardware configuration above. DO NOT disassemble the system board from its enclosure at this time.

Reverse the procedure above by reinstalling each piece of hardware removed, one piece at a time, and testing your computer after each installation. Since your computer works with only the essential hardware installed, those parts must be working properly. This means that one of the hardware components removed is causing the computer to not work properly. By installing each device back into the computer and testing each time, the failing hardware will eventually be identified.

### Safe mode

A driver conflict often results in a blue screen error message. Therefore, booting in safe mode can resolve many issues in Windows because safe mode forces the computer to load a limited version of Windows which only contains essential files. Safe mode is useful for troubleshooting problems with programs and drivers that might not start correctly or that might prevent Windows from starting correctly.

If a problem does not reappear when you start in safe mode, eliminate the default settings and basic device drivers as possible causes. Refer to the links below for how to start your computer in safe mode:

- HP PCs – Windows 7 Safe Mode: <http://support.hp.com/us-en/document/c01835750>
- HP PCs – Windows Safe Mode (Windows 10, 8): <http://support.hp.com/us-en/document/c03439317>

## 12. Test with verified working configuration (hardware and/or operating system)

One troubleshooting technique that can quickly isolate an issue is using a verified working part while testing. A good example is to use an external keyboard, mouse, or VGA monitor when you have issues with an internal keyboard, TouchPad, or display. Testing with a verified working AC adapter can identify an error caused by a faulty one. Similarly, testing with a verified working operating system can determine bad behaviors of the current operating system. See [Non HP diagnostics tools on page 83](#) for instructions about obtaining and using a Windows-To-Go USB.

 **NOTE:** In some situations, more than one item may contribute to a problem.

## 13. Replace the system board

The system board may be replaced only by authorized service providers. This should not be considered an initial step taken to resolve an issue. Review and perform all steps discussed previously before replacing the system board. [4. Update BIOS and drivers on page 79](#), [7. Status lights, blinking light codes, troubleshooting lights, and POST error messages on page 84](#), [8. Hard reset on page 89](#), and [9. Soft reset \(Default Settings\) on page 90](#), and/or [10. Reseat cables and connections on page 90](#) can resolve many system board issues without requiring the effort of replacing unnecessary hardware.

Review [Table 6-1 Troubleshooting methodology and general troubleshooting steps on page 75](#) for appropriate troubleshooting steps.

 **IMPORTANT:** System board failure is not common. Do not replace the system board until you have tried all other troubleshooting options.

 **NOTE:** Determine whether a previous service case might be related to the current problem. For example, a fan detection issue may be caused by a loose connection resulting from previous service.

 **TIP:** Without an RTC battery (3V coin-cell battery), the computer automatically reboots. This is a useful feature when the power connector cable (between external AC adapter and system board) is defective.

 **NOTE:** Most of the time, effective troubleshooting can prevent a system board replacement.

Items that may prevent resolution of the issue:

- The information provided about the issue omits key details, including any actions taken before the issue occurred.
  - BIOS, software, and drivers have not been updated.
  - Cables or connections are loose.
  - Technician is unaware of information available from the HP Support website (i.e., CA - Customer Advisory).
  - The issue is related to existing or known issues that may be identified in existing support articles.
  - Technician may have omitted steps in the provided repair instructions (e.g., Spare Part Replacement Instructions).
  - Skipping one of steps from Troubleshooting Methodology table results in No Defect Found (NDF)/No Fault Found (NFF)/No Issue Detected (NID) messages.
- 

## Verify solution

- Verify that the implemented solution works. Reboot the system or device and try to complete the task that produced the issue.
- If a part has been replaced, verify other basic functions. For example, GPU replacement requires keyboard removal. Therefore, it is good practice to verify all basic components to be sure that the solution is complete.
- Explain to the customer why the issue occurred and what was done to resolve it. If the solution you used was in an HP Public document, provide the document information to the customer, letting them know it can be located on [www.hp.com](http://www.hp.com). Also, tell them that there are other solutions available on the website. Advise the customer to check the website first when they have an issue. It may save them time calling in.
- Document the correct issue. Update the case with as many details as possible for other agents and engineering to analyze and study for lessons learned.

## Helpful Hints

After you become familiar with the general troubleshooting steps above ([General troubleshooting steps on page 75](#)), follow the helpful hints below before running diagnostics and troubleshooting.

### At startup

 **TIP:** If you have installed an operating system other than the factory-installed operating system, go to <http://http://www.hp.com/go/quickspecs> and verify that it is supported on your system.

---

1. Be sure that the computer is plugged into a working AC outlet.
2. Be sure that power is connected to the docking station if a dock is used.
3. Be sure that the AC adapter light is on.
4. Be sure that the AC adapter is connected when you update BIOS to avoid BIOS corruption.
5. Be sure that the computer is turned on, the rear power light is solid white (connected to an external power source) and the front power light is solid white (normal operation).
6. Remove all optical and flash drives from your system before turning it on.

7. Be sure that the boot option is set to a working operating system drive.
8. Be sure that externally connected monitors are turned on and their power lights are on. Not all monitors are equipped with lights to indicate their functionality.
9. Turn up the brightness and contrast controls of a display or external display device if the screen is dim.

## During operation

1. To wake the computer:
  - a. Press the power button or any key on the keyboard.
  - b. If the system remains in the Sleep (Windows), Suspend (Linux), or Hibernate state, shut down the system by pressing and holding the power button for at least four seconds.
  - c. If the system does not shut down, unplug the power cord, wait a few seconds, and then plug it in again. Then press the power button again to restart the system. If it does not turn on, press the power button to start the computer.
2. Look for blinking lights on the computer. The blinking lights could be error codes that will help diagnose the problem.
3. Check all cables for loose or incorrect connections (external devices, power cords, dock, etc.).
4. After installing a non-Plug and Play expansion board or other option, reconfigure the computer. For example, if you upgrade to a solid-state drive, you may need to reconfigure the boot order.
5. Be sure that all required device drivers have been installed. For example, if you have connected a printer, you must install a printer driver.
6. If there is a network connection issue, plug another computer with a different cable into the network connection. There might be a problem with the network plug or cable.
7. If hardware has recently been installed, remove it and determine whether the computer functions properly.
8. If software has recently been installed, uninstall it and determine whether the computer functions properly.
9. If the screen is blank, confirm the display choice by pressing **Windows logo**  + **P** and set to screen only. Or plug an external monitor into a different video port on the computer if one is available and close the computer lid.
10. Verify that the latest version of BIOS, drivers, and software are installed. A new release might support new features or fix the problem.
11. Press the **caps lock** and/or **num lock** key. If the **caps lock** and/or **num lock** light toggles on or off, the keyboard is likely operating correctly.
12. Press the TouchPad On/Off button light. If the light toggles on or off, the TouchPad is likely operating correctly.

## Consulting with HP Service

If further HP support is required, a lot of the following information may be requested when you call, so it may be helpful to take notes.

- Technical support registration number (if applicable)
- Product serial number



- Product model name and number
- Product identification number
- Applicable error messages
- Add-on boards or hardware
- Third-party hardware or software
- Operating system type and revision level

## Common issues and possible solutions

This section contains common issues, symptoms, and a series of tables that describe possible solutions to issues from [Failure classification on page 76](#) tables. The following sections identify the issue with symptoms and solutions to resolve an issue.

### Power-on issues

#### No Power

When a unit experiences no power there are several contributing factors to consider. Be sure to consider all symptoms related to this behavior in troubleshooting.

<i>Symptoms</i>	<i>Possible causes</i>
<ul style="list-style-type: none"> <li>• Computer does not start</li> <li>• Display is black or blank</li> <li>• No fan noise</li> <li>• No hard drive spinning</li> <li>• Lights do not glow</li> </ul>	<ul style="list-style-type: none"> <li>Failed power input to the computer (external power source, AC adapter, faulty battery).</li> <li>Bad connection to the computer (bad power button, power connector).</li> <li>Defective parts (memory, hard drive, graphics) or failed system board.</li> </ul>
	<p><i>Troubleshooting steps</i></p> <p><b>Perform quick check</b></p> <p>Remove all external devices, including docking station.</p> <p>Verify external power source (<a href="#">2. Examine the environment on page 78</a>).</p> <p>Perform a hard reset (<a href="#">8. Hard reset on page 89</a>).</p>



#### **Verify AC adapter**

It is preferable to verify the battery before verifying the AC adapter. However, you can verify the AC adapter first, before opening the service door for a battery check.

- Verify AC adapter is compatible with product. Verify that the part number is for this computer if possible.
- Verify AC adapter and power cord are good (no physical damage, bent middle ID pin).
- Verify AC adapter works on a verified working computer.
- Plug in AC adapter and power on computer without battery.
- Inspect power port on computer side for any damage, dust, or debris.



- Check power light ([7. Status lights, blinking light codes, troubleshooting lights, and POST error messages on page 84](#)). Rear power light indicates external power to the computer is good.

**NOTE:** Refer to battery replacement section for removing/replacing the battery

#### Verify battery condition/status

1. Check battery condition (overall result, cycle life, voltage, etc.) using HP PC Hardware Diagnostics (UEFI) or HPSA tools.
2. Verify that battery is installed properly in battery bay without a gap and that latch locks are tight (for models with removable batteries).
3. Check battery status light ([7. Status lights, blinking light codes, troubleshooting lights, and POST error messages on page 84](#)). Be sure that battery is not fully discharged, preventing system from booting.
4. Determine whether the computer can turn on with battery only.
5. Remove service door and test with a verified working battery. If the computer boots, inspect original battery before replacement.
6. Test battery with a verified working computer to verify that it is OK.
7. If there is still no boot, remove battery and boot on AC power only.

**The sections below are intended for authorized service providers/technicians.**

#### Verify AC adapter – voltage

1. Measure DC voltage output that should be around 19.5 VDC and acceptable voltage range is from 18.5 – 20.5 VDC.
2. If the DC voltage is out of range, replace the AC adapter.

**NOTE:** This action requires a digital voltmeter.

**NOTE:** 2015 mWS does not have the power cable between system board and power connector on chassis



#### Verify power button, power connector

1. Be sure that power button is not stuck.
2. Reseat power connector cable (if applicable).
3. Replace new power connector cable (if the cable exists and is defective)
4. To isolate faulty power connector cable and power button, technicians can short power-on pads/pins to power up the computer. Contact HP Engineering for this information.

#### Verify blinking lights ([7. Status lights, blinking light codes, troubleshooting lights, and POST error messages on page 84](#))

At this point, there should be sufficient power from the AC adapter to the system board. Expect to hear the fan spinning and see blinking lights or error messages (i.e., faulty memory, HDD, etc)

#### Verify Power Good (Troubleshooting) lights

1. Verify if the system board has power-on issue related. If there is no power-on issue, move to next steps. For more information, see [Power Good \(Troubleshooting\) lights on page 88](#).
2. Verify all connections and reseat parts ([10. Reseat cables and connections on page 90](#)).

#### Verify system board

1. Test essential hardware configuration ([11. Test with minimum configuration on page 91](#), [12. Test with verified working configuration \(hardware and/or operating system\) on page 92](#), [13. Replace the system board on page 92](#)) by removing nonessential parts.
2. If there is still no boot, replace system board.

#### Tips and tricks

Computer automatically boots without pressing power button when RTC 3V battery has been removed. Therefore, after the service door and RTC 3V battery are removed, no need to press power button from top side.

In essential hardware configuration, mWS G1 and G2 may require discrete GPU to boot. However, mWS G3 can boot with integrated graphics.

See “Overview of How to Troubleshoot Problems When a Computer Does Not Start Up or Boot Properly” at [http://h20566.www2.hp.com/hpsc/doc/public/display?docLocale=en\\_US&docId=emr\\_na-c01443371](http://h20566.www2.hp.com/hpsc/doc/public/display?docLocale=en_US&docId=emr_na-c01443371)

## Intermittent power-on, shutdown, reboot

#### Symptoms

- Does not always turn on
- Intermittently hangs
- Intermittently shuts down
- Spontaneously reboots

#### Possible causes

Electrical short, fluctuating power source, unstable power rails, loose connections, bent pins, stray wires, dust, obvious damage, nearly faulty parts (bulging/leaking capacitor).

Potentially will turn into a no power issue soon ([No Power on page 95](#)).

#### Troubleshooting steps

1. Make sure drivers are updated.
2. Visually check power ports on both AC adapter and computer sides.
3. Inspect power sources:
  - a. Verify AC adapter working correctly. Use a confirmed working adapter to test.
  - b. Verify that battery is not depleted while system is in Sleep state. Test with a confirmed working battery.

#### The sections below are intended for authorized service providers/technicians.

1. Follow actions in [No Power on page 95](#).
  - a. Be sure that AC adapter has correct DC voltage.
  - b. Verify battery - test with a confirmed working battery.
  - c. Verify that power button is not stuck.
  - d. Verify that power connector is not loose.
  - e. Verify that Power Good LEDs are solid.
  - f. Remedy loose connections and reseat major components (processor, memory, GPU, hard drive/solid-state drive, etc).
2. Perform visual check for loose connections, bent pins, stray wires, dust, nearly faulty parts (bulging/leaking capacitor).

3. Test **essential hardware configuration** ([11. Test with minimum configuration on page 91](#))
  - a. If system boots, reinstall nonessential hardware one component at a time to isolate issue.
  - b. If system does not boot, replace essential hardware with verified working parts, one component at a time. If system still does not boot, replace system board.

## AC adapter issue

<b>Solution</b>	
<i>Symptoms</i>	<i>Possible causes</i>
<ul style="list-style-type: none"> <li>• No sign of power</li> <li>• No boot</li> <li>• No rear power light</li> <li>• No front power light</li> <li>• Battery does not charge when AC adapter is connected</li> </ul>	<p>AC adapter and others (i.e., external power source)</p> <hr/> <p><i>Troubleshooting steps</i></p> <p><b>Quick check</b></p> <ol style="list-style-type: none"> <li>1. Verify external power source (<a href="#">2. Examine the environment on page 78</a>).</li> <li>2. Remove all external devices, including docking station.</li> <li>3. Perform a hard reset for the computer (<a href="#">8. Hard reset on page 89</a>).</li> <li>4. Disconnect and reassemble the power cord and adapter in case the adapter experienced short circuit, over current, over temperature events.</li> <li>5. Use a verified working adapter. If the computer operates normally, there is a problem with the original adapter.</li> <li>6. Verify that the AC adapter works on a verified working computer. If the computer operates normally, there is no problem with the adapter. See <a href="#">HP Smart Adapter warning message on page 112</a> for further information.</li> </ol> <hr/> <p><b>Verify AC adapter</b></p> <ol style="list-style-type: none"> <li>1. Remove working battery.</li> <li>2. Verify that AC adapter is compatible with product. Verify that part number is for this computer if possible.</li> <li>3. Inspect AC adapter and power cord for physical damage, bent middle ID pin.</li> <li>4. Plug in AC adapter and power the computer without battery.</li> <li>5. Inspect the power port on computer side for any damage, dust, debris.</li> <li>6. Check power light (<a href="#">7. Status lights, blinking light codes, troubleshooting lights, and POST error messages on page 84</a>). Rear power light indicates that external power to the computer is good.</li> <li>7. If there is still no rear power light or no boot, replace the AC adapter.</li> </ol> <hr/> <p><b>Tips and tricks</b></p> <p>The HP Smart AC adapter has a special pin in the middle, called the ID pin, for power rating and throttling purpose. If this pin is broken, the rear power light will be on but the power button and front power lights will blink continuously and the computer will not turn on. Third party AC adapter will not work on the computer.</p> <p>Use the AC adapter that came with the computer for better performance.</p> <p>See “HP Notebook PCs - Testing and Using the AC Power Adapter” at <a href="http://h20564.www2.hp.com/hpsc/doc/public/display?docid=emr_na-c00363266">http://h20564.www2.hp.com/hpsc/doc/public/display?docid=emr_na-c00363266</a></p>

## Battery not recognized, not charging

---

<i>Symptoms</i>	<i>Possible causes</i>
<ul style="list-style-type: none"><li>• No battery status light</li><li>• Blinking amber (critically low battery level)</li><li>• No boot without AC adapter</li></ul>	<p>Defective AC adapter and/or battery.</p> <p><b>NOTE:</b> Before proceeding, verify that the computer can boot to BIOS or Windows with a good AC adapter.</p>
<hr/>	
<i>Troubleshooting steps</i>	
<b>Visual inspections</b>	
<ol style="list-style-type: none"><li>1. Inspect battery connectors for any signs of damage.</li><li>2. Verify that battery is installed properly in battery bay without gap or obstructions and latch locks are tight. Reseat battery (for models with removable batteries).</li><li>3. Determine whether battery gets hot (batteries heat up when charging, but not too hot to touch).</li></ol>	
<p><b>Check battery warranty</b> to see whether the battery is new or its warranty is expired. Battery capacity degrades over time.</p>	
<b>Verify front battery status light</b>	
<ol style="list-style-type: none"><li>1. Battery status light is off: battery not recognized.</li><li>2. Battery status light is blinking amber: critically low battery level.</li></ol>	
<b>Reset</b>	
<ol style="list-style-type: none"><li>1. Hard reset (<a href="#">8. Hard reset on page 89</a>)</li><li>2. Soft reset (<a href="#">9. Soft reset (Default Settings) on page 90</a>)</li></ol>	
<b>Verify AC adapter</b>	
<ol style="list-style-type: none"><li>1. Determine whether the computer needs the AC adapter to boot and operate. Sometimes, intermittently bad AC adapter and loose connection between adapter and computer results in inability to charge battery which causes short run time.</li><li>2. Inspect AC adapter to verify that it is functioning.</li><li>3. Test with a working AC adapter and confirm whether battery is charging.</li><li>4. Be sure that battery is fully charged (AC adapter plugged in at least 2.5 hours).</li></ol>	
<p><b>Diagnostics:</b> HP tools will report results such as passed, calibrate, weak, replace, no battery and unknown, and suggest corresponding actions.</p>	
<p><b>Use HP Hardware Diagnostics (UEFI)</b> (<a href="#">6. HP Hardware Diagnostics and Tools on page 80</a>)</p>	
<ul style="list-style-type: none"><li>• HP PC Hardware Diagnostics (UEFI) is a good tool to use to isolate and determine faulty battery, especially for quickly discharging (short life) battery.</li></ul>	
<p><b>Use HP Support Assistant tools in Windows</b> (<a href="#">HP Support Assistant (HPSA) on page 82</a>)</p>	
<ol style="list-style-type: none"><li>1. Verify that battery is recognized and charging.</li><li>2. Verify battery condition if battery cycle life is over specs (i.e., long life of 1000-cycle life and 3-year warranty). Battery may have premature capacity loss within its cycle life or warranty.</li><li>3. If issue remains, test with a verified working battery and verify battery status lights and battery conditions.</li><li>4. If issue remains, replace system board.</li></ol>	

- 
- 
5. Verify the new replacement.
- 

**Tips and tricks**

See the computer user guide for instructions regarding battery maintenance and increasing battery life.

- Reference “HP Notebook Mobile Workstations - Improving Battery Performance (Windows 10, 8, 7, Vista)”: [http://support.hp.com/us-en/document/c01297640?jumpid=hpr\\_r1002\\_usen\\_link3](http://support.hp.com/us-en/document/c01297640?jumpid=hpr_r1002_usen_link3)
  - Reference video “Testing and Calibrating the Battery on PC Notebooks”: <http://www8.hp.com/h22157/video-gallery/us/en/customer-care/2536294556001/testing-and-calibrating-the-battery-on-hp-notebook-pcs-in-windows-8/video/>
- 

## Battery discharges too fast

---

**Symptoms**

Battery has good status light but discharges too fast

**Possible causes**

AC adapter and/or battery.

**Troubleshooting steps****Verify AC adapter**

Determine whether the computer needs the AC adapter to boot and operate. Sometimes, intermittently bad AC adapter and loose connection between adapter and computer results in inability to charge battery and causes short run time.

1. Inspect AC adapter to verify that it is working.
  2. Test with AC adapter alone and with a verified working AC adapter.
- 

**Verify battery:** Battery capacity can degrade over time, so check the warranty coverage. Run a battery test to confirm if issue is hardware-related.

1. Review battery power plans in **Control Panel > Power Options** that may consume more energy and discharge battery faster. Resetting default to **Power Saver** option can conserve battery power.
  2. Determine whether any graphics processing is running.
  3. Verify battery maintenance and operations. Leaving the battery at a high level of charge in a high-temperature environment for extended periods accelerates the loss of capacity.
  4. Test and calibrate battery using HP PC Hardware Diagnostics (UEFI).
  5. Verify battery life cycle using HP Support Assistant tool.  
  
If battery cycle life is over specs (long life battery of 1000-cycle life and 3-year warranty), battery may have capacity loss beyond its lifecycle or warranty.
  6. Compare discharge time with a verified working battery (remove AC adapter) using **Hardware Diagnostics (UEFI) > Hard Drive Tests > Extensive Test > Loop until error**.
- 

**Tips and tricks**

To conserve battery power, turn off Wireless On-Off button and other peripherals/USB devices, applications, processes (in Task Manager) when not in use; also, reduce screen brightness.

Follow HP instructions of how to maintain battery and increase battery life.

---

---

Reference “HP Notebook Mobile Workstations - Improving Battery Performance (Windows 10, 8, 7, Vista)” at [http://support.hp.com/us-en/document/c01297640?jumpid=hpr\\_r1002\\_usen\\_link3](http://support.hp.com/us-en/document/c01297640?jumpid=hpr_r1002_usen_link3)

Reference video “Testing and Calibrating the Battery on PC Notebooks” at: <http://www8.hp.com/h22157/video-gallery/us/en/customer-care/2536294556001/testing-and-calibrating-the-battery-on-hp-notebook-pcs-in-windows-8/video/>

---

## Burnt smell

---

<i>Symptoms</i>	<i>Possible causes</i>
Emits smoke, burnt smell	Defective on-board components.
	<i>Troubleshooting steps</i>
	<b>General visual inspection</b>
	<ol style="list-style-type: none"><li>1. Disconnect the computer from power source (AC adapter and battery).</li><li>2. Inspect for visual damage on AC adapter and battery. Test on a known working computer to isolate issue. If issue follows AC adapter or battery, replace it.</li><li>3. Inspect any sign of liquid spill on the computer (back of keyboard).</li></ol>
<b>The sections below are intended for authorized service providers/technicians.</b>	
	<b>Further inspection on components</b>
	<ol style="list-style-type: none"><li>1. Inspect further sources internally after disassembling chassis, such as burnt or damaged components.</li><li>2. If the issue persists, replace boards, AC adapter, and battery for safety concern and report issues to HP.</li></ol>

---

## POST

### No video (with power)

---

<i>Symptoms</i>	<i>Possible causes</i>
<ul style="list-style-type: none"><li>• No video (black/blank image) but have power</li><li>• Light activity</li><li>• No error messages</li><li>• Fan noise</li><li>• Hard drive light blinking and hard drive noise</li></ul>	<p>Failed display</p> <p>Failed critical components (memory, hard drive, system board)</p> <p>Loose connection</p> <p>Recently added hardware</p> <p><b>NOTE:</b> Assume the computer has not previously been set up for multiple displays.</p>
	<i>Troubleshooting steps</i>
	<b>Quick check</b>
	<ol style="list-style-type: none"><li>1. Verify that system light activity is OK.</li></ol>

---

2. Remove all external devices, including docking station. Recently added hardware and/or applications may cause graphics driver conflict and result in loss of video.
3. Perform hardware reset ([8. Hard reset on page 89](#)) and verify that HP Logo is presented correctly on display screen when pressing **F10**.
4. Test with external monitor via VGA port (or DisplayPort, HDMI, etc). Press power button and close the computer lid to force video output to external video. If unsuccessful, contact HP service.
5. If external video is OK, update BIOS, software, and drivers ([4. Update BIOS and drivers on page 79](#)) and perform soft reset ([9. Soft reset \(Default Settings\) on page 90](#)) if needed. Go to next step to verify display.

#### Verify display

- When booting to Windows, determine whether image appears on display screen (via Windows Screen Solutions or [Windows logo](#)  + **P** for display switcher).
- If there is video on display, disconnect external display device, open the computer lid and restart.

#### The sections below are intended for authorized service providers/technicians.

1. Verify Power Good lights are on to be sure that system board power is functional.
2. Reseat display cable connection on system board.
3. Reseat display cable connection on display panel side.
4. Examine and reseat major components, such as hard drive, memory.
5. Test with minimum configuration ([11. Test with minimum configuration on page 91](#)) by removing hard drive to isolate operating system issues and testing video in F10 Setup.
6. If video is present, restart and retest the computer.
7. If video is present but bad, go to [Display on page 113](#) section.
8. If issue persists (no video), test with external video.
9. If issue persists, test or replace a confirmed working display.
10. If issue persists, replace discrete graphics card.
11. If issue persists, replace system board due to defective video function.

#### Tips and tricks

Swipe a metal piece (screwdriver) over wireless/mute buttons to act as if closing lid to force video output to external display device. See the “External component identification – Display” section for location of the magnetic sensor.

## Blinking lights

#### Symptoms

Lights blink on keyboard [caps lock/num lock](#) keys

#### Possible causes

Blinking lights on startup usually indicate a problem with basic functionality of a critical component (processor, BIOS, graphics cards, memory, etc.) due to loose connection, defective parts, or recently added parts.

#### Troubleshooting steps

1. Check for any blink patterns. Count the number of blinks in a sequence, followed by a pause for a few seconds.



2. See Status, Blinking Lights, and Error Message ([7. Status lights, blinking light codes, troubleshooting lights, and POST error messages on page 84](#)) for corrective actions.
3. If internal hardware components (memory, hard drive, etc.) have been recently added, a component may not be connected properly. Remove and reseat new components ([10. Reseat cables and connections on page 90](#)) one at a time.

**Note** Since the display may not be functional, lights are used to indicate an error.

## Diagnostics error messages

### Symptoms

- Computer has power
- POST error message displays (Windows logo has not yet appeared)

### Possible causes

Diagnostic error messages indicate a problem. There may be a problem with the instruction being sent from the BIOS to a hardware component (e.g., keyboard failures), or incompatible hardware. Can usually be resolved by installing updated firmware for the component.

### Troubleshooting steps

1. See [7. Status lights, blinking light codes, troubleshooting lights, and POST error messages on page 84](#) for corrective actions. An example of a POST error message is shown below.

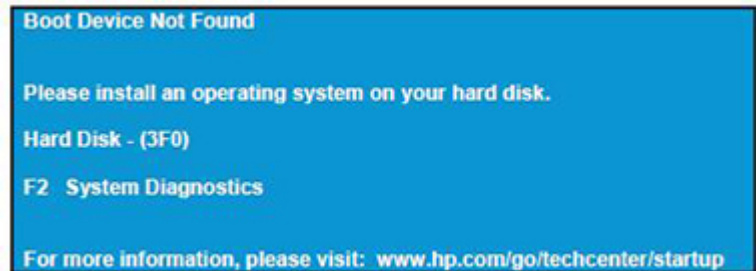

2. If there is power, you may be able to access BIOS. Reset BIOS to its default condition. ([9. Soft reset \(Default Settings\) on page 90](#))
3. Restore hardware to its original condition (i.e., bootable solid-state drive instead of hard drive).
4. Reseat suspected components and verify connection.
5. Test suspected components using HP PC Hardware Diagnostics (UEFI) tool.

**Note** An Error Message means the system has finished BIOS hardware validation and is ready to launch the **Startup Menu**. To access the **Startup Menu** for further options, press the **Esc** key while restarting the computer.

## BIOS password

---

### *Symptoms*

Some sections are unavailable (grayed out)

### *Possible causes*

BIOS administration password is required.

### *Troubleshooting steps*

1. Review F10 BIOS Setup Overview to determine which features must be enabled.
2. Your BIOS settings may be managed by a BIOS administrator password setup.
3. If you lost or forgot user password, contact your IT personnel.
4. If you lost or forgot administrator password, contact HP service to reset the password. This process requires a unique UUID.

### **Reference**

#### **HP F10 Setup Overview**

HP Business Notebook and Desktop PC F10 setup overview – 2012 and 2013 Business PC models: <http://h10032.www1.hp.com/ctg/Manual/c04460979>

HP Business Notebook and Desktop PC F10 setup overview – 2014 Business PC models: <http://h10032.www1.hp.com/ctg/Manual/c04685655>

2015 Business PC models – see the BIOS F10 Setup technical white paper at <http://support.hp.com>, enter your computer model, and then go to **Manuals > White papers > HP PC BIOS F10 Setup Guide**.

---

## Performance (OS)

---



**NOTE:** Most software problems occur as a result of the following:

- The application was not installed or configured correctly.
- There is insufficient memory available to run the application.
- There is a conflict between applications.

Make sure that all the needed device drivers are installed.

If an operating system other than the factory operating system is installed, check whether the operating system is supported and the application is certified for the version of the operating system.

HP ships and supports Windows 7 with BIOS Legacy boot mode and Windows 8, 10 with BIOS UEFI boot mode. Therefore, HP recommends that you switch BIOS boot mode from Legacy to UEFI Native for clean Windows 8, 10 installations, or to UEFI Hybrid (if available) for upgrading the option from Windows 7 to Windows 8, 10. UEFI Windows 8, 10 avoids many unexpected behaviors (i.e., blue screen error, graphics/video issues) in the BIOS Legacy setting.

---

## Intermittent shutdown

---

<i>Symptoms</i>	<i>Possible causes</i>
<ul style="list-style-type: none"><li>• Shutdown during startup</li><li>• Shutdown during operation</li></ul>	<p>It is often difficult to troubleshoot an intermittent issue. Possible causes include the following:</p> <p>Power-related issue: defective or insufficient power sources, poor connection.</p> <p>OS Custom Setting: Energy Saver (Power Management).</p> <p>Thermal-related issue: thermal sensors reach limits.</p> <p>Hardware related issue: voltage, out-of-range current; electrical short.</p>
	<p><i>Troubleshooting steps</i></p> <ol style="list-style-type: none"><li>1. Update BIOS and drivers. (<a href="#">4. Update BIOS and drivers on page 79</a>)</li></ol> <p><b>CAUTION:</b> Do not attempt to update BIOS if the computer is shutting down at startup, as running a BIOS update could corrupt the BIOS and require a system board replacement if the system powers down during the procedure. The computer should be stable enough to go through several start/restart cycles without issue before attempting a BIOS update.</p> <ol style="list-style-type: none"><li>2. Perform hard reset (<a href="#">8. Hard reset on page 89</a>)</li><li>3. Perform soft reset (<a href="#">9. Soft reset (Default Settings) on page 90</a>)</li></ol>
	<p><b>Power related issue</b></p> <ol style="list-style-type: none"><li>1. Verify functionality of AC adapter alone. If no functionality, test with a verified working adapter.</li><li>2. Verify battery alone. Verify that battery is not depleted. Test battery using HP PC Hardware Diagnostics (UEFI) tool.</li><li>3. Verify connection of power button, power cable.</li></ol>
	<p><b>OS custom settings</b></p> <ol style="list-style-type: none"><li>1. Advise users to reset power options and close all applications that are not in use, including applications in the background.</li><li>2. Test with a confirmed working operating system to isolate custom settings by users or any conflicting applications that cause shutdown.</li></ol>

---

**The sections below are intended for authorized service providers/technicians.**

---

### **Thermal-related issue**

1. Verify thermal condition:
  - a. Test fan using HP PC Hardware Diagnostics (UEFI) tool ([6. HP Hardware Diagnostics and Tools on page 80](#))
  - b. Check fan and connection. Reseat fan cable.
  - c. Be sure that no obstructions or dust are in heat sink fan, fin, or vent.
  - d. Test with a verified working fan.
  - e. Remove old thermal compound and pads and replace with new compound and pads.
2. Verify thermal solution:
  - Use Thermal Monitor tool (available only to authorized service providers/technicians) to perform stress test (processor and GPU) ([6. HP Hardware](#)

---

[Diagnostics and Tools on page 80](#)) and verify that thermal sensors are within limits after thermal condition is serviced.

---

**Hardware related issue**

1. Check for any signs of loose connections, bent pins, stray wires, dust, nearly faulty parts (bulging/leaking capacitor).
  2. Verify that lights are solid.
  3. If shutdown is reproducible, test essential hardware configuration:
    - a. If no issue with hardware configuration, reinstall one non essential component at a time to determine faulty hardware.
    - b. If issue persists, replace essential hardware with a confirmed working part, one at a time. If no boot, replace system board.
- 

**Tips and tricks**

Intermittent issue is difficult to reproduce and troubleshoot. It is important to record details on shutdown frequencies, system configuration (3D video application) and operating conditions.

---

## Blue screen

---

*Symptoms*

- Have power, light activity, fan spinning
- HP Logo displays briefly
- Fails to boot into Windows operating system, displays blue screen, and then crashes, restarts, or stops responding

*Possible causes*

- Recent changes: conflict of instructions from multiple programs or just added hardware.
  - Incompatible hardware and driver.
  - Poor connection (hard drive, memory).
  - Hardware malfunctioning due to overheating (GPU, processor).
  - Defective hardware (memory, hard drive).
- 

**Important Notes & Resources**

*Troubleshooting steps*

There are many different ways to troubleshoot a blue screen error. Therefore, you need to identify working configuration (Windows 7/8/10) and specific symptoms of the failure in order to narrow down the issue. Refer to [Blue screen \(BSOD\) error on page 131](#).

---



**Recommended resources**

Microsoft knowledge base:

Resolving Blue Screen errors in Windows: <http://windows.microsoft.com/en-us/windows-8/resolve-windows-blue-screen-errors>

HP Troubleshooting Error Messages on a blue screen:

HP Notebook PCs - Troubleshooting Error Messages on a Blue Screen that may Occur During Startup or Boot: [http://h20566.www2.hp.com/hpsc/doc/public/display?docLocale=en\\_US&docId=emr\\_na-c00372711](http://h20566.www2.hp.com/hpsc/doc/public/display?docLocale=en_US&docId=emr_na-c00372711)

---

## Overview of General Troubleshooting Steps for a blue screen error

1. Note the blue screen error message and what activity was performed at the time.
2. Perform a hard reset ([8. Hard reset on page 89](#)) after disconnecting all external peripherals.
3. Reset BIOS to default ([9. Soft reset \(Default Settings\) on page 90](#)) to prevent booting to another device.
4. Run HP Hardware Diagnostics ([6. HP Hardware Diagnostics and Tools on page 80](#)) to isolate major faulty hardware issues.
  - HP PC Hardware Diagnostics (UEFI) tool to test hard drive, memory and system.
  - Thermal Monitor (available only to authorized service providers/technicians) tool to monitor temperature limits of processor and GPU. See “HP Thermal Monitor” in [6. HP Hardware Diagnostics and Tools on page 80](#).
5. Remove or undo recently added hardware ([5. Remove or uninstall recently added hardware, software on page 79](#)). For example, incompatible memory or new solid-state drive storage.
6. Reseat cables and connections ([10. Reseat cables and connections on page 90](#)). Pay attention to proper installation of memory and hard drive.
7. Verify that a minimum of at least 100 MB of free space is available on your Windows partition.
8. If you can start Windows:
  - a. Update BIOS and drivers ([4. Update BIOS and drivers on page 79](#)) to support updates for incompatibilities.
  - b. Get all the latest updates, using Windows Update.
  - c. Undo recent changes:
    - Startup using Last Known Good Configuration.
    - Use System Restore.
    - Roll back device driver in Device Manager.
  - d. Check for specific Error Message. See [Common Blue Screen Error Messages on page 142](#).
  - e. Boot to safe mode ([11. Test with minimum configuration on page 91](#)) to troubleshoot issues.
9. If you cannot start Windows:
  - a. Boot to safe mode. ([11. Test with minimum configuration on page 91](#))
  - b. Use Startup Repair to fix Windows startup files.
  - c. Undo recent changes using System Restore to revert to a previous “working” state.
  - d. Check for specific STOP error by analyzing Crash Dump (retrieved via a bootable USB). See [Use Windows Debugging Tool on page 143](#).
  - e. Restore computer using System Recovery or image backup to factory settings.
10. Lastly, test with essential hardware configuration ([11. Test with minimum configuration on page 91](#)) along with a verified working operating system (i.e., USB Windows-To-Go), if available, to isolate the software issue.

### Tips & tricks

In some cases, the computer may reboot automatically before you have time to read the blue screen.

To identify the error message itself, disable the automatic restart using one of the following methods:

Right-click on **My Computer**, and then select **Properties** > **Advanced**. Under **Startup and Recovery**, select **Settings**. Clear the **Automatically Restart** check box.

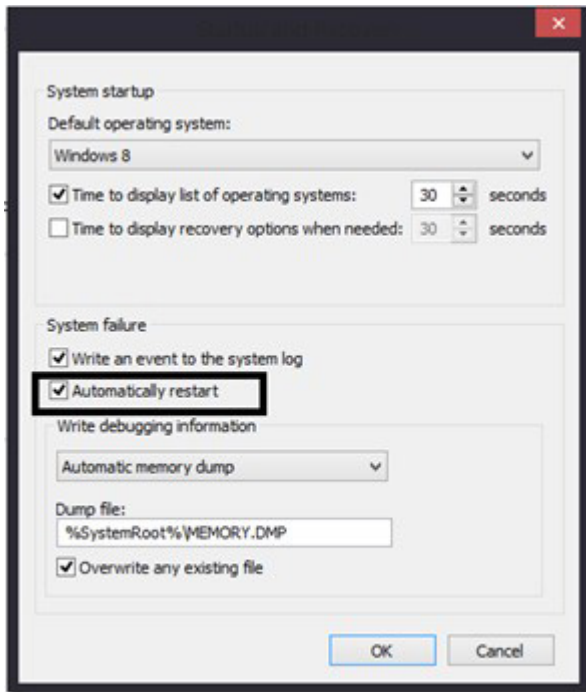

### Windows Advanced Boot Option

Windows 7:

1. Press **F8** to open the Windows Advanced Boot Option screen.
2. Select **Disable automatic restart on system failure** to view error messages.

Windows 8:

1. Press **F11** (System Recovery) to open the Windows Advanced Boot Option screen.
2. Select **Startup Settings** to view error messages.

## Freeze at Windows Logo (hang/lockup)

---

### Symptoms

- Has power, light activity, fan spinning
- HP Logo displays briefly
- Attempt to boot to operating system and freeze/hang at Windows logo
- No response to pressing [num lock](#) or [caps lock](#) key

### Possible causes

Conflict of instructions from multiple programs or drivers; installing a new hardware or program that is not compatible (may also cause a blue screen error—see blue screen issue).



#### *Troubleshooting steps*

Follow suggested steps below one at a time to verify normal boot process:

1. Disconnect all external peripherals, and perform a hard reset ([8. Hard reset on page 89](#)).
2. Perform soft reset ([9. Soft reset \(Default Settings\) on page 90](#)).
3. Update BIOS and drivers ([4. Update BIOS and drivers on page 79](#)).
  - a. Roll back to previous version may be necessary.
  - b. Go to safe mode to install drivers.
4. Run Hardware Diagnostics ([6. HP Hardware Diagnostics and Tools on page 80](#)) to isolate hardware issue.
5. Undo recent changes in Windows ([5. Remove or uninstall recently added hardware, software on page 79](#)).
6. Reseat cables and connections ([10. Reseat cables and connections on page 90](#)).
7. Start Windows in safe mode ([11. Test with minimum configuration on page 91](#)).
8. Use Startup Repair Windows to fix Windows damaged files.
9. Test with essential hardware configuration ([11. Test with minimum configuration on page 91](#)) along with a verified working operating system (i.e., USB Windows-To-Go ) if available to isolate the software issue.

#### **Tips and tricks**

For more information, see “HP PCs - Using Task Manager (Windows 10, 8)” at <http://support.hp.com/us-en/document/c03671001>.

## **Electromagnetic Interference (EMI)**

#### *Symptoms*

System locks up, freezes in certain physical area or location

#### *Possible causes*

Electromagnetic interference (EMI).

#### *Troubleshooting steps*

1. See ([2. Examine the environment on page 78](#)). Pay attention to external power source, high-frequency signals such as cell phones, microwave ovens.
2. Move the computer to different locations nearby to determine where it fails and where it does not fail.
3. Test with a verified working computer in original factory configuration.
4. Consult with support.

## No wake up

### Symptoms

When resuming from a power management state the computer may display:

- Blank screen
- Some light activity

### Possible causes

Power-saving mode; multiple-display setting.

### Troubleshooting steps

1. Verify that front power light ([7. Status lights, blinking light codes, troubleshooting lights, and POST error messages on page 84](#)) is blinking (indicating Sleep state). Press power button to exit Sleep.
2. Reset BIOS to default (associated with **OS Power Management** in **Power Menu**) ([4. Update BIOS and drivers on page 79](#))
3. Verify power management settings in Windows **Power Options**. Disable Sleep options if the issue is resolved.

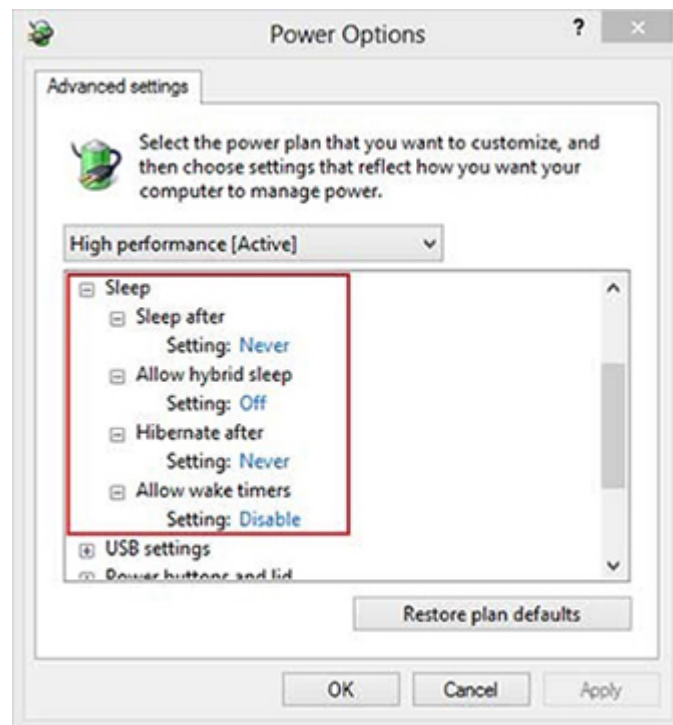

4. Screen saver is set. Press any key or touch TouchPad to resume.
5. Verify that Display Choice is set to external video only. Toggle screen control key combination **Fn + F4** or **Windows logo**  **+P**.

### Tips and tricks

If you are using a docking station, set your notebook display as a primary display. When the computer is not docked, you may think it is in a power-saving state, but the screen image may actually display on an external display device in the docking configuration.

The order in which the computer shows video is as follows:

1. Auto: (default). When set to Auto, hybrid graphics is disabled for certain Linux operating systems.
2. Hybrid graphics: Both integrated and discrete graphics are used.
3. Discrete graphics: Only discrete graphics is used.



## Unresponsive

---

<i>Symptom</i>	<i>Possible causes</i>
Unresponsive	Program in use has stopped responding to commands.
	<i>Troubleshooting steps</i>
	<ol style="list-style-type: none"><li>1. If possible, use the Windows Task Manager to isolate and terminate the offending process.</li><li>2. Attempt the normal Windows shutdown procedure.</li><li>3. Restart the computer using the power button.</li></ol>

---

## Slow performance

---

<i>Symptom</i>	<i>Possible causes</i>
Slow performance when performing small tasks, or even in idle mode	Processor is hot or hard drive is full.
	<i>Troubleshooting steps</i>
	<b>Processor is hot</b>
	<ol style="list-style-type: none"><li>1. Verify that airflow to the computer is not blocked.</li><li>2. Verify that chassis fans are connected and working properly. Some fans operate only when needed.</li><li>3. Verify that the processor heat sink is installed properly.</li></ol>
	<b>Hard drive is full</b>
	<ol style="list-style-type: none"><li>1. Transfer data from the hard drive to create more space on the hard drive. Microsoft recommends at least 200 MB to sync system files.</li><li>2. Perform disk defragmentation to consolidate fragmented data on the hard drive so it will work more efficiently.</li></ol>
	Also see <a href="#">Slow performance on page 131</a> .
<b>Tips and tricks</b>	See “Improving System Performance” at <a href="http://h20564.www2.hp.com/hpsc/doc/public/display?docLocale=en_US&amp;docId=emr_na-c00816938">http://h20564.www2.hp.com/hpsc/doc/public/display?docLocale=en_US&amp;docId=emr_na-c00816938</a> (see <a href="#">Routine Maintenance for Performance Improvement on page 141</a> ).
	See “Tips to free up drive space on your PC” at <a href="http://windows.microsoft.com/en-us/windows-8/free-up-disk-space">http://windows.microsoft.com/en-us/windows-8/free-up-disk-space</a> .
	See “Optimize Windows for better performance” at <a href="http://windows.microsoft.com/en-us/windows/optimize-windows-better-performance#optimize-windows-better-performance=windows-vista">http://windows.microsoft.com/en-us/windows/optimize-windows-better-performance#optimize-windows-better-performance=windows-vista</a> .

---

## HP Smart Adapter warning message

---

### Symptom

Warning message displayed in Window

### Possible causes

Less powerful AC adapter, BIOS out of date.



### Troubleshooting steps

1. Update BIOS that may contain a table that assigns an appropriate adapter for a certain configuration.
2. Update the latest **HP Hotkey Support** software from Drivers website.
3. Verify sufficient power source (where adapter is connected).
4. Use appropriate AC adapter (often supplied with system) for optimum system performance.
5. Test with a verified working AC adapter.
6. Test the adapter on a verified working computer.
7. Contact HP for configuration details.

### Note

**HP Smart AC adapter warning message:** informs you that as power demands increase, the notebook may not perform at full capacity, which may result in longer battery-charging time. In cases of extreme power demands, the system may also throttle back the processor, or with systems that have a discrete video sub-system, a video balance mode may occur to further balance the power needs of the system.

System processor functions always have priority over battery charging, so charging delays will occur first.

## Incorrect time and date

---

### Symptom

Incorrect date and time

### Possible cause

Real-time clock (RTC) battery might need replacement.

### Troubleshooting steps

1. Reset the date and time in the operating system Control Panel.
2. Replace the RTC battery.
3. Verify that date and time are correct.

# Display

## Display anomalies

The display panel is a field replaceable unit (FRU) and must be replaced by only authorized technicians. However, HP highly recommends that users and technicians observe specific symptom vs. generic symptoms and utilize the HP PC Hardware Diagnostics (UEFI) tool before any replacement.

### Symptom

Common display issues with symptoms:

- Blank/black video
- Incorrect/missing color/distorted image
- Flickering image
- Vertical lines (due to LDVS, decreased signal integrity, and data loss)
- Dead pixel (due to display liquid, internal transistor, etc.)
- Horizontal lines (due to video memory)
- Distorted when hot (due to thermal issue)
- Cracked screen/image (physical damage)
- Light leakage/bleeding

Contact support for assistance.

- Humming noise (due to frequency settings)

Contact support for assistance.

---

### Screen examples

---



Cracked screen

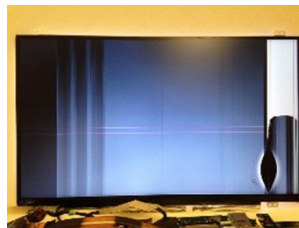

Cracked image

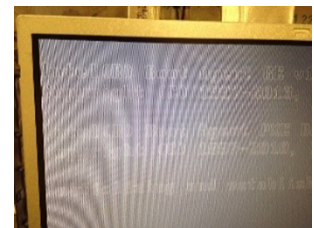

Blurred image

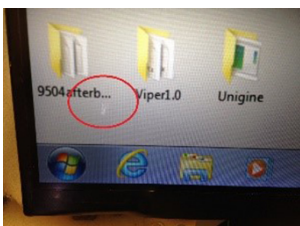

Dead pixel

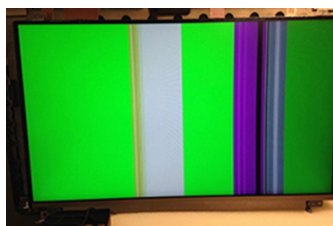

Vertical lines

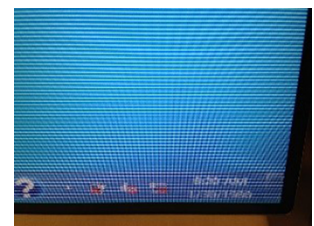

Horizontal lines

---

## Quick check

- Visually examine the display for cracked screen, liquid crystal leak, dirty spots on glass, etc.
- Reset and update BIOS and docking firmware.
- Update operating system (OS), graphics/video drivers (Intel/AMD/NVidia, etc).

For custom images, HP highly recommends upgrading or installing Windows in UEFI mode (or Legacy disabled) to fully support hybrid graphics and avoid unexpected behaviors (i.e., blue screen error, graphics/video issues) in the BIOS Legacy setting.

- Configure Windows settings (Power options, Screen brightness, Personalization, Screen resolution, etc.).
- Test with a verified working external display.
- Boot to Windows in safe mode.
- Test with a verified working operating system (i.e., shipping image).

## HP PC Hardware Diagnostics (UEFI) for video test

Use this tool to quickly determine if the display issue is related to a real hardware issue.

To start HP PC Hardware Diagnostics (UEFI) ([6. HP Hardware Diagnostics and Tools on page 80](#)), when the computer is at boot, press the **F2** key, select **Component Tests**, and then select **Video**.

There are three options:

- **Video Memory Check:** to test video memory
- **Palette Check:** to test the three video color components (red, green, blue)
- **Dead Pixel Check:** to check dead pixels in eight different colors (Dead Pixel Check is available with the “HP PC Diagnostics 3-in-1 USB Key” tool)

Review the video troubleshooting in the Display section below for specific issues and possible solutions. For additional information about display problems, refer to documentation provided by the product manufacturer.

## Display assembly diagram

The display assembly diagram shows basic video components: system board, graphics cards, display cables, display connectors, operating system (OS), graphics driver, and LCD display panel. Any component or a combination of these components can contribute to a video issue.

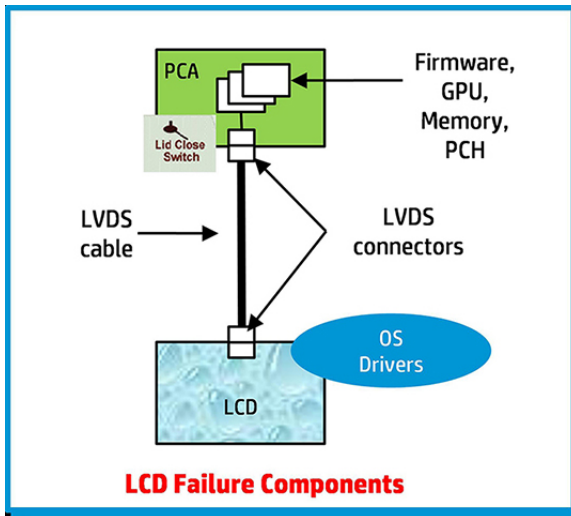

**NOTE:** The lid close switch is a Hall-effect sensor located in the top cover. When the display is closed, the sensor acts like a switch is closed. A notebook can force a video output to an external monitor, or go to hibernation or standby mode through power management. If the display screen does not light up when the display is open, the lid close switch (Hall-effect sensor) could be faulty.

## Dead pixel

Display panel may show one or more pixels that are not properly lit when displaying a single color over the screen area. Use HP PC Hardware Diagnostics (UEFI) tool to determine those defective pixels. There is no solution for dead pixels. Refer to [Display Issue: Pixel Anomalies on page 148](#) for the HP dead pixel policy.

## No video (internal)

<i>Symptoms</i>	<i>Possible causes</i>
No internal video with certain programs (i.e., video-intensive games)	Display resolution, brightness, faulty lid switch, running a program requiring a higher resolution than the display screen can support..  Faulty lid switch may put the system into Sleep or Hibernation mode.
	<i>Troubleshooting steps</i>  Use an external monitor with higher resolution.  Test with external monitor using HDMI or HP port. Press the power button and close the computer lid to force video output to external video. If there is still no video, contact support.
<b>References</b>	See section <a href="#">No video (with power) on page 101</a> for display information.

## No video (external)

---

<i>Symptom</i>	<i>Possible causes</i>
No image on external monitor	External monitor, resolution, display configuration, drivers.
	<i>Troubleshooting steps</i>
	<ol style="list-style-type: none"><li>1. Be sure external monitor is compatible with the computer.</li><li>2. Be sure that external monitor is turned on.</li><li>3. Press any key to get out power saving mode.</li><li>4. Adjust the brightness of the monitor.</li><li>5. Test with a verified working monitor.</li><li>6. Test the monitor via internal ports (VGA, DP ports).</li><li>7. Install latest video driver.</li><li>8. Reset the screen resolution as described in the documentation.</li><li>9. Configure display choice, and then force output to external video by closing the notebook lid or pressing <b>Fn + F4</b> to switch screen output.</li></ol>

---

## DisplayPort/VGA

See [No video \(external\) on page 116](#).

## HDMI

---

<i>Symptoms</i>	<i>Possible causes</i>
<ul style="list-style-type: none"><li>• Display issue</li><li>• Sound issue</li></ul>	Cable, connection, settings.
	<i>Troubleshooting steps</i>
	<b>Quick Check</b>
	<ol style="list-style-type: none"><li>1. Verify HDMI device input source is set correctly (i.e., HDMI1).</li><li>2. Be sure you are using the correct HDMI cable.</li><li>3. Check connection and reconnect the HDMI cable.</li><li>4. Verify if sound output is configured correctly in <b>Control Panel &gt; Sound Manager</b>.</li></ol>
	<ol style="list-style-type: none"><li>1. Perform hard reset (<a href="#">4. Update BIOS and drivers on page 79</a>).</li><li>2. Update BIOS and drivers (<a href="#">4. Update BIOS and drivers on page 79</a>) when sound is heard but no video on HDTV.</li></ol>
<b>References</b>	HP Notebook PCs - Troubleshooting HDMI Display and Sound Issues: <a href="http://support.hp.com/us-en/document/c01186408">http://support.hp.com/us-en/document/c01186408</a>

---

## No or bad external video via docking

---

<i>Symptoms</i>	<i>Possible causes</i>
No or bad image on external monitor via ports of docking station (VGA, DP, TB, display port, etc.)	Rooted from system board, software/drivers, dock connectors, docking station hardware/firmware, dock video ports (DP, VGA, etc).
	<i>Troubleshooting steps</i>
	<ol style="list-style-type: none"><li>1. Refer to the Thunderbolt Dock troubleshooting guide at <a href="http://h20565.www2.hp.com/hpsc/doc/public/display?sp4ts.oid=9822172&amp;docLocale=en_US&amp;docId=emr_na-c05060909">http://h20565.www2.hp.com/hpsc/doc/public/display?sp4ts.oid=9822172&amp;docLocale=en_US&amp;docId=emr_na-c05060909</a>.</li><li>2. Be sure that external monitor is powered on.</li><li>3. Be sure that external monitor is compatible with the computer.</li><li>4. If applicable, plug the dock in different Type-C ports.  For more information, see the technical white paper titled "HP ZBook 65/150/200 W Thunderbolt 3 Dock User Guide." Go to <a href="http://support.hp.com/">http://support.hp.com/</a>, enter your model number, and then click <b>Manuals &gt; Technical white papers</b>.</li><li>5. If the screen image is distorted, try a DP-to-VGA adapter. Connect the adapter to each DisplayPort and VGA port of the dock.</li><li>6. Test the monitor via internal ports (VGA, DP, HDMI, etc.).</li><li>7. Verify that dock connectors of the notebook and the dock are clean, without dust, debris (e.g., using air duster).</li><li>8. Ideally, use a verified working operating system/system connected to the dock to isolate the issue of the current operating system.</li><li>9. Ideally, use a verified working docking station to isolate the faulty dock.</li><li>10. Update latest dock firmware. Be sure to follow the installation instructions carefully. You may want to try a DP-to-VGA adapter if you have a distorted screen image. Connect the adapter to each DisplayPort of the dock. If you still cannot update the dock, attempt to update it on a confirmed working notebook before having the dock replaced.</li></ol>
<b>Note</b>	See the technical white paper titled "Multiple displays on HP ZBook Mobile Workstations" from HP platform support website. Go to <a href="http://support.hp.com/">http://support.hp.com/</a> , enter your model number, and then click <b>Manuals &gt; Technical white papers</b> .

---

## Incorrect or missing color/distorted image

---

<i>Symptoms</i>	<i>Possible causes</i>
System works normally but the display shows:	Loose connection, display cable, display, graphics card.
<ul style="list-style-type: none"><li>• Missing or strange color</li><li>• Image distortion</li></ul>	<i>Troubleshooting steps</i>
	<b>Verify with external monitor (i.e., VGA)</b>
	<ol style="list-style-type: none"><li>1. Use combination <b>Fn + F4</b> to enable output to external monitor.</li><li>2. Close the lid.</li></ol>

---

If the external monitor also shows incorrect color, it is graphics card issue. Test with a verified working graphics card.

---

**Verify display cable and cable connection**—Display disassembly is required.

Be sure that external display cables are not pinched or damaged.

Be sure that external display cables have good connection at both ends (system board and display panel).

- If moving cables affects the image, it is display cable. Test with a confirmed working cable.
  - If moving cables does not affect the image, is display issue. Test with a confirmed working display
- 

## Touch screen

---

### Symptoms

Unresponsive

Inaccurate

### Possible causes

Dirt and smudge, driver, touch display configuration, power management.

### Troubleshooting steps

#### Quick check

Turn off the computer, spray glass cleaner onto a soft, damp cloth, and gently wipe the screen to remove dirt and smudge.

**NOTE:** Do not spray cleaner directly onto the screen.

---

Configure the touch display in **Control Panel > Tablet PC Settings**

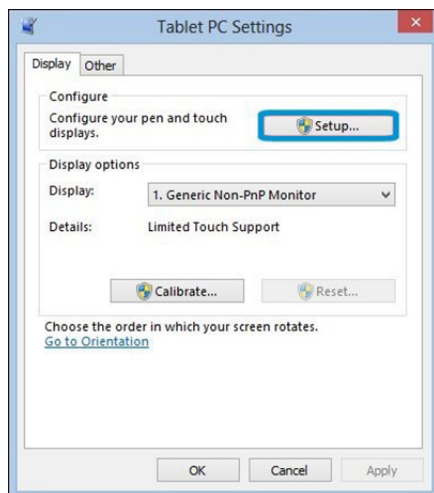

1. Restart the computer.
2. Verify touch screen and graphics drivers.
3. Configure the touch display to identify the screen as a touch screen as shown in the image at left.
4. Calibrate the screen and reset if touch functionality is still not working correctly.
5. Perform diagnostic test in HP Hardware Diagnostics under **Component Tests > Touch Screen**.

If the diagnostics tests pass but the touch screen still does not respond, continue following the steps.

6. Adjust the power management settings for your touch screen.

If the touch screen stops working after waking from sleep, adjust the power management settings so that the touch screen device stays active while the computer is in sleep mode.

7. Perform Microsoft System Restore and restore to a time when the system was working.
  8. Perform HP System Recovery if none of the above actions resolves the issue.
- 

### References

HP Notebook PCs - Touch Screen Issues (Windows 10): <http://support.hp.com/us-en/document/c04789449>

HP Notebook PCs - Touch Screen Issues (Windows 8): <http://support.hp.com/us-en/document/c04676089>

---



## I/O devices



### NOTE:

- Make sure external devices are supported and compliant (i.e., USB Type C, Thunderbolt 3, PCI Express, etc).
- If you have problems with external devices not provided by HP, contact device manufacturers for compatibility and latest drivers prior to troubleshooting (i.e., USB devices, Thunderbolt devices, PCI Express Card reader, VGA/Display/HDMI monitors, Speakers, etc).
- Be sure I/O devices are properly inserted into the I/O ports, and then be sure the I/O devices are recognized by Windows Device Manager.

## Keyboard

<i>Symptoms</i>	<i>Possible causes</i>
Keystrokes not recognized	Dust trapped under keycap, loose keycap, loose keyboard connection, defective keyboard.
Characters not matched	
	<i>Troubleshooting steps</i>
	<ol style="list-style-type: none"><li>1. Inspect the keyboard for any signs of dust, liquid, or debris trapped under sticky keys that might prevent keystroke recognition.</li><li>2. Check for incomplete connection between keyboard and system board by verifying that <a href="#">caps lock</a> or <a href="#">num lock</a> light turns on when key is pressed.</li><li>3. Verify whether the keyboard is recognized in Windows Device Manager and verify whether the keyboard driver is installed properly.</li><li>4. Test with a working external keyboard (i.e., USB keyboard). Also test in Windows for special keys (<a href="#">Caps Lock</a>, <a href="#">Shift</a>, <a href="#">Ctrl</a>, <a href="#">Fn</a>, <a href="#">Windows</a>, <a href="#">Alt</a>) if necessary.</li><li>5. Test with HP PC Hardware Diagnostics (UEFI) to isolate a hardware issue from a software issue.</li><li>6. Verify that BIOS is up to date. If so, resetting BIOS to default may help.</li><li>7. Test with verified working operating system or restore operating system to be sure that the issue is not caused by different language settings, sticky keys feature, etc.</li><li>8. Verify that keyboard flex cables are fully inserted and in good condition.</li></ol>
<b>The sections below are intended for authorized service providers/technicians.</b>	
	<ol style="list-style-type: none"><li>1. Verify if keyboard flex cable is in good condition (no delamination or torn cable end, no missing or cracked tracks, pads).</li><li>2. Verify keyboard flex cable ends are fully inserted and aligned with connectors on system board, and those connector tabs are properly closed. Reseat cables.</li><li>3. Replace new internal keyboard and retest.</li></ol>
<b>Tips and tricks</b>	A key only works when pressed with force. Inspect and remove debris trapped under keycap.

## Keyboard point stick

---

<i>Symptom</i>	<i>Possible causes</i>
Point stick not working properly	Dust trapped under point stick, loose point stick cap.
	<i>Troubleshooting steps</i>
	<ol style="list-style-type: none"><li>1. Inspect any signs of dust, liquid spill that prevent point stick from working.</li><li>2. Check whether point stick cap is loose and reseal it if necessary.</li></ol>

---

**The sections below are intended for authorized service providers/technicians.**

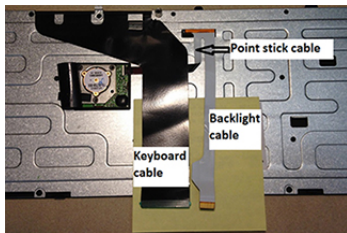

1. Verify whether keyboard flex cables are in good condition (no delamination or torn cable end, no missing or cracked tracks, pads).
2. Verify keyboard flex cable ends are fully inserted and aligned with connectors on system board and back of keyboard and that connector tabs are properly closed.
3. Reseat point stick cables.

Example of back of keyboard, including keyboard, point stick, and backlight cables.

## Keyboard backlight

---

<i>Symptom</i>	<i>Possible causes</i>
Backlight function not working properly	Backlight disabled, loose connection.
	<i>Troubleshooting steps</i>
	<b>NOTE:</b> Not all notebook computers have backlit keyboards. A keyboard function key lets you turn the light on and off. Verify if backlit feature is not disabled by pressing a combination of <b>Fn + Backlit</b> key.

---

**The sections below are intended for authorized service providers/technicians.**

1. Verify if backlight flex cables are in good condition (no delamination or torn cable end, no missing or cracked tracks, pads).
  2. Verify backlight flex cable ends are fully inserted and aligned with connectors on system board and that connector tabs are properly closed.
  3. Reseat backlight cable.
-

## TouchPad

---

<i>Symptoms</i>	<i>Possible causes</i>
Not working properly	On/Off enabled, driver, settings.
	<i>Troubleshooting steps</i>
	<ol style="list-style-type: none"><li>1. Ensure touchpad On/Off light is not amber (disabled). Double touch to enable.</li><li>2. Verify if touchpad device is listed in <b>Device Manager &gt; Mice and other pointing devices</b>.</li><li>3. Install the latest touchpad driver.</li><li>4. Adjust touchpad settings (<b>Control Panel &gt; Mouse</b>).</li><li>5. Test touchpad controller using the HP PC Hardware Diagnostics (UEFI) tool (<b>F2 &gt; Component Tests &gt; Mouse Test &gt; Pointer Test &amp; Drag and Drop Test</b>).</li></ol>
<b>The sections below are intended for authorized service providers/technicians.</b>	
	<ol style="list-style-type: none"><li>1. Check the touchpad cable for damage or a loose connection, and then reseal the touchpad cable.</li><li>2. If issue persists, replace the touchpad and verify the change.</li></ol>

---

## Network Connectivity Ethernet (RJ-45 jack)

---

<i>Symptoms</i>	<i>Possible causes</i>
<ul style="list-style-type: none"><li>• Unable to find networks (yellow bang)</li><li>• Connection dropouts</li><li>• Slow performance</li></ul>	Network source, cable, connection, RJ-45 port, driver, settings.
	<i>Troubleshooting steps</i>
	<b>Quick Check:</b> verify the network status lights that supposed to flash when there is network activity.
HP Support Assistant tool - No network detected in HPSA	<ol style="list-style-type: none"><li>1. Turn off the computer's wireless feature (press wireless button).</li><li>2. Verify that networking source with recommended distance to the base is less than 300 feet.</li><li>3. Examine the Ethernet cable for damage. Test with a verified working cable.</li><li>4. Test with different networks and jacks and check with IT for hardware compatibility settings.</li><li>5. Connect a verified working RJ-45 cable directly to the computer to isolate other related issues (e.g., router, switch, docking station).</li><li>6. Verify Ethernet port lights (RJ-45):<ul style="list-style-type: none"><li>– Green (left): network is connected.</li><li>– Amber (right): network is showing activity.</li></ul></li><li>7. Test with HP Support Assistant in Windows.</li></ol>

---



8. Diagnose with HP PC Hardware Diagnostics (UEFI) to isolate a hardware issue from a software issue.
9. Examine Ethernet ports on the computer, docking station, and wall for damage, dust, obstructions.
10. **Update drivers:** Verify that Ethernet module is displayed in Device Manager and be sure that device driver is up to date. If updating drivers does not help, try rolling back to previous drivers.
11. **Reset BIOS to Default:** If other devices can connect to network, but computer cannot connect, a BIOS setting might be the cause of the problem. Restore BIOS to default.
12. Test with verified working operating system or perform operating system recovery to verify that the issue is not caused by customized settings.
13. Replace system board and verify that the issue is fixed.

## Network connectivity wireless (WLAN)

### Symptoms

- Unable to find networks (yellow bang)
- Connection dropouts
- Slow performance

### Possible causes

Network source, cable, connection, wireless module, driver, settings.

HP Support Assistant tool - No network detected in HPSA



Wireless Adapter Properties - U-APSD support

### Troubleshooting steps

1. Turn off the computer's wired network (remove RJ-45 cable).
2. Examine environment for interference, such as cell phone or microwave, that may emit high frequencies (above 1 GHz).
3. Verify wireless source by moving computer closer to the wireless base/router.
4. Test with different wireless networks and check with your IT department for hardware compatibility, settings.
5. Verify that the wireless light is on. If the light is amber, press the wireless button to enable the wireless device.
6. Test with HP Support Assistant in Windows.
7. Diagnose with HP PC Hardware Diagnostics (UEFI) to isolate a hardware issue from a software issue.
8. **Update drivers:** Verify that wireless module is displayed in Device Manager and be sure that wireless drivers are up to date using [www.hp.com](http://www.hp.com) or HP Support Assistant. If updating drivers does not help, try rolling back to previous drivers.
9. **Reset BIOS to Default:** If other devices can connect to your wireless network, but your computer cannot connect, a BIOS setting might be the cause of the problem. Restore BIOS to default.
10. Configure power management advanced settings as necessary.

In the example to the left, **U-APSD support** (Unscheduled Automatic Power Save Delivery) is changed to **Disabled** to resolve an incompatible access

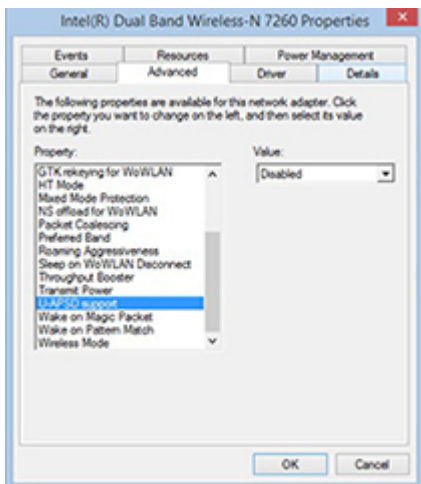

point. If disabling U-APSD improves the throughput issue, check with the access point provider for updated firmware that resolves the issue.

11. Test with verified working operating system or perform operating system recovery to verify that the issue is not caused by customized settings.
12. Test with a verified working wireless module.

**The sections below are intended for authorized service providers/technicians.**

1. Verify that the wireless module and its antenna cables are fully inserted and in good condition (see WLAN module removal and replacement section). Reseat wireless module and antenna connection.
2. Verify module antenna cable connection are not loose.
3. Verify antenna cables are properly connected to the MAIN and AUX terminals (see WLAN module removal and replacement section).

## WWAN

Symptom	Possible causes
Unable to find networks/service	Network source, cable, connection, driver, settings.
	<i>Troubleshooting steps</i>
	<ol style="list-style-type: none"> <li>1. Update to the latest driver and utility.</li> <li>2. Check with network service provider for signal coverage.</li> <li>3. Make sure signal strength is good.</li> <li>4. Make sure your service is active.</li> </ol>

**The sections below are intended for authorized service providers/technicians.**

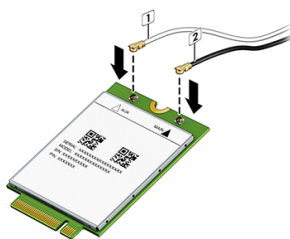

- Verify module and antenna cable connections are not loose.
- Verify antenna cables are properly connected to the correct terminals. For example, the antenna cable labeled “1” connects to the “Main” terminal labeled “1”. The antenna cable labeled “2” connects to the “Aux” terminal labeled “2”.

# USB

## Symptoms

- USB devices are not recognized
- USB devices are not charging

## Possible causes

USB devices do not have the latest software drivers, port insufficient power, or not compliant.

**NOTE:** USB Type-C uses a different connector entirely

## Examples of USB device Not Recognized

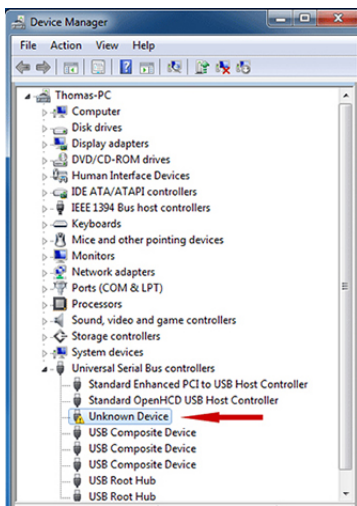
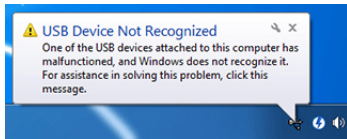

## Troubleshooting steps

1. Unplug USB device and/or restart the computer (wait for 2-5 minutes) to reset USB port/hub in case of power surge.
2. Soft Reset ([9. Soft reset \(Default Settings\) on page 90](#)) and verify if USB device is recognized.
3. Verify if USB device is recognized in **Device Manager > Universal Serial Bus Controller**, or USB is recognized without Yellow bang.
4. Verify if the latest USB driver or/and USB chipset driver are installed. USB driver could be removed and reinstalled.
5. Make sure USB device is supported, for example, USB 3.0 device requires more power drawn (0.9A) from USB port than USB 2.0 device (0.5A). As a result, identify USB charging port to be used for charging a USB device, or an external AC power adapter may be required for an external USB storage to work properly.
6. Test with verified working USB devices (keyboard, mouse, USB key) to make sure USB ports are functional.
7. Test USB device on a verified working computer to make sure USB device is not malfunctioning.

## Smart card reader

---

### Symptoms

- Not recognized
- Unable to write

### Possible causes

Physical damage, incorrect insertion, dirt, driver, malfunctioning card reader.

**NOTE:** Some cards have a read/write security switch on the card. Make sure that switch is set to “write enabled” before attempting to write data to it.

---

### Card Reader Removal Policy

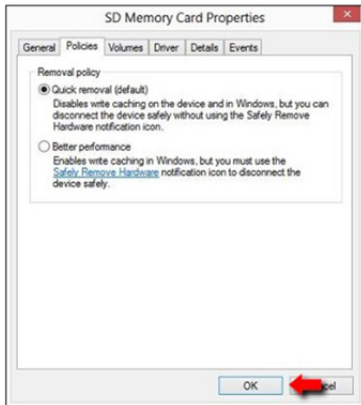

### Troubleshooting steps

1. Verify card reader removal policy.
2. Make sure there is no physical damage to the card.
3. Inspect the ends of the memory cards for dirt or material closing a hole or spoiling a metal contact. Clean the contacts with a lint-free cloth and small amounts of isopropyl alcohol. Replace the memory card if necessary.
4. Reinstall and update the drivers for the card reader.
5. Make sure the smart card reader is compliant with ISO 7816 Class A, B, and C.
6. Reinsert the card reader with correct face as described in its documentation.
7. Check reader function with a verified working card.

**CAUTION:** If the card reader has an in-use indicator light, do not insert or remove memory cards while the light is flashing. Doing so may cause loss of data on the card or may permanently damage the card reader.

---

## Speaker, headphone - audio issues

---



### Symptoms

- No sound from external or internal speakers
- Distorted sound, too soft, too loud, intermittent



### Possible causes

Volume turned down, sound card not recognized, malfunctioning hardware, electronic interference.



### Troubleshooting steps

1. Remove any device connected to the Audio jack to enable the internal speaker.
2. Close all open programs.
3. Adjust volume by pressing **Fn +**  or . Be sure that volume button light is not amber (mute).  
  
- or -  
  
Adjust Windows volume control by clicking the speaker icon on the Windows taskbar. Be sure that the sound is not muted.
4. Verify that sound card is detected in Windows Device Manager.
5. Reinstall the **latest audio driver**.
6. Test audio device using HP PC Hardware Diagnostics (UEFI) tool (**F2 > Component Tests > Audio**).
7. Test with a verified working operating system. If issue is resolved, restore full operating system.
8. Test with verified working external speakers or headset.
9. Reseat internal speaker connections.
10. Test with verified working internal speakers.
11. Replace internal speakers.

### No sound from headphones

1. Adjust volume by pressing **Fn +**  or . Be sure that volume button light is not amber (mute). Or adjust Windows volume control by clicking the speaker icon on the Windows taskbar. Be sure that the sound it not muted.
2. Check headphone cable connection.
3. Test with a verified working audio board.
4. Replace audio board and verify the change.

### No sound from external speakers

1. Verify that external speakers are turned on.
2. Disconnect headphones from headphone jack.
3. Adjust volume by pressing **Fn +**  or . Be sure that volume button light is not amber (mute).  
  
- or -  
  
Adjust Windows volume control by clicking the speaker icon on the Windows taskbar. Be sure that the sound is not muted.
4. Check for possible interference devices nearby that may impact the audio (cell phone or portable communications handset.)



## Thunderbolt (TB)

Symptom	Possible causes
Thunderbolt device not working	BIOS, drivers, and user settings.

### Troubleshooting steps

1. Update to the latest BIOS and choose appropriate TB Port settings.
2. Reset **User Account Settings** to default.
3. Update Intel Thunderbolt software that includes firmware version (for TB controller), driver version (operating system driver), and application version.

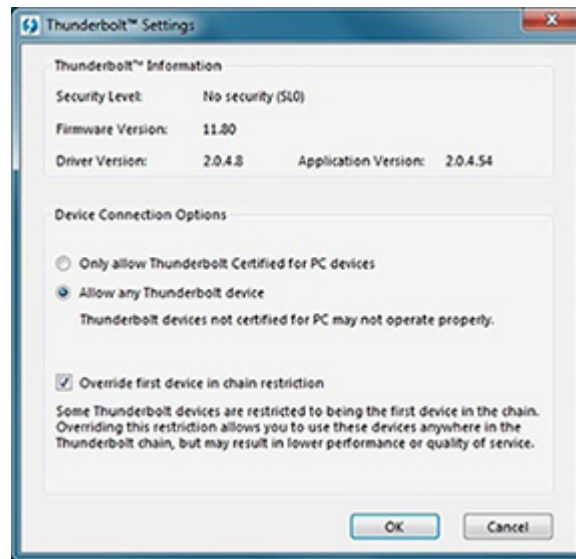

4. Verify that TB device is detected in Windows Device Manager.

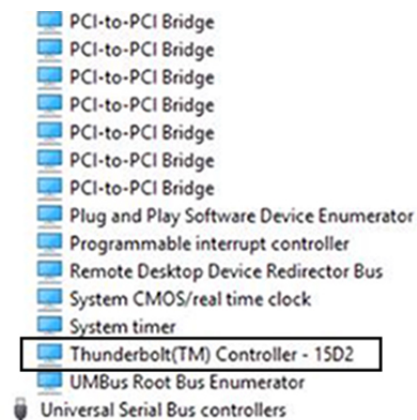

5. Verify TB port, cable and connection.
6. Test with a verified working TB board, if possible.

**NOTE:** Thunderbolt is new technology. Thunderbolt cable and Thunderbolt device must be compatible with Windows. To determine whether your device is Thunderbolt Certified for Windows, see <https://thunderbolttechnology.net/products>.

## Thunderbolt 3 dock

---

<i>Symptom</i>	<i>Possible causes</i>
Thunderbolt dock and devices not working	System BIOS, firmware, drivers, user settings, Thunderbolt dock firmware and driver, or hardware issues.
	<i>Troubleshooting steps</i>
	<ol style="list-style-type: none"><li><b>1. Important: review dock user guide and documents in references section for best practices.</b><p>Refer to “HP Elite Dock with Thunderbolt 3 and HP ZBook Dock with Thunderbolt 3 - Using and Troubleshooting the Dock” at <a href="http://h20565.www2.hp.com/hpsc/doc/public/display?sp4ts.oid=9822172&amp;docLocale=en_US&amp;docId=emr_na-c05060909">http://h20565.www2.hp.com/hpsc/doc/public/display?sp4ts.oid=9822172&amp;docLocale=en_US&amp;docId=emr_na-c05060909</a> for detailed instructions on how to troubleshoot common problems.</p><p>Docking and undocking (i.e., unplug the dock before putting notebook into Standby).</p><p>Connecting and disconnecting the dock.</p><p>Connecting external devices to the dock.</p><p>Configuring an external monitor.</p><p>Sleep, hibernation, shutdown, and restart.</p><p>Troubleshooting common problems.</p></li><li><b>2. Important: update to the latest BIOS, firmware, and drivers for both system and the dock.</b><p>Latest BIOS version for your computer.</p><p>Intel Thunderbolt Secure Connect driver.</p><p>Intel Thunderbolt firmware update utility.</p><p>Intel graphics drivers.</p><p>AMD or NVIDIA graphics driver (depends on notebook configuration).</p><p>Ethernet controller driver.</p><p>Conexant Audio USB driver.</p><p>ASMedia eXtensible host controller driver – dock is required to be plugged in.</p><p>Dock: Thunderbolt 3 Dock firmware – dock is required to be plugged in.</p></li><li><b>3. Visual inspection.</b><p>Inspect TB ports on your computer for any signs of damage.</p><p>Inspect dock cables on both ends and dock ports for any signs of damage.</p></li><li><b>4. Verify status light.</b><p>Verify system AC adapter light is on. Follow steps below if there is no AC adapter light.</p><p>Verify AC adapter by connecting AC adapter directly to the system.</p><p>Verify dock power light is on.</p><p>Verify TB cable and devices are properly connected. Use a verified working TB cable to insure there is a good connection between the dock and system.</p></li></ol>

---

---

Use a verified working dock. If the computer operates normally, there is a problem with the original dock.

---

#### References

Go to <http://support.hp.com/>, enter your model name or model number, or search for user guide titled "HP ZBook 150W Dock with Thunderbolt 3" or "HP ZBook 200W Dock with Thunderbolt 3", and then click **Manuals > Technical white papers**.

Advisory: HP ZBook Dock with Thunderbolt 3 - HP Mobile Workstation May Not Detect ZBook Thunderbolt Dock: [http://h20564.www2.hp.com/hpsc/doc/public/display?docId=emr\\_na-c05178033](http://h20564.www2.hp.com/hpsc/doc/public/display?docId=emr_na-c05178033)

---

## Storage



#### NOTE:

- Back up all critical data prior to drive troubleshooting.
- Prior to contacting support, HP recommends that you run a drive (HDD, SSD, M.2 drive) test using the HP PC Hardware Diagnostics (UEFI) tool on the suspected failed drive.
- Diagnose the hard drive using BIOS, Diagnostics built in the shipping image, or an external USB (HP PC Diagnostics 3-in-1 USB Key at [http://www8.hp.com/us/en/campaigns/hpsupportassistant/pc-diags.html?jumpid=va\\_r602\\_us/en/any/pps/pl\\_ot\\_ob\\_ds\\_pd/HP\\_PC\\_Hardware\\_Diagnostics\\_cc/dt](http://www8.hp.com/us/en/campaigns/hpsupportassistant/pc-diags.html?jumpid=va_r602_us/en/any/pps/pl_ot_ob_ds_pd/HP_PC_Hardware_Diagnostics_cc/dt)).
- The drive quick test is recommended to quickly (less than 10 minutes) identify the malfunctioning drive. If the issue still exists, run Extensive Test (more than 2 hours, or loop mode, which will run until an error occurs).
- If any test fails, record failure code and contact support for instructions on how to order a replacement hard drive.
- If all of the tests pass, the hard drive is not damaged. As a rule, HP will not replace a hard drive under warranty that does not fail the HP Hard Drive Self-Test.
- If there is no physical problem with the hard drive (or memory), then try reinstalling the Windows operating system to troubleshoot the problem.

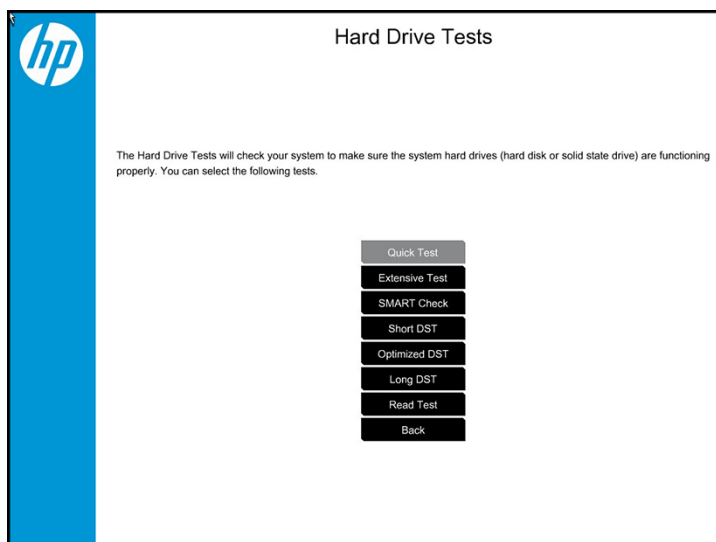

## Hard drive/solid-state drive not recognized

---

<i>Symptom</i>	<i>Possible causes</i>
Hard drive is not recognized during POST	Loose connection, faulty hard drive, faulty drive configuration/BIOS setting.
	<i>Troubleshooting steps</i>
	<ol style="list-style-type: none"><li>1. Perform a hard reset (<a href="#">8. Hard reset on page 89</a>).</li><li>2. Reset BIOS to default.</li><li>3. Verify hard drive connection and flex cable. Reseat hard drive and cable connection. For multiple storage devices, keep the primary drive with the operating system and remove other devices.</li><li>4. Use the HP Hardware Diagnostics tool to verify the drive is recognized and test it.</li><li>5. If the hard drive fails diagnostics, record failure and have the drive replaced.</li><li>6. Identify when the issue is related to software. If the hard drive passes diagnostics, test the drive on a verified working computer. If the failure follows the drive, reinstall the operating system to make sure software is not an issue.</li><li>7. Test with a verified working hard drive. If it is still not recognized, the system board is faulty.</li></ol>
	<b>NOTE:</b> If the drive is seen in BIOS and Diagnostics, try a secure erase prior to replacing a drive as this may resolve related issues.

---

## No boot to operating system (no read/write error)

---

<i>Symptoms</i>	<i>Possible causes</i>
<ul style="list-style-type: none"><li>• Post error message: Boot Device not found (3F0)</li><li>• Hang when booting to operating system</li></ul>	Operating system, loose connection, faulty hard drive, BIOS configuration, Secure Boot.
	<i>Troubleshooting steps</i>
	<ol style="list-style-type: none"><li>1. Verify if Secure Boot is enabled in BIOS. Secure Boot prevents legacy boot devices from starting the computer, including bootable CDs and DVDs. For more information, see "HP PCs - Secure Boot (Windows 8)" at <a href="http://support.hp.com/us-en/document/c03653226">http://support.hp.com/us-en/document/c03653226</a>.</li><li>2. Reset BIOS to default. Be sure that BIOS <b>Boot Mode</b> in <b>Boot Option</b> is set up properly for bootable device and its operating system (i.e., UEFI Native for Windows 8).  Another example, choosing <b>Legacy Boot Order</b> for an UEFI device will cause "Boot Device not found (3F0)" error.</li><li>3. Verify hard drive connection and flex cable. Reseat connection. For multiple storage devices, keep the primary drive with the operating system and remove other devices.</li><li>4. Use PC Hardware Diagnostics tool to test. Record failure code and have the hard drive replaced.</li><li>5. If there is no error, reinstall the operating system using HP Restore.</li><li>6. Test with a verified working operating system hard drive, if available.</li></ol>
<b>Note</b>	If there is a hard drive POST error message, see <a href="#">POST Error Messages and User Actions on page 140</a> .

---

## Read-write error

---

<i>Symptoms</i>	<i>Possible causes</i>
<ul style="list-style-type: none"><li>• Post error message (i.e., error code 301)</li><li>• Hang when working on data, files, documents</li></ul>	<p>Loose connection, faulty hardware.</p> <hr/> <p><i>Troubleshooting steps</i></p> <ol style="list-style-type: none"><li>1. Perform a hard reset (<a href="#">8. Hard reset on page 89</a>).</li><li>2. Reset BIOS to default (<a href="#">9. Soft reset (Default Settings) on page 90</a>).</li><li>3. Verify drive connection and flex cable. Reseat connection (<a href="#">10. Reseat cables and connections on page 90</a>).</li><li>4. Use the HP Hardware Diagnostics tool to test. If failed, record failure code and have the hard drive replaced.</li><li>5. If no error with HP PC Hardware Diagnostics (UEFI) tool, try to repair the hard drive and its files in Windows (using command “CHKDSK /f /r /x”). Use HP Restore to reinstall the operating system, if needed.</li><li>6. Test with a verified working hard drive. If it is not recognized, the system board is faulty.</li></ol>
<b>Note</b>	If there is a hard drive POST error message, see <a href="#">POST Error Messages and User Actions on page 140</a> .

---

## Slow performance

---

<i>Symptoms</i>	<i>Possible causes</i>
Slow performance even when performing small read/write operations	<p>Operating system files, hard drive is full.</p> <hr/> <p><i>Troubleshooting steps</i></p> <ol style="list-style-type: none"><li>1. Transfer data from the hard drive to create more space. Microsoft recommends at least 200 MB to sync system files.</li><li>2. Perform disk defragmentation to consolidate fragmented data on the hard drive so it will work more efficiently.</li></ol> <p><b>NOTE:</b> Do not defrag an SSD.</p>
<b>Tips &amp; tricks</b>	<p>For optimal system performance, you need to place your operating system and all of your most commonly used applications and files in the fastest hard drive (solid-state drive) and fastest areas on the drive (primary partition of 200 GB max).</p> <p>See “Improving System Performance” at <a href="http://h20564.www2.hp.com/hpsc/doc/public/display?docLocale=en_US&amp;docId=emr_na-c00816938">http://h20564.www2.hp.com/hpsc/doc/public/display?docLocale=en_US&amp;docId=emr_na-c00816938</a>. Also see <a href="#">Routine Maintenance for Performance Improvement on page 141</a>).</p>

---

## Blue screen (BSOD) error

Faulty hard drive may cause blue screen error. Perform the drive tests using the HP Diagnostics Tool to make sure the drive is functional. If all of the tests pass, see [Common Blue Screen Error Messages on page 142](#) for detailed troubleshooting steps.

## Noisy hard drive



**IMPORTANT:** An SSD has no moving parts, so it does not make loud or clicking noise.

Depending on type and rotational speed, some hard drives will make more noise than others.

Not all noises are related to the fan or hard drive.

---

<i>Symptoms</i>	<i>Possible causes</i>
<ul style="list-style-type: none"><li>• Loud noise from hard drive</li><li>• Clicking noise from hard drive</li><li>• Still boots to operating system and operates normally</li></ul>	BIOS, hard drive firmware, driver, faulty drive, power supply (AC adapter).
	<i>Troubleshooting steps</i>
	<ol style="list-style-type: none"><li>1. Update BIOS and hard drive firmware.</li><li>2. Examine AC adapter to be sure that it is not faulty or overloaded. Disconnect all peripherals (USB storages, dock, etc.).</li><li>3. Remove hard drive to isolate the noise.</li><li>4. Test the hard drive on a verified working computer if the noise continues. If the hard drive makes the same noise or clicking sounds, the sounds are either normal sounds for the hard drive or a fault with the hard drive.</li><li>5. Verify original hard drive connection and flex cable. Reseat hard drive and connection.</li><li>6. Run HP PC Hardware Diagnostics (UEFI). If failed, record failure code and have the hard drive replaced.</li><li>7. If no error with HP PC Hardware Diagnostics (UEFI), perform disk defragmentation (some hard drives make a clicking noise when highly fragmented).</li></ol>
<b>Tips &amp; tricks</b>	<p>For optimal system performance, place your operating system and all of your most commonly used applications and files on the fastest hard drive or solid-state drive and on the fastest areas on the drive (primary partition of 200 GB max).</p> <p>See “Improving System Performance” at <a href="http://h20564.www2.hp.com/hpsc/doc/public/display?docLocale=en_US&amp;docId=emr_na-c00816938">http://h20564.www2.hp.com/hpsc/doc/public/display?docLocale=en_US&amp;docId=emr_na-c00816938</a>. Also, see <a href="#">Routine Maintenance for Performance Improvement on page 141</a>).</p>

---

# Mechanical

## Fan error message - 90B

### Symptoms

Fan error 90B at boot

**CAUTION:** May lead to system shutdown, data loss or possible system damage.

### Possible causes

Defective fan; out-of-date BIOS.

- The system fan is not spinning or not spinning properly (loose connection, fan is stuck or defective).
- The temperature inside the case is too high, and the fan cannot spin fast enough to remove the heat due to an obstruction to air flow.



### Troubleshooting steps

#### General actions

1. Update BIOS and drivers ([4. Update BIOS and drivers on page 79](#)) or reset BIOS to default. BIOS may implement new fan characteristics and updates for other components.
2. Perform a hard reset ([8. Hard reset on page 89](#)). Performing a hard reset can reset recorded thermal values in memory.

#### Thermal-related issue

1. Verify thermal condition:
  - a. Check fan and connection. Reseat fan cable.
  - b. Be sure that no obstructions or dust are in heat sink fan, fin, or vent.
  - c. Test fan using HP PC Hardware Diagnostics (UEFI) tool ([6. HP Hardware Diagnostics and Tools on page 80](#)). Be sure that the fan is not producing loud noise and that fan blades spin correctly.
  - d. Test with a verified working fan.
  - e. Remove old thermal compound and pads, and replace properly with new pads.
2. Verify thermal solution
  - ▲ Use Thermal Monitor tool (available only to authorized service providers/ technicians) to run stress test (processor and GPU) and verify that thermal sensors are within limits after thermal condition is serviced.

#### Note

BIOS currently omits fan presence detection to shorten boot time delay less than four seconds. Therefore, the fan error is generated based on previous boot to operating system that found system fan error.

Fan often is part of thermal solution, including heat sink, fin/ muffler, and thermal grease. Fan replacement requires reboot and fan function verification using HP PC Hardware Diagnostics (UEFI) tool.

---

See “Reducing Heat Inside the PC to Prevent Overheating” at [http://h20564.www2.hp.com/hpsc/doc/public/display?docLocale=en\\_US&docId=emr\\_na-c01657439](http://h20564.www2.hp.com/hpsc/doc/public/display?docLocale=en_US&docId=emr_na-c01657439).

---

## Noise (sound)

---

### *Symptoms*

Computer emits abnormal noise

### *Possible causes*

Aside from basic components (power adapter/supply, fan, speaker, hard drive, optical drive, display panel, external devices), it is also common for electronic components to produce noise.

### *Troubleshooting steps*

1. Inspect external power source and change to verified working one.
2. Determine whether the noise comes from AC power adapter. Test with a verified working AC adapter.

Disconnect external devices and all cables connected to the computer to isolate issue to computer only.

### **Noisy fan**

Determine whether the noise comes from the fan. Disconnect the fan briefly to isolate whether noise originates from fan. If noise is absent with fan disconnected, refer to [Fan runs constantly on page 135](#).

### **Noisy hard drive**

Determine whether the noise comes from the hard drive.

See [Noisy hard drive on page 132](#).

### **Noisy optical drive**

1. Determine whether the noise comes from an optical drive.
2. Remove CD/DVD from the optical drive.

### **Noisy speaker**

1. Determine whether the noise comes from speaker.
2. Test with a verified working external headset/speaker.

### **Noisy display**

Determine whether the noise comes from display panel (humming noise). Change display frequency settings. See [Display on page 113](#).

### **The section below is intended for authorized service providers/technicians.**

1. After disassembling the chassis, inspect components of the interior for excessive wear or damage.
  2. If noise issues persist, proceed with process of elimination for battery, AC adapter, or boards.
-



## Fan runs constantly

---

<i>Symptoms</i>	<i>Possible causes</i>
<ul style="list-style-type: none"><li>• Fan never stops running</li><li>• Generates heat</li><li>• Decreased computer performance</li></ul>	<ul style="list-style-type: none"><li>• BIOS not up to date.</li><li>• Thermal condition (fan, air flow)--fan may not be defective but must run constantly to remove excess heat generated by electrical components.</li><li>• Inappropriate configuration.</li></ul>
	<p><i>Troubleshooting steps</i></p> <p><b>General actions</b></p> <ol style="list-style-type: none"><li>1. Verify whether BIOS is set to <b>Fan Always on while on AC Power</b> F10 Setup. When booting the computer, press <b>F10</b> to open Setup, and then select <b>Advanced &gt; Built-In Device Options Menu</b>.</li><li>2. Update BIOS and drivers (<a href="#">4. Update BIOS and drivers on page 79</a>) and reset BIOS to default. BIOS may implement new fan characteristics and updates for other components.</li><li>3. Perform a hard reset (<a href="#">8. Hard reset on page 89</a>). Performing a hard reset can reset recorded thermal values in memory.</li></ol>
	<p><b>Thermal-related issue</b></p> <ol style="list-style-type: none"><li>1. Verify fan is spinning. Reseat fan cable before moving to next step.<ol style="list-style-type: none"><li>a. Check fan and connection. Reseat fan cable.</li><li>b. Be sure that no obstructions or dust are in heat sink fan, heat sink fin, or vent.</li><li>c. Test fan using HP PC Hardware Diagnostics (UEFI) tool (<a href="#">6. HP Hardware Diagnostics and Tools on page 80</a>). Be sure that the fan is not producing loud noise and that fan blades spin correctly.</li><li>d. Test with a verified working fan.</li><li>e. Replace the fan.</li></ol></li><li>2. Verify thermal solution<p>Use Thermal Monitor tool (available only to authorized service providers/technicians) (<a href="#">HP Thermal Monitor on page 83</a>) to run stress test (processor and GPU) and verify that thermal sensors are within limits after thermal condition is serviced.</p></li></ol>
	<p><b>User configuration</b></p> <p>Change Power Options in Windows (i.e., choosing <b>Balanced mode</b> instead of <b>High performance</b>). High performance and extensive graphics may cause the fan run constantly to release the heat.</p>
<b>Notes</b>	<p>BIOS currently omits fan presence detection to shorten boot time delay less than four seconds. Therefore, the fan error is generated based on previous boot to operating system that found system fan error.</p> <p>Fan often is part of thermal solution, including heat sink, heat sink fin/muffler, and thermal grease. Fan replacement requires reboot and fan function verification using HP PC Hardware Diagnostics (UEFI) tool.</p> <p>For more information, see the following links:</p> <ul style="list-style-type: none"><li>• HP Notebook PCs - Fan is Noisy and Spins Constantly, PC is Warmer than Normal: <a href="http://support.hp.com/us-en/document/c01007591">http://support.hp.com/us-en/document/c01007591</a>.</li></ul>

- Reducing Heat Inside the PC to Prevent Overheating: [http://h20564.www2.hp.com/hpsc/doc/public/display?docLocale=en\\_US&docId=emr\\_na-c01657439](http://h20564.www2.hp.com/hpsc/doc/public/display?docLocale=en_US&docId=emr_na-c01657439).
- Improving System Performance: [http://h20564.www2.hp.com/hpsc/doc/public/display?docLocale=en\\_US&docId=emr\\_na-c00816938](http://h20564.www2.hp.com/hpsc/doc/public/display?docLocale=en_US&docId=emr_na-c00816938).

## Thermal shutdown (hot)

### Symptoms

Similar to fan runs constantly issue ([Fan runs constantly on page 135](#))

- System shutdown
- Abnormal heat
- Continually running fan
- Decreased computer performance

### Possible causes

BIOS, drivers not up to date, thermal condition (fan, air flow)

### Troubleshooting steps

1. Update BIOS and drivers ([4. Update BIOS and drivers on page 79](#)) and reset BIOS to default. BIOS may implement new fan characteristics and updates for other component.
 

**NOTE:** Studio model is shipped with Intel Dynamic Platform and Thermal Framework (DPTF) driver that provides system temperature and power utilization information for the system thermal protection to function properly. When DPTF driver is installed, ensure DPTF is also enabled in F10 BIOS (by default).
2. Perform a hard reset ([8. Hard reset on page 89](#)). Performing a hard reset can reset recorded thermal values in memory.
3. Determine whether you are using a correct AC adapter.
4. Be sure to turn power off completely when putting a notebook in a travel bag.

**NOTE:** It is normal for the system to get warm in F10 BIOS mode after a period of time (i.e., one hour) because there is no power management in a non-operating system environment.



### Thermal-related issue

1. Verify thermal condition:
  - a. Check fan and connection. Reseat fan cable.
  - b. Be sure that no obstructions or dust are in heat sink fan, fin, or vent.
  - c. Be sure that the notebook is not sitting on a hot surface that blocks vent intakes.
  - d. Test fan using HP PC Hardware Diagnostics (UEFI) tool ([6. HP Hardware Diagnostics and Tools on page 80](#)). Be sure that the fan is not producing a loud noise and that fan blades spin correctly.
  - e. Test with a verified working fan.
  - f. Remove old thermal compound and pads, and replace properly with new pads.
2. Verify thermal solution:
  - Use Thermal Monitor tool (available only to authorized service providers/technicians) to run stress test (processor and GPU) and verify that thermal sensors are within limits after thermal condition is serviced.

### Note

See “Reducing Heat Inside the PC to Prevent Overheating” at [http://h20564.www2.hp.com/hpsc/doc/public/display?docLocale=en\\_US&docId=emr\\_na-c01657439](http://h20564.www2.hp.com/hpsc/doc/public/display?docLocale=en_US&docId=emr_na-c01657439).

## Stuck power button

---

<i>Symptoms</i>	<i>Possible causes</i>
<ul style="list-style-type: none"><li>• Rear power indicator light is on</li></ul>	Sticky or defective power button.
<ul style="list-style-type: none"><li>• Will not turn on when power button is pressed</li></ul>	<i>Troubleshooting steps</i>
<ul style="list-style-type: none"><li>• Automatically powers on</li></ul>	<b>General actions</b> <ol style="list-style-type: none"><li>1. Perform a hard reset (<a href="#">8. Hard reset on page 89</a>).</li><li>2. Perform a soft reset if system can turn on.</li></ol>
<b>The sections below are intended for authorized service providers/technicians.</b>	
	<ol style="list-style-type: none"><li>1. Disassemble the unit.</li><li>2. Inspect power button on the top cover and on the system board to make sure these buttons move freely.</li></ol>

---

## Additional information

The following sections provide additional information that can be used during the troubleshooting process.

### Acronyms

The following acronyms are used in this chapter.

**Blue screen (BSOD)**—A Windows error screen that can occur if a problem causes your computer to shut down or restart unexpectedly. When you experience this type of error, you will not be able to see items such as the Start menu or the taskbar when your computer is turned on. Instead you might see a blue screen with a message that your computer ran into a problem and needs to restart.

**CPU**—Central processing unit

**DIMM**—Dual in-line memory module

**Daughterboard**—Type of circuit board that plugs into or is attached to the system board or similar expansion card to extend its features and services.

**GPU**—Graphics processor unit

**GTS**—General Troubleshooting Step

**HDD**—Hard drive

**KB**—Keyboard

**LVDS**—Low-Voltage Differential Signaling

**MSG**—Maintenance and Service Guide

**mWS**—Mobile Workstations

**WS**—Workstations

**OS**—Operating system

**PC**—Personal computer

**POST**—Power-On Self-Test

**SSD**—Solid-state drive

**TSG**—Troubleshooting Guide

**UEFI**—Unified Extensible Firmware Interface

**WLAN**—Wireless local area network

**WWAN**—Wireless wide area network

## Blinking lights and boot error codes

The information below is from the white paper “HP Business Notebook and Desktop PC F10 Setup, 2014 Business PC models” at <http://h10032.www1.hp.com/ctg/Manual/c04685655>.

In some cases, when the host processor is not executing code or does not have the necessary code to drive the display, light blink codes inform you of a problem.

**Table 6-6 Boot-error codes**

Blink codes	Error
Amber battery light: blinks 1 Hz continuously	Embedded Controller unable to load firmware
Caps/num lock lights = 1 blink	Processor not executing code
Caps/num lock lights = 2 blinks	BIOS recovery code unable to find valid BIOS recovery image
Caps/num lock lights = 3 blinks	Memory module error
Caps/num lock lights = 4 blinks	Graphics controller error
Caps/num lock lights = 5 blinks	System board error
Caps/num lock lights = 6 blinks	Intel Trusted Execution Technology (TXT) Error
Caps/num lock lights = 7 blinks	Sure Start unable to find valid BIOS Boot Block image
Caps/num lock lights = 8 blinks	Sure Start has identified a problem (Manual Recovery Policy Set)

### Processor not executing code

This computer has experienced a problem due to the failure of certain code to execute, resulting in a failed startup of the processor. The issue could be related to the processor or the system board in the computer. If the processor is socketed, be sure that the processor is seated correctly in the socket. If this error reoccurs, refer to [General troubleshooting steps on page 75](#).



**NOTE:** The computer will attempt to notify you of this problem through a series of blinking lights. When you attempt to turn on the computer from an “Off” or “Hibernated” state, lights associated with the **caps lock** and **num lock** keys will both **blink once** followed by a pause, and then continue in a repeating pattern.

### BIOS recovery code unable to find valid BIOS recovery image

This computer has experienced a problem in locating a valid BIOS image, resulting in a failed startup. This problem may be resolved by placing a clean copy of the system BIOS on a USB key or in the appropriate hard drive directory and performing a reboot. If this error reoccurs, refer to [General troubleshooting steps on page 75](#).



**NOTE:** The computer will attempt to notify you of this problem through a series of blinking lights. When you attempt to turn on the computer from an “Off” or “Hibernated” state, lights associated with the **caps lock** and **num lock** keys will both **blink twice** followed by a pause, and then continue in a repeating pattern.

## Memory module error

This computer has experienced a memory initialization problem resulting in a failed startup. This issue may be related to the memory modules in the computer. This problem may be resolved by ensuring that memory modules are correctly inserted and seated. If this error reoccurs, a service event is required to determine the source of the error (memory modules or system board) and take the appropriate corrective action.

---

 **NOTE:** The computer will attempt to notify you of this problem through a series of blinking lights. When you attempt to turn on the computer from an “Off” or “Hibernated” state, lights associated with the [caps lock](#) and [num lock](#) keys will both **blink three times** followed by a pause, then continue in a repeating pattern.

---

## Graphics Controller Error (No Controller)

This computer has experienced a graphics controller initialization problem resulting in a failed startup. This issue may be related to the graphics controller in your machine. This problem may be resolved by ensuring that the graphics controller module is seated correctly in machines with modular graphics. If this error reoccurs, a service event is required to identify the source of the error and take the appropriate corrective action.

---

 **NOTE:** The computer will attempt to notify you of this problem through a series of blinking lights. When you attempt to turn on the computer from an “Off” or “Hibernated” state, lights associated with the [caps lock](#) and [num lock](#) keys will both **blink four times** followed by a pause, then continue in a repeating pattern.

---

## Failure - System Board Error

This computer has experienced a system board initialization problem resulting in a failed startup. This issue may be related to the system board in the computer. A service event is required to identify the source of the error and take the appropriate corrective action.

---

 **NOTE:** The computer will attempt to notify you of this problem through a series of blinking lights. When you attempt to turn on the computer from an “Off” or “Hibernated” state, lights associated with the [caps lock](#) and [num lock](#) keys will both **blink five times** followed by a pause, then continue in a repeating pattern.

---

## Intel Trusted Execution Technology (TXT) Error

This computer has experienced a problem related to the Intel Trusted Execution Technology resulting in a failed startup. The error occurs when all of the following are true:

- The Intel Trusted Execution Technology (TXT) has been enabled on the computer.
- Policies have been set to prevent startup if the BIOS measurement has changed.
- The BIOS measurement has changed.

For more information about Intel TXT, go to <http://www.intel.com/content/dam/www/public/us/en/documents/white-papers/trusted-execution-technology-security-paper.pdf>.

A service event is required to resolve this issue.

---

 **NOTE:** The computer will attempt to notify you of this problem through a series of blinking lights. When you attempt to turn on the computer from an “Off” or “Hibernated” state, lights associated with the [caps lock](#) and [num lock](#) keys will both **blink six times** followed by a pause, then continue in a repeating pattern.

---

## Sure Start unable to find valid BIOS Boot Block image

This computer has experienced a problem in locating a valid BIOS image, resulting in a failed startup. A service event is required to identify the source of the error and take appropriate corrective action.



**NOTE:** The computer will attempt to notify you of this problem through a series of blinking lights. When you attempt to turn on the computer from an “Off” or “Hibernated” state, lights associated with the **caps lock** and **num lock** keys will both **blink seven times** followed by a pause, then continue in a repeating pattern.

### Sure Start has identified a problem (Manual Recovery Policy Set)

This computer has experienced a problem in locating a valid BIOS image, resulting in a failed startup. HP Sure Start will normally repair this type of issue; however, on this computer HP Sure Start has been configured to operate in manual mode key sequence. To proceed with the repair, press and hold the following keys: **<ESC> +<UP arrow>+<DOWN arrow>**. To avoid the need for this manual recovery step, set the HP Sure Start recovery policy to automatic. If this error reoccurs, a service event is required to identify the source of the error and take appropriate corrective action.



**NOTE:** The computer will attempt to notify you of this problem through a series of blinking lights. When you attempt to turn on the computer from an “Off” or “Hibernated” state, lights associated with the **caps lock** and **num lock** keys will both **blink eight times** followed by a pause, then continue in a repeating pattern.

### POST Error Messages and User Actions

Test description	Displayed message	Error code	Possible user actions
Product information	Invalid value	00A	Contact support for assistance.
Startup test	Memory module	2E1, 2E2	Attempt to reseat the memory module and then repeat the test.  See “Overview of How to Troubleshoot Problems When a Computer Does Not Start Up or Boot Properly” at <a href="http://h20566.www2.hp.com/hpsc/doc/public/display?docLocale=en_US&amp;docId=emr_na-c01443371">http://h20566.www2.hp.com/hpsc/doc/public/display?docLocale=en_US&amp;docId=emr_na-c01443371</a> for details on troubleshooting issues related to the memory module.  If the memory module still fails, contact support.
Startup test	Hard Disk 1 SMART Hard Drive Detects Imminent Failure	301	Attempt to reseat the hard drive and repeat the test.  The hard disk drive may have failed. Contact support for assistance.
Startup test	Hard Disk 2 SMART Hard Drive Detects Imminent Failure	302	Attempt to reseat the hard drive and repeat the test.  The hard disk drive may have failed. Contact support for assistance.
Startup test	Hard Disk 3-6: SMART Hard Drive Detects Imminent Failure	309–30C	Attempt to reseat the hard drive and repeat the test.  The hard disk drive may have failed. Contact support for assistance.
Boot Device Manager	Boot device not found	3F0	Indicates a potential problem with the hard drive. Please run the hard drive test.  See “Testing a Hard Disk using the Built in Self Test “ at <a href="http://h20566.www2.hp.com/hpsc/doc/public/display?docLocale=en_US&amp;docId=emr_na-c00439024">http://h20566.www2.hp.com/hpsc/doc/public/display?docLocale=en_US&amp;docId=emr_na-c00439024</a> for more information.
BIOS Recovery	BIOS recovery occurred	500	This message indicates that BIOS recovery was completed successfully. No further action is required.
Battery Check	Primary battery rReplace	601	This indicates that the primary battery has very low capacity. See “Checking the Status of the Battery” at <a href="http://h20566.www2.hp.com/hpsc/doc/public/display?docLocale=en_US&amp;docId=emr_na-c00821536">http://h20566.www2.hp.com/hpsc/doc/public/display?docLocale=en_US&amp;docId=emr_na-c00821536</a> for details on using the HP Support Assistant to verify the battery capacity and, if necessary, order a replacement.
Wireless Module	Not installed or responding	701	Reseat the wireless LAN adapter module, if your notebook supports it.

Test description	Displayed message	Error code	Possible user actions
			Because seating or reseating a wireless LAN adapter is unique to each computer model. For more information, see the chapter titled "Removal and replacement procedures for Customer Self-Repair parts."
Fan	Fan not operating correctly	90B	<p>The system fan may be malfunctioning.</p> <p>For information on troubleshooting heat-related issues, see "HP Notebook PCs - Fan is Noisy and Spins Constantly, PC is Warmer than Normal" at <a href="http://support.hp.com/us-en/document/c01007591">http://support.hp.com/us-en/document/c01007591</a>.</p> <p>A hard reset can sometimes restore the system fan to working order. See "Use Hard Reset to Resolve Hardware and Software Issues" at <a href="http://h20566.www2.hp.com/hpsc/doc/public/display?docLocale=en_US&amp;docId=emr_na-c01684768">http://h20566.www2.hp.com/hpsc/doc/public/display?docLocale=en_US&amp;docId=emr_na-c01684768</a> for details.</p> <p>If the system fan continues to malfunction, contact support.</p>
Fan	System temperature	90D	System BIOS detected your computer was previously shut down to avoid overheating. Overheating may occur if the cooling vents are blocked or the operating temperature exceeds system specifications. The computer should return to normal operation once the situation is resolved.
Fan	fan speed failure	90F	<p>The system has detected that a cooling fan may not be working properly. Before continuing, perform the following steps:</p> <ul style="list-style-type: none"> <li>• Press <b>Enter</b> to clear the message and go to the Windows desktop.</li> <li>• Shutdown Windows.</li> <li>• While the computer is off, clean the vent exterior to remove dust build-up.</li> <li>• Check for a BIOS update.</li> </ul>

## Routine Maintenance for Performance Improvement

See "HP Notebook PCs - Improving the Performance of Your Computer" at [http://h20564.www2.hp.com/hpsc/doc/public/display?docLocale=en\\_US&docId=emr\\_na-c00816938](http://h20564.www2.hp.com/hpsc/doc/public/display?docLocale=en_US&docId=emr_na-c00816938).

The following table presents a summary of the suggested times for performing the routine maintenance tasks described in this document.

Tasks	Weekly	Monthly	Occasionally
Perform a system tune up.	X		
Run Windows Update.	X		
Scan for and remove viruses.	X		
Scan for and remove spyware and adware.	X		
Empty the Recycle Bin.	X		
Delete temporary Internet files.	X		
Back up user files.		X	
Create a restore point.		X	
Defragment the hard drive.		X	
Run Scan Disk.		X	

Tasks	Weekly	Monthly	Occasionally
Clean the exterior of the computer.			X
Close programs that are not being used.			X
Prevent programs from loading at startup.			X

## Common Blue Screen Error Messages

### Error message list

The following image shows an example of one possible Bug Check (Blue Screen) Code Reference from Microsoft at [https://msdn.microsoft.com/en-us/library/windows/hardware/hh994433\(v=vs.85\).aspx](https://msdn.microsoft.com/en-us/library/windows/hardware/hh994433(v=vs.85).aspx):

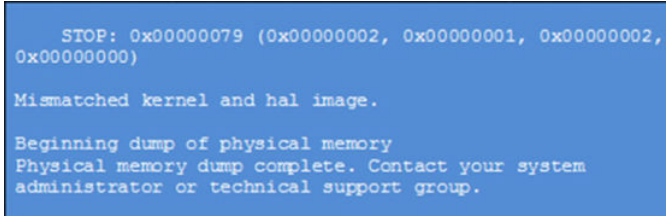

```

STOP: 0x00000079 (0x00000002, 0x00000001, 0x00000002,
0x00000000)

Mismatched kernel and hal image.

Beginning dump of physical memory
Physical memory dump complete. Contact your system
administrator or technical support group.

```

The hexadecimal number following the word "STOP" is called the bug check code or Stop code. This is the most important item on the screen.

### Bug check symbolic names

Each bug check code also has an associated symbolic name. In the example, the screen shows "bug check 0x79 (MISMATCHED\_HAL)". See [https://msdn.microsoft.com/en-us/library/windows/hardware/ff559209\(v=vs.85\).aspx](https://msdn.microsoft.com/en-us/library/windows/hardware/ff559209(v=vs.85).aspx).



## Microsoft general troubleshooting of Windows bug check codes

- If you recently added hardware to the system, try removing or replacing it. Or check with the manufacturer to see if any patches are available.
- Try running HP PC Hardware Diagnostics (UEFI).
- Check with the manufacturer to see if an updated system BIOS or firmware is available.
- Be sure that any expansion board is properly seated and all cables are completely connected.
- Confirm that any new hardware that is installed is compatible with the installed version of Windows.
- If new device drivers or system services have been added recently, try removing or updating them.



---

**NOTE:** Use safe mode when removing or disabling components. Safe mode loads only the minimum required drivers and system services during the Windows startup. To enter safe mode, restart your computer and press **F8** at the menu that displays the operating system choices. At the resulting **Windows Advanced Options** menu, choose **Safe Mode**.

---

- Run a virus detection program. Viruses can infect all types of hard drives formatted for Windows, and resulting drive corruption can generate system bug check codes. Be sure that the virus detection program checks the Master Boot Record for infections.
- Verify that the system has the latest service pack installed. To detect which service pack, if any, is installed on your system, click **Start**, click **Run**, type `winver`, and then press **Enter**. The **About Windows** dialog box displays the Windows version number and the version number of the service pack, if one has been installed.
- Disable BIOS memory options such as caching or shadowing.
- Check the System Log and Application Log in Event Viewer to see if any additional error messages have been logged recently. These might pinpoint the cause of the error.

## Use Windows Debugging Tool

The Windows Debugger ([https://msdn.microsoft.com/library/windows/hardware/ff551063%20\(v=vs.85\).aspx](https://msdn.microsoft.com/library/windows/hardware/ff551063%20(v=vs.85).aspx)) is one of the primary tools used by Microsoft software developers to analyze and resolve errors that result in memory dumps. Use the tool to determine the cause of the error. Follow general steps for downloading, setting up, and using the Windows 10 debugging tool. A similar process is used for Windows 7 or Windows 8.



---

**NOTE:** The following screen shots provide only an example of the tool. Specifics shown are not representative of all applications of the debugging tool. This is a Microsoft tool supported by Microsoft.

---

## Windows Software Development Kit (SDK)

1. Download the SDK from the following link:  
<https://dev.windows.com/en-US/downloads/windows-10-sdk>
2. Set up the SDK in the configuration window (Windows 10 shown).

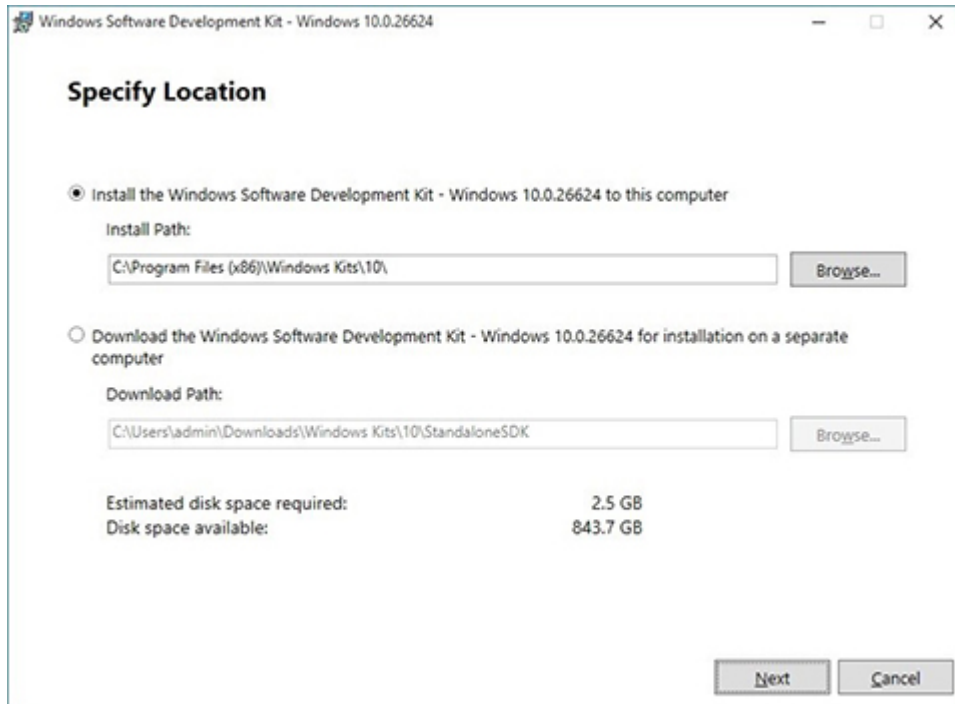

3. Select features to install.

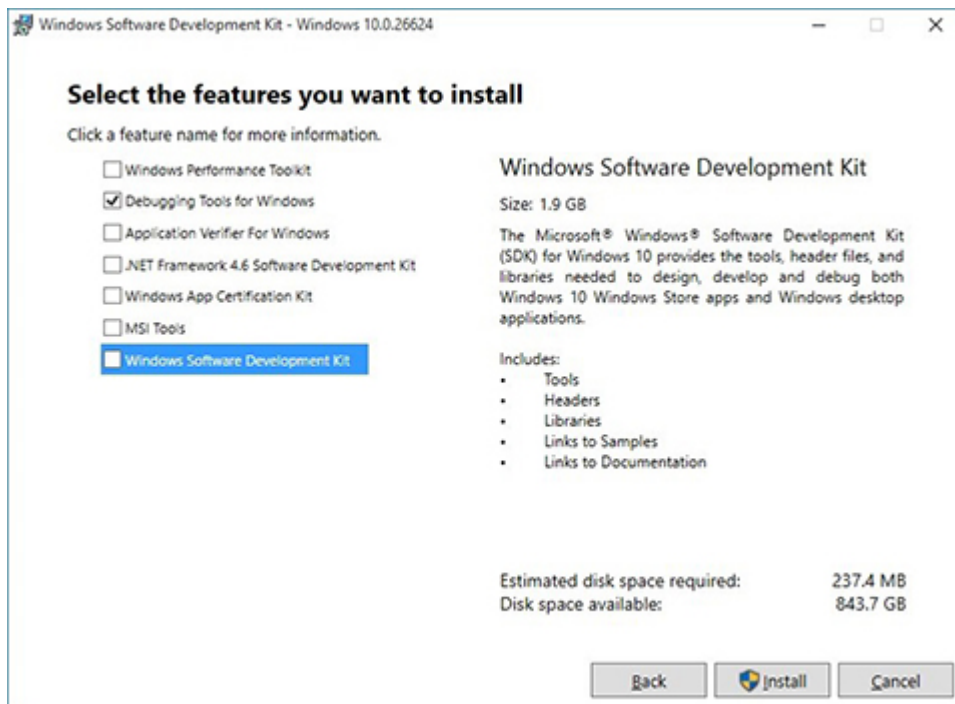

4. Run the SDK as an administrator.

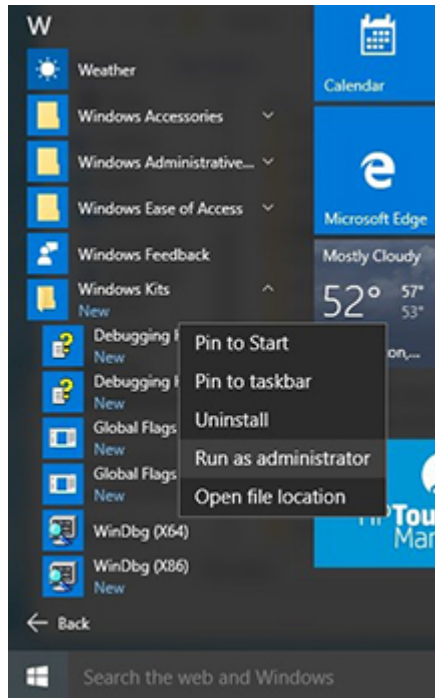

5. Set the symbol path. Select **File > Symbol File Path**.

- In the **Symbol path** box, type `SRV*C:\Windows\symbol_cache*http://msdl.microsoft.com/download/symbols`.
- Save the workspace.

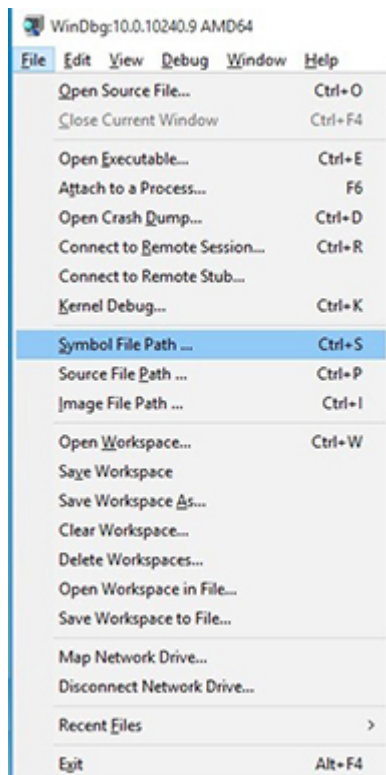

6. Open the crash dump file.

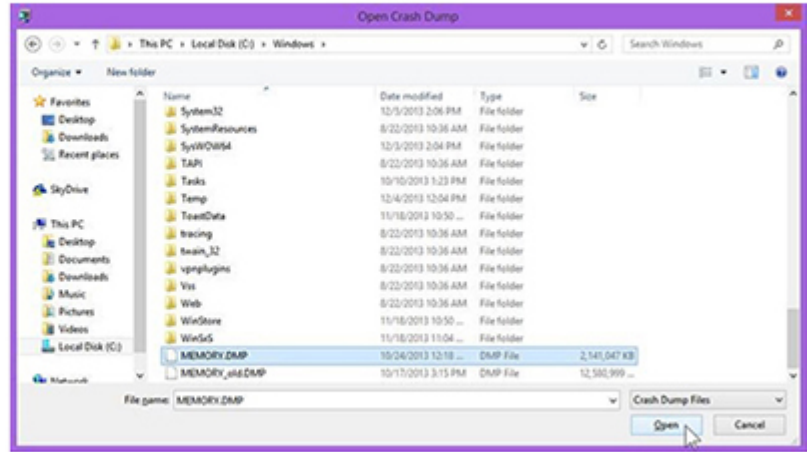
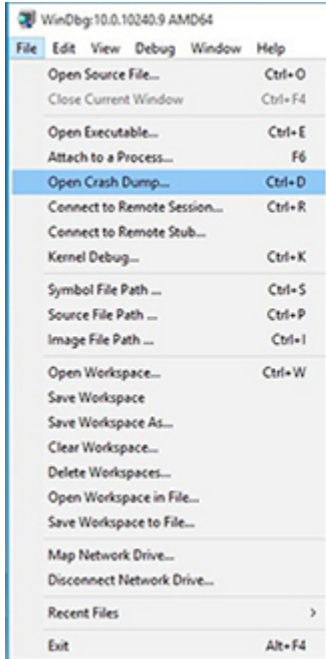

- Analyze the file. In the following memory dump sample, look for Bug Check 0x3B. The ATKMAG driver needs to be investigated for further root cause.

Lookup for Bug Check 0xC2.

```
1: kd> !analyze -v
.....
*
*                               Bugcheck Analysis
*
*
*
.....

SYSTEM_SERVICE_EXCEPTION (3b)
An exception happened while executing a system service routine.
Arguments:
Arg1: 0000000c00000005, Exception code that caused the bugcheck
Arg2: fffff8006d927acf, Address of the instruction which caused the bugcheck
Arg3: fffffd00020e4e500, Address of the context record for the exception that caused the bugcheck
Arg4: 0000000000000000, zero.

Debugging Details:
-----
BUGCHECK_P1: c0000005
BUGCHECK_P2: fffff8006d927acf
BUGCHECK_P3: fffffd00020e4e500
BUGCHECK_P4: 0
EXCEPTION_CODE: (NTSTATUS) 0xc0000005 - The instruction at 0x%p referenced memory at 0x%p. The memory

FAULTING_IP:
atikmpag+2facf
fffff800`6d927acf 4539bc2434030000 cmp     dword ptr [r12+334h],r15d
...

SYMBOL_STACK_INDEX: 0
SYMBOL_NAME: atikmpag+2facf
FOLLOWUP_NAME: MachineOwner
MODULE_NAME: atikmpag
IMAGE_NAME: atikmpag.sys
DEBUG_FLR_IMAGE_TIMESTAMP: 55479b42
STACK_COMMAND: .cxr 0xffffd00020e4e500 ; kb
BUCKET_ID_FUNC_OFFSET: 2facf
FAILURE_BUCKET_ID: 0x3B_atikmpag!Unknown_Function
BUCKET_ID: 0x3B_atikmpag!Unknown_Function
PRIMARY_PROBLEM_CLASS: 0x3B_atikmpag!Unknown_Function
ANALYSIS_SOURCE: KM
FAILURE_ID_HASH_STRING: km:0x3b_atikmpag!unknown_function
FAILURE_ID_HASH: {adb00875-801c-005a-68e8-645bb2f2c848}
```

```
Command - Dump C:\Windows\MEMORY.DMP - WinDbg.6.3.9600.16384 AMD64
.....
Loading User Symbols
Loading unloaded module list
.....
*
*                               Bugcheck Analysis
*
*
*
.....

Use !analyze -v to get detailed debugging information.
BugCheck C2, (7, 1205, 1159400, fffff0001137350)
*** ERROR: Module load completed but symbols could not be loaded for nldr.sys
Probably caused by : NETIO.SYS ( NETIO! ?? ::FNODOBFN::'string'+797c )

Followup: MachineOwner
-----
<
0: kd>
```

## Display Issue: Pixel Anomalies

All HP notebook displays adhere to strict quality and reliability specifications. A small percentage of display panels may have minor cosmetic manufacturing anomalies or irregularities such as bright or dark dots in the viewable area. These cosmetic imperfections are common to all display panel types and are not specific to any HP model or product line.

All display panel defects should be examined at the highest possible resolution using both the brightest and darkest possible backgrounds, because some sub-pixel failures may not be readily visible under certain conditions.

- Type 1: Bright dot on a dark background = Always On
- Type 2: Dark dot on a bright background = Always Off
- Combination = in any combination and any color that are always on or off

Use the HP PC Hardware Diagnostics (UEFI) tool to determine numbers of pixels and their distance. HP uses the following set of criteria when damaged displays are submitted for warranty coverage.

Source: HP Notebook PCs and Tablets - About LCD Panel Defects and Terminology for Notebook PCs and Tablets (<http://support.hp.com/us-en/document/c00035844>).

**Table 6-7 Electrical defect allowances**

Panel resolution	Accept	Reject
<b>Sub-pixel faults</b>		
VGA, SVGA, SD, WSVGA, XGA, 720p, SD+, WXGA, HD	N ≤ 2 Type 1 N ≤ 2 Type 2	N ≥ 3 Type 1
WXGA+, SXGA+, HD+, SXGA+	N ≤ 3 Type 1 N ≤ 3 Type 2	N ≥ 4 Type 1
WSXGA+, UXGA, FHD, WUXGA	N ≤ 4 Type 1 N ≤ 4 Type 2	N ≥ 5 Type 1
QHD, QHD+, WQXGA, UD	N ≤ 5 Type 1 N ≤ 5 Type 2	N ≥ 6 Type 1
<b>Electrical defect clusters (defects within a 5x5 pixel block)</b>		
Minimum distance between ANY allowable defects (unless otherwise specified)	S ≥ 25 mm	S < 25 mm
Cluster with 2 or more sub-pixels with sub-pixel faults		Not allowed
Dim lines		Not allowed
Cross line(s) on/off		Not allowed
Horizontal line(s) on/off		Not allowed
Vertical line(s) on/off		Not allowed

 **NOTE:** All LCD panel defects should be examined at the highest possible resolution using both the brightest and darkest possible backgrounds, as some sub-pixel failures may not be readily visible under certain conditions.

 **NOTE:** Contact support for assistance if issues are not listed.

## Cable management

Proper routing of the internal cables is critical to the operation of the computer. Follow good cable management practices when removing and installing components.

- Handle cables with care to avoid damage.
- Apply only the tension required to seat or unseat cables during insertion or removal from the connector.
- When possible, handle cables by the connector or pull-strap.
- Route cables in such a way that they cannot be caught or snagged by parts being removed or replaced.
- Keep cables away from direct contact with major heat sources, such as the heat sink. (Some air flow guides have a cable guide that lets you route cables safely around the heat sink.)
- Do not jam cables on top of daughterboards or memory modules (DIMMs). Circuit cards and DIMMs are not designed to take excessive pressure.
- Keep cables clear of any movable or rotating parts (such as a fan) to prevent them from being cut or crimped when the component is lowered into its normal position.
- In all cases, avoid bending or twisting the cables. Do not bend any cable sharply. A sharp bend can break the internal wires.
- Do not rely on components like the keyboard or service door to push cables down internally. Always position the cables to lay properly by themselves or in the cable guides and chassis areas designed for cable routing.

---

 **CAUTION:** Always release connector latch before removing the cable. Otherwise, pulling the cable could damage the cable pins and result in a failed device.

---

## Connector types

 **IMPORTANT:** Connector pins and connector gold fingers should not be touched directly with bare hands.

There are several different types of connectors on the system board with different requirements for cable removal or insertion.

### Flex cable

When connecting flex cables, push the cable completely, evenly into the connector.

When removing flex cables from a ZIF connector on the system board, always follow these steps:

1. Squeeze on the top of the retaining latch attached to the cable end of the connector.
2. Grasp the cable end of the connector and pull it straight out.

 **CAUTION:** Always release connector latch before removing the cable. Otherwise, pulling the cable could damage the cable pins and result in a failed device.

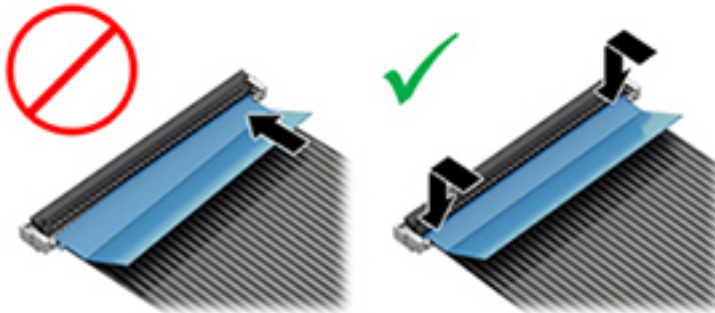

### Horizontal installation cable

Use flat tool to pull connector evenly. Do not pull on cable to remove.

Slide connector into receptacle on same horizontal plane as board and use flat tool to push evenly into receptacle.

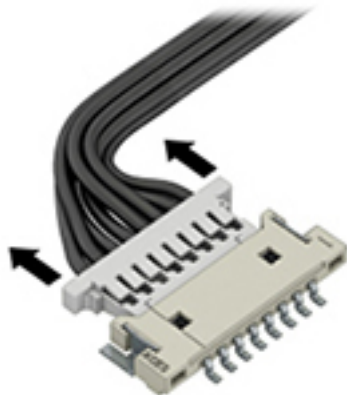



### Multi-pin horizontal insert connector (LVDS cable to display panel)

Insert procedure:

1. Slide connector evenly into receptacle on same horizontal plane as PCB connector.
2. Pull lock bar to insert and push both side connector horizontally to firmly lock.
3. Tape down lock bar over the panel to hold in position.

Reverse the procedure above to remove the connector:

1. Remove tape.
2. Pull up bar (pull tape) and release the lock with the PCB connector.
3. Pull to the direction in parallel with PCB to withdraw the connector.

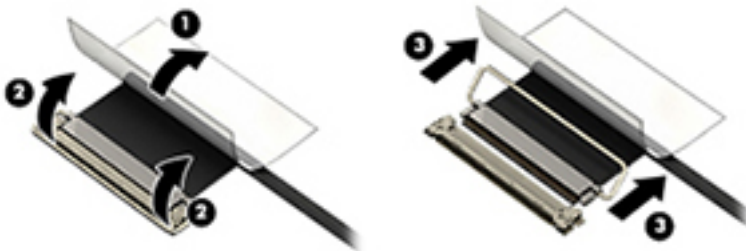

### Multi-pin vertical insert connector (LVDS cable to system board)

- Remove the connector gasket prior to removing the connector.
- Use flat tool under the connector to remove evenly. Do not pull on the cable to remove.
- Press evenly when reseating/reconnecting/installing the connector.

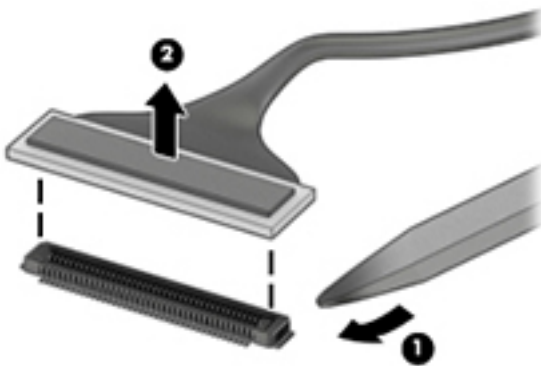

For more information about cable management, see [Cable management on page 149](#).

---

# 7 Computer Setup (BIOS), TPM, and HP Sure Start

## Using Computer Setup

Computer Setup, or Basic Input/Output System (BIOS), controls communication between all the input and output devices on the system (such as disk drives, display, keyboard, mouse, and printer). Computer Setup includes settings for the types of devices installed, the startup sequence of the computer, and the amount of system and extended memory.

 **NOTE:** Use extreme care when making changes in Computer Setup. Errors can prevent the computer from operating properly.

---

## Starting Computer Setup

- ▲ Turn on or restart the computer, and when the HP logo appears, press **f10** to enter Computer Setup.

## Using a USB keyboard or USB mouse to start Computer Setup (BIOS)

You can start Computer Setup by using a keyboard or mouse connected to a USB port, but you must first disable FastBoot.

1. Turn on or restart the computer, and when the HP logo appears, press **f9** to enter the Boot Device Options menu.
2. Clear the check box for **Fast Boot**.
3. To save your changes and exit, select the **Save** icon in the lower-right corner of the screen, and then follow the on-screen instructions.

– or –

Select **Main**, select **Save Changes and Exit**, and then press **enter**.

Your changes go into effect when the computer restarts.

## Navigating and selecting in Computer Setup

- To select a menu or a menu item, use the **tab** key and the keyboard arrow keys and then press **enter**, or use a pointing device to select the item.
- To scroll up and down, select the up arrow or the down arrow in the upper-right corner of the screen, or use the up arrow key or the down arrow key on the keyboard.
- To close open dialog boxes and return to the main Computer Setup screen, press **esc**, and then follow the on-screen instructions.

To exit Computer Setup menus, choose one of the following methods:

- To exit Computer Setup menus without saving your changes:  
Select the **Exit** icon in the lower-right corner of the screen, and then follow the on-screen instructions.  
– or –  
Select **Main**, select **Ignore Changes and Exit**, and then press [enter](#).
- To save your changes and exit Computer Setup menus:  
Select the **Save** icon in the lower-right corner of the screen, and then follow the on-screen instructions.  
– or –  
Select **Main**, select **Save Changes and Exit**, and then press [enter](#).

Your changes go into effect when the computer restarts.

## Restoring factory settings in Computer Setup

---

 **NOTE:** Restoring defaults will not change the hard drive mode.

---

To return all settings in Computer Setup to the values that were set at the factory, follow these steps:

1. Start Computer Setup. See [Starting Computer Setup on page 152](#).
2. Select **Main**, and then select **Apply Factory Defaults and Exit**.

---

 **NOTE:** On select products, the selections may display **Restore Defaults** instead of **Apply Factory Defaults and Exit**.

---

3. Follow the on-screen instructions.
4. To save your changes and exit, select the **Save** icon in the lower-right corner of the screen, and then follow the on-screen instructions.  
– or –  
Select **Main**, select **Save Changes and Exit**, and then press [enter](#).

Your changes go into effect when the computer restarts.

---

 **NOTE:** Your password settings and security settings are not changed when you restore the factory settings.

---

## Updating the BIOS

Updated versions of the BIOS may be available on the HP website.

Most BIOS updates on the HP website are packaged in compressed files called *SoftPaqs*.

Some download packages contain a file named *Readme.txt*, which contains information regarding installing and troubleshooting the file.

## Determining the BIOS version

To decide whether you need to update Computer Setup (BIOS), first determine the BIOS version on your computer.

BIOS version information (also known as *ROM date* and *System BIOS*) can be accessed by pressing [fn+esc](#) (if you are already in Windows) or by using Computer Setup.

1. Start Computer Setup. See [Starting Computer Setup on page 152](#).
2. Select **Main**, and then select **System Information**.
3. To exit Computer Setup without saving your changes, select the **Exit** icon in the lower-right corner of the screen, and then follow the on-screen instructions.

– or –

Select **Main**, select **Ignore Changes and Exit**, and then press [enter](#).

To check for later BIOS versions, see [Downloading a BIOS update on page 154](#).

## Downloading a BIOS update

---

 **CAUTION:** To reduce the risk of damage to the computer or an unsuccessful installation, download and install a BIOS update only when the computer is connected to reliable external power using the AC adapter. Do not download or install a BIOS update while the computer is running on battery power, docked in an optional docking device, or connected to an optional power source. During the download and installation, follow these instructions:

Do not disconnect power on the computer by unplugging the power cord from the AC outlet.

Do not shut down the computer or initiate Sleep.

Do not insert, remove, connect, or disconnect any device, cable, or cord.

---

1. Type `support` in the taskbar search box, and then select the HP Support Assistant app.  
– or –  
Select the question mark icon in the taskbar.
2. Select **Updates**, and then select **Check for updates and messages**.
3. Follow the on-screen instructions.
4. At the download area, follow these steps:
  - a. Identify the most recent BIOS update and compare it to the BIOS version currently installed on your computer. Make a note of the date, name, or other identifier. You may need this information to locate the update later, after it has been downloaded to your hard drive.
  - b. Follow the on-screen instructions to download your selection to the hard drive.  
Make a note of the path to the location on your hard drive where the BIOS update is downloaded. You will need to access this path when you are ready to install the update.

---

 **NOTE:** If you connect your computer to a network, consult the network administrator before installing any software updates, especially system BIOS updates.

---

BIOS installation procedures vary. Follow any instructions that are displayed on the screen after the download is complete. If no instructions are displayed, follow these steps:

1. Type `file` in the taskbar search box, and then select **File Explorer**.
2. Select your hard drive designation. The hard drive designation is typically Local Disk (C:).
3. Using the hard drive path you recorded earlier, open the folder that contains the update.
4. Double-click the file that has an `.exe` extension (for example, *filename.exe*).  
The BIOS installation begins.
5. Complete the installation by following the on-screen instructions.



---

**NOTE:** After a message on the screen reports a successful installation, you can delete the downloaded file from your hard drive.

---

## Changing the boot order using the f9 prompt

To dynamically choose a boot device for the current startup sequence, follow these steps:

1. Access the Boot Device Options menu:
  - Turn on or restart the computer, and when the HP logo appears, press **f9** to enter the Boot Device Options menu.
2. Select a boot device, press **enter**, and then follow the on-screen instructions.

## TPM BIOS settings (select products only)



---

**IMPORTANT:** Before enabling Trusted Platform Module (TPM) functionality on this system, you must ensure that your intended use of TPM complies with relevant local laws, regulations and policies, and approvals or licenses must be obtained if applicable. For any compliance issues arising from your operation/usage of TPM which violates the above mentioned requirement, you shall bear all the liabilities wholly and solely. HP will not be responsible for any related liabilities.

---

TPM provides additional security for your computer. You can modify the TPM settings in Computer Setup (BIOS).



---

**NOTE:** If you change the TPM setting to Hidden, TPM is not visible in the operating system.

---

To access TPM settings in Computer Setup:

1. Start Computer Setup. See [Starting Computer Setup on page 152](#).
2. Select **Security**, select **TPM Embedded Security**, and then follow the on-screen instructions.

## Using HP Sure Start (select products only)

Select computer models are configured with HP Sure Start, a technology that monitors the computer's BIOS for attacks or corruption. If the BIOS becomes corrupted or is attacked, HP Sure Start automatically restores the BIOS to its previously safe state, without user intervention.

HP Sure Start is configured and already enabled so that most users can use the HP Sure Start default configuration. The default configuration can be customized by advanced users.

To access the latest documentation on HP Sure Start, go to <http://www.hp.com/support>. Select **Find your product**, and then follow the on-screen instructions.

---

## 8 Using HP PC Hardware Diagnostics (UEFI)

HP PC Hardware Diagnostics is a Unified Extensible Firmware Interface (UEFI) that allows you to run diagnostic tests to determine whether the computer hardware is functioning properly. The tool runs outside the operating system so that it can isolate hardware failures from issues that are caused by the operating system or other software components.

When HP PC Hardware Diagnostics (UEFI) detects a failure that requires hardware replacement, a 24-digit Failure ID code is generated. This ID code can then be provided to support to help determine how to correct the problem.

---

 **NOTE:** To start diagnostics on a convertible computer, your computer must be in notebook mode and you must use the keyboard attached.

---

To start HP PC Hardware Diagnostics (UEFI), follow these steps:

1. Turn on or restart the computer, and quickly press *esc*.
2. Press *f2*.

The BIOS searches three places for the diagnostic tools, in the following order:

- a. Connected USB drive

---

 **NOTE:** To download the HP PC Hardware Diagnostics (UEFI) tool to a USB drive, see [Downloading HP PC Hardware Diagnostics \(UEFI\) to a USB device on page 156](#).

---

- b. Hard drive
- c. BIOS

3. When the diagnostic tool opens, select the type of diagnostic test you want to run, and then follow the on-screen instructions.

---

 **NOTE:** If you need to stop a diagnostic test, press *esc*.

---

### Downloading HP PC Hardware Diagnostics (UEFI) to a USB device

---

 **NOTE:** The HP PC Hardware Diagnostics (UEFI) download instructions are provided in English only, and you must use a Windows computer to download and create the HP UEFI support environment because only .exe files are offered.

---

There are two options to download HP PC Hardware Diagnostics to a USB device.

#### Download the latest UEFI version

1. Go to <http://www.hp.com/go/techcenter/pcdiags>. The HP PC Diagnostics home page is displayed.
2. In the HP PC Hardware Diagnostics section, select the **Download** link, and then select **Run**.

#### Download any version of UEFI for a specific product

1. Go to <http://www.hp.com/support>.
2. Select **Get software and drivers**.

3. Enter the product name or number.

– or –

Select **Identify now** to let HP automatically detect your product.

4. Select your computer, and then select your operating system.
5. In the **Diagnostic** section, follow the on-screen instructions to select and download the UEFI version you want.

#### **Additional BIOS crisis recovery tool**

HP provides a BIOS crisis recovery tool through the HP PC Hardware Diagnostics 3-in-1 USB key. This tool can be used by HP authorized service providers to recover systems that have failed due to a corrupted BIOS. For more information about using the 3-in-1 USB key for BIOS crisis recovery, go to <http://www.hp.com/go/techcenter/pcdiags>. Additional information is included in the web-based training offered by HP University. See the modules that cover HP PC Hardware Diagnostics (UEFI).

---

## 9 Backing up, restoring, and recovering

This chapter provides information about the following processes. The information in the chapter is standard procedure for most products.

- Creating recovery media and backups
- Restoring and recovering your system

For additional information, refer to the HP Support Assistant app.

▲ Type `support` in the taskbar search box, and then select the **HP Support Assistant** app.

– or –

Select the question mark icon in the taskbar.



**IMPORTANT:** If you will be performing recovery procedures on a tablet, the tablet battery must be at least 70% charged before you start the recovery process.

**IMPORTANT:** For a tablet with a detachable keyboard, connect the tablet to the keyboard base before beginning any recovery process.

---

### Creating recovery media and backups

The following methods of creating recovery media and backups are available on select products only. Choose the available method according to your computer model.

- Use HP Recovery Manager to create HP Recovery media after you successfully set up the computer. This step creates a backup of the HP Recovery partition on the computer. The backup can be used to reinstall the original operating system in cases where the hard drive is corrupted or has been replaced. For information on creating recovery media, see [Creating HP Recovery media \(select products only\) on page 158](#). For information on the recovery options that are available using the recovery media, see [Using Windows tools on page 159](#).
- Use Windows tools to create system restore points and create backups of personal information.

For more information, see [Recovering using HP Recovery Manager on page 160](#).



**NOTE:** If storage is 32 GB or less, Microsoft System Restore is disabled by default.

---

### Creating HP Recovery media (select products only)

If possible, check for the presence of the Recovery partition and the Windows partition. From the **Start** menu, select **File Explorer**, and then select **This PC**.

- If your computer does not list the Windows partition and the Recovery partition, you can obtain recovery media for your system from support. See the *Worldwide Telephone Numbers* booklet included with the computer. You can also find contact information on the HP website. Go to <http://www.hp.com/support>, select your country or region, and follow the on-screen instructions.



You can use Windows tools to create system restore points and create backups of personal information, see [Using Windows tools on page 159](#).

- If your computer does list the Recovery partition and the Windows partition, you can use HP Recovery Manager to create recovery media after you successfully set up the computer. HP Recovery media can be used to perform system recovery if the hard drive becomes corrupted. System recovery reinstalls the original operating system and software programs that were installed at the factory and then configures the settings for the programs. HP Recovery media can also be used to customize the system or restore the factory image if you replace the hard drive.
  - Only one set of recovery media can be created. Handle these recovery tools carefully, and keep them in a safe place.
  - HP Recovery Manager examines the computer and determines the required storage capacity for the media that will be required.
  - To create recovery discs, your computer must have an optical drive with DVD writer capability, and you must use only high-quality blank DVD-R, DVD+R, DVD-R DL, or DVD+R DL discs. Do not use rewritable discs such as CD±RW, DVD±RW, double-layer DVD±RW, or BD-RE (rewritable Blu-ray) discs; they are not compatible with HP Recovery Manager software. Or, instead, you can use a high-quality blank USB flash drive.
  - If your computer does not include an integrated optical drive with DVD writer capability, but you would like to create DVD recovery media, you can use an external optical drive (purchased separately) to create recovery discs. If you use an external optical drive, it must be connected directly to a USB port on the computer; the drive cannot be connected to a USB port on an external device, such as a USB hub. If you cannot create DVD media yourself, you can obtain recovery discs for your computer from HP. See the *Worldwide Telephone Numbers* booklet included with the computer. You can also find contact information on the HP website. Go to <http://www.hp.com/support>, select your country or region, and follow the on-screen instructions.
  - Be sure that the computer is connected to AC power before you begin creating the recovery media.
  - The creation process can take an hour or more. Do not interrupt the creation process.
  - If necessary, you can exit the program before you have finished creating all of the recovery DVDs. HP Recovery Manager will finish burning the current DVD. The next time you start HP Recovery Manager, you will be prompted to continue.

To create HP Recovery media:

---

 **IMPORTANT:** For a tablet with a detachable keyboard, connect the tablet to the keyboard base before beginning these steps.

---

1. Type `recovery` in the taskbar search box, and then select **HP Recovery Manager**.
2. Select **Create recovery media**, and then follow the on-screen instructions.

If you ever need to recover the system, see [Recovering using HP Recovery Manager on page 160](#).

## Using Windows tools

You can create recovery media, system restore points, and backups of personal information using Windows tools.

---

 **NOTE:** If storage is 32 GB or less, Microsoft System Restore is disabled by default.

---

For more information and steps, see the Get started app.

- ▲ Select the **Start** button, and then select the **Get started** app.

## Restore and recovery

There are several options for recovering your system. Choose the method that best matches your situation and level of expertise:

---

 **IMPORTANT:** Not all methods are available on all products.

---

- Windows offers several options for restoring from backup, refreshing the computer, and resetting the computer to its original state. For more information see the Get started app.
  - ▲ Select the **Start** button, and then select the **Get started** app.
- If you need to correct a problem with a preinstalled application or driver, use the Reinstall drivers and/or applications option (select products only) of HP Recovery Manager to reinstall the individual application or driver.
  - ▲ Type `recovery` in the taskbar search box, select **HP Recovery Manager**, select **Reinstall drivers and/or applications**, and then follow the on-screen instructions.
- If you want to recover the Windows partition to original factory content, you can choose the System Recovery option from the HP Recovery partition (select products only) or use the HP Recovery media. For more information, see [Recovering using HP Recovery Manager on page 160](#). If you have not already created recovery media, see [Creating HP Recovery media \(select products only\) on page 158](#).
- On select products, if you want to recover the computer's original factory partition and content, or if you have replaced the hard drive, you can use the Factory Reset option of HP Recovery media. For more information, see [Recovering using HP Recovery Manager on page 160](#).
- On select products, if you want to remove the Recovery partition to reclaim hard drive space, HP Recovery Manager offers the Remove Recovery Partition option.

For more information, see [Removing the HP Recovery partition \(select products only\) on page 163](#).

## Recovering using HP Recovery Manager

HP Recovery Manager software allows you to recover the computer to its original factory state by using the HP Recovery media that you either created or that you obtained from HP, or by using the HP Recovery partition (select products only). If you have not already created recovery media, see [Creating HP Recovery media \(select products only\) on page 158](#).

### What you need to know before you get started

- HP Recovery Manager recovers only software that was installed at the factory. For software not provided with this computer, you must either download the software from the manufacturer's website or reinstall the software from the media provided by the manufacturer.

---

 **IMPORTANT:** Recovery through HP Recovery Manager should be used as a final attempt to correct computer issues.

---

- HP Recovery media must be used if the computer hard drive fails. If you have not already created recovery media, see [Creating HP Recovery media \(select products only\) on page 158](#).
- To use the Factory Reset option (select products only), you must use HP Recovery media. If you have not already created recovery media, see [Creating HP Recovery media \(select products only\) on page 158](#).
- If your computer does not allow the creation of HP Recovery media or if the HP Recovery media does not work, you can obtain recovery media for your system from support. See the *Worldwide Telephone Numbers* booklet included with the computer. You can also find contact information from the HP

website. Go to <http://www.hp.com/support>, select your country or region, and follow the on-screen instructions.

---

 **IMPORTANT:** HP Recovery Manager does not automatically provide backups of your personal data. Before beginning recovery, back up any personal data you want to retain.

---

Using HP Recovery media, you can choose from one of the following recovery options:

---

 **NOTE:** Only the options available for your computer display when you start the recovery process.

---

- System Recovery—Reinstalls the original operating system, and then configures the settings for the programs that were installed at the factory.
- Factory Reset—Restores the computer to its original factory state by deleting all information from the hard drive and re-creating the partitions. Then it reinstalls the operating system and the software that was installed at the factory.

The HP Recovery partition (select products only) allows System Recovery only.

## Using the HP Recovery partition (select products only)

The HP Recovery partition allows you to perform a system recovery without the need for recovery discs or a recovery USB flash drive. This type of recovery can be used only if the hard drive is still working.

To start HP Recovery Manager from the HP Recovery partition:

---

 **IMPORTANT:** For a tablet with a detachable keyboard, connect the tablet to the keyboard base before beginning these steps (select products only).

---

1. Type `recovery` in the taskbar search box, select **Recovery Manager**, and then select **HP Recovery Environment**.

– or –

For computers or tablets with keyboards attached, press **f11** while the computer boots, or press and hold **f11** as you press the power button.

For tablets without keyboards:

- Turn on or restart the tablet, and then quickly hold down the volume up button; then select **f11**.
- or –
- Turn on or restart the tablet, and then quickly hold down the volume down button; then select **f11**.
2. Select **Troubleshoot** from the boot options menu.
  3. Select **Recovery Manager**, and then follow the on-screen instructions.

## Using HP Recovery media to recover

You can use HP Recovery media to recover the original system. This method can be used if your system does not have an HP Recovery partition or if the hard drive is not working properly.

1. If possible, back up all personal files.
2. Insert the HP Recovery media, and then restart the computer.

---

 **NOTE:** If the computer does not automatically restart in HP Recovery Manager, change the computer boot order. See [Changing the computer boot order on page 162](#).

---

3. Follow the on-screen instructions.

## Changing the computer boot order

If your computer does not restart in HP Recovery Manager, you can change the computer boot order, which is the order of devices listed in BIOS where the computer looks for startup information. You can change the selection to an optical drive or a USB flash drive.

To change the boot order:



---

**IMPORTANT:** For a tablet with a detachable keyboard, connect the tablet to the keyboard base before beginning these steps.

---

1. Insert the HP Recovery media.
2. Access the system **Startup** menu.

For computers or tablets with keyboards attached:

- ▲ Turn on or restart the computer or tablet, quickly press **esc**, and then press **f9** for boot options.

For tablets without keyboards:

- ▲ Turn on or restart the tablet, and then quickly hold down the volume up button; then select **f9**.

– or –

Turn on or restart the tablet, and then quickly hold down the volume down button; then select **f9**.

3. Select the optical drive or USB flash drive from which you want to boot.
4. Follow the on-screen instructions.

## Removing the HP Recovery partition (select products only)

HP Recovery Manager software allows you to remove the HP Recovery partition to free up hard drive space.

---

 **IMPORTANT:** After you remove the HP Recovery partition, you will not be able to perform System Recovery or create HP Recovery media from the HP Recovery partition. So before you remove the Recovery partition, create HP Recovery media; see [Creating HP Recovery media \(select products only\) on page 158](#).

---

 **NOTE:** The Remove Recovery Partition option is only available on products that support this function.

---

Follow these steps to remove the HP Recovery partition:

1. Type `recovery` in the taskbar search box, and then select **HP Recovery Manager**.
2. Select **Remove Recovery Partition**, and then follow the on-screen instructions.

# 10 Specifications

## Computer specifications

	Metric	U.S.
<b>Dimensions</b>		
Width	<b>386 mm</b>	15.2 in
Depth	<b>264 mm</b>	10.4 in
Height Dream Color (front)	<b>26.33 mm</b>	1.037 in
Height Touch (front)	<b>26.51 mm</b>	1.044 in
Weight (lightest panel, Core i5 CPU, Discrete Gfx, 8GBx1 SODIMM, SATA SSD, WLAN/BT, WWAN, non-FPR, 9-cell battery, backlit keyboard, TouchPad)	<b>2.63 kg</b>	5.79 lb
Weight (FHD touch anti-glare, Core i5 CPU, Discrete Gfx, 8GBx1 SODIMM, SATA SSD, WLAN/BT, WWAN, non-FPR, 9-cell battery, backlit keyboard, TouchPad)	<b>2.86 kg</b>	6.31 lb
Weight (Dream Color, Core i5 CPU, Discrete Gfx, 8GBx1 SODIMM, SATA SSD, WLAN/BT, WWAN, non-FPR, 9-cell battery, backlit keyboard, TouchPad)	<b>2.62 kg</b>	5.78 lb
<b>Input power</b>		
Operating voltage and current	19.5 V dc @ 7.69 A - 150 W, Slim Smart AC Adapter	
<b>Temperature</b>		
Operating	<b>5°C to 35°C</b>	41°F to 95°F
Nonoperating	<b>-20°C to 60°C</b>	-4°F to 140°F
<b>Relative humidity</b> (non-condensing)		
Operating	10% to 90%	
Nonoperating	5% to 95%	
<b>Maximum altitude</b> (unpressurized)		
Operating	<b>-15 m to 3,048 m</b>	-50 ft to 10,000 ft
Nonoperating	<b>-15 m to 12,192 m</b>	-50 ft to 40,000 ft
<b>NOTE:</b> Applicable product safety standards specify thermal limits for plastic surfaces. The device operates well within this range of temperatures.		

## Hard drive specifications

	1-TB*	500-GB**
<b>Dimensions</b>		
Height	9.5 mm	9.5 mm
Length	100.4 mm	100.4 mm
Width	69.9 mm	69.9 mm
Weight	110 g	110 g
<b>Interface type</b>	SATA	SATA
<b>Transfer rate</b>		
Synchronous (maximum)	1.1 GB/sec	1.1 GB/sec
Security	ATA security	ATA security
<b>Seek times</b> (typical read, including setting)		
Single track	1.5 ms	1.5 ms
Average (read/write)	11/13 ms	11/13 ms
Maximum	22 ms	22 ms
<b>Logical blocks</b>	1,953,525,168	976,773,168
<b>Disk rotational speed</b>	5400 rpm or 7200 rpm	5400 rpm or 7200 rpm
<b>Operating temperature</b>	0°C to 60°C (32°F to 140°F)	
*1 TB = 1 trillion bytes when referring to hard drive storage capacity. Actual accessible capacity is less.		
**1 GB = 1 billion bytes when referring to hard drive storage capacity. Actual accessible capacity is less.		
<b>NOTE:</b> Certain restrictions and exclusions apply. Contact technical support for details.		

## M.2 solid-state drive specifications

	256-GB*	512-GB*
<b>Dimensions</b>		
Height	1 mm	1 mm
Length	50.8 mm	50.8 mm
Width	28.9 mm	28.9 mm
Weight	< 10 g	< 10 g
<b>Interface type</b>	ATA-7	ATA-7
<b>Transfer rate</b>		
Sequential Read	Up to 540 MB/s	Up to 500 MB/s
Random Read	Up to 85K IOPs	Up to 84K IOPs
Sequential Write	Up to 280 MB/s	Up to 455 MB/s
Random Write	Up to 67K IOPs	Up to 59K IOPs
<b>Ready time, Maximum (to not busy)</b>	1.0 s	3.0 s
<b>Access times</b>		
Logical	0.1	0.1
<b>Total logical sectors</b>	500,118,192	1,000,215,216
<b>Operating temperature</b>		
Operating	0° to 70°C (32°F to 158°F)	0° to 70°C (32°F to 158°F)
Non-operating	-55° to 90°C (-67°F to 194°F)	-40° to 85°C (-40°F to 185°F)
*1 GB = 1 billion bytes when referring to hard drive storage capacity. Actual accessible capacity is less.		
<b>NOTE:</b> Certain restrictions and exclusions apply. Contact technical support for details.		



## M.2 PCIe solid-state drive specifications

	256-GB*	512-GB*	1-TB*
<b>Dimensions</b>			
Height	1 mm	1 mm	1 mm
Length	50.8 mm	50.8 mm	50.8 mm
Width	28.9 mm	28.9 mm	28.9 mm
Weight	< 10 g	< 10 g	< 10 g
<b>Interface type</b>	ATA-7	ATA-7	ATA-7
<b>Transfer rate</b>			
Sequential Read	Up to 2150 MB/s	Up to 2150 MB/s	Up to 2150 MB/s
Random Read	Up to 300,000 IOPs	Up to 300,000 IOPs	Up to 300,000 IOPs
Sequential Write	Up to 1260 MB/s	Up to 1550 MB/s	Up to 1550 MB/s
Random Write	Up to 100,000 IOPs	Up to 100,000 IOPs	Up to 100,000 IOPs
<b>Ready time, Maximum (to not busy)</b>	1.0 s	1.0 s	1.0 s
<b>Access times</b>			
Logical	0.1	0.1	0.1
<b>Total logical sectors</b>	500,118,192	1,000,215,216	1,500,336,388
<b>Operating temperature</b>			
Operating	0° to 70°C (32°F to 158°F)	0° to 70°C (32°F to 158°F)	0° to 70°C (32°F to 158°F)
Non-operating	-40° to 80°C (-40°F to 176°F)	-40° to 85°C (-40°F to 185°F)	-40° to 85°C (-40°F to 185°F)
*1 GB = 1 billion bytes when referring to hard drive storage capacity. Actual accessible capacity is less.			
<b>NOTE:</b> Certain restrictions and exclusions apply. Contact technical support for details.			

# 11 Statement of memory volatility

The purpose of this chapter is to provide general information regarding nonvolatile memory in HP Business computers. This chapter also provides general instructions for restoring nonvolatile memory that can contain personal data after the system has been powered off and the hard drive has been removed.

HP Business computer products that use Intel®-based or AMD®-based system boards contain volatile DDR memory. The amount of nonvolatile memory present in the system depends upon the system configuration. Intel-based and AMD-based system boards contain nonvolatile memory subcomponents as originally shipped from HP, assuming that no subsequent modifications have been made to the system and assuming that no applications, features, or functionality have been added to or installed on the system.

Following system shutdown and removal of all power sources from an HP Business computer system, personal data can remain on volatile system memory (DIMMs) for a finite period of time and will also remain in nonvolatile memory. Use the steps below to remove personal data from the computer, including the nonvolatile memory found in Intel-based and AMD-based system boards.

---

 **NOTE:** If your tablet has a keyboard base, connect to the keyboard base before beginning steps in this chapter.

---

## Current BIOS steps

1. Follow steps (a) through (l) below to restore the nonvolatile memory that can contain personal data. Restoring or reprogramming nonvolatile memory that does not store personal data is neither necessary nor recommended.
  - a. Turn on or restart the computer, and then press **esc** while the "Press the ESC key for Startup Menu" message is displayed at the bottom of the screen.

---

 **NOTE:** If the system has a BIOS administrator password, enter the password at the prompt.

---

- b. Select **Main**, select **Apply Factory Defaults and Exit**, and then select **Yes** to load defaults.  
The computer will reboot.
  - c. During the reboot, press **esc** while the "Press the ESC key for Startup Menu" message is displayed at the bottom of the screen.

---

 **NOTE:** If the system has a BIOS administrator password, enter the password at the prompt.

---

- d. Select the **Security** menu, select **Restore Security Settings to Factory Defaults**, and then select **Yes** to restore security level defaults.  
The computer will reboot.
  - e. During the reboot, press **esc** while the "Press the ESC key for Startup Menu" message is displayed at the bottom of the screen.

---

 **NOTE:** If the system has a BIOS administrator password, enter the password at the prompt.

---

- f. If an asset or ownership tag is set, select the **Security** menu and scroll down to the **Utilities** menu. Select **System IDs**, and then select **Asset Tracking Number**. Clear the tag, and then make the selection to return to the prior menu.



## Nonvolatile memory usage

Nonvolatile Memory Type	Amount (Size)	Does this memory store customer data?	Does this memory retain data when power is removed?	What is the purpose of this memory?	How is data input into this memory?	How is this memory write-protected?
HP Sure Start flash (select models only)	8 MBytes	No	Yes	Provides protected backup of critical System BIOS code, EC firmware, and critical computer configuration data for select platforms that support HP Sure Start.  For more information, see <a href="#">Using HP Sure Start (select models only) on page 173</a> .	Data cannot be written to this device via the host processor. The content is managed solely by the HP Sure Start Embedded Controller.	This memory is protected by the HP Sure Start Embedded Controller.
Real Time Clock (RTC) battery backed-up CMOS configuration memory	256 Bytes	No	Yes	Stores system date and time and noncritical data.	RTC battery backed-up CMOS is programmed using the Computer Setup (BIOS), or changing the Microsoft Windows date & time.	This memory is not write-protected.
Controller (NIC) EEPROM	64 KBytes (not customer accessible)	No	Yes	Stores NIC configuration and NIC firmware.	NIC EEPROM is programmed using a utility from the NIC vendor that can be run from DOS.	A utility is required to write data to this memory and is available from the NIC vendor. Writing data to this ROM in an inappropriate manner will render the NIC non-functional.
DIMM Serial Presence Detect (SPD) configuration data	256 Bytes per memory module, 128 Bytes programmable (not customer accessible)	No	Yes	Stores memory module information.	DIMM SPD is programmed by the memory vendor.	Data cannot be written to this memory when the module is installed in a computer. The specific write-protection method varies by memory vendor.
System BIOS	9 MBytes	Yes	Yes	Stores system BIOS code and computer configuration data.	System BIOS code is programmed at the factory. Code is updated when the system BIOS is updated. Configuration data and settings are input using the Computer Setup (BIOS) or a custom utility.	<b>NOTE:</b> Writing data to this ROM in an inappropriate manner can render the computer non-functional.  A utility is required for writing data to this memory and is available on the HP website; go to <a href="http://www.hp.com/support">http://www.hp.com/support</a> . Select <b>Find your</b>

Nonvolatile Memory Type	Amount (Size)	Does this memory store customer data?	Does this memory retain data when power is removed?	What is the purpose of this memory?	How is data input into this memory?	How is this memory write-protected?
Intel Management Engine Firmware (present only in select Elite or Z models. For more information, go to <a href="http://www.hp.com/support">http://www.hp.com/support</a> . Select <b>Find your product</b> , and then follow the on-screen instructions.)	1.5 MBytes or 7 MBytes	Yes	Yes	Stores Management Engine Code, Settings, Provisioning Data and iAMT third-party data store.	Management Engine Code is programmed at the factory. Code is updated via Intel secure firmware update utility. Unique Provisioning Data can be entered at the factory or by an administrator using the Management Engine (MEBx) setup utility. The third party data store contents can be populated by a remote management console or local applications that have been registered by an administrator to have access to the space.	<b>product</b> , and then follow the on-screen instructions.  The Intel chipset is configured to enforce hardware protection to block all direct read/write access to this area. An Intel utility is required for updating the firmware. Only firmware updates digitally signed by Intel can be applied using this utility.
Bluetooth flash (select products only)	2 Mbit	No	Yes	Stores Bluetooth configuration and firmware.	Bluetooth flash is programmed at the factory. Tools for writing data to this memory are not publicly available but can be obtained from the silicon vendor.	A utility is required for writing data to this memory and is made available through newer versions of the driver whenever the flash requires an upgrade.
802.11 WLAN EEPROM	4 Kbit to 8 Kbit	No	Yes	Stores configuration and calibration data.	802.11 WLAN EEPROM is programmed at the factory. Tools for writing data to this memory are not made public.	A utility is required for writing data to this memory and is typically not made available to the public unless a firmware upgrade is necessary to address a unique issue.
Camera (select products only)	64 Kbit	No	Yes	Stores camera configuration and firmware.	Camera memory is programmed using a utility from the device manufacturer that can be run from Windows.	A utility is required for writing data to this memory and is typically not made available to the public unless a firmware upgrade is necessary to address a unique issue.
Fingerprint reader (select products only)	512 KByte flash	Yes	Yes	Stores fingerprint templates.	Fingerprint reader memory is programmed by user enrollment in HP ProtectTools Security Manager.	Only a digitally signed application can make the call to write to the flash.

## Questions and answers

### 1. How can the BIOS settings be restored (returned to factory settings)?



**IMPORTANT:** Restore defaults does not securely erase any data on your hard drive. See question and answer 6 for steps to securely erase data.

Restore defaults does not reset the Custom Secure Boot keys. See question and answer 7 for information about resetting the keys.

- a. Turn on or restart the computer, and then press **esc** while the "Press the ESC key for Startup Menu" message is displayed at the bottom of the screen.
- b. Select **Main**, and then select **Apply Factory Defaults and Exit**.
- c. Follow the on-screen instructions.
- d. Select **Main**, select **Save Changes and Exit**, and then follow the on-screen instructions.

### 2. What is a UEFI BIOS, and how is it different from a legacy BIOS?

The Unified Extensible Firmware Interface (UEFI) BIOS is an industry-standard software interface between the platform firmware and an operating system (OS). It is a replacement for the older BIOS architecture, but supports much of the legacy BIOS functionality.

Like the legacy BIOS, the UEFI BIOS provides an interface to display the system information and configuration settings and to change the configuration of your computer before an OS is loaded. BIOS provides a secure run-time environment that supports a Graphic User Interface (GUI). In this environment, you can use either a pointing device (Touchscreen, TouchPad, pointing stick, or USB mouse) or the keyboard to navigate and make menu and configuration selections. The UEFI BIOS also contains basic system diagnostics.

The UEFI BIOS provides functionality beyond that of the legacy BIOS. In addition, the UEFI BIOS works to initialize the computer's hardware before loading and executing the OS; the run-time environment allows the loading and execution of software programs from storage devices to provide more functionality, such as advanced hardware diagnostics (with the ability to display more detailed system information) and advanced firmware management and recovery software.

HP has provided options in Computer Setup (BIOS) to allow you to run in legacy BIOS, if required by the operating system. Examples of this requirement would be if you upgrade or downgrade the OS.

### 3. Where does the UEFI BIOS reside?

The UEFI BIOS resides on a flash memory chip. A utility is required to write to the chip.

### 4. What kind of configuration data is stored on the DIMM Serial Presence Detect (SPD) memory module? How would this data be written?

The DIMM SPD memory contains information about the memory module, such as size, serial number, data width, speed/timing, voltage, and thermal information. This information is written by the module manufacturer and stored on an EEPROM. This EEPROM cannot be written to when the memory module is installed in a computer. Third-party tools do exist that can write to the EEPROM when the memory module is not installed in a computer. Various third-party tools are available to read SPD memory.

### 5. What is meant by "Restore the nonvolatile memory found in Intel-based system boards"?

This message relates to clearing the Real Time Clock (RTC) CMOS memory that contains computer configuration data.

### 6. How can the BIOS security be reset to factory defaults and data erased?

---

 **IMPORTANT:** Resetting will result in the loss of information.

These steps will not reset Custom Secure Boot Keys. See question and answer 7 for information about resetting the keys.

---

- a. Turn on or restart the computer, and then press **esc** while the "Press the ESC key for Startup Menu" message is displayed at the bottom of the screen.
- b. Select **Main**, and then select **Reset Security to Factory Defaults**.
- c. Follow the on-screen instructions.
- d. Select **Main**, select **Save Changes and Exit**, and then follow the on-screen instructions.

#### 7. How can the Custom Secure Boot Keys be reset?

Secure Boot is a feature to ensure that only authenticated code can start on a platform. If you enabled Secure Boot and created Custom Secure Boot Keys, simply disabling Secure Boot will not clear the keys. You must also select to clear the Custom Secure Boot Keys. Use the same Secure Boot access procedure you used to create the Custom Secure Boot Keys, but make the selection to clear or delete all Secure Boot Keys.

- a. Turn on or restart the computer, and then press **esc** while the "Press the ESC key for Startup Menu" message is displayed at the bottom of the screen.
- b. Select the **Security** menu, select **Secure Boot Configuration**, and then follow the on-screen instructions.
- c. At the **Secure Boot Configuration** window, select **Secure Boot**, select **Clear Secure Boot Keys**, and then follow the on-screen instructions to continue.

## Using HP Sure Start (select models only)

Select computer models are configured with HP Sure Start, a technology that continuously monitors your computer's BIOS for attacks or corruption. If the BIOS becomes corrupted or is attacked, HP Sure Start restores the BIOS to its previously safe state, without user intervention. Those select computer models ship with HP Sure Start configured and enabled. HP Sure Start is configured and already enabled so that most users can use the HP Sure Start default configuration. The default configuration can be customized by advanced users.

To access the latest documentation on HP Sure Start, go to <http://www.hp.com/support>. Select **Find your product**, and then follow the on-screen instructions.

---

## 12 Power cord set requirements

The wide-range input feature of the computer permits it to operate from any line voltage from 100 to 120 volts AC, or from 220 to 240 volts AC.

The 3-conductor power cord set included with the computer meets the requirements for use in the country or region where the equipment is purchased.

Power cord sets for use in other countries and regions must meet the requirements of the country or region where the computer is used.

### Requirements for all countries

The following requirements are applicable to all countries and regions:

- The length of the power cord set must be at least 1.0 m (3.3 ft) and no more than 2.0 m (6.5 ft).
- All power cord sets must be approved by an acceptable accredited agency responsible for evaluation in the country or region where the power cord set will be used.
- The power cord sets must have a minimum current capacity of 10 amps and a nominal voltage rating of 125 or 250 V AC, as required by the power system of each country or region.
- The appliance coupler must meet the mechanical configuration of an EN 60 320/IEC 320 Standard Sheet C13 connector for mating with the appliance inlet on the back of the computer. Requirements for all countries 113



## Requirements for specific countries and regions

Country/region	Accredited agency	Applicable note number
Argentina	IRAM	1
Australia	SAA	1
Austria	OVE	1
Belgium	CEBEC	1
Brazil	ABNT	1
Canada	CSA	2
Chile	IMQ	1
Denmark	DEMKO	1
Finland	FIMKO	1
France	UTE	1
Germany	VDE	1
India	ISI	1
Israel	SII	1
Italy	IMQ	1
Japan	JIS	3
The Netherlands	KEMA	1
New Zealand	SANZ	1
Norway	NEMKO	1
The People's Republic of China	CCC	4
Saudi Arabia	SASO	7
Singapore	PSB	1
South Africa	SABS	1
South Korea	KTL	5
Sweden	SEMKO	1
Switzerland	SEV	1
Taiwan	BSMI	6
Thailand	TISI	1
The United Kingdom	ASTA	1
The United States	UL	2

1. The flexible cord must be Type H05VV-F, 3-conductor, 0.75 mm<sup>2</sup> conductor size. Power cord set fittings (appliance coupler and wall plug) must bear the certification mark of the agency responsible for evaluation in the country or region where it will be used.
2. The flexible cord must be Type SVT/SJT or equivalent, No. 18 AWG, 3-conductor. The wall plug must be a two-pole grounding type with a NEMA 5-15P (15 A, 125 V ac) or NEMA 6-15P (15 A, 250 V ac) configuration. CSA or C-UL mark. UL file number must be on each element.

Country/region	Accredited agency	Applicable note number
3.	The appliance coupler, flexible cord, and wall plug must bear a “T” mark and registration number in accordance with the Japanese Dentori Law. The flexible cord must be Type VCTF, 3-conductor, 0.75 mm <sup>2</sup> or 1.25 mm <sup>2</sup> conductor size. The wall plug must be a two-pole grounding type with a Japanese Industrial Standard C8303 (7 A, 125 V ac) configuration.	
4.	The flexible cord must be Type RVV, 3-conductor, 0.75 mm <sup>2</sup> conductor size. Power cord set fittings (appliance coupler and wall plug) must bear the CCC certification mark.	
5.	The flexible cord must be Type H05VV-F 3-conductor, 0.75 mm <sup>2</sup> conductor size. KTL logo and individual approval number must be on each element. Corset approval number and logo must be printed on a flag label.	
6.	The flexible cord must be Type HVCTF 3-conductor, 1.25 mm <sup>2</sup> conductor size. Power cord set fittings (appliance coupler, cable, and wall plug) must bear the BSMI certification mark.	
7.	For 127 V ac, the flexible cord must be Type SVT or SJT 3-conductor, 18 AWG, with plug NEMA 5-15P (15 A, 125 V ac), with UL and CSA or C-UL marks. For 240 V ac, the flexible cord must be Type H05VV-F 3-conductor, 0.75 mm <sup>2</sup> or 1.00 mm <sup>2</sup> conductor size, with plug BS 1363/A with BSI or ASTA marks.	

---

## 13 Recycling

When a non-rechargeable or rechargeable battery has reached the end of its useful life, do not dispose of the battery in general household waste. Follow the local laws and regulations in your area for battery disposal.

HP encourages customers to recycle used electronic hardware, HP original print cartridges, and rechargeable batteries. For more information about recycling programs, see the HP Web site at <http://www.hp.com/recycle>.

# Index

- A**
  - AC adapter, spare part numbers 26
  - action keys
    - using 14
  - action keys, identifying 13
  - Antenna Kit, WLAN
    - spare part number 23
  - Antenna Kit, WWAN
    - spare part number 23
  - audio, product description 3
  - audio-out (headphone)/audio-in (microphone) combo jack, identifying 6
- B**
  - backups 158
  - battery
    - removal 37
    - spare part numbers 19, 37
  - battery light 7, 16
  - BIOS
    - determining version 153
    - downloading an update 154
    - updating 153
  - Blu-ray R/RE DVD±RW SuperMulti Double-Layer Drive
    - precautions 28
  - Blu-ray ROM DVD±RW SuperMulti Double-Layer Drive
    - precautions 28
  - Bluetooth label 17
  - boot order
    - changing 162
    - changing using the f9 prompt 155
  - bottom 17
  - bottom cover
    - removal 36
    - spare part number 21, 36
  - Bracket Kit
    - components 21
    - spare part number 21
  - buttons
    - center TouchPad 10
    - left TouchPad 10
    - power 12
    - right TouchPad 10
- C**
  - Cable Kit
    - components 23
    - spare part number 23
  - cables, service considerations 28
  - camera 9
  - camera light, identifying 9
  - camera, identifying 9
  - camera/microphone module
    - removal 34, 69
    - spare part number 22, 35, 70
  - caps lock light, identifying 11
  - chipset, product description 1
  - components
    - bottom 15
    - display 9
    - front 16
    - left side 8
    - right side 6
    - top 10
  - computer
    - major components 18
    - specifications 164
  - Computer Setup
    - navigating and selecting 152
    - restoring factory settings 153
    - using a USB keyboard or USB mouse to start Computer Setup 152
  - computer setup 152
  - connector, power 7
  - connectors, service considerations 28
- D**
  - display assembly
    - removal 65
    - spare part numbers 19, 65
  - display bezel
    - removal 32, 66
    - spare part numbers 22, 33, 67
  - display panel
    - product description 2
    - removal 33, 67
    - spare part numbers 22
  - display rear cover
    - spare part number 23
  - display subcomponents
    - removal 32
    - spare part numbers 32
  - display/camera cable
    - removal 70
  - Display/Camera Cable Kit
    - spare part number 23
  - DisplayPort
    - identifying USB Type-C 7
  - docking
    - product description 4
  - drive light 16
  - drives, preventing damage 28
  - DVD-ROM Drive
    - precautions 28
  - DVD±RW SuperMulti Double-Layer Drive
    - precautions 28
- E**
  - EDP bracket
    - illustrated 21
  - electrostatic discharge 28
  - equipment guidelines 31
  - esc key, identifying 13
  - Ethernet, product description 3
  - external monitor port 8
- F**
  - fan
    - removal 60
    - spare part number 20
    - spare part numbers 60
  - fingerprint reader bezel, illustrated 24
  - fingerprint reader board
    - removal 61
    - spare part number 19, 61

fingerprint reader board bracket  
  illustrated 21  
  removal 61  
fingerprint reader, identifying 13  
fn key, identifying 13

## G

graphics board  
  removal 56  
  spare part numbers 19, 56  
graphics, product description 1  
grounding guidelines 28  
guidelines  
  equipment 31  
  grounding 28  
  packaging 30  
  transporting 30  
  workstation 30

## H

hard drive  
  precautions 28  
  product description 3  
  removal 46  
  spare part numbers 19, 25, 46  
  specifications 165  
hard drive bracket  
  illustrated 26  
  removal 47  
Hard Drive Hardware Kit  
  contents 26  
  spare part number 19, 26  
HDMI port, identifying 6  
heat sink assembly  
  removal 52  
  spare part numbers 20, 52  
hinge  
  removal 70  
  spare part number 23, 70, 71  
hot keys  
  microphone mute 14  
HP PC Hardware Diagnostics (UEFI)  
  using 156  
HP Recovery Manager  
  correcting boot problems 162  
  starting 161  
HP Recovery media  
  creating 158  
  recovery 161

HP Recovery partition  
  recovery 161  
  removing 163  
HP Sure Start 173

## I

integrated camera light, identifying 9  
integrated numeric keypad,  
  identifying 13  
internal microphones, identifying 9

## J

jacks  
  audio-out (headphone)/audio-in  
  (microphone) combo 6  
  network 8  
  RJ-45 (network) 8

## K

keyboard  
  product description 4  
  removal 49  
  spare part numbers 19, 49  
keypad  
  integrated numeric 13  
keys  
  esc 13  
  fn 13  
  Windows key 13

## L

labels  
  Bluetooth 17  
  regulatory 17  
  serial number 17  
  service 17  
  wireless certification 17  
  WLAN 17  
LED board  
  removal 59  
  spare part number 19  
lights  
  battery 7, 16  
  camera 9  
  caps lock 11  
  drive 16  
  microphone mute 11  
  num lock 11  
  power 11, 16  
  RJ-45 (network) 8

TouchPad 11  
  wireless 11, 16  
lock bracket  
  removal 73

## M

M.2 solid-state drive  
  specifications 166, 167  
mass storage device  
  illustrated 25  
  precautions 28  
  spare part numbers 25  
memory  
  nonvolatile 168  
  volatile 168  
memory card reader, identifying 8  
memory module  
  product description 2  
  removal 38  
  spare part numbers 19, 38  
microphone  
  product description 3  
microphone module  
  removal 34, 69  
  spare part number 22, 35, 70  
microphone mute key, identifying 14  
microphone mute light, identifying 11  
minimized image recovery 161  
minimized image, creating 160  
model name 1

## N

network jack, identifying 8  
nonvolatile memory 168  
num lock light 11

## O

operating system, product  
  description 5  
optical drive  
  precautions 28  
original system recovery 160

## P

packaging guidelines 30  
plastic parts, service  
  considerations 27

- Plastics Kit
    - components 24
    - spare part number 24
  - pointing device, product description 4
  - pointing stick 10
  - pointing stick cable
    - illustrated 23
  - ports
    - external monitor 8
    - HDMI 6
    - product description 4
    - USB 3.x charging 8
    - USB 3.x SuperSpeed 6
    - USB Type-C SuperSpeed 7
    - USB Type-C Thunderbolt 7
  - power button, identifying 12
  - power connector, identifying 7
  - power cord
    - requirements for specific countries and regions 175
    - set requirements 174
    - spare part numbers 26
  - power lights 11, 16
  - power requirements, product description 4
  - primary M.2
    - product description 2
  - processor
    - product description 1
  - product description
    - audio 3
    - chipset 1
    - display panel 2
    - docking 4
    - Ethernet 3
    - external media cards 4
    - graphics 1
    - hard drive 3
    - keyboard 4
    - memory module 2
    - microphone 3
    - operating system 5
    - pointing device 4
    - ports 4
    - power requirements 4
    - processor 1
    - product name 1
    - security 4
    - serviceability 5
    - solid-state drive 2
    - video 3
    - wireless 3
  - product name 1
  - product name and number, computer 17
- R**
- recover
    - options 160
  - recovery
    - discs 159, 161
    - HP Recovery Manager 160
    - media 161
    - starting 161
    - supported discs 159
    - system 160
    - USB flash drive 161
    - using HP Recovery media 159
  - recovery media
    - creating 158
    - creating using HP Recovery Manager 159
  - recovery partition
    - removing 163
  - regulatory information
    - regulatory label 17
    - wireless certification labels 17
  - removal/replacement
    - procedures 32
  - removing personal data from volatile system memory 168
  - RJ-45 (network) jack, identifying 8
  - RJ-45 (network) lights, identifying 8
  - RTC battery
    - removal 48
    - spare part number 19, 48
- S**
- Screw Kit, spare part number 26
  - SD card reader insert, illustrated 24
  - secondary M.2
    - product description 2
  - security cable slot, identifying 8
  - security, product description 4
  - serial number 17
  - serial number, computer 17
  - service considerations
    - cables 28
    - connectors 28
    - plastic parts 27
  - service labels, locating 17
  - serviceability, product description 5
  - setup utility
    - navigating and selecting 152
    - restoring factory settings 153
  - slots
    - security cable 8
    - smart card 6
  - smart card bracket
    - illustrated 21
  - smart card reader
    - removal 45
    - spare part number 19, 45
  - smart card slot 6
  - solid-state drive
    - precautions 28
    - product description 2
    - removal 40
    - spare part numbers 20, 25, 40
  - Speaker Kit, spare part number 19
  - speakers
    - removal 57
    - spare part number 19, 57
  - speakers, identifying 15, 16
  - specifications
    - computer 164
    - hard drive 165
    - M.2 solid-state drive 166, 167
    - supported discs, recovery 159
  - Sure Start
    - using 155
  - system board
    - removal 62
    - spare part numbers 20, 62
  - system memory, removing personal data from volatile 168
  - system recovery 160
  - system restore point
    - creating 159
  - system restore point, creating 158
- T**
- Thunderbolt
    - identifying USB Type-C 7
  - tools required 27
  - top cover
    - spare part number 19

- TouchPad
  - buttons 10
- TouchPad cable
  - illustrated 23
- TouchPad light, identifying 10, 11
- TouchPad module
  - removal 58
  - spare part number 19, 58
- TouchPad on/off button,
  - identifying 10
- TouchPad zone
  - identifying 10
- TPM settings 155
- transporting guidelines 30
- traveling with the computer 17

- WWAN module
  - removal 43
  - spare part numbers 20, 43

## U

- USB 3.x charging port, identifying 8
- USB 3.x SuperSpeed port,
  - identifying 6
- USB Type-C SuperSpeed port,
  - identifying 7
- USB Type-C Thunderbolt port,
  - identifying 7
- USB-C bracket
  - illustrated 21

## V

- vents, identifying 15
- VGA cap, illustrated 24
- video, product description 3

## W

- Windows
  - system restore point 158, 159
- Windows key, identifying 13
- Windows tools
  - using 159
- wireless antennas, identifying 9
- wireless certification label 17
- wireless light 11, 16
- wireless, product description 3
- WLAN antennas, identifying 9
- WLAN device 17
- WLAN label 17
- WLAN module
  - removal 41
  - spare part numbers 20, 41
- workstation guidelines 30
- WWAN antennas, identifying 9