



# HP 250 G6 Notebook PC

## Maintenance and Service Guide

© Copyright 2017 HP Development Company, L.P.

AMD is a trademark of Advanced Micro Devices, Inc. Bluetooth is a trademark owned by its proprietor and used by HP Inc. under license. Intel, Celeron, and Pentium are trademarks of Intel Corporation in the U.S. and other countries. Microsoft and Windows are U.S. registered trademarks of the Microsoft group of companies.

In accordance with Microsoft's support policy, HP does not support the Windows 8 or Windows 7 operating system on products configured with Intel and AMD 7th generation and forward processors or provide any Windows 8 or Windows 7 drivers on <http://www.support.hp.com>.

The information contained herein is subject to change without notice. The only warranties for HP products and services are set forth in the express warranty statements accompanying such products and services. Nothing herein should be construed as constituting an additional warranty. HP shall not be liable for technical or editorial errors or omissions contained herein.

First Edition: April 2017

Document Part Number: 926816-001

## Product notice

This guide describes features that are common to most models. Some features may not be available on your computer.

Not all features are available in all editions or versions of Windows. Systems may require upgraded and/or separately purchased hardware, drivers, software or BIOS update to take full advantage of Windows functionality. Windows 10 is automatically updated, which is always enabled. ISP fees may apply and additional requirements may apply over time for updates. Go to <http://www.microsoft.com> for details.

To access the latest user guides or manuals for your product, go to <http://www.hp.com/support>, and select your country. Select **Find your product**, and then follow the on-screen instructions.

## Software terms

By installing, copying, downloading, or otherwise using any software product preinstalled on this computer, you agree to be bound by the terms of the HP End User License Agreement (EULA). If you do not accept these license terms, your sole remedy is to return the entire unused product (hardware and software) within 14 days for a full refund subject to the refund policy of your seller.

For any further information or to request a full refund of the price of the computer, please contact your seller.

## Safety warning notice

---

 **WARNING!** To reduce the possibility of heat-related injuries or of overheating the device, do not place the device directly on your lap or obstruct the device air vents. Use the device only on a hard, flat surface. Do not allow another hard surface, such as an adjoining optional printer, or a soft surface, such as pillows or rugs or clothing, to block airflow. Also, do not allow the AC adapter to contact the skin or a soft surface, such as pillows or rugs or clothing, during operation. The device and the AC adapter comply with the user-accessible surface temperature limits defined by the International Standard for Safety of Information Technology Equipment (IEC 60950-1).

---



---

# Table of contents

<b>1 Product description .....</b>	<b>1</b>
<b>2 Components .....</b>	<b>7</b>
Right .....	7
Left .....	8
Display .....	10
Keyboard area .....	11
TouchPad .....	11
Lights .....	12
Button .....	13
Special keys .....	14
Action keys .....	15
Bottom .....	16
Labels .....	17
<b>3 Illustrated parts catalog .....</b>	<b>19</b>
Computer major components .....	19
Display assembly subcomponents .....	23
Cables .....	24
Mass storage devices .....	25
Miscellaneous parts .....	26
<b>4 Removal and replacement procedures preliminary requirements .....</b>	<b>27</b>
Tools required .....	27
Service considerations .....	27
Plastic parts .....	27
Cables and connectors .....	27
Drive handling .....	28
Grounding guidelines .....	28
Electrostatic discharge damage .....	28
Packaging and transporting guidelines .....	29
Workstation guidelines .....	29
<b>5 Removal and replacement procedures for Customer Self-Repair parts .....</b>	<b>31</b>
Component replacement procedures .....	31
Battery .....	32

Optical drive .....	33
---------------------	----

**6 Removal and replacement procedures for Authorized Service Provider parts ..... 35**

Component replacement procedures .....	35
Display subcomponents (bezel, panel, camera) .....	35
Rubber feet .....	39
Bottom cover .....	40
WLAN module .....	43
Memory module .....	45
Optical drive connector board .....	47
Hard drive and hard drive connector board .....	48
M.2 solid-state drive adapter bracket and connector board .....	51
Solid-state drive (SSD) .....	53
RTC battery .....	54
Speakers .....	55
USB board .....	56
Fan .....	57
Heat sink assembly .....	59
TouchPad button board .....	63
System board .....	64
Display assembly .....	66
Power connector cable .....	76
Power button board .....	77
Cable locations .....	78
Top cover/keyboard .....	79

**7 Computer Setup (BIOS), TPM, and HP Sure Start ..... 81**

Using Computer Setup .....	81
Starting Computer Setup .....	81
Using a USB keyboard or USB mouse to start Computer Setup (BIOS) .....	81
Navigating and selecting in Computer Setup .....	81
Restoring factory settings in Computer Setup .....	82
Updating the BIOS .....	82
Determining the BIOS version .....	82
Downloading a BIOS update .....	83
Changing the boot order using the f9 prompt .....	84
TPM BIOS settings (select products only) .....	84
Using HP Sure Start (select products only) .....	84

<b>8 Backing up, restoring, and recovering .....</b>	<b>85</b>
Creating recovery media and backups .....	85
Creating HP Recovery media (select products only) .....	85
Using Windows tools .....	86
Restore and recovery .....	87
Recovering using HP Recovery Manager .....	87
What you need to know before you get started .....	87
Using the HP Recovery partition (select products only) .....	88
Using HP Recovery media to recover .....	88
Changing the computer boot order .....	89
Removing the HP Recovery partition (select products only) .....	90
<b>9 Using HP PC Hardware Diagnostics (UEFI) .....</b>	<b>91</b>
Downloading HP PC Hardware Diagnostics (UEFI) to a USB device .....	91
<b>10 Specifications .....</b>	<b>93</b>
Computer specifications .....	93
39.6-cm (15.6-in) display specifications .....	94
Hard drive specifications .....	95
M.2 solid-state drive specifications .....	96
DVD±RW SuperMulti DL Drive specifications .....	97
<b>11 Statement of memory volatility .....</b>	<b>99</b>
Nonvolatile memory usage .....	101
Questions and answers .....	103
Using HP Sure Start (select models only) .....	104
<b>12 Power cord set requirements .....</b>	<b>105</b>
Requirements for all countries .....	105
Requirements for specific countries and regions .....	106
<b>13 Recycling .....</b>	<b>109</b>
<b>Index .....</b>	<b>111</b>





# 1 Product description

Category	Description	7th gen Dis	7th gen UMA	6th gen Dis	6th gen UMA	Pen/Cel UMA
<b>Product name</b>	HP HP 250 G6 Notebook PC	✓	✓	✓	✓	✓
<b>Processor</b>	<b>7th generation Intel® Core™ processors</b>	✓	✓			
	Intel Core i7-7500U (2.7-GHz, turbo up to 3.5 GHz, 4-MB L3 cache, 2133-MHz, dual, 15W)		✓			
	Intel Core i5-7200U (2.5-GHz, turbo up to 3.1 GHz, 3-MB L3 cache, 2133-MHz, dual, 15W)	✓	✓			
	<b>6th generation Intel Core processors</b>			✓	✓	
	Intel Core i3-6006U (2.0-GHz, 3-MB L3 cache, 2133-MHz, dual, 15W)			✓	✓	
	<b>Intel Pentium® and Celeron® processors</b>					✓
	Intel Pentium N3710 (1.6-GHz, turbo up to 2.56 GHz, 2-MB L3 cache, 1600-MHz, quad, 6W)					✓
	Intel Celeron N3060 (1.6-GHz, turbo up to 2.48 GHz, 2-MB L3 cache, 1600-MHz, dual, 6W)					✓
<b>Graphics</b>	<b>Internal graphics</b>	✓	✓	✓	✓	✓
	Intel HD Graphics 620	✓	✓			
	Intel HD Graphics 520			✓	✓	
	Intel HD Graphics 405					✓
	Intel HD Graphics 400					✓
	<b>Switchable discrete graphics</b>	✓		✓		
	AMD Radeon M520 R17M-M1-30 with 2048 MB of dedicated video memory	✓		✓		
	Support HD Decode, DX12, and HDMI	✓	✓	✓	✓	✓
<b>Panel</b>	<b>39.6-cm</b> (15.6-in), high-definition (HD), white light-emitting diode (WLED), SVA, anti glare (1366×768) display, slim 3.2 mm, eDP; typical brightness: 220 nits	✓	✓	✓	✓	✓
	<b>39.6-cm</b> (15.6-in), full high-definition (FHD), white light-emitting diode (WLED), SVA, anti glare (1920×1080) display, slim 3.2 mm, eDP; typical brightness: 220 nits	✓	✓	✓	✓	✓
<b>Memory</b>	<b>Two non-customer-accessible/upgradable memory module slots (Intel Core processors)</b>	✓	✓	✓	✓	
	DDR4-2133 dual channel support (DDR4-2400 bridge to DDR4-2133)	✓	✓	✓	✓	

Category	Description	7th gen Dis	7th gen UMA	6th gen Dis	6th gen UMA	Pen/Cel UMA
	Supports up to 16 GB of system RAM in the following configurations:	√	√	√	√	
	<ul style="list-style-type: none"> <li>8192-MB total system memory (8192×1) or (4096×2)</li> </ul>	√	√	√	√	
	<ul style="list-style-type: none"> <li>6144-MB total system memory (4096×1) + (2048×1)</li> </ul>	√	√	√	√	
	<ul style="list-style-type: none"> <li>4096-MB total system memory (4096×1)</li> </ul>	√	√	√	√	
	<b>One non-customer-accessible/upgradable memory module slot</b>					√
	DDR3L-1600 single channel support					√
	Supports up to 8 GB of system RAM in the following configurations:					√
	<ul style="list-style-type: none"> <li>8192-MB total system memory (8192×1)</li> </ul>					√
	<ul style="list-style-type: none"> <li>4096-MB total system memory (4096×1)</li> </ul>					√
	<ul style="list-style-type: none"> <li>2048-MB total system memory (2048×1)</li> </ul>					√
<b>Hard drives</b>	Supports <b>6.35-cm</b> (2.5-in) SATA hard drives in <b>9.5-mm</b> (.37-in) and <b>7.2-mm</b> (.28-in) thicknesses	√	√	√	√	√
	Support for m.2 SATA SSD	√	√	√	√	√
	<b>Single hard drive configurations:</b>	√	√	√	√	√
	<ul style="list-style-type: none"> <li>1-TB, 5400 rpm, 9.5 mm or 7.2 mm</li> </ul>	√	√	√	√	√
	<ul style="list-style-type: none"> <li>500-GB, 5400/7200 rpm, 7.0-mm</li> </ul>	√	√	√	√	√
	<b>eMMC configurations:</b>	√	√	√	√	√
	<ul style="list-style-type: none"> <li>128 GB</li> </ul>	√	√	√	√	√
	<b>M.2 SATA-3 configurations (value):</b>	√	√	√	√	√
	<ul style="list-style-type: none"> <li>256 GB</li> </ul>	√	√	√	√	√
	<ul style="list-style-type: none"> <li>128 GB</li> </ul>	√	√	√	√	√
	<b>M.2 SATA-3 configurations (TLC):</b>	√	√	√	√	√
	<ul style="list-style-type: none"> <li>512 GB</li> </ul>	√	√	√	√	√
	<ul style="list-style-type: none"> <li>256 GB</li> </ul>	√	√	√	√	√
	<ul style="list-style-type: none"> <li>128 GB</li> </ul>	√	√	√	√	√
<b>Optical drive</b>	Fixed, serial ATA, 9.0-mm tray load	√	√	√	√	√
	DVD+/-RW Double-Layer writer	√	√	√	√	√
	Supports zero power optical drive	√	√	√	√	√
	Supports M-disc	√	√	√	√	√
	Supports configuration without optical drive	√	√	√	√	√
<b>Camera</b>	HP TrueVision HD camera - activity LED, USB 2.0, HD BSI sensor, f2.0, 720p by 30 frames per second	√	√	√	√	√

Category	Description	7th gen Dis	7th gen UMA	6th gen Dis	6th gen UMA	Pen/Cel UMA
<b>Mic</b>	HP Camera – VGA camera, indicator LED, USB 2.0, f2.4, 480p by 30 frames per second	√	√	√	√	√
	Single digital microphone	√	√	√	√	√
<b>Audio</b>	Dual speakers	√	√	√	√	√
	HP Audio Control	√	√	√	√	√
<b>Ethernet</b>	Integrated 10/100/1000 network interface card (NIC)	√	√	√	√	√
<b>Wireless Network</b>	<b>Integrated wireless options with single antenna (M. 2/PCIe):</b>	√	√	√	√	√
	Compatible with Miracast-certified devices	√	√	√	√	√
	Support for the following WLAN formats:	√	√	√	√	√
	<ul style="list-style-type: none"> <li>Realtek RTL8723DE 802.11 bgn 1x1 WiFi + BT 4.2 Combo Adapter</li> </ul>	√	√	√	√	√
	<b>Integrated wireless options with dual antennas (M. 2/PCIe):</b>	√	√	√	√	√
	Compatible with Miracast-certified devices	√	√	√	√	√
	Support for the following WLAN formats:	√	√	√	√	√
	<ul style="list-style-type: none"> <li>Intel Dual Band Wireless-AC 3168 802.11 ac 1x1 WiFi + BT 4.2 Combo (non-vPro)</li> </ul>	√	√	√	√	√
	<ul style="list-style-type: none"> <li>Intel Dual Band Wireless-AC 7265 802.11AC 2x2 WiFi + BT 4.2 Combo Adapter (non-vPro)</li> </ul>				√	
<b>External media card</b>	<b>HP Multi-Format Digital Media Reader</b>	√	√	√	√	√
	Support SD/SDHC/SDXC	√	√	√	√	√
	Push-pull insertion/removal	√	√	√	√	√
<b>Internal Card</b>	One M.2 slot for SSD	√	√	√	√	√
	One M.2 slot for WLAN	√	√	√	√	√
<b>Ports</b>	VGA (Dsub 15 pin) supporting 1920 × 1200 external resolution @ 60Hz	√	√	√	√	√
	HDMI version 1.4b supporting 1920 × 1080 @ 60Hz	√	√	√	√	√
	Hot Plug/unplug and auto detect for correct output to wide-aspect vs. standard aspect video	√	√	√	√	√
	RJ-45 (Ethernet)	√	√	√	√	√
	USB 3.0 (2 ports; left side)	√	√	√	√	√
	USB 2.0 (1 right side)	√	√	√	√	√
	AC Smart Pin adapter plug	√	√	√	√	√
	Headphone/line out and microphone/line in combo jack	√	√	√	√	√
<b>Keyboard/pointing devices</b>	Full-size textured, island style keyboard with numeric keypad	√	√	√	√	√

Category	Description	7th gen Dis	7th gen UMA	6th gen Dis	6th gen UMA	Pen/Cel UMA
	TouchPad with multi-touch gestures enabled	√	√	√	√	√
	TouchPad taps enabled by default	√	√	√	√	√
	TouchPad supports Modern Trackpad Gestures	√	√	√	√	√
<b>Power</b>	<b>AC adapters</b>	√	√	√	√	√
	65-W EM	√	√	√	√	√
	65-W	√		√		
	45-W		√		√	√
	1 meter power cord	√	√	√	√	√
	<b>Batteries</b>	√	√	√	√	√
	4-cell, 41-Whr Li-ion battery	√	√	√	√	√
	3-cell, 31-Whr Li-ion battery		√		√	√
<b>Security</b>	fTPM 2.0	√	√	√	√	√
	Kensington Security Lock	√	√	√	√	√
<b>Operating system</b>	<b>Preinstalled</b>	√	√	√	√	√
	Windows 10	√	√	√	√	√
	Windows 10 Professional	√	√	√	√	√
	<b>For Developed Market (ML):</b>	√	√	√	√	√
	Windows 10 Home ML	√	√	√	√	√
	Windows 10 Home Plus ML	√	√	√	√	√
	Windows 10 Pro StF MSNA Standard	√	√	√	√	√
	<b>For Emerging Market (EM/SL):</b>	√	√	√	√	√
	Windows 10 Home EM/SL	√	√	√	√	√
	Windows 10 Home Plus EM/SL	√	√	√	√	√
	Windows 10 Pro StF MSNA Strategic					√
	Windows 10 Pro StF MSNA Value (EM)					√
	Windows 10 Pro StF MSNA Standard	√	√	√	√	√
	<b>For China Market:</b>	√	√	√	√	√
	CPPP Windows 10 Home High End China Language Edition	√	√	√	√	√
	CPPP Windows 10 Home China Language Edition	√	√	√	√	√
	FreeDOS 2.0	√	√	√	√	√
<b>Service</b>	<b>End-user replaceable parts</b>	√	√	√	√	√
	AC adapter	√	√	√	√	√





Category	Description	7th gen Dis	7th gen UMA	6th gen Dis	6th gen UMA	Pen/Cel UMA
	Battery	√	√	√	√	√
	Optical drive	√	√	√	√	√

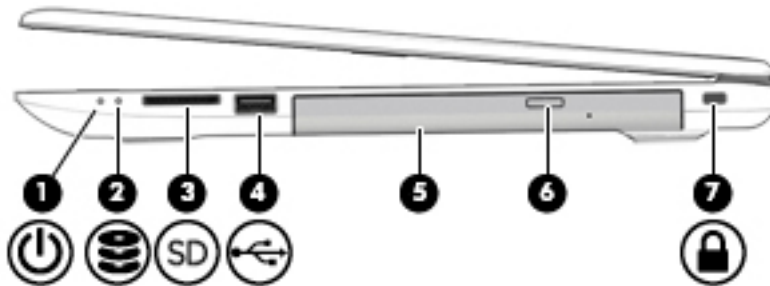

## 2 Components







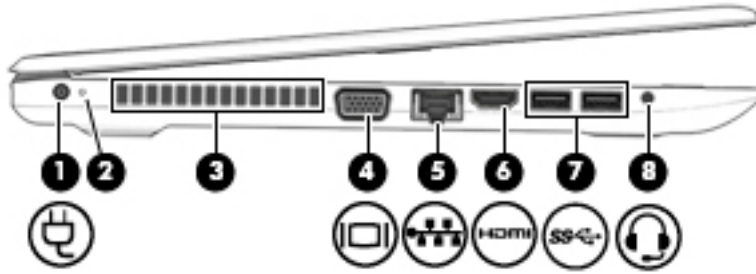

### Right



Component	Description
(1)  Power light	<ul style="list-style-type: none"><li>• On: The computer is on.</li><li>• Blinking: The computer is in the Sleep state, a power-saving state. The computer shuts off power to the display and other unneeded components.</li><li>• Off: The computer is off or in Hibernation. Hibernation is a power-saving state that uses the least amount of power.</li></ul>
(2)  Drive light	<ul style="list-style-type: none"><li>• Blinking white: The hard drive is being accessed.</li></ul>
(3)  Memory card reader	Reads optional memory cards that store, manage, share, or access information.  To insert a card: <ol style="list-style-type: none"><li>1. Hold the card label-side up, with the connectors facing the computer.</li><li>2. Insert the card into the memory card reader, and then press in on the card until it is firmly seated.</li></ol> To remove a card: <ul style="list-style-type: none"><li>▲ Pull the card out of the memory card reader.</li></ul>
(4)  USB 2.0 port	Connects a USB device, such as a cell phone, camera, activity tracker, or smartwatch, and provides data transfer.
(5) Optical drive (select products only)	Depending on your computer model, reads an optical disc or reads and writes to an optical disc.
(6) Optical drive eject button (select products only)	Releases the optical drive disc tray.
(7)  Security cable slot	Attaches an optional security cable to the computer.  <b>NOTE:</b> The security cable is designed to act as a deterrent, but it may not prevent the computer from being mishandled or stolen.

# Left



Component	Description
(1) 	Power connector Connects an AC adapter.
(2) 	Battery light When AC power is connected: <ul style="list-style-type: none"> <li>White: The battery charge is greater than 90 percent.</li> <li>Amber: The battery charge is from 0 to 90 percent.</li> <li>Off: The battery is not charging.</li> </ul> When AC power is disconnected (battery not charging): <ul style="list-style-type: none"> <li>Blinking amber: The battery has reached a low battery level. When the battery has reached a critical battery level, the battery light begins blinking rapidly.</li> <li>Off: The battery is not charging.</li> </ul>
(3) 	Vent Enables airflow to cool internal components. <b>NOTE:</b> The computer fan starts up automatically to cool internal components and prevent overheating. It is normal for the internal fan to cycle on and off during routine operation.
(4) 	External monitor port Connects an external VGA monitor or projector.
(5) 	RJ-45 (network) jack/status lights Connects a network cable. <ul style="list-style-type: none"> <li>White (left): The network is connected.</li> <li>Amber (right): Activity is occurring on the network.</li> </ul>
(6) 	HDMI port Connects an optional video or audio device, such as a high-definition television, any compatible digital or audio component, or a high-speed High Definition Multimedia Interface (HDMI) device.
(7) 	USB 3.x SuperSpeed ports (2) Connect a USB device, such as a cell phone, camera, activity tracker, or smartwatch, and provides high-speed data transfer.
(8) 	Audio-out (headphone)/Audio-in (microphone) combo jack Connects optional powered stereo speakers, headphones, earbuds, a headset, or a television audio cable. Also connects an optional headset microphone. This jack does not support optional standalone microphones.



Component	Description
	<p><b>WARNING!</b> To reduce the risk of personal injury, adjust the volume before putting on headphones, earbuds, or a headset. For additional safety information, refer to the <i>Regulatory, Safety, and Environmental Notices</i>.</p> <p>To access this guide:</p> <ol style="list-style-type: none"><li>1. Type <code>support</code> in the taskbar search box, and then select the <b>HP Support Assistant</b> app.</li></ol> <p>– or –</p> <p>Click the question mark icon in the taskbar.</p> <ol style="list-style-type: none"><li>2. Select <b>My PC</b>, select the <b>Specifications</b> tab, and then select <b>User Guides</b>.</li></ol> <p><b>NOTE:</b> When a device is connected to the jack, the computer speakers are disabled.</p>

# Display

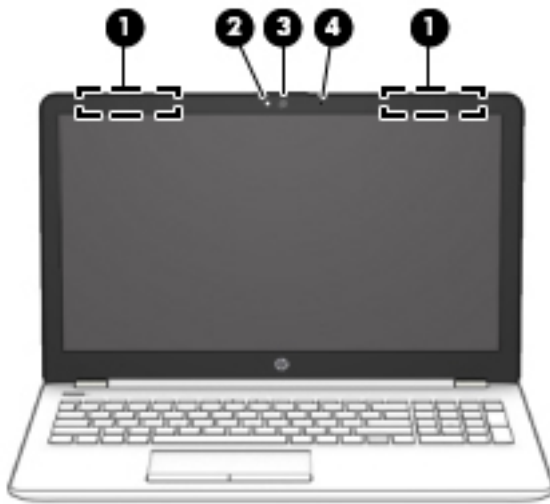

Component	Description
(1) WLAN antennas*	Send and receive wireless signals to communicate with wireless local area networks (WLANs).
(2) Camera light	On: The camera is in use.
(3) Camera	Records video and captures photographs. Some models allow you to video conference and chat online using streaming video.  To use the camera:  ▲ Type <code>camera</code> in the taskbar search box, and then select <b>Camera</b> .
(4) Internal microphone	Records sound.

\*The antennas are not visible from the outside of the computer. For optimal transmission, keep the areas immediately around the antennas free from obstructions.

For wireless regulatory notices, see the section of the *Regulatory, Safety, and Environmental Notices* that applies to your country or region.

To access this guide:

1. Type `support` in the taskbar search box, and then select the **HP Support Assistant** app.  
  
– or –  
  
Click the question mark icon in the taskbar.
2. Select **My PC**, select the **Specifications** tab, and then select **User Guides**.

# Keyboard area

## TouchPad

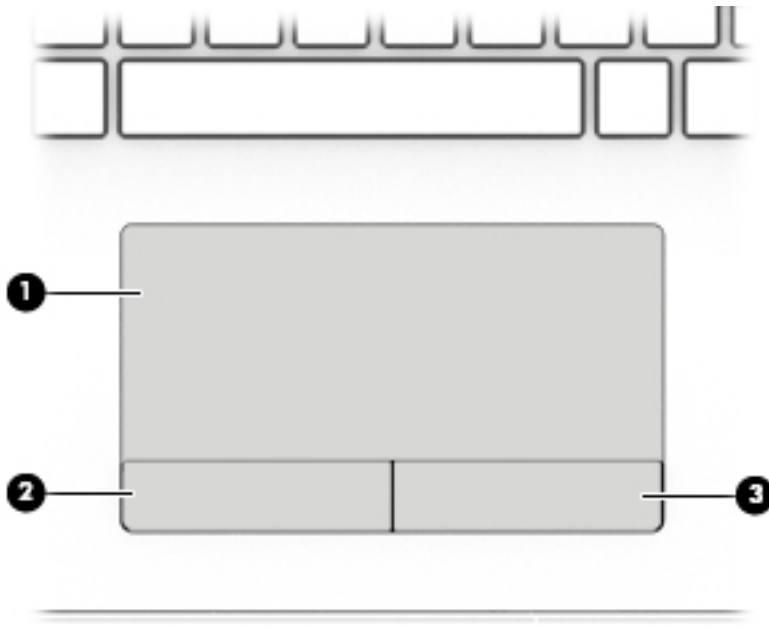

Component	Description
(1) TouchPad zone	Reads your finger gestures to move the pointer or activate items on the screen.
(2) Left TouchPad button	Functions like the left button on an external mouse.
(3) Right TouchPad button	Functions like the right button on an external mouse.

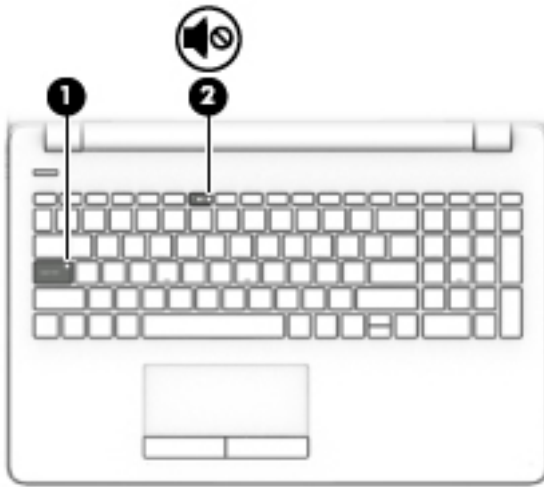

## Lights

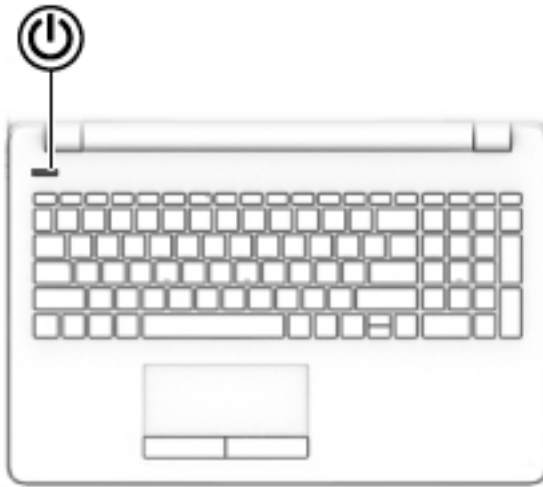

Component		Description
(1)	Caps lock light	On: Caps lock is on, which switches the key input to all capital letters.
(2)	 Mute light	<ul style="list-style-type: none"><li>• Amber: Computer sound is off.</li><li>• Off: Computer sound is on.</li></ul>

## Button



Component	Description
 Power button	<ul style="list-style-type: none"><li>• When the computer is off, press the button to turn on the computer.</li><li>• When the computer is on, press the button briefly to initiate Sleep.</li><li>• When the computer is in the Sleep state, press the button briefly to exit Sleep.</li><li>• When the computer is in Hibernation, press the button briefly to exit Hibernation.</li></ul> <p><b>CAUTION:</b> Pressing and holding down the power button results in the loss of unsaved information.</p> <p>If the computer has stopped responding and shutdown procedures are ineffective, press and hold the power button for at least 5 seconds to turn off the computer.</p> <p>To learn more about your power settings, see your power options.</p> <p>▲ Type <code>power options</code> in the taskbar search box, and then select <b>Power Options</b>.</p> <p>– or –</p> <p>Right-click the <b>Power meter</b> icon  and then select <b>Power Options</b>.</p>

## Special keys

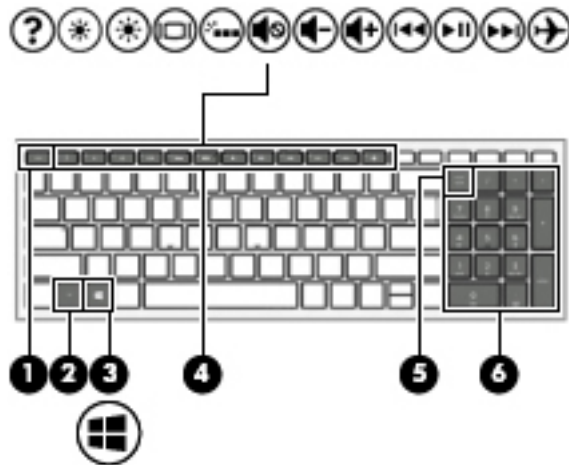













Component	Description
(1) <code>esc</code> key	Displays system information when pressed in combination with the <code>fn</code> key.
(2) <code>fn</code> key	Executes frequently used system functions when pressed in combination with another key. Such key combinations are called <i>hot keys</i> .
(3)  Windows key	Opens the <b>Start</b> menu. <b>NOTE:</b> Pressing the Windows key again will close the <b>Start</b> menu.
(4) Action keys	Execute frequently used system functions. See <a href="#">Action keys on page 15</a> .
(5) <code>num lk</code> key	Turns the embedded numeric keypad on and off.
(6) Integrated numeric keypad	A separate keypad to the right of the alphabet keyboard. When <code>num lk</code> is pressed, the integrated keypad can be used like an external numeric keypad. <b>NOTE:</b> If the keypad function is active when the computer is turned off, that function is reinstated when the computer is turned back on.

## Action keys

An action key performs the function indicated by the icon on the key. To determine which keys are on your product, see [Special keys on page 14](#).



▲ To use an action key, press and hold the key.

Icon	Description
	Opens Help and Support, which provides tutorials, information about the Windows operating system and your computer, answers to questions, and updates to your computer. Help and Support also provides automated troubleshooting tools and access to support.
	Decreases the screen brightness incrementally as long as you hold down the key.
	Increases the screen brightness incrementally as long as you hold down the key.
	Switches the screen image among display devices connected to the system. For example, if a monitor is connected to the computer, repeatedly pressing the key alternates the screen image from computer display to monitor display to simultaneous display on both the computer and monitor.
	Turns the keyboard backlight off or on. <b>NOTE:</b> To conserve battery power, turn off this feature.
	Mutes or restores speaker sound.
	Decreases speaker volume incrementally while you hold down the key.
	Increases speaker volume incrementally while you hold down the key.
	Plays the previous track of an audio CD or the previous section of a DVD or a Blu-ray Disc (BD).
	Starts, pauses, or resumes playback of an audio CD, a DVD, or a BD.
	Plays the next track of an audio CD or the next section of a DVD or a BD.
	Turns the airplane mode and wireless feature on or off. <b>NOTE:</b> The airplane mode key is also referred to as the wireless button. <b>NOTE:</b> A wireless network must be set up before a wireless connection is possible.

 **NOTE:** The action key feature is enabled at the factory. You can disable this feature by pressing and holding the **fn** key and the left **shift** key. The **fn** lock light will turn on. After you have disabled the action key feature, you can still perform each function by pressing the **fn** key in combination with the appropriate action key.

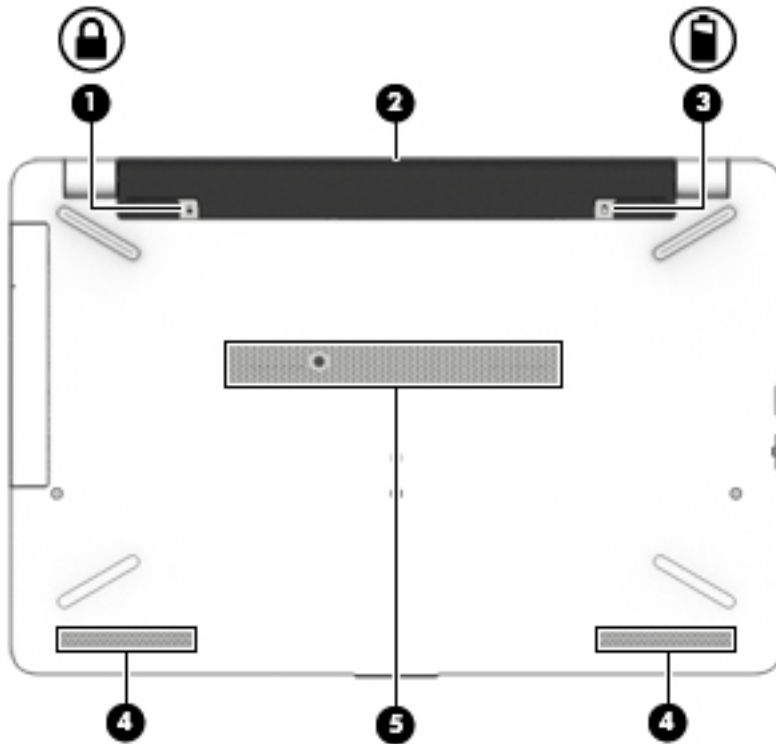
## Bottom



Component	Description
(1) 	Battery lock Locks the battery in the battery bay.
(2)	Battery bay Holds the battery.
(3) 	Battery release latch Releases the battery.
(4)	Speakers (2) Produce sound.
(5)	Vent Enables airflow to cool internal components. <b>NOTE:</b> The computer fan starts up automatically to cool internal components and prevent overheating. It is normal for the internal fan to cycle on and off during routine operation.



# Labels

The labels affixed to the computer provide information you may need when you troubleshoot system problems or travel internationally with the computer.

 **IMPORTANT:** Check the following locations for the labels described in this section: the bottom of the computer, inside the battery bay, under the service door, or on the back of the display.

- Service label—Provides important information to identify your computer. When contacting support, you will probably be asked for the serial number, and possibly for the product number or the model number. Locate these numbers before you contact support.

Your service label will resemble one of the examples shown below. Refer to the illustration that most closely matches the service label on your computer.



---

### Component

- (1) Serial number
  - (2) Product number
  - (3) Warranty period
  - (4) Model number (select products only)
- 

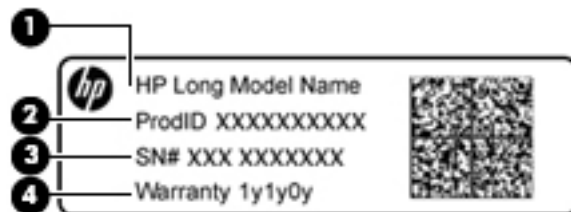

---

### Component

- (1) Model name (select products only)
  - (2) Product number
  - (3) Serial number
  - (4) Warranty period
- 

- Regulatory label(s)—Provide(s) regulatory information about the computer.
- Wireless certification label(s)—Provide(s) information about optional wireless devices and the approval markings for the countries or regions in which the devices have been approved for use.



# 3 Illustrated parts catalog

## Computer major components

 **NOTE:** HP continually improves and changes product parts. For complete and current information on supported parts for your computer, go to <http://partsurfer.hp.com>, select your country or region, and then follow the on-screen instructions.

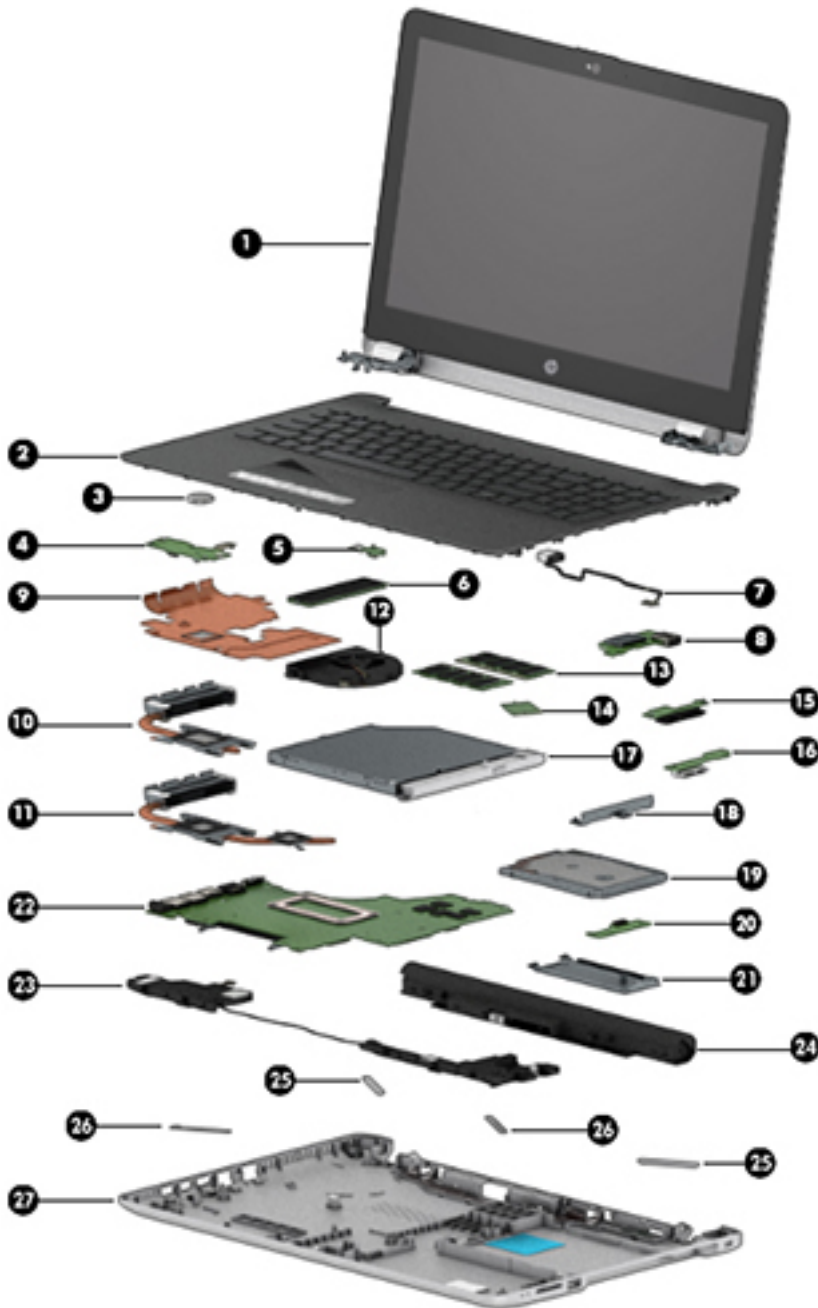

Item	Component	Spare part number
(1)	<b>Display assembly</b> (touch or non-touch) <b>NOTE:</b> For display assembly spare part information, see <a href="#">Display assembly subcomponents on page 23</a> .	not spared
(2)	<b>Top cover/keyboard</b> <b>NOTE:</b> For a detailed list of keyboard country codes, see <a href="#">Top cover/keyboard on page 79</a> .	
	Asteroid silver models with no backlight	929904-xxx
	Dark ash silver models with no backlight	929906-xxx
(3)	<b>RTC battery</b>	922847-001
(4)	<b>Touchpad button board</b>	924993-001
(5)	<b>Power button board</b>	924994-001
(6)	<b>Solid-state drive, M.2</b>	
	512 GB	926255-001
	256 GB	926254-001
	128 GB	926253-001
(7)	<b>Power connector cable</b>	931613-001
(8)	<b>USB board</b>	924991-001
	<b>Heat sink assembly</b> (includes replacement thermal materials)	
(9)	For use in models with UMA graphics and Intel Pentium or Celeron processors	924977-001
(10)	For use in models with UMA graphics memory and 6th or 7th generation Intel Core processors	924975-001
(11)	For use in models with discrete graphics memory and Intel Pentium or Celeron processors	924978-001
(11)	For use in models with discrete graphics memory and 6th or 7th generation Intel Core processors	924976-001
(12)	<b>Fan</b>	925012-001
(13)	<b>Memory module</b>	
	PC3L-1600	
	For use in models with Intel Pentium and Celeron processors	
	• 8-GB	693374-005
	• 4 GB	691740-005
	• 2 GB	691739-005
	DDR4-2400	
	For use in models with 6th and 7th generation Intel Core processors	
	• 8-GB	862398-855
	• 4 GB	862397-855
	• 2 GB	864271-855
(14)	<b>WLAN module</b>	

<b>Item</b>	<b>Component</b>	<b>Spare part number</b>
	Intel Dual Band Wireless-AC 7265 802.11AC 2x2 WiFi + BT 4.2 Combo Adapter (non-vPro)	901229-855
	Intel Dual Band Wireless-AC 3168 802.11 ac 1x1 WiFi + BT 4.2 Combo Adapter	863934-855
	Realtek RTL8723BE-VB 802.11b/g/n 1x1 Wi-Fi + BT4.0 Combo Adapter	855106-855
<b>(15)</b>	<b>Hard drive connector board</b>	924995-001
<b>(16)</b>	<b>Optical drive connector board</b>	924990-001
<b>(17)</b>	<b>Optical drive</b> (DVD+/-RW Double-Layer SuperMulti)	920420-003
<b>(18)</b>	<b>Hard drive bracket</b>	924980-001
<b>(19)</b>	<b>Hard drive, 2.5 inch</b> (does not include bracket, connector board, or cable)	
	<ul style="list-style-type: none"> <li>• 1-TB, 5400-rpm</li> </ul>	778192-005
	<ul style="list-style-type: none"> <li>• 500-GB, 7200-rpm</li> </ul>	703267-005
	<ul style="list-style-type: none"> <li>• 500-GB, 5400-rpm</li> </ul>	778186-005
<b>(20)</b>	<b>Solid-state drive board</b>	924992-001
<b>(21)</b>	<b>Solid-state drive bracket</b>	924981-001
<b>(22)</b>	<b>System board</b> (includes replacement thermal materials)	
	All system boards use the following part numbers:	
	xxxxxx-001: Non-Windows operating systems	
	xxxxxx-601: Windows 10 operating system	
	For use in models with discrete graphics memory	
	<ul style="list-style-type: none"> <li>• Intel Core i5-7200U processor and 2 GB of discrete graphics memory</li> </ul>	926248-xx1
	<ul style="list-style-type: none"> <li>• Intel Core i3-6006U processor and 2 GB of discrete graphics memory</li> </ul>	926249-xx1
	For use in models with UMA graphics memory:	
	<ul style="list-style-type: none"> <li>• Intel Core i7-7500U processor</li> </ul>	926246-xx1
	<ul style="list-style-type: none"> <li>• Intel Core i5-7200U processor</li> </ul>	926247-xx1
	<ul style="list-style-type: none"> <li>• Intel Core i3-6006U processor</li> </ul>	926249-xx1
	<ul style="list-style-type: none"> <li>• Intel Pentium N4200 processor</li> </ul>	934736-xx1
	<ul style="list-style-type: none"> <li>• Intel Pentium N3710 processor</li> </ul>	926251-xx1
	<ul style="list-style-type: none"> <li>• Intel Celeron N3350 processor</li> </ul>	934737-xx1
	<ul style="list-style-type: none"> <li>• Intel Celeron N3060 processor</li> </ul>	926252-xx1
<b>(23)</b>	<b>Speakers</b> (includes left and right speakers and cable)	925306-001
<b>(24)</b>	<b>Battery</b>	
	4-cell, 41-Whr, 2.8-Ah Li-ion battery	919701-850
	3-cell, 31-Whr, 2.8-Ah Li-ion battery	919700-850
<b>(25)</b>	<b>Rubber Kit</b> (includes upper feet)	
	Asteroid silver	931599-001

<b>Item</b>	<b>Component</b>	<b>Spare part number</b>
	Dark ash silver	931600-001
<b>(26)</b>	<b>Rubber Kit</b> (includes lower feet)	
	Asteroid silver	931601-001
	Dark ash silver	931602-001
<b>(27)</b>	<b>Bottom cover</b>	
	For use in models with an optical drive:	
	• Asteroid silver	929894-001
	• Dark ash silver	929895-001
	For use in models without an optical drive:	
	• Dark ash silver	929897-001

## Display assembly subcomponents

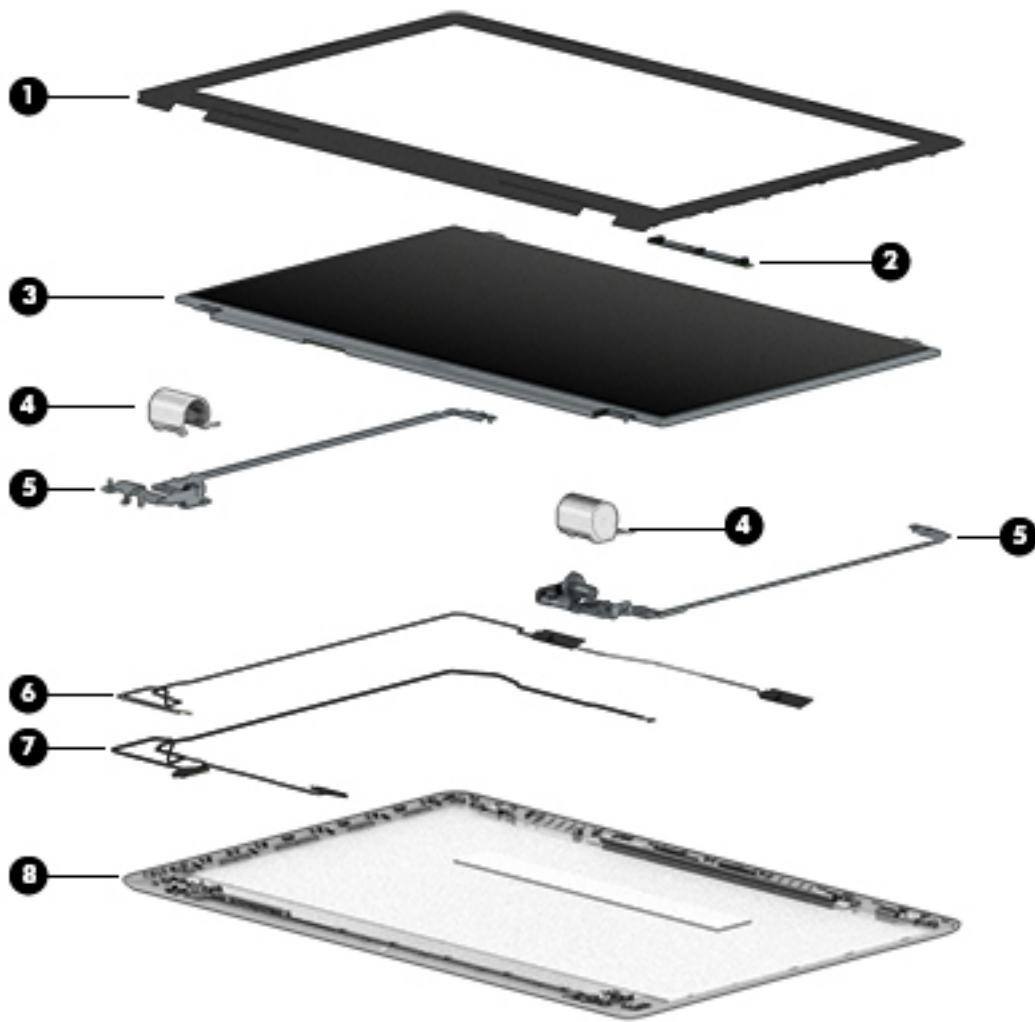

Item	Component	Spare part number
(1)	<b>Display bezel</b>	924925-001
(2)	<b>Camera/microphone module</b>	
	HD	919475-003
	VGA	919476-003
(3)	<b>Raw display panel (39.6-cm [15.6-in])</b>	
	FHD	850475-003
	HD	850477-003
(4)	<b>Hinge cover</b>	
	Left, asteroid silver	929900-001
	Right, asteroid silver	929901-001
	Left, dark ash silver	929902-001

Item	Component	Spare part number
	Right, dark ash silver	929903-001
<b>(5)</b>	<b>Hinge Kit</b> (left and right)	925297-001
<b>(6)</b>	<b>Antenna</b> (includes wireless antenna cable and transceiver)	925032-001
<b>(7)</b>	<b>Display cable</b> (includes display panel cable and camera/microphone cable)	924930-001
<b>(8)</b>	<b>Display enclosure:</b>	
	Asteroid silver	929892-001
	Ash silver	929893-001

## Cables

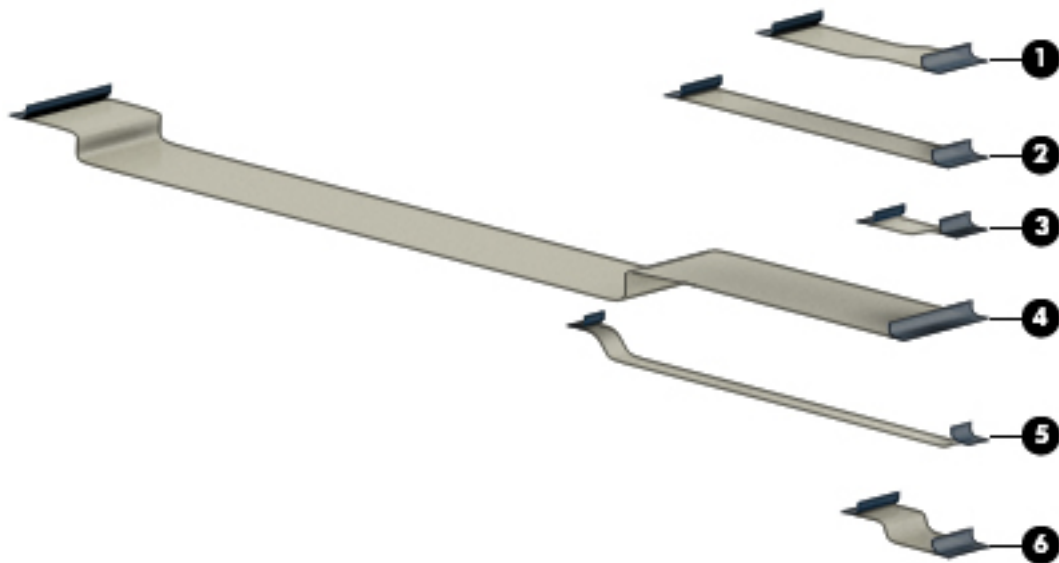

Item	Component	Spare part number
<b>(1)</b>	<b>Hard drive connector board cable</b>	924927-001
<b>(2)</b>	<b>TouchPad button board cable</b>	924934-001
<b>(3)</b>	<b>TouchPad cable</b>	924928-001
<b>(4)</b>	<b>USB board cable</b>	924929-001
<b>(5)</b>	<b>Power button board cable</b>	924933-001
<b>(6)</b>	<b>Optical drive connector board cable</b>	924926-001



## Mass storage devices

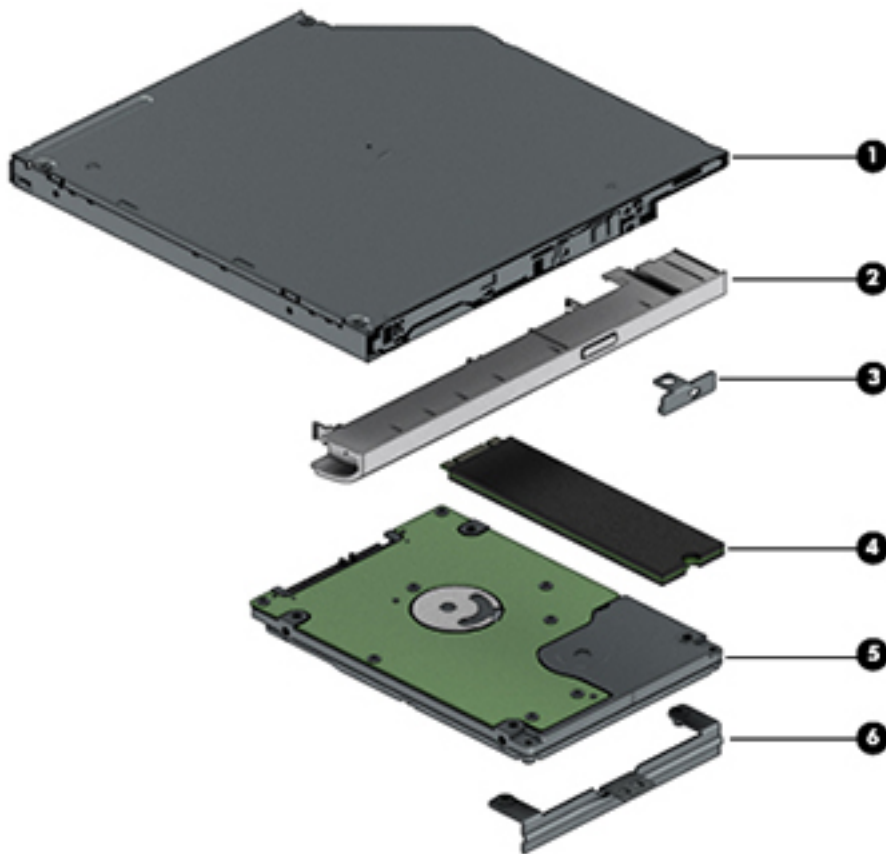

Item	Component	Spare part number
(1)	<b>Optical drive</b> (DVD+/-RW Double-Layer SuperMulti)	920420-003
(2)	<b>Optical drive bezel</b>	
	Asteroid silver	929898-001
	Dark ash silver	929898-001
(3)	<b>Optical drive bracket</b>	924979-001
(4)	<b>Solid-state drive, M.2</b>	
	512 GB	926255-001
	256 GB	926254-001
	128 GB	926253-001
(5)	<b>Hard drive, SATA; does not include brackets, connector board, or cable):</b>	
	1-TB, 5400-rpm	778192-005
	500-GB, 7200-rpm	703267-005
	500-GB, 5400-rpm	778186-005
(6)	<b>Hard drive bracket</b>	924980-001

## Miscellaneous parts

Component	Spare part number
<b>HP Smart AC adapter</b> (4.5 mm, non-PFC)	
65-W	710412-001
65-W, EM, for use in India and the People's Republic of China	913691-850
45-W	741727-001
<b>Power cord</b> (3-pin, black, 1.0-m):	
For use in Australia	920688-011
For use in Denmark	920688-007
For use in Europe	920688-005
For use in India	920688-016
For use in Israel	920688-008
For use in Italy	920688-002
For use in Japan	920688-017
For use in North America	920688-001
For use in the People's Republic of China	920688-014
For use in South Africa	920688-010
For use in South Korea	920688-013
For use in Switzerland	920688-009
For use in Taiwan	920688-015
For use in Thailand	920688-012
For use in the United Kingdom and Singapore	920688-006
<b>Screw Kit</b>	
Black	925005-001
Silver	925006-001
<b>Essential top load case</b>	679921-001

---

## 4 Removal and replacement procedures preliminary requirements

### Tools required

You will need the following tools to complete the removal and replacement procedures:

- Flat-bladed screwdriver
- Magnetic screwdriver
- Phillips P0 and P1 screwdrivers

### Service considerations

The following sections include some of the considerations that you must keep in mind during disassembly and assembly procedures.

---

 **NOTE:** As you remove each subassembly from the computer, place the subassembly (and all accompanying screws) away from the work area to prevent damage.

---

### Plastic parts

---

 **CAUTION:** Using excessive force during disassembly and reassembly can damage plastic parts. Use care when handling the plastic parts. Apply pressure only at the points designated in the maintenance instructions.

---

### Cables and connectors

---

 **CAUTION:** When servicing the computer, be sure that cables are placed in their proper locations during the reassembly process. Improper cable placement can damage the computer.

---

Cables must be handled with extreme care to avoid damage. Apply only the tension required to unseat or seat the cables during removal and insertion. Handle cables by the connector whenever possible. In all cases, avoid bending, twisting, or tearing cables. Be sure that cables are routed in such a way that they cannot be caught or snagged by parts being removed or replaced. Handle flex cables with extreme care; these cables tear easily.

## Drive handling

---

**⚠ CAUTION:** Drives are fragile components that must be handled with care. To prevent damage to the computer, damage to a drive, or loss of information, observe these precautions:

Before removing or inserting a hard drive, shut down the computer. If you are unsure whether the computer is off or in Hibernation, turn the computer on, and then shut it down through the operating system.

Before handling a drive, be sure that you are discharged of static electricity. While handling a drive, avoid touching the connector.

Before removing a diskette drive or optical drive, be sure that a diskette or disc is not in the drive and be sure that the optical drive tray is closed.

Handle drives on surfaces covered with at least one inch of shock-proof foam.

Avoid dropping drives from any height onto any surface.

After removing a hard drive, an optical drive, or a diskette drive, place it in a static-proof bag.

Avoid exposing an internal hard drive to products that have magnetic fields, such as monitors or speakers.

Avoid exposing a drive to temperature extremes or liquids.

If a drive must be mailed, place the drive in a bubble pack mailer or other suitable form of protective packaging and label the package "FRAGILE."

---

## Grounding guidelines

### Electrostatic discharge damage

Electronic components are sensitive to electrostatic discharge (ESD). Circuitry design and structure determine the degree of sensitivity. Networks built into many integrated circuits provide some protection, but in many cases, ESD contains enough power to alter device parameters or melt silicon junctions.

A discharge of static electricity from a finger or other conductor can destroy static-sensitive devices or microcircuitry. Even if the spark is neither felt nor heard, damage may have occurred.

An electronic device exposed to ESD may not be affected at all and can work perfectly throughout a normal cycle. Or the device may function normally for a while, then degrade in the internal layers, reducing its life expectancy.

---

**⚠ CAUTION:** To prevent damage to the computer when you are removing or installing internal components, observe these precautions:

Keep components in their electrostatic-safe containers until you are ready to install them.

Before touching an electronic component, discharge static electricity by using the guidelines described in this section.

Avoid touching pins, leads, and circuitry. Handle electronic components as little as possible.

If you remove a component, place it in an electrostatic-safe container.

---

The following table shows how humidity affects the electrostatic voltage levels generated by different activities.

---

**⚠ CAUTION:** A product can be degraded by as little as 700 V.

---

Typical electrostatic voltage levels			
Event	Relative humidity		
	10%	40%	55%
Walking across carpet	35,000 V	15,000 V	7,500 V
Walking across vinyl floor	12,000 V	5,000 V	3,000 V
Motions of bench worker	6,000 V	800 V	400 V
Removing DIPs from plastic tube	2,000 V	700 V	400 V
Removing DIPs from vinyl tray	11,500 V	4,000 V	2,000 V
Removing DIPs from Styrofoam	14,500 V	5,000 V	3,500 V
Removing bubble pack from PCB	26,500 V	20,000 V	7,000 V
Packing PCBs in foam-lined box	21,000 V	11,000 V	5,000 V

## Packaging and transporting guidelines

Follow these grounding guidelines when packaging and transporting equipment:

- To avoid hand contact, transport products in static-safe tubes, bags, or boxes.
- Protect ESD-sensitive parts and assemblies with conductive or approved containers or packaging.
- Keep ESD-sensitive parts in their containers until the parts arrive at static-free workstations.
- Place items on a grounded surface before removing items from their containers.
- Always be properly grounded when touching a component or assembly.
- Store reusable ESD-sensitive parts from assemblies in protective packaging or non-conductive foam.
- Use transporters and conveyors made of antistatic belts and roller bushings. Be sure that mechanized equipment used for moving materials is wired to ground and that proper materials are selected to avoid static charging. When grounding is not possible, use an ionizer to dissipate electric charges.

## Workstation guidelines

Follow these grounding workstation guidelines:

- Cover the workstation with approved static-shielding material.
- Use a wrist strap connected to a properly grounded work surface and use properly grounded tools and equipment.
- Use conductive field service tools, such as cutters, screwdrivers, and vacuums.
- When fixtures must directly contact dissipative surfaces, use fixtures made only of static-safe materials.
- Keep the work area free of nonconductive materials, such as ordinary plastic assembly aids and Styrofoam.
- Handle ESD-sensitive components, parts, and assemblies by the case or PCM laminate. Handle these items only at static-free workstations.
- Avoid contact with pins, leads, or circuitry.
- Turn off power and input signals before inserting or removing connectors or test equipment.

## Equipment guidelines

Grounding equipment must include either a wrist strap or a foot strap at a grounded workstation.

- When seated, wear a wrist strap connected to a grounded system. Wrist straps are flexible straps with a minimum of one megohm  $\pm 10\%$  resistance in the ground cords. To provide proper ground, wear a strap snugly against the skin at all times. On grounded mats with banana-plug connectors, use alligator clips to connect a wrist strap.
- When standing, use foot straps and a grounded floor mat. Foot straps (heel, toe, or boot straps) can be used at standing workstations and are compatible with most types of shoes or boots. On conductive floors or dissipative floor mats, use foot straps on both feet with a minimum of one megohm resistance between the operator and ground. To be effective, the conductive must be worn in contact with the skin.

The following grounding equipment is recommended to prevent electrostatic damage:

- Antistatic tape
- Antistatic smocks, aprons, and sleeve protectors
- Conductive bins and other assembly or soldering aids
- Nonconductive foam
- Conductive tabletop workstations with ground cords of one megohm resistance
- Static-dissipative tables or floor mats with hard ties to the ground
- Field service kits
- Static awareness labels
- Material-handling packages
- Nonconductive plastic bags, tubes, or boxes
- Metal tote boxes
- Electrostatic voltage levels and protective materials

The following table lists the shielding protection provided by antistatic bags and floor mats.

Material	Use	Voltage protection level
Antistatic plastics	Bags	1,500 V
Carbon-loaded plastic	Floor mats	7,500 V
Metallized laminate	Floor mats	5,000 V

---

# 5 Removal and replacement procedures for Customer Self-Repair parts

---

 **CAUTION:** The Customer Self-Repair program is not available in all locations. Installing a part not supported by the Customer Self-Repair program may void your warranty. Check your warranty to determine if Customer Self-Repair is supported in your location.

 **NOTE:** HP continually improves and changes product parts. For complete and current information on supported parts for your computer, go to <http://partsurfer.hp.com>, select your country or region, and then follow the on-screen instructions.

---

## Component replacement procedures

---

 **NOTE:** Please read and follow the procedures described here to access and replace Customer Self-Repair parts successfully.

 **NOTE:** Details about your computer, including model, serial number, product key, and length of warranty, are on the service tag at the bottom of your computer. See [Labels on page 17](#) for details.

---

This chapter provides removal and replacement procedures for Customer Self-Repair parts.

Make special note of each screw size and location during removal and replacement.

## Battery

Description	Spare part number
4-cell, 41-Whr, 2.8-Ah Li-ion battery	919701-850
3-cell, 31-Whr, 2.8-Ah Li-ion battery	919700-850

Before disassembling the computer, follow these steps:

1. Shut down the computer. If you are unsure whether the computer is off or in Hibernation, turn the computer on, and then shut it down through the operating system.
2. Disconnect all external devices connected to the computer.
3. Disconnect the power from the computer by first unplugging the power cord from the AC outlet and then unplugging the AC adapter from the computer.

To remove the battery:

1. Position the computer upside down on a flat surface.
2. Slide the battery lock latch **(1)** to unlock the battery, and then slide the battery release latch **(2)** to release the battery.



**NOTE:** The battery release latch automatically returns to its original position.

3. Remove the battery **(3)** from the computer.

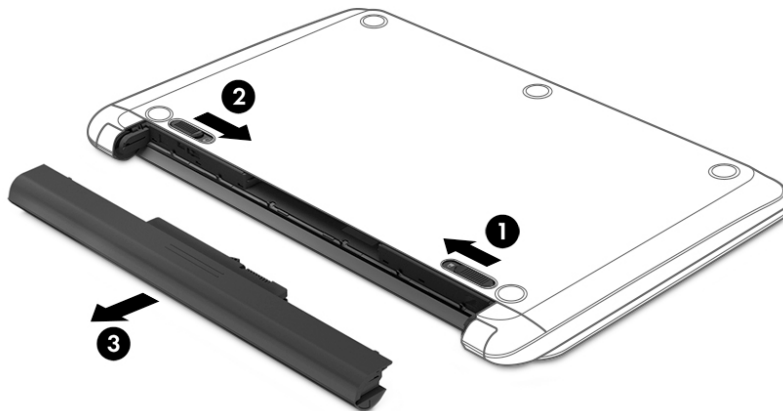



## Optical drive

Description	Spare part number
DVD+/-RW Double-Layer SuperMulti Drive	920420-003
Optical drive bezel for use in asteroid silver models	929898-001
Optical drive bezel for use in dark ash silver models	929899-001
Optical drive bracket	924979-001

Before removing the optical drive, follow these steps:

1. Shut down the computer. If you are unsure whether the computer is off or in Hibernation, turn the computer on, and then shut it down through the operating system.
2. Disconnect all external devices connected to the computer.
3. Disconnect the power from the computer by first unplugging the power cord from the AC outlet and then unplugging the AC adapter from the computer.
4. Remove the battery (see [Battery on page 32](#)).

To remove the optical drive:

1. Remove the Phillips PM2.5×11.0 screw **(1)** that secures the optical drive to the computer.
2. Remove the optical drive **(2)** by sliding it out of the optical drive bay.

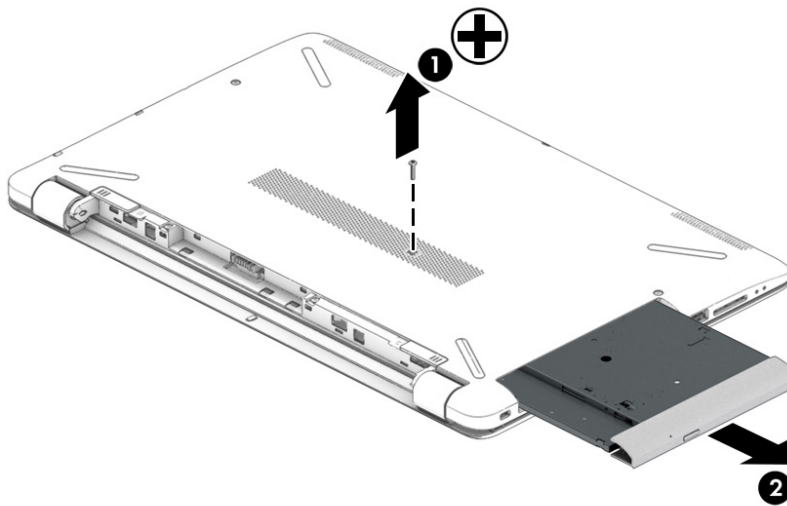

3. If it is necessary to remove the optical drive bezel, insert a paper clip into the release hole **(1)** to disengage the bezel. Press the tab **(2)** to release the bezel from the drive. Rotate the side of the bezel **(3)**, and then remove it **(4)**.

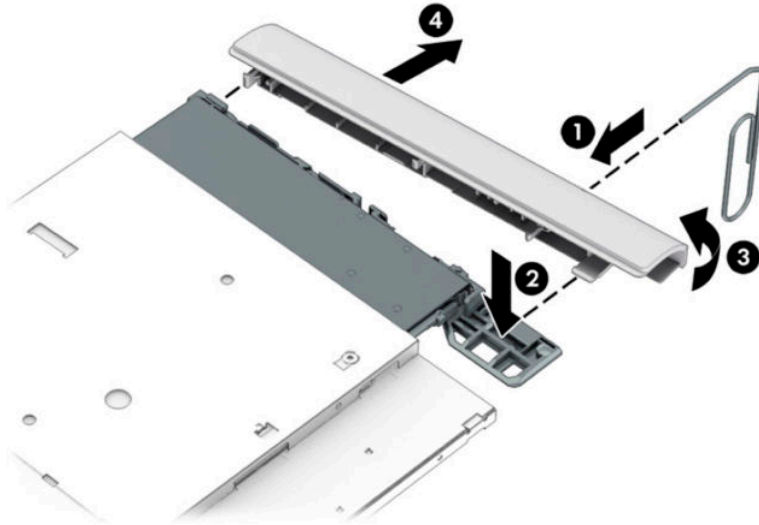

4. If it is necessary to replace the bracket on the rear of the optical drive, remove the Phillips PM2.0×2.5 screw **(1)** that secures the bracket to the drive, and then remove the bracket **(2)**.

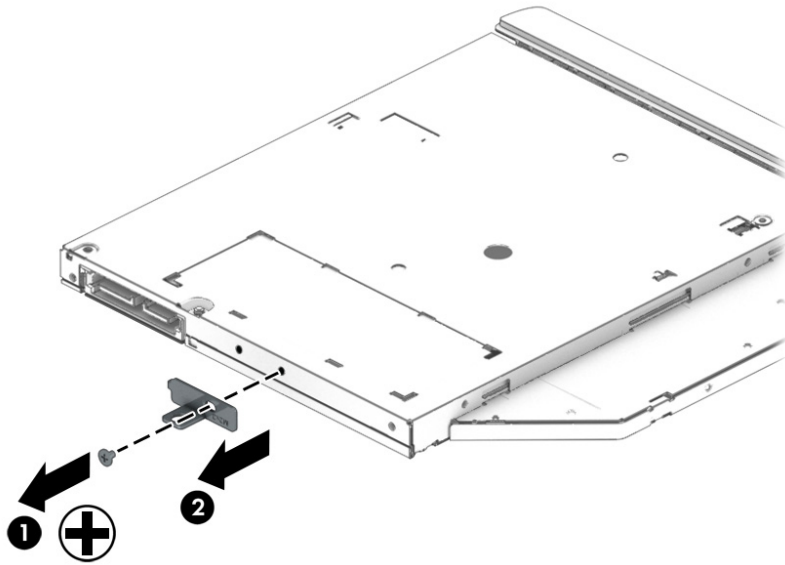

Reverse this procedure to reassemble and install the optical drive.

---

# 6 Removal and replacement procedures for Authorized Service Provider parts

 **CAUTION:** Components described in this chapter should only be accessed by an authorized service provider. Accessing these parts can damage the computer or void the warranty.

 **NOTE:** HP continually improves and changes product parts. For complete and current information on supported parts for your computer, go to <http://partsurfer.hp.com>, select your country or region, and then follow the on-screen instructions.

---

## Component replacement procedures

 **NOTE:** Details about your computer, including model, serial number, product key, and length of warranty, are on the service tag at the bottom of your computer. See [Labels on page 17](#) for details.

---

This chapter provides removal and replacement procedures for Authorized Service Provider only parts.

There are as many as 54 screws that must be removed, replaced, or loosened when servicing Authorized Service Provider only parts. Make special note of each screw size and location during removal and replacement.

## Display subcomponents (bezel, panel, camera)

 **NOTE:** Display assemblies are spared at the subcomponent level only.

---

This section illustrates how to remove the display bezel, display panel, and camera module without removing the display from the computer. The [Display assembly on page 66](#) section illustrates removing all display subcomponents.

To remove the display assembly subcomponents, follow these steps:

1. Shut down the computer. If you are unsure whether the computer is off or in Hibernation, turn the computer on, and then shut it down through the operating system.
2. Disconnect all external devices connected to the computer.
3. Disconnect the power from the computer by first unplugging the power cord from the AC outlet and then unplugging the AC adapter from the computer.

Remove the display assembly subcomponents:

1. Open the computer as far as it will open.
2. To remove the display bezel:
  - a. Flex the inside of the top edge **(1)**, the left and right edges **(2)**, and the bottom edge **(3)** of the display bezel until the bezel disengages from the display enclosure.

 **NOTE:** When removing the bezel from the bottom of the display **(3)**, be careful not to peel the Mylar from the bottom of the display panel.

---

- b. Remove the display bezel (4).

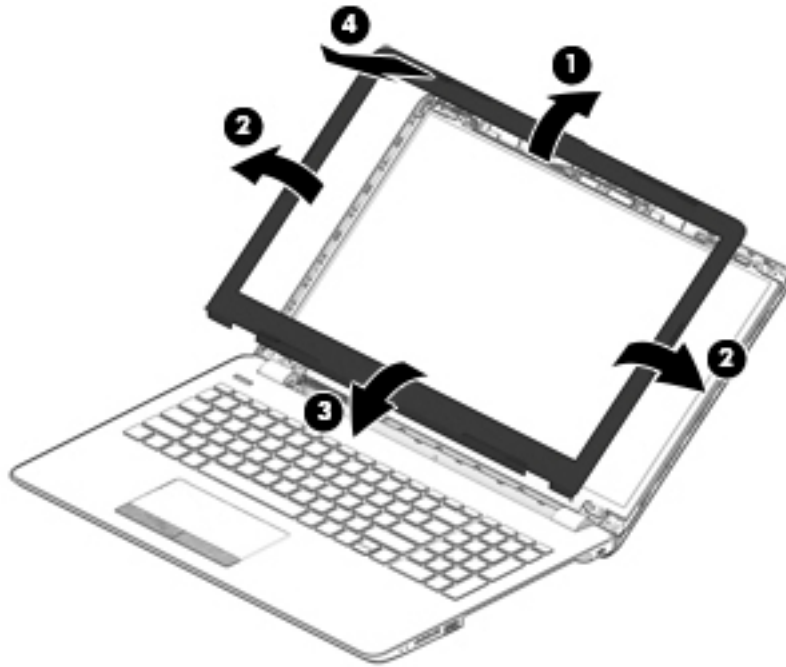

3. To remove the camera/microphone module:

- a. Position the display assembly with the top edge toward you.
- b. Pry up to disengage the camera/microphone module from the adhesive that secures it to the display (1).
- c. Disconnect the cable (2) from the module.
- d. Remove the tape from the enclosure (3). Replacement cameras come with tape already installed.

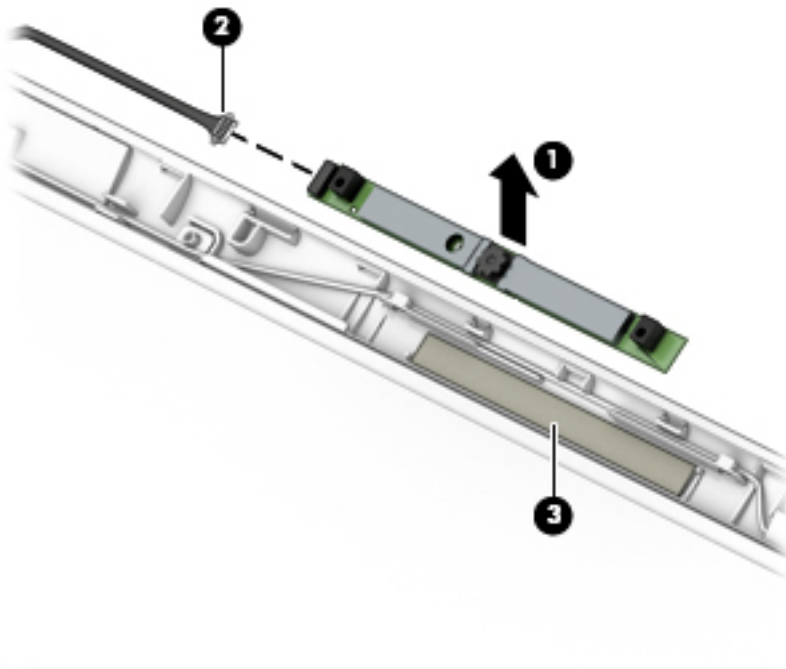

4. To remove the display panel:
- Remove the four Phillips PM2.0×3.0 screws **(1)** that secure the display panel to the top of the enclosure.
  - Remove the two Phillips PM2.0×3.0 screws **(2)** that secure the display panel to the bottom of the enclosure.
  - Lift the hinges up and move aside enough to be able to rotate the panel up and over **(3)**.
  - Rotate the display panel onto the keyboard **(4)** to gain access to the display cable connection on the back of the panel.

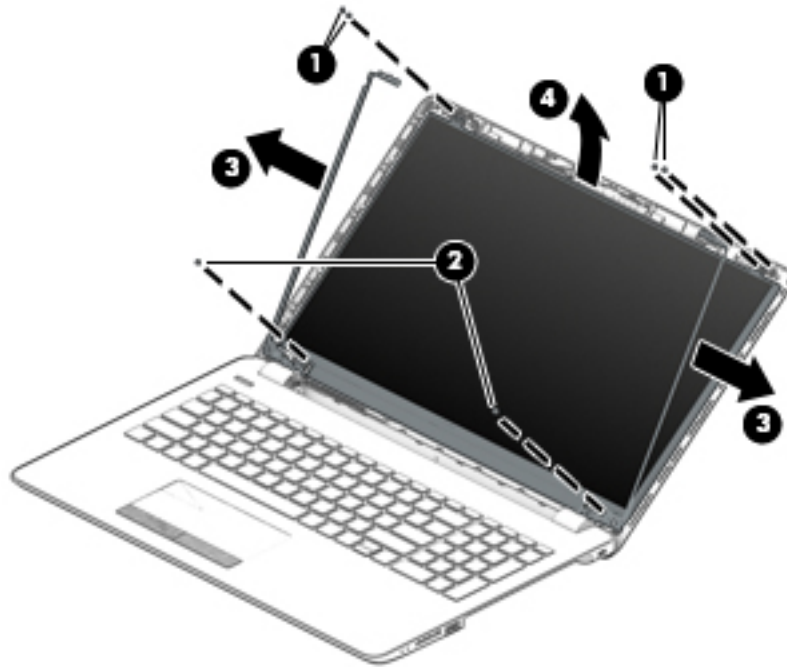

- On the back of the display panel, release the adhesive strip that secures the display panel cable to the display panel, and then disconnect the cable **(1)**.

- f. Remove the display panel from the computer **(2)**.

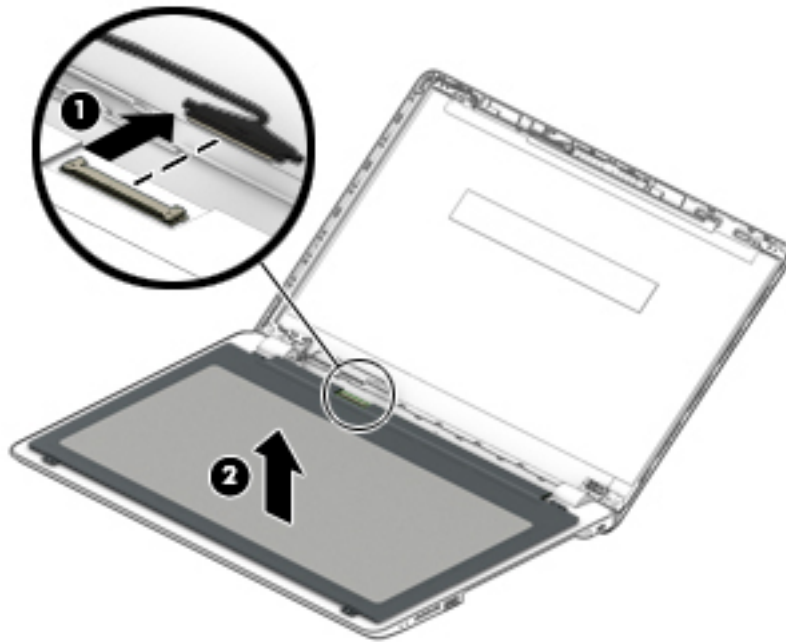

Reverse this procedure to reassemble and install the display assembly components.

## Rubber feet

Description	Spare part number
<b>Rubber feet, upper</b>	
Asteroid silver	931599-001
Dark ash silver	931600-001
<b>Rubber feet, lower</b>	
Asteroid silver	931601-001
Dark ash silver	931602-001

Before removing the rubber feet, follow these steps:

1. Shut down the computer. If you are unsure whether the computer is off or in Hibernation, turn the computer on, and then shut it down through the operating system.
2. Disconnect all external devices connected to the computer.
3. Disconnect the power from the computer by first unplugging the power cord from the AC outlet and then unplugging the AC adapter from the computer.

To remove the rubber feet:

- ▲ Peel the lower rubber feet **(1)** and upper rubber feet **(2)** from the bottom of the computer.



**NOTE:** The lower feet and upper feet are different sizes.

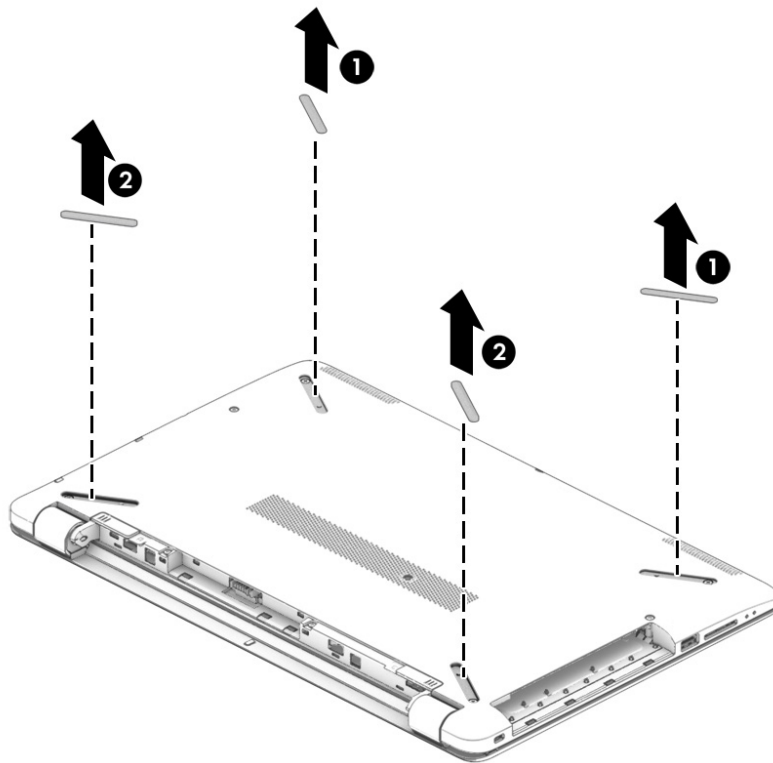

Reverse this procedure to install the rubber feet.

## Bottom cover

Description	Spare part number
Bottom cover for use in models with an optical drive:	
<ul style="list-style-type: none"><li>Asteroid silver</li></ul>	929894-001
<ul style="list-style-type: none"><li>Dark ash silver</li></ul>	929895-001
Bottom cover for use in models without an optical drive:	
<ul style="list-style-type: none"><li>Dark ash silver</li></ul>	929897-001

Before removing the bottom cover, follow these steps:

1. Shut down the computer. If you are unsure whether the computer is off or in Hibernation, turn the computer on, and then shut it down through the operating system.
2. Disconnect all external devices connected to the computer.
3. Disconnect the power from the computer by first unplugging the power cord from the AC outlet and then unplugging the AC adapter from the computer.
4. Remove the battery (see [Battery on page 32](#)).
5. Remove the optical drive (see [Optical drive on page 33](#)), if installed.

To remove the bottom cover:

1. Position the computer upside down with the front toward you.
2. Peel back the rubber feet enough to access the screws underneath **(1)**



3. Remove the 9 Phillips PM2.5×11.0 screws (2) that secure the bottom cover to the computer.

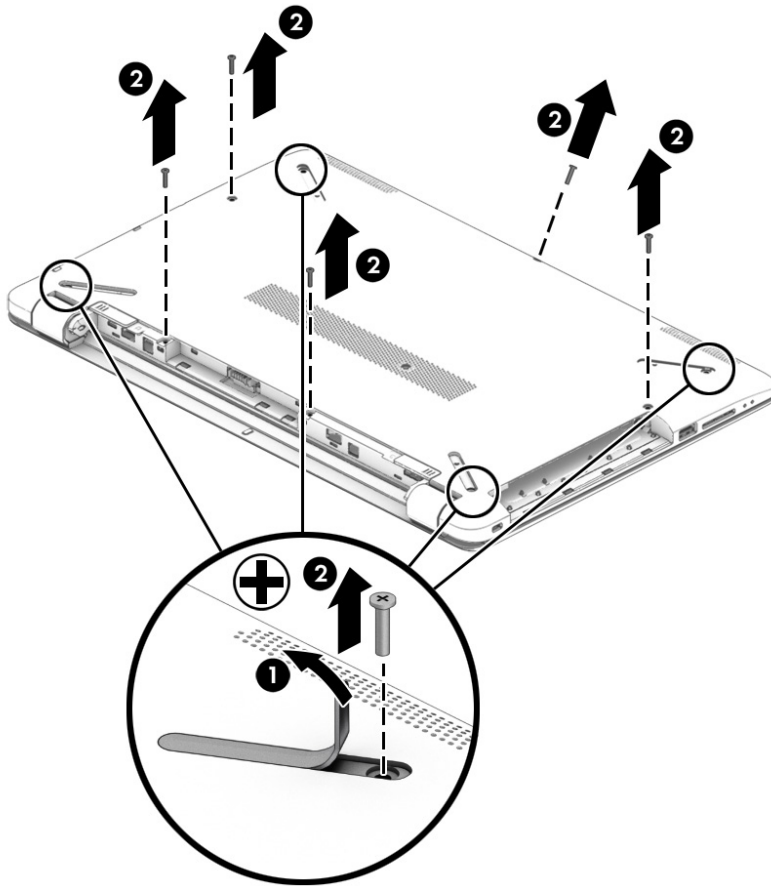

4. Start prying at the front of the computer and work around to the back to separate the bottom cover from computer **(1)**, and then remove the bottom cover **(2)**.

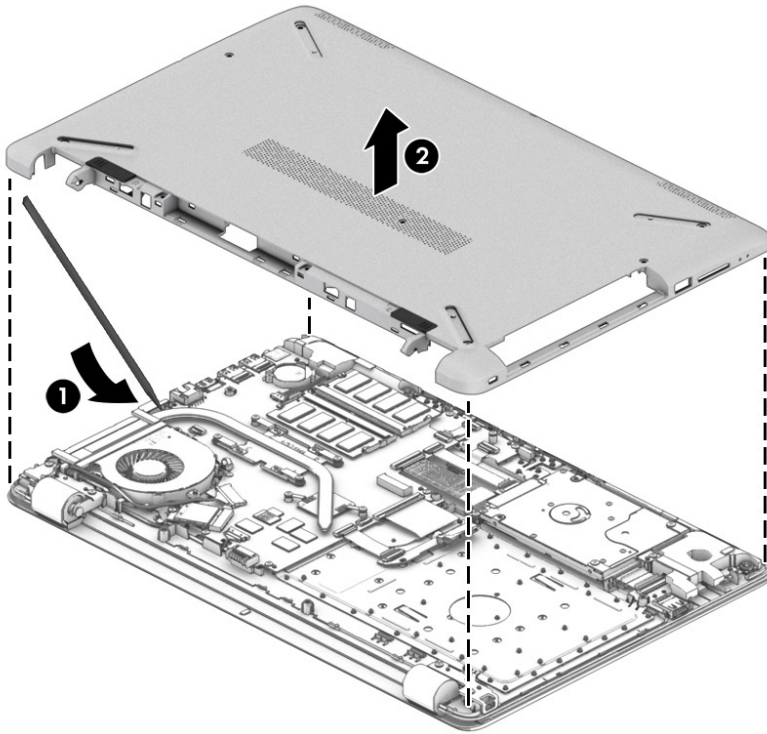

Reverse this procedure to install the bottom cover.

## WLAN module

Description	Spare part number
Intel Dual Band Wireless-AC 7265 802.11AC 2x2 WiFi + BT 4.2 Combo Adapter (non-vPro)	901229-855
Realtek RTL8723BE-VB 802.11b/g/n 1x1 Wi-Fi + BT4.0 Combo Adapter	855106-855
Intel Dual Band Wireless-AC 3168 802.11 ac 1x1 WiFi + BT 4.2 Combo Adapter	863934-855

 **CAUTION:** To prevent an unresponsive system, replace the wireless module only with a wireless module authorized for use in the computer by the governmental agency that regulates wireless devices in your country or region. If you replace the module and then receive a warning message, remove the module to restore device functionality, and then contact support.

Before removing the WLAN module, follow these steps:

1. Shut down the computer. If you are unsure whether the computer is off or in Hibernation, turn the computer on, and then shut it down through the operating system.
2. Disconnect all external devices connected to the computer.
3. Disconnect the power from the computer by first unplugging the power cord from the AC outlet and then unplugging the AC adapter from the computer.
4. Remove the battery (see [Battery on page 32](#)).
5. Remove the optical drive (see [Optical drive on page 33](#)), if installed.
6. Remove the bottom cover (see [Bottom cover on page 40](#)).

To remove the WLAN module:

1. Disconnect the WLAN antenna cables **(1)** from the terminals on the WLAN module.



**NOTE:** The WLAN antenna cable labeled “1” connects to the WLAN module “Main” terminal labeled “1”. The WLAN antenna cable labeled “2” connects to the WLAN module “Aux” terminal labeled “2” (if applicable).

2. Remove the Phillips PM2.0×3.0 screw **(2)** that secures the WLAN module to the system board. (The WLAN module tilts up.)

3. Remove the WLAN module by pulling the module away from the slot at an angle (3).

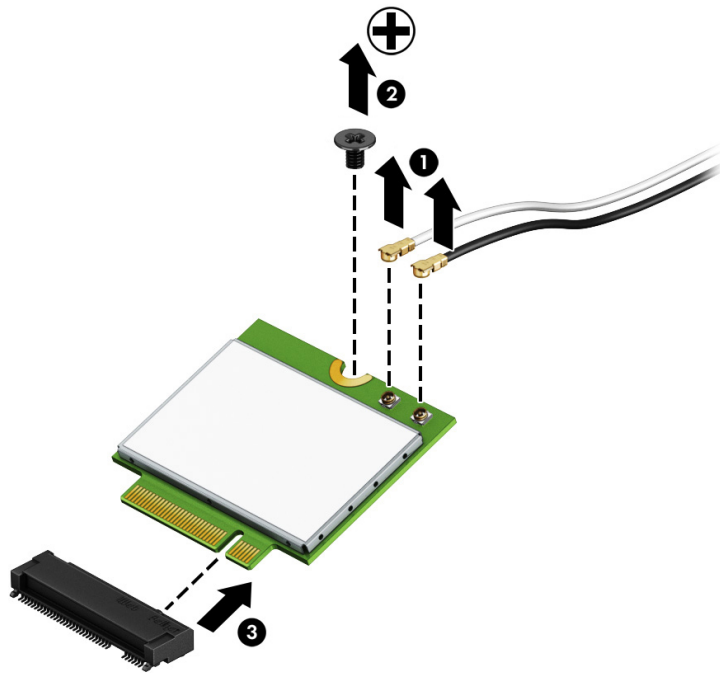

**NOTE:** If the WLAN antennas are not connected to the terminals on the WLAN module, the protective sleeves must be installed on the antenna connectors, as shown in the following illustration.

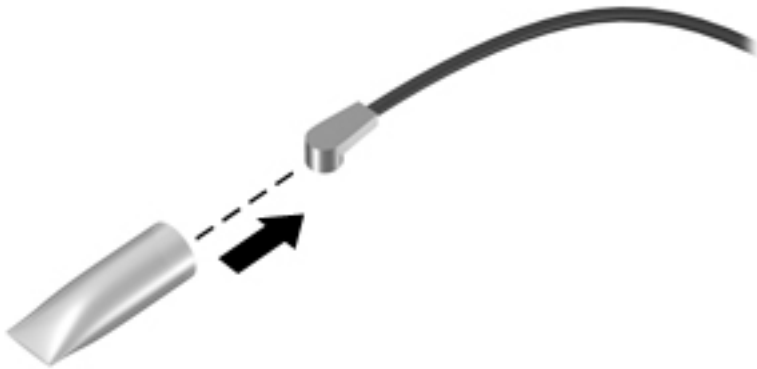

Reverse this procedure to install the WLAN module.

## Memory module

Description	Spare part number
<b>Memory module (PC3L-1600)</b>	
For use in models with Intel Pentium and Celeron processors:	
8-GB	693374-005
4-GB	691740-005
2-GB	691739-005
<b>Memory module (PC4-2400)</b>	
For use in models with 6th and 7th generation Intel Core processors:	
8-GB	862398-855
4-GB	862397-855
2-GB	864271-855

Before removing a memory module, follow these steps:

1. Shut down the computer. If you are unsure whether the computer is off or in Hibernation, turn the computer on, and then shut it down through the operating system.
2. Disconnect all external devices connected to the computer.
3. Disconnect the power from the computer by first unplugging the power cord from the AC outlet and then unplugging the AC adapter from the computer.
4. Remove the battery (see [Battery on page 32](#)).
5. Remove the optical drive (see [Optical drive on page 33](#)), if installed.
6. Remove the bottom cover (see [Bottom cover on page 40](#)).

To remove a memory module:

1. Spread the retaining tabs **(1)** on each side of the memory module slot to release the memory module. (The memory module tilts up.)

2. Remove the memory module **(2)** by pulling it away from the slot at an angle.

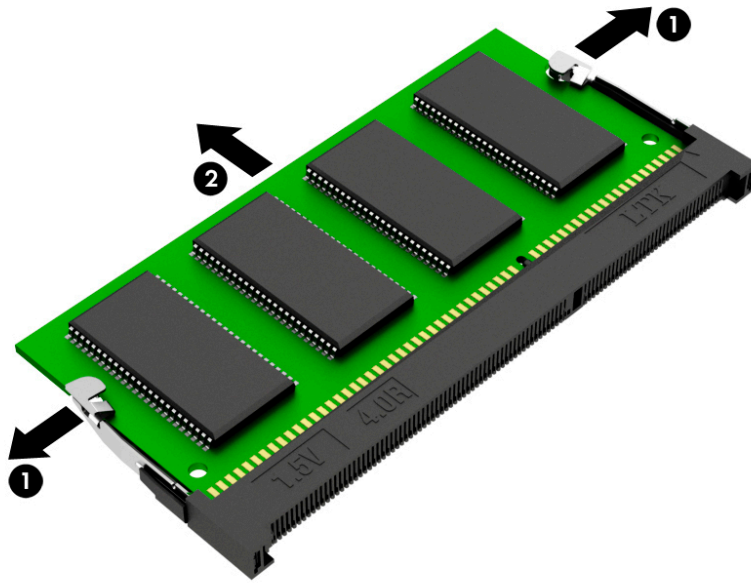

Reverse this procedure to install a memory module.

## Optical drive connector board

Description	Spare part number
Optical drive connector board	924990-001
Optical drive cable	924926-001

Before removing the optical drive connector board, follow these steps:

1. Shut down the computer. If you are unsure whether the computer is off or in Hibernation, turn the computer on, and then shut it down through the operating system.
2. Disconnect all external devices connected to the computer.
3. Disconnect the power from the computer by first unplugging the power cord from the AC outlet and then unplugging the AC adapter from the computer.
4. Remove the battery (see [Battery on page 32](#)).
5. Remove the optical drive (see [Optical drive on page 33](#)), if installed.
6. Remove the bottom cover (see [Bottom cover on page 40](#)).

To remove the optical drive connector board:

1. Disconnect the cable from the optical drive connector board **(1)**.
2. Remove the Phillips PM2.0×2.0 screw **(2)** that secures the optical drive connector board to the computer.
3. Rotate the connector side of the board upward, and then pull the board up and out of the computer **(3)**.

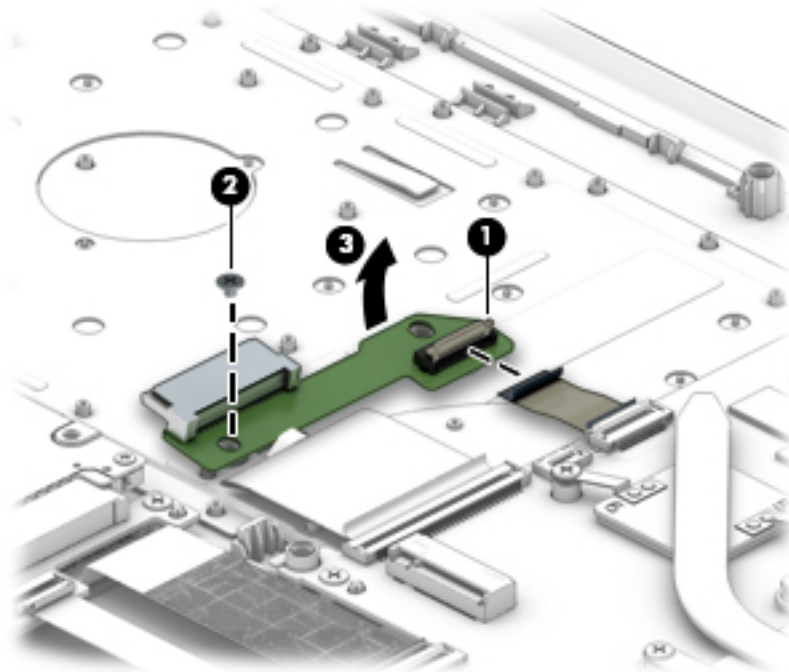

Reverse this procedure to install the optical drive board connector.

## Hard drive and hard drive connector board



**NOTE:** The hard drive spare part kit does not include the hard drive bracket, cable, or connector board.

Description	Spare part number
<b>Hard drives:</b>	
1-TB, 5400-rpm	778192-005
500-GB, 7200-rpm	703267-005
500-GB, 5400-rpm	778186-005
<b>Hard drive bracket</b>	924980-001

Before removing the hard drive, follow these steps:

1. Shut down the computer. If you are unsure whether the computer is off or in Hibernation, turn the computer on, and then shut it down through the operating system.
2. Disconnect all external devices connected to the computer.
3. Disconnect the power from the computer by first unplugging the power cord from the AC outlet and then unplugging the AC adapter from the computer.
4. Remove the battery (see [Battery on page 32](#)).
5. Remove the optical drive (see [Optical drive on page 33](#)), if installed.
6. Remove the bottom cover (see [Bottom cover on page 40](#)).

To remove the hard drive:

1. Remove the Phillips PM2.0×3.0 screw **(1)** that secures the hard drive assembly to the computer.
2. Lift the rear of the hard drive upward **(2)**.



3. Pull the hard drive assembly away from connector to remove it **(3)**.

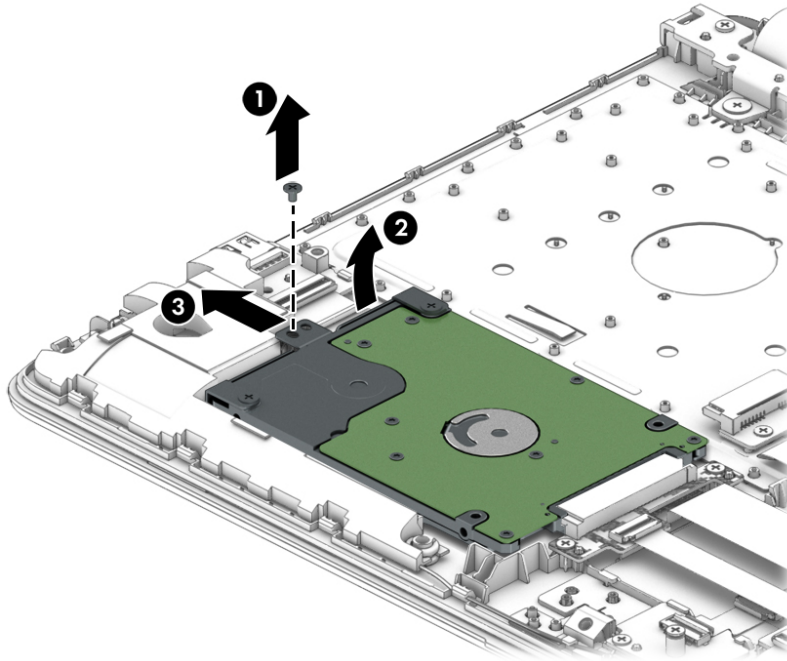

4. To remove the hard drive bracket, remove the two Phillips PM3.0×3.0 screws **(1)** that secure the bracket to the hard drive.
5. Remove the hard drive bracket from the hard drive **(2)**.

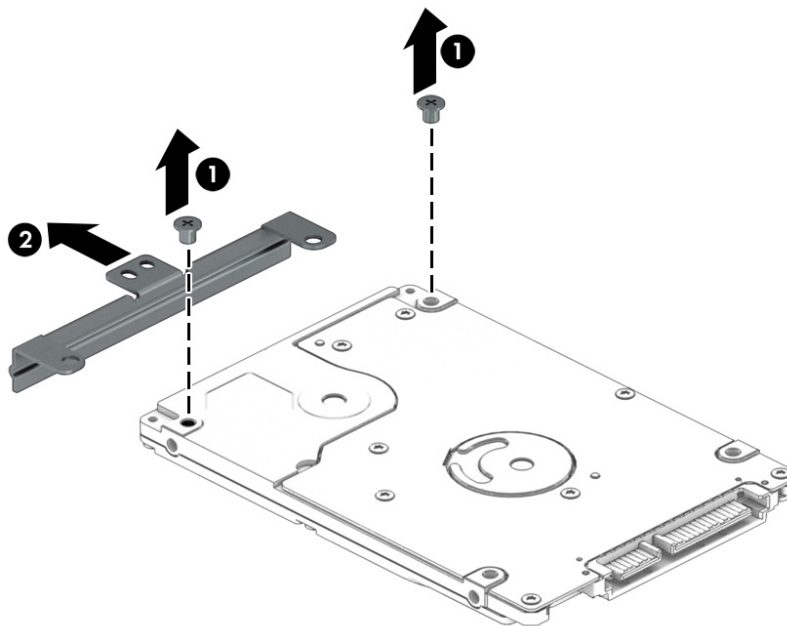

6. To remove the hard drive connector board, disconnect the cable from the board **(1)**.
7. Remove the two Phillips PM2.0×3.0 screws **(2)** that secure the hard drive board to the computer.

8. Remove the hard drive board from the computer **(3)**.

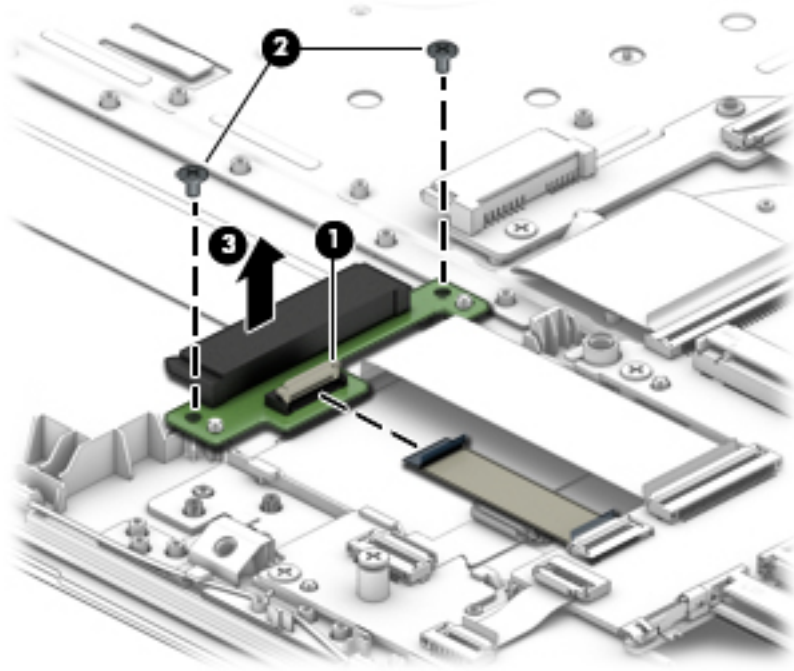

Reverse this procedure to reassemble and install the hard drive.

## M.2 solid-state drive adapter bracket and connector board



**NOTE:** You can install an M.2 solid-state drive into the hard drive bay using an adapter bracket and connector board.

Description	Spare part number
Solid-state drive board	924992-001
Solid-state drive bracket	924981-001

Before removing the solid-state drive adapter bracket and connector board, follow these steps:

1. Shut down the computer. If you are unsure whether the computer is off or in Hibernation, turn the computer on, and then shut it down through the operating system.
2. Disconnect all external devices connected to the computer.
3. Disconnect the power from the computer by first unplugging the power cord from the AC outlet and then unplugging the AC adapter from the computer.
4. Remove the battery (see [Battery on page 32](#)).
5. Remove the optical drive (see [Optical drive on page 33](#)), if installed.
6. Remove the bottom cover (see [Bottom cover on page 40](#)).

To remove the solid-state drive adapter bracket and connector board:

1. Disconnect the cable from the connector board **(1)**.
2. Remove the two Phillips PM2.0×3.0 screws **(2)** that secure the connector board to the computer.
3. Lift the connector board out of the computer **(3)**.
4. Remove the Phillips PM2.0×3.0 screw **(4)** that secures the adapter bracket to the computer.

5. Lift the adapter bracket out of the computer (5)

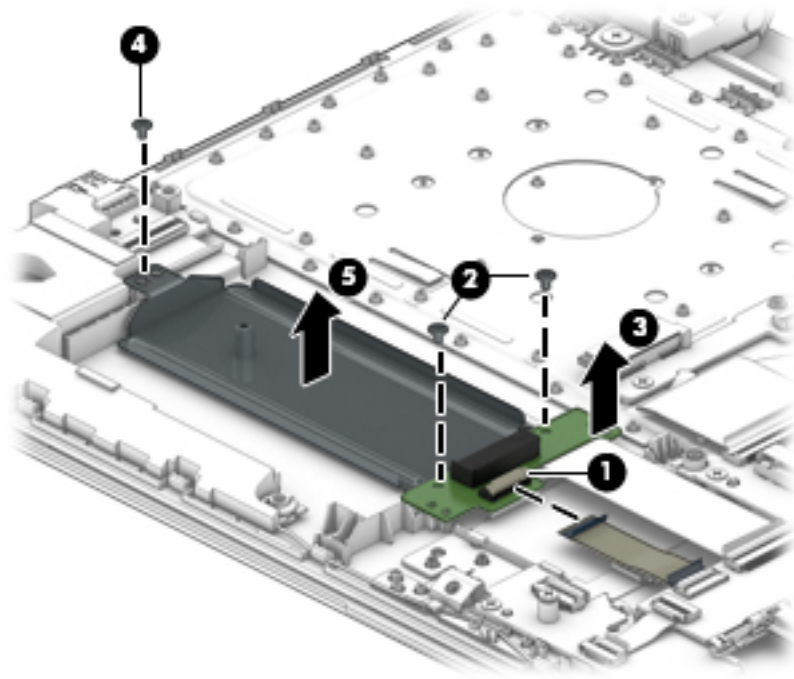

Reverse this procedure to reassemble and install the solid-state drive adapter bracket and connector board.

## Solid-state drive (SSD)

Description	Spare part number
512 GB	926255-001
256 GB	926254-001
128 GB	926253-001

Before removing the solid-state drive, follow these steps:

1. Shut down the computer. If you are unsure whether the computer is off or in Hibernation, turn the computer on, and then shut it down through the operating system.
2. Disconnect all external devices connected to the computer.
3. Disconnect the power from the computer by first unplugging the power cord from the AC outlet and then unplugging the AC adapter from the computer.
4. Remove the battery (see [Battery on page 32](#)).
5. Remove the optical drive (see [Optical drive on page 33](#)), if installed.
6. Remove the bottom cover (see [Bottom cover on page 40](#)).

Remove the solid-state drive:

1. Remove the Phillips PM2.0×2.0 screw **(1)** that secures the drive to the system board.
2. Remove the drive **(2)** by pulling it away from the connector.

 **NOTE:** Solid-state drives are designed with notches to prevent incorrect insertion.

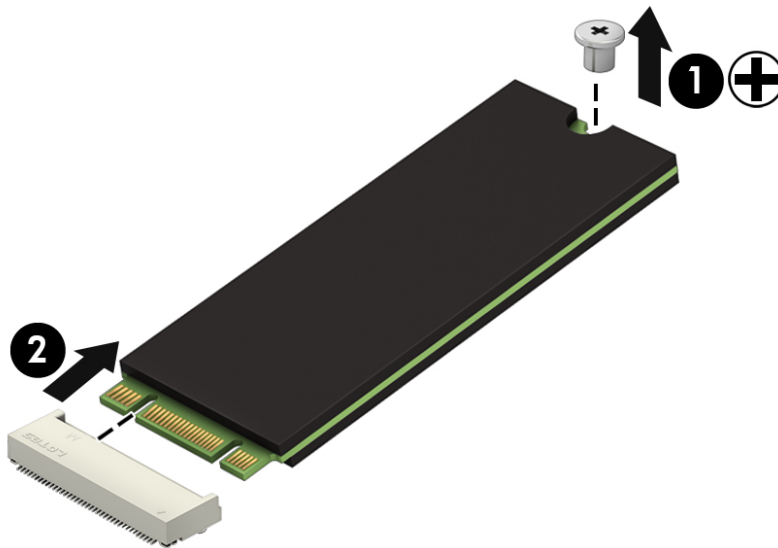

Reverse this procedure to reassemble and install the solid-state drive.

## RTC battery

Description	Spare part number
RTC battery	922847-001

Before removing the RTC battery, follow these steps:

1. Shut down the computer. If you are unsure whether the computer is off or in Hibernation, turn the computer on, and then shut it down through the operating system.
2. Disconnect all external devices connected to the computer.
3. Disconnect the power from the computer by first unplugging the power cord from the AC outlet and then unplugging the AC adapter from the computer.
4. Remove the battery (see [Battery on page 32](#)).
5. Remove the optical drive (see [Optical drive on page 33](#)), if installed.
6. Remove the bottom cover (see [Bottom cover on page 40](#)).

To remove the RTC battery:

- ▲ Using a thin tool or screwdriver, disengage the battery from the socket **(1)**, and then remove the battery **(2)**.

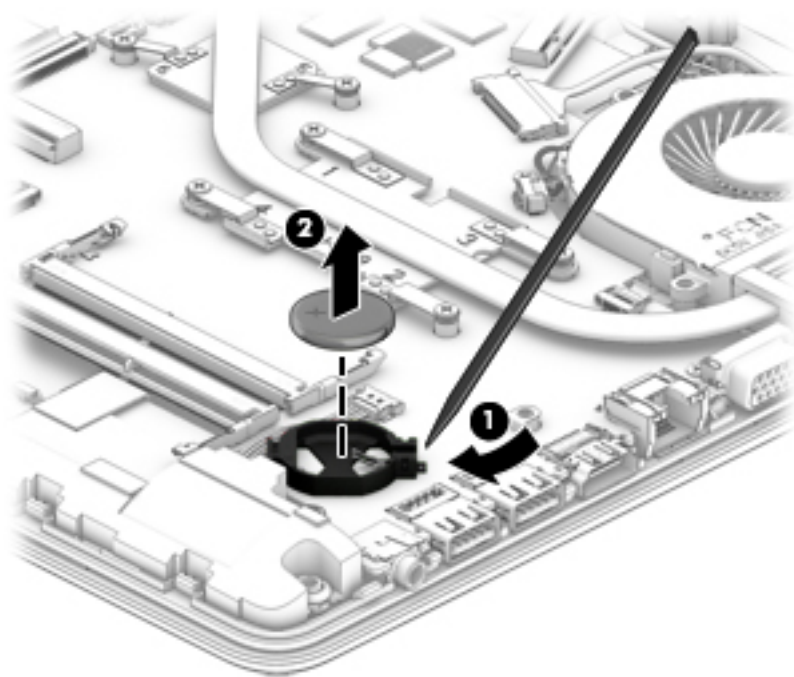

Reverse this procedure to install the RTC battery.

## Speakers

Description	Spare part number
Speakers (includes left and right speakers and cable)	925306-001

Before removing the speakers, follow these steps:

1. Shut down the computer. If you are unsure whether the computer is off or in Hibernation, turn the computer on, and then shut it down through the operating system.
2. Disconnect all external devices connected to the computer.
3. Disconnect the power from the computer by first unplugging the power cord from the AC outlet and then unplugging the AC adapter from the computer.
4. Remove the battery (see [Battery on page 32](#)).
5. Remove the optical drive (see [Optical drive on page 33](#)), if installed.
6. Remove the bottom cover (see [Bottom cover on page 40](#)).

To remove the speakers:

1. Disconnect the speaker cable from the system board (1).
2. Remove the cable from its routing path along the bottom of the computer (2), and then lift up and remove the speakers from the computer (3).

 **NOTE:** The speakers are not secured with screws. Note the rubber gaskets (4) that help secure the speakers to the computer. When installing the speakers, make sure the gaskets are installed correctly.



Reverse this procedure to install the speakers.

## USB board

Description	Spare part number
USB board	924991-001
USB board cable	924929-001

Before removing the USB board, follow these steps:

1. Shut down the computer. If you are unsure whether the computer is off or in Hibernation, turn the computer on, and then shut it down through the operating system.
2. Disconnect all external devices connected to the computer.
3. Disconnect the power from the computer by first unplugging the power cord from the AC outlet and then unplugging the AC adapter from the computer.
4. Remove the battery (see [Battery on page 32](#)).
5. Remove the optical drive (see [Optical drive on page 33](#)), if installed.
6. Remove the bottom cover (see [Bottom cover on page 40](#)).
7. Remove the speakers (see [Speakers on page 55](#)).

To remove the USB board:

1. Disconnect the USB board cable from the USB board **(1)**.
2. Remove the Phillips PM2.0×3.0 screw **(2)** that secures the USB board to the computer.
3. Remove the USB board **(3)**.

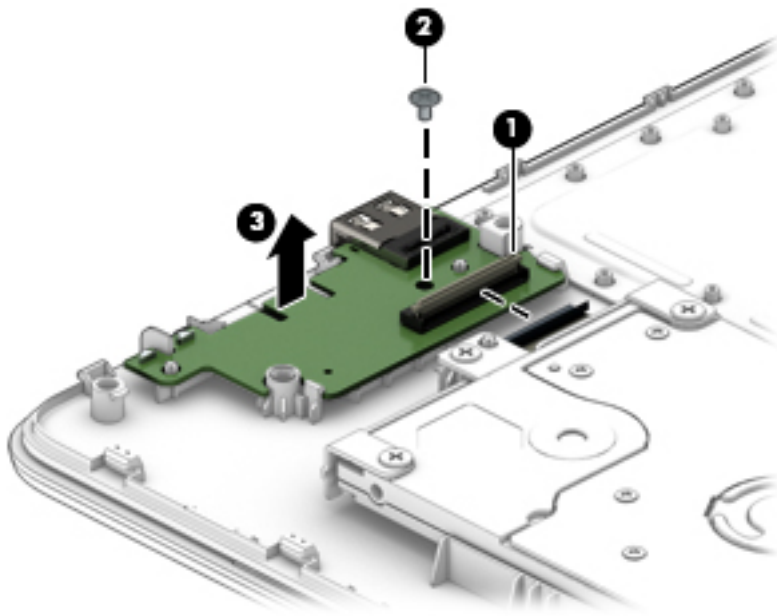

Reverse this procedure to install the USB board.



## Fan

Description	Spare part number
Fan	925012-001



**NOTE:** To properly ventilate the computer, allow at least **7.6 cm** (3.0 in) of clearance on the left side of the computer. The computer uses an electric fan for ventilation. The fan is controlled by a temperature sensor and is designed to turn on automatically when high temperature conditions exist. These conditions are affected by high external temperatures, system power consumption, power management/battery conservation configurations, battery fast charging, and software requirements. Exhaust air is displaced through the ventilation grill located on the left side of the computer.

Before removing the fan/heat sink assembly, follow these steps:

1. Shut down the computer. If you are unsure whether the computer is off or in Hibernation, turn the computer on, and then shut it down through the operating system.
2. Disconnect all external devices connected to the computer.
3. Disconnect the power from the computer by first unplugging the power cord from the AC outlet and then unplugging the AC adapter from the computer.
4. Remove the battery (see [Battery on page 32](#)).
5. Remove the optical drive (see [Optical drive on page 33](#)), if installed.
6. Remove the bottom cover (see [Bottom cover on page 40](#)).

To remove the fan:

1. Lift the cables (antenna, display, power connector) from atop the screw **(1)**.
2. Disconnect the fan cable **(2)** from the system board.
3. Remove the Phillips PM2.5×6.5 screw **(3)** that secures the fan to the computer.

4. Remove the fan from the computer (4).

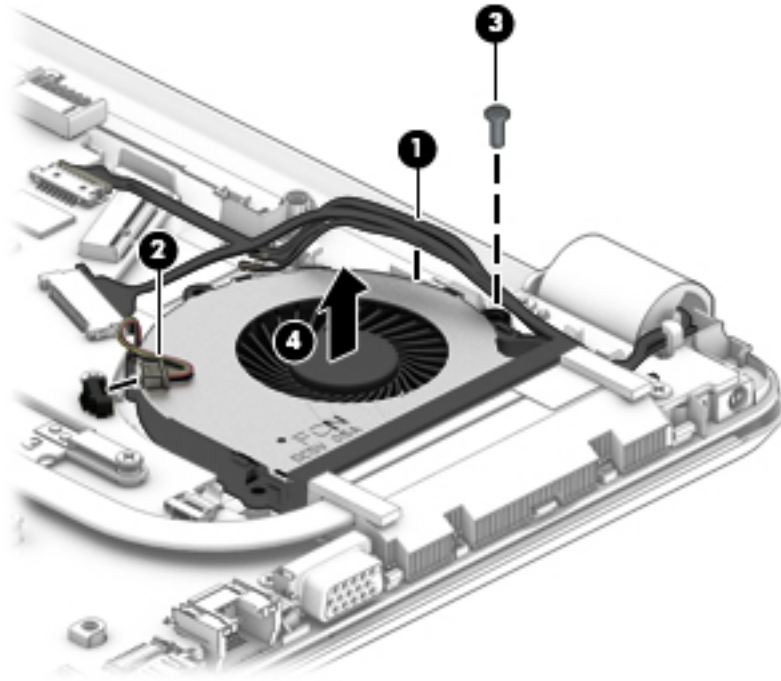

Reverse this procedure to install the fan.

## Heat sink assembly

 **NOTE:** The heat sink assembly spare part kit includes replacement thermal materials.

Description	Spare part number
Heat sink for use in models with discrete graphics memory and 6th or 7th generation Intel Core processors	924976-001
Heat sink for use in models with discrete graphics memory and Intel Pentium or Celeron processors	924978-001
Heat sink for use in models with UMA graphics memory and 6th or 7th generation Intel Core processors	924975-001
Heat sink for use in models with UMA graphics and Intel Pentium or Celeron processors	924977-001

 **NOTE:** To properly ventilate the computer, allow at least **7.6 cm (3.0 in)** of clearance on the left side of the computer. The computer uses an electric fan for ventilation. The fan is controlled by a temperature sensor and is designed to turn on automatically when high temperature conditions exist. These conditions are affected by high external temperatures, system power consumption, power management/battery conservation configurations, battery fast charging, and software requirements. Exhaust air is displaced through the ventilation grill located on the left side of the computer.

Before removing the heat sink assembly, follow these steps:

1. Shut down the computer. If you are unsure whether the computer is off or in Hibernation, turn the computer on, and then shut it down through the operating system.
2. Disconnect all external devices connected to the computer.
3. Disconnect the power from the computer by first unplugging the power cord from the AC outlet and then unplugging the AC adapter from the computer.
4. Remove the battery (see [Battery on page 32](#)).
5. Remove the optical drive (see [Optical drive on page 33](#)), if installed.
6. Remove the bottom cover (see [Bottom cover on page 40](#)).

To remove the heat sink assembly:

1. Refer to the following heat sink removal image that matches your computer.
2. In the order indicated on the heat sink, remove the screws that secure the heat sink assembly to the system board.
3. Remove the heat sink assembly from the system board.

 **NOTE:** Heat sink appearance may vary.

### Discrete graphics

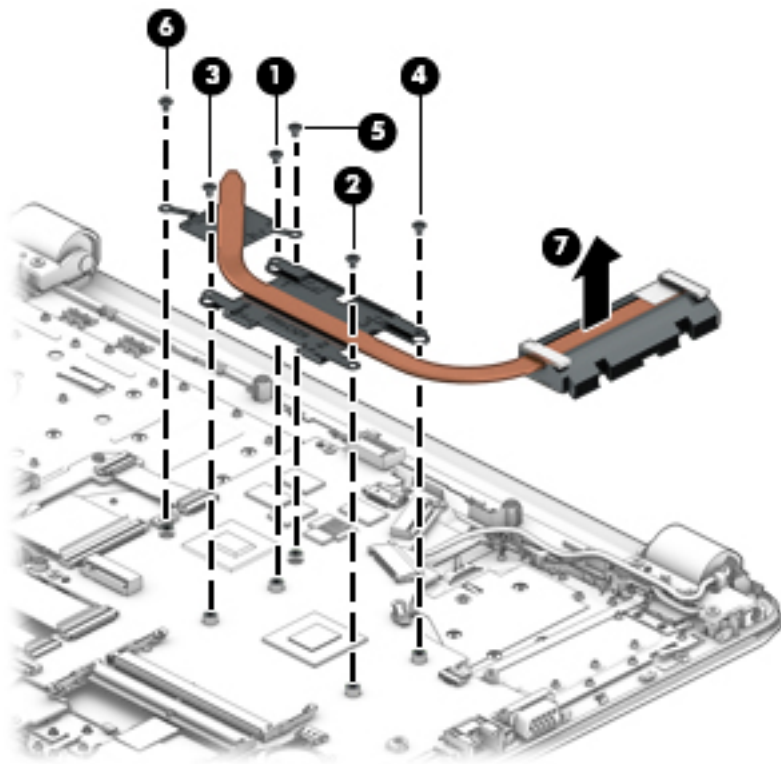

- **Discrete graphics** Thermal paste is used on the processor and associated heat sink area **(1)(2)**, as well as the graphics chip and associated heat sink area **(3)(4)**.

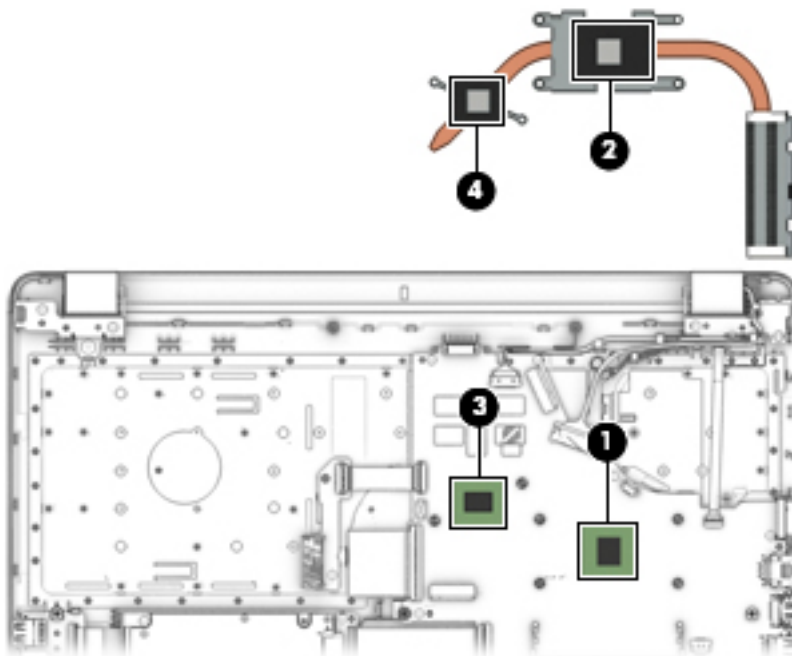

#### 4. UMA graphics

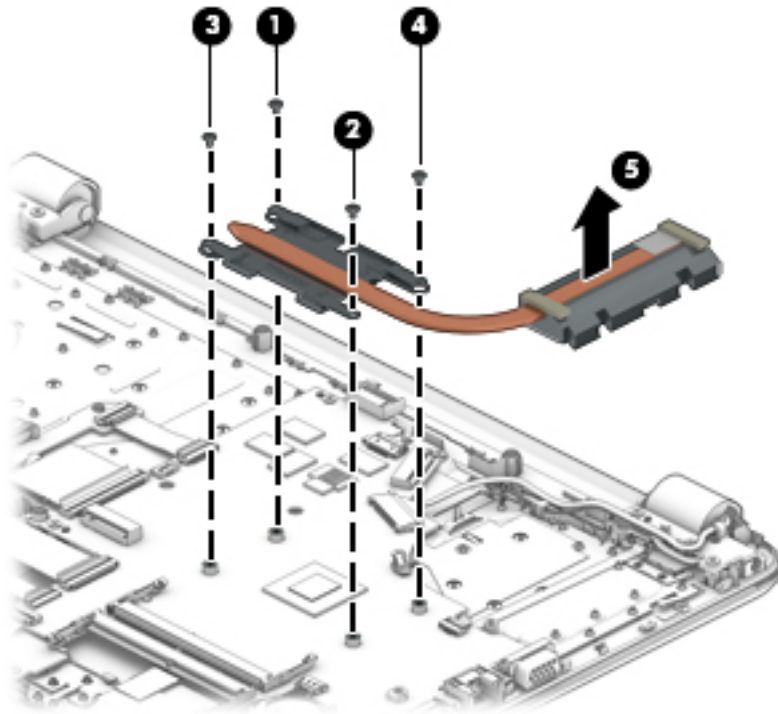

- **UMA graphics** Thermal paste is used on the heat sink (1) and the processor (2).

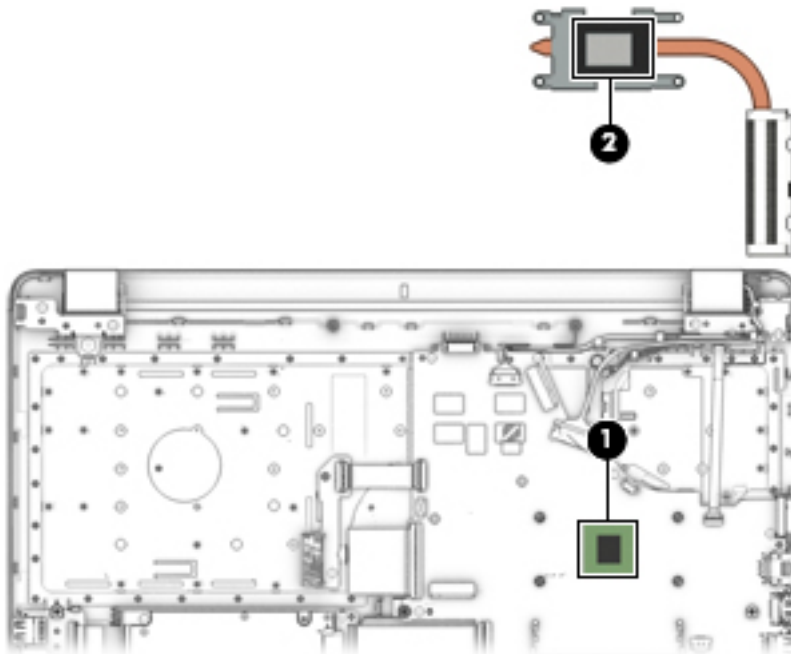

#### 5. UMA graphics (fanless)

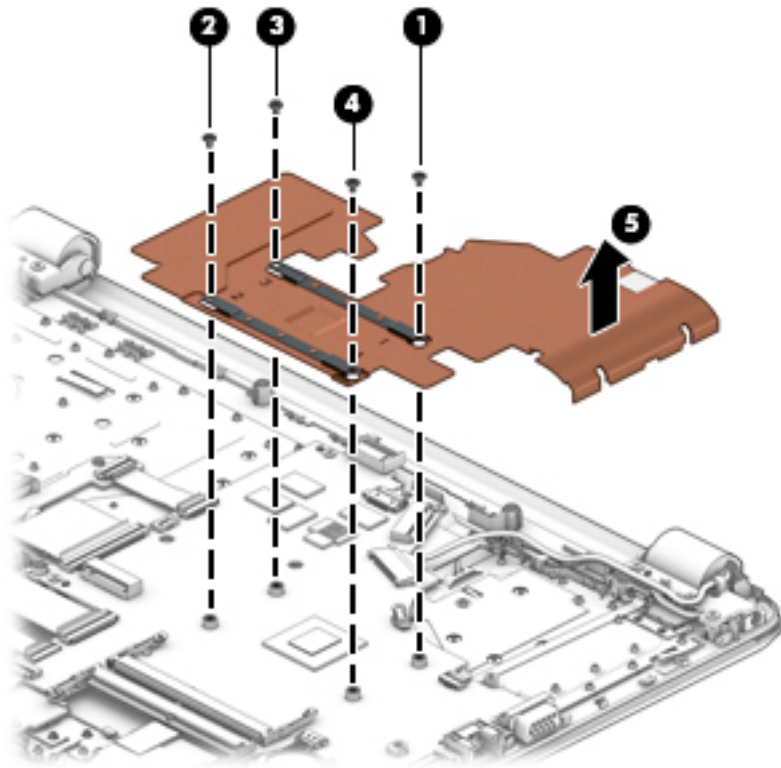

- **UMA graphics (fanless)** Thermal paste is used on the heat sink (1) and the processor (2).

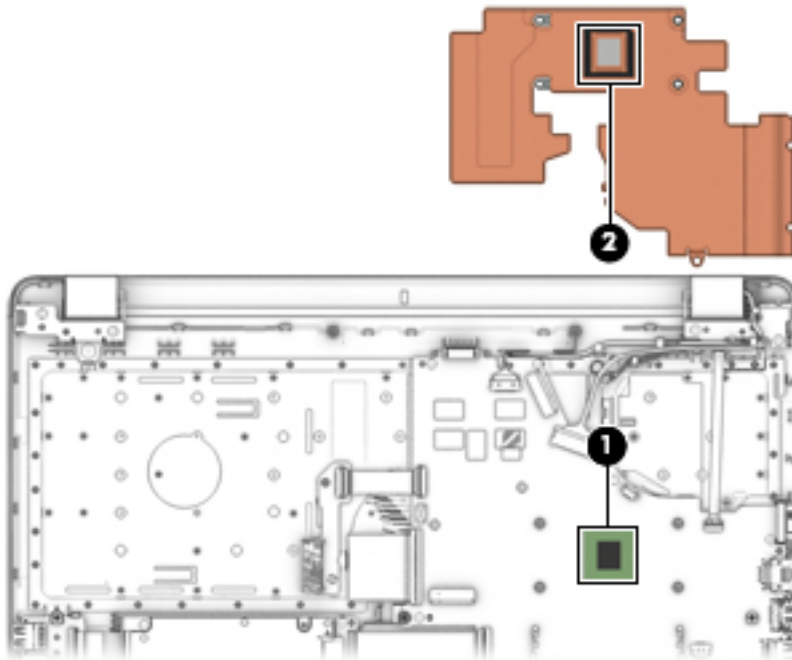

Reverse this procedure to reassemble and install the heat sink assembly.

## TouchPad button board

Description	Spare part number
TouchPad button board	924993-001
TouchPad button board cable	924934-001
TouchPad cable	924928-001

Before removing the TouchPad button board, follow these steps:

1. Shut down the computer. If you are unsure whether the computer is off or in Hibernation, turn the computer on, and then shut it down through the operating system.
2. Disconnect all external devices connected to the computer.
3. Disconnect the power from the computer by first unplugging the power cord from the AC outlet and then unplugging the AC adapter from the computer.
4. Remove the battery (see [Battery on page 32](#)).
5. Remove the optical drive (see [Optical drive on page 33](#)), if installed.
6. Remove the bottom cover (see [Bottom cover on page 40](#)).

To remove the TouchPad button board:

1. Disconnect the system board cable **(1)** and the TouchPad cable from the TouchPad button board **(2)**.
2. Remove the two Phillips PM2.0×3.0 screws **(3)** that secure the TouchPad button board to the computer.
3. Pull the TouchPad button board toward the bottom of the computer, and then remove the TouchPad button board **(4)**.

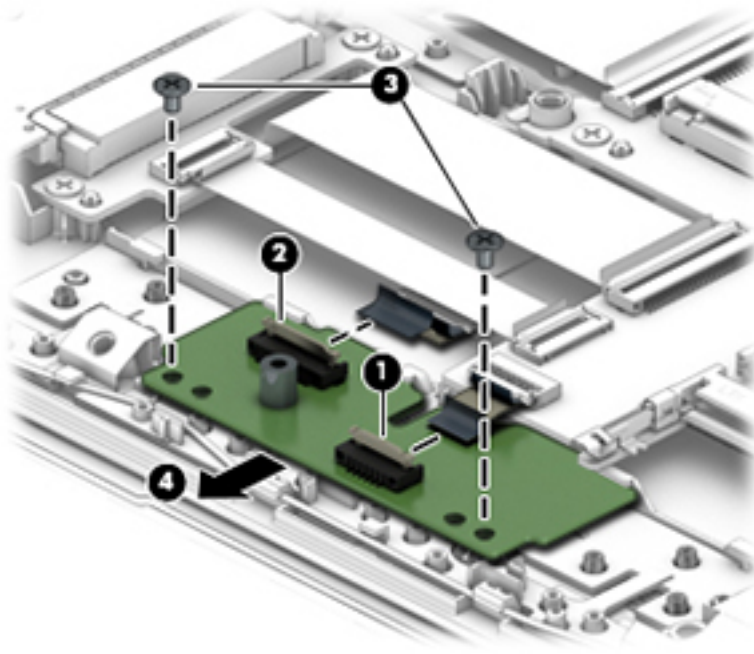

Reverse this procedure to install the TouchPad button board.

## System board



**NOTE:** The system board spare part kit includes replacement thermal materials.

Description	Spare part number
<b>System board</b> (includes replacement thermal materials):	
All system boards use the following part numbers:	
xxxxxx-001: Non-Windows operating systems	
xxxxxx-601: Windows 10 operating system	
For use in models with discrete graphics memory	
<ul style="list-style-type: none"><li>Intel Core i5-7200U processor and 2 GB of discrete graphics memory</li></ul>	926248-xx1
<ul style="list-style-type: none"><li>Intel Core i3-6006U processor and 2 GB of discrete graphics memory</li></ul>	926249-xx1
For use in models with UMA graphics memory:	
<ul style="list-style-type: none"><li>Intel Core i7-7500U processor</li></ul>	926246-xx1
<ul style="list-style-type: none"><li>Intel Core i5-7200U processor</li></ul>	926247-xx1
<ul style="list-style-type: none"><li>Intel Core i3-6006U processor</li></ul>	926249-xx1
<ul style="list-style-type: none"><li>Intel Pentium N4200 processor</li></ul>	934736-001
<ul style="list-style-type: none"><li>Intel Pentium N3710 processor</li></ul>	926251-xx1
<ul style="list-style-type: none"><li>Intel Celeron N3350 processor</li></ul>	934737-001
<ul style="list-style-type: none"><li>Intel Celeron N3060 processor</li></ul>	926252-xx1

Before removing the system board, follow these steps:

1. Shut down the computer. If you are unsure whether the computer is off or in Hibernation, turn the computer on, and then shut it down through the operating system.
2. Disconnect all external devices connected to the computer.
3. Disconnect the power from the computer by first unplugging the power cord from the AC outlet and then unplugging the AC adapter from the computer.
4. Remove the battery (see [Battery on page 32](#)).
5. Remove the optical drive (see [Optical drive on page 33](#)), if installed.
6. Remove the bottom cover (see [Bottom cover on page 40](#)).
7. Remove the WLAN module (see [WLAN module on page 43](#)).
8. Remove the memory module (see [Memory module on page 45](#)).
9. Remove the solid-state drive (see [Solid-state drive \(SSD\) on page 53](#)).

To remove the system board:

1. Position the computer upright, and then disconnect the following cables from the system board:
  - (1): Power connector cable
  - (2): Display cable



- (3): Power button board cable
- (4): Speaker cable
- (5): TouchPad cable
- (6): Hard drive connector cable
- (7): USB board cable
- (8): Keyboard cable
- (9): Optical drive board cable

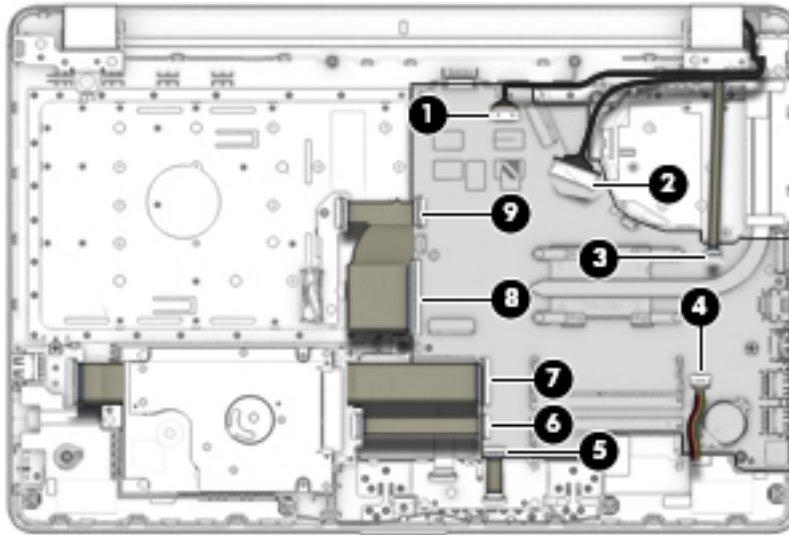

2. Remove the six Phillips PM2.0×3.0 screws **(1)** that secure the system board to the computer.

3. Rotate the side of the board upward **(2)**, and then lift the system board out of the computer **(3)**.

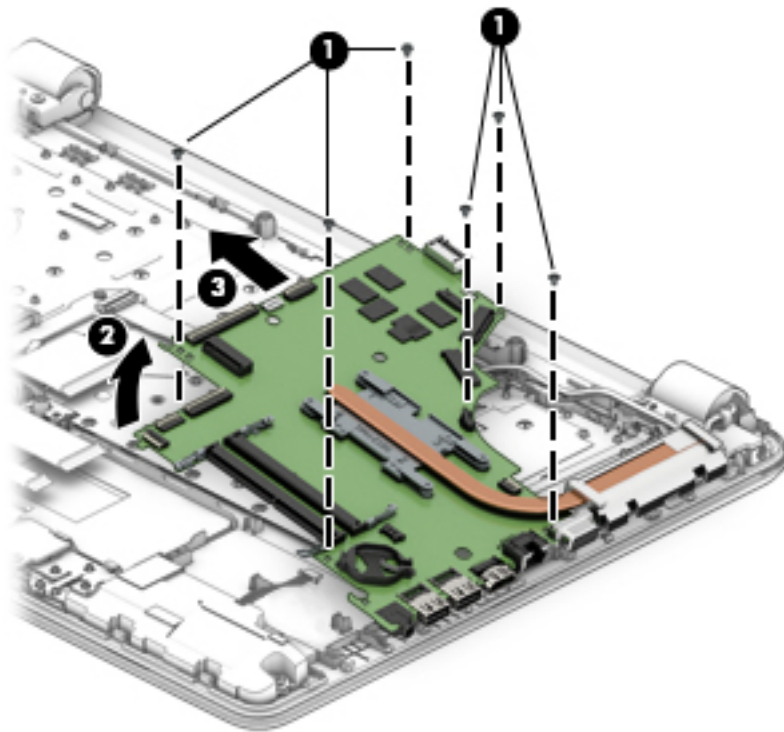

Reverse this procedure to install the system board.

## Display assembly

This section describes removing the display assembly and disassembling display subcomponents. You must remove the display from the computer to disassemble display subcomponents.

Before removing the display assembly, follow these steps:

1. Shut down the computer. If you are unsure whether the computer is off or in Hibernation, turn the computer on, and then shut it down through the operating system.
2. Disconnect all external devices connected to the computer.
3. Disconnect the power from the computer by first unplugging the power cord from the AC outlet and then unplugging the AC adapter from the computer.
4. Remove the battery (see [Battery on page 32](#)).
5. Remove the optical drive (see [Optical drive on page 33](#)), if installed.
6. Remove the bottom cover (see [Bottom cover on page 40](#)).
7. Remove the fan (see [Fan on page 57](#)).

To remove the display assembly:

1. Disconnect the display panel cable from the system board **(1)**.
2. Disconnect the wireless antennas from the WLAN module **(2)**.
3. Remove the four Phillips PM2.5×6.0 screws **(3)** (two from each hinge) and one broadhead Phillips PM2.0×2.0 screw **(4)** (on the left hinge) that secures the display assembly to the computer.

4. Lift the display to bend the hinges upward (5).
5. Separate the display from the computer (6).

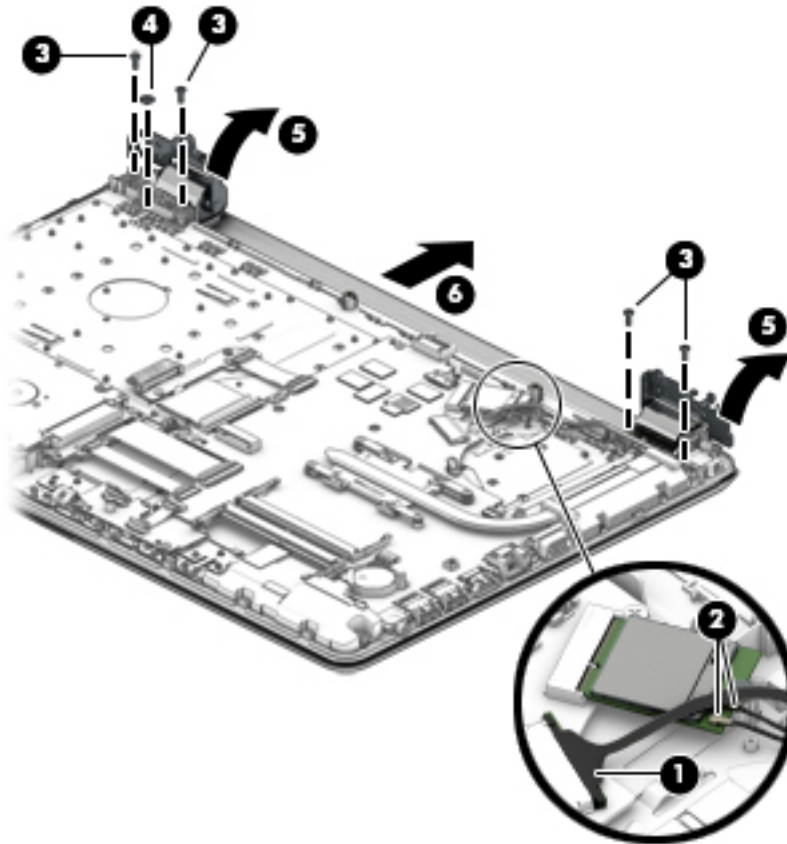

If it is necessary to replace any of the display assembly subcomponents:

1. To remove the display bezel:
  - a. Flex the inside of the top edge (1), the left and right edges (2), and the bottom edge (3) of the display bezel until the bezel disengages from the display enclosure.

 **NOTE:** When removing the bezel from the bottom of the display (3), be careful not to peel the Mylar from the bottom of the display panel.

- b.** Remove the display bezel **(4)**.

 **NOTE:** The display will not be connected to the computer as shown in the following image.

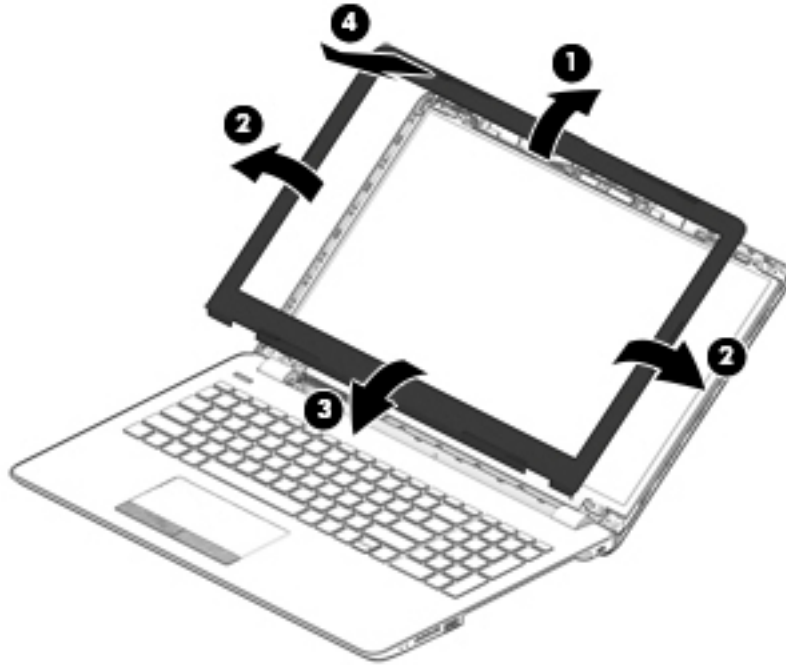

- 2.** To remove the camera/microphone module:
  - a.** Position the display assembly with the top edge toward you.
  - b.** Pry up to disengage the camera/microphone module from the adhesive that secures it to the display **(1)**.
  - c.** Disconnect the cable **(2)** from the module.

- d. Remove the tape from the enclosure **(3)**. Replacement cameras come with tape already installed.

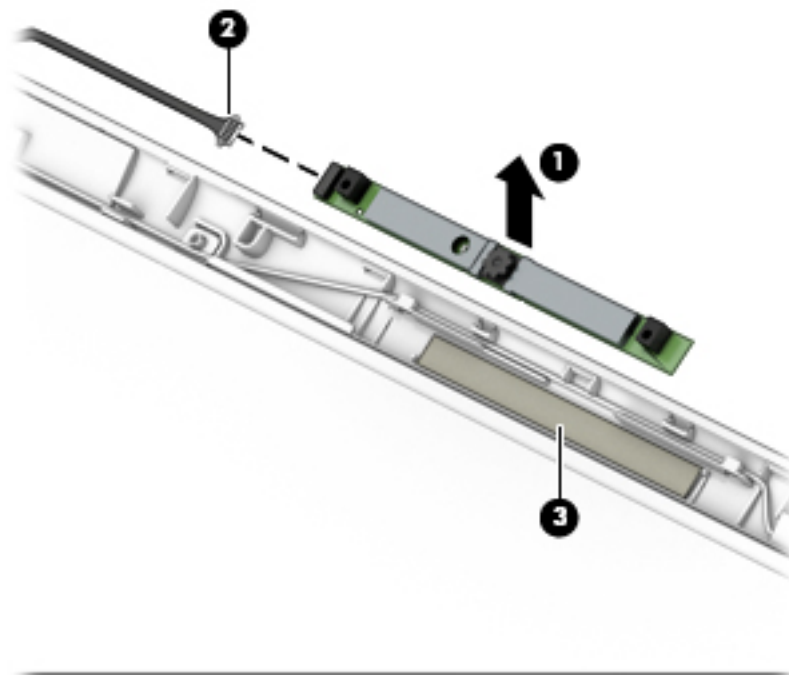

**3.** To remove the display panel:

- a. Remove the four Phillips PM2.0×3.0 screws **(1)** that secure the display panel to the top of the enclosure.
- b. Remove the two Phillips PM2.0×3.0 screws **(2)** that secure the display panel to the bottom of the enclosure.
- c. Lift the hinges up and move aside enough to be able to rotate the panel up and over **(3)**.

- d. Rotate the display panel onto the keyboard (4) to gain access to the display cable connection on the back of the panel.

 **NOTE:** The display will not be connected to the computer as shown in the following image.

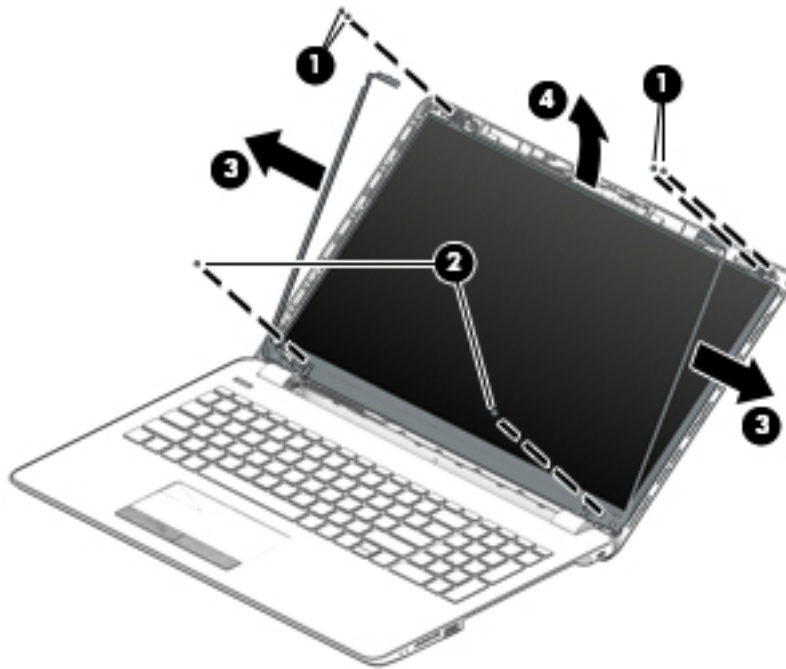

- e. On the back of the display panel, release the adhesive strip that secures the display panel cable to the display panel, and then disconnect the cable (1).
- f. Remove the display panel from the computer (2).

 **NOTE:** The display will not be connected to the computer as shown in the following image.

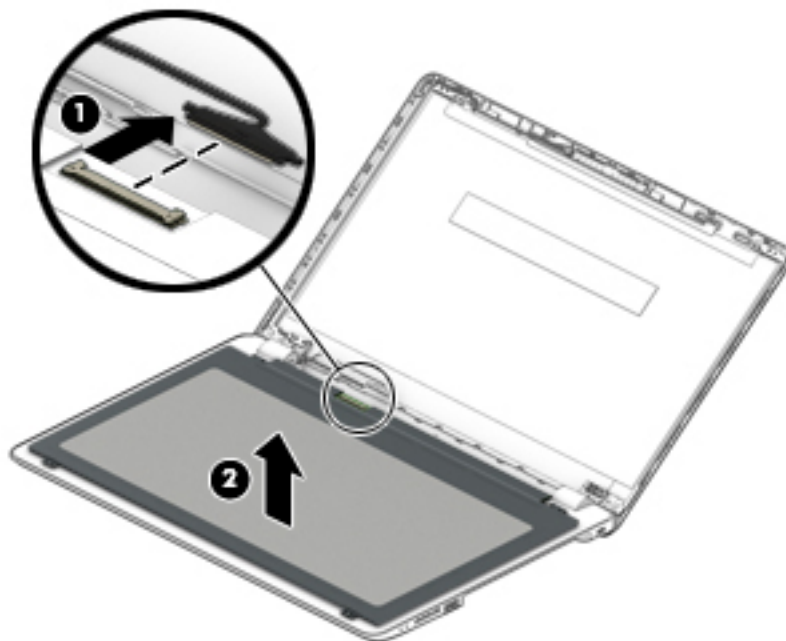

- 4. To remove the display hinges:

- a. Remove the Phillips PM2.0×3.0 screw **(1)** that secures each hinge cover to the display enclosure.
- b. Slide the left hinge cover toward the left and remove while threading the cable through the hinge cover **(2)**.
- c. Slide the right hinge cover toward the right to remove **(3)**.

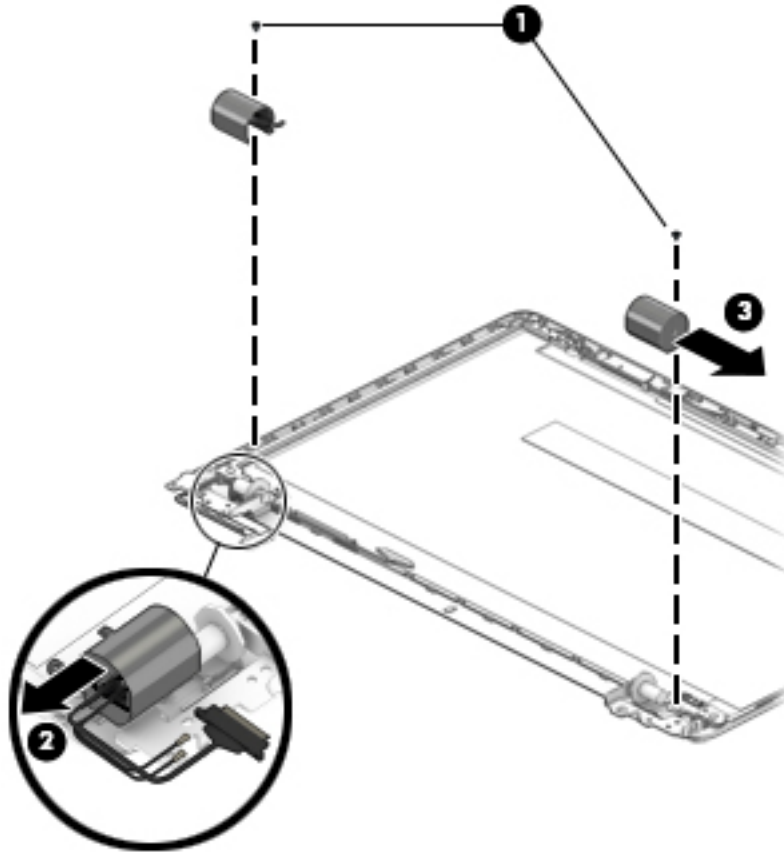

- d. Remove the two broadhead Phillips PM2.5×2.5 screws **(1)** and the broadhead PM2.5×3.0 screw **(2)** that secure each hinge to the bottom of the display enclosure.

- e. Remove the display hinges (3).

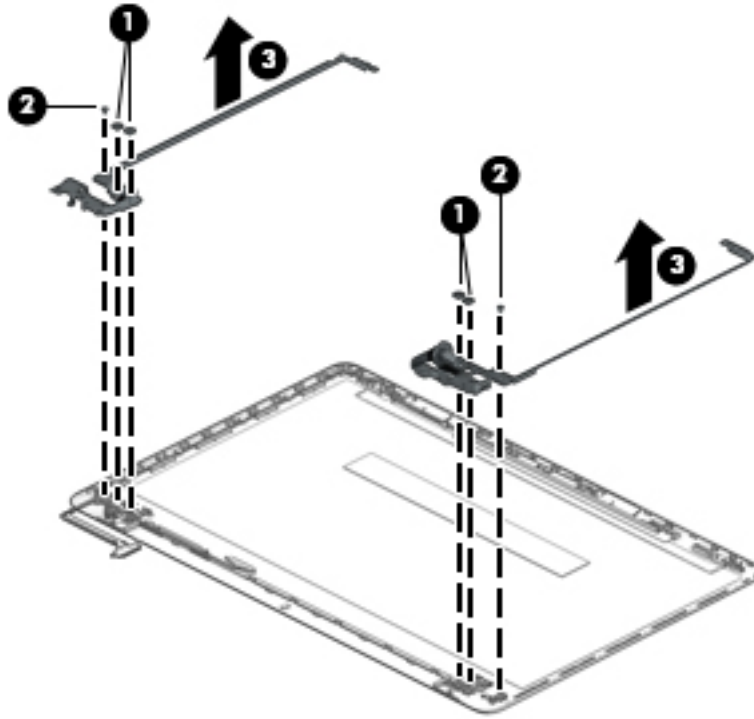



5. To remove the wireless antennas and cables, release the cables from the clips built into the side of the display enclosure (1), and then remove the antennas and cables (2).

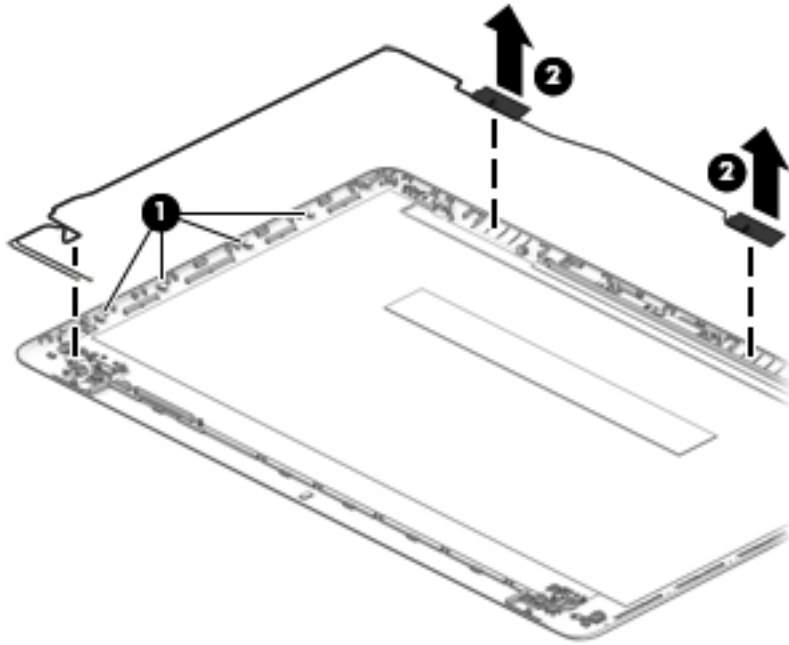

When installing the antennas, use the following image to determine correct installation locations at the top of the display enclosure.

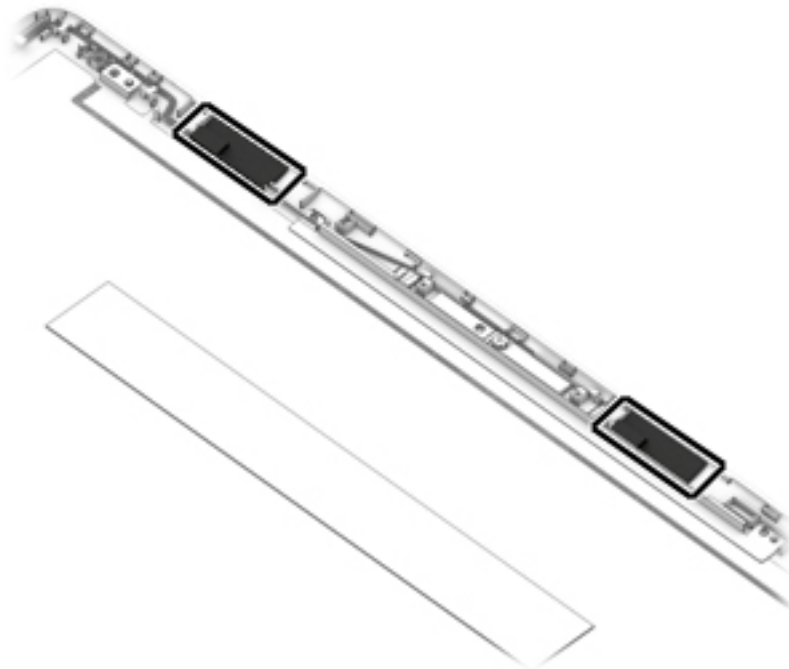

6. To remove the display/camera cable, remove the cable from the clips built into the side of the display enclosure (1), and then remove the cable from the display enclosure (2).

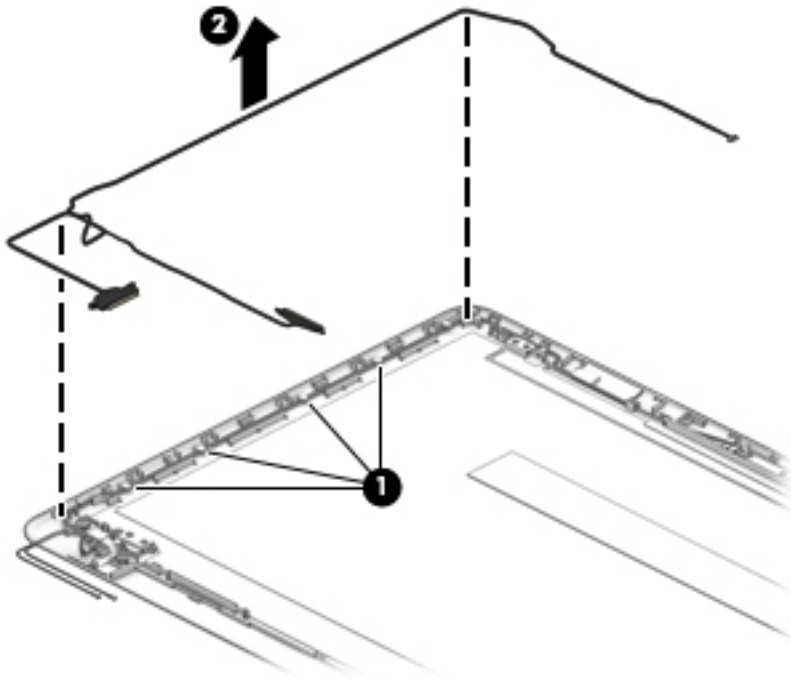

7. Use the following image to determine proper cable routing around the left hinge for the camera/display cable and the wireless antenna cables.

**(1):** Camera cable routing path

**(2):** Display/camera cable routing path

**(3):** Antenna cable routing path

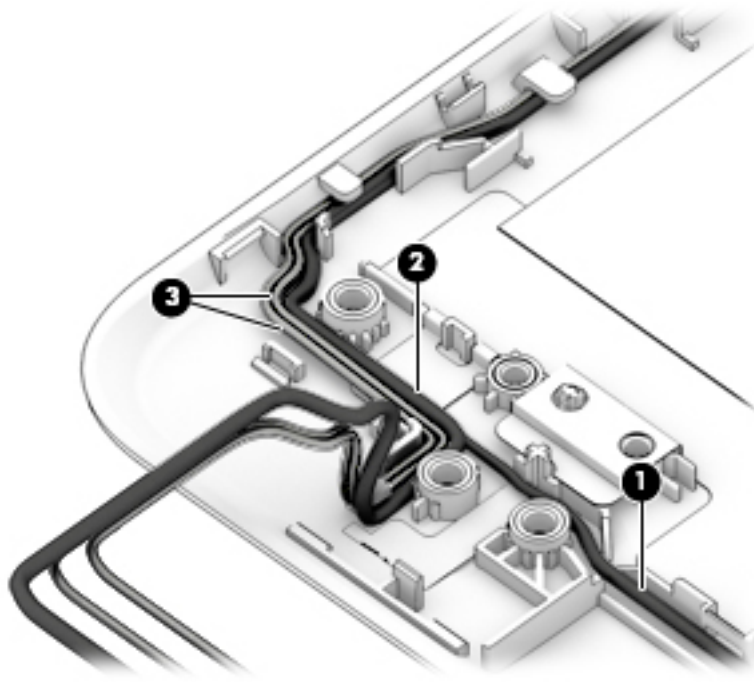

8. If replacing the display enclosure, be sure that the subcomponents (including the camera/microphone module, the antenna receivers, and all associated cables and hardware) are transferred to the new enclosure.

Reverse this procedure to reassemble and install the display assembly.

## Power connector cable

Description	Spare part number
Power connector cable	931613-001

Before removing the power connector cable, follow these steps:

1. Shut down the computer. If you are unsure whether the computer is off or in Hibernation, turn the computer on, and then shut it down through the operating system.
2. Disconnect all external devices connected to the computer.
3. Disconnect the power from the computer by first unplugging the power cord from the AC outlet and then unplugging the AC adapter from the computer.
4. Remove the battery (see [Battery on page 32](#)).
5. Remove the optical drive (see [Optical drive on page 33](#)), if installed.
6. Remove the bottom cover (see [Bottom cover on page 40](#)).
7. Remove the display (see [Display assembly on page 66](#)).

To remove the power connector cable:

1. Disconnect the power connector cable from the system board **(1)**.
2. Remove the cable from its routing path in the computer **(2)**.
3. Use a tool to pry the connector out of the computer **(3)**, and then remove the power connector cable **(4)**.

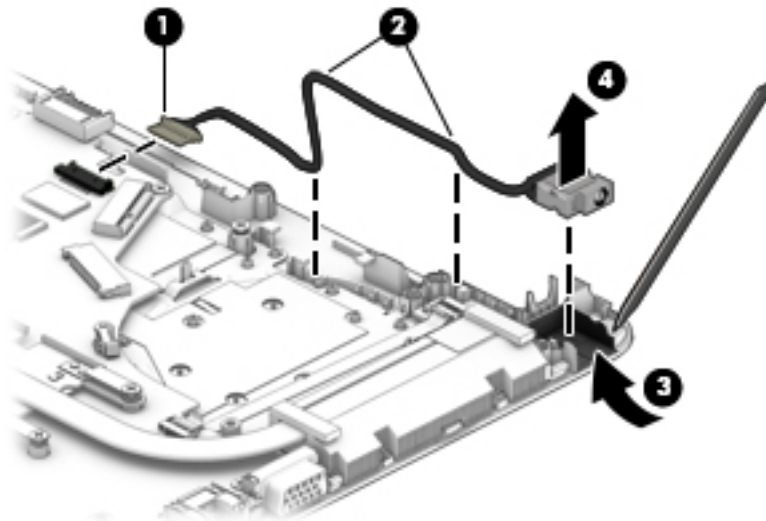

Reverse this procedure to install the power connector cable.

## Power button board

Description	Spare part number
Power button board	924994-001
Power button board cable	924933-001

Before removing the power button board, follow these steps:

1. Shut down the computer. If you are unsure whether the computer is off or in Hibernation, turn the computer on, and then shut it down through the operating system.
2. Disconnect all external devices connected to the computer.
3. Disconnect the power from the computer by first unplugging the power cord from the AC outlet and then unplugging the AC adapter from the computer.
4. Remove the battery (see [Battery on page 32](#)).
5. Remove the optical drive (see [Optical drive on page 33](#)), if installed.
6. Remove the bottom cover (see [Bottom cover on page 40](#)).
7. Remove the display (see [Display assembly on page 66](#)).

To remove the power button board:

1. Disconnect the cable from the power button board **(1)**.
2. Remove the Phillips PM2.0×2.0 screw **(2)** that secures the power button board to the computer.
3. Remove the power button board from the computer **(3)**.

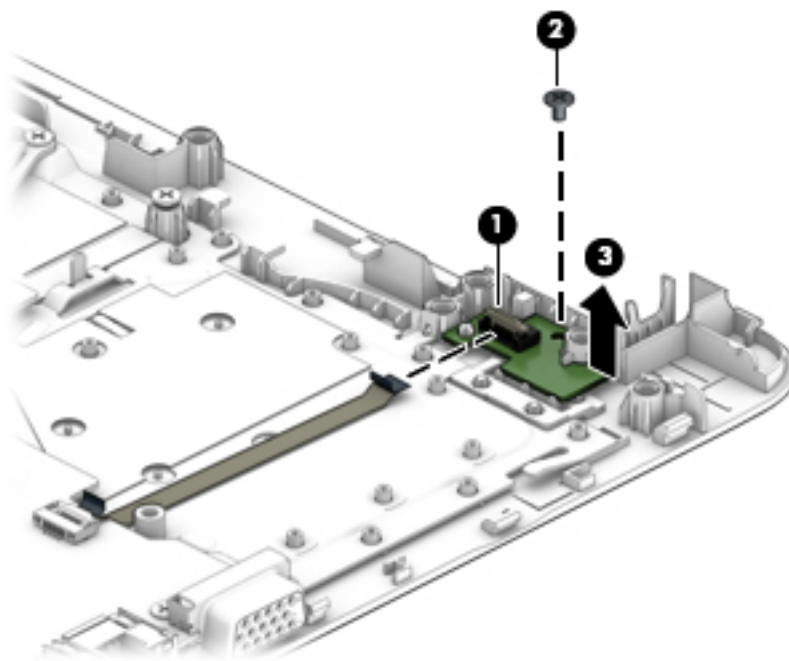

Reverse this procedure to install the power button board and cable.

## Cable locations

Description	Spare part number
TouchPad cable	924928-001
Hard drive cable	924927-001
USB board cable	924929-001
Optical drive connector board cable	924926-001
Power button board cable	924933-001

Use the following image to determine properly cable location and routing.

- (1) TouchPad cable
- (2) Hard drive cable
- (3) USB board cable
- (4) Optical drive connector board cable
- (5) Power button board cable

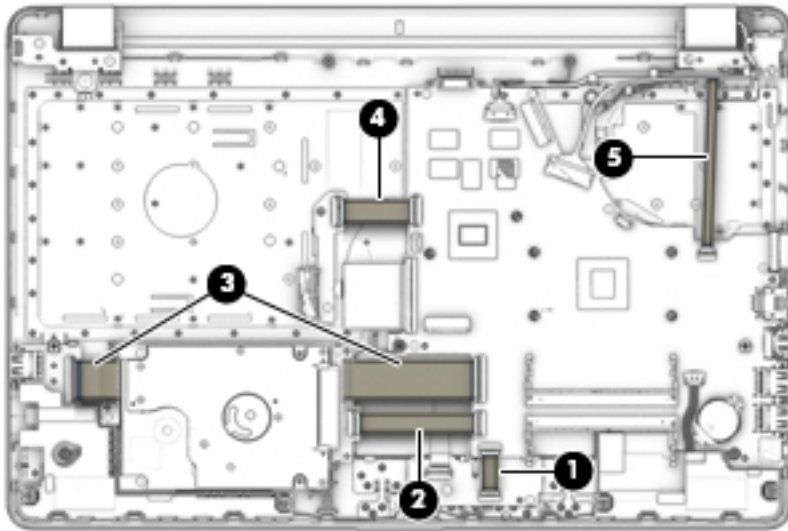

## Top cover/keyboard

The top cover/keyboard spare part remains after all other spare parts have been removed.

The top cover/keyboard spare part kit includes the keyboard, keyboard cable and the keyboard backlight cable (if equipped).

In this section, the first table provides the main spare part number for the keyboard. The second table provides the country codes.

 **NOTE:** All top cover/keyboard spare part kits include TouchPad.

Description	Spare part number
Asteroid silver models with no backlight	929904-xxx
Dark ash silver models with no backlight	929906-xxx

For use in country or region	Spare part number	For use in country or region	Spare part number	For use in country or region	Spare part number
Belgium	-A41	India	-002	Slovenia	-BA1
Bulgaria	-261	Italy	-061	South Korea	-AD1
Canada	-DB1	Latin America	-161	Spain	-071
Czech Republic and Slovakia	-FL1	Japan	-291	Switzerland	-BG1
Denmark, Finland, and Norway	-DH1	The Netherlands	-B31	Taiwan	-AB1
France	-051	Portugal	-131	Thailand	-281
Germany	-041	Romania	-271	Turkey	-141
Greece	-151	Russia	-251	United Kingdom	-031
Hungary	-211	Saudi Arabia	-171	United States	-001





---

# 7 Computer Setup (BIOS), TPM, and HP Sure Start

## Using Computer Setup

Computer Setup, or Basic Input/Output System (BIOS), controls communication between all the input and output devices on the system (such as disk drives, display, keyboard, mouse, and printer). Computer Setup includes settings for the types of devices installed, the startup sequence of the computer, and the amount of system and extended memory.



**NOTE:** Use extreme care when making changes in Computer Setup. Errors can prevent the computer from operating properly.

---

## Starting Computer Setup

- ▲ Turn on or restart the computer, and when the HP logo appears, press **f10** to enter Computer Setup.

## Using a USB keyboard or USB mouse to start Computer Setup (BIOS)

You can start Computer Setup by using a keyboard or mouse connected to a USB port, but you must first disable FastBoot.

1. Turn on or restart the computer, and when the HP logo appears, press **f9** to enter the Boot Device Options menu.
2. Clear the check box for **Fast Boot**.
3. To save your changes and exit, select the **Save** icon in the lower-right corner of the screen, and then follow the on-screen instructions.

– or –

Select **Main**, select **Save Changes and Exit**, and then press **enter**.

Your changes go into effect when the computer restarts.

## Navigating and selecting in Computer Setup

- To select a menu or a menu item, use the **tab** key and the keyboard arrow keys and then press **enter**, or use a pointing device to select the item.
- To scroll up and down, select the up arrow or the down arrow in the upper-right corner of the screen, or use the up arrow key or the down arrow key on the keyboard.
- To close open dialog boxes and return to the main Computer Setup screen, press **esc**, and then follow the on-screen instructions.

To exit Computer Setup menus, choose one of the following methods:

- To exit Computer Setup menus without saving your changes:  
Select the **Exit** icon in the lower-right corner of the screen, and then follow the on-screen instructions.  
– or –  
Select **Main**, select **Ignore Changes and Exit**, and then press **enter**.
- To save your changes and exit Computer Setup menus:  
Select the **Save** icon in the lower-right corner of the screen, and then follow the on-screen instructions.  
– or –  
Select **Main**, select **Save Changes and Exit**, and then press **enter**.

Your changes go into effect when the computer restarts.

## Restoring factory settings in Computer Setup

---

 **NOTE:** Restoring defaults will not change the hard drive mode.

---

To return all settings in Computer Setup to the values that were set at the factory, follow these steps:

1. Start Computer Setup. See [Starting Computer Setup on page 81](#).
2. Select **Main**, and then select **Apply Factory Defaults and Exit**.

---

 **NOTE:** On select products, the selections may display **Restore Defaults** instead of **Apply Factory Defaults and Exit**.

---

3. Follow the on-screen instructions.
4. To save your changes and exit, select the **Save** icon in the lower-right corner of the screen, and then follow the on-screen instructions.  
– or –  
Select **Main**, select **Save Changes and Exit**, and then press **enter**.

Your changes go into effect when the computer restarts.

---

 **NOTE:** Your password settings and security settings are not changed when you restore the factory settings.

---

## Updating the BIOS

Updated versions of the BIOS may be available on the HP website.

Most BIOS updates on the HP website are packaged in compressed files called *SoftPaqs*.

Some download packages contain a file named *Readme.txt*, which contains information regarding installing and troubleshooting the file.

## Determining the BIOS version

To decide whether you need to update Computer Setup (BIOS), first determine the BIOS version on your computer.

BIOS version information (also known as *ROM date* and *System BIOS*) can be accessed by pressing **fn+esc** (if you are already in Windows) or by using Computer Setup.

1. Start Computer Setup. See [Starting Computer Setup on page 81](#).
2. Select **Main**, and then select **System Information**.
3. To exit Computer Setup without saving your changes, select the **Exit** icon in the lower-right corner of the screen, and then follow the on-screen instructions.

– or –

Select **Main**, select **Ignore Changes and Exit**, and then press [enter](#).

To check for later BIOS versions, see [Downloading a BIOS update on page 83](#).

## Downloading a BIOS update

---

 **CAUTION:** To reduce the risk of damage to the computer or an unsuccessful installation, download and install a BIOS update only when the computer is connected to reliable external power using the AC adapter. Do not download or install a BIOS update while the computer is running on battery power, docked in an optional docking device, or connected to an optional power source. During the download and installation, follow these instructions:

Do not disconnect power on the computer by unplugging the power cord from the AC outlet.

Do not shut down the computer or initiate Sleep.

Do not insert, remove, connect, or disconnect any device, cable, or cord.

---

1. Type `support` in the taskbar search box, and then select the HP Support Assistant app.  
– or –  
Select the question mark icon in the taskbar.
2. Select **Updates**, and then select **Check for updates and messages**.
3. Follow the on-screen instructions.
4. At the download area, follow these steps:
  - a. Identify the most recent BIOS update and compare it to the BIOS version currently installed on your computer. Make a note of the date, name, or other identifier. You may need this information to locate the update later, after it has been downloaded to your hard drive.
  - b. Follow the on-screen instructions to download your selection to the hard drive.  
  
Make a note of the path to the location on your hard drive where the BIOS update is downloaded. You will need to access this path when you are ready to install the update.

---

 **NOTE:** If you connect your computer to a network, consult the network administrator before installing any software updates, especially system BIOS updates.

---

BIOS installation procedures vary. Follow any instructions that are displayed on the screen after the download is complete. If no instructions are displayed, follow these steps:

1. Type `file` in the taskbar search box, and then select **File Explorer**.
2. Select your hard drive designation. The hard drive designation is typically Local Disk (C:).
3. Using the hard drive path you recorded earlier, open the folder that contains the update.
4. Double-click the file that has an `.exe` extension (for example, `filename.exe`).  
  
The BIOS installation begins.
5. Complete the installation by following the on-screen instructions.



---

**NOTE:** After a message on the screen reports a successful installation, you can delete the downloaded file from your hard drive.

---

## Changing the boot order using the f9 prompt

To dynamically choose a boot device for the current startup sequence, follow these steps:

1. Access the Boot Device Options menu:
  - Turn on or restart the computer, and when the HP logo appears, press **f9** to enter the Boot Device Options menu.
2. Select a boot device, press **enter**, and then follow the on-screen instructions.

## TPM BIOS settings (select products only)



---

**IMPORTANT:** Before enabling Trusted Platform Module (TPM) functionality on this system, you must ensure that your intended use of TPM complies with relevant local laws, regulations and policies, and approvals or licenses must be obtained if applicable. For any compliance issues arising from your operation/usage of TPM which violates the above mentioned requirement, you shall bear all the liabilities wholly and solely. HP will not be responsible for any related liabilities.

---

TPM provides additional security for your computer. You can modify the TPM settings in Computer Setup (BIOS).



---

**NOTE:** If you change the TPM setting to Hidden, TPM is not visible in the operating system.

---

To access TPM settings in Computer Setup:

1. Start Computer Setup. See [Starting Computer Setup on page 81](#).
2. Select **Security**, select **TPM Embedded Security**, and then follow the on-screen instructions.

## Using HP Sure Start (select products only)

Select computer models are configured with HP Sure Start, a technology that monitors the computer's BIOS for attacks or corruption. If the BIOS becomes corrupted or is attacked, HP Sure Start automatically restores the BIOS to its previously safe state, without user intervention.

HP Sure Start is configured and already enabled so that most users can use the HP Sure Start default configuration. The default configuration can be customized by advanced users.

To access the latest documentation on HP Sure Start, go to <http://www.hp.com/support>. Select **Find your product**, and then follow the on-screen instructions.

# 8 Backing up, restoring, and recovering

This chapter provides information about the following processes. The information in the chapter is standard procedure for most products.

- Creating recovery media and backups
- Restoring and recovering your system

For additional information, refer to the HP Support Assistant app.

▲ Type `support` in the taskbar search box, and then select the **HP Support Assistant** app.

– or –

Select the question mark icon in the taskbar.

 **IMPORTANT:** If you will be performing recovery procedures on a tablet, the tablet battery must be at least 70% charged before you start the recovery process.

**IMPORTANT:** For a tablet with a detachable keyboard, connect the tablet to the keyboard base before beginning any recovery process.

## Creating recovery media and backups

The following methods of creating recovery media and backups are available on select products only. Choose the available method according to your computer model.

- Use HP Recovery Manager to create HP Recovery media after you successfully set up the computer. This step creates a backup of the HP Recovery partition on the computer. The backup can be used to reinstall the original operating system in cases where the hard drive is corrupted or has been replaced. For information on creating recovery media, see [Creating HP Recovery media \(select products only\) on page 85](#). For information on the recovery options that are available using the recovery media, see [Using Windows tools on page 86](#).
- Use Windows tools to create system restore points and create backups of personal information.

For more information, see [Recovering using HP Recovery Manager on page 87](#).

 **NOTE:** If storage is 32 GB or less, Microsoft System Restore is disabled by default.

## Creating HP Recovery media (select products only)

If possible, check for the presence of the Recovery partition and the Windows partition. From the **Start** menu, select **File Explorer**, and then select **This PC**.

- If your computer does not list the Windows partition and the Recovery partition, you can obtain recovery media for your system from support. See the *Worldwide Telephone Numbers* booklet included with the computer. You can also find contact information on the HP website. Go to <http://www.hp.com/support>, select your country or region, and follow the on-screen instructions.

You can use Windows tools to create system restore points and create backups of personal information, see [Using Windows tools on page 86](#).

- If your computer does list the Recovery partition and the Windows partition, you can use HP Recovery Manager to create recovery media after you successfully set up the computer. HP Recovery media can be used to perform system recovery if the hard drive becomes corrupted. System recovery reinstalls the original operating system and software programs that were installed at the factory and then configures the settings for the programs. HP Recovery media can also be used to customize the system or restore the factory image if you replace the hard drive.
  - Only one set of recovery media can be created. Handle these recovery tools carefully, and keep them in a safe place.
  - HP Recovery Manager examines the computer and determines the required storage capacity for the media that will be required.
  - To create recovery discs, your computer must have an optical drive with DVD writer capability, and you must use only high-quality blank DVD-R, DVD+R, DVD-R DL, or DVD+R DL discs. Do not use rewritable discs such as CD±RW, DVD±RW, double-layer DVD±RW, or BD-RE (rewritable Blu-ray) discs; they are not compatible with HP Recovery Manager software. Or, instead, you can use a high-quality blank USB flash drive.
  - If your computer does not include an integrated optical drive with DVD writer capability, but you would like to create DVD recovery media, you can use an external optical drive (purchased separately) to create recovery discs. If you use an external optical drive, it must be connected directly to a USB port on the computer; the drive cannot be connected to a USB port on an external device, such as a USB hub. If you cannot create DVD media yourself, you can obtain recovery discs for your computer from HP. See the *Worldwide Telephone Numbers* booklet included with the computer. You can also find contact information on the HP website. Go to <http://www.hp.com/support>, select your country or region, and follow the on-screen instructions.
  - Be sure that the computer is connected to AC power before you begin creating the recovery media.
  - The creation process can take an hour or more. Do not interrupt the creation process.
  - If necessary, you can exit the program before you have finished creating all of the recovery DVDs. HP Recovery Manager will finish burning the current DVD. The next time you start HP Recovery Manager, you will be prompted to continue.

To create HP Recovery media:



---

**IMPORTANT:** For a tablet with a detachable keyboard, connect the tablet to the keyboard base before beginning these steps.

---

1. Type `recovery` in the taskbar search box, and then select **HP Recovery Manager**.
2. Select **Create recovery media**, and then follow the on-screen instructions.

If you ever need to recover the system, see [Recovering using HP Recovery Manager on page 87](#).

## Using Windows tools

You can create recovery media, system restore points, and backups of personal information using Windows tools.



---

**NOTE:** If storage is 32 GB or less, Microsoft System Restore is disabled by default.

---

For more information and steps, see the Get started app.

- ▲ Select the **Start** button, and then select the **Get started** app.

# Restore and recovery

There are several options for recovering your system. Choose the method that best matches your situation and level of expertise:

 **IMPORTANT:** Not all methods are available on all products.

- Windows offers several options for restoring from backup, refreshing the computer, and resetting the computer to its original state. For more information see the Get started app.
  - ▲ Select the **Start** button, and then select the **Get started** app.
- If you need to correct a problem with a preinstalled application or driver, use the Reinstall drivers and/or applications option (select products only) of HP Recovery Manager to reinstall the individual application or driver.
  - ▲ Type `recovery` in the taskbar search box, select **HP Recovery Manager**, select **Reinstall drivers and/or applications**, and then follow the on-screen instructions.
- If you want to recover the Windows partition to original factory content, you can choose the System Recovery option from the HP Recovery partition (select products only) or use the HP Recovery media. For more information, see [Recovering using HP Recovery Manager on page 87](#). If you have not already created recovery media, see [Creating HP Recovery media \(select products only\) on page 85](#).
- On select products, if you want to recover the computer's original factory partition and content, or if you have replaced the hard drive, you can use the Factory Reset option of HP Recovery media. For more information, see [Recovering using HP Recovery Manager on page 87](#).
- On select products, if you want to remove the Recovery partition to reclaim hard drive space, HP Recovery Manager offers the Remove Recovery Partition option.

For more information, see [Removing the HP Recovery partition \(select products only\) on page 90](#).

## Recovering using HP Recovery Manager

HP Recovery Manager software allows you to recover the computer to its original factory state by using the HP Recovery media that you either created or that you obtained from HP, or by using the HP Recovery partition (select products only). If you have not already created recovery media, see [Creating HP Recovery media \(select products only\) on page 85](#).

### What you need to know before you get started

- HP Recovery Manager recovers only software that was installed at the factory. For software not provided with this computer, you must either download the software from the manufacturer's website or reinstall the software from the media provided by the manufacturer.

 **IMPORTANT:** Recovery through HP Recovery Manager should be used as a final attempt to correct computer issues.

- HP Recovery media must be used if the computer hard drive fails. If you have not already created recovery media, see [Creating HP Recovery media \(select products only\) on page 85](#).
- To use the Factory Reset option (select products only), you must use HP Recovery media. If you have not already created recovery media, see [Creating HP Recovery media \(select products only\) on page 85](#).
- If your computer does not allow the creation of HP Recovery media or if the HP Recovery media does not work, you can obtain recovery media for your system from support. See the *Worldwide Telephone Numbers* booklet included with the computer. You can also find contact information from the HP

website. Go to <http://www.hp.com/support>, select your country or region, and follow the on-screen instructions.

---

 **IMPORTANT:** HP Recovery Manager does not automatically provide backups of your personal data. Before beginning recovery, back up any personal data you want to retain.

---

Using HP Recovery media, you can choose from one of the following recovery options:

---

 **NOTE:** Only the options available for your computer display when you start the recovery process.

---

- System Recovery—Reinstalls the original operating system, and then configures the settings for the programs that were installed at the factory.
- Factory Reset—Restores the computer to its original factory state by deleting all information from the hard drive and re-creating the partitions. Then it reinstalls the operating system and the software that was installed at the factory.

The HP Recovery partition (select products only) allows System Recovery only.

## Using the HP Recovery partition (select products only)

The HP Recovery partition allows you to perform a system recovery without the need for recovery discs or a recovery USB flash drive. This type of recovery can be used only if the hard drive is still working.

To start HP Recovery Manager from the HP Recovery partition:

---

 **IMPORTANT:** For a tablet with a detachable keyboard, connect the tablet to the keyboard base before beginning these steps (select products only).

---

1. Type `recovery` in the taskbar search box, select **Recovery Manager**, and then select **HP Recovery Environment**.

– or –

For computers or tablets with keyboards attached, press **f11** while the computer boots, or press and hold **f11** as you press the power button.

For tablets without keyboards:

- Turn on or restart the tablet, and then quickly hold down the volume up button; then select **f11**.

– or –

- Turn on or restart the tablet, and then quickly hold down the volume down button; then select **f11**.

2. Select **Troubleshoot** from the boot options menu.
3. Select **Recovery Manager**, and then follow the on-screen instructions.

## Using HP Recovery media to recover

You can use HP Recovery media to recover the original system. This method can be used if your system does not have an HP Recovery partition or if the hard drive is not working properly.

1. If possible, back up all personal files.
2. Insert the HP Recovery media, and then restart the computer.

---

 **NOTE:** If the computer does not automatically restart in HP Recovery Manager, change the computer boot order. See [Changing the computer boot order on page 89](#).

---

3. Follow the on-screen instructions.



## Changing the computer boot order

If your computer does not restart in HP Recovery Manager, you can change the computer boot order, which is the order of devices listed in BIOS where the computer looks for startup information. You can change the selection to an optical drive or a USB flash drive.

To change the boot order:



---

**IMPORTANT:** For a tablet with a detachable keyboard, connect the tablet to the keyboard base before beginning these steps.

---

1. Insert the HP Recovery media.
2. Access the system **Startup** menu.

For computers or tablets with keyboards attached:

- ▲ Turn on or restart the computer or tablet, quickly press **esc**, and then press **f9** for boot options.

For tablets without keyboards:

- ▲ Turn on or restart the tablet, and then quickly hold down the volume up button; then select **f9**.

– or –

Turn on or restart the tablet, and then quickly hold down the volume down button; then select **f9**.

3. Select the optical drive or USB flash drive from which you want to boot.
4. Follow the on-screen instructions.

## Removing the HP Recovery partition (select products only)

HP Recovery Manager software allows you to remove the HP Recovery partition to free up hard drive space.



**IMPORTANT:** After you remove the HP Recovery partition, you will not be able to perform System Recovery or create HP Recovery media from the HP Recovery partition. So before you remove the Recovery partition, create HP Recovery media; see [Creating HP Recovery media \(select products only\) on page 85](#).



**NOTE:** The Remove Recovery Partition option is only available on products that support this function.

Follow these steps to remove the HP Recovery partition:

1. Type `recovery` in the taskbar search box, and then select **HP Recovery Manager**.
2. Select **Remove Recovery Partition**, and then follow the on-screen instructions.

# 9 Using HP PC Hardware Diagnostics (UEFI)

HP PC Hardware Diagnostics is a Unified Extensible Firmware Interface (UEFI) that allows you to run diagnostic tests to determine whether the computer hardware is functioning properly. The tool runs outside the operating system so that it can isolate hardware failures from issues that are caused by the operating system or other software components.

When HP PC Hardware Diagnostics (UEFI) detects a failure that requires hardware replacement, a 24-digit Failure ID code is generated. This ID code can then be provided to support to help determine how to correct the problem.

---

 **NOTE:** To start diagnostics on a convertible computer, your computer must be in notebook mode and you must use the keyboard attached.

---

To start HP PC Hardware Diagnostics (UEFI), follow these steps:

1. Turn on or restart the computer, and quickly press **esc**.
2. Press **f2**.

The BIOS searches three places for the diagnostic tools, in the following order:

- a. Connected USB drive

---

 **NOTE:** To download the HP PC Hardware Diagnostics (UEFI) tool to a USB drive, see [Downloading HP PC Hardware Diagnostics \(UEFI\) to a USB device on page 91](#).

---

- b. Hard drive
  - c. BIOS
3. When the diagnostic tool opens, select the type of diagnostic test you want to run, and then follow the on-screen instructions.

---

 **NOTE:** If you need to stop a diagnostic test, press **esc**.

---

## Downloading HP PC Hardware Diagnostics (UEFI) to a USB device

---

 **NOTE:** The HP PC Hardware Diagnostics (UEFI) download instructions are provided in English only, and you must use a Windows computer to download and create the HP UEFI support environment because only .exe files are offered.

---

There are two options to download HP PC Hardware Diagnostics to a USB device.

### Download the latest UEFI version

1. Go to <http://www.hp.com/go/techcenter/pcdiags>. The HP PC Diagnostics home page is displayed.
2. In the HP PC Hardware Diagnostics section, select the **Download** link, and then select **Run**.

### Download any version of UEFI for a specific product

1. Go to <http://www.hp.com/support>.
2. Select **Get software and drivers**.

3. Enter the product name or number.

– or –

Select **Identify now** to let HP automatically detect your product.

4. Select your computer, and then select your operating system.
5. In the **Diagnostic** section, follow the on-screen instructions to select and download the UEFI version you want.

#### **Additional BIOS crisis recovery tool**

HP provides a BIOS crisis recovery tool through the HP PC Hardware Diagnostics 3-in-1 USB key. This tool can be used by HP authorized service providers to recover systems that have failed due to a corrupted BIOS. For more information about using the 3-in-1 USB key for BIOS crisis recovery, go to <http://www.hp.com/go/techcenter/pcdiags>. Additional information is included in the web-based training offered by HP University. See the modules that cover HP PC Hardware Diagnostics (UEFI).

# 10 Specifications

## Computer specifications

	Metric	U.S.
<b>Dimensions</b>		
Depth	<b>253.8 mm</b>	9.99 in
Width	<b>380.0 mm</b>	14.9 in
Height	<b>23.8 mm</b>	0.94 in
<b>Weight (SSD configuration)</b>		
3 cell battery	<b>1.86 kg</b>	4.1 lb
4 cell battery	<b>1.91 kg</b>	4.21 lb
<b>Weight (SSD+HDD configuration)</b>		
3 cell battery	<b>2.05 kg</b>	4.52 lb
4 cell battery	<b>2.1 kg</b>	4.63 lb
<b>Input power</b>		
Operating voltage and current	19.5 V dc @ 3.33 A – 65 W	
	19.5 V dc @ 2.31 A – 45 W	
<b>Temperature</b>		
Operating	<b>5°C to 35°C</b>	41°F to 95°F
Nonoperating	<b>-20°C to 60°C</b>	-4°F to 140°F
<b>Relative humidity (noncondensing)</b>		
Operating	10% to 90%	
Nonoperating	5% to 95%	
<b>Maximum altitude (unpressurized)</b>		
Operating	<b>-15 m to 3,048 m</b>	-50 ft to 10,000 ft
Nonoperating	<b>-15 m to 12,192 m</b>	-50 ft to 40,000 ft

**NOTE:** Applicable product safety standards specify thermal limits for plastic surfaces. The device operates well within this range of temperatures.

## 39.6-cm (15.6-in) display specifications

	<b>Metric</b>	<b>U.S.</b>
Active diagonal size	39.6-cm	15.6-in
Resolution	1366x768 (HD) 1920x1080 (FHD)	
Surface treatment	Anti glare	
Brightness	220 nits	
Viewing angle	SVA	
Backlight	WLED	
Graphics adapter	eDP	
Thickness	3.2 mm	

## Hard drive specifications

	1-TB*	500-GB*
<b>Dimensions</b>		
Height	9.5 mm or 7.2 mm	7.0 mm
Length	100.4 mm	100.6 mm
Width	69.9 mm	70.1 mm
Weight	107.0 g	92.0 g
<b>Interface type</b>	SATA	SATA
<b>Transfer rate</b>		
Synchronous (maximum)	300 MB/sec	300 MB/sec
Security	ATA security	ATA security
<b>Seek times</b> (typical read, including setting)		
Single track	2.0 ms	3 ms
Average (read/write)	12 ms	13 ms
Maximum	22 ms	24 ms
<b>Logical blocks</b>	1,953,525,168	1,048,576,000
<b>Disk rotational speed</b>	5400 rpm	5400 rpm or 7200 rpm
<b>Operating temperature</b>		
*1 GB = 1 billion bytes when referring to hard drive storage capacity. Actual accessible capacity is less.		
<b>NOTE:</b> Certain restrictions and exclusions apply. Contact technical support for details.		

## M.2 solid-state drive specifications

	128-GB*	256-GB*	512-GB*
<b>Dimensions</b>			
Width	1 mm	1 mm	1.5 mm
Length	50.8 mm	50.8 mm	80.0 mm
Width	28.9 mm	28.9 mm	22.0 mm
Weight	< 10 g	< 10 g	< 9 g
<b>Interface type</b>	ATA-7	ATA-7	ATA-7
<b>Transfer rate</b>			
Sequential Read	Up to 520 MB/s	Up to 535 MB/s	Up to 530 MB/s
Random Read	Up to 60K IOPs	Up to 97K IOPs	Up to 97K IOPs
Sequential Write	Up to 160 MB/s	Up to 515 MB/s	Up to 515 MB/s
Random Write	Up to 34K IOPs	Up to 59K IOPs	Up to 88K IOPs
<b>Ready time, Maximum (to not busy)</b>	1.0 s	1.0 s	1.0 s
<b>Access times</b>			
Logical	0.1 ms	0.1 ms	0.1 ms
<b>Total logical sectors</b>	250,069,680	500,118,192	1,000,215,216
<b>Operating temperature</b>			
Operating	0° to 70°C (32°F to 158°F)	0° to 70°C (32°F to 158°F)	0° to 70°C (32°F to 158°F)
Non-operating	-40° to 85°C (-40°F to 185°F)	-40° to 85°C (-40°F to 185°F)	-40° to 85°C (-40°F to 185°F)
*1 GB = 1 billion bytes when referring to hard drive storage capacity. Actual accessible capacity is less.			
<b>NOTE:</b> Certain restrictions and exclusions apply. Contact technical support for details.			



## DVD±RW SuperMulti DL Drive specifications

Component	Value	
<b>Applicable disc</b>	<b>Read:</b> CD-DA, CD+(E)G, CD-MIDI, CD-TEXT, CD-ROM, CD-ROM XA, MIXED MODE CD, CD-I, CD-I Bridge (Photo-CD, Video CD), Multisession CD (Photo-CD, CD-EXTRA, Portfolio, CD-R, CD-RW), CD-R, CD-RW, DVD-ROM (DVD-5, DVD-9, DVD-10, DVD-18), DVD-R, DVD-RW, DVD+R, DVD+RW, DVD-RAM	<b>Write:</b> CD-R and CD-RW DVD+R, DVD+RW, DVD-R, DVD-RW, DVD-RAM
<b>Center hole diameter</b>	1.5 cm (0.59 in)	
<b>Disc diameter</b>		
Standard disc	12 cm (4.72 in)	
Mini disc	8 cm (3.15 in)	
<b>Disc thickness</b>	1.2 mm (0.047 in)	
<b>Track pitch</b>	0.74 μm	
<b>Access time</b>	<b>CD</b>	<b>DVD</b>
Random	< 175 ms	< 230 ms
Full stroke	< 285 ms	< 335 ms
<b>Audio output level</b>	Line-out, 0.7 Vrms	
<b>Cache buffer</b>	2 MB	
<b>Data transfer rate</b>		
24X CD-ROM	3,600 KB/sec	
8X DVD-ROM	10,800 KB/sec	
24X CD-R	3,600 KB/sec	
16X CD-RW	2,400 KB/sec	
8X DVD+R	10,800 KB/sec	
4X DVD+RW	5,400 KB/sec	
8X DVD-R	10,800 KB/sec	
4X DVD-RW	5,400 KB/sec	
2.4X DVD+R(9)	2,700 KB/sec	
5X DVD-RAM	6,750 KB/sec	
<b>Transfer mode</b>	Multiword DMA Mode	
<b>Startup time</b>	< 15 seconds	
<b>Stop time</b>	< 6 seconds	



# 11 Statement of memory volatility

The purpose of this chapter is to provide general information regarding nonvolatile memory in HP Business computers. This chapter also provides general instructions for restoring nonvolatile memory that can contain personal data after the system has been powered off and the hard drive has been removed.

HP Business computer products that use Intel®-based or AMD®-based system boards contain volatile DDR memory. The amount of nonvolatile memory present in the system depends upon the system configuration. Intel-based and AMD-based system boards contain nonvolatile memory subcomponents as originally shipped from HP, assuming that no subsequent modifications have been made to the system and assuming that no applications, features, or functionality have been added to or installed on the system.

Following system shutdown and removal of all power sources from an HP Business computer system, personal data can remain on volatile system memory (DIMMs) for a finite period of time and will also remain in nonvolatile memory. Use the steps below to remove personal data from the computer, including the nonvolatile memory found in Intel-based and AMD-based system boards.

---

 **NOTE:** If your tablet has a keyboard base, connect to the keyboard base before beginning steps in this chapter.

---

## Current BIOS steps

1. Follow steps (a) through (l) below to restore the nonvolatile memory that can contain personal data. Restoring or reprogramming nonvolatile memory that does not store personal data is neither necessary nor recommended.
  - a. Turn on or restart the computer, and then press **esc** while the "Press the ESC key for Startup Menu" message is displayed at the bottom of the screen.

---

 **NOTE:** If the system has a BIOS administrator password, enter the password at the prompt.
  - b. Select **Main**, select **Apply Factory Defaults and Exit**, and then select **Yes** to load defaults.  
The computer will reboot.
  - c. During the reboot, press **esc** while the "Press the ESC key for Startup Menu" message is displayed at the bottom of the screen.

---

 **NOTE:** If the system has a BIOS administrator password, enter the password at the prompt.
  - d. Select the **Security** menu, select **Restore Security Settings to Factory Defaults**, and then select **Yes** to restore security level defaults.  
The computer will reboot.
  - e. During the reboot, press **esc** while the "Press the ESC key for Startup Menu" message is displayed at the bottom of the screen.

---

 **NOTE:** If the system has a BIOS administrator password, enter the password at the prompt.
  - f. If an asset or ownership tag is set, select the **Security** menu and scroll down to the **Utilities** menu. Select **System IDs**, and then select **Asset Tracking Number**. Clear the tag, and then make the selection to return to the prior menu.

- g. If a DriveLock password is set, select the **Security** menu, and scroll down to **Hard Drive Utilities** under the **Utilities** menu. Select **Hard Drive Utilities**, select **DriveLock**, then uncheck the checkbox for **DriveLock password on restart**. Select **OK** to proceed.
- h. Select the **Main** menu, and then select **Reset BIOS Security to factory default**. Click **Yes** at the warning message.  
The computer will reboot.
- i. During the reboot, press **esc** while the “Press the ESC key for Startup Menu” message is displayed at the bottom of the screen.



---

**NOTE:** If the system has a BIOS administrator password, enter the password at the prompt.

---

- j. Select the **Main** menu, select **Apply Factory Defaults and Exit**, select **Yes** to save changes and exit, and then select **Shutdown**.
  - k. Reboot the system. If the system has a Trusted Platform Module (TPM) and/or fingerprint reader, one or two prompts will appear—one to clear the TPM and the other to Reset Fingerprint Sensor; press or tap **F1** to accept or **F2** to reject.
  - l. Remove all power and system batteries for at least 24 hours.
2. Complete one of the following:
- Remove and retain the storage drive.
  - or –
  - Clear the drive contents by using a third party utility designed to erase data from an SSD.
  - or –
  - Clear the contents of the drive by using the following BIOS Setup Secure Erase command option steps:



---

**IMPORTANT:** If you clear data using Secure Erase, it cannot be recovered.

---

- a. Turn on or restart the computer, and then press **esc** while the “Press the ESC key for Startup Menu” message is displayed at the bottom of the screen.
- b. Select the **Security** menu and scroll down to the **Utilities** menu.
- c. Select **Hard Drive Utilities**.
- d. Under **Utilities**, select **Secure Erase**, select the hard drive storing the data you want to clear, and then follow the on-screen instructions to continue.

# Nonvolatile memory usage

Nonvolatile Memory Type	Amount (Size)	Does this memory store customer data?	Does this memory retain data when power is removed?	What is the purpose of this memory?	How is data input into this memory?	How is this memory write-protected?
HP Sure Start flash (select models only)	8 MBytes	No	Yes	Provides protected backup of critical System BIOS code, EC firmware, and critical computer configuration data for select platforms that support HP Sure Start.  For more information, see <a href="#">Using HP Sure Start (select models only) on page 104</a> .	Data cannot be written to this device via the host processor. The content is managed solely by the HP Sure Start Embedded Controller.	This memory is protected by the HP Sure Start Embedded Controller.
Real Time Clock (RTC) battery backed-up CMOS configuration memory	256 Bytes	No	Yes	Stores system date and time and noncritical data.	RTC battery backed-up CMOS is programmed using the Computer Setup (BIOS), or changing the Microsoft Windows date & time.	This memory is not write-protected.
Controller (NIC) EEPROM	64 KBytes (not customer accessible)	No	Yes	Stores NIC configuration and NIC firmware.	NIC EEPROM is programmed using a utility from the NIC vendor that can be run from DOS.	A utility is required to write data to this memory and is available from the NIC vendor. Writing data to this ROM in an inappropriate manner will render the NIC non-functional.
DIMM Serial Presence Detect (SPD) configuration data	256 Bytes per memory module, 128 Bytes programmable (not customer accessible)	No	Yes	Stores memory module information.	DIMM SPD is programmed by the memory vendor.	Data cannot be written to this memory when the module is installed in a computer. The specific write-protection method varies by memory vendor.
System BIOS	9 MBytes	Yes	Yes	Stores system BIOS code and computer configuration data.	System BIOS code is programmed at the factory. Code is updated when the system BIOS is updated. Configuration data and settings are input using the Computer Setup (BIOS) or a custom utility.	<b>NOTE:</b> Writing data to this ROM in an inappropriate manner can render the computer non-functional.  A utility is required for writing data to this memory and is available on the HP website; go to <a href="http://www.hp.com/support">http://www.hp.com/support</a> . Select <b>Find your</b>

Nonvolatile Memory Type	Amount (Size)	Does this memory store customer data?	Does this memory retain data when power is removed?	What is the purpose of this memory?	How is data input into this memory?	How is this memory write-protected?
Intel Management Engine Firmware (present only in select Elite or Z models. For more information, go to <a href="http://www.hp.com/support">http://www.hp.com/support</a> . Select <b>Find your product</b> , and then follow the on-screen instructions.)	1.5 MBytes or 7 MBytes	Yes	Yes	Stores Management Engine Code, Settings, Provisioning Data and iAMT third-party data store.	Management Engine Code is programmed at the factory. Code is updated via Intel secure firmware update utility. Unique Provisioning Data can be entered at the factory or by an administrator using the Management Engine (MEBx) setup utility. The third party data store contents can be populated by a remote management console or local applications that have been registered by an administrator to have access to the space.	<b>product</b> , and then follow the on-screen instructions.  The Intel chipset is configured to enforce hardware protection to block all direct read/write access to this area. An Intel utility is required for updating the firmware. Only firmware updates digitally signed by Intel can be applied using this utility.
Bluetooth flash (select products only)	2 Mbit	No	Yes	Stores Bluetooth configuration and firmware.	Bluetooth flash is programmed at the factory. Tools for writing data to this memory are not publicly available but can be obtained from the silicon vendor.	A utility is required for writing data to this memory and is made available through newer versions of the driver whenever the flash requires an upgrade.
802.11 WLAN EEPROM	4 Kbit to 8 Kbit	No	Yes	Stores configuration and calibration data.	802.11 WLAN EEPROM is programmed at the factory. Tools for writing data to this memory are not made public.	A utility is required for writing data to this memory and is typically not made available to the public unless a firmware upgrade is necessary to address a unique issue.
Camera (select products only)	64 Kbit	No	Yes	Stores camera configuration and firmware.	Camera memory is programmed using a utility from the device manufacturer that can be run from Windows.	A utility is required for writing data to this memory and is typically not made available to the public unless a firmware upgrade is necessary to address a unique issue.
Fingerprint reader (select products only)	512 KByte flash	Yes	Yes	Stores fingerprint templates.	Fingerprint reader memory is programmed by user enrollment in HP ProtectTools Security Manager.	Only a digitally signed application can make the call to write to the flash.

# Questions and answers

## 1. How can the BIOS settings be restored (returned to factory settings)?



**IMPORTANT:** Restore defaults does not securely erase any data on your hard drive. See question and answer 6 for steps to securely erase data.

Restore defaults does not reset the Custom Secure Boot keys. See question and answer 7 for information about resetting the keys.

- a. Turn on or restart the computer, and then press **esc** while the "Press the ESC key for Startup Menu" message is displayed at the bottom of the screen.
- b. Select **Main**, and then select **Apply Factory Defaults and Exit**.
- c. Follow the on-screen instructions.
- d. Select **Main**, select **Save Changes and Exit**, and then follow the on-screen instructions.

## 2. What is a UEFI BIOS, and how is it different from a legacy BIOS?

The Unified Extensible Firmware Interface (UEFI) BIOS is an industry-standard software interface between the platform firmware and an operating system (OS). It is a replacement for the older BIOS architecture, but supports much of the legacy BIOS functionality.

Like the legacy BIOS, the UEFI BIOS provides an interface to display the system information and configuration settings and to change the configuration of your computer before an OS is loaded. BIOS provides a secure run-time environment that supports a Graphic User Interface (GUI). In this environment, you can use either a pointing device (Touchscreen, TouchPad, pointing stick, or USB mouse) or the keyboard to navigate and make menu and configuration selections. The UEFI BIOS also contains basic system diagnostics.

The UEFI BIOS provides functionality beyond that of the legacy BIOS. In addition, the UEFI BIOS works to initialize the computer's hardware before loading and executing the OS; the run-time environment allows the loading and execution of software programs from storage devices to provide more functionality, such as advanced hardware diagnostics (with the ability to display more detailed system information) and advanced firmware management and recovery software.

HP has provided options in Computer Setup (BIOS) to allow you to run in legacy BIOS, if required by the operating system. Examples of this requirement would be if you upgrade or downgrade the OS.

## 3. Where does the UEFI BIOS reside?

The UEFI BIOS resides on a flash memory chip. A utility is required to write to the chip.

## 4. What kind of configuration data is stored on the DIMM Serial Presence Detect (SPD) memory module? How would this data be written?

The DIMM SPD memory contains information about the memory module, such as size, serial number, data width, speed/timing, voltage, and thermal information. This information is written by the module manufacturer and stored on an EEPROM. This EEPROM cannot be written to when the memory module is installed in a computer. Third-party tools do exist that can write to the EEPROM when the memory module is not installed in a computer. Various third-party tools are available to read SPD memory.

## 5. What is meant by "Restore the nonvolatile memory found in Intel-based system boards"?

This message relates to clearing the Real Time Clock (RTC) CMOS memory that contains computer configuration data.

## 6. How can the BIOS security be reset to factory defaults and data erased?

---

 **IMPORTANT:** Resetting will result in the loss of information.

These steps will not reset Custom Secure Boot Keys. See question and answer 7 for information about resetting the keys.

---

- a. Turn on or restart the computer, and then press **esc** while the "Press the ESC key for Startup Menu" message is displayed at the bottom of the screen.
- b. Select **Main**, and then select **Reset Security to Factory Defaults**.
- c. Follow the on-screen instructions.
- d. Select **Main**, select **Save Changes and Exit**, and then follow the on-screen instructions.

#### 7. How can the Custom Secure Boot Keys be reset?

Secure Boot is a feature to ensure that only authenticated code can start on a platform. If you enabled Secure Boot and created Custom Secure Boot Keys, simply disabling Secure Boot will not clear the keys. You must also select to clear the Custom Secure Boot Keys. Use the same Secure Boot access procedure you used to create the Custom Secure Boot Keys, but make the selection to clear or delete all Secure Boot Keys.

- a. Turn on or restart the computer, and then press **esc** while the "Press the ESC key for Startup Menu" message is displayed at the bottom of the screen.
- b. Select the **Security** menu, select **Secure Boot Configuration**, and then follow the on-screen instructions.
- c. At the **Secure Boot Configuration** window, select **Secure Boot**, select **Clear Secure Boot Keys**, and then follow the on-screen instructions to continue.

## Using HP Sure Start (select models only)

Select computer models are configured with HP Sure Start, a technology that continuously monitors your computer's BIOS for attacks or corruption. If the BIOS becomes corrupted or is attacked, HP Sure Start restores the BIOS to its previously safe state, without user intervention. Those select computer models ship with HP Sure Start configured and enabled. HP Sure Start is configured and already enabled so that most users can use the HP Sure Start default configuration. The default configuration can be customized by advanced users.

To access the latest documentation on HP Sure Start, go to <http://www.hp.com/support>. Select **Find your product**, and then follow the on-screen instructions.



---

## 12 Power cord set requirements

The wide-range input feature of the computer permits it to operate from any line voltage from 100 to 120 volts ac, or from 220 to 240 volts ac.

The 3-conductor power cord set included with the computer meets the requirements for use in the country or region where the equipment is purchased.

Power cord sets for use in other countries and regions must meet the requirements of the country or region where the computer is used.

### Requirements for all countries

The following requirements are applicable to all countries and regions:

- The length of the power cord set must be at least **1.5 m** (5.0 ft) and no more than **2.0 m** (6.5 ft).
- All power cord sets must be approved by an acceptable accredited agency responsible for evaluation in the country or region where the power cord set will be used.
- The power cord sets must have a minimum current capacity of 10 A and a nominal voltage rating of 125 or 250 V ac, as required by the power system of each country or region.
- The appliance coupler must meet the mechanical configuration of an EN 60 320/IEC 320 Standard Sheet C13 connector for mating with the appliance inlet on the back of the computer.

## Requirements for specific countries and regions

Country/region	Accredited agency	Applicable note number
Argentina	IRAM	1
Australia	SAA	1
Austria	OVE	1
Belgium	CEBEC	1
Brazil	ABNT	1
Canada	CSA	2
Chile	IMQ	1
Denmark	DEMKO	1
Finland	FIMKO	1
France	UTE	1
Germany	VDE	1
India	ISI	1
Israel	SII	1
Italy	IMQ	1
Japan	JIS	3
The Netherlands	KEMA	1
New Zealand	SANZ	1
Norway	NEMKO	1
The People's Republic of China	CCC	4
Saudi Arabia	SASO	7
Singapore	PSB	1
South Africa	SABS	1
South Korea	KTL	5
Sweden	SEMKO	1
Switzerland	SEV	1
Taiwan	BSMI	6
Thailand	TISI	1
The United Kingdom	ASTA	1
The United States	UL	2

1. The flexible cord must be Type H05VV-F, 3-conductor, 0.75mm<sup>2</sup> conductor size. Power cord set fittings (appliance coupler and wall plug) must bear the certification mark of the agency responsible for evaluation in the country or region where it will be used.
2. The flexible cord must be Type SVT/SJT or equivalent, No. 18 AWG, 3-conductor. The wall plug must be a two-pole grounding type with a NEMA 5-15P (15 A, 125 V ac) or NEMA 6-15P (15 A, 250 V ac) configuration. CSA or C-UL mark. UL file number must be on each element.

Country/region	Accredited agency	Applicable note number
		<p>3. The appliance coupler, flexible cord, and wall plug must bear a “T” mark and registration number in accordance with the Japanese Dentori Law. The flexible cord must be Type VCTF, 3-conductor, 0.75mm<sup>2</sup> or 1.25mm<sup>2</sup> conductor size. The wall plug must be a two-pole grounding type with a Japanese Industrial Standard C8303 (7 A, 125 V ac) configuration.</p>
		<p>4. The flexible cord must be Type RVV, 3-conductor, 0.75mm<sup>2</sup> conductor size. Power cord set fittings (appliance coupler and wall plug) must bear the CCC certification mark.</p>
		<p>5. The flexible cord must be Type H05VV-F 3X0.75mm<sup>2</sup> conductor size. KTL logo and individual approval number must be on each element. Corset approval number and logo must be printed on a flag label.</p>
		<p>6. The flexible cord must be Type HVCTF 3X1.25mm<sup>2</sup> conductor size. Power cord set fittings (appliance coupler, cable, and wall plug) must bear the BSMI certification mark.</p>
		<p>7. For 127 V ac, the flexible cord must be Type SVT or SJT 3 x 18 AWG, with plug NEMA 5-15P (15 A, 125 V ac), with UL and CSA or C-UL marks. For 240 V ac, the flexible cord must be Type H05VV-F 3X0.75/1.00mm<sup>2</sup> conductor size, with plug BS 1363/A with BSI or ASTA marks.</p>



---

## 13 Recycling

When a non-rechargeable or rechargeable battery has reached the end of its useful life, do not dispose of the battery in general household waste. Follow the local laws and regulations in your area for battery disposal.

HP encourages customers to recycle used electronic hardware, HP original print cartridges, and rechargeable batteries. For more information about recycling programs, see the HP Web site at <http://www.hp.com/recycle>.



# Index

## A

- action keys
  - using 15
- airplane mode key 15
- antenna
  - illustrated 24
- antennas
  - removing 73, 74
- audio, product description 3
- audio-out (headphone)/audio-in (microphone) combo jack, identifying 8

## B

- backups 85
- battery
  - illustrated 21
  - removing 32
- battery cover, identifying 16
- battery light 8
- battery lock, identifying 16
- battery release latch 16
- BIOS
  - determining version 82
  - downloading an update 83
  - updating 82
- Bluetooth label 17
- boot order
  - changing 89
  - changing using the f9 prompt 84
- bottom 17
- bottom cover
  - illustrated 22
  - removing 40
- buttons
  - left TouchPad 11
  - optical drive eject 7
  - power 13
  - right TouchPad 11

## C

- cable locations
  - removing 78

- cables
  - illustrated 24
- cables, service considerations 27
- camera 10
- camera light, identifying 10
- camera, identifying 10
- camera/microphone cable
  - illustrated 24
  - removing 37, 69, 70
- camera/microphone module
  - illustrated 23
  - removing 36, 68
- caps lock light, identifying 12
- components
  - bottom 16
  - display 10
  - left side 8
  - right side 7
  - top 11
- computer major components, illustrated 19
- Computer Setup
  - navigating and selecting 81
  - restoring factory settings 82
  - using a USB keyboard or USB mouse to start Computer Setup 81
- computer setup 81
- computer specifications 93
- connector, power 8
- connectors, service considerations 27

## D

- display assembly
  - illustrated 20
  - removing 66
- display assembly subcomponents
  - illustrated 23
  - removing 66
- display bezel
  - illustrated 23
  - removing 35, 67

- display cable
  - illustrated 24
  - removing 70
- display enclosure
  - illustrated 24
  - removing 75
- display panel
  - illustrated 23
  - product description 1
  - removing 37, 69, 70
- display specifications 94
- display subcomponents
  - removal 35
  - spare part numbers 35
- drive light 7
- DVD±RW SuperMulti DL Drive specifications 97

## E

- electrostatic discharge 28
- equipment guidelines 30
- esc key, identifying 14
- Ethernet, product description 3
- external media cards 3
- external monitor port 8

## F

- fan
  - illustrated 20
  - removing 57
- fn key, identifying 14
- function keys, identifying 14

## G

- graphics, product description 1
- grounding guidelines 28
- guidelines
  - equipment 30
  - grounding 28
  - packaging 29
  - transporting 29
  - workstation 29

- H**
- hard drive
  - illustrated 21, 25
  - precautions 28
  - product description 2
  - removing 48
  - specifications 95
- hard drive board
  - illustrated 21
- hard drive bracket
  - illustrated 21, 25
- hard drive brackets
  - removing 49
- hard drive connector
  - removing 50
- hard drive connector and cable
  - removing 49
- hard drive connector board
  - removing 48
- hard drive connector board cable
  - illustrated 24
- HDMI port, identifying 8
- heat sink assembly
  - illustrated 20
  - removing 20, 59
- hinge cover
  - illustrated 23
- hinges
  - illustrated 24
  - removing 37, 69, 70
- HP PC Hardware Diagnostics (UEFI)
  - using 91
- HP Recovery Manager
  - correcting boot problems 89
  - starting 88
- HP Recovery media
  - creating 85
  - recovery 88
- HP Recovery partition
  - recovery 88
  - removing 90
- HP Sure Start 104
  
- I**
- integrated camera light, identifying 10
- integrated numeric keypad, identifying 14
- internal card
  - product description 3
- internal microphone, identifying 10
  
- J**
- jacks
  - audio-out (headphone)/audio-in (microphone) combo 8
  - network 8
  - RJ-45 (network) 8
  
- K**
- keyboard
  - illustrated 20
  - product description 3
- keypad
  - integrated numeric 14
- keys
  - airplane mode 15
  - esc 14
  - fn 14
  - Windows key 14
  
- L**
- labels
  - Bluetooth 17
  - regulatory 17
  - serial number 17
  - service 17
  - wireless certification 17
  - WLAN 17
- latch, battery release 16
- lights
  - battery 8
  - camera 10
  - caps lock 12
  - drive 7
  - power 7
  - RJ-45 (network) 8
  
- M**
- M.2 solid-state drive
  - specifications 96
- M.2 solid-state drive adapter bracket and connector board
  - removing 51
- mass storage devices
  - illustrated 25
  - precautions 28
- memory
  - nonvolatile 99
  - volatile 99
- memory card reader, identifying 7
- memory module
  - illustrated 20
  - product description 1
  - removing 45
- microphone 2
- minimized image recovery 88
- minimized image, creating 87
- model name 1
  
- N**
- network jack, identifying 8
- nonvolatile memory 99
  
- O**
- operating system 4
- optical drive
  - illustrated 21, 25
  - precautions 28
  - product description 2
  - removing 33
  - specifications 97
- optical drive bezel
  - illustrated 25
- optical drive bracket
  - illustrated 25
- optical drive connector board
  - illustrated 21, 47
  - removing 47
- optical drive connector board cable
  - illustrated 24
- optical drive eject button, identifying 7
- optical drive rear bracket
  - removing 34
- optical drive, identifying 7
- original system recovery 87
  
- P**
- packaging guidelines 29
- plastic parts, service considerations 27
- pointing device 3
- ports
  - external monitor 8
  - HDMI 8
  - product description 3
  - USB 2.0 7
  - USB 3.x SuperSpeed 8
- power button board
  - illustrated 20
  - removing 77



- power button board cable
    - illustrated 24
  - power button, identifying 13
  - power connector cable
    - illustrated 20
    - removing 76
  - power connector, identifying 8
  - power cord
    - requirements for all countries 105
    - requirements for specific countries and regions 106
    - set requirements 105
    - spare part numbers 26
  - power lights 7
  - power requirements 4
  - processor
    - product description 1
  - product description
    - audio 3
    - display panel 1
    - Ethernet 3
    - external media cards 3
    - graphics 1
    - hard drive 2
    - internal card 3
    - keyboard 3
    - memory module 1
    - microphone 2
    - operating system 4
    - optical drive 2
    - pointing device 3
    - ports 3
    - power requirements 4
    - processor 1
    - product name 1
    - security 4
    - serviceability 4
    - video 2
    - wireless 3
  - product name 1
  - product name and number, computer 17
- R**
- recover
    - options 87
  - recovery
    - discs 86, 88
    - HP Recovery Manager 87
    - media 88
    - starting 88
    - supported discs 86
    - system 87
    - USB flash drive 88
    - using HP Recovery media 86
  - recovery media
    - creating 85
    - creating using HP Recovery Manager 86
  - recovery partition
    - removing 90
  - regulatory information
    - regulatory label 17
    - wireless certification labels 17
  - removal/replacement
    - preliminaries 27
    - procedures 31, 35
  - removing personal data from volatile system memory 99
  - RJ-45 (network) jack, identifying 8
  - RJ-45 (network) lights, identifying 8
  - RTC battery
    - illustrated 20
    - removing 54
  - rubber feet
    - removing 39
- S**
- security cable slot, identifying 7
  - security, product description 4
  - serial number 17
  - serial number, computer 17
  - service considerations
    - cables 27
    - connectors 27
    - plastic parts 27
  - service labels, locating 17
  - serviceability, product description 4
  - setup utility
    - navigating and selecting 81
    - restoring factory settings 82
  - slots
    - security cable 7
  - solid-state drive
    - illustrated 25
    - removal 53
    - spare part number 20, 25, 53
  - solid-state drive board
    - illustrated 21, 51
  - solid-state drive bracket
    - illustrated 21, 51
  - speakers
    - illustrated 21
    - removing 55
  - speakers, identifying 16
  - specifications
    - computer 93
    - display 94
    - DVD±RW SuperMulti DL Drive 97
    - hard drive 95
    - M.2 solid-state drive 96
    - optical drive 97
  - supported discs, recovery 86
  - Sure Start
    - using 84
  - system board
    - removing 64
    - spare part number 21, 64
  - system memory, removing personal data from volatile 99
  - system recovery 87
  - system restore point
    - creating 86
  - system restore point, creating 85
- T**
- tools required 27
  - top cover/keyboard
    - removing 79
  - TouchPad
    - buttons 11
  - TouchPad button board
    - removing 63
    - spare part number 20, 63
  - TouchPad button board cable
    - illustrated 24
  - TouchPad cable
    - illustrated 24
  - TouchPad zone
    - identifying 11
  - TPM settings 84
  - transporting guidelines 29
  - traveling with the computer 17
- U**
- USB 2.0 port, identifying 7

- USB 3.x SuperSpeed port,
  - identifying 8
- USB board
  - removing 56
  - spare part number 20
- USB board cable
  - illustrated 24

## V

- vents, identifying 8, 16
- video, product description 2

## W

- Windows
  - system restore point 85, 86
- Windows key, identifying 14
- Windows tools
  - using 86
- wireless antenna
  - illustrated 24
- wireless antennas
  - removing 73, 74
- wireless certification label 17
- wireless, product description 3
- WLAN antennas, identifying 10
- WLAN device 17
- WLAN label 17
- WLAN module
  - illustrated 20
  - removing 43
- workstation guidelines 29