



# HP ProBook 440 G5 Notebook PC

## Maintenance and Service Guide

© Copyright 2017 HP Development Company, L.P.

AMD is a trademark of Advanced Micro Devices, Inc. Bluetooth is a trademark owned by its proprietor and used by HP Inc. under license. Intel is a trademark of Intel Corporation in the U.S. and other countries. Microsoft and Windows are trademarks of the Microsoft group of companies.

The information contained herein is subject to change without notice. The only warranties for HP products and services are set forth in the express warranty statements accompanying such products and services. Nothing herein should be construed as constituting an additional warranty. HP shall not be liable for technical or editorial errors or omissions contained herein.

First Edition: September 2017

Document Part Number: 941279-001

### **Product notice**

This user guide describes features that are common to most models. Some features may not be available on your computer.

Not all features are available in all editions of Windows. This computer may require upgraded and/or separately purchased hardware, drivers and/or software to take full advantage of Windows functionality. Go to <http://www.microsoft.com> for details.

### **Your product does not support Windows 8 or Windows 7**

In accordance with Microsoft's support policy, HP does not support the Windows 8 or Windows 7 operating system on this product or provide any Windows 8 or Windows 7 drivers on <http://support.hp.com>.

### **Software terms**

By installing, copying, downloading, or otherwise using any software product preinstalled on this computer, you agree to be bound by the terms of the HP End User License Agreement (EULA). If you do not accept these license terms, your sole remedy is to return the entire unused product (hardware and software) within 14 days for a full refund subject to the refund policy of your seller.

For any further information or to request a full refund of the price of the computer, please contact your seller.

## Important Notice about Customer Self-Repair Parts

---

 **CAUTION:** Your computer includes Customer Self-Repair parts and parts that should only be accessed by an authorized service provider. See Chapter 5, "Removal and replacement procedures for Customer Self-Repair parts," for details. Accessing parts described in Chapter 6, "Removal and replacement procedures for Authorized Service Provider only parts," can damage the computer or void your warranty.

---



## Safety warning notice

---

 **WARNING!** To reduce the possibility of heat-related injuries or of overheating the computer, do not place the computer directly on your lap or obstruct the computer air vents. Use the computer only on a hard, flat surface. Do not allow another hard surface, such as an adjoining optional printer, or a soft surface, such as pillows or rugs or clothing, to block airflow. Also, do not allow the AC adapter to contact the skin or a soft surface, such as pillows or rugs or clothing, during operation. The computer and the AC adapter comply with the user-accessible surface temperature limits defined by the International Standard for Safety of Information Technology Equipment (IEC 60950-1).

---



---

# Table of contents

<b>1 Product description .....</b>	<b>1</b>
<b>2 Components .....</b>	<b>6</b>
Right .....	6
Left .....	7
Display .....	9
Keyboard area .....	10
TouchPad .....	10
Lights .....	11
Buttons, speakers, and fingerprint reader .....	12
Special keys .....	13
Action keys .....	14
Bottom .....	15
Labels .....	16
Inserting a SIM card (select products only) .....	17
<b>3 Illustrated parts catalog .....</b>	<b>18</b>
Computer major components .....	18
Display components .....	21
Cable Kit .....	22
Plastics Kit .....	23
Bracket Kit .....	23
Mass storage devices .....	24
Miscellaneous parts .....	25
<b>4 Removal and replacement procedures preliminary requirements .....</b>	<b>27</b>
Tools required .....	27
Service considerations .....	27
Plastic parts .....	27
Cables and connectors .....	28
Drive handling .....	28
Grounding guidelines .....	29
Electrostatic discharge damage .....	29
Packaging and transporting guidelines .....	30
Workstation guidelines .....	30
Equipment guidelines .....	31

<b>5 Removal and replacement procedures for Customer Self-Repair parts .....</b>	<b>32</b>
Component replacement procedures .....	32
Battery Safe mode .....	32
Service doors .....	33
Memory modules .....	35
WLAN/Bluetooth combo card .....	37
WWAN module .....	39
Hard drive .....	41
M.2 solid-state drive .....	43
Keyboard .....	44
<b>6 Removal and replacement procedures for Authorized Service Provider parts .....</b>	<b>47</b>
Component replacement procedures .....	47
Top cover .....	48
Fingerprint reader assembly .....	51
Power button board .....	53
Speaker assembly .....	55
TouchPad assembly .....	57
Card reader board .....	59
Fan .....	60
Hard drive cable .....	62
RTC battery .....	63
Battery .....	64
USB board .....	65
System board .....	67
Heat sink assembly .....	70
Display assembly – non-touch .....	73
Power cable .....	80
<b>7 Computer Setup (BIOS), TPM, and HP Sure Start .....</b>	<b>81</b>
Using Computer Setup .....	81
Starting Computer Setup .....	81
Using a USB keyboard or USB mouse to start Computer Setup (BIOS) .....	81
Navigating and selecting in Computer Setup .....	81
Restoring factory settings in Computer Setup .....	82
Updating the BIOS .....	82
Determining the BIOS version .....	82
Downloading a BIOS update .....	83
Changing the boot order using the f9 prompt .....	84
TPM BIOS settings (select products only) .....	84



Using HP Sure Start (select products only) .....	84
<b>8 Using HP PC Hardware Diagnostics (UEFI) .....</b>	<b>85</b>
Downloading HP PC Hardware Diagnostics (UEFI) to a USB device .....	85
Using Remote HP PC Hardware Diagnostics (UEFI) settings (select products only) .....	86
Customizing Remote HP PC Hardware Diagnostics (UEFI) settings .....	86
<b>9 Backing up, restoring, and recovering .....</b>	<b>87</b>
Creating recovery media and backups .....	87
Creating HP Recovery media (select products only) .....	87
Using Windows tools .....	88
Restore and recovery .....	89
Recovering using HP Recovery Manager .....	89
What you need to know before you get started .....	89
Using the HP Recovery partition (select products only) .....	90
Using HP Recovery media to recover .....	90
Changing the computer boot order .....	91
Removing the HP Recovery partition (select products only) .....	91
<b>10 Specifications .....</b>	<b>92</b>
Computer specifications .....	92
35.6-cm (14.0-in) display specifications .....	93
Hard drive specifications .....	94
Solid-state drive specifications .....	95
<b>11 Statement of memory volatility .....</b>	<b>96</b>
Nonvolatile memory usage .....	98
Questions and answers .....	100
Using HP Sure Start (select models only) .....	101
<b>12 Power cord set requirements .....</b>	<b>102</b>
Requirements for all countries and regions .....	102
Requirements for specific countries and regions .....	102
<b>13 Recycling .....</b>	<b>104</b>
<b>Index .....</b>	<b>105</b>



# 1 Product description

Category	Description
<b>Product Name</b>	<b>HP ProBook 440 G5 Notebook PC</b>
<b>Processors</b>	<b>8th generation, Intel® Core™ i7 processor, quad core</b> (8-MB L3 cache, 15 W) i7-8550U, 1.8 GHz/3.7 GHz quad core turbo; Intel UHD Graphics 620
	<b>8th generation, Intel Core i5 processors, quad core</b> (6-MB L3 cache, 15 W) i5-8350U, 1.7 GHz/3.6 GHz quad core turbo; Intel UHD Graphics 620
	i5-8250U, 1.6 GHz/3.4 GHz quad core turbo; Intel UHD Graphics 620
	<b>7th generation, Intel Core i5 processors, dual core</b> (3-MB L3 cache, 15 W) i5-7200U, 2.5-GHz/3.1-GHz single core turbo; Intel HD Graphics 620
	<b>7th generation, Intel Core i3 processor, dual core</b> (3-MB L3 cache, 15 W) i3-7100U, 2.4-GHz; Intel HD Graphics 620
	<b>6th generation, Intel Core i3 processor, dual core</b> (3-MB L3 cache, 15 W) i3-6006U, 2.0-GHz; Intel HD Graphics 520
	<b>Intel Celeron dual core processor</b> (2-MB L3 cache, 15 W) 3865U, 1.8-GHz; Intel HD Graphics
<b>Graphics</b>	Supports HD decode, DX12, HDMI 1.4b, HDCP 2.2 via HDMI up to 4K@30Hz, DP support 4K@60Hz on 7th/8th Generation Celeron, i3, i5, and i7 processors
	<b>Integrated UMA Graphics GT1 and GT2</b> Integrated with shared video memory; dynamically allocated
<b>Panel</b>	<b>35.6 cm (14.0-inch), LED backlight, 16:9 aspect ratio, SVA, HD (1366x768), 220 nits, eDP, slim (3.0 mm)</b> 1 or 2 WLAN antennas, anti-glare (UMA only; not available with camera) Camera, 1 or 2 WLAN antennas, anti-glare (only available with camera) Camera, 2 WLAN antennas, WWAN, anti-glare (UMA only; only available with camera) Touch panel, IR camera, 1 or 2 WLAN antennas (only available with camera)
	<b>35.6 cm (14.0-inch), LED backlight, 16:9 aspect ratio, anti-glare, UWVA, FHD (1920x1080), 220 nits; eDP, IPS, slim (3.0 mm)</b> 1 or 2 WLAN antennas (UMA only; not available with camera) Camera, 1 or 2 WLAN antennas (only available with camera)
<b>Memory</b>	Two customer-accessible memory module slots supporting up to 32 GB of RAM Supports dual-channel memory PC4, 2133-MHz, DDR4 SODIMMs (models with 8th generation Intel Core processors run at 2400 MHz) Supports the following configurations:

Category	Description
	<ul style="list-style-type: none"> <li>• 32768 MB (16384 × 2; dual channel)</li> </ul>
	<ul style="list-style-type: none"> <li>• 16384 MB (16384 × 1)</li> </ul>
	<ul style="list-style-type: none"> <li>• 16384 MB (8192 × 2; dual channel)</li> </ul>
	<ul style="list-style-type: none"> <li>• 12288 MB (8192 + 4096; dual channel)</li> </ul>
	<ul style="list-style-type: none"> <li>• 8192 MB (8192 × 1)</li> </ul>
	<ul style="list-style-type: none"> <li>• 8192 MB (4096 × 2; dual channel)</li> </ul>
	<ul style="list-style-type: none"> <li>• 4096 MB (4096 × 1)</li> </ul>
	For use in Brazil:
	<ul style="list-style-type: none"> <li>• 16384 MB (8192 × 2; dual channel)</li> </ul>
	<ul style="list-style-type: none"> <li>• 8192 MB (8192 × 1)</li> </ul>
	<ul style="list-style-type: none"> <li>• 8192 MB (4096 × 2; dual channel)</li> </ul>
	<ul style="list-style-type: none"> <li>• 4096 MB (4096 × 1)</li> </ul>
<b>Primary storage</b>	<p>Supports hard drives with HP 3D DriveGuard</p> <p>Primary storage not required if primary M.2 storage selected</p> <p>Supports the following SATA, 7 mm, 2.5 inch hard drives:</p> <ul style="list-style-type: none"> <li>• 1-TB, 5400-rpm</li> <li>• 500-GB, 7200-rpm</li> <li>• 500-GB, hybrid (8-GB SSD)</li> </ul>
<b>Primary M.2 storage</b>	<p><b>M.2 2280 SSD (NGFF)</b></p> <ul style="list-style-type: none"> <li>• 512 GB, PCIe, NVMe, TLC (not available with Celeron)</li> <li>• 256 GB, PCIe, NVMe, value (not available with Celeron)</li> <li>• 128 GB, SATA, TLC</li> </ul>
<b>Audio/Visual</b>	<p>Audio controls</p> <p>Integrated mono microphone (non-camera models only)</p> <p>Integrated dual-array microphone (camera models only)</p> <p>Integrated camera (720p HD) (supports Wide Dynamic Range [WDR])</p> <p>IR camera (720p HD) (supports WDR)</p> <p>Stereo speakers (2)</p> <p>Headphone/microphone combo jack</p>
<b>Ethernet</b>	<p>Realtek RTL8111HSH 10/100/1000</p> <p>S3/S4/S5 wake on LAN (AC mode and battery mode)</p>
<b>Wireless</b>	<p><b>Integrated WLAN options by way of wireless module</b> (select models only)</p> <p>WLAN antennas built into top of display assembly</p> <p>Supports HP Connection Optimizer with wi-fi load balancing</p>

Category	Description
	<p>Supports the following wireless adapters via minicard connector:</p> <ul style="list-style-type: none"> <li>• Realtek RTL8822BE 802.11AC 2x2 Wi-Fi + BT 4.2 Combo Adapter</li> <li>• Realtek RTL8821CE 802.11AC 1x1 Wi-Fi + BT 4.2 Combo Adapter</li> <li>• Intel Dual Band Wireless-AC 3168 802.11ac, Dual Band, 1×1 Wi-Fi + Bluetooth 4.2</li> <li>• Intel Dual Band Wireless-AC 8265, 802.11ac, 2×2 Wi-Fi + Bluetooth 4.2 combination adapter (non-vPro)</li> </ul> <p><b>Wireless Personal Area Network (PAN) Bluetooth</b></p> <p>Bluetooth 4.2 supported using combo card</p> <p><b>Integrated WWAN options by way of wireless module</b> (select models only)</p> <p>SIM module: Micro SIM/3FF (user accessible under service door)</p> <p>Supports the following WWAN options using connector:</p> <ul style="list-style-type: none"> <li>• Huawei HP It4132, LTE/HSPA+ w/GPS M.2</li> <li>• Fibocom CAT9: Foxconn It4210 LTE/HSPA+ w/GPS</li> </ul> <p>WWAN antennas (2), worldwide, 5 band, configured at top of panel</p> <p>Supports “No WWAN” option</p>
<b>External media card</b>	<p><b>Digital Media Reader Slot</b></p> <p>Supports SD, SDHC, SDXC</p>
<b>Ports (Input/output)</b>	<p>VGA (Dsub 15-pin) supporting:</p> <ul style="list-style-type: none"> <li>• 2048×1536 external resolution at 60-GHz</li> <li>• Hot plug/unplug and auto detect</li> <li>• HDMI 1.4b</li> </ul> <p>USB 3.0 + powered port (left)</p> <p>USB 3.0 (right)</p> <p>USB Type-C (PD+DP, gen 1)</p> <p>Headphone/microphone combo jack</p> <p>RJ-45 (Ethernet, includes link and activity lights)</p> <p>Multi-pin AC port</p>
<b>Docking</b>	Docking via USB Type-C
<b>Keyboard/pointing devices</b>	<p><b>Keyboard</b></p> <p>HP Premium Keyboard</p> <p>TouchPad</p> <p>Full-sized, chiclet, spill-resistant keyboard (backlit or not backlit)</p> <p><b>TouchPad requirements</b></p> <p>Windows 10 gestures: taps enabled by default: on/off control by driver, 2-finger scrolling and zoom enabled by default, OSD (enable/disable), 3-finger tap - Cortana, 3- finger flick - App switch, 4-finger tap - Action Center</p>

<b>Category</b>	<b>Description</b>
<b>Power requirements</b>	<b>Battery</b>
	3-cell prismatic, 48-Wh, long-life, Li-ion battery
	<b>AC adapters</b>
	65-W Smart AC adapter, right angle, 4.5 mm (discrete only)
	65-W Smart AC adapter, right angle, 4.5 mm – EM (discrete only)
	45-W Smart AC adapter, right angle, 4.5 mm (UMA only)
	45-W Smart AC adapter, right angle, 4.5 mm (UMA only) – Argentina
	45-W Smart AC adapter, right angle, 2-prong, 4.5 mm (Japan only) (UMA only)
	<b>Power cords</b>
	3-wire plug - 1.8 m
	3-wire plug - 1.0 m
	2-wire plug - 1.0 m
	<b>Security</b>
Integrated fingerprint reader (select models only)	
TPM 2.0 SLB9670 (Infineon; soldered down)	
Hardware enforced firmware protection: HP Hardware Root of Trust	
ANSSI Certified Hardware Root of Trust: Yes	
Hardware enforced software protection: No	
Firmware based operating system recovery: No	
<b>Operating system</b>	<b>Operating system version</b>
	Windows 10
	<b>Preinstalled</b>
	Windows 10 Home 64
	Windows 10 Home 64 – Plus
	Windows 10 Home 64 Single Language
	Windows 10 Home 64 Single Language – Plus
	Windows 10 Home 64 Chinese Market - CPPP
	Windows 10 Home 64 Chinese Market - CPPP - Plus
	Windows 10 Home 64 StF MSNA for Higher Education
	Windows 10 Home 64 StF MSNA for Higher Education - Strategic
	Windows 10 Professional 64
	Windows 10 Professional StF MSNA
	Windows 10 Professional StF MSNA EM
	Windows 10 Professional 64 StF MSNA - Standard





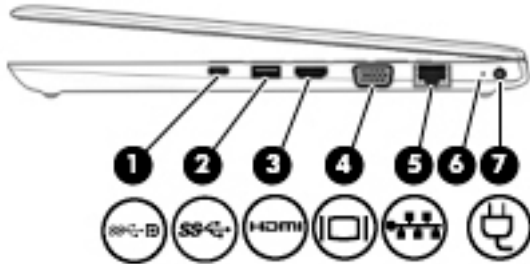

<b>Category</b>	<b>Description</b>
	Windows 10 Professional 64 StF MSNA - Plus
	Windows 10 Professional StF MSNA - Strategic
	FreeDOS 2.0
	<b>Restore Media (DRDVD/SRDVD)</b>
	DRDVD Windows 10
	<b>Restore Media (OSDVD)</b>
	Windows 10 Professional 64
	<b>Certified</b>
	Microsoft WHQL
	<b>Web-only support</b>
	Windows 10 Enterprise
	Windows 10 Enterprise 64 LTSB 1607
<b>Serviceability</b>	<b>End-user replaceable parts</b>
	AC adapter
	M.2 solid-state drive
	Hard drive
	Memory module
	WLAN module
	WWAN module
	WWAN SIM card
	Keyboard

## 2 Components

Your computer features top-rated components. This chapter provides details about your components, where they're located, and how they work.

### Right







Component	Description
(1) 	<p>USB Type-C power connector port, SuperSpeed port, and DisplayPort</p> <p>Connects an AC adapter that has a USB Type-C connector, supplying power to the computer and, if needed, charging the computer battery.</p> <p>– and –</p> <p>Connects a USB device that has a Type-C connector, such as a cell phone, camera, activity tracker, or smartwatch, and provides high-speed data transfer.</p> <p>– and –</p> <p>Connects a display device that has a USB Type-C connector, providing DisplayPort output.</p> <p><b>NOTE:</b> Cables and/or adapters (purchased separately) may be required.</p>
(2) 	<p>USB 3.x SuperSpeed port</p> <p>Connects a USB device, such as a cell phone, camera, activity tracker, or smartwatch, and provides high-speed data transfer.</p>
(3) 	<p>HDMI port</p> <p>Connects an optional video or audio device, such as a high-definition television, any compatible digital or audio component, or a high-speed High Definition Multimedia Interface (HDMI) device.</p>
(4) 	<p>External monitor port</p> <p>Connects an external VGA monitor or projector.</p>
(5) 	<p>RJ-45 (network) jack/status lights</p> <p>Connects a network cable.</p> <ul style="list-style-type: none"><li>• Green (right): The network is connected.</li><li>• Amber (left): Activity is occurring on the network.</li></ul>
(6) 	<p>Battery light</p> <p>When AC power is connected:</p> <ul style="list-style-type: none"><li>• White: The battery charge is greater than 90 percent.</li><li>• Amber: The battery charge is from 0 to 90 percent.</li><li>• Off: The battery is not charging.</li></ul>



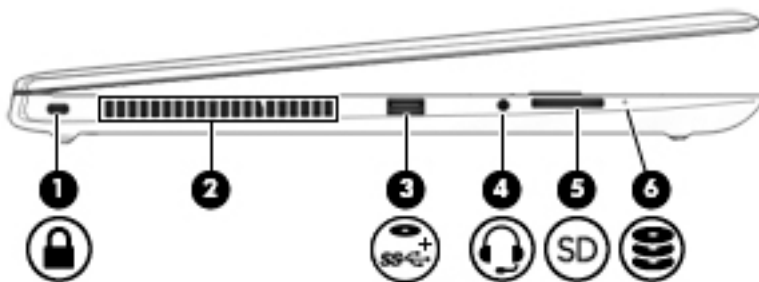

Component	Description
	<p>When AC power is disconnected (battery not charging):</p> <ul style="list-style-type: none"> <li>Blinking amber: The battery has reached a low battery level. When the battery has reached a critical battery level, the battery light begins blinking rapidly.</li> <li>Off: The battery is not charging.</li> </ul>
(7)  Power connector	Connects an AC adapter.

## Left



Component	Description
(1)  Security cable slot	<p>Attaches an optional security cable to the computer.</p> <p><b>NOTE:</b> The security cable is designed to act as a deterrent, but it may not prevent the computer from being mishandled or stolen.</p>
(2) Vent	<p>Enables airflow to cool internal components.</p> <p><b>NOTE:</b> The computer fan starts up automatically to cool internal components and prevent overheating. It is normal for the internal fan to cycle on and off during routine operation.</p>
(3)  USB 3.x SuperSpeed powered port	Connects a USB device, such as a cell phone, camera, activity tracker, optical drive, or smartwatch, and provides high-speed data transfer.
(4)  Audio-out (headphone)/Audio-in (microphone) combo jack	<p>Connects optional powered stereo speakers, headphones, earbuds, a headset, or a television audio cable. Also connects an optional headset microphone. This jack does not support optional standalone microphones.</p> <p><b>WARNING!</b> To reduce the risk of personal injury, adjust the volume before putting on headphones, earbuds, or a headset. For additional safety information, refer to the <i>Regulatory, Safety, and Environmental Notices</i>.</p> <p>To access this guide:</p> <ol style="list-style-type: none"> <li>Type <b>support</b> in the taskbar search box, and then select the <b>HP Support Assistant</b> app. – or – Click the question mark icon in the taskbar.</li> <li>Select <b>My PC</b>, select the <b>Specifications</b> tab, and then select <b>User Guides</b>.</li> </ol>

Component	Description
(5)  Memory card reader	<p><b>NOTE:</b> When a device is connected to the jack, the computer speakers are disabled.</p> <p>Reads optional memory cards that store, manage, share, or access information.</p> <p>To insert a card:</p> <ol style="list-style-type: none"> <li>1. Hold the card label-side up, with the connectors facing the computer.</li> <li>2. Insert the card into the memory card reader, and then press in on the card until it is firmly seated.</li> </ol> <p>To remove a card:</p> <ul style="list-style-type: none"> <li>▲ Press in on the card, and then remove it from the memory card reader.</li> </ul>
(6)  Drive light	<ul style="list-style-type: none"> <li>• Blinking white: The hard drive is being accessed.</li> <li>• Amber: HP 3D DriveGuard has temporarily parked the hard drive.</li> </ul>

# Display

 **NOTE:** Refer to the illustration that most closely matches your computer.

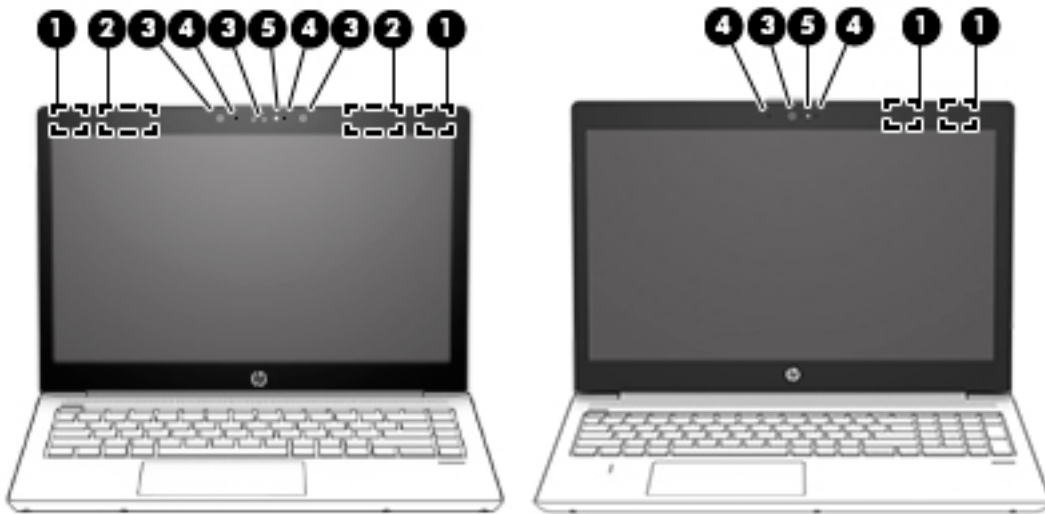

Component	Description
(1) WLAN antennas* (select products only)	Send and receive wireless signals to communicate with wireless local area networks (WLANs).
(2) WWAN antennas* (select products only)	Send and receive wireless signals to communicate with wireless wide area networks (WWANs).
(3) Camera(s) (select products only)	Allow you to video chat, record video, and record still images. Some cameras also allow a facial recognition logon to Windows, instead of a password logon. <b>NOTE:</b> Camera functions vary depending on the camera hardware and software installed on your product.
(4) Internal microphones (1 or 2 depending on model)	Record sound.
(5) Camera light (select products only)	On: One or more cameras are in use.

\*The antennas are not visible from the outside of the computer. For optimal transmission, keep the areas immediately around the antennas free from obstructions.

For wireless regulatory notices, see the section of the *Regulatory, Safety, and Environmental Notices* that applies to your country or region.

To access this guide:

1. Type `support` in the taskbar search box, and then select the **HP Support Assistant** app.

– or –

Click the question mark icon in the taskbar.

2. Select **My PC**, select the **Specifications** tab, and then select **User Guides**.

# Keyboard area



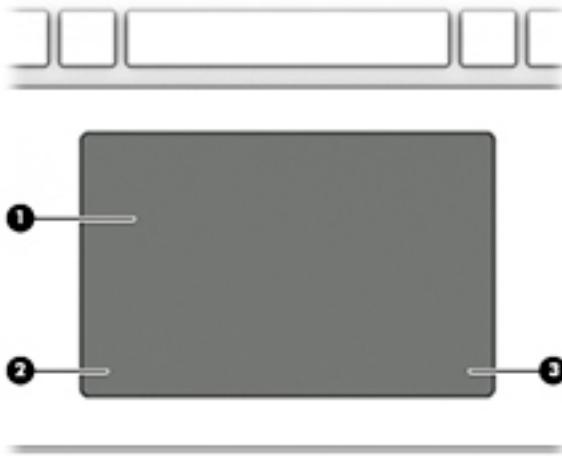

## TouchPad

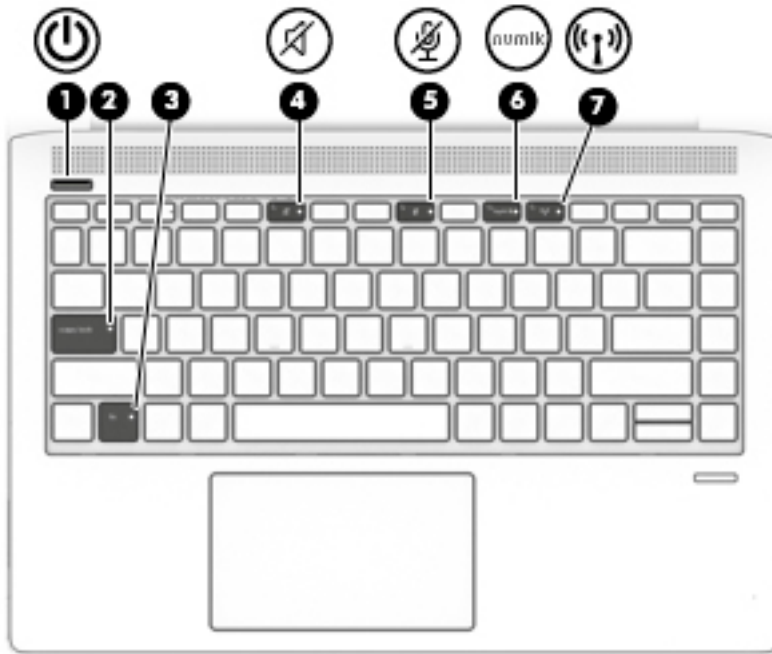

Component		Description
(1)	TouchPad zone	Reads your finger gestures to move the pointer or activate items on the screen.
(2)	Left TouchPad button	Functions like the left button on an external mouse.
(3)	Right TouchPad button	Functions like the right button on an external mouse.



## Lights



Component	Description
(1)  Power light	<ul style="list-style-type: none"> <li>On: The computer is on.</li> <li>Blinking: The computer is in the Sleep state, a power-saving state. The computer shuts off power to the display and other unneeded components.</li> <li>Off: The computer is off or in Hibernation. Hibernation is a power-saving state that uses the least amount of power.</li> </ul>
(2) Caps lock light	On: Caps lock is on, which switches the key input to all capital letters.
(3) Fn lock light	On: The <b>fn</b> key is locked.
(4)  Mute light	<ul style="list-style-type: none"> <li>Amber: Computer sound is off.</li> <li>Off: Computer sound is on.</li> </ul>
(5)  Microphone mute light	<ul style="list-style-type: none"> <li>Amber: Microphone is off.</li> <li>Off: Microphone is on.</li> </ul>
(6)  Num Lk light	On: Num lock is on.
(7)  Wireless light	<p>On: An integrated wireless device, such as a wireless local area network (WLAN) device and/or a Bluetooth® device, is on.</p> <p><b>NOTE:</b> On some models, the wireless light is amber when all wireless devices are off.</p>

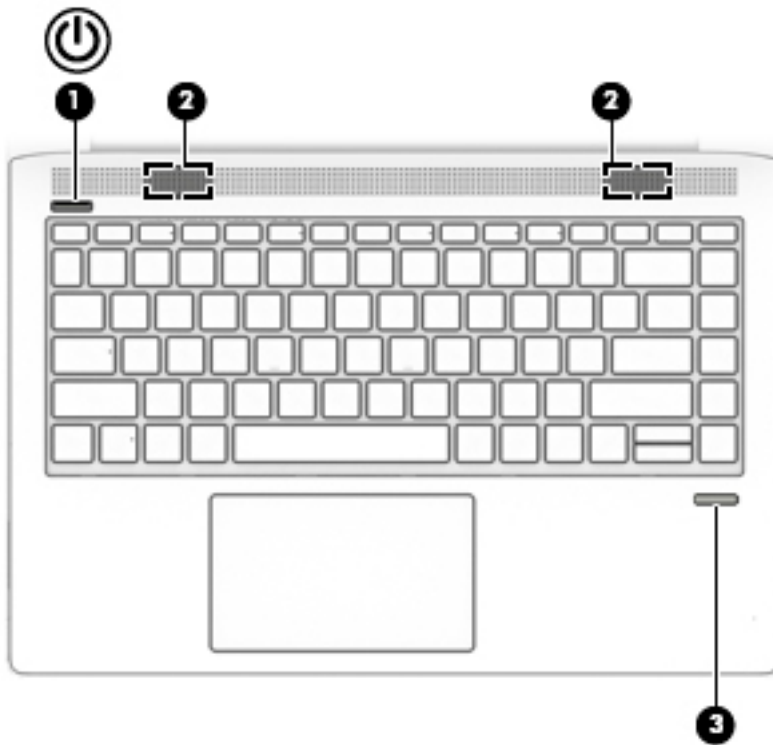

## Buttons, speakers, and fingerprint reader

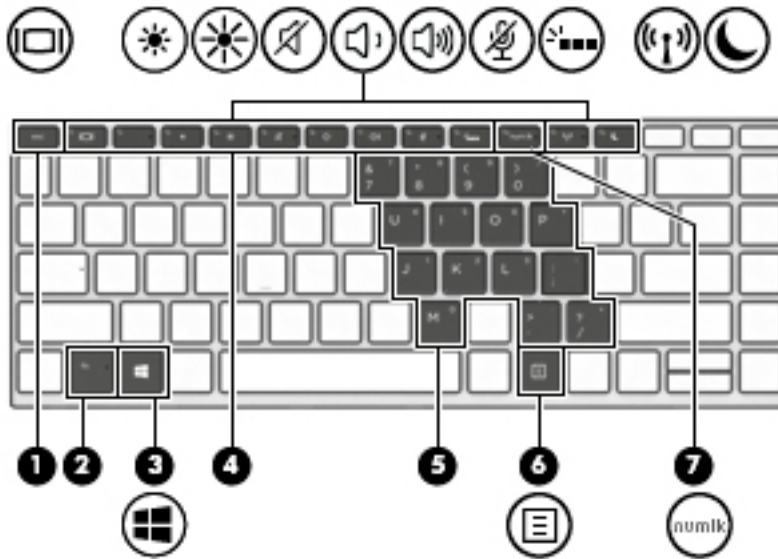

Component	Description
(1)  Power button	<ul style="list-style-type: none"><li>• When the computer is off, press the button to turn on the computer.</li><li>• When the computer is on, press the button briefly to initiate Sleep.</li><li>• When the computer is in the Sleep state, press the button briefly to exit Sleep.</li><li>• When the computer is in Hibernation, press the button briefly to exit Hibernation.</li></ul> <p><b>CAUTION:</b> Pressing and holding down the power button results in the loss of unsaved information.</p> <p>If the computer has stopped responding and shutdown procedures are ineffective, press and hold the power button for at least 5 seconds to turn off the computer.</p> <p>To learn more about your power settings, see your power options.</p> <p>▲ Right-click the <b>Power meter</b> icon  and then select <b>Power Options</b>.</p>
(2) Speakers (2)	Produce sound.
(3) Fingerprint reader (select products only)	Allows a fingerprint logon to Windows, instead of a password logon.

## Special keys













Component	Description
(1) <code>esc</code> key	Displays system information when pressed in combination with the <code>fn</code> key.
(2) <code>fn</code> key	Executes frequently used system functions when pressed in combination with another key. Such key combinations are called <i>hot keys</i> .
(3)  Windows key	Opens the <b>Start</b> menu. <b>NOTE:</b> Pressing the Windows key again will close the <b>Start</b> menu.
(4) Action keys	Execute frequently used system functions. See <a href="#">Action keys on page 14</a> .
(5) Embedded numeric keypad	A numeric keypad superimposed over the keyboard alphabet keys. When <code>fn+num lk</code> is pressed, the keypad can be used like an external numeric keypad. Each key on the keypad performs the function indicated by the icon in the upper-right corner of the key. <b>NOTE:</b> If the keypad function is active when the computer is turned off, that function is reinstated when the computer is turned back on.
(6)  Windows application key	Displays options for a selected object.
(7) <code>num lk</code> key	Turns the embedded numeric keypad on and off when pressed in combination with the <code>fn</code> key. – or – Alternates between the navigational and numeric functions on the integrated numeric keypad.

## Action keys

An action key performs the function indicated by the icon on the key. To determine which keys are on your product, see [Special keys on page 13](#).

▲ To use an action key, press and hold the key.

Icon	Description
	Switches the screen image among display devices connected to the system. For example, if a monitor is connected to the computer, repeatedly pressing the key alternates the screen image from computer display to monitor display to simultaneous display on both the computer and monitor.
	Decreases the screen brightness incrementally as long as you hold down the key.
	Increases the screen brightness incrementally as long as you hold down the key.
	Mutes or restores speaker sound.
	Decreases speaker volume incrementally while you hold down the key.
	Increases speaker volume incrementally while you hold down the key.
	Mutes the microphone.
	Turns the keyboard backlight off or on. <b>NOTE:</b> To conserve battery power, turn off this feature.
	Turns the wireless feature on or off. <b>NOTE:</b> A wireless network must be set up before a wireless connection is possible.
	Initiates Sleep, which saves your information in system memory. The display and other system components turn off and power is conserved. To exit Sleep, briefly press the power button. <b>CAUTION:</b> To reduce the risk of information loss, save your work before initiating Sleep.





**NOTE:** The action key feature is enabled at the factory. You can disable this feature by pressing and holding the **fn** key and the left **shift** key. The **fn** lock light will turn on. After you have disabled the action key feature, you can still perform each function by pressing the **fn** key in combination with the appropriate action key.

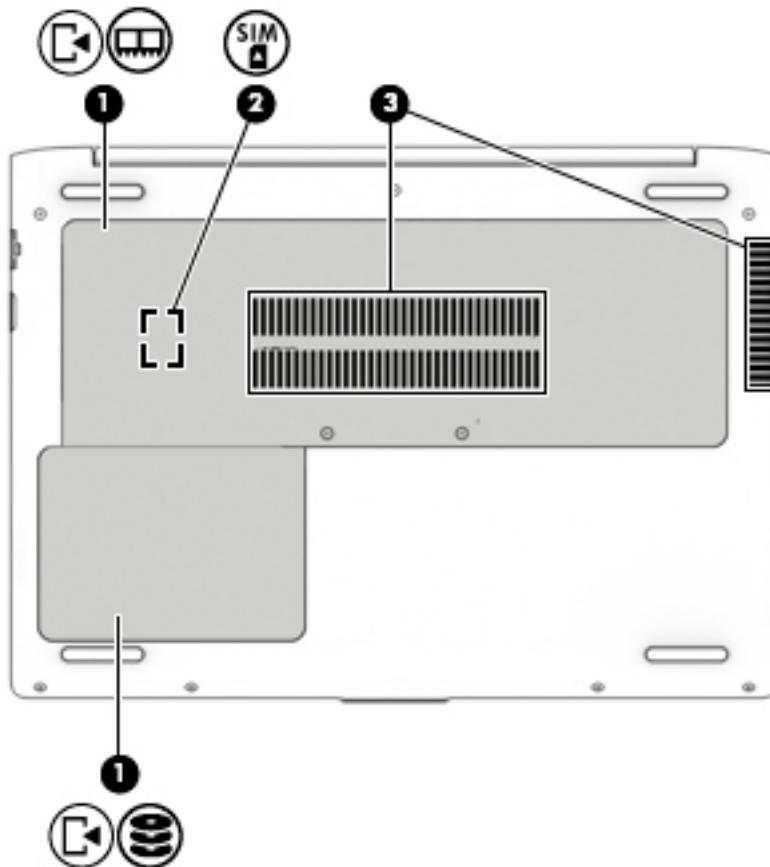

## Bottom



Component	Description
(1) 	<p>Service doors (2) Provide access to the hard drive bay, the WLAN module slot, the WWAN module slot, the SIM card slot, and the memory module slots.</p> <p><b>CAUTION:</b> To prevent an unresponsive system, replace the wireless module only with a wireless module authorized for use in the computer by the governmental agency that regulates wireless devices in your country or region. If you replace the module and then receive a warning message, remove the module to restore computer functionality, and then contact support.</p> <p>▲ Type <code>support</code> in the taskbar search box, and then select the <b>HP Support Assistant</b> app.</p> <p>– or –</p> <p>Click the question mark icon in the taskbar.</p>
(2) 	<p>SIM card slot (select products only) Supports a wireless subscriber identity module (SIM) card. The SIM card slot is located under the service door.</p>
(3)	<p>Vents Enable airflow to cool internal components.</p> <p><b>NOTE:</b> The computer fan starts up automatically to cool internal components and prevent overheating. It is normal for the internal fan to cycle on and off during routine operation.</p>

# Labels

The labels affixed to the computer provide information you may need when you troubleshoot system problems or travel internationally with the computer.

**IMPORTANT:** Check the following locations for the labels described in this section: the bottom of the computer, the bottom of a tablet kickstand, inside the battery bay, under the service door, or on the back of the display.

- Service label—Provides important information to identify your computer. When contacting support, you will probably be asked for the serial number, and possibly for the product number or the model number. Locate these numbers before you contact support.

Your service label will resemble one of the examples shown below. Refer to the illustration that most closely matches the service label on your computer.



### Component

- (1) Serial number
- (2) Product number
- (3) Warranty period
- (4) Model number (select products only)

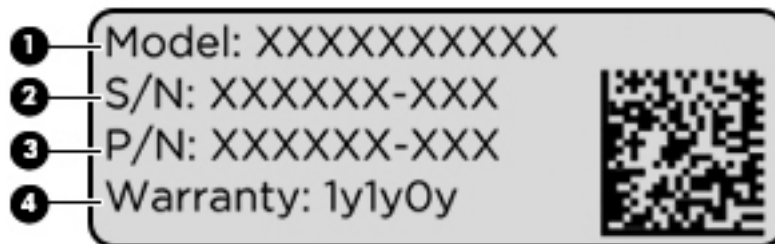

### Component

- (1) Model name (select products only)
- (2) Serial number
- (3) Product number
- (4) Warranty period

- Regulatory label(s)—Provide(s) regulatory information about the computer.
- Wireless certification label(s)—Provide(s) information about optional wireless devices and the approval markings for the countries or regions in which the devices have been approved for use.

## Inserting a SIM card (select products only)

**CAUTION:** To prevent damage to the connectors, use minimal force when inserting a SIM card.

To insert a SIM card, follow these steps:

1. Turn off the computer by using the Shut down command.
2. Close the display.
3. Disconnect all external devices connected to the computer.
4. Unplug the power cord from the AC outlet.
5. Turn the computer upside down on a flat surface.
6. Remove the service door.
7. Open the SIM locking hinged connector.
8. Gently press the SIM card **(1)** into the connector, and then rotate the hinge **(2)** down to secure the SIM card.

**NOTE:** The SIM card in your computer may look slightly different from the illustration in this section.

**NOTE:** See the image in the service bay to determine which way the SIM card should be inserted into your computer.

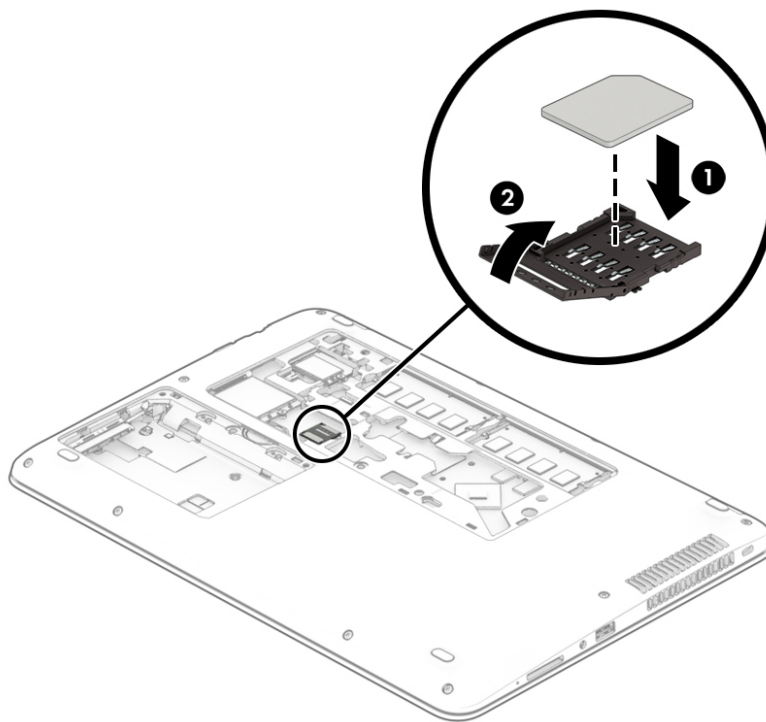

To remove a SIM card, rotate the SIM connector hinge upward, and then remove the SIM card from the connector.

# 3 Illustrated parts catalog

## Computer major components

 **NOTE:** HP continually improves and changes product parts. For complete and current information on supported parts for your computer, go to <http://partsurfer.hp.com>, select your country or region, and then follow the on-screen instructions.

 **NOTE:** Details about your computer, including model, serial number, product key, and length of warranty, are on the service tag at the bottom of your computer. See [Labels on page 16](#) for details.

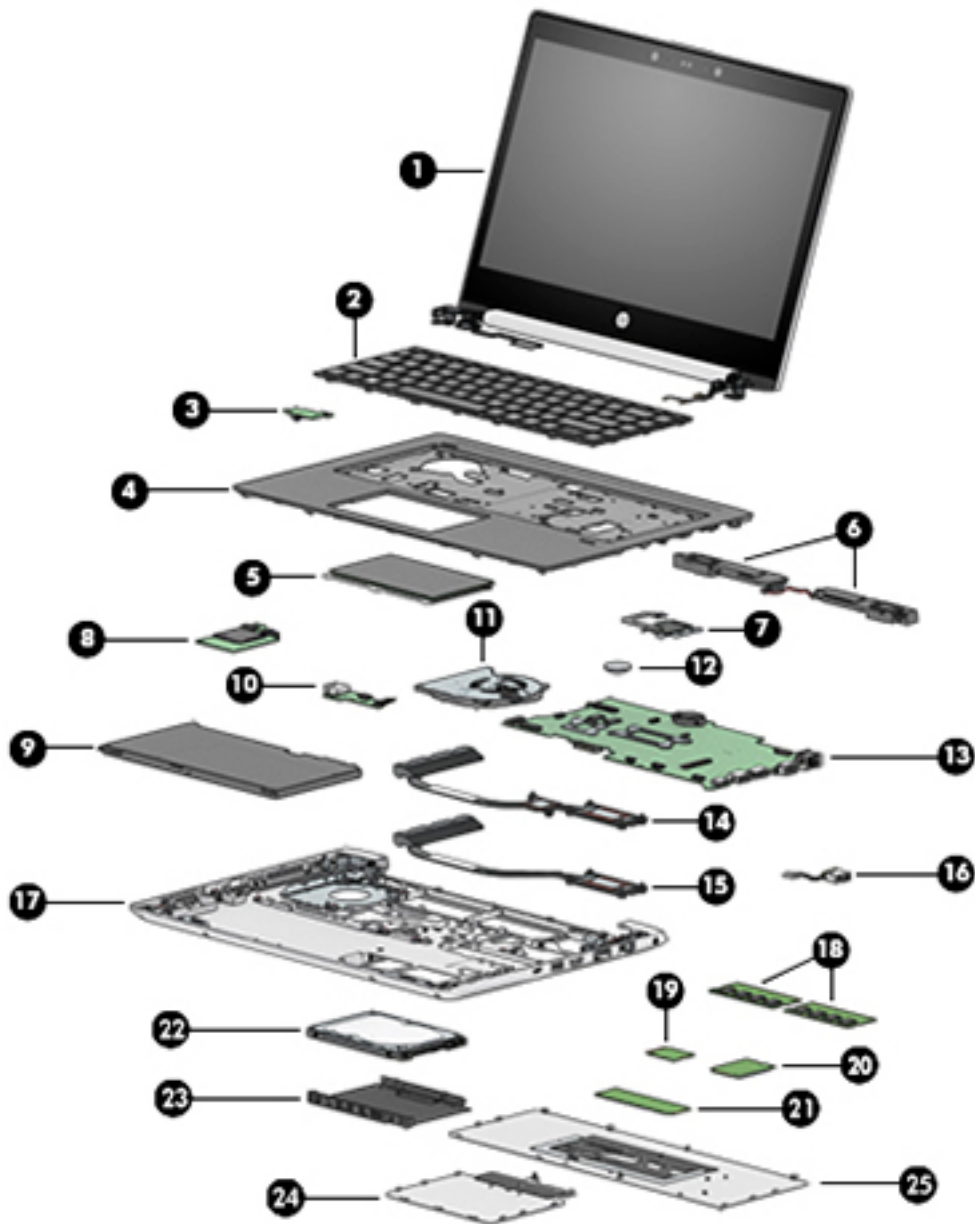

Item	Description	Spare part number
(1)	<b>Display panel assembly</b> , touch screen  <b>NOTE:</b> Touch displays are spared only as whole assemblies. <b>NOTE:</b> Non-touch displays are spared only at the subcomponent level. Non-touch assemblies are not spared as whole units.	L01102-001
(2)	<b>Keyboard</b> (includes cable)  <b>NOTE:</b> For a detailed list of keyboard country codes, see <a href="#">Keyboard on page 44</a> .	
	No backlight	L01072-xxx
	Backlit	L01071-xxx
(3)	<b>Power button board</b>	L01044-001
(4)	<b>Top cover</b>	L01089-001
(5)	<b>TouchPad</b>	L01056-001
(6)	<b>Speaker assembly</b>	L01087-001
(7)	<b>Fingerprint reader assembly</b> (includes cable)	L01091-001
(8)	<b>Card reader board</b>	L01045-001
(9)	<b>Battery, Li-ion (4-cell, 48 WHr, 4.21 Ah)</b>	851610-855
(10)	<b>USB board</b>	L01043-001
(11)	<b>Fan</b>	L01088-001
(12)	<b>RTC battery</b>	746439-001
(13)	<b>System board</b> (includes replacement thermal material)  All system boards use the following part numbers:  xxxxxx-001: Non-Windows operating system  xxxxxx-601: Windows 10 operating system  Models with UMA graphics:	
	• Intel Core i7-8550U processor	L01042-xxx
	• Intel Core i5-8350U processor	L01041-xxx
	• Intel Core i5-8250U processor (WWAN models)	L01040-xxx
	• Intel Core i5-8250U processor	L01039-xxx
	• Intel Core i5-7200U processor	L06797-xxx
	• Intel Core i3-7100U processor (WWAN models)	L01038-xxx
	• Intel Core i3-7100U processor	L01037-xxx
	• Intel Core i3-6006U processor	L01036-xxx
	• Intel Celeron 3865U processor	L01035-xxx
	Models with 2 GB of discrete graphics:	
	• Intel Core i7-8550U processor	L01081-xxx
	• Intel Core i5-8350U processor	L01080-xxx

Item	Description	Spare part number
	<ul style="list-style-type: none"> <li>Intel Core i5-8250U processor</li> </ul>	L01079-xxx
	<ul style="list-style-type: none"> <li>Intel Core i5-7200U processor</li> </ul>	L06798-xxx
	<ul style="list-style-type: none"> <li>Intel Core i3-7100U processor</li> </ul>	L01078-xxx
	<b>Heat sink assembly</b> (includes replacement thermal material)	
<b>(14)</b>	Models with discrete graphics	L01086-001
<b>(15)</b>	Models with UMA graphics	L01085-001
<b>(16)</b>	<b>Power connector cable</b>	L07857-001
<b>(17)</b>	<b>Base enclosure</b>	L01090-001
<b>(18)</b>	<b>Memory modules</b> (DDR4-2400)	
	16-GB	865396-850
	8-GB	862398-850
	4-GB	862397-850
<b>(19)</b>	<b>WLAN module</b>	
	Intel Dual Band Wireless-AC 3168 802.11ac, 1×1 Wi-Fi + Bluetooth 4.0 combination adapter	852511-001
	Intel Dual Band Wireless-AC 8265, 802.11ac, 2×2 Wi-Fi + Bluetooth 4.2 combination adapter	851594-001
	Realtek RTL8822BE 802.11AC 2×2 Wi-Fi + Bluetooth 4.2 combination adapter	915623-001
<b>(20)</b>	<b>WWAN module</b> (Huawei HP It4132, LTE/HSPA+ w/GPS M.2)	845710-001
<b>(21)</b>	<b>M.2 solid-state drive</b>	
	512-GB, Turbo Drive	L01101-001
	256-GB, PCIe	L01100-001
	128-GB, SATA-3	L01099-001
<b>(22)</b>	<b>Hard drive</b>	
	1 TB, 5400 rpm, 7 mm	832077-001
	500 GB, 5400 rpm, 7 mm, hybrid (8-GB SSD)	732000-001
	500 GB, 7200 rpm, 7 mm	703267-001
<b>(23)</b>	<b>Hard drive cover</b>	L01083-001
	<b>NOTE:</b> The hard drive cover is included in the Hard Drive Hardware Kit.	
<b>(24)</b>	<b>Drive service door</b>	L01083-001
	<b>NOTE:</b> The drive service door is included in the Hard Drive Hardware Kit.	
<b>(25)</b>	<b>Main service door</b>	L01084-001
	<b>NOTE:</b> The main service door is included in the Plastics Kit.	

# Display components

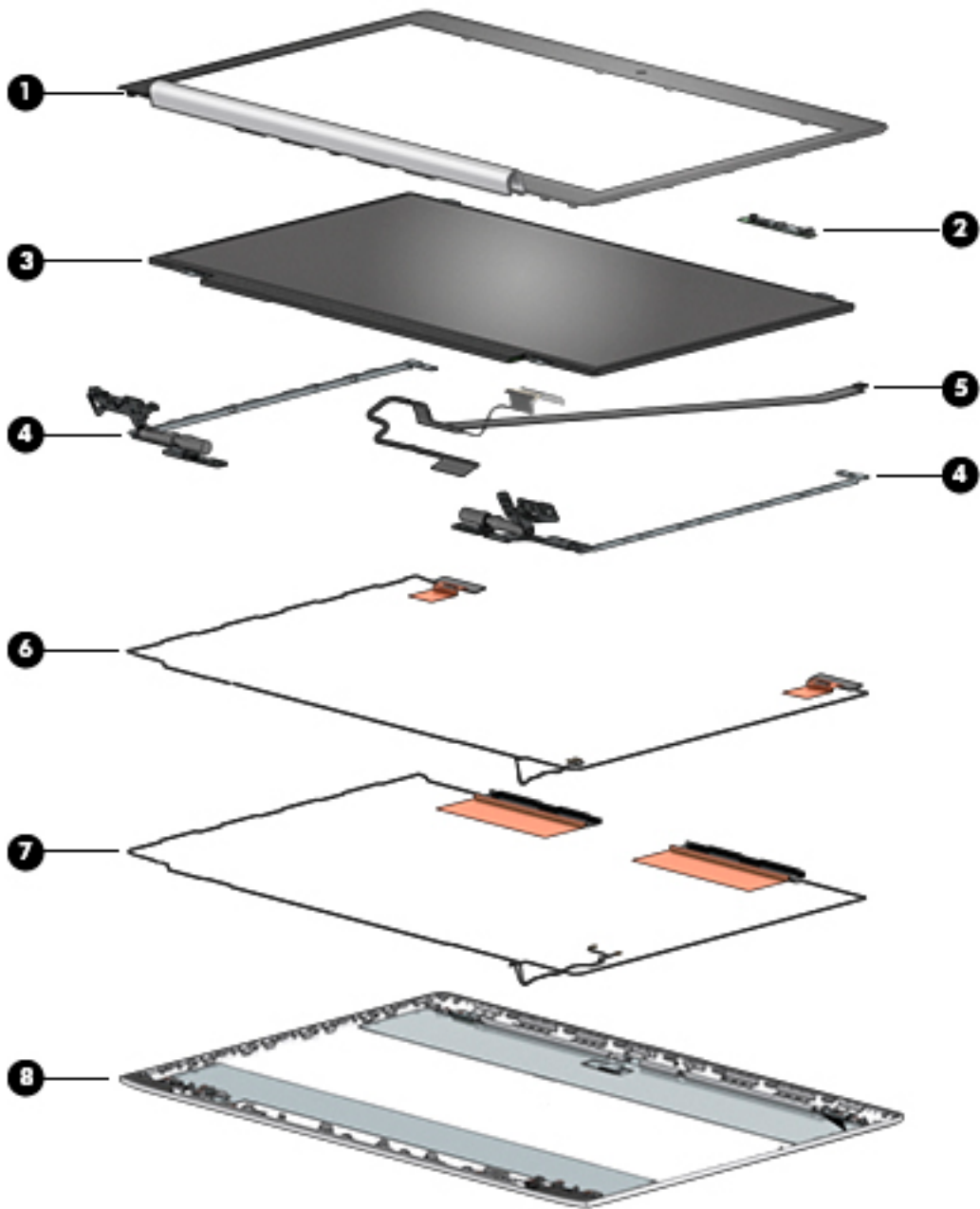

Item	Description	Spare part number
(1)	<b>Display bezel</b>	
	Models without a camera	L01094-001
	Models with a camera	L01093-001
(2)	<b>Camera module</b>	L01065-001
	<b>Microphone board</b>	L01046-001
(3)	<b>Display panel (raw)</b>	

Item	Description	Spare part number
	FHD	L01103-001
	HD, models without WWAN	L01104-001
	HD, WWAN models	L01105-001
<b>(4)</b>	<b>Hinge Kit</b> (includes left and right hinges)	L01097-001
<b>(5)</b>	<b>Display/camera cable assembly</b>	
	WLAN models	L01095-001
	WWAN models	L01096-001
<b>(6)</b>	<b>WLAN antennas</b>	
	Single	L01948-001
	Dual	L01949-001
<b>(7)</b>	<b>WWAN antennas</b>	L01950-001
<b>(8)</b>	<b>Display rear cover</b> (includes wireless antennas)	L01092-001

## Cable Kit

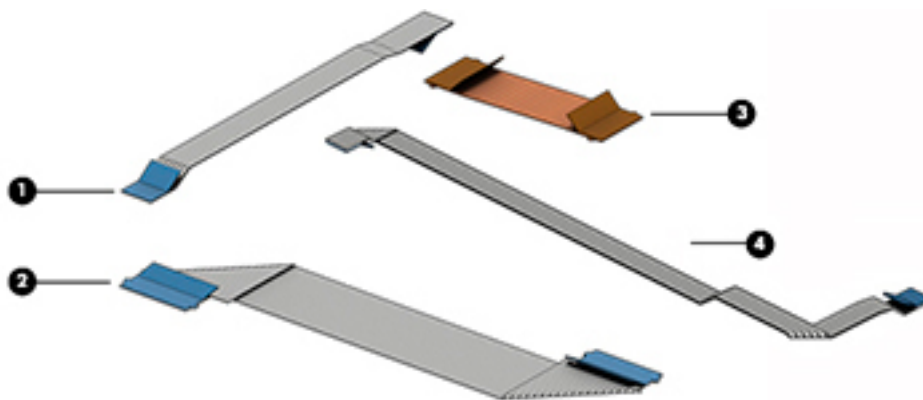

Item	Description	Spare part number
	<b>Cable Kit</b>	L01082-001
<b>(1)</b>	TouchPad cable	
<b>(2)</b>	Card reader board cable	
<b>(3)</b>	USB board cable	
<b>(4)</b>	Power button board cable	



## Plastics Kit

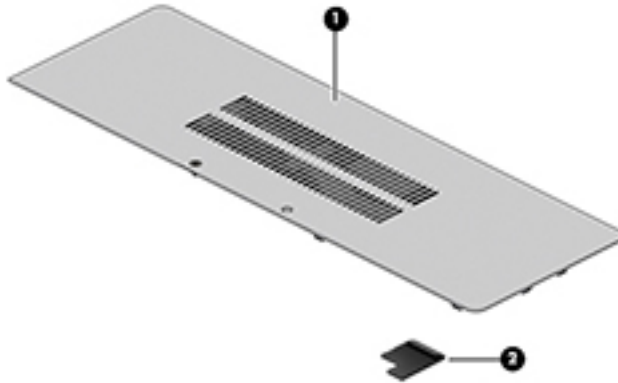

Item	Description	Spare part number
	<b>Plastics Kit</b>	L01084-001
(1)	Main service door	
(2)	Fingerprint reader insert (for use in models without a fingerprint reader)	

## Bracket Kit

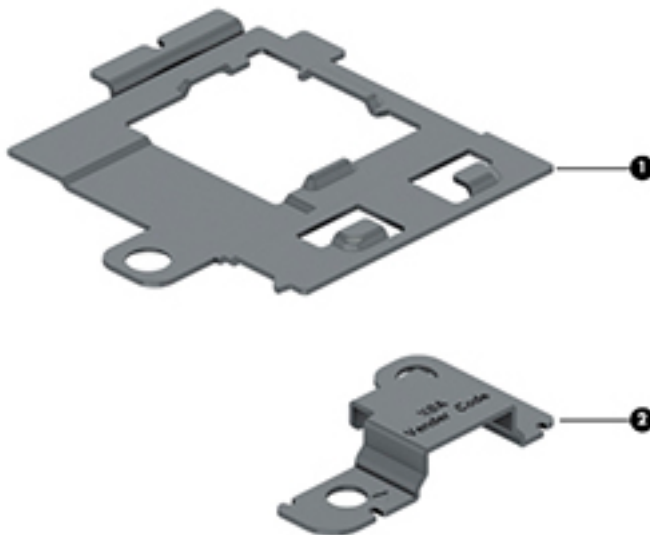

Item	Description	Spare part number
	<b>Bracket Kit</b>	L01051-001
(1)	Fingerprint reader bracket	
(2)	USB reader bracket	

## Mass storage devices

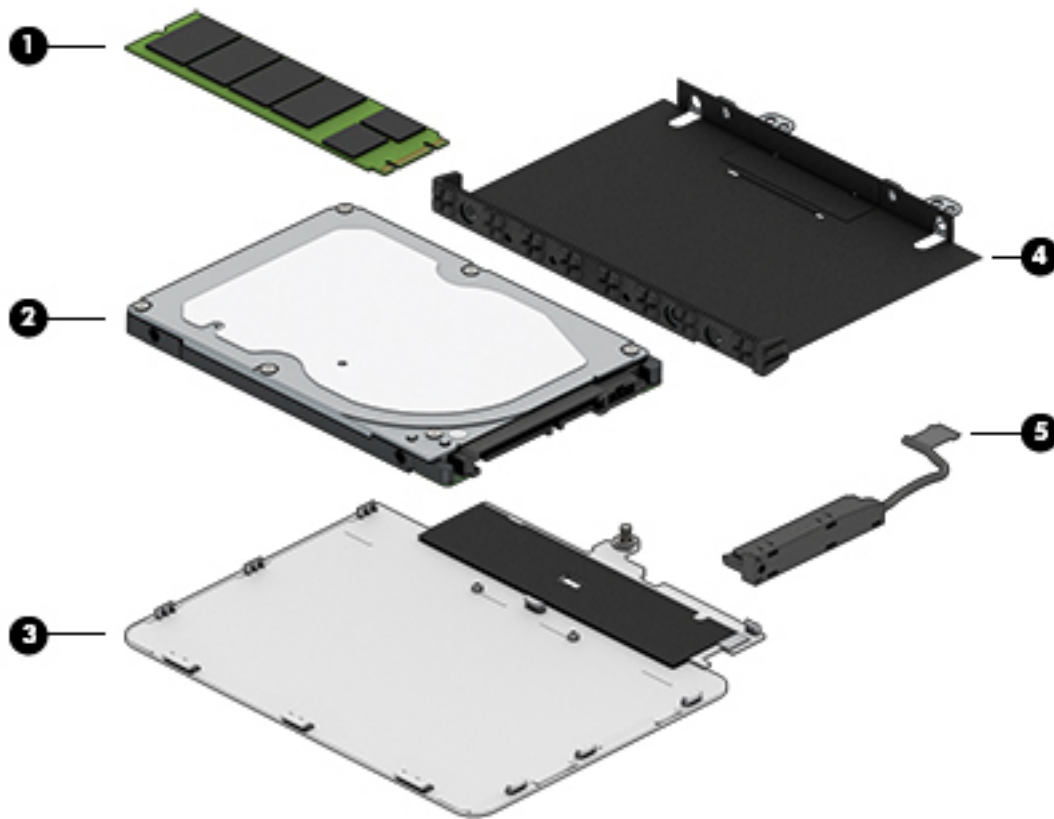

Item	Description	Spare part number
<b>(1)</b>	<b>Solid-state drive, M.2</b>	
	512-GB, Turbo Drive	L01101-001
	256-GB, PCIe	L01100-001
	128-GB, SATA-3	L01099-001
<b>(2)</b>	<b>Hard drive</b>	
	1 TB, 5400 rpm, 7 mm	832077-001
	500 GB, 5400 rpm, 7 mm, hybrid (8-GB SSD)	732000-001
	500 GB, 7200 rpm, 7 mm	703267-001
	<b>Hard Drive Hardware Kit, includes:</b>	L01083-001
<b>(3)</b>	Drive service door	
<b>(4)</b>	Hard drive cover	
<b>(5)</b>	Hard drive cable	

## Miscellaneous parts

Description	Spare part number
<b>AC adapters</b>	
65-W Smart AC power adapter, 4.5 mm barrel connector, S-3P	913691-850
65-W Smart AC power adapter, 4.5 mm barrel connector, RC	710412-001
45-W Smart AC power adapter, 4.5 mm barrel connector	741727-001
45-W Smart AC power adapter, 4.5 mm barrel connector, 2 prong	742436-001
<b>Power cord</b> (3-pin, C5, black, 1.0-m), for use in:	
Argentina	931249-001
Australia	923430-001
Brazil	923430-002
Denmark	923430-003
Europe (Austria, Belgium, Finland, France, Germany, the Netherlands, Norway and Sweden)	923430-004
India	923430-006
Israel	923430-005
Italy	923430-007
Japan	931252-001
North America	923430-008
The People's Republic of China	931251-001
South Africa	923430-009
South Korea	931250-001
Switzerland	923430-010
Taiwan	923430-012
Thailand	923430-011
United Kingdom and Singapore	923430-013
<b>Power cord</b> (3-pin, C5, black, 1.8-m), for use in:	
Argentina	931257-001
Australia	931265-001
Brazil	931258-001
Denmark	931261-001
Europe (Austria, Belgium, Finland, France, Germany, the Netherlands, Norway and Sweden)	931259-001
India	931270-001
Israel	931262-001
Italy	931256-001
Japan	931271-001

<b>Description</b>	<b>Spare part number</b>
North America	931255-001
The People's Republic of China	931268-001
South Africa	931264-001
South Korea	931267-001
Switzerland	931263-001
Taiwan	931269-001
Thailand	931266-001
United Kingdom and Singapore	931260-001
<b>Power cord</b> (3-pin, C7, black, 1.00-m), for use in:	
Japan	931325-001
<b>Screw Kit</b>	L01098-001
<b>Mouse</b>	
HP USB Laser Mouse	674318-001
HP Comfort Grip Wireless Mouse	691922-001
HP USB Travel Mouse	757770-001
<b>Cases</b>	
Top load case	679921-001
Messenger bag	679922-001
Backpack	679923-001
<b>HP keyed cable lock</b>	840158-001
<b>HP Smart AC Adapter dongle, 7.4 mm</b>	734734-001
<b>HP Elite USB-C Docking Station</b>	844550-001
<b>HP USB-C Mini Dock</b>	935327-001
<b>HP USB Travel Dock</b>	844551-001

---

# 4 Removal and replacement procedures preliminary requirements

## Tools required

You will need the following tools to complete the removal and replacement procedures:

- Flat-bladed screwdriver
- Phillips P0 and P1 screwdrivers
- Torx T8 screwdriver

## Service considerations

The following sections include some of the considerations that you must keep in mind during disassembly and assembly procedures.

---

 **NOTE:** As you remove each subassembly from the computer, place the subassembly (and all accompanying screws) away from the work area to prevent damage.

---

## Plastic parts

---

 **CAUTION:** Using excessive force during disassembly and reassembly can damage plastic parts. Use care when handling the plastic parts. Apply pressure only at the points designated in the maintenance instructions.

---

## Cables and connectors

---

**⚠ CAUTION:** When servicing the computer, be sure that cables are placed in their proper locations during the reassembly process. Improper cable placement can damage the computer.

---

Cables must be handled with extreme care to avoid damage. Apply only the tension required to unseat or seat the cables during removal and insertion. Handle cables by the connector whenever possible. In all cases, avoid bending, twisting, or tearing cables. Be sure that cables are routed in such a way that they cannot be caught or snagged by parts being removed or replaced. Handle flex cables with extreme care; these cables tear easily.

## Drive handling

---

**⚠ CAUTION:** Drives are fragile components that must be handled with care. To prevent damage to the computer, damage to a drive, or loss of information, observe these precautions:

Before removing or inserting a hard drive, shut down the computer. If you are unsure whether the computer is off or in Hibernation, turn the computer on, and then shut it down through the operating system.

Before handling a drive, be sure that you are discharged of static electricity. While handling a drive, avoid touching the connector.

Before removing a diskette drive or optical drive, be sure that a diskette or disc is not in the drive and be sure that the optical drive tray is closed.

Handle drives on surfaces covered with at least one inch of shock-proof foam.

Avoid dropping drives from any height onto any surface.

After removing a hard drive, an optical drive, or a diskette drive, place it in a static-proof bag.

Avoid exposing a hard drive to products that have magnetic fields, such as monitors or speakers.

Avoid exposing a drive to temperature extremes or liquids.

If a drive must be mailed, place the drive in a bubble pack mailer or other suitable form of protective packaging and label the package "FRAGILE."

---

# Grounding guidelines

## Electrostatic discharge damage

Electronic components are sensitive to electrostatic discharge (ESD). Circuitry design and structure determine the degree of sensitivity. Networks built into many integrated circuits provide some protection, but in many cases, ESD contains enough power to alter device parameters or melt silicon junctions.

A discharge of static electricity from a finger or other conductor can destroy static-sensitive devices or microcircuitry. Even if the spark is neither felt nor heard, damage may have occurred.

An electronic device exposed to ESD may not be affected at all and can work perfectly throughout a normal cycle. Or the device may function normally for a while, and then degrade in the internal layers, reducing its life expectancy.

**CAUTION:** To prevent damage to the computer when you are removing or installing internal components, observe these precautions:

Keep components in their electrostatic-safe containers until you are ready to install them.

Use nonmagnetic tools.

Before touching an electronic component, discharge static electricity by using the guidelines described in this section.

Avoid touching pins, leads, and circuitry. Handle electronic components as little as possible.

If you remove a component, place it in an electrostatic-safe container.

The following table shows how humidity affects the electrostatic voltage levels generated by different activities.

**CAUTION:** A product can be degraded by as little as 700 V.

Typical electrostatic voltage levels			
Event	Relative humidity		
	10%	40%	55%
Walking across carpet	35,000 V	15,000 V	7,500 V
Walking across vinyl floor	12,000 V	5,000 V	3,000 V
Motions of bench worker	6,000 V	800 V	400 V
Removing DIPS from plastic tube	2,000 V	700 V	400 V
Removing DIPS from vinyl tray	11,500 V	4,000 V	2,000 V
Removing DIPS from Styrofoam	14,500 V	5,000 V	3,500 V
Removing bubble pack from PCB	26,500 V	20,000 V	7,000 V
Packing PCBs in foam-lined box	21,000 V	11,000 V	5,000 V

## Packaging and transporting guidelines

Follow these grounding guidelines when packaging and transporting equipment:

- To avoid hand contact, transport products in static-safe tubes, bags, or boxes.
- Protect ESD-sensitive parts and assemblies with conductive or approved containers or packaging.
- Keep ESD-sensitive parts in their containers until the parts arrive at static-free workstations.
- Place items on a grounded surface before removing items from their containers.
- Always be properly grounded when touching a component or assembly.
- Store reusable ESD-sensitive parts from assemblies in protective packaging or nonconductive foam.
- Use transporters and conveyors made of antistatic belts and roller bushings. Be sure that mechanized equipment used for moving materials is wired to ground and that proper materials are selected to avoid static charging. When grounding is not possible, use an ionizer to dissipate electric charges.

## Workstation guidelines

Follow these grounding workstation guidelines:

- Cover the workstation with approved static-shielding material.
- Use a wrist strap connected to a properly grounded work surface and use properly grounded tools and equipment.
- Use conductive field service tools, such as cutters, screwdrivers, and vacuums.
- When fixtures must directly contact dissipative surfaces, use fixtures made only of static-safe materials.
- Keep the work area free of nonconductive materials, such as ordinary plastic assembly aids and Styrofoam.
- Handle ESD-sensitive components, parts, and assemblies by the case or PCM laminate. Handle these items only at static-free workstations.
- Avoid contact with pins, leads, or circuitry.
- Turn off power and input signals before inserting or removing connectors or test equipment.



## Equipment guidelines

Grounding equipment must include either a wrist strap or a foot strap at a grounded workstation.

- When seated, wear a wrist strap connected to a grounded system. Wrist straps are flexible straps with a minimum of one megohm  $\pm 10\%$  resistance in the ground cords. To provide proper ground, wear a strap snugly against the skin at all times. On grounded mats with banana-plug connectors, use alligator clips to connect a wrist strap.
- When standing, use foot straps and a grounded floor mat. Foot straps (heel, toe, or boot straps) can be used at standing workstations and are compatible with most types of shoes or boots. On conductive floors or dissipative floor mats, use foot straps on both feet with a minimum of one megohm resistance between the operator and ground. To be effective, the conductive strips must be worn in contact with the skin.

The following grounding equipment is recommended to prevent electrostatic damage:

- Antistatic tapes
- Antistatic smocks, aprons, and sleeve protectors
- Conductive bins and other assembly or soldering aids
- Nonconductive foam
- Conductive tabletop workstations with ground cords of one megohm resistance
- Static-dissipative tables or floor mats with hard ties to the ground
- Field service kits
- Static awareness labels
- Material-handling packages
- Nonconductive plastic bags, tubes, or boxes
- Metal tote boxes
- Electrostatic voltage levels and protective materials

The following table lists the shielding protection provided by antistatic bags and floor mats.

Material	Use	Voltage protection level
Antistatic plastic	Bags	1,500 V
Carbon-loaded plastic	Floor mats	7,500 V
Metallized laminate	Floor mats	5,000 V

---

## 5 Removal and replacement procedures for Customer Self-Repair parts

 **CAUTION:** The Customer Self-Repair program is not available in all locations. Installing a part not supported by the Customer Self-Repair program may void your warranty. Check your warranty to determine if Customer Self-Repair is supported in your location.

 **NOTE:** HP continually improves and changes product parts. For complete and current information on supported parts for your computer, go to <http://partsurfer.hp.com>, select your country or region, and then follow the on-screen instructions.

---

### Component replacement procedures

 **NOTE:** Please read and follow the procedures described here to access and replace Customer Self-Repair parts successfully.

 **NOTE:** Details about your computer, including model, serial number, product key, and length of warranty, are on the service tag at the bottom of your computer. See [Labels on page 16](#) for details.

---

This chapter provides removal and replacement procedures for Customer Self-Repair parts.

There are as many as 13 screws that must be removed, replaced, or loosened when servicing Customer Self-Repair parts. Make special note of each screw size and location during removal and replacement.

### Battery Safe mode

Before removing internal components, you must place the computer in “Battery Safe mode.” This mode avoids short-circuits or system malfunction by removing power from internal components.

To place the computer in “Battery Safe mode,” follow these steps:

1. With the computer turned off and AC adapter connected, press the following key and button combination: **Windows key + Backspace key + Power button.**
2. Turn the computer on to initiate “Battery Safe mode.”
3. After the computer powers off, disconnect the AC adapter.

In “Battery Safe mode,” the power button will not turn the computer on if the AC adapter is not connected.

To disengage “Battery Safe mode,” plug in the AC adapter and press the power button.

## Service doors

Description	Spare part number
Main service door (included in Plastics Kit)	L01084-001
Drive service door (included in Hard Drive Hardware Kit)	L01083-001

The bottom of the computer has two service doors. The drive service door provides access to the hard drive and M.2 solid-state drive. The main service door provides access to the memory modules, wireless modules, and keyboard screws.

Before removing the service doors, follow these steps:

1. Shut down the computer. If you are unsure whether the computer is off or in Hibernation, turn the computer on, and then shut it down through the operating system.
2. Place the computer in “Battery Safe mode” ([Battery Safe mode on page 32](#)).
3. Disconnect all external devices connected to the computer.
4. Disconnect the power from the computer by first unplugging the power cord from the AC outlet, and then unplugging the AC adapter from the computer.

Remove the service doors:

### Main service door

1. Loosen the captive Phillips screw **(1)**.
2. Lift the bottom of the door upward **(2)**, and then remove the door from the computer **(3)**.

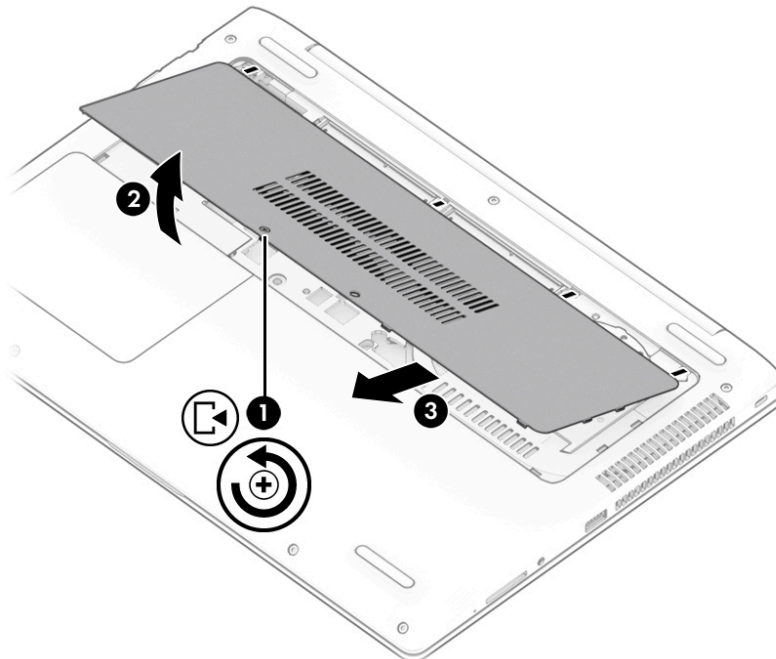

### Drive service door

3. Loosen the captive Phillips screw **(1)**.

4. Lift the bottom of the door upward **(2)**, and then remove the door from the computer **(3)**.

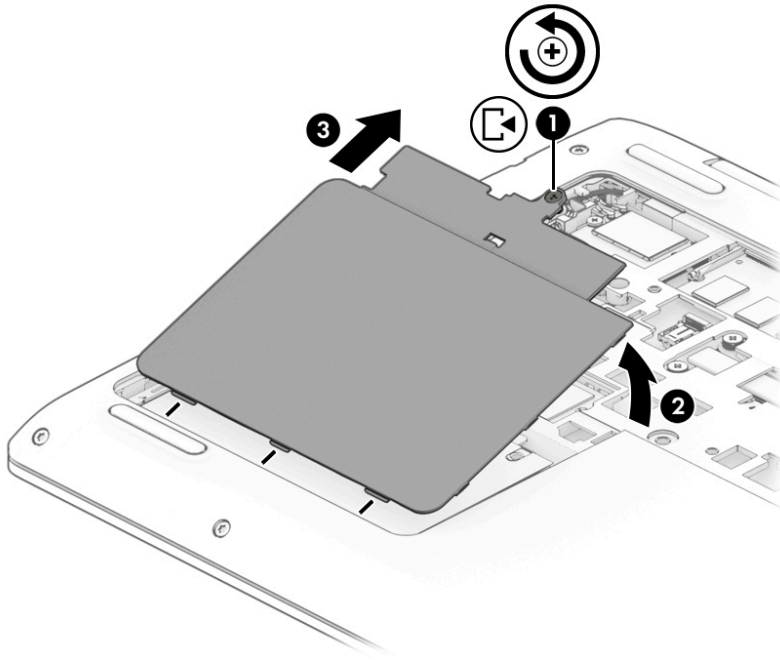

Reverse these procedures to install the service doors.

## Memory modules

Description	Spare part number
16-GB (DDR4-2400)	865396-850
8-GB (DDR4-2400)	862398-850
4-GB (DDR4-2400)	862397-850

### Update BIOS before adding memory modules

Before adding new memory, make sure you update the computer to the latest BIOS.

 **CAUTION:** Failure to update the computer to the latest BIOS prior to installing new memory may result in various system problems.

To update BIOS:

1. Navigate to [www.hp.com](http://www.hp.com).
2. Move the cursor over **Support** to display the pull-down menu, and then click **Software & drivers**.
3. Type your product name, number, or serial number, and then click **Find**.
4. Click **BIOS**, and then click **Download**.
5. Follow the on-screen instructions.

Before removing the memory module, follow these steps:

1. Shut down the computer. If you are unsure whether the computer is off or in Hibernation, turn the computer on, and then shut it down through the operating system.
2. Place the computer in “Battery Safe mode” ([Battery Safe mode on page 32](#)).
3. Disconnect all external devices connected to the computer.
4. Disconnect the power from the computer by first unplugging the power cord from the AC outlet, and then unplugging the AC adapter from the computer.
5. Remove the main service door ([Service doors on page 33](#)).

Remove the memory module:

1. Spread the retaining tabs **(1)** on each side of the memory module slot to release the memory module. (The edge of the module opposite the slot rises away from the computer.)

2. Remove the memory module (2) by pulling the module away from the slot at an angle.

---

 **NOTE:** Memory modules are designed with a notch to prevent incorrect insertion into the memory module slot.

---

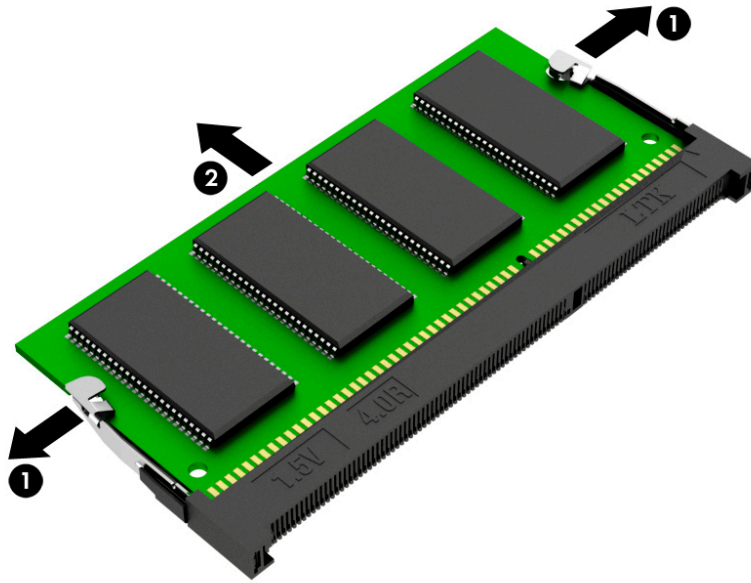

Reverse this procedure to install a memory module.

## WLAN/Bluetooth combo card

The computer uses a card that provides both WLAN and Bluetooth functionality.

Description	Spare part number
Intel Dual Band Wireless-AC 3168 802.11ac, 1×1 Wi-Fi + Bluetooth 4.0 combination adapter	852511-001
Intel Dual Band Wireless-AC 8265, 802.11ac, 2×2 Wi-Fi + Bluetooth 4.2 combination adapter	851594-001
Realtek RTL8822BE 802.11AC 2x2 Wi-Fi + Bluetooth 4.2 combination adapter	915623-001

Before removing the WLAN module, follow these steps:

1. Shut down the computer. If you are unsure whether the computer is off or in Hibernation, turn the computer on, and then shut it down through the operating system.
2. Place the computer in “Battery Safe mode” ([Battery Safe mode on page 32](#)).
3. Disconnect all external devices connected to the computer.
4. Disconnect the power from the computer by first unplugging the power cord from the AC outlet, and then unplugging the AC adapter from the computer.
5. Remove the main service door ([Service doors on page 33](#)).

Remove the WLAN module:

1. Disconnect the WLAN antenna cables **(1)** from the terminals on the WLAN module.





**NOTE:** The WLAN antenna cable labeled “1” connects to the WLAN module “Main” terminal labeled “1”. The WLAN antenna cable labeled “2” connects to the WLAN module “Aux” terminal labeled “2”. If the computer is equipped with an 802.11a/b/g/n WLAN module, the yellow WLAN antenna cable connects to the middle terminal on the WLAN module.

2. Remove the Phillips M2.0×4.0 screw **(2)** that secures the WLAN module to the computer. (The edge of the module opposite the slot rises away from the computer.)

3. Remove the WLAN module (3) by pulling the module away from the slot at an angle.

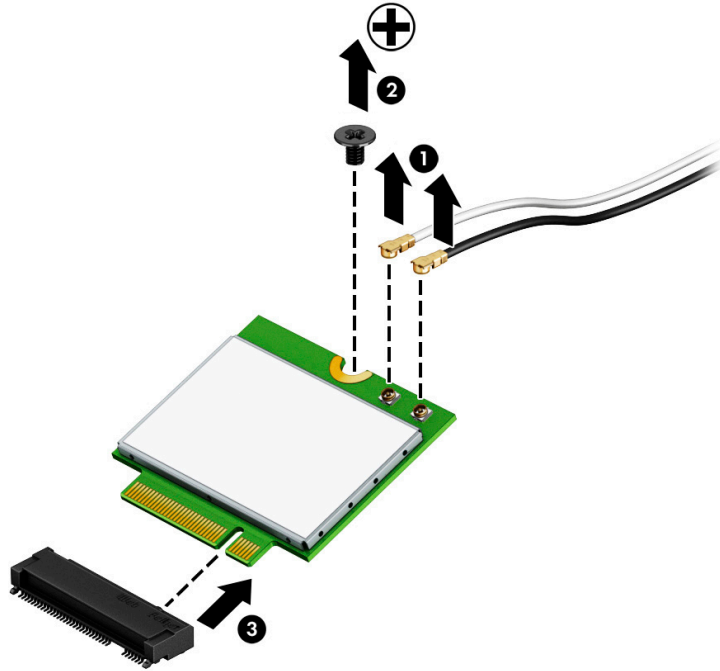
 **NOTE:** WLAN modules are designed with a notch to prevent incorrect insertion.



 **NOTE:** If the WLAN antennas are not connected to the terminals on the WLAN module, the protective sleeves must be installed on the antenna connectors, as shown in the following illustration.

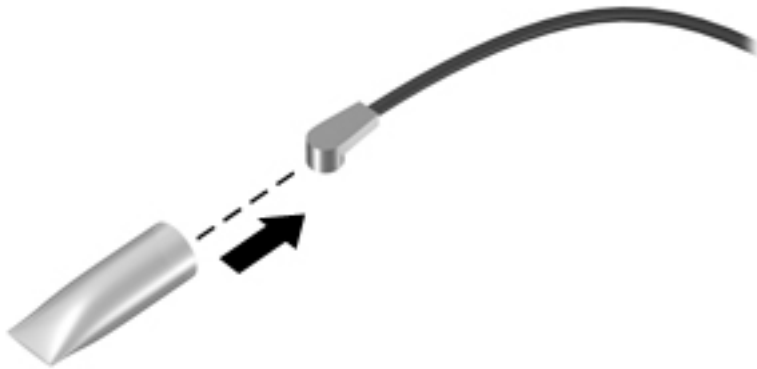

Reverse this procedure to install the WLAN module.



## WWAN module



**NOTE:** The WWAN module and the WLAN module are not interchangeable.

Description	Spare part number
Huawei HP It4132, LTE/HSPA+ w/GPS M.2	845710-001

Before removing the WWAN module, follow these steps:

1. Shut down the computer. If you are unsure whether the computer is off or in Hibernation, turn the computer on, and then shut it down through the operating system.
2. Place the computer in “Battery Safe mode” ([Battery Safe mode on page 32](#)).
3. Disconnect all external devices connected to the computer.
4. Disconnect the power from the computer by first unplugging the power cord from the AC outlet, and then unplugging the AC adapter from the computer.
5. Remove the main service door ([Service doors on page 33](#)).

Remove the WWAN module:

1. Disconnect the WWAN antenna cables **(1)** from the terminals on the WWAN module.





**NOTE:** The red WWAN antenna cable is connected to the WWAN module “Main” terminal. The blue WWAN antenna cable is connected to the WWAN module “Aux” terminal.

2. Remove the Phillips M2.0×4.0 screw **(2)** that secures the WWAN module to the system board.

3. Remove the WWAN module (3) by pulling the module away from the slot.

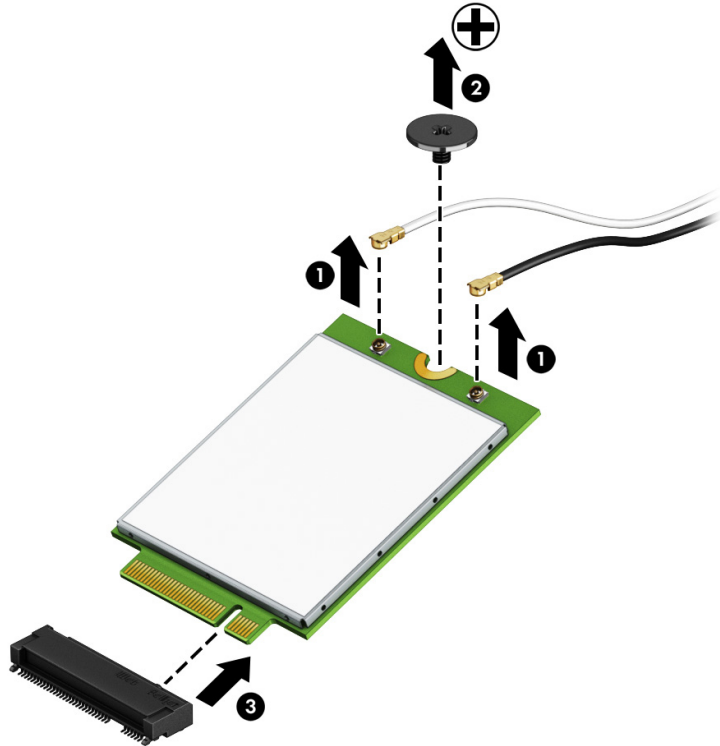
 **NOTE:** WWAN modules are designed with a notch to prevent incorrect insertion.



 **NOTE:** If the WWAN antennas are not connected to the terminals on the WWAN module, the protective sleeves must be installed on the antenna connectors, as shown in the following illustration.

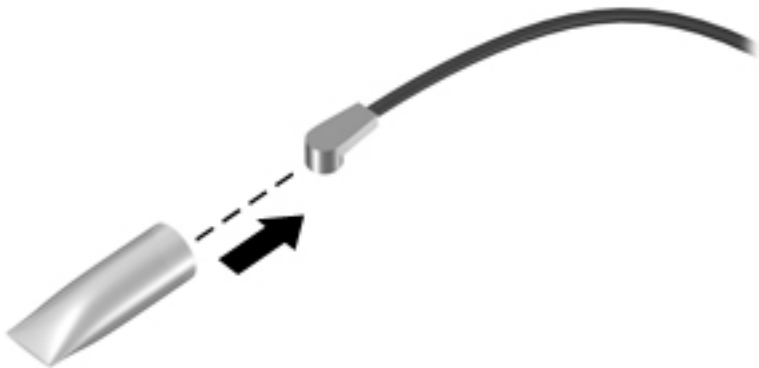

Reverse this procedure to install the WWAN module.

## Hard drive

Description	Spare part number
<b>Hard drives</b>	
1 TB, 5400 rpm, 7 mm	832077-001
500 GB, 5400 rpm, 7 mm, hybrid (8-GB SSD)	732000-001
500 GB, 7200 rpm, 7 mm	703267-001
<b>Hard drive cover</b> (Included in the Hard Drive Hardware Kit)	L01083-001

Before removing the hard drive, follow these steps:

1. Shut down the computer. If you are unsure whether the computer is off or in Hibernation, turn the computer on, and then shut it down through the operating system.
2. Place the computer in “Battery Safe mode” ([Battery Safe mode on page 32](#)).
3. Disconnect all external devices connected to the computer.
4. Disconnect the power from the computer by first unplugging the power cord from the AC outlet, and then unplugging the AC adapter from the computer.
5. Remove the main service door ([Service doors on page 33](#)).
6. Remove the drive service door ([Service doors on page 33](#)).

Remove the hard drive:

1. Remove the 2 Phillips M2.0×3.0 screws **(1)** that secure the hard drive to the computer.
2. Lift the bracket side of the hard drive upward **(2)**, and then use the tab to pull and lift the drive up enough to access the cable **(3)**.
3. Disconnect the cable from the drive **(4)**.

4. Remove the hard drive from the bay (5).

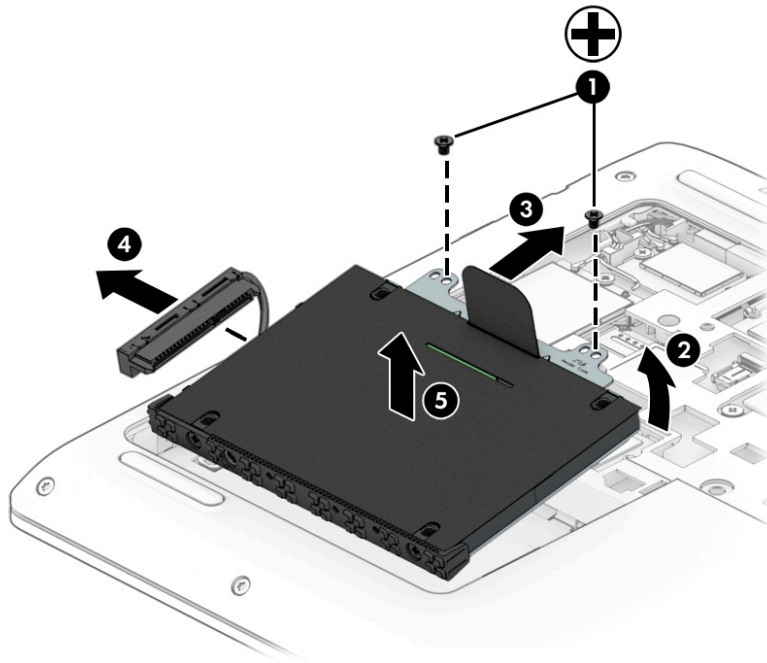

5. To remove the hard drive cover from the hard drive, remove the 4 Phillips M3.0×3.0 screws (1) that secure the bracket to the drive, and then lift the cover off the drive (2).

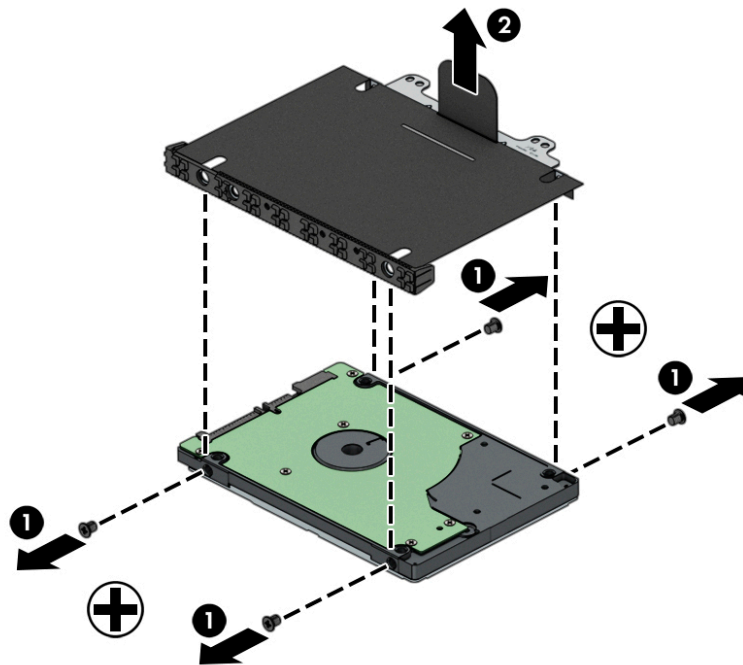

Reverse these procedures to install a hard drive.

## M.2 solid-state drive

Description	Spare part number
512-GB, Turbo Drive	L01101-001
256-GB, PCIe	L01100-001
128-GB, SATA-3	L01099-001

Before removing the solid-state drive, follow these steps:

1. Shut down the computer. If you are unsure whether the computer is off or in Hibernation, turn the computer on, and then shut it down through the operating system.
2. Place the computer in “Battery Safe mode” ([Battery Safe mode on page 32](#)).
3. Disconnect all external devices connected to the computer.
4. Disconnect the power from the computer by first unplugging the power cord from the AC outlet, and then unplugging the AC adapter from the computer.
5. Remove the main service door ([Service doors on page 33](#)).
6. Remove the drive service door ([Service doors on page 33](#)).

Remove the solid-state drive:

1. Remove the Phillips M2.0×4.0 screw **(1)** that secures the solid-state drive to the computer. (The edge of the module opposite the slot rises away from the computer.)
2. Remove the solid-state drive **(2)** by pulling the module away from the slot at an angle.

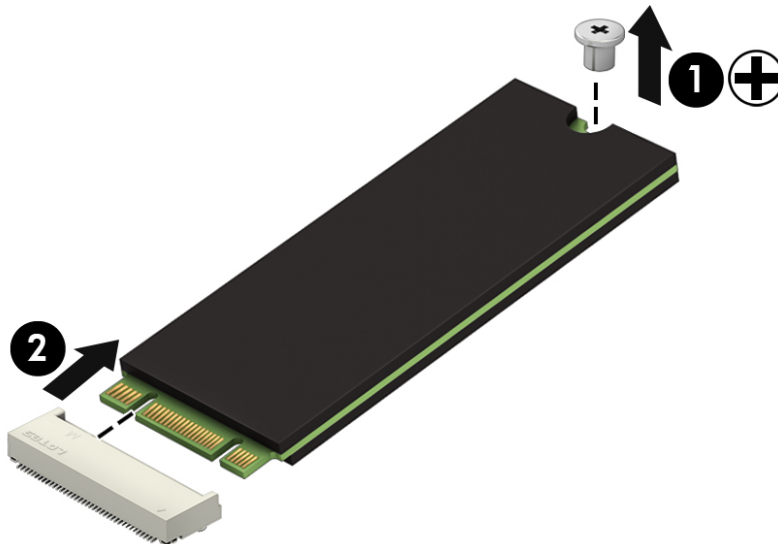

Reverse this procedure to install the solid-state drive.

## Keyboard

In this section, the first table provides the main spare part number for the keyboards. The second table provides the country codes.

Description	Spare part number
Keyboard, no backlight	L01072-xxx
Keyboard, backlit	L01071-xxx

For use in country or region	Spare part number	For use in country or region	Spare part number	For use in country or region	Spare part number
Belgium	-A41	India	-D61	Slovenia	-BA1
Brazil	-201	Israel	-BB1	South Korea	-AD1
Bulgaria	-261	Italy	-061	Spain	-071
Canada	-DB1	Japan	-291	Switzerland	-BG1
Czech Republic and Slovakia	-FL1	Latin America	-161	Taiwan	-AB1
Denmark, Finland, and Norway	-DH1	The Netherlands	-B31	Thailand	-281
France	-051	Northern Africa	-FP1	Turkey	-141
Germany	-041	Portugal	-131	Ukraine	-BD1
Greece	-151	Russia	-251	United Kingdom	-031
Hungary	-211	Saudi Arabia	-171	United States	-001
Iceland	-DD1				

Before removing the keyboard, follow these steps:

1. Shut down the computer. If you are unsure whether the computer is off or in Hibernation, turn the computer on, and then shut it down through the operating system.
2. Place the computer in “Battery Safe mode” ([Battery Safe mode on page 32](#)).
3. Disconnect all external devices connected to the computer.
4. Disconnect the power from the computer by first unplugging the power cord from the AC outlet, and then unplugging the AC adapter from the computer.
5. Remove the main service door ([Service doors on page 33](#)).

Remove the keyboard:

1. Remove the 2 Phillips M2.5×5.0 screws that secure the keyboard to the computer (1).

2. Insert a tool into the access hole next to the fan in the bottom of the computer and push to disengage the keyboard from the top cover (2).

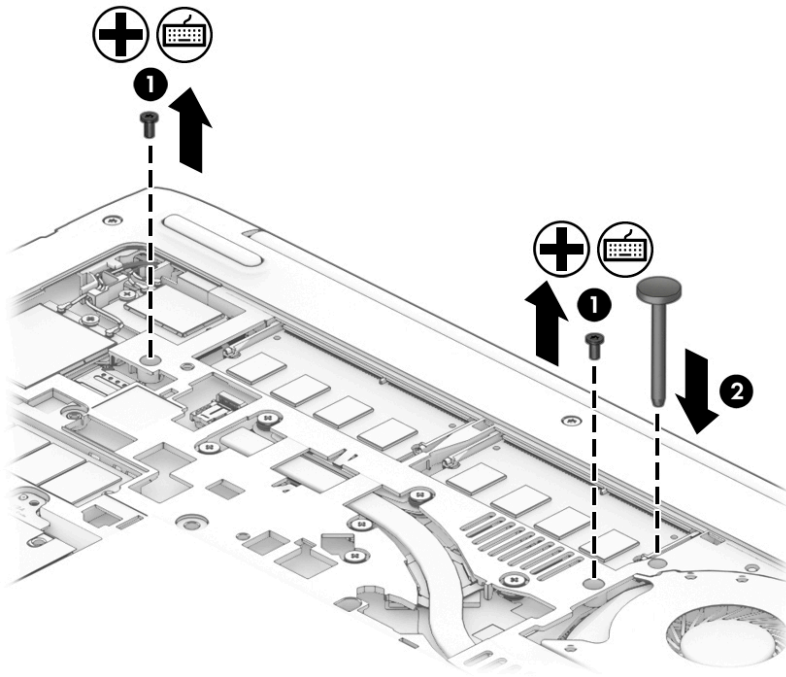

3. Lift the top of the keyboard upward, and then rotate the keyboard until it rests on the palm rest.

 **NOTE:** A cable (or cables) connect the bottom of the keyboard to the system board. Make sure not to prematurely pull the cables out of the system board connector(s).



4. If applicable, disconnect the backlight cable by lifting the ZIF connector latch (1), and then disconnect the cable from the system board (2).

5. Disconnect the keyboard cable by lifting the reverse ZIF connector latch **(3)**, and then disconnect the keyboard cable from the system board **(4)**.
6. Remove the keyboard **(5)**.

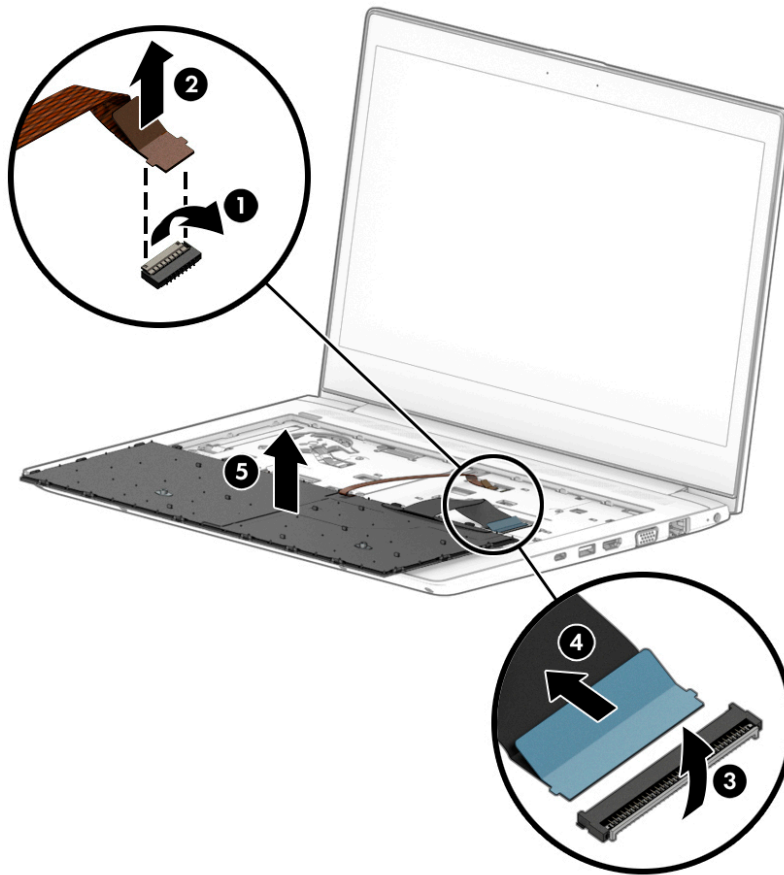

Reverse this procedure to install the keyboard.



---

## 6 Removal and replacement procedures for Authorized Service Provider parts

---

 **CAUTION:** Components described in this chapter should only be accessed by an authorized service provider. Accessing these parts can damage the computer or void the warranty.

 **NOTE:** HP continually improves and changes product parts. For complete and current information on supported parts for your computer, go to <http://partsurfer.hp.com>, select your country or region, and then follow the on-screen instructions.

---

### Component replacement procedures

---

 **NOTE:** Details about your computer, including model, serial number, product key, and length of warranty, are on the service tag at the bottom of your computer. See [Labels on page 16](#) for details.

---

This chapter provides removal and replacement procedures for Authorized Service Provider only parts.

There are as many as 49 screws that must be removed, replaced, or loosened when servicing Authorized Service Provider only parts. Make special note of each screw size and location during removal and replacement.

## Top cover

Description	Spare part number
Top cover	L01089-001

Before removing the top cover, follow these steps:

1. Shut down the computer. If you are unsure whether the computer is off or in Hibernation, turn the computer on, and then shut it down through the operating system.
2. Place the computer in “Battery Safe mode” ([Battery Safe mode on page 32](#)).
3. Disconnect all external devices connected to the computer.
4. Disconnect the power from the computer by first unplugging the power cord from the AC outlet, and then unplugging the AC adapter from the computer.
5. Remove the following components:
  - a. Service doors ([Service doors on page 33](#)).
  - b. Hard drive ([Hard drive on page 41](#))
  - c. Keyboard ([Keyboard on page 44](#))

Remove the top cover:

1. Position the computer upside-down with the front toward you.
2. Remove the 8 Torx T8 2.5×6.0 screws **(1)** from around the edges of the computer.
3. Remove the Phillips broad head M2.0×2.0 screw **(2)** from the hard drive bay.

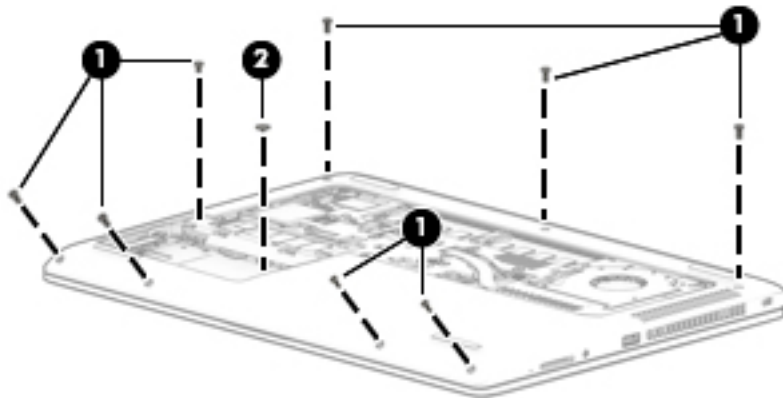

4. Position the computer upright and open it as far as possible.

5. Remove the 6 Torx T8 2.5×5.0 screws from under the keyboard.

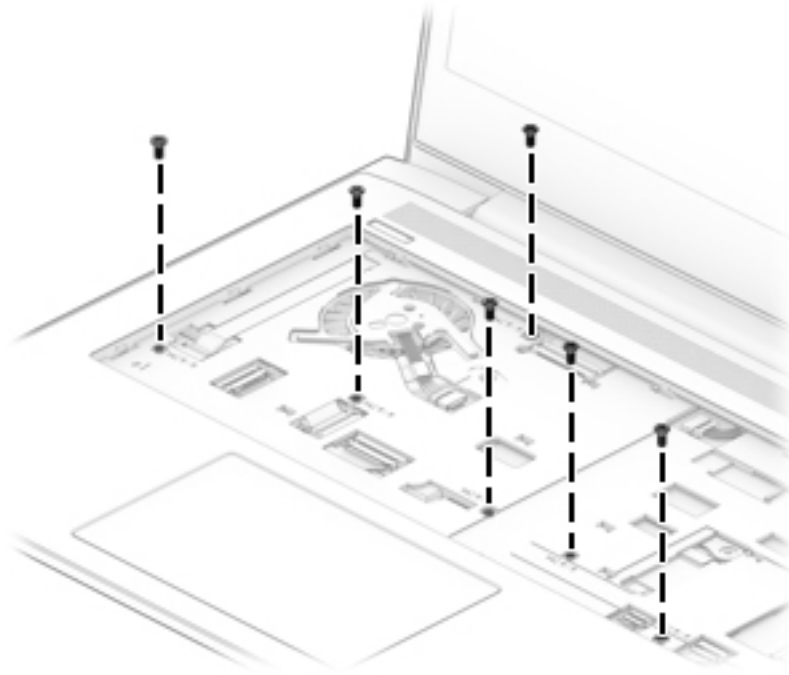

6. Disconnect the following cables from the system board:

- (1) Power button board cable
- (2) Speaker cable
- (3) TouchPad board cable
- (4) Fingerprint reader cable

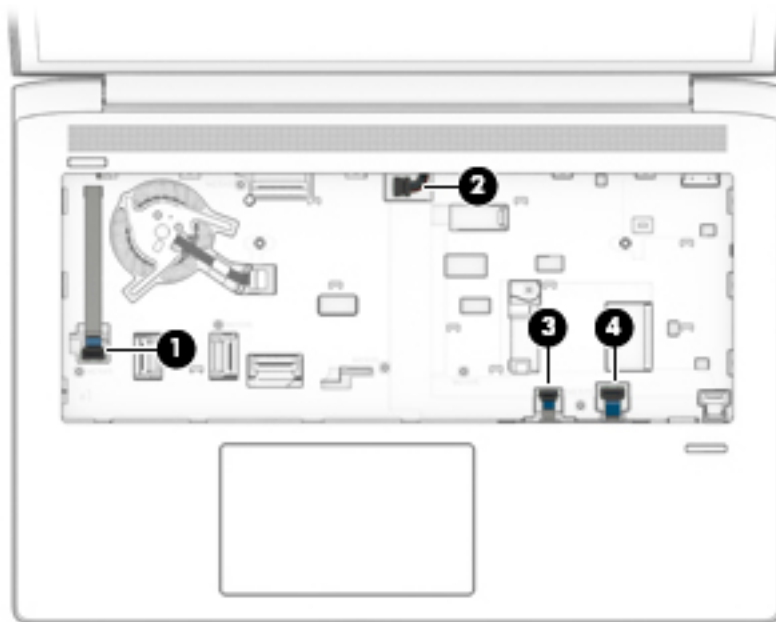

7. To remove the top cover, start prying upward on both sides of the TouchPad **(1)**, and then remove the top cover from the computer **(2)**.

---

 **NOTE:** The top cover may be secured very tightly to the computer.

 **TIP:** After disengaging the front of the top cover, the rear near the display may remain connected. If this is the case, lift up on the rear part of the top cover to remove.

---

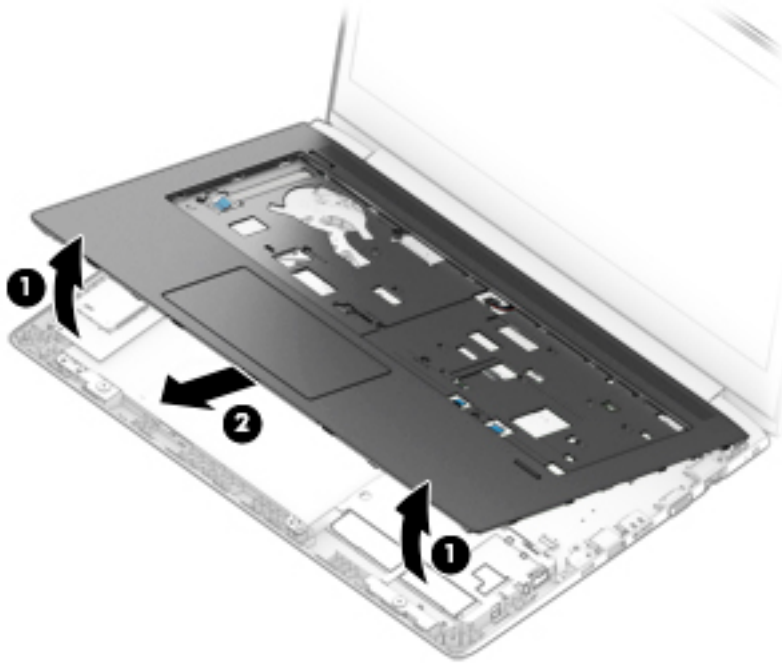

Reverse this procedure to install the top cover.

## Fingerprint reader assembly

Description	Spare part number
Fingerprint reader assembly (includes cable)	L01091-001
Fingerprint reader bracket (included in Bracket Kit)	L01051-001
Fingerprint reader insert (included in Plastics Kit; for use in models without a fingerprint reader)	L01084-001

Before removing the fingerprint reader assembly, follow these steps:

1. Shut down the computer. If you are unsure whether the computer is off or in Hibernation, turn the computer on, and then shut it down through the operating system.
2. Place the computer in “Battery Safe mode” ([Battery Safe mode on page 32](#)).
3. Disconnect all external devices connected to the computer.
4. Disconnect the power from the computer by first unplugging the power cord from the AC outlet, and then unplugging the AC adapter from the computer.
5. Remove the following components:
  - a. Service doors ([Service doors on page 33](#)).
  - b. Hard drive ([Hard drive on page 41](#))
  - c. Keyboard ([Keyboard on page 44](#))
  - d. Top cover ([Top cover on page 48](#))

Remove the fingerprint reader assembly:

1. Position the top cover upside-down.
2. If necessary, lift the tape from atop the bracket **(1)**.
3. Slide the bracket toward the side of the top cover, and then lift it off the fingerprint reader board **(2)**.

 **TIP:** A tool may be required to push and disengage the bracket.

4. Lift the fingerprint reader cable (3) and board (4) to disengage the adhesive that secures them to the top cover, and then remove the board and cable assembly from the top cover.

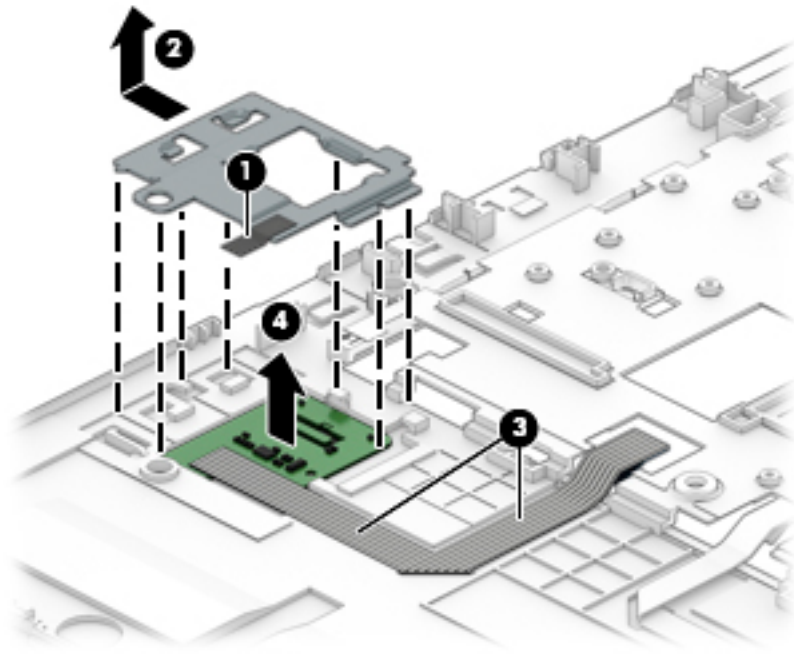

Reverse this procedure to install the fingerprint reader assembly.

## Power button board

Description	Spare part number
Power button board	L01044-001
Power button board cable (included in Cable Kit)	L01082-001

Before removing the power button board, follow these steps:

1. Shut down the computer. If you are unsure whether the computer is off or in Hibernation, turn the computer on, and then shut it down through the operating system.
2. Place the computer in “Battery Safe mode” ([Battery Safe mode on page 32](#)).
3. Disconnect all external devices connected to the computer.
4. Disconnect the power from the computer by first unplugging the power cord from the AC outlet, and then unplugging the AC adapter from the computer.
5. Remove the following components:
  - a. Service doors ([Service doors on page 33](#))
  - b. Hard drive ([Hard drive on page 41](#))
  - c. Keyboard ([Keyboard on page 44](#))
  - d. Top cover ([Top cover on page 48](#))

Remove the power button board:

1. Position the top cover upside-down.
2. Disconnect the cable from the connector on the board **(1)**.
3. Remove the Phillips M2.0×3.0 screw **(2)** that secures the board to the top cover.
4. Lift the left side of the board **(3)**, and then pull the board to the left **(4)** to remove it from under the tab **(5)**.

5. If you need to replace the cable, note the cable routing path inside of the top cover.

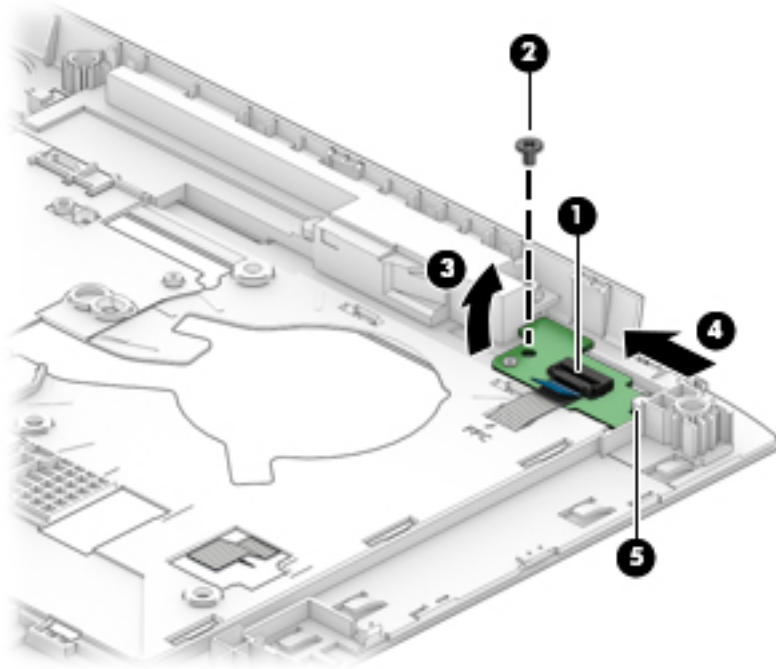

Reverse this procedure to install the power button board.



## Speaker assembly

Description	Spare part number
Speaker assembly	L01087-001

Before removing the speaker assembly, follow these steps:

1. Shut down the computer. If you are unsure whether the computer is off or in Hibernation, turn the computer on, and then shut it down through the operating system.
2. Place the computer in “Battery Safe mode” ([Battery Safe mode on page 32](#)).
3. Disconnect all external devices connected to the computer.
4. Disconnect the power from the computer by first unplugging the power cord from the AC outlet, and then unplugging the AC adapter from the computer.
5. Remove the following components:
  - a. Service doors ([Service doors on page 33](#)).
  - b. Hard drive ([Hard drive on page 41](#))
  - c. Keyboard ([Keyboard on page 44](#))
  - d. Top cover ([Top cover on page 48](#))

Remove the speaker assembly:

1. Position the top cover upside-down.
2. Remove the 2 Phillips M2.0×6.0 screws **(1)** that secure the speaker assembly to the top cover.
3. Remove the cable from the clips in the top cover **(2)**.

4. Remove the speakers from the top cover (3).

 **IMPORTANT:** When removing the speakers, make sure the rubber feet (4) and rubber screw gaskets (5) remain attached to the speakers. These parts must be installed with the speakers.

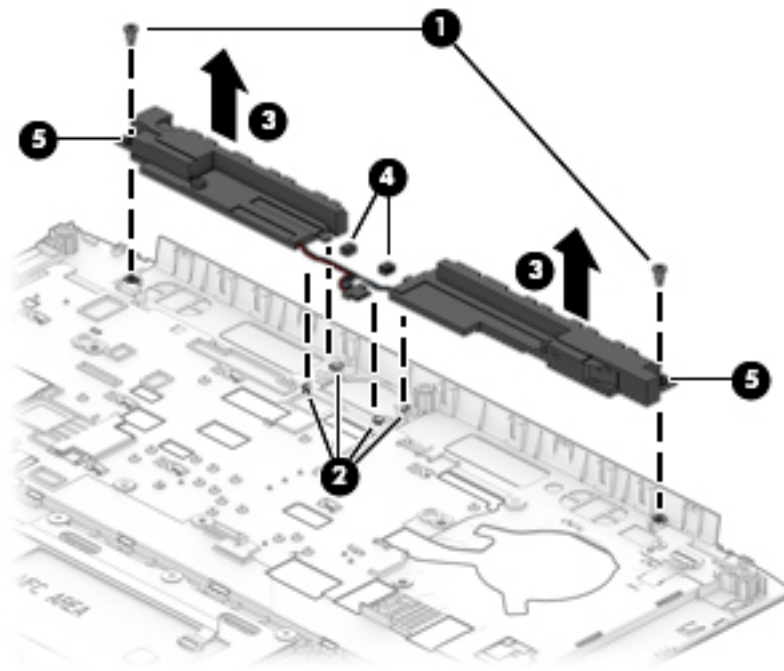

Reverse this procedure to install the speaker assembly.

## TouchPad assembly

Description	Spare part number
TouchPad assembly	L01056-001
TouchPad assembly cable (included in Cable Kit)	L01082-001

Before removing the TouchPad assembly, follow these steps:

1. Shut down the computer. If you are unsure whether the computer is off or in Hibernation, turn the computer on, and then shut it down through the operating system.
2. Place the computer in “Battery Safe mode” ([Battery Safe mode on page 32](#)).
3. Disconnect all external devices connected to the computer.
4. Disconnect the power from the computer by first unplugging the power cord from the AC outlet, and then unplugging the AC adapter from the computer.
5. Remove the following components:
  - a. Service doors ([Service doors on page 33](#)).
  - b. Hard drive ([Hard drive on page 41](#))
  - c. Keyboard ([Keyboard on page 44](#))
  - d. Top cover ([Top cover on page 48](#))

Remove the TouchPad assembly:

1. Position the top cover upside-down.
2. Disconnect the cable from the ZIF connector on the TouchPad **(1)**.
3. Lift the cable to remove it from the adhesive that secures it to the top cover **(2)**.
4. Remove the 6 broad head Phillips M2.0×2.0 screws **(3)** that secure the TouchPad to the top cover.

5. Lift the TouchPad off the top cover (4).

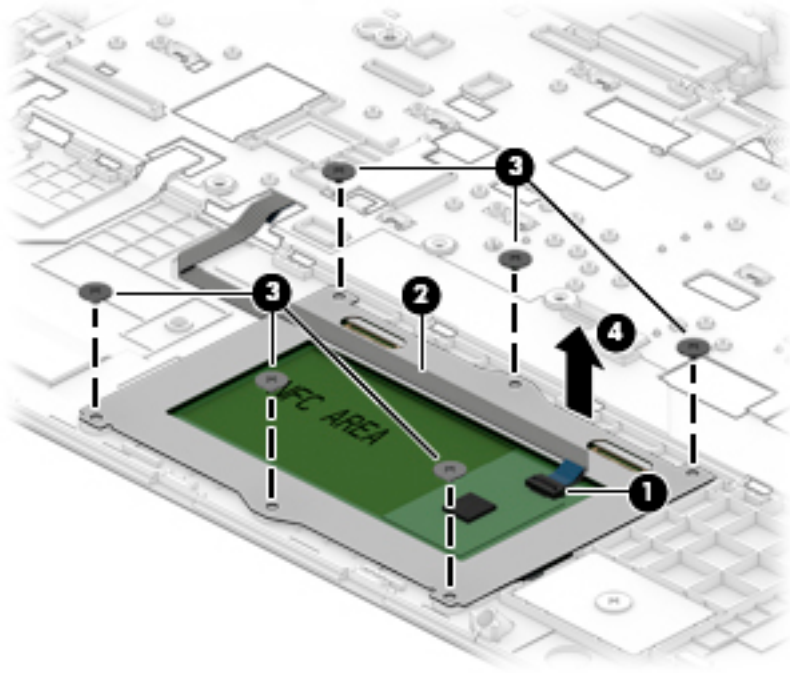

Reverse this procedure to install the TouchPad assembly.

## Card reader board

Description	Spare part number
Card reader board assembly	L01045-001
Card reader board cable (included in Cable Kit)	L01082-001

Before removing the card reader board, follow these steps:

1. Shut down the computer. If you are unsure whether the computer is off or in Hibernation, turn the computer on, and then shut it down through the operating system.
2. Place the computer in “Battery Safe mode” ([Battery Safe mode on page 32](#)).
3. Disconnect all external devices connected to the computer.
4. Disconnect the power from the computer by first unplugging the power cord from the AC outlet, and then unplugging the AC adapter from the computer.
5. Remove the following components:
  - a. Service doors ([Service doors on page 33](#))
  - b. Hard drive ([Hard drive on page 41](#))
  - c. Keyboard ([Keyboard on page 44](#))
  - d. Top cover ([Top cover on page 48](#))

Remove the card reader board:

1. Position the computer upright on a flat surface and open the display as far as possible.
2. Disconnect the cable from the system board ZIF connector **(1)**.
3. Remove the 2 Torx T8 2.5×4.0 screws **(2)** that secure the board to the computer.
4. Lift the board out of the computer **(3)**.

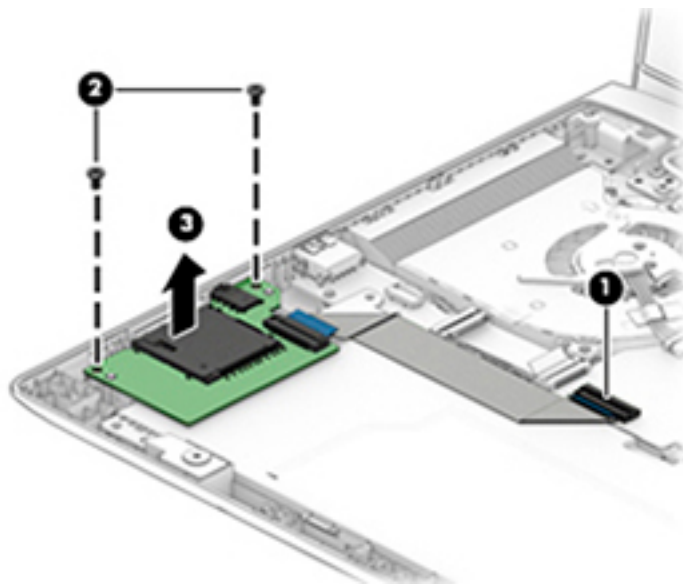

Reverse this procedure to install the card reader board.

## Fan

Description	Spare part number
Fan	L01088-001

 **NOTE:** To properly ventilate the computer, allow at least **7.6 cm** (3.0 in) of clearance on the sides of the computer. The computer uses an electric fan for ventilation. The fan is controlled by a temperature sensor and is designed to turn on automatically when high temperature conditions exist. These conditions are affected by high external temperatures, system power consumption, power management/battery conservation configurations, battery fast charging, and software requirements. Exhaust air is displaced through the ventilation grill.

Before removing the fan, follow these steps:

1. Shut down the computer. If you are unsure whether the computer is off or in Hibernation, turn the computer on, and then shut it down through the operating system.
2. Place the computer in “Battery Safe mode” ([Battery Safe mode on page 32](#)).
3. Disconnect all external devices connected to the computer.
4. Disconnect the power from the computer by first unplugging the power cord from the AC outlet and then unplugging the AC adapter from the computer.
5. Remove the battery ([Battery on page 64](#)), and then remove the following components:
  - a. Service doors ([Service doors on page 33](#)).
  - b. Hard drive ([Hard drive on page 41](#))
  - c. Keyboard ([Keyboard on page 44](#))
  - d. Top cover ([Top cover on page 48](#))

To remove the fan:

1. Position the computer upright on a flat surface and open the display as far as possible.
2. Disconnect the fan cable **(1)** from the system board.
3. Remove the display cable from atop the screw **(2)**.
4. Remove the two Torx T8 2.5×5.0 screws **(3)** that secure the fan to the computer.

5. Lift the fan out of the computer (4).

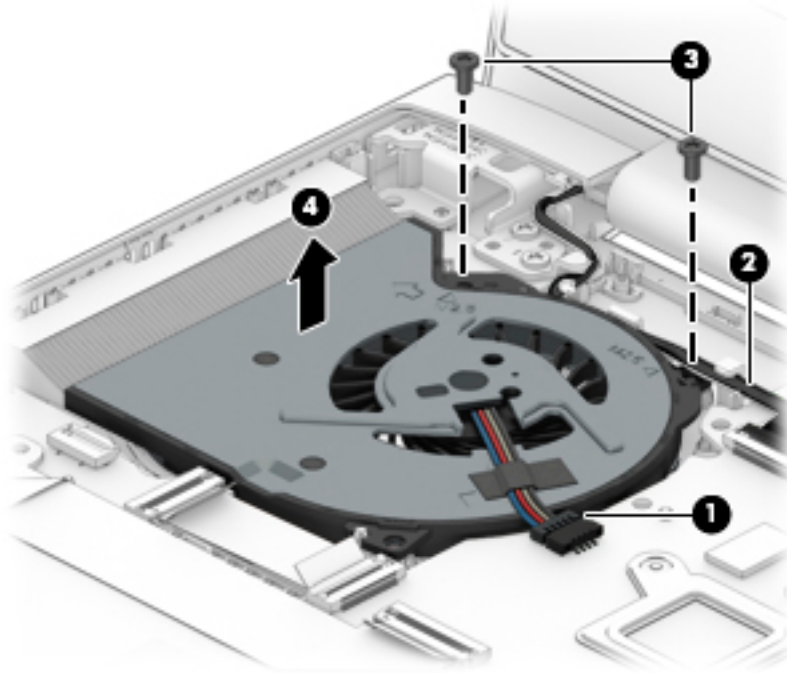

Reverse this procedure to install the fan.

## Hard drive cable

Description	Spare part number
Hard drive cable (included in Hard Drive Hardware Kit)	L01083-001

Before removing the hard drive cable, follow these steps:

1. Shut down the computer. If you are unsure whether the computer is off or in Hibernation, turn the computer on, and then shut it down through the operating system.
2. Place the computer in “Battery Safe mode” ([Battery Safe mode on page 32](#)).
3. Disconnect all external devices connected to the computer.
4. Disconnect the power from the computer by first unplugging the power cord from the AC outlet and then unplugging the AC adapter from the computer.
5. Remove the battery ([Battery on page 64](#)), and then remove the following components:
  - a. Service doors ([Service doors on page 33](#)).
  - b. Hard drive ([Hard drive on page 41](#))
  - c. Keyboard ([Keyboard on page 44](#))
  - d. Top cover ([Top cover on page 48](#))

To remove the hard drive cable:

1. Position the computer upright on a flat surface and open the display as far as possible.
2. Disconnect the cable from the ZIF connector on the system board (**1**).
3. Remove the cable from the clip (**2**), and then route the cable through the hole and out the bottom of the computer (**3**).

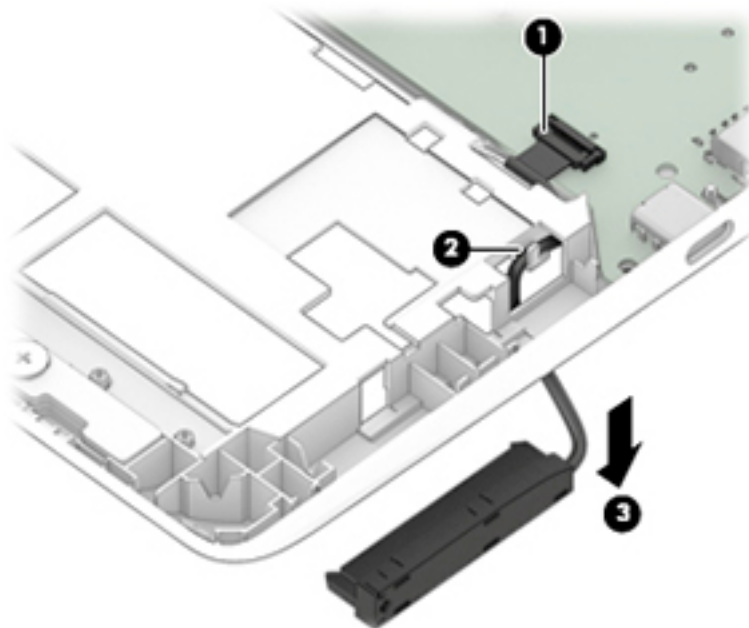

Reverse this procedure to install the hard drive cable.



## RTC battery

Description	Spare part number
RTC battery	746439-001

Before removing the RTC battery, follow these steps:

1. Shut down the computer. If you are unsure whether the computer is off or in Hibernation, turn the computer on, and then shut it down through the operating system.
2. Place the computer in “Battery Safe mode” ([Battery Safe mode on page 32](#)).
3. Disconnect all external devices connected to the computer.
4. Disconnect the power from the computer by first unplugging the power cord from the AC outlet, and then unplugging the AC adapter from the computer.
5. Remove the following components:
  - a. Service doors ([Service doors on page 33](#)).
  - b. Hard drive ([Hard drive on page 41](#))
  - c. Keyboard ([Keyboard on page 44](#))
  - d. Top cover ([Top cover on page 48](#))

Remove the RTC battery:

1. Position the computer upright on a flat surface and open the display as far as possible.
2. Use a tool to pry the battery out of the socket **(1)**.
3. Remove the battery from the system board **(2)**.

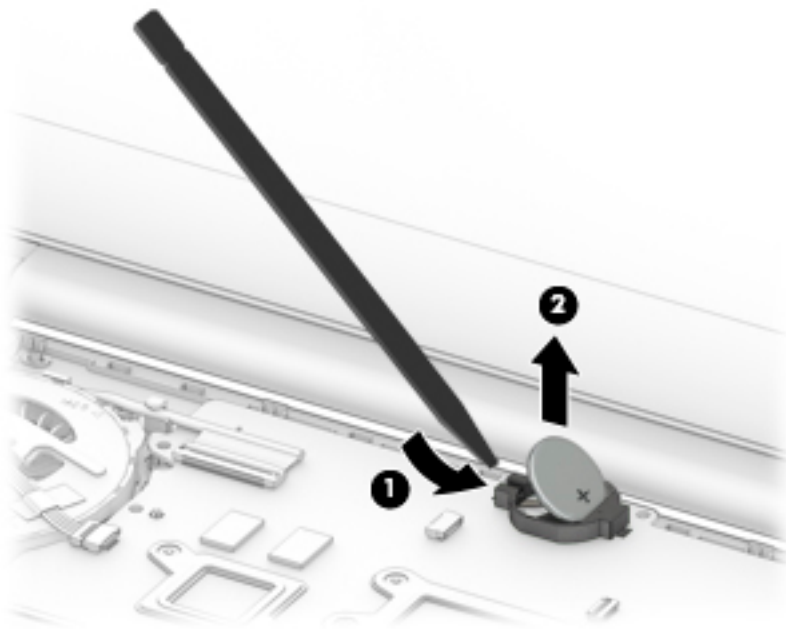

Reverse this procedure to install the RTC battery.

## Battery

Description	Spare part number
Battery, 4-cell, 48 WHr, 4.21 Ah	851610-855

Before removing the battery, follow these steps:

1. Shut down the computer. If you are unsure whether the computer is off or in Hibernation, turn the computer on, and then shut it down through the operating system.
2. Place the computer in “Battery Safe mode” ([Battery Safe mode on page 32](#)).
3. Disconnect all external devices connected to the computer.
4. Disconnect the power from the computer by first unplugging the power cord from the AC outlet, and then unplugging the AC adapter from the computer.
5. Remove the following components:
  - a. Service doors ([Service doors on page 33](#)).
  - b. Hard drive ([Hard drive on page 41](#))
  - c. Keyboard ([Keyboard on page 44](#))
  - d. Top cover ([Top cover on page 48](#))
  - e. Card reader board ([Card reader board on page 59](#))

To remove the battery:

1. Position the computer upright on a flat surface and open the display as far as possible.
2. Remove the Torx T8 2.5×5.0 screw **(1)** that secures the battery to the computer.
3. Rotate the bottom of the battery upward **(2)**, and then lift the battery out of the computer **(3)**.

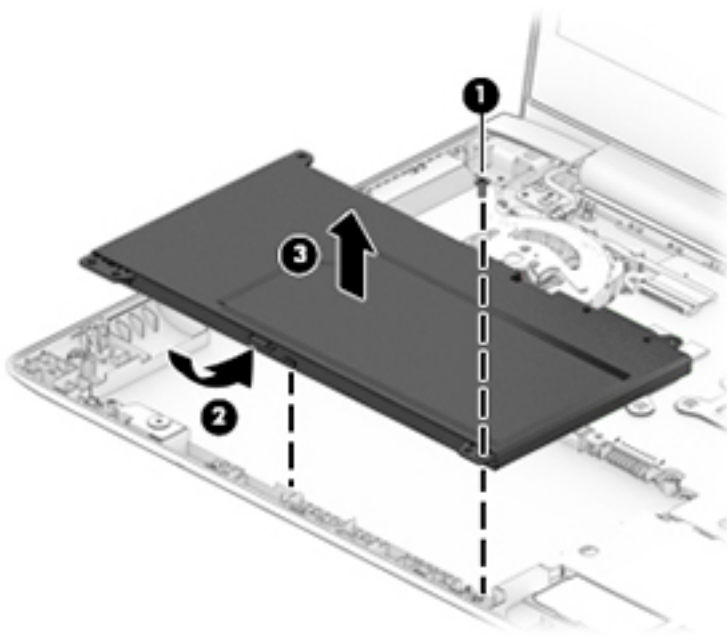

Reverse this procedure to install the battery.

## USB board

Description	Spare part number
USB board	L01043-001
USB board cable (included in Cable Kit)	L01082-001

Before removing the USB board, follow these steps:

1. Shut down the computer. If you are unsure whether the computer is off or in Hibernation, turn the computer on, and then shut it down through the operating system.
2. Place the computer in “Battery Safe mode” ([Battery Safe mode on page 32](#)).
3. Disconnect all external devices connected to the computer.
4. Disconnect the power from the computer by first unplugging the power cord from the AC outlet, and then unplugging the AC adapter from the computer.
5. Remove the following components:
  - a. Service doors ([Service doors on page 33](#)).
  - b. Hard drive ([Hard drive on page 41](#))
  - c. Keyboard ([Keyboard on page 44](#))
  - d. Top cover ([Top cover on page 48](#))
  - e. Card reader board ([Card reader board on page 59](#))
  - f. Battery ([Battery on page 64](#))

Remove the USB board:

1. Position the computer upright on a flat surface and open the display as far as possible.
2. Disconnect the cable from the ZIF connector on the USB board **(1)**.
3. Use a tool to pry the side of the board near the fan upward **(2)**, and then pull the board away from the tab that secures it **(3)**.

4. Remove the USB board from the computer (4).

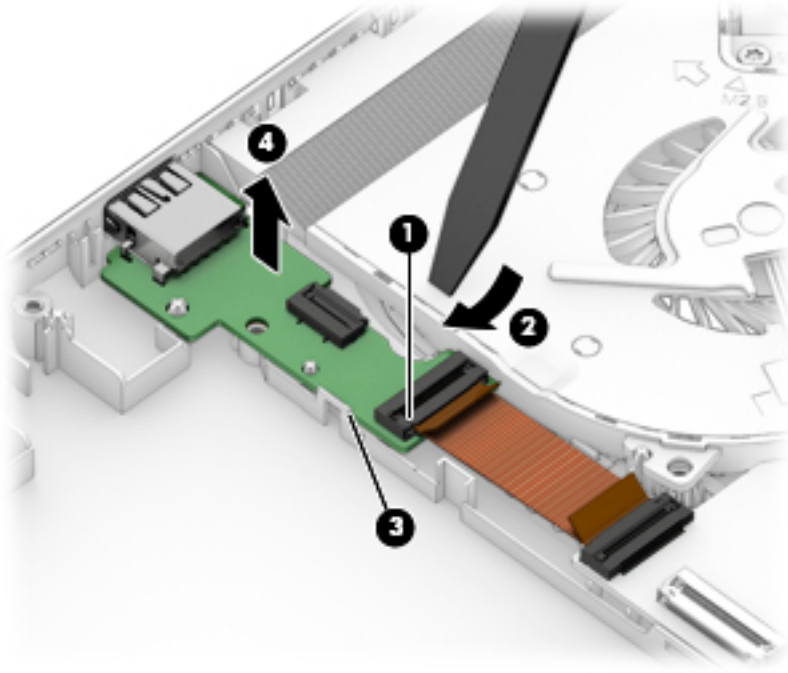

Reverse this procedure to install the USB board.

## System board



**NOTE:** All system board spare part kits include replacement thermal material.

All system boards use the following part numbers:

xxxxxx-001: Non-Windows operating systems

xxxxxx-601: Windows 10 operating system

Description	Spare part number
<b>System board with processor for use in models with UMA graphics:</b>	
Intel Core i7-8550U processor	L01042-xxx
Intel Core i5-8350U processor	L01041-xxx
Intel Core i5-8250U processor (WWAN models)	L01040-xxx
Intel Core i5-8250U processor	L01039-xxx
Intel Core i5-7200U processor	L06797-xxx
Intel Core i3-7100U processor (WWAN models)	L01038-xxx
Intel Core i3-7100U processor	L01037-xxx
Intel Core i3-6006U processor	L01036-xxx
Intel Celeron 3865U processor	L01035-xxx
<b>System board with processor for use in models with 2 GB of discrete graphics:</b>	
Intel Core i7-8550U processor	L01081-xxx
Intel Core i5-8350U processor	L01080-xxx
Intel Core i5-8250U processor	L01079-xxx
Intel Core i5-7200U processor	L06798-xxx
Intel Core i3-7100U processor	L01078-xxx

Before removing the system board, follow these steps:

1. Shut down the computer. If you are unsure whether the computer is off or in Hibernation, turn the computer on, and then shut it down through the operating system.
2. Place the computer in "Battery Safe mode" ([Battery Safe mode on page 32](#)).
3. Disconnect all external devices connected to the computer.
4. Disconnect the power from the computer by first unplugging the power cord from the AC outlet, and then unplugging the AC adapter from the computer.
5. Remove the following components:
  - a. Service doors ([Service doors on page 33](#)).
  - b. Hard drive ([Hard drive on page 41](#))
  - c. Keyboard ([Keyboard on page 44](#))
  - d. Top cover ([Top cover on page 48](#))

- e. Card reader board ([Card reader board on page 59](#))
- f. Battery ([Battery on page 64](#))

When replacing the system board, be sure to remove the following components (as applicable) from the defective system board and install on the replacement system board:

- Memory modules ([Memory modules on page 35](#))
- WLAN/Bluetooth module ([WLAN/Bluetooth combo card on page 37](#))
- WWAN module ([WWAN module on page 39](#))
- M.2 solid-state drive ([M.2 solid-state drive on page 43](#))

Remove the system board:

1. Position the computer upright on a flat surface and open the display as far as possible.
2. Disconnect the following cables from the system board:
  - (1): Display cable
  - (2): Power connector cable
  - (3): Hard drive connector cable (ZIF)

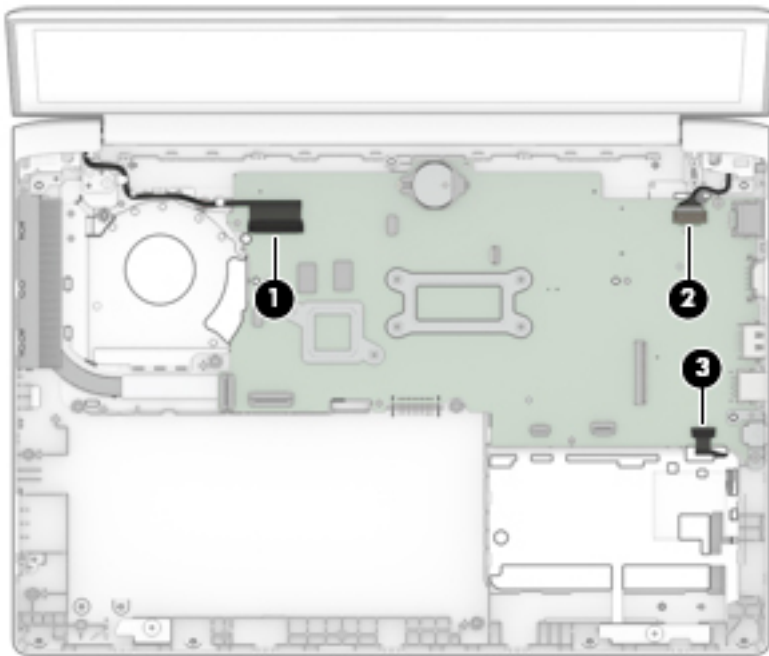

3. Remove the 2 Torx T8 2.5×4.0 screws (1) that secure the system board to the computer.
4. Lift the bracket from atop the USB-Type C port (2).  
The USB bracket is available using spare part number L01051-001.
5. Rotate the left side of the system board upward (3).

6. Pull the system board away from the connectors on the side of the chassis to remove it from the computer (4).

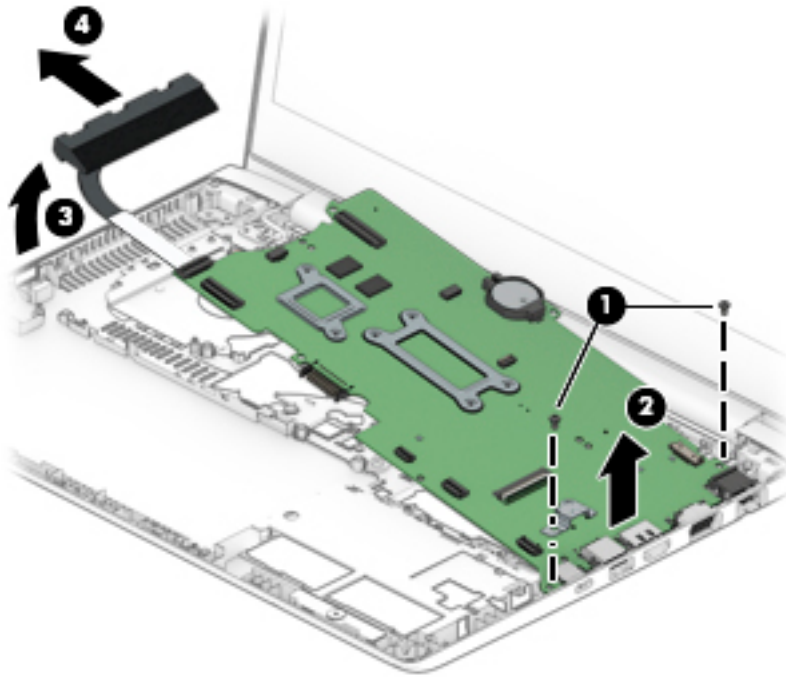

Reverse this procedure to install the system board.

## Heat sink assembly

All heat sink assembly spare part kits include replacement thermal material.

Description	Spare part number
Heat sink for use in models with UMA graphics	L01085-001
Heat sink for use in models with discrete graphics	L01086-001

Before removing the heat sink assembly, follow these steps:

1. Shut down the computer. If you are unsure whether the computer is off or in Hibernation, turn the computer on, and then shut it down through the operating system.
2. Place the computer in “Battery Safe mode” ([Battery Safe mode on page 32](#)).
3. Disconnect all external devices connected to the computer.
4. Disconnect the power from the computer by first unplugging the power cord from the AC outlet, and then unplugging the AC adapter from the computer.
5. Remove the following components:
  - a. Service doors ([Service doors on page 33](#)).
  - b. Hard drive ([Hard drive on page 41](#))
  - c. Keyboard ([Keyboard on page 44](#))
  - d. Top cover ([Top cover on page 48](#))
  - e. Card reader board ([Card reader board on page 59](#))
  - f. Battery ([Battery on page 64](#))
  - g. System board ([System board on page 67](#))

Remove the heat sink assembly:

1. Position the system board upside-down.
2. **Discrete models:** In the order indicated on the heat sink, loosen the 6 captive Phillips screws **(1)** that secure the heat sink to the system board.



3. Lift the heat sink from the system board (2).

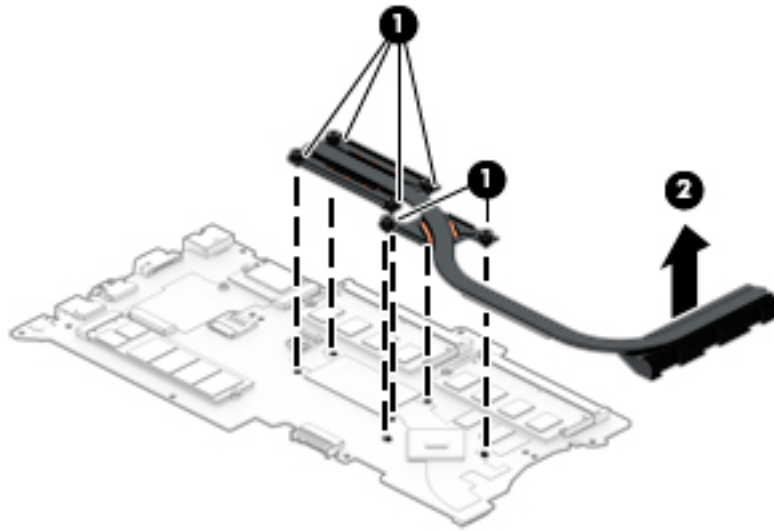

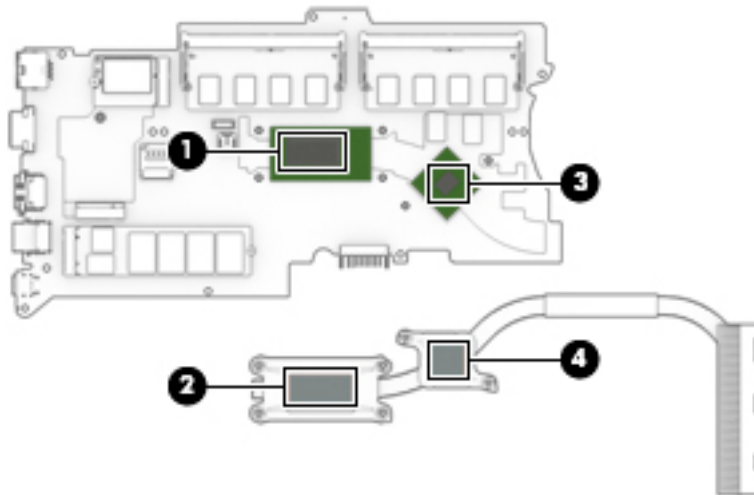

 **NOTE:** Thoroughly clean thermal material from the surfaces of the system board components (1)(3) and the heat sink (2)(4) each time you remove the heat sink. All heat sink and processor spare part kits include thermal material.

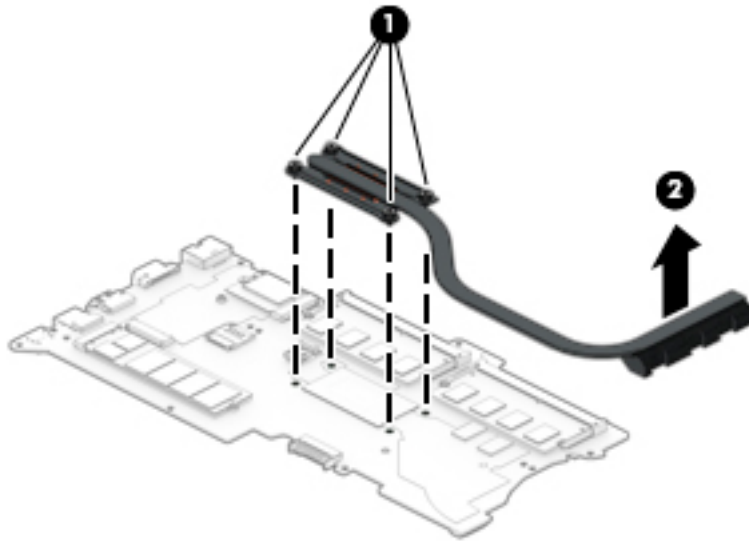

4. **UMA models:** In the order indicated on the heat sink, loosen the 4 captive Phillips screws (1) that secure the heat sink to the system board.

5. Lift the heat sink from the system board (2).



 **NOTE:** Thoroughly clean thermal material from the surfaces of the system board components (1) and the heat sink (2) each time you remove the heat sink. All heat sink and processor spare part kits include thermal material.

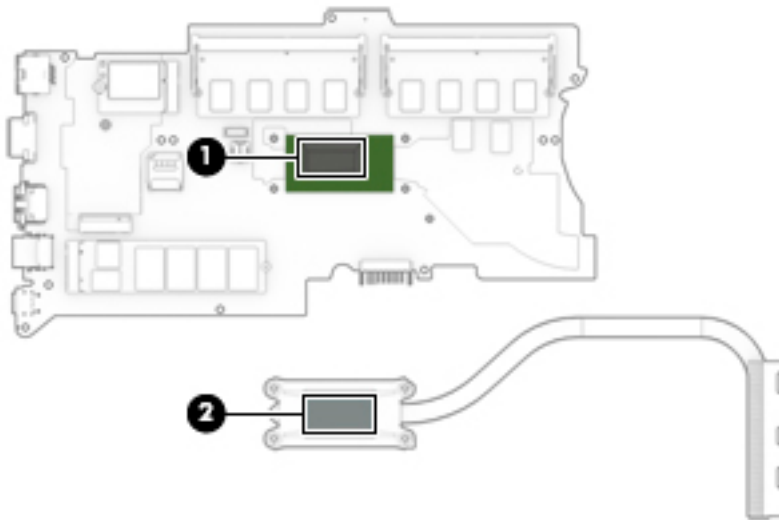

Reverse this procedure to install the heat sink assembly.

## Display assembly – non-touch

Description	Spare part number
Display panel assembly, touch screen (entire assembly)	L01102-001
<b>NOTE:</b> Touch displays are spared only as whole assemblies.	
<b>NOTE:</b> Non-touch displays are spared only at the subcomponent level. Non-touch assemblies are not spared as whole units.	

Before disassembling the display assembly, follow these steps:

1. Shut down the computer. If you are unsure whether the computer is off or in Hibernation, turn the computer on, and then shut it down through the operating system.
2. Place the computer in “Battery Safe mode” ([Battery Safe mode on page 32](#)).
3. Disconnect all external devices connected to the computer.
4. Disconnect the power from the computer by first unplugging the power cord from the AC outlet, and then unplugging the AC adapter from the computer.
5. Remove the following components:
  - a. Service doors ([Service doors on page 33](#)).
  - b. Hard drive ([Hard drive on page 41](#))
  - c. Keyboard ([Keyboard on page 44](#))
  - d. Top cover ([Top cover on page 48](#))

Disassemble the display assembly:

1. Position the computer upright on a flat surface and open the display as far as possible.
2. Flex the top **(1)** of the bezel, the inside edges of the left and right sides **(2)**, and then the right side of the bottom **(3)** and the left side of the bottom **(4)** of the bezel until it disengages from the display enclosure.

 **TIP:** The bottom, inside of the bezel is secured to the display enclosure with double-sided adhesive. When removing the bezel, be sure to remove the tape from the bezel so that it remains connected to the display.

3. Remove the display bezel (5).

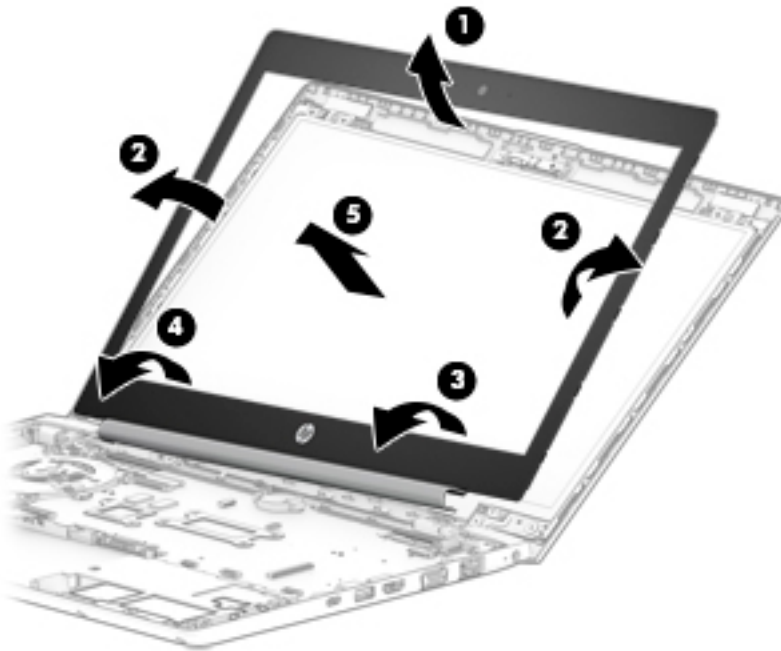

4. If it is necessary to remove or replace the display panel, remove the 4 Phillips M2.0×2.0 screws (1) that secure the display panel to the enclosure.
5. Rotate the display panel onto the keyboard (2) to gain access to the display cable connector on the back of the panel.

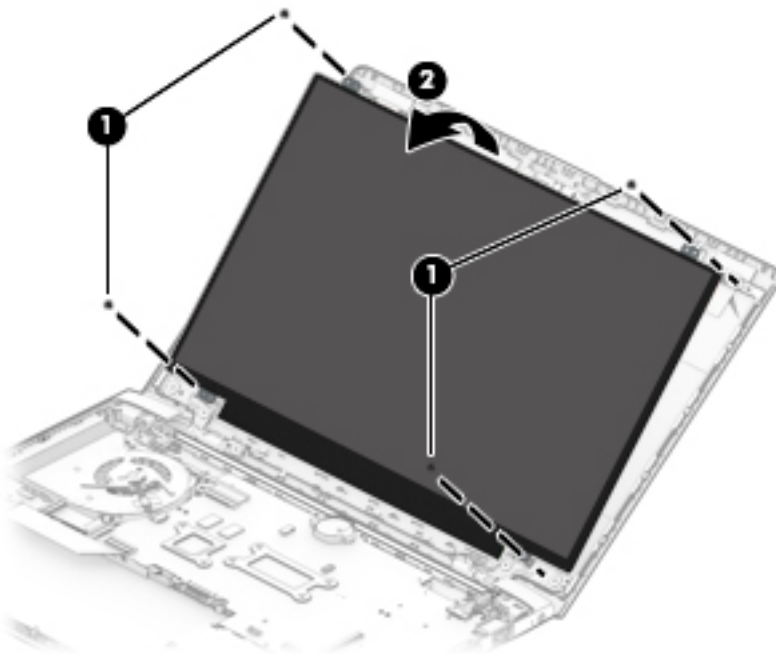

6. Lift the tape from atop the connector on the display panel (1), lift the connector latch (2), and then disconnect the cable from the panel (3).

7. Remove the panel (4).

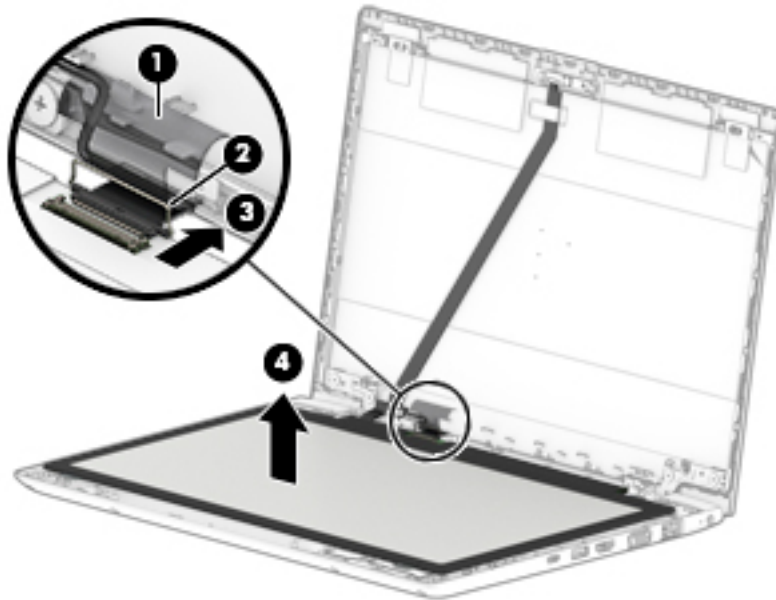

8. To remove the display enclosure, position the computer with the display enclosure lying on a flat surface and the computer upward at a 90 degree angle.
9. Remove the 6 Phillips broad head M2.5×2.5 screws (1) from the bottom of the display hinges and the 2 Phillips M2.0×2.0 screws (2) from the top of the display hinges.
10. Separate the display enclosure from the hinges (3).

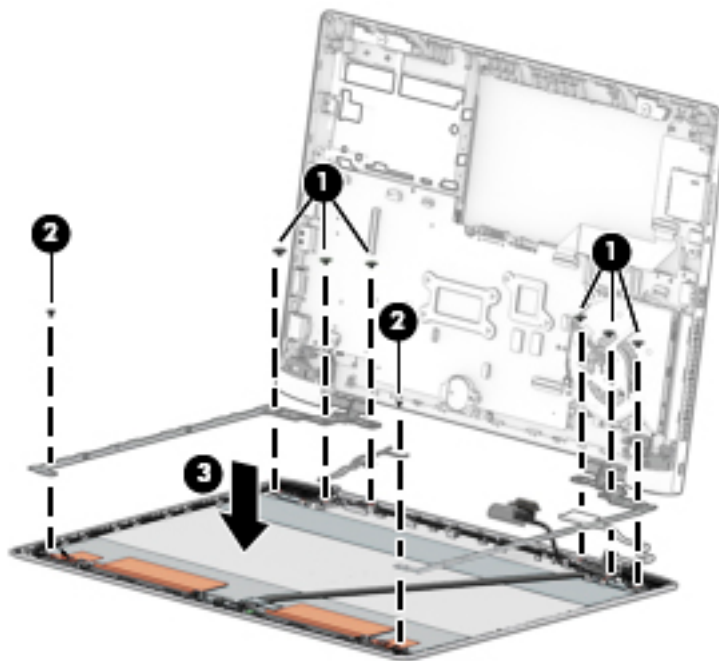

11. To remove the display hinges and brackets, remove the 4 Torx T8 2.5×4.0 screws (1) that secure the hinges to the computer, and then slide the hinges toward each other to remove them (2).

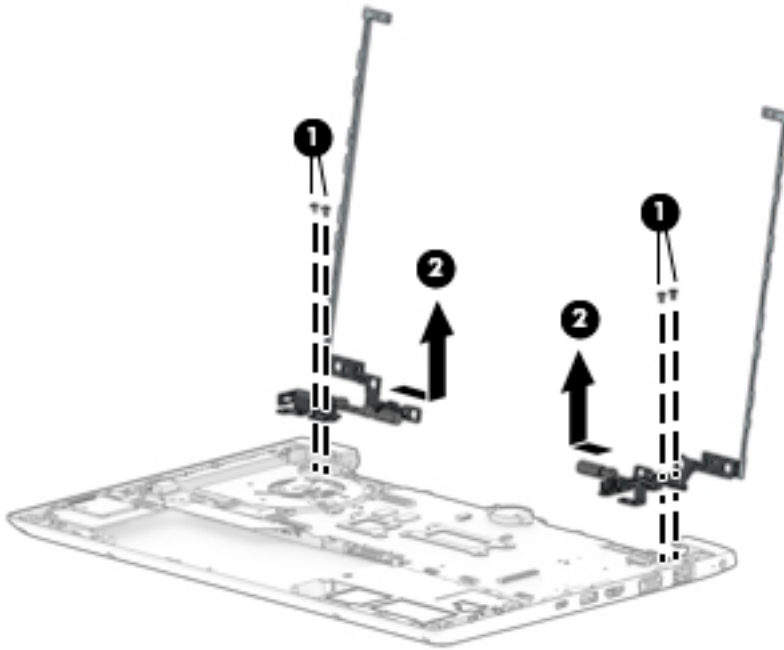

12. If it is necessary to replace the WiGig antenna, peel the antenna from the display enclosure (1), remove the cable from the clips in the side of the enclosure (2), and then lift the cable and antenna from the enclosure (3).

**CAUTION:** When installing the display assembly, be sure that the wireless antenna cables are routed and arranged properly. Failure to properly route the antennas can result in degradation of the computer's wireless performance.

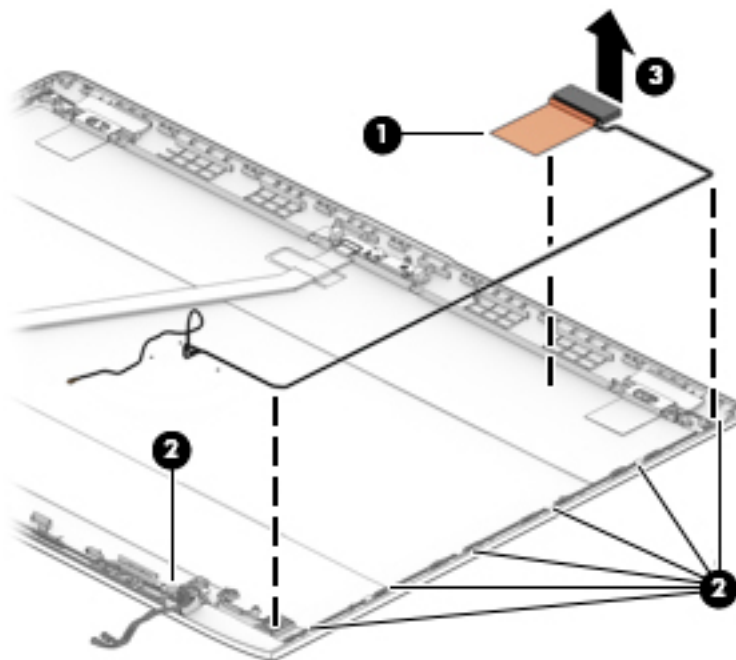

13. If it is necessary to replace the WWAN antennas, peel the antennas from the display enclosure (1), remove the cables from the clips in the sides of the enclosure (2), and then lift the cables and antennas from the enclosure (3).

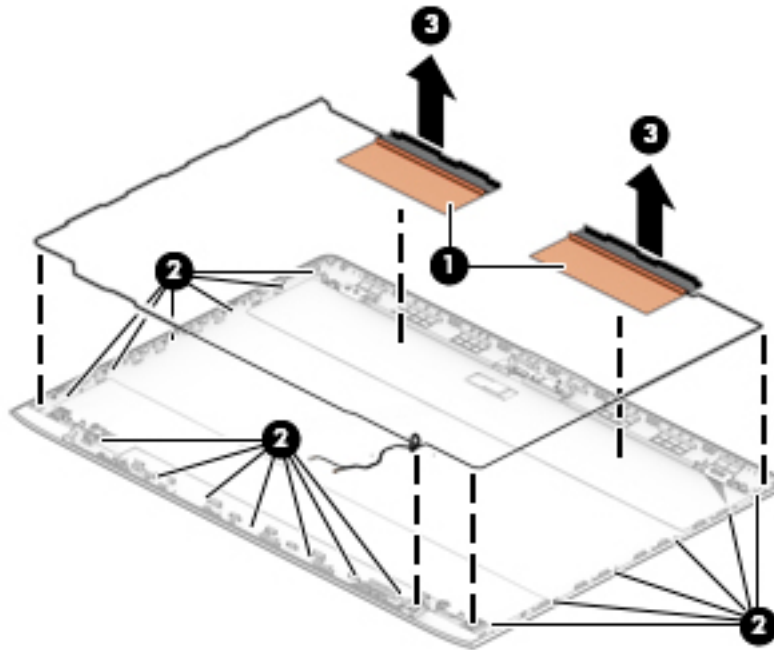

14. If it is necessary to replace the WLAN antennas, peel the antennas from the display enclosure (1), remove the cables from the clips in the sides of the enclosure (2), and then lift the cables and antennas from the enclosure (3).

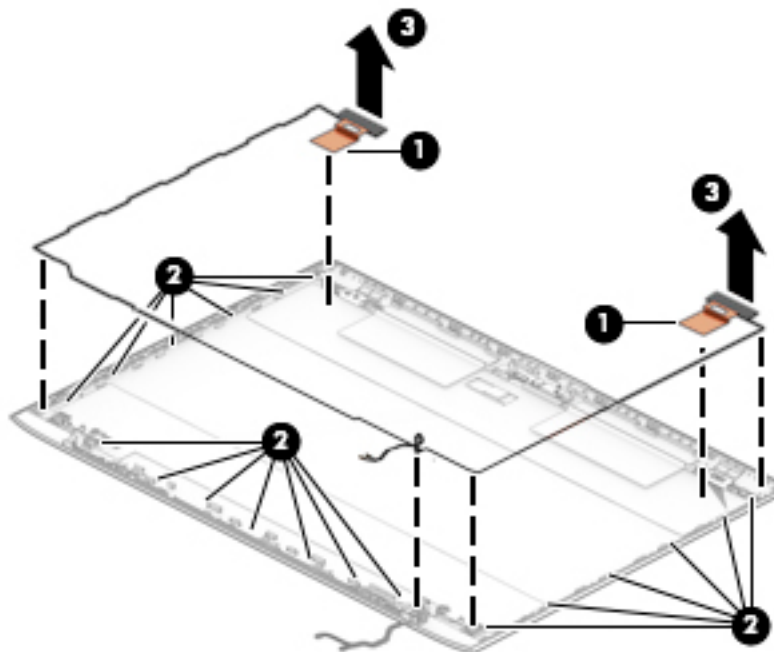

15. If it is necessary to remove or replace the IR camera, disconnect the cable from both sides of the camera (1), and then peel the camera module up to remove it from the adhesive that secures it to the enclosure (2).

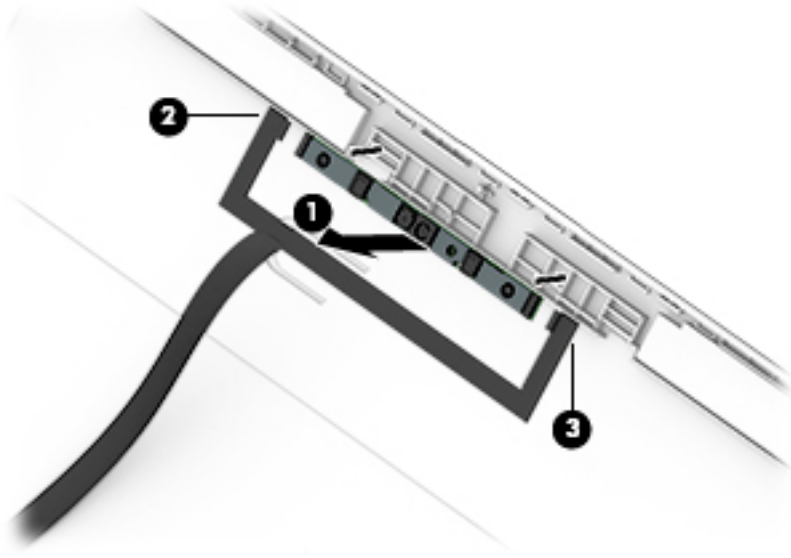

16. If it is necessary to remove or replace the HD camera, disconnect the cable from the camera (1), and then peel the camera module up to remove it from the adhesive that secures it to the enclosure (2).

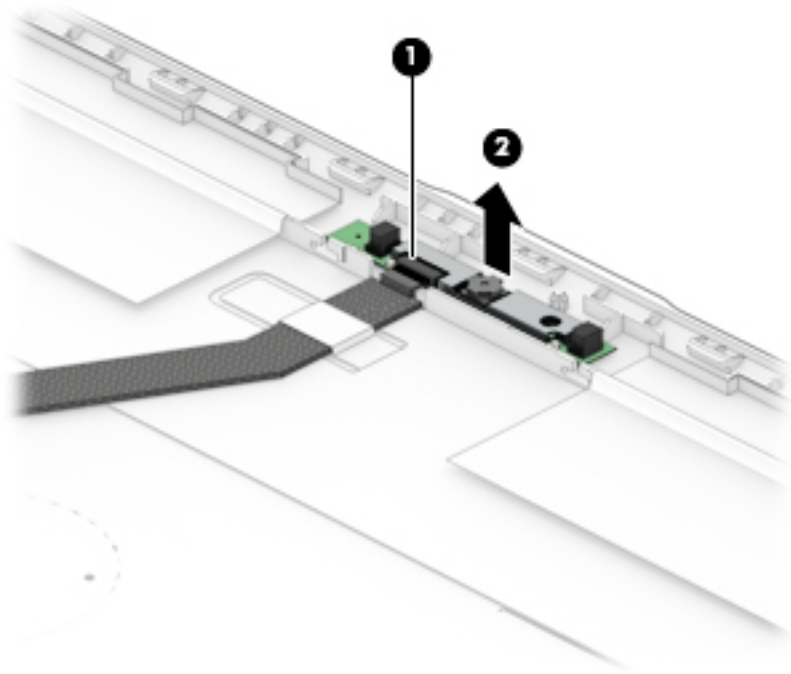



17. If it is necessary to remove or replace the IR display/camera cable, lift the cable from under the tab that secures it to the enclosure (1), and then remove the cable from the display enclosure (2).

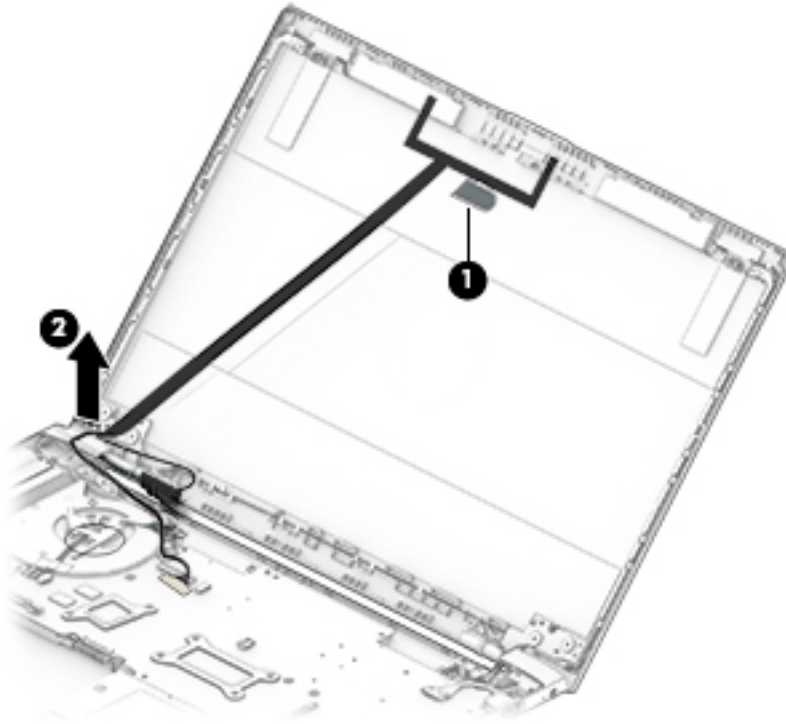

18. If it is necessary to remove or replace the HD display/camera cable, remove the cable from under the tab that secures it to the enclosure (1), and then remove the cable from the display enclosure (2).

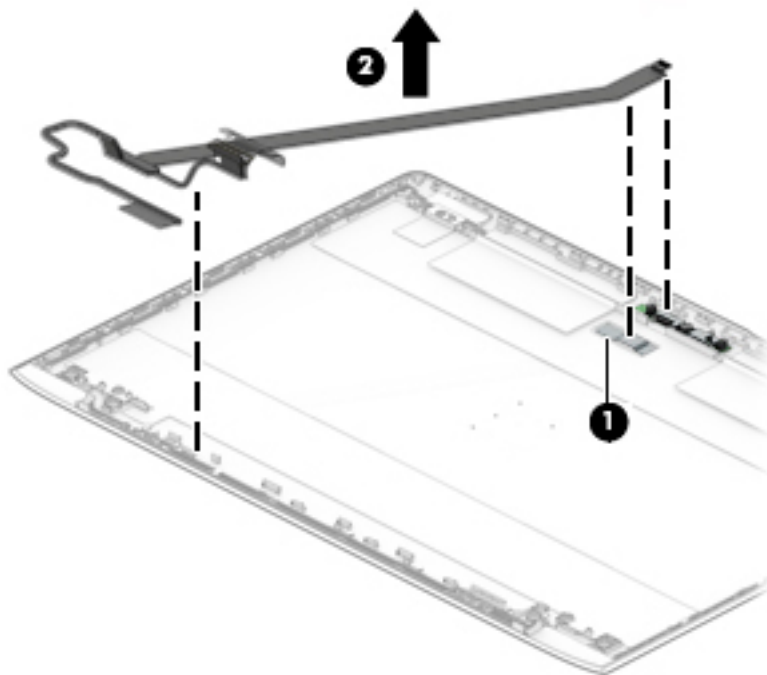

Reverse this procedure to reassemble the touch display assembly.

## Power cable

Description	Spare part number
Power cable	L07857-001

Before removing the power cable, follow these steps:

1. Shut down the computer. If you are unsure whether the computer is off or in Hibernation, turn the computer on, and then shut it down through the operating system.
2. Place the computer in “Battery Safe mode” ([Battery Safe mode on page 32](#)).
3. Disconnect all external devices connected to the computer.
4. Disconnect the power from the computer by first unplugging the power cord from the AC outlet, and then unplugging the AC adapter from the computer.
5. Remove the following components:
  - a. Service door ([Service doors on page 33](#)).
  - b. Hard drive ([Hard drive on page 41](#))
  - c. Keyboard ([Keyboard on page 44](#))
  - d. Top cover ([Top cover on page 48](#))
  - e. Card reader board ([Card reader board on page 59](#))
  - f. Battery ([Battery on page 64](#))
  - g. Display assembly right hinge ([Display assembly – non-touch on page 73](#))

Remove the power cable:

1. Disconnect the cable from the system board **(1)**.
2. Remove the power cable from the computer **(2)**.

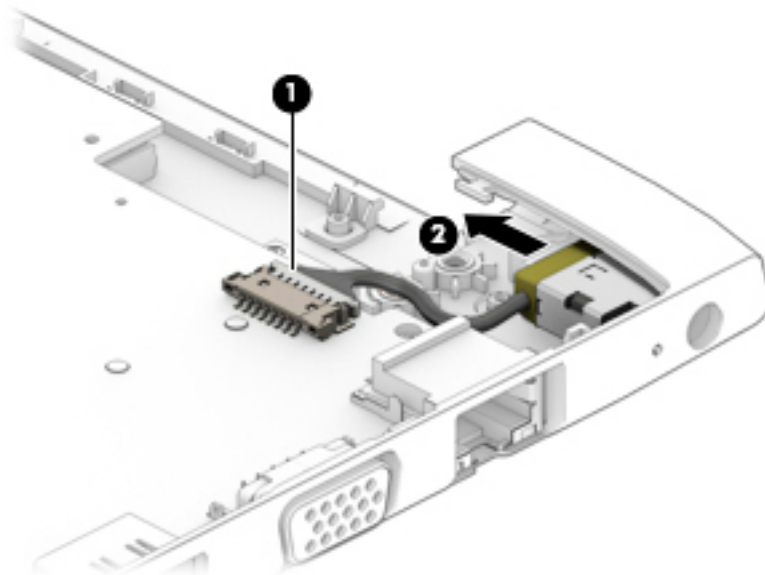

Reverse this procedure to install the power cable.

---

# 7 Computer Setup (BIOS), TPM, and HP Sure Start

## Using Computer Setup

Computer Setup, or Basic Input/Output System (BIOS), controls communication between all the input and output devices on the system (such as disk drives, display, keyboard, mouse, and printer). Computer Setup includes settings for the types of devices installed, the startup sequence of the computer, and the amount of system and extended memory.



**NOTE:** Use extreme care when making changes in Computer Setup. Errors can prevent the computer from operating properly.

---

## Starting Computer Setup

- ▲ Turn on or restart the computer, and when the HP logo appears, press **f10** to enter Computer Setup.

## Using a USB keyboard or USB mouse to start Computer Setup (BIOS)

You can start Computer Setup by using a keyboard or mouse connected to a USB port, but you must first disable FastBoot.

1. Turn on or restart the computer, and when the HP logo appears, press **f9** to enter the Boot Device Options menu.
2. Clear the check box for **Fast Boot**.
3. To save your changes and exit, select the **Save** icon in the lower-right corner of the screen, and then follow the on-screen instructions.

– or –

Select **Main**, select **Save Changes and Exit**, and then press **enter**.

Your changes go into effect when the computer restarts.

## Navigating and selecting in Computer Setup

- To select a menu or a menu item, use the **tab** key and the keyboard arrow keys and then press **enter**, or use a pointing device to select the item.
- To scroll up and down, select the up arrow or the down arrow in the upper-right corner of the screen, or use the up arrow key or the down arrow key on the keyboard.
- To close open dialog boxes and return to the main Computer Setup screen, press **esc**, and then follow the on-screen instructions.

To exit Computer Setup menus, choose one of the following methods:

- To exit Computer Setup menus without saving your changes:  
Select the **Exit** icon in the lower-right corner of the screen, and then follow the on-screen instructions.  
– or –  
Select **Main**, select **Ignore Changes and Exit**, and then press **enter**.
- To save your changes and exit Computer Setup menus:  
Select the **Save** icon in the lower-right corner of the screen, and then follow the on-screen instructions.  
– or –  
Select **Main**, select **Save Changes and Exit**, and then press **enter**.

Your changes go into effect when the computer restarts.

## Restoring factory settings in Computer Setup

---

 **NOTE:** Restoring defaults will not change the hard drive mode.

---

To return all settings in Computer Setup to the values that were set at the factory, follow these steps:

1. Start Computer Setup. See [Starting Computer Setup on page 81](#).
2. Select **Main**, and then select **Apply Factory Defaults and Exit**.

---

 **NOTE:** On select products, the selections may display **Restore Defaults** instead of **Apply Factory Defaults and Exit**.

---

3. Follow the on-screen instructions.
4. To save your changes and exit, select the **Save** icon in the lower-right corner of the screen, and then follow the on-screen instructions.  
– or –  
Select **Main**, select **Save Changes and Exit**, and then press **enter**.

Your changes go into effect when the computer restarts.

---

 **NOTE:** Your password settings and security settings are not changed when you restore the factory settings.

---

## Updating the BIOS

Updated versions of the BIOS may be available on the HP website.

Most BIOS updates on the HP website are packaged in compressed files called *SoftPaqs*.

Some download packages contain a file named *Readme.txt*, which contains information regarding installing and troubleshooting the file.

## Determining the BIOS version

To decide whether you need to update Computer Setup (BIOS), first determine the BIOS version on your computer.

BIOS version information (also known as *ROM date* and *System BIOS*) can be accessed by pressing **fn+esc** (if you are already in Windows) or by using Computer Setup.

1. Start Computer Setup. See [Starting Computer Setup on page 81](#).
2. Select **Main**, and then select **System Information**.
3. To exit Computer Setup without saving your changes, select the **Exit** icon in the lower-right corner of the screen, and then follow the on-screen instructions.

– or –

Select **Main**, select **Ignore Changes and Exit**, and then press [enter](#).

To check for later BIOS versions, see [Downloading a BIOS update on page 83](#).

## Downloading a BIOS update

---

 **CAUTION:** To reduce the risk of damage to the computer or an unsuccessful installation, download and install a BIOS update only when the computer is connected to reliable external power using the AC adapter. Do not download or install a BIOS update while the computer is running on battery power, docked in an optional docking device, or connected to an optional power source. During the download and installation, follow these instructions:

Do not disconnect power on the computer by unplugging the power cord from the AC outlet.

Do not shut down the computer or initiate Sleep.

Do not insert, remove, connect, or disconnect any device, cable, or cord.

---

1. Type `support` in the taskbar search box, and then select the HP Support Assistant app.  
– or –  
Select the question mark icon in the taskbar.
2. Select **Updates**, and then select **Check for updates and messages**.
3. Follow the on-screen instructions.
4. At the download area, follow these steps:
  - a. Identify the most recent BIOS update and compare it to the BIOS version currently installed on your computer. Make a note of the date, name, or other identifier. You may need this information to locate the update later, after it has been downloaded to your hard drive.
  - b. Follow the on-screen instructions to download your selection to the hard drive.  
  
Make a note of the path to the location on your hard drive where the BIOS update is downloaded. You will need to access this path when you are ready to install the update.

---

 **NOTE:** If you connect your computer to a network, consult the network administrator before installing any software updates, especially system BIOS updates.

---

BIOS installation procedures vary. Follow any instructions that are displayed on the screen after the download is complete. If no instructions are displayed, follow these steps:

1. Type `file` in the taskbar search box, and then select **File Explorer**.
2. Select your hard drive designation. The hard drive designation is typically Local Disk (C:).
3. Using the hard drive path you recorded earlier, open the folder that contains the update.
4. Double-click the file that has an `.exe` extension (for example, *filename.exe*).  
  
The BIOS installation begins.
5. Complete the installation by following the on-screen instructions.



---

**NOTE:** After a message on the screen reports a successful installation, you can delete the downloaded file from your hard drive.

---

## Changing the boot order using the f9 prompt

To dynamically choose a boot device for the current startup sequence, follow these steps:

1. Access the Boot Device Options menu:
  - Turn on or restart the computer, and when the HP logo appears, press **f9** to enter the Boot Device Options menu.
2. Select a boot device, press **enter**, and then follow the on-screen instructions.

## TPM BIOS settings (select products only)



---

**IMPORTANT:** Before enabling Trusted Platform Module (TPM) functionality on this system, you must ensure that your intended use of TPM complies with relevant local laws, regulations and policies, and approvals or licenses must be obtained if applicable. For any compliance issues arising from your operation/usage of TPM which violates the above mentioned requirement, you shall bear all the liabilities wholly and solely. HP will not be responsible for any related liabilities.

---

TPM provides additional security for your computer. You can modify the TPM settings in Computer Setup (BIOS).



---

**NOTE:** If you change the TPM setting to Hidden, TPM is not visible in the operating system.

---

To access TPM settings in Computer Setup:

1. Start Computer Setup. See [Starting Computer Setup on page 81](#).
2. Select **Security**, select **TPM Embedded Security**, and then follow the on-screen instructions.

## Using HP Sure Start (select products only)

Select computer models are configured with HP Sure Start, a technology that monitors the computer's BIOS for attacks or corruption. If the BIOS becomes corrupted or is attacked, HP Sure Start automatically restores the BIOS to its previously safe state, without user intervention.

HP Sure Start is configured and already enabled so that most users can use the HP Sure Start default configuration. The default configuration can be customized by advanced users.

To access the latest documentation on HP Sure Start, go to <http://www.hp.com/support>. Select **Find your product**, and then follow the on-screen instructions.

## 8 Using HP PC Hardware Diagnostics (UEFI)

HP PC Hardware Diagnostics is a Unified Extensible Firmware Interface (UEFI) that allows you to run diagnostic tests to determine whether the computer hardware is functioning properly. The tool runs outside the operating system so that it can isolate hardware failures from issues that are caused by the operating system or other software components.

When HP PC Hardware Diagnostics (UEFI) detects a failure that requires hardware replacement, a 24-digit Failure ID code is generated. This ID code can then be provided to support to help determine how to correct the problem.

---

 **NOTE:** To start diagnostics on a convertible computer, your computer must be in notebook mode and you must use the keyboard attached.

---

To start HP PC Hardware Diagnostics (UEFI), follow these steps:

1. Turn on or restart the computer, and quickly press **esc**.
2. Press **f2**.

The BIOS searches three places for the diagnostic tools, in the following order:

- a. Connected USB drive

---

 **NOTE:** To download the HP PC Hardware Diagnostics (UEFI) tool to a USB drive, see [Downloading HP PC Hardware Diagnostics \(UEFI\) to a USB device on page 85](#).

---

- b. Hard drive
  - c. BIOS
3. When the diagnostic tool opens, select the type of diagnostic test you want to run, and then follow the on-screen instructions.

---

 **NOTE:** If you need to stop a diagnostic test, press **esc**.

---

### Downloading HP PC Hardware Diagnostics (UEFI) to a USB device

---

 **NOTE:** The HP PC Hardware Diagnostics (UEFI) download instructions are provided in English only, and you must use a Windows computer to download and create the HP UEFI support environment because only .exe files are offered.

---

There are two options to download HP PC Hardware Diagnostics to a USB device.

#### Download the latest UEFI version

1. Go to <http://www.hp.com/go/techcenter/pcdiags>. The HP PC Diagnostics home page is displayed.
2. In the HP PC Hardware Diagnostics section, select the **Download** link, and then select **Run**.

#### Download any version of UEFI for a specific product

1. Go to <http://www.hp.com/support>.
2. Select **Get software and drivers**.
3. Enter the product name or number.

4. Select your computer, and then select your operating system.
5. In the **Diagnostic** section, follow the on-screen instructions to select and download the UEFI version you want.

## Using Remote HP PC Hardware Diagnostics (UEFI) settings (select products only)

Your computer supports Remote HP PC Hardware Diagnostics (UEFI). This is a firmware (BIOS) feature that downloads HP PC Hardware Diagnostics UEFI to your computer.

It executes the diagnostics on your computer, and then may upload results to a preconfigured server.

Using the Remote HP PC Hardware Diagnostics setting in Computer Setup (BIOS), you can perform the following customizations:

- Set a schedule for running diagnostics unattended. You can also start diagnostics immediately in interactive mode by selecting **Execute Remote HP PC Hardware Diagnostics**.
- Set the location for downloading the diagnostic tools. This feature provides access to the tools from the HP website or from a server that has been preconfigured for use. Your computer does not require the traditional local storage (such as a disk drive or USB flash drive) to run remote diagnostics.
- Set a location for storing the test results. You can also set the user name and password settings used for uploads.
- Display status information about the diagnostics run previously.

## Customizing Remote HP PC Hardware Diagnostics (UEFI) settings

1. Turn on or restart the computer, and when the HP logo appears, press **F10** to enter Computer Setup.
2. Select **Advanced**, and then select **Settings**.
3. Make your customization selections.
4. Select **Main**, and then **Save Changes and Exit** to save your settings.

Your changes take effect when the computer restarts.

To access documentation on using Remote HP PC Hardware Diagnostics (UEFI) to configure a server for remote diagnostics or to customize which diagnostic tests are run, go to <http://www.hp.com/support>. Select **Find your product**, and then follow the on-screen instructions.



# 9 Backing up, restoring, and recovering

This chapter provides information about the following processes. The information in the chapter is standard procedure for most products.

- Creating recovery media and backups
- Restoring and recovering your system

For additional information, refer to the HP Support Assistant app.

- ▲ Type `support` in the taskbar search box, and then select the **HP Support Assistant** app.

– or –

Select the question mark icon in the taskbar.

 **IMPORTANT:** If you will be performing recovery procedures on a tablet, the tablet battery must be at least 70% charged before you start the recovery process.

**IMPORTANT:** For a tablet with a detachable keyboard, connect the tablet to the keyboard base before beginning any recovery process.

## Creating recovery media and backups

The following methods of creating recovery media and backups are available on select products only. Choose the available method according to your computer model.

- Use HP Recovery Manager to create HP Recovery media after you successfully set up the computer. This step creates a backup of the HP Recovery partition on the computer. The backup can be used to reinstall the original operating system in cases where the hard drive is corrupted or has been replaced. For information on creating recovery media, see [Creating HP Recovery media \(select products only\) on page 87](#). For information on the recovery options that are available using the recovery media, see [Using Windows tools on page 88](#).

- Use Windows tools to create system restore points and create backups of personal information.

For more information, see [Recovering using HP Recovery Manager on page 89](#).

 **NOTE:** If storage is 32 GB or less, Microsoft System Restore is disabled by default.

- On select products, use the HP Cloud Recovery Download Tool to create a bootable USB drive for your HP recovery media. Go to <https://support.hp.com/us-en/document/c05115630?openCLC=true>, select your country or region, and follow the on-screen instructions.

## Creating HP Recovery media (select products only)

If possible, check for the presence of the Recovery partition and the Windows partition. Right-click the **Start** menu, select **File Explorer**, and then select **This PC**.

- If your computer does not list the Windows partition and the Recovery partition, you can obtain recovery media for your system from support. You can find contact information on the HP website. Go to <http://www.hp.com/support>, select your country or region, and follow the on-screen instructions.

You can use Windows tools to create system restore points and create backups of personal information, see [Using Windows tools on page 88](#).

- If your computer does list the Recovery partition and the Windows partition, you can use HP Recovery Manager to create recovery media after you successfully set up the computer. HP Recovery media can be used to perform system recovery if the hard drive becomes corrupted. System recovery reinstalls the original operating system and software programs that were installed at the factory and then configures the settings for the programs. HP Recovery media can also be used to customize the system or restore the factory image if you replace the hard drive.
  - Only one set of recovery media can be created. Handle these recovery tools carefully, and keep them in a safe place.
  - HP Recovery Manager examines the computer and determines the required storage capacity for the media that will be required.
  - To create recovery discs, your computer must have an optical drive with DVD writer capability, and you must use only high-quality blank DVD-R, DVD+R, DVD-R DL, or DVD+R DL discs. Do not use rewritable discs such as CD±RW, DVD±RW, double-layer DVD±RW, or BD-RE (rewritable Blu-ray) discs; they are not compatible with HP Recovery Manager software. Or, instead, you can use a high-quality blank USB flash drive.
  - If your computer does not include an integrated optical drive with DVD writer capability, but you would like to create DVD recovery media, you can use an external optical drive (purchased separately) to create recovery discs. If you use an external optical drive, it must be connected directly to a USB port on the computer; the drive cannot be connected to a USB port on an external device, such as a USB hub. If you cannot create DVD media yourself, you can obtain recovery discs for your computer from HP. You can find contact information on the HP website. Go to <http://www.hp.com/support>, select your country or region, and follow the on-screen instructions.
  - Be sure that the computer is connected to AC power before you begin creating the recovery media.
  - The creation process can take an hour or more. Do not interrupt the creation process.
  - If necessary, you can exit the program before you have finished creating all of the recovery DVDs. HP Recovery Manager will finish burning the current DVD. The next time you start HP Recovery Manager, you will be prompted to continue.

To create HP Recovery media:



---

**IMPORTANT:** For a tablet with a detachable keyboard, connect the tablet to the keyboard base before beginning these steps.

---

1. Type `recovery` in the taskbar search box, and then select **HP Recovery Manager**.
2. Select **Create recovery media**, and then follow the on-screen instructions.

If you ever need to recover the system, see [Recovering using HP Recovery Manager on page 89](#).

## Using Windows tools

You can create recovery media, system restore points, and backups of personal information using Windows tools.



---

**NOTE:** If storage is 32 GB or less, Microsoft System Restore is disabled by default.

---

For more information and steps, see the Get help app.

- ▲ Select the **Start** button, and then select the **Get Help** app.

---

 **NOTE:** You must be connected to the Internet to access the Get help app.

---

## Restore and recovery

There are several options for recovering your system. Choose the method that best matches your situation and level of expertise:

 **IMPORTANT:** Not all methods are available on all products.

---

- Windows offers several options for restoring from backup, refreshing the computer, and resetting the computer to its original state. For more information see the Get help app.

▲ Select the **Start** button, and then select the **Get Help** app.

 **NOTE:** You must be connected to the Internet to access the Get help app.

---

- If you need to correct a problem with a preinstalled application or driver, use the Reinstall drivers and/or applications option (select products only) of HP Recovery Manager to reinstall the individual application or driver.

▲ Type `recovery` in the taskbar search box, select **HP Recovery Manager**, select **Reinstall drivers and/or applications**, and then follow the on-screen instructions.

- If you want to recover the Windows partition to original factory content, you can choose the System Recovery option from the HP Recovery partition (select products only) or use the HP Recovery media. For more information, see [Recovering using HP Recovery Manager on page 89](#). If you have not already created recovery media, see [Creating HP Recovery media \(select products only\) on page 87](#).
- On select products, if you want to recover the computer's original factory partition and content, or if you have replaced the hard drive, you can use the Factory Reset option of HP Recovery media. For more information, see [Recovering using HP Recovery Manager on page 89](#).
- On select products, if you want to remove the Recovery partition to reclaim hard drive space, HP Recovery Manager offers the Remove Recovery Partition option.

For more information, see [Removing the HP Recovery partition \(select products only\) on page 91](#).

## Recovering using HP Recovery Manager

HP Recovery Manager software allows you to recover the computer to its original factory state by using the HP Recovery media that you either created or that you obtained from HP, or by using the HP Recovery partition (select products only). If you have not already created recovery media, see [Creating HP Recovery media \(select products only\) on page 87](#).

### What you need to know before you get started

- HP Recovery Manager recovers only software that was installed at the factory. For software not provided with this computer, you must either download the software from the manufacturer's website or reinstall the software from the media provided by the manufacturer.

 **IMPORTANT:** Recovery through HP Recovery Manager should be used as a final attempt to correct computer issues.

---

- HP Recovery media must be used if the computer hard drive fails. If you have not already created recovery media, see [Creating HP Recovery media \(select products only\) on page 87](#).

- To use the Factory Reset option (select products only), you must use HP Recovery media. If you have not already created recovery media, see [Creating HP Recovery media \(select products only\) on page 87](#).
- If your computer does not allow the creation of HP Recovery media or if the HP Recovery media does not work, you can obtain recovery media for your system from support. You can find contact information from the HP website. Go to <http://www.hp.com/support>, select your country or region, and follow the on-screen instructions.

---

 **IMPORTANT:** HP Recovery Manager does not automatically provide backups of your personal data. Before beginning recovery, back up any personal data you want to retain.

---

Using HP Recovery media, you can choose from one of the following recovery options:

---

 **NOTE:** Only the options available for your computer display when you start the recovery process.

---

- System Recovery—Reinstalls the original operating system, and then configures the settings for the programs that were installed at the factory.
- Factory Reset—Restores the computer to its original factory state by deleting all information from the hard drive and re-creating the partitions. Then it reinstalls the operating system and the software that was installed at the factory.

The HP Recovery partition (select products only) allows System Recovery only.

## Using the HP Recovery partition (select products only)

The HP Recovery partition allows you to perform a system recovery without the need for recovery discs or a recovery USB flash drive. This type of recovery can be used only if the hard drive is still working.

To start HP Recovery Manager from the HP Recovery partition:

---

 **IMPORTANT:** For a tablet with a detachable keyboard, connect the tablet to the keyboard base before beginning these steps (select products only).

---

1. Type `recovery` in the taskbar search box, select **HP Recovery Manager**, and then select **Windows Recovery Environment**.

– or –

For computers or tablets with keyboards attached, press **f11** while the computer boots, or press and hold **f11** as you press the power button.

For tablets without keyboards:

- Turn on or restart the tablet, and then quickly hold down the volume up button; then select **f11**.

– or –

- Turn on or restart the tablet, and then quickly hold down the volume down button; then select **f11**.

2. Select **Troubleshoot** from the boot options menu.
3. Select **Recovery Manager**, and then follow the on-screen instructions.

## Using HP Recovery media to recover

You can use HP Recovery media to recover the original system. This method can be used if your system does not have an HP Recovery partition or if the hard drive is not working properly.

1. If possible, back up all personal files.
2. Insert the HP Recovery media, and then restart the computer.



**NOTE:** If the computer does not automatically restart in HP Recovery Manager, change the computer boot order. See [Changing the computer boot order on page 91](#).

3. Follow the on-screen instructions.

## Changing the computer boot order

If your computer does not restart in HP Recovery Manager, you can change the computer boot order, which is the order of devices listed in BIOS where the computer looks for startup information. You can change the selection to an optical drive or a USB flash drive.

To change the boot order:



**IMPORTANT:** For a tablet with a detachable keyboard, connect the tablet to the keyboard base before beginning these steps.

1. Insert the HP Recovery media.
2. Access the system **Startup** menu.

For computers or tablets with keyboards attached:

- ▲ Turn on or restart the computer or tablet, quickly press **esc**, and then press **f9** for boot options.

For tablets without keyboards:

- ▲ Turn on or restart the tablet, and then quickly hold down the volume up button; then select **f9**.

– or –

Turn on or restart the tablet, and then quickly hold down the volume down button; then select **f9**.

3. Select the optical drive or USB flash drive from which you want to boot.
4. Follow the on-screen instructions.

## Removing the HP Recovery partition (select products only)

HP Recovery Manager software allows you to remove the HP Recovery partition to free up hard drive space.



**IMPORTANT:** After you remove the HP Recovery partition, you will not be able to perform System Recovery or create HP Recovery media from the HP Recovery partition. So before you remove the Recovery partition, create HP Recovery media; see [Creating HP Recovery media \(select products only\) on page 87](#).



**NOTE:** The Remove Recovery Partition option is only available on products that support this function.

Follow these steps to remove the HP Recovery partition:

1. Type `recovery` in the taskbar search box, and then select **HP Recovery Manager**.
2. Select **Remove Recovery Partition**, and then follow the on-screen instructions.

# 10 Specifications

## Computer specifications

	Metric	U.S.
<b>Dimensions</b>		
Depth (non-touch)	238.0 mm	9.37 in
Depth (touch)	238.0 mm	9.37 in
Width (non-touch)	336.0 mm	13.23 in
Width (touch)	336.0 mm	13.23 in
Height (non-touch)	19.95 mm	0.79 in
Height (touch)	21.55 mm	0.85 in
<b>Weight</b> (1 DIMM, WLAN, camera, no fingerprint reader, no WWAN)		
Non-touch, M.2 SSD,	1.64 kg	3.6 lbs
Non-touch, hard drive	1.74 kg	3.82 lbs
Touch, M.2 SSD,	1.90 kg	4.17 lbs
Touch, hard drive	2.00 kg	4.39 lbs
<b>Input power</b>		
Operating voltage	19.0 V dc @ 4.74 A – 90 W or 18.5 V dc @ 3.5 A – 65 W	
Operating current	4.74 A or 3.5 A	
<b>Temperature</b>		
Operating (not writing to optical disc)	0°C to 35°C	32°F to 95°F
Operating (writing to optical disc)	5°C to 35°C	41°F to 95°F
Nonoperating	-20°C to 60°C	-4°F to 140°F
<b>Relative humidity</b>		
Operating	10% to 90%	
Nonoperating	5% to 95%	
<b>Maximum altitude</b> (unpressurized)		
Operating (14.7 to 10.1 psia)	-15 m to 3,048 m	50 ft to 10,000 ft
Nonoperating (14.7 to 4.4 psia)	-15 m to 12,192 m	-50 ft to 40,000 ft
<b>Shock</b>		
Operating	125 g, 2 ms, half-sine	
Nonoperating	200 g, 2 ms, half-sine	
<b>Random vibration</b>		

	<b>Metric</b>	<b>U.S.</b>
Operating	0.75 g zero-to-peak, 10 Hz to 500 Hz, 0.25 oct/min sweep rate	
Nonoperating	1.50 g zero-to-peak, 10 Hz to 500 Hz, 0.5 oct/min sweep rate	

**NOTE:** Applicable product safety standards specify thermal limits for plastic surfaces. The computer operates well within this range of temperatures.

## 35.6-cm (14.0-in) display specifications

	<b>Metric</b>	<b>U.S.</b>
Active diagonal size	35.6-cm	14.0-in
Resolution	HD: 1366x768 FHD: 1920x1080	
Surface treatment	Anti-glare	
Panel Width	3.0 mm	
Brightness	220 nits	
Viewing angle	HD: SVA FHD: UWVA	
Backlight	LED	
Aspect ratio	16:9	

## Hard drive specifications

	1-TB*	500-GB*	500-GB* hybrid
<b>Dimensions</b>			
Height	7.0 mm	7.0 mm	7.0 mm
Width	70 mm	70 mm	70 mm
Weight	115 g	101 g or 95 g	95 g
<b>Interface type</b>	SATA	SATA	SATA
<b>Transfer rate</b>	100 MB/sec	100 MB/sec	100 MB/sec
<b>Security</b>	ATA security	ATA security	ATA security
<b>Seek times</b> (typical read, including setting)			
Single track	1.4 ms	3 ms	2 ms
Average	10 ms	13 ms	12 ms
Maximum	12 ms	24 ms	22 ms
<b>Logical blocks</b>	1,938,921,461	1,048,576,000	976,773,168
<b>Disc rotational speed</b>	5400 rpm	7200 rpm or 5400 rpm	5400 rpm
<b>Operating temperature</b>			
*1 GB = 1 billion bytes when referring to hard drive storage capacity. Actual accessible capacity is less. Actual drive specifications may differ slightly.			
<b>NOTE:</b> Certain restrictions and exclusions apply. Contact technical support for details.			



## Solid-state drive specifications

	128-GB*	256-GB*	512-GB*
<b>Height</b>	1.0 mm	1.0 mm	1.0 mm
<b>Length</b>	50.8 mm	50.8 mm	50.8 mm
<b>Width</b>	28.9 mm	28.9 mm	28.9 mm
<b>Weight</b>	< 10 g	< 10 g	< 10 g
<b>Transfer rate</b>			
Sequential read	up to 2150 MB/sec	up to 2150 MB/sec	up to 2150 MB/sec
Random read	Up to 300,000 IOPs	Up to 300,000 IOPs	Up to 300,000 IOPs
Sequential write	up to 1260 MB/sec	up to 1550 MB/sec	up to 1550 MB/sec
Random write	Up to 100,000 IOPs	Up to 100,000 IOPs	Up to 100,000 IOPs
<b>Interface type</b>	SATA-3	PCIe	PCIe
Ready time, maximum (to not busy)	1.0 ms	< 1.0 ms	< 1.0 ms
Access times, logical	0.1 ms	0.1 ms	0.1 ms
<b>Total logical sectors</b>	234,441,648	468,883,296	1,000,215,216
<b>Operating temperature</b>	0°C to 70°C (32°F to 158°F)		
*1 GB = 1 billion bytes when referring to hard drive storage capacity. Actual accessible capacity is less. Actual drive specifications may differ slightly.			
<b>NOTE:</b> Certain restrictions and exclusions apply. Contact technical support for details.			

# 11 Statement of memory volatility

The purpose of this chapter is to provide general information regarding nonvolatile memory in HP Business computers. This chapter also provides general instructions for restoring nonvolatile memory that can contain personal data after the system has been powered off and the hard drive has been removed.

HP Business computer products that use Intel®-based or AMD®-based system boards contain volatile DDR memory. The amount of nonvolatile memory present in the system depends upon the system configuration. Intel-based and AMD-based system boards contain nonvolatile memory subcomponents as originally shipped from HP, assuming that no subsequent modifications have been made to the system and assuming that no applications, features, or functionality have been added to or installed on the system.

Following system shutdown and removal of all power sources from an HP Business computer system, personal data can remain on volatile system memory (DIMMs) for a finite period of time and will also remain in nonvolatile memory. Use the steps below to remove personal data from the computer, including the nonvolatile memory found in Intel-based and AMD-based system boards.

---

 **NOTE:** If your tablet has a keyboard base, connect to the keyboard base before beginning steps in this chapter.

---

## Current BIOS steps

1. Follow steps (a) through (l) below to restore the nonvolatile memory that can contain personal data. Restoring or reprogramming nonvolatile memory that does not store personal data is neither necessary nor recommended.
  - a. Turn on or restart the computer, and then press **esc** while the “Press the ESC key for Startup Menu” message is displayed at the bottom of the screen.

---

 **NOTE:** If the system has a BIOS administrator password, enter the password at the prompt.

---

- b. Select **Main**, select **Apply Factory Defaults and Exit**, and then select **Yes** to load defaults.

The computer will reboot.

- c. During the reboot, press **esc** while the “Press the ESC key for Startup Menu” message is displayed at the bottom of the screen.

---

 **NOTE:** If the system has a BIOS administrator password, enter the password at the prompt.

---

- d. Select the **Security** menu, select **Restore Security Settings to Factory Defaults**, and then select **Yes** to restore security level defaults.

The computer will reboot.

- e. During the reboot, press **esc** while the “Press the ESC key for Startup Menu” message is displayed at the bottom of the screen.

---

 **NOTE:** If the system has a BIOS administrator password, enter the password at the prompt.

---

- f. If an asset or ownership tag is set, select the **Security** menu and scroll down to the **Utilities** menu. Select **System IDs**, and then select **Asset Tracking Number**. Clear the tag, and then make the selection to return to the prior menu.

- g.** If a DriveLock password is set, select the **Security** menu, and scroll down to **Hard Drive Utilities** under the **Utilities** menu. Select **Hard Drive Utilities**, select **DriveLock**, then uncheck the checkbox for **DriveLock password on restart**. Select **OK** to proceed.
- h.** Select the **Main** menu, and then select **Reset BIOS Security to factory default**. Click **Yes** at the warning message.  
The computer will reboot.
- i.** During the reboot, press **esc** while the “Press the ESC key for Startup Menu” message is displayed at the bottom of the screen.



---

**NOTE:** If the system has a BIOS administrator password, enter the password at the prompt.

- j.** Select the **Main** menu, select **Apply Factory Defaults and Exit**, select **Yes** to save changes and exit, and then select **Shutdown**.
  - k.** Reboot the system. If the system has a Trusted Platform Module (TPM) and/or fingerprint reader, one or two prompts will appear—one to clear the TPM and the other to Reset Fingerprint Sensor; press or tap **F1** to accept or **F2** to reject.
  - l.** Remove all power and system batteries for at least 24 hours.
- 2.** Complete one of the following:
- Remove and retain the storage drive.
  - or –
  - Clear the drive contents by using a third party utility designed to erase data from an SSD.
  - or –
  - Clear the contents of the drive by using the following BIOS Setup Secure Erase command option steps:



---

**IMPORTANT:** If you clear data using Secure Erase, it cannot be recovered.

- a.** Turn on or restart the computer, and then press **esc** while the “Press the ESC key for Startup Menu” message is displayed at the bottom of the screen.
- b.** Select the **Security** menu and scroll down to the **Utilities** menu.
- c.** Select **Hard Drive Utilities**.
- d.** Under **Utilities**, select **Secure Erase**, select the hard drive storing the data you want to clear, and then follow the on-screen instructions to continue.

## Nonvolatile memory usage

Nonvolatile Memory Type	Amount (Size)	Does this memory store customer data?	Does this memory retain data when power is removed?	What is the purpose of this memory?	How is data input into this memory?	How is this memory write-protected?
HP Sure Start flash (select models only)	8 MBytes	No	Yes	Provides protected backup of critical System BIOS code, EC firmware, and critical computer configuration data for select platforms that support HP Sure Start.  For more information, see <a href="#">Using HP Sure Start (select models only) on page 101</a> .	Data cannot be written to this device via the host processor. The content is managed solely by the HP Sure Start Embedded Controller.	This memory is protected by the HP Sure Start Embedded Controller.
Real Time Clock (RTC) battery backed-up CMOS configuration memory	256 Bytes	No	Yes	Stores system date and time and noncritical data.	RTC battery backed-up CMOS is programmed using the Computer Setup (BIOS), or changing the Microsoft Windows date & time.	This memory is not write-protected.
Controller (NIC) EEPROM	64 KBytes (not customer accessible)	No	Yes	Stores NIC configuration and NIC firmware.	NIC EEPROM is programmed using a utility from the NIC vendor that can be run from DOS.	A utility is required to write data to this memory and is available from the NIC vendor. Writing data to this ROM in an inappropriate manner will render the NIC non-functional.
DIMM Serial Presence Detect (SPD) configuration data	256 Bytes per memory module, 128 Bytes programmable (not customer accessible)	No	Yes	Stores memory module information.	DIMM SPD is programmed by the memory vendor.	Data cannot be written to this memory when the module is installed in a computer. The specific write-protection method varies by memory vendor.
System BIOS	9 MBytes	Yes	Yes	Stores system BIOS code and computer configuration data.	System BIOS code is programmed at the factory. Code is updated when the system BIOS is updated. Configuration data and settings are input using the Computer Setup (BIOS) or a custom utility.	<b>NOTE:</b> Writing data to this ROM in an inappropriate manner can render the computer non-functional.  A utility is required for writing data to this memory and is available on the HP website; go to <a href="http://www.hp.com/support">http://www.hp.com/support</a> . Select <b>Find your</b>

Nonvolatile Memory Type	Amount (Size)	Does this memory store customer data?	Does this memory retain data when power is removed?	What is the purpose of this memory?	How is data input into this memory?	How is this memory write-protected?
Intel Management Engine Firmware (present only in select Elite or Z models. For more information, go to <a href="http://www.hp.com/support">http://www.hp.com/support</a> . Select <b>Find your product</b> , and then follow the on-screen instructions.)	1.5 MBytes or 7 MBytes	Yes	Yes	Stores Management Engine Code, Settings, Provisioning Data and iAMT third-party data store.	Management Engine Code is programmed at the factory. Code is updated via Intel secure firmware update utility. Unique Provisioning Data can be entered at the factory or by an administrator using the Management Engine (MEBx) setup utility. The third party data store contents can be populated by a remote management console or local applications that have been registered by an administrator to have access to the space.	<b>product</b> , and then follow the on-screen instructions.  The Intel chipset is configured to enforce hardware protection to block all direct read/write access to this area. An Intel utility is required for updating the firmware. Only firmware updates digitally signed by Intel can be applied using this utility.
Bluetooth flash (select products only)	2 Mbit	No	Yes	Stores Bluetooth configuration and firmware.	Bluetooth flash is programmed at the factory. Tools for writing data to this memory are not publicly available but can be obtained from the silicon vendor.	A utility is required for writing data to this memory and is made available through newer versions of the driver whenever the flash requires an upgrade.
802.11 WLAN EEPROM	4 Kbit to 8 Kbit	No	Yes	Stores configuration and calibration data.	802.11 WLAN EEPROM is programmed at the factory. Tools for writing data to this memory are not made public.	A utility is required for writing data to this memory and is typically not made available to the public unless a firmware upgrade is necessary to address a unique issue.
Camera (select products only)	64 Kbit	No	Yes	Stores camera configuration and firmware.	Camera memory is programmed using a utility from the device manufacturer that can be run from Windows.	A utility is required for writing data to this memory and is typically not made available to the public unless a firmware upgrade is necessary to address a unique issue.
Fingerprint reader (select products only)	512 KByte flash	Yes	Yes	Stores fingerprint templates.	Fingerprint reader memory is programmed by user enrollment in HP ProtectTools Security Manager.	Only a digitally signed application can make the call to write to the flash.

## Questions and answers

### 1. How can the BIOS settings be restored (returned to factory settings)?



**IMPORTANT:** Restore defaults does not securely erase any data on your hard drive. See question and answer 6 for steps to securely erase data.

Restore defaults does not reset the Custom Secure Boot keys. See question and answer 7 for information about resetting the keys.

- a. Turn on or restart the computer, and then press **esc** while the “Press the ESC key for Startup Menu” message is displayed at the bottom of the screen.
- b. Select **Main**, and then select **Apply Factory Defaults and Exit**.
- c. Follow the on-screen instructions.
- d. Select **Main**, select **Save Changes and Exit**, and then follow the on-screen instructions.

### 2. What is a UEFI BIOS, and how is it different from a legacy BIOS?

The Unified Extensible Firmware Interface (UEFI) BIOS is an industry-standard software interface between the platform firmware and an operating system (OS). It is a replacement for the older BIOS architecture, but supports much of the legacy BIOS functionality.

Like the legacy BIOS, the UEFI BIOS provides an interface to display the system information and configuration settings and to change the configuration of your computer before an OS is loaded. BIOS provides a secure run-time environment that supports a Graphic User Interface (GUI). In this environment, you can use either a pointing device (Touchscreen, TouchPad, pointing stick, or USB mouse) or the keyboard to navigate and make menu and configuration selections. The UEFI BIOS also contains basic system diagnostics.

The UEFI BIOS provides functionality beyond that of the legacy BIOS. In addition, the UEFI BIOS works to initialize the computer’s hardware before loading and executing the OS; the run-time environment allows the loading and execution of software programs from storage devices to provide more functionality, such as advanced hardware diagnostics (with the ability to display more detailed system information) and advanced firmware management and recovery software.

HP has provided options in Computer Setup (BIOS) to allow you to run in legacy BIOS, if required by the operating system. Examples of this requirement would be if you upgrade or downgrade the OS.

### 3. Where does the UEFI BIOS reside?

The UEFI BIOS resides on a flash memory chip. A utility is required to write to the chip.

### 4. What kind of configuration data is stored on the DIMM Serial Presence Detect (SPD) memory module? How would this data be written?

The DIMM SPD memory contains information about the memory module, such as size, serial number, data width, speed/timing, voltage, and thermal information. This information is written by the module manufacturer and stored on an EEPROM. This EEPROM cannot be written to when the memory module is installed in a computer. Third-party tools do exist that can write to the EEPROM when the memory module is not installed in a computer. Various third-party tools are available to read SPD memory.

### 5. What is meant by “Restore the nonvolatile memory found in Intel-based system boards”?

This message relates to clearing the Real Time Clock (RTC) CMOS memory that contains computer configuration data.

### 6. How can the BIOS security be reset to factory defaults and data erased?

---

 **IMPORTANT:** Resetting will result in the loss of information.

These steps will not reset Custom Secure Boot Keys. See question and answer 7 for information about resetting the keys.

---

- a. Turn on or restart the computer, and then press **esc** while the “Press the ESC key for Startup Menu” message is displayed at the bottom of the screen.
- b. Select **Main**, and then select **Reset Security to Factory Defaults**.
- c. Follow the on-screen instructions.
- d. Select **Main**, select **Save Changes and Exit**, and then follow the on-screen instructions.

#### 7. How can the Custom Secure Boot Keys be reset?

Secure Boot is a feature to ensure that only authenticated code can start on a platform. If you enabled Secure Boot and created Custom Secure Boot Keys, simply disabling Secure Boot will not clear the keys. You must also select to clear the Custom Secure Boot Keys. Use the same Secure Boot access procedure you used to create the Custom Secure Boot Keys, but make the selection to clear or delete all Secure Boot Keys.

- a. Turn on or restart the computer, and then press **esc** while the “Press the ESC key for Startup Menu” message is displayed at the bottom of the screen.
- b. Select the **Security** menu, select **Secure Boot Configuration**, and then follow the on-screen instructions.
- c. At the **Secure Boot Configuration** window, select **Secure Boot**, select **Clear Secure Boot Keys**, and then follow the on-screen instructions to continue.

## Using HP Sure Start (select models only)

Select computer models are configured with HP Sure Start, a technology that continuously monitors your computer's BIOS for attacks or corruption. If the BIOS becomes corrupted or is attacked, HP Sure Start restores the BIOS to its previously safe state, without user intervention. Those select computer models ship with HP Sure Start configured and enabled. HP Sure Start is configured and already enabled so that most users can use the HP Sure Start default configuration. The default configuration can be customized by advanced users.

To access the latest documentation on HP Sure Start, go to <http://www.hp.com/support>. Select **Find your product**, and then follow the on-screen instructions.

# 12 Power cord set requirements

The wide-range input feature of the computer permits it to operate from any line voltage from 100 to 120 volts ac, or from 220 to 240 volts ac.

The 3-conductor power cord set included with the computer meets the requirements for use in the country or region where the equipment is purchased.

Power cord sets for use in other countries and regions must meet the requirements of the country or region where the computer is used.

## Requirements for all countries and regions

The following requirements are applicable to all countries and regions:

- The length of the power cord set must be at least **1.5 m** (5.0 ft) and no more than **2.0 m** (6.5 ft).
- All power cord sets must be approved by an acceptable accredited agency responsible for evaluation in the country or region where the power cord set will be used.
- The power cord sets must have a minimum current capacity of 10 A and a nominal voltage rating of 125 or 250 V ac, as required by the power system of each country or region.
- The appliance coupler must meet the mechanical configuration of an EN 60 320/IEC 320 Standard Sheet C13 connector for mating with the appliance inlet on the back of the computer.

## Requirements for specific countries and regions

Country/region	Accredited agency	Applicable note number
Argentina	IRAM	1
Australia	SAA	1
Austria	OVE	1
Belgium	CEBEC	1
Brazil	ABNT	1
Canada	CSA	2
Chile	IMQ	1
Denmark	DEMKO	1
Finland	FIMKO	1
France	UTE	1
Germany	VDE	1
India	ISI	1
Israel	SII	1
Italy	IMQ	1



Country/region	Accredited agency	Applicable note number
Japan	JIS	3
The Netherlands	KEMA	1
New Zealand	SANZ	1
Norway	NEMKO	1
The People's Republic of China	CCC	4
Saudi Arabia	SASO	7
Singapore	PSB	1
South Africa	SABS	1
South Korea	KTL	5
Sweden	SEMKO	1
Switzerland	SEV	1
Taiwan	BSMI	6
Thailand	TISI	1
The United Kingdom	ASTA	1
The United States	UL	2

1. The flexible cord must be Type H05VV-F, 3-conductor, 0.75mm<sup>2</sup> conductor size. Power cord set fittings (appliance coupler and wall plug) must bear the certification mark of the agency responsible for evaluation in the country or region where it will be used.
2. The flexible cord must be Type SVT/SJT or equivalent, No. 18 AWG, 3-conductor. The wall plug must be a two-pole grounding type with a NEMA 5-15P (15 A, 125 V ac) or NEMA 6-15P (15 A, 250 V ac) configuration. CSA or C-UL mark. UL file number must be on each element.
3. The appliance coupler, flexible cord, and wall plug must bear a "T" mark and registration number in accordance with the Japanese Dentori Law. The flexible cord must be Type VCTF, 3-conductor, 0.75mm<sup>2</sup> or 1.25mm<sup>2</sup> conductor size. The wall plug must be a two-pole grounding type with a Japanese Industrial Standard C8303 (7 A, 125 V ac) configuration.
4. The flexible cord must be Type RVV, 3-conductor, 0.75mm<sup>2</sup> conductor size. Power cord set fittings (appliance coupler and wall plug) must bear the CCC certification mark.
5. The flexible cord must be Type H05VV-F 3X0.75mm<sup>2</sup> conductor size. KTL logo and individual approval number must be on each element. Corset approval number and logo must be printed on a flag label.
6. The flexible cord must be Type HVCTF 3X1.25mm<sup>2</sup> conductor size. Power cord set fittings (appliance coupler, cable, and wall plug) must bear the BSMI certification mark.
7. For 127 V ac, the flexible cord must be Type SVT or SJT 3 x 18 AWG, with plug NEMA 5-15P (15 A, 125 V ac), with UL and CSA or C-UL marks. For 240 V ac, the flexible cord must be Type H05VV-F 3X0.75/1.00mm<sup>2</sup> conductor size, with plug BS 1363/A with BSI or ASTA marks.

---

# 13 Recycling

When a non-rechargeable or rechargeable battery has reached the end of its useful life, do not dispose of the battery in general household waste. Follow the local laws and regulations in your area for battery disposal.

HP encourages customers to recycle used electronic hardware, HP original print cartridges, and rechargeable batteries. For more information about recycling programs, see the HP Web site at <http://www.hp.com/recycle>.

# Index

## A

- AC adapter, spare part numbers 25
- action keys
  - using 14
- action keys, identifying 13
- antennas
  - disconnecting 37
- audio, product description 2
- audio-out (headphone)/audio-in (microphone) combo jack, identifying 7

## B

- backups 87
- base enclosure, spare part number 20
- battery
  - removing 64
  - spare part number 19, 64
- battery light 6
- BIOS
  - determining version 82
  - downloading an update 83
  - updating 82
- Bluetooth card
  - spare part number 37
- Bluetooth label 16
- boot order
  - changing 91
  - changing using the f9 prompt 84
- bottom 16
- Bracket Kit
  - contents 23
  - spare part number 23
- buttons
  - left TouchPad 10
  - power 12
  - right TouchPad 10

## C

- Cable Kit
  - contents 22
  - spare part number 22
- cables, service considerations 28

- camera 9
  - product description 2
- camera light, identifying 9
- camera module
  - spare part number 21
- camera, identifying 9
- caps lock light, identifying 11
- card reader board
  - removal 59
  - spare part number 19, 59
- components
  - bottom 15
  - display 9
  - left side 7
  - right side 6
  - top 10
- Computer Setup
  - navigating and selecting 81
  - restoring factory settings 82
  - using a USB keyboard or USB mouse to start Computer Setup 81
- computer setup 81
- computer specifications 92
- connector, power 7
- connectors, service considerations 28

## D

- diskette drive
  - precautions 28
- display assembly
  - removal 73
  - spare part numbers 21, 73
- display bezel
  - spare part numbers 21
- display panel
  - product description 1
- display rear cover
  - spare part number 22
- display specifications 93
- DisplayPort
  - identifying USB Type-C 6
- drive light, identifying 8

- drives
  - preventing damage 28

## E

- electrostatic discharge 29
- embedded numeric keypad, identifying 13
- esc key, identifying 13
- Ethernet, product description 2
- external media cards, product description 3
- external monitor port, using 6

## F

- fan
  - removing 60
  - spare part number 19
- fingerprint reader assembly
  - removal 51
  - spare part number 19, 51
- fingerprint reader, identifying 12
- fn key, identifying 13
- fn lock light 11

## G

- graphics, product description 1
- grounding equipment and methods 31

## H

- hard drive
  - precautions 28
  - product description 2
  - removing 41
  - spare part numbers 20, 24, 41
  - specifications 94
- hard drive cable
  - removing 62
- Hard Drive Hardware Kit
  - spare part number 20, 24, 33, 41
- hard drive, identifying 15
- HDMI port, identifying 6

- heat sink
  - removal 70
  - spare part number 20, 70
- Hinge Kit
  - spare part number 22
- hot keys
  - microphone mute 14
- HP PC Hardware Diagnostics (UEFI)
  - using 85
- HP Recovery Manager
  - correcting boot problems 91
  - starting 90
- HP Recovery media
  - creating 87
  - recovery 90
- HP Recovery partition
  - recovery 90
  - removing 91
- HP Sure Start 101

**I**

- integrated camera light, identifying 9
- internal microphones, identifying 9

**J**

- jacks
  - audio-out (headphone)/audio-in (microphone) combo 7
  - network 6
  - RJ-45 (network) 6

**K**

- keyboard
  - product description 3
  - removal 44
  - spare part numbers 19, 44
- keypad
  - embedded numeric 13
- keys
  - esc 13
  - fn 13
  - Windows application 13
  - Windows key 13

**L**

- labels
  - Bluetooth 16
  - regulatory 16
  - serial number 16
  - service 16

- wireless certification 16
- WLAN 16
- lights
  - battery 6
  - camera 9
  - caps lock 11
  - fn lock 11
  - hard drive 8
  - microphone mute 11
  - num lock 11
  - power 11
  - RJ-45 (network) 6
  - wireless 11

**M**

- mass storage devices, spare part numbers 24
- memory
  - nonvolatile 96
  - volatile 96
- memory card reader, identifying 8
- memory module
  - identifying 15
  - product description 1
  - removal 35
  - spare part numbers 20, 35
- microphone (audio-in) jack
  - product description 2
- microphone board
  - spare part number 21
- microphone mute key, identifying 14
- microphone mute light, identifying 11
- mini card
  - product description 2
- minimized image recovery 90
- minimized image, creating 89
- model name 1

**N**

- network jack, identifying 6
- nonvolatile memory 96
- num lock light 11

**O**

- operating system, product description 4
- optical drive
  - precautions 28
- original system recovery 89

**P**

- packing guidelines 30
- plastic parts 27
- Plastics Kit
  - contents 23
  - spare part number 23
- pointing device, product description 3
- ports
  - external monitor 6
  - HDMI 6
  - product description 3
  - USB 3.x SuperSpeed 6, 7
  - USB Type-C DisplayPort 6
  - USB Type-C power connector 6
  - USB Type-C SuperSpeed 6
- power button board
  - removal 53
  - spare part number 19, 53
- power button, identifying 12
- power cable
  - removal 80
  - spare part number 20, 80
- Power connector
  - identifying USB Type-C 6
- power connector, identifying 7
- power cord
  - set requirements 102
  - spare part numbers 25, 26
- power lights 11
- power requirements, product description 4
- processor
  - product description 1
- product description
  - audio 2
  - camera 2
  - display panel 1
  - Ethernet 2
  - external media cards 3
  - graphics 1
  - hard drives 2
  - keyboard 3
  - memory module 1
  - microphone 2
  - mini card 2
  - operating system 4
  - pointing devices 3
  - ports 3
  - power requirements 4

- processors 1
- product name 1
- security 4
- serviceability 5
- wireless 2
- product name 1
- product name and number, computer 16

## R

- recover
  - options 89
- recovery
  - discs 88, 90
  - HP Recovery Manager 89
  - media 90
  - starting 90
  - supported discs 88
  - system 89
  - USB flash drive 90
  - using HP Recovery media 88
- recovery media
  - creating 87
  - creating using HP Recovery Manager 88
- recovery partition
  - removing 91
- regulatory information
  - regulatory label 16
  - wireless certification labels 16
- removal/replacement
  - preliminaries 27
  - procedures, Authorized Service Provider 47
  - procedures, Customer Self-Repair 32
- removing personal data from volatile system memory 96
- RJ-45 (network) jack, identifying 6
- RJ-45 (network) lights, identifying 6
- RTC battery
  - removal 63
  - spare part number 19, 63

## S

- Screw Kit, spare part number 26
- security cable slot, identifying 7
- security, product description 4
- serial number 16

- serial number, computer 16
- service considerations 27
- service doors
  - removing 33
  - spare part number 33
- service labels, locating 16
- serviceability, product description 5
- setup utility
  - navigating and selecting 81
  - restoring factory settings 82
- SIM card
  - inserting 17
- SIM card slot, identifying 15
- slots
  - security cable 7
  - SIM card 15
- solid-state drive
  - removal 43
  - spare part numbers 20, 24, 43
  - specifications 95
- speaker assembly
  - removal 55
  - spare part number 19, 55
- speakers, identifying 12
- special keys, using 13
- specifications
  - computer 92
  - display 93
  - hard drive 94
  - solid-state drive 95
- static-shielding materials 31
- supported discs, recovery 88
- Sure Start
  - using 84
- system board
  - removal 67
  - spare part numbers 19, 67
- system memory, removing personal data from volatile 96
- system recovery 89
- system restore point
  - creating 88
- system restore point, creating 87

## T

- thermal material, replacement 71, 72
- tools required 27

- top cover
  - removal 48
  - spare part number 19, 48
- TouchPad
  - buttons 10
  - spare part number 19
- TouchPad assembly
  - removal 57
  - spare part number 57
- TouchPad zone
  - identifying 10
- TPM settings 84
- transporting guidelines 30
- traveling with the computer 16

## U

- USB
  - spare part number 19
- USB 3.x SuperSpeed port, identifying 6
- USB 3.x SuperSpeed powered port, identifying 7
- USB board
  - removal 65
  - spare part number 65
- USB Type-C power connector port, identifying 6
- USB Type-C SuperSpeed port, identifying 6

## V

- vents, identifying 7, 15

## W

- Windows
  - system restore point 87, 88
- Windows application key, identifying 13
- Windows key, identifying 13
- Windows tools
  - using 88
- wireless antennas
  - disconnecting 37
  - wireless antennas, identifying 9
  - wireless certification label 16
  - wireless light 11
  - wireless, product description 2
- WLAN antennas, identifying 9
- WLAN device 16
- WLAN label 16

- WLAN/Bluetooth combo card
  - removal 37
  - spare part number 20, 37
- workstation guidelines 30
- WWAN antennas, identifying 9
- WWAN module
  - removal 39
  - spare part numbers 39