

Samsung ML-1630W Series

# Monochrome Laser Printer



## User's Guide

**SAMSUNG**

© 2008 Samsung Electronics Co., Ltd. All rights reserved.

This user's guide is provided for information purposes only. All information included herein is subject to change without notice. Samsung Electronics is not responsible for any changes, direct or indirect damages, arising from or related to use of this user's guide.

- ML-1630W is model names of Samsung Electronics Co., Ltd.
- Samsung and Samsung logo are trademarks of Samsung Electronics Co., Ltd.
- Microsoft, Windows, Windows Vista, Windows 7 and Windows 2008 Server R2 are either registered trademarks or trademarks of Microsoft Corporation.
- UFST® and MicroType™ are registered trademarks of Monotype Imaging Inc.
- TrueType, LaserWriter and Macintosh are trademarks of Apple Computer, Inc.
- All other brand or product names are trademarks of their respective companies or organizations.
- Please visit [www.samsung.com](http://www.samsung.com) for open source information.
- Refer to the 'LICENSE.txt' file in the provided CD-ROM for the open source license information.

# CONTACT SAMSUNG WORLDWIDE

If you have any comments or questions regarding Samsung products, contact the Samsung customer care center.

COUNTRY/REGION	CUSTOMER CARE CENTER	WEB SITE
ARGENTINE	0800-333-3733	www.samsung.com/ar
AUSTRALIA	1300 362 603	www.samsung.com/au
AUSTRIA	0810-SAMSUNG (7267864, € 0.07/min)	www.samsung.com/at
BELARUS	810-800-500-55-500	www.samsung.ua www.samsung.com/ua_ru
BELGIUM	02 201 2418	www.samsung.com/be (Dutch) www.samsung.com/be_fr (French)
BRAZIL	0800-124-421 4004-0000	www.samsung.com/br
CANADA	1-800-SAMSUNG (726-7864)	www.samsung.com/ca
CHILE	800-SAMSUNG (726-7864)	www.samsung.com/cl
CHINA	400-810-5858 010-6475 1880	www.samsung.com/cn
COLOMBIA	01-8000112112	www.samsung.com.co
COSTA RICA	0-800-507-7267	www.samsung.com/latin
CZECH REPUBLIC	800-SAMSUNG (800-726786) Samsung Zrt., česká organizační složka, Oasis Florenc, Sokolovská394/17, 180 00, Praha 8	www.samsung.com/cz
DENMARK	8-SAMSUNG (7267864)	www.samsung.com/dk
ECUADOR	1-800-10-7267	www.samsung.com/latin
EL SALVADOR	800-6225	www.samsung.com/latin
ESTONIA	800-7267	www.samsung.com/ee
KAZAKHSTAN	8-10-800-500-55-500	www.samsung.com/kz_ru
KYRGYZSTAN	00-800-500-55-500	
FINLAND	30-6227 515	www.samsung.com/fi
FRANCE	01 4863 0000	www.samsung.com/fr
GERMANY	01805 - SAMSUNG (726-7864 € 0,14/min)	www.samsung.de
GUATEMALA	1-800-299-0013	www.samsung.com/latin
HONDURAS	800-7919267	www.samsung.com/latin
HONG KONG	3698-4698	www.samsung.com/hk www.samsung.com/hk_en/

COUNTRY/REGION	CUSTOMER CARE CENTER	WEB SITE
HUNGARY	06-80-SAMSUNG (726-7864)	www.samsung.com/hu
INDIA	3030 8282 1800 110011 1800 3000 8282	www.samsung.com/in
INDONESIA	0800-112-8888	www.samsung.com/id
ITALIA	800-SAMSUNG (726-7864)	www.samsung.com/it
JAMAICA	1-800-234-7267	www.samsung.com/latin
JAPAN	0120-327-527	www.samsung.com/jp
LATVIA	8000-7267	www.samsung.com/lv
LITHUANIA	8-800-77777	www.samsung.com/lt
LUXEMBURG	02 261 03 710	www.samsung.com/lu
MALAYSIA	1800-88-9999	www.samsung.com/my
MEXICO	01-800-SAMSUNG (726-7864)	www.samsung.com/mx
MOLDOVA	00-800-500-55-500	www.samsung.ua www.samsung.com/ua_ru
NETHERLANDS	0900-SAMSUNG (0900-7267864) (€ 0,10/min)	www.samsung.com/nl
NEW ZEALAND	0800 SAMSUNG (0800 726 786)	www.samsung.com/nz
NICARAGUA	00-1800-5077267	www.samsung.com/latin
NORWAY	3-SAMSUNG (7267864)	www.samsung.com/no
PANAMA	800-7267	www.samsung.com/latin
PHILIPPINES	1800-10-SAMSUNG (726-7864) 1-800-3-SAMSUNG (726-7864) 1-800-8-SAMSUNG (726-7864) 02-5805777	www.samsung.com/ph
POLAND	0 801 1SAMSUNG (172678) 022-607-93-33	www.samsung.com/pl
PORTUGAL	80820-SAMSUNG (726-7864)	www.samsung.com/pt
PUERTO RICO	1-800-682-3180	www.samsung.com/latin
REP. DOMINICA	1-800-751-2676	www.samsung.com/latin

<b>COUNTRY/REGION</b>	<b>CUSTOMER CARE CENTER</b>	<b>WEB SITE</b>
<b>EIRE</b>	0818 717 100	<a href="http://www.samsung.com/ie">www.samsung.com/ie</a>
<b>RUSSIA</b>	8-800-555-55-55	<a href="http://www.samsung.ru">www.samsung.ru</a>
<b>SINGAPORE</b>	1800-SAMSUNG (726-7864)	<a href="http://www.samsung.com/sg">www.samsung.com/sg</a>
<b>SLOVAKIA</b>	0800-SAMSUNG (726-7864)	<a href="http://www.samsung.com/sk">www.samsung.com/sk</a>
<b>SOUTH AFRICA</b>	0860 SAMSUNG (726-7864)	<a href="http://www.samsung.com/za">www.samsung.com/za</a>
<b>SPAIN</b>	902-1-SAMSUNG(902 172 678)	<a href="http://www.samsung.com/es">www.samsung.com/es</a>
<b>SWEDEN</b>	0771 726 7864 (SAMSUNG)	<a href="http://www.samsung.com/se">www.samsung.com/se</a>
<b>SWITZERLAND</b>	0848-SAMSUNG (7267864, CHF 0.08/min)	<a href="http://www.samsung.com/ch">www.samsung.com/ch</a>
<b>TADJIKISTAN</b>	8-10-800-500-55-500	
<b>TAIWAN</b>	0800-329-999	<a href="http://www.samsung.com/tw">www.samsung.com/tw</a>
<b>THAILAND</b>	1800-29-3232 02-689-3232	<a href="http://www.samsung.com/th">www.samsung.com/th</a>
<b>TRINIDAD &amp; TOBAGO</b>	1-800-SAMSUNG (726-7864)	<a href="http://www.samsung.com/latin">www.samsung.com/latin</a>
<b>TURKEY</b>	444 77 11	<a href="http://www.samsung.com/tr">www.samsung.com/tr</a>
<b>U.A.E</b>	800-SAMSUNG (726-7864) 8000-4726	<a href="http://www.samsung.com/ae">www.samsung.com/ae</a>
<b>U.K</b>	0845 SAMSUNG (726-7864)	<a href="http://www.samsung.com/uk">www.samsung.com/uk</a>
<b>U.S.A</b>	1-800-SAMSUNG (7267864)	<a href="http://www.samsung.com/us">www.samsung.com/us</a>
<b>UKRAINE</b>	8-800-502-0000	<a href="http://www.samsung.ua">www.samsung.ua</a> <a href="http://www.samsung.com/ua_ru">www.samsung.com/ua_ru</a>
<b>UZBEKISTAN</b>	8-10-800-500-55-500	<a href="http://www.samsung.com/kz_ru">www.samsung.com/kz_ru</a>
<b>VENEZUELA</b>	0-800-100-5303	<a href="http://www.samsung.com/latin">www.samsung.com/latin</a>
<b>VIETNAM</b>	1 800 588 889	<a href="http://www.samsung.com/vn">www.samsung.com/vn</a>

# CONTENTS

About this user's guide .....	i
Finding more information .....	i
Safety and Regulatory Information .....	ii
<b>1. Introduction</b>	
Special features .....	1.1
Machine overview .....	1.2
Front view .....	1.2
Rear view .....	1.3
Control panel overview .....	1.4
<b>2. Software overview</b>	
Supplied software .....	2.1
Printer driver features .....	2.2
System requirements .....	2.2
<b>3. Getting Started</b>	
Setting up the hardware .....	3.1
Setting up the network .....	3.2
Supported network environments .....	3.2
Using a wired network .....	3.2
Printing Configuration report .....	3.2
Setting IP address .....	3.2
Network parameter setting .....	3.3
Installing the software .....	3.3
Using a wireless network .....	3.4
Checking your Network Environments .....	3.4
Printing Configuration report .....	3.5
Setting IP address .....	3.5
Network parameter setting .....	3.6
Restoring factory default settings .....	3.6
Configuring the machine's wireless network .....	3.7
Installing the software .....	3.8
Altitude adjustment .....	3.9
<b>4. Selecting and loading print media</b>	
Selecting print media .....	4.1
Guidelines for selecting and storing print media .....	4.2
Specifications on print media .....	4.3
Guidelines for special print media .....	4.4
Loading paper in the tray .....	4.5
Changing the paper size in the tray .....	4.5

Setting the paper size and type .....	4.6
<b>5. Basic printing</b>	
Printing a document .....	5.1
Canceling a print job .....	5.1
<b>6. Maintenance</b>	
Printing a machine report .....	6.1
Cleaning your machine .....	6.1
Cleaning the outside .....	6.1
Cleaning the inside .....	6.1
Maintaining the cartridge .....	6.3
Toner cartridge storage .....	6.3
Handling instructions .....	6.3
Use of non-Samsung and refilled toner cartridge .....	6.3
Estimated cartridge life .....	6.3
Redistributing toner .....	6.3
Replacing the toner cartridge .....	6.5
Maintenance Parts .....	6.6
Managing your machine from the website .....	6.7
<b>7. Troubleshooting</b>	
Tips for avoiding paper jams .....	7.1
Clearing paper jams .....	7.1
In the paper feed area and rear the machine .....	7.1
Rear and inside the machine .....	7.3
In the exit area .....	7.5
Understanding display messages .....	7.7
Solving other problems .....	7.8
Paper feeding problems .....	7.8
Printing problems .....	7.8
Printing quality problems .....	7.10
Common Windows problems .....	7.12
Common Linux problems .....	7.13
Common Macintosh problems .....	7.13
<b>8. Ordering supplies and accessories</b>	
Supplies .....	8.1
How to purchase .....	8.1
<b>9. Specifications</b>	
General specifications .....	9.1
Printer specifications .....	9.1
<b>10. Glossary</b>	
<b>Index</b>	

## About this user's guide



This user's guide provides information about basic understanding of the machine as well as detailed explanation on each step during the actual usage. Both novice users and professional users can refer to this guide for installing and using the machine.

This explanation is mainly based on the Microsoft Windows operating system.

Some terms in this guide are used interchangeably, as below.



- Document is synonymous with original.
- Paper is synonymous with media, or print media.

The following table offers the conventions of this guide.

Convention	Description	Example
Bold	Used for texts on the display or actual prints on the machine.	<b>Properties</b>
Note	Used to provide additional information or detailed specification of the machine function and feature.	 <b>Note</b> The date format may differ from country to country.
Caution	Used to give users information to protect the machine from possible mechanical damage or malfunction.	 <b>Caution</b> Do not touch the green underside of the toner cartridge.
Footnote	Used to provide more detailed information on certain words or a phrase.	a. pages per minute
(See page 1.1 for more information)	Used to guide users to the reference page for the additional detailed information.	(See page 1.1 for more information)

## Finding more information

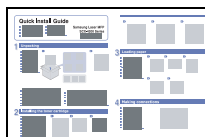
You can find information for setting up and using your machine from the following resources, either as a print-out or onscreen.

<b>Quick Install Guide</b> 	Provides information on setting up your machine and this requires that you follow the instructions in the guide to prepare the machine.
<b>Online User's Guide</b> 	Provides you with step-by-step instructions for using your machine's full features, and contains information for maintaining your machine, troubleshooting, and installing accessories.  This user's guide also contains Software section to provide you with information on how to print documents with your machine in various operating systems, and how to use the included software utilities.  <b>Note</b> You can access the user's guide in other languages from the Manual folder on the printer software CD.
<b>Printer Driver Help</b> 	Provides you with help information on printer driver properties and instructions for setting up the properties for printing. To access a printer driver help screen, click <b>Help</b> from the printer properties dialog box.
<b>Samsung website</b>	If you have Internet access, you can get help, support, printer drivers, manuals, and order information from the Samsung website, <a href="http://www.samsungprinter.com">www.samsungprinter.com</a> .

---

## Safety and Regulatory Information

---

### Important Precautions and Safety Information

When using this machine, these basic safety precautions should always be followed to reduce risk of fire, electric shock, and injury to people:

- 1 Read and understand all instructions.
- 2 Use common sense whenever operating electrical appliances.
- 3 Follow all warnings and instructions marked on the machine and in the literature accompanying the machine.
- 4 If an operating instruction appears to conflict with safety information, heed the safety information. You may have misunderstood the operating instruction. If you cannot resolve the conflict, contact your sales or service representative for assistance.
- 5 Unplug the machine from the AC wall socket before cleaning. Do not use liquid or aerosol cleaners. Use only a damp cloth for cleaning.
- 6 Do not place the machine on an unstable cart, stand or table. It may fall, causing serious damage.
- 7 Your machine should never be placed on, near or over a radiator, heater, air conditioner or ventilation duct.
- 8 Do not allow anything to rest on the power cable. Do not locate your machine where the cords will be abused by persons walking on them.
- 9 Do not overload wall outlets and extension cords. This can diminish performance, and may result in the risk of fire or electric shock.
- 10 Do not allow pets to chew on the AC power or PC interface cords.
- 11 Never push objects of any kind into the machine through case or cabinet openings. They may touch dangerous voltage points, creating a risk of fire or shock. Never spill liquid of any kind onto or into the machine.
- 12 To reduce the risk of electric shock, do not disassemble the machine. Take it to a qualified service technician when repair work is required. Opening or removing covers may expose you to dangerous voltages or other risks. Incorrect reassembly could cause electric shock when the unit is subsequently used.
- 13 Unplug the machine from the PC and AC wall outlet, and refer servicing to qualified service personnel under the following conditions:
  - When any part of the power cord, plug, or connecting cable is damaged or frayed.
  - If liquid has been spilled into the machine.
  - If the machine has been exposed to rain or water.
  - If the machine does not operate properly after instructions have been followed.
  - If the machine has been dropped, or the cabinet appears damaged.
  - If the machine exhibits a sudden and distinct change in performance.
- 14 Adjust only those controls covered by the operating instructions. Improper adjustment of other controls may result in damage, and may require extensive work by a qualified service technician to restore the machine to normal operation.
- 15 Avoid using this machine during a lightning storm. There may be a remote risk of electric shock from lightning. If possible, unplug the AC power for the duration of the lightning storm.
- 16 If you continuously print multiple pages, the surface of the output tray may become hot. Be careful not to touch the surface, and keep children away from the surface.
- 17 The Power cord supplied with your machine should be used for safe operation. If you are using a cord which is longer than 2 m with 110 V machine, then it should be 16 AWG\* or bigger.
- 18 SAVE THESE INSTRUCTIONS.

---

\* AWG: American Wire Gauge



## Environmental and Safety Consideration

### Laser Safety Statement

The printer is certified in the U.S. to conform to the requirements of DHHS 21 CFR, chapter 1 Subchapter J for Class I(1) laser products, and elsewhere, is certified as a Class I laser product conforming to the requirements of IEC 825.

Class I laser products are not considered to be hazardous. The laser system and printer are designed so there is never any human access to laser radiation above a Class I level during normal operation, user maintenance, or prescribed service condition.

### Warning

Never operate or service the printer with the protective cover removed from Laser/Scanner assembly. The reflected beam, although invisible, can damage your eyes.

When using this product, these basic safety precautions should always be followed to reduce risk of fire, electric shock, and injury to persons:

	CAUTION - CLASS 3B LASER RADIATION WHEN OPEN AVOID EXPOSURE TO THE BEAM. DANGER - LASER RADIATION AVOID DIRECT EXPOSURE TO BEAM.
	DANGER - RADIATIONS INVISIBLES DU LASER EN CAS D'OUVERTURE. EVITER TOUTE EXPOSITION DIRECTE AU FAISCEAU.
	VORSICHT - UNSICHTBARE LASERSTRAHLUNG, WENN ABDECKUNG GEÖFFNET. NICHT DEM STRAHL AUSSETZEN.
	ATTENZIONE - RADIAZIONE LASER INVISIBILE IN CASO DI APERTURA. EVITARE L'ESPOSIZIONE AL FASCIO.
	PRECAUCIÓN - RADIACIÓN LASER INVISIBLE CUANDO SE ABRE. EVITAR EXPONERSE AL RAYO.
	PERIGO - RADIACÃO LASER INVISÍVEL AO ABRIR. EVITE EXPOSIÇÃO DIRECTA AO FEIXE.
	GEVAAR - ONZICHTBARE LASERSTRALEN BIJ GEOPENDE KLEP. DEZE KLEP NIET OPENEN.
	ADVARSEL - USYNLIG LASERSTRÅLNING VED ÅBNING. UNDGÅ UDSAETTELSE FOR STRÅLNING.
	ADVARSEL - USYNLIG LASERSTRÅLNING NÄR DEKSEL ÄPNES. UNNGÅ EKSPONERING FOR STRÅLEN.
	VARNING - OSYNLIG LASERSTRÅLNING NÄR DENNA DEL ÄR ÖPPEN. STRÅLEN ÄR FARLIG.
	VAROITUS - NÄKYMÄTÖNTÄ LASERSÄTEILYÄ AVATTAESSA. VARO SUORAA ALTISTUMISTA SÄTEELLE.
	注 意 - 严禁揭开此盖, 以免激光泄露灼伤 주 의 - 이 덮개를 열면 레이저광에 노출될 수 있으므로 주의하십시오.

## Ozone Safety



During normal operation, this machine produces ozone. The ozone produced does not present a hazard to the operator. However, it is advisable that the machine be operated in a well ventilated area.

If you need additional information about ozone, please contact your nearest Samsung dealer.

## California USA Only

This Perchlorate warning applies only to primary CR (Manganese Dioxide) Lithium coin cells in the product sold or distributed ONLY in California USA.

Perchlorate Material - special handling may apply.

See [www.dtsc.ca.gov/hazardouswaste/perchlorate](http://www.dtsc.ca.gov/hazardouswaste/perchlorate).

## Recycling

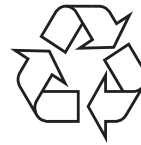

Please recycle or dispose of packaging materials for this product in an environmentally responsible manner.

## Correct Disposal of This Product (Waste Electrical & Electronic Equipment)

(Applicable in the European Union and other European countries with separate collection systems)



This marking shown on the product or its literature, indicates that it should not be disposed with other household wastes at the end of its working life. To prevent possible harm to the environment or human health from uncontrolled waste disposal, please separate this from other types of wastes and recycle it responsibly to promote the sustainable reuse of material resources.

Household users should contact either the retailer where they purchased this product, or their local government office, for details of where and how they can take this item for environmentally safe recycling.

Business users should contact their supplier and check the terms and conditions of the purchase contract. This product should not be mixed with other commercial wastes for disposal.

## Radio Frequency Emissions

### FCC Regulations

This device complies with Part 15 of the FCC Rules. Operation is subject to the following two conditions:

- This device may not cause harmful interference, and
- This device must accept any interference received, including interference that may cause undesired operation.

This device has been tested and found to comply with the limits for a Class B digital device, pursuant to Part 15 of the FCC rules. These limits are designed to provide reasonable protection against harmful interference in a residential installation. This equipment generates, uses and can radiate radio frequency energy and, if not installed and used in accordance with the instructions, may cause harmful interference to radio communications. However, there is no guarantee that interference will not occur in a particular installation. If this equipment does cause harmful interference to radio or television reception, which can be determined by turning the equipment off and on, the user is encouraged to try to correct the interference by one or more of the following measures:

- Reorient or relocate the receiving antenna.
- Increase the separation between the equipment and receiver.
- Connect the equipment into an outlet on a circuit different from that to which the receiver is connected.
- Consult the dealer or an experienced radio/TV technician for help.

## Caution:

Changes or modifications not expressly approved by the manufacturer responsible for compliance could void the user's authority to operate the equipment.

## Canadian Radio Interference Regulations

This digital apparatus does not exceed the Class B limits for radio noise emissions from digital apparatus as set out in the interference-causing equipment standard entitled "Digital Apparatus", ICES-003 of the Industry and Science Canada.

Cet appareil numérique respecte les limites de bruits radioélectriques applicables aux appareils numériques de Classe B prescrites dans la norme sur le matériel brouilleur: "Appareils Numériques", ICES-003 édictée par l'Industrie et Sciences Canada.

## United States of America

### Federal Communications Commission (FCC)

#### *Intentional emitter per FCC Part 15*

Low power, Radio LAN type devices (radio frequency (RF) wireless communication devices), operating in the 2.4 GHz/5 GHz Band, may be present (embedded) in your printer system. This section is only applicable if these devices are present. Refer to the system label to verify the presence of wireless devices.

Wireless devices that may be in your system are only qualified for use in the United States of America if an FCC ID number is on the system label.

The FCC has set a general guideline of 20 cm (8 inches) separation between the device and the body, for use of a wireless device near the body (this does not include extremities). This device should be used more than 20 cm (8 inches) from the body when wireless devices are on. The power output of the wireless device (or devices), which may be embedded in your printer, is well below the RF exposure limits as set by the FCC.

This transmitter must not be collocated or operation in conjunction with any other antenna or transmitter.

Operation of this device is subject to the following two conditions:(1) This device may not cause harmful interference, and(2) this device must accept any interference received, including interference that may cause undesired operation of the device.



Wireless devices are not user serviceable. Do not modify them in any way. Modification to a wireless device will void the authorization to use it. Contact manufacturer for service.



#### **FCC Statement for Wireless LAN use:**

"While installing and operating this transmitter and antenna combination the radio frequency exposure limit of 1mW/cm<sup>2</sup> may be exceeded at distances close to the antenna installed. Therefore, the user must maintain a minimum distance of 20cm from the antenna at all times. This device can not be collocated with another transmitter and transmitting antenna."

## Declaration of Conformity (European Countries)

### Approvals and Certifications



The CE marking applied to this product symbolises Samsung Electronics Co., Ltd. Declaration of Conformity with the following applicable 93/68/EEC Directives of the European Union as of the dates indicated:

The declaration of conformity may be consulted at [www.samsung.com/printer](http://www.samsung.com/printer), go to Support > Download center and enter your printer name to browse the EuDoC.

January 1, 1995: Council Directive 73/23/EEC Approximation of the laws of the member states related to low voltage equipment.

January 1, 1996: Council Directive 89/336/EEC (92/31/EEC), approximation of the laws of the Member States related to electromagnetic compatibility.

March 9, 1999: Council Directive 1999/5/EC on radio equipment and telecommunications terminal equipment and the mutual recognition of their conformity.

A full declaration, defining the relevant Directives and referenced standards can be obtained from your Samsung Electronics Co., Ltd. representative.

### EC Certification

#### **Certification to 1999/5/EC Radio Equipment & Telecommunications Terminal Equipment Directive (FAX)**

This Samsung product has been self-certified by Samsung for pan-European single terminal connection to the analogue public switched telephone network (PSTN) in accordance with Directive 1999/5/EC. The product has been designed to work with the national PSTNs and compatible PBXs of the European countries:

In the event of problems, you should contact the Euro QA Lab of Samsung Electronics Co., Ltd. in the first instance.

The product has been tested against TBR21 and/or TBR 38. To assist in the use and application of terminal equipment which complies with this standard, the European Telecommunication Standards Institute (ETSI) has issued an advisory document (EG 201 121) which contains notes and additional requirements to ensure network compatibility of TBR21 terminals. The product has been designed against, and is fully compliant with, all of the relevant advisory notes contained in this document.

#### **European Radio Approval Information (for products fitted with EU-approved radio devices)**

This Product is a printer; low power, Radio LAN type devices (radio frequency (RF) wireless communication devices), operating in the 2.4 GHz/5 GHz band, may be present (embedded) in your printer system which is intended for home or office use. This section is only applicable if these devices are present. Refer to the system label to verify the presence of wireless devices.

Wireless devices that may be in your system are only qualified for use in the European Union or associated areas if a CE mark with  a Notified Body Registration Number and the Alert Symbol is on the system label.

The power output of the wireless device or devices that may be embedded in you printer is well below the RF exposure limits as set by the European Commission through the R&TTE directive.

#### **European States qualified under wireless approvals:**

**EU** Austria, Belgium, Cyprus, Czech Republic, Denmark, Estonia, Finland, France (with frequency restrictions), Germany, Greece, Hungary, Ireland, Italy, Latvia, Lithuania, Luxembourg, Malta, The Netherlands, Poland, Portugal, Slovakia, Slovenia, Spain, Sweden and the U.K.

**EEA/EFTA countries** Iceland, Liechtenstein, Norway and Switzerland

### European States with restrictions on use:

**EU** In France, the frequency range is restricted to 2446.5-2483.5 MHz for devices above 10 mW transmitting power such as wireless

**EEA/EFTA countries** No limitations at this time.

## Regulatory Compliance Statements

### Wireless Guidance

Low power, Radio LAN type devices (radio frequency (RF) wireless communication devices), operating in the 2.4 GHz/5 GHz Band, may be present (embedded) in your printer system. The following section is a general overview of considerations while operating a wireless device.

Additional limitations, cautions, and concerns for specific countries are listed in the specific country sections (or country group sections). The wireless devices in your system are only qualified for use in the countries identified by the Radio Approval Marks on the system rating label. If the country you will be using the wireless device in, is not listed, please contact your local Radio Approval agency for requirements. Wireless devices are closely regulated and use may not be allowed.

The power output of the wireless device or devices that may be embedded in your printer is well below the RF exposure limits as known at this time. Because the wireless devices (which may be embedded into your printer) emit less energy than is allowed in radio frequency safety standards and recommendations, manufacturer believes these devices are safe for use. Regardless of the power levels, care should be taken to minimize human contact during normal operation.

As a general guideline, a separation of 20 cm (8 inches) between the wireless device and the body, for use of a wireless device near the body (this does not include extremities) is typical. This device should be used more than 20 cm (8 inches) from the body when wireless devices are on and transmitting.

This transmitter must not be collocated or operation in conjunction with any other antenna or transmitter.

Some circumstances require restrictions on wireless devices. Examples of common restrictions are listed below:



Radio frequency wireless communication can interfere with equipment on commercial aircraft. Current aviation regulations require wireless devices to be turned off while traveling in an airplane. IEEE 802.11 (also known as wireless Ethernet) and Bluetooth communication devices are examples of devices that provide wireless communication.



In environments where the risk of interference to other devices or services is harmful or perceived as harmful, the option to use a wireless device may be restricted or eliminated. Airports, Hospitals, and Oxygen or flammable gas laden atmospheres are limited examples where use of wireless devices may be restricted or eliminated. When in environments where you are uncertain of the sanction to use wireless devices, ask the applicable authority for authorization prior to use or turning on the wireless device.



Every country has different restrictions on the use of wireless devices. Since your system is equipped with a wireless device, when traveling between countries with your system, check with the local Radio Approval authorities prior to any move or trip for any restrictions on the use of a wireless device in the destination country.



If your system came equipped with an internal embedded wireless device, do not operate the wireless device unless all covers and shields are in place and the system is fully assembled.



Wireless devices are not user serviceable. Do not modify them in any way. Modification to a wireless device will void the authorization to use it. Please contact manufacturer for service.



Only use drivers approved for the country in which the device will be used. See the manufacturer System Restoration Kit, or contact manufacturer Technical Support for additional information.

## Replacing the Fitted Plug (for UK Only)

### Important

The mains lead for this machine is fitted with a standard (BS 1363) 13 amp plug and has a 13 amp fuse. When you change or examine the fuse, you must re-fit the correct 13 amp fuse. You then need to replace the fuse cover. If you have lost the fuse cover, do not use the plug until you have another fuse cover.

Please contact the people from you purchased the machine.

The 13 amp plug is the most widely used type in the UK and should be suitable. However, some buildings (mainly old ones) do not have normal 13 amp plug sockets. You need to buy a suitable plug adaptor. Do not remove the moulded plug.

### Warning

**If you cut off the moulded plug, get rid of it straight away.**

**You cannot rewire the plug and you may receive an electric shock if you plug it into a socket.**

**Important warning: You must earth this machine.**

The wires in the mains lead have the following color code:

- Green and Yellow: Earth
- Blue: Neutral
- Brown: Live

If the wires in the mains lead do not match the colors marked in your plug, do the following:

You must connect the green and yellow wire to the pin marked by the letter "E" or by the safety 'Earth symbol' or colored green and yellow or green.

You must connect the blue wire to the pin which is marked with the letter "N" or colored black.

You must connect the brown wire to the pin which is marked with the letter "L" or colored red.

You must have a 13 amp fuse in the plug, adaptor, or at the distribution board.

## OPENSSL LICENSE

---

Copyright (c) 1998-2001 The OpenSSL Project. All rights reserved.

Redistribution and use in source and binary forms, with or without modification, are permitted provided that the following conditions are met:

1. Redistributions of source code must retain the above copyright notice, this list of conditions and the following disclaimer.
2. Redistributions in binary form must reproduce the above copyright notice, this list of conditions and the following disclaimer in the documentation and/or other materials provided with the distribution.
3. All advertising materials mentioning features or use of this software must display the following acknowledgment: "This product includes software developed by the OpenSSL Project for use in the OpenSSL Toolkit. (<http://www.openssl.org/>)"
4. The names "OpenSSL Toolkit" and "OpenSSL Project" must not be used to endorse or promote products derived from this software without
5. prior written permission. For written permission, please contact [openssl-core@openssl.org](mailto:openssl-core@openssl.org).
6. Products derived from this software may not be called "OpenSSL" nor may "OpenSSL" appear in their names without prior written permission of the OpenSSL Project.
7. Redistributions of any form whatsoever must retain the following acknowledgment: "This product includes software developed by the OpenSSL Project for use in the OpenSSL Toolkit (<http://www.openssl.org/>)"

THIS SOFTWARE IS PROVIDED BY THE OpenSSL PROJECT "AS IS" AND ANY EXPRESSED OR IMPLIED WARRANTIES, INCLUDING, BUT NOT LIMITED TO, THE IMPLIED WARRANTIES OF MERCHANTABILITY AND FITNESS FOR A PARTICULAR PURPOSE ARE DISCLAIMED. IN NO EVENT SHALL THE OpenSSL PROJECT OR ITS CONTRIBUTORS BE LIABLE FOR ANY DIRECT, INDIRECT, INCIDENTAL, SPECIAL, EXEMPLARY, OR CONSEQUENTIAL DAMAGES (INCLUDING, BUT NOT LIMITED TO, PROCUREMENT OF SUBSTITUTE GOODS OR SERVICES; LOSS OF USE, DATA, OR PROFITS; OR BUSINESS INTERRUPTION) HOWEVER CAUSED AND ON ANY THEORY OF LIABILITY, WHETHER IN CONTRACT, STRICT LIABILITY, OR TORT (INCLUDING NEGLIGENCE OR OTHERWISE) ARISING IN ANY WAY OUT OF THE USE OF THIS SOFTWARE, EVEN IF ADVISED OF THE POSSIBILITY OF SUCH DAMAGE.

This product includes cryptographic software written by Eric Young([ey@cryptsoft.com](mailto:ey@cryptsoft.com)). This product includes software written by Tim Hudson ([tjh@cryptsoft.com](mailto:tjh@cryptsoft.com)).

## ORIGINAL SSLEAY LICENSE

---

Copyright (C) 1995-1998 Eric Young ([ey@cryptsoft.com](mailto:ey@cryptsoft.com)) All rights reserved.

This package is an SSL implementation written by Eric Young ([ey@cryptsoft.com](mailto:ey@cryptsoft.com)). The implementation was written so as to conform with Netscapes SSL.

This library is free for commercial and non-commercial use as long as the following conditions are adhered to. The following conditions apply to all code found in this distribution, be it the RC4, RSA, lhash, DES, etc., code; not just the SSL code. The SSL documentation included with this distribution is covered by the same copyright terms except that the holder is Tim Hudson ([tjh@cryptsoft.com](mailto:tjh@cryptsoft.com)). Copyright remains Eric Young's, and as such any Copyright notices in the code are not to be removed. If this package is used in a product, Eric Young should be given attribution as the author of the parts of the library used. This can be in the form of a textual message at program startup or in documentation (online or textual) provided with the package.

Redistribution and use in source and binary forms, with or without modification, are permitted provided that the following conditions are met:

1. Redistributions of source code must retain the copyright notice, this list of conditions and the following disclaimer.
2. Redistributions in binary form must reproduce the above copyright notice, this list of conditions and the following disclaimer in the documentation and/or other materials provided with the distribution.
3. All advertising materials mentioning features or use of this software must display the following acknowledgement: "This product includes cryptographic software written by Eric Young ([ey@cryptsoft.com](mailto:ey@cryptsoft.com))" The word 'cryptographic' can be left out if the routines from the library being used are not cryptographic related:-).
4. If you include any Windows specific code (or a derivative thereof) from the apps directory (application code) you must include an acknowledgement: "This product includes software written by Tim Hudson ([tjh@cryptsoft.com](mailto:tjh@cryptsoft.com))"

THIS SOFTWARE IS PROVIDED BY ERIC YOUNG "AS IS" AND ANY EXPRESS OR IMPLIED WARRANTIES, INCLUDING, BUT NOT LIMITED TO, THE IMPLIED WARRANTIES OF MERCHANTABILITY AND FITNESS FOR A PARTICULAR PURPOSE ARE DISCLAIMED. IN NO EVENT SHALL THE AUTHOR OR CONTRIBUTORS BE LIABLE FOR ANY DIRECT, INDIRECT, INCIDENTAL, SPECIAL, EXEMPLARY, OR CONSEQUENTIAL DAMAGES (INCLUDING, BUT NOT LIMITED TO, PROCUREMENT OF SUBSTITUTE GOODS OR SERVICES; LOSS OF USE, DATA, OR PROFITS; OR BUSINESS INTERRUPTION) HOWEVER CAUSED AND ON ANY THEORY OF LIABILITY, WHETHER IN CONTRACT, STRICT LIABILITY, OR TORT (INCLUDING NEGLIGENCE OR OTHERWISE) ARISING IN ANY WAY OUT OF THE USE OF THIS SOFTWARE, EVEN IF ADVISED OF THE POSSIBILITY OF SUCH DAMAGE.

The licence and distribution terms for any publically available version or derivative of this code cannot be changed. i.e. this code cannot simply be copied and put under another distribution licence [including the GNU Public Licence.]

# 1 Introduction

Thank you for purchasing this Samsung multifunctional product. Your machine provides printing functions.

This chapter includes:

- **Special features**
- **Machine overview**
- **Control panel overview**



## Caution

- This product is high glossy. Please be careful of surface scratch during installation.

---

## Special features

---

Your new machine is equipped with special features.

### Print with excellent quality and speed



- You can print with a resolution of up to **1200 dpi class Effective output**.
- Your machine prints A4-sized paper at up to 16 ppm<sup>a</sup> letter-sized paper at up to 17 ppm.

### Handle different paper options with flexibility

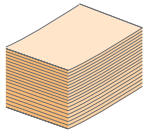

The **100-sheet tray** support plain paper in various sizes.

### Create professional documents

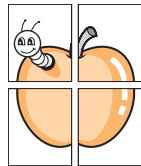

- Print **Watermarks**. You can customize your documents with words, such as "Confidential". See Software section.
- Print **Posters**. The text and pictures of each page of your document are magnified and printed across the sheet of paper and can then be taped together to form a poster. See Software section.

### Save time and money

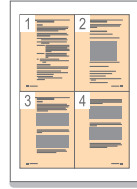

- To save paper, you can print multiple pages on one single sheet of paper.
- This machine automatically **conserves electricity** by substantially reducing power consumption when not in use.

### Print in various environments

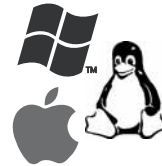

- You can print with various operating system such as Windows, Linux and Macintosh systems.
- Your machine is equipped with a **USB** interface.
- You can also use a network interface. Your machine comes with a built-in network interface, 10/100 Base TX and 802.11 b/g Wireless LAN.

---

a. pages per minute



## Machine overview

These are the main components of your machine.

### Front view

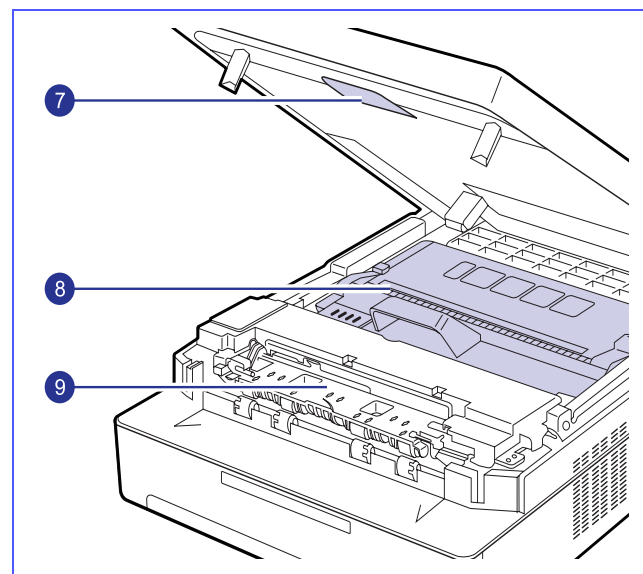
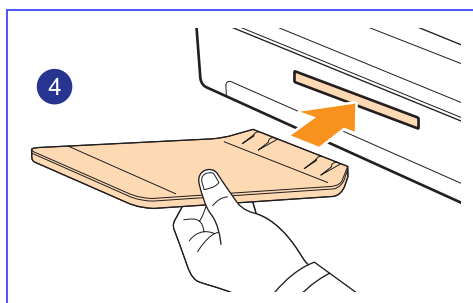
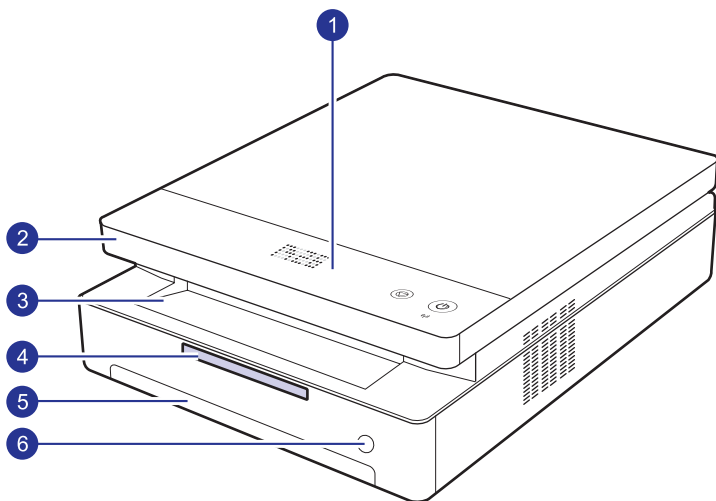

1	control panel	6	tray open button
2	top cover	7	top cover lever
3	output tray	8	toner cartridge
4	output support	9	inner cover
5	tray		



#### Note

- All illustrations on this user's guide may differ from your machine.
- The surface of the output tray may become hot if you print a large number of pages at once. Please make sure that you do not touch the surface, and do not allow children near it.



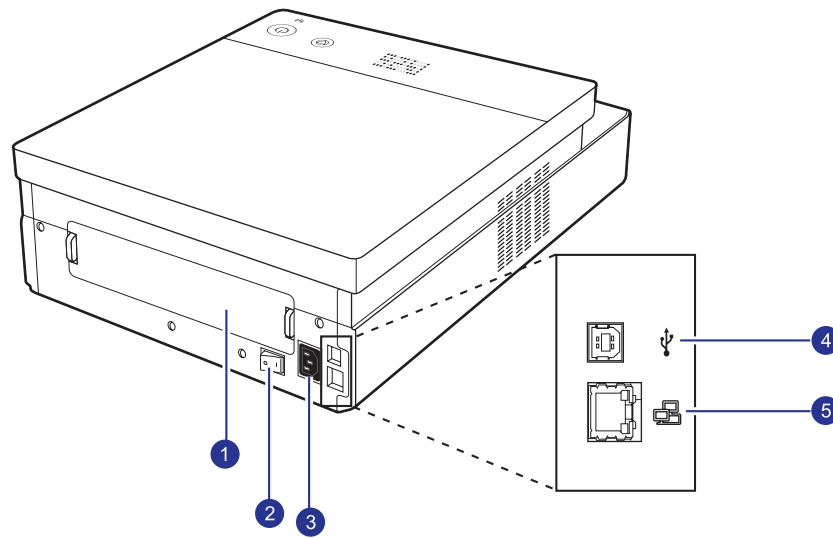

## Rear view

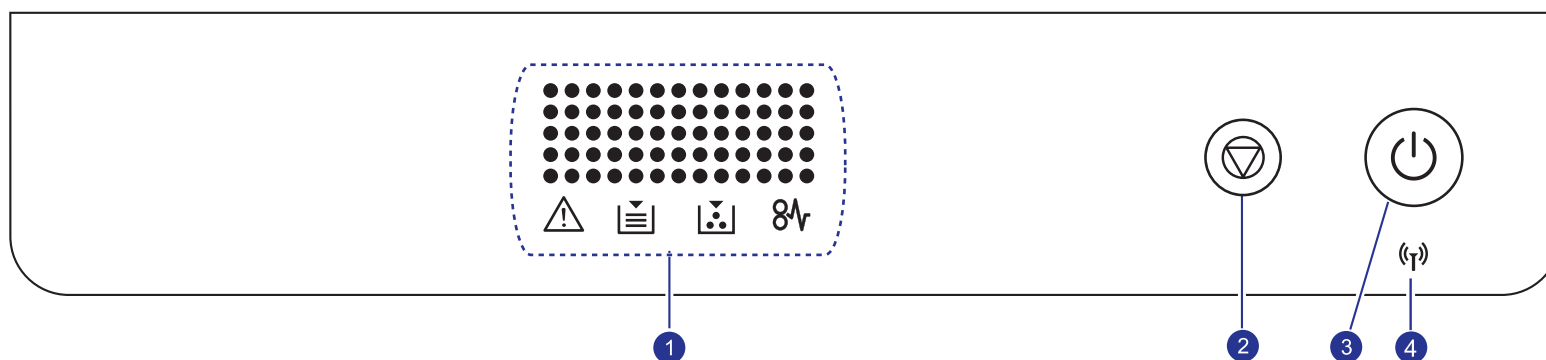

1	rear cover	4	USB port
2	power switch	5	Network port
3	power receptacle		

## Control panel overview



display	
1	<p>Shows the current status and prompts during an operation. The message shows with specific LEDs as below. LEDs are working with short message on a display.</p> <ul style="list-style-type: none"> <li>• error LED  Blinks when the error occurs on your machine. If it blinks rapidly, the machine has stopped for some reason. Check the display message to solve the problem.</li> <li>• paper LED  Blinks when the paper in the tray is empty.</li> <li>• toner LED  Blinks when the estimated cartridge life of toner is close, or toner cartridge is invalid. Check the display message and replace the toner cartridge.</li> <li>• paper jam LED  Lights blink when there is a paper jam in the machine. Check the display message to release the jammed paper.</li> </ul> <p>See page 7.7 about more information on the display messages.</p>
2	Stops an operation at any time. Also, You can print a machine report by pressing this button for about 4 seconds.
3	You can power on or off the control panel by pressing and holding this button for a few seconds.
4	Shows the status of wireless network. When the LED on, the machine is ready.



## 2 Software overview

This chapter gives you an overview of the software that comes with your machine. Further details on how to use the software are explained in the Software section.

This chapter includes:

- **Supplied software**
- **Printer driver features**
- **System requirements**

### Supplied software

After you have set up your machine and connected it to your computer, you must install the printer software. If you are a Windows or Macintosh OS, install the software from the supplied CD and if you are a Linux OS user, download the software from the Samsung website ([www.samsung.com/printer](http://www.samsung.com/printer)) and install.:

OS	Contents
Windows	<ul style="list-style-type: none"><li>• <b>Printer driver:</b> Use this driver to take full advantage of your machine's features.</li><li>• <b>Smart Panel:</b> This program allows you to monitor the machine's status and alerts you when an error occurs during printing.</li><li>• <b>SetIP:</b> Use this program to set your machine's TCP/IP addresses.</li><li>• User's Guide in PDF</li></ul>
Linux	<ul style="list-style-type: none"><li>• <b>Linux printer driver:</b> Use this driver to run your machine from a Linux computer and print documents.</li><li>• <b>SetIP:</b> Use this program to set your machine's TCP/IP addresses.</li></ul>
Macintosh	<ul style="list-style-type: none"><li>• <b>Macintosh printer driver:</b> Use this driver to run your machine from a Macintosh computer and print documents.</li><li>• <b>Smart Panel:</b> This program allows you to monitor the machine's status and alerts you when an error occurs during printing.</li><li>• <b>SetIP:</b> Use this program to set your machine's TCP/IP addresses.</li></ul>

## Printer driver features

Your printer drivers support the following standard features:

- Paper size, orientation and media type
- Number of copies

In addition, you can use various special printing features. The following table shows a general overview of features supported by your printer drivers:

Feature	Windows	Linux	Macintosh
Machine quality option	O	O	O
Poster printing	O	X	X
Multiple pages per sheet (N-up)	O	O (2, 4)	O
Fit to page printing	O	X	O <sup>a</sup>
Scale printing	O	X	O
Watermark	O	X	X
Overlay	O	X	X

a. This feature is supported only MAC OS X 10.4 ~ 10.6.

## System requirements

Before you begin, ensure that your system meets the following requirements:

### Windows

Your machine supports the following Windows operating systems.

OPERATING SYSTEM	REQUIREMENT (RECOMMENDED)		
	CPU	RAM	FREE HDD SPACE
<b>Windows 2000</b>	Pentium II 400 MHz (Pentium III 933 MHz)	64 MB (128 MB)	600 MB
<b>Windows XP</b>	Pentium III 933 MHz (Pentium IV 1 GHz)	128 MB (256 MB)	1.5GB
<b>Windows Server 2003</b>	Pentium III 933 MHz (Pentium IV 1 GHz)	128 MB (512 MB)	1.25 GB to 2 GB
<b>Windows Server 2008</b>	Pentium IV 1 GHz (Pentium IV 2 GHz)	512 MB (2048 MB)	10 GB
<b>Windows Vista</b>	Pentium IV 3 GHz	512 MB (1024 MB)	15 GB

OPERATING SYSTEM	REQUIREMENT (RECOMMENDED)		
	CPU	RAM	FREE HDD SPACE
<b>Windows 7</b>	Pentium IV 1 GHz 32-bit or 64-bit processor or higher	1 GB (2 GB)	16 GB
	<ul style="list-style-type: none"> <li>• Support for DirectX 9 graphics with 128 MB memory(to enable the Aero theme).</li> <li>• DVD-R/W Drive</li> </ul>		
<b>Windows Server 2008 R2</b>	Pentium IV 1 GHz(x86) or 1.4GHz(x64) processors(2GHz or faster)	512 MB (2048 MB)	10 GB



### Note

- Internet Explorer 5.0 or higher is the minimum requirement for all Windows operating systems.
- Users who have an administrator right can install the software.

## Linux

Operating System	Requirements (recommended)		
	CPU	RAM	free HDD space
RedHat 8.0, 9.0 (32bit)	<ul style="list-style-type: none"> <li>• Pentium IV 2.4GHz (IntelCore2)</li> </ul>	<ul style="list-style-type: none"> <li>• 512 MB (1024 MB)</li> </ul>	<ul style="list-style-type: none"> <li>1 GB (2GB)</li> </ul>
RedHat Enterprise Linux WS 4, 5 (32/64bit)			
Fedora Core 1~7 (32/64bit)			
Mandrake 9.2 (32bit), 10.0, 10.1 (32/64bit) Mandriva 2005, 2006, 2007 (32/64bit)			
SuSE Linux 8.2, 9.0, 9.1 (32bit) SuSE Linux 9.2, 9.3, 10.0, 10.1, 10.2 (32/64bit)			
SuSE Linux Enterprise Desktop 9, 10 (32/64bit)			
Ubuntu 6.06, 6.10, 7.04 (32/64bit)			
Debian 3.1, 4.0 (32/64bit)			

Operating System	Requirements (recommended)		
	CPU	RAM	free HDD space
Mac OS X 10.6	<ul style="list-style-type: none"> <li>• Intel processors</li> </ul>	1 GB (2 GB)	1 GB

## Macintosh

Operating System	Requirements (recommended)		
	CPU	RAM	free HDD space
Mac OS X 10.3 ~ 10.4	<ul style="list-style-type: none"> <li>• Intel Processor</li> <li>• Power PC G4 /G5</li> </ul>	<ul style="list-style-type: none"> <li>• 128 MB for a Power-PC based Mac (512 MB).</li> <li>• 512 MB for an Intel-based Mac (1 GB)</li> </ul>	1 GB
Mac OS X 10.5	<ul style="list-style-type: none"> <li>• Intel Processor</li> <li>• 867 MHz or faster Power PC G4 /G5</li> </ul>	<ul style="list-style-type: none"> <li>• 512 MB (1 GB)</li> </ul>	1 GB

# 3 Getting Started

This chapter gives you step-by-step instructions for setting up the machine.

This chapter includes:

- **Setting up the hardware**
- **Setting up the network**
- **Using a wired network**
- **Using a wireless network**
- **Altitude adjustment**

## Setting up the hardware

This section shows the steps to set up the hardware which is explained in the Quick Install Guide. Make sure you read Quick Install Guide and complete following steps.

- 1 Select a stable location.

Select a level, stable place with adequate space for air circulation. Allow extra space to open covers and trays.

The area should be well-ventilated and away from direct sunlight or sources of heat, cold, and humidity. Do not set the machine close to the edge of your desk or table.

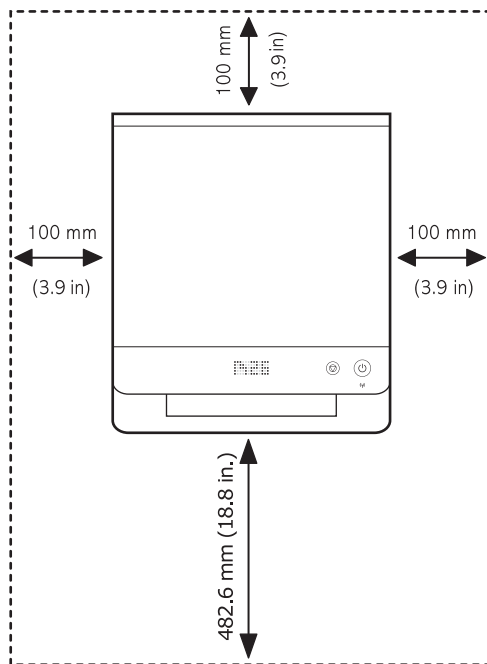

Printing is suitable for altitudes under 1,000 m (3,281 ft). Refer to the altitude setting to optimize your printing. See page 3.9 for more information.

Place the machine on a flat and stable surface for not letting it lean more than 2 mm (0.08 inches). Otherwise, it may affect the printing quality.

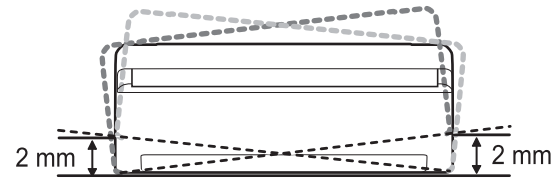

- 2 Unpack the machine and check all the enclosed items.
- 3 Remove the tape holding the machine tightly.
- 4 Install both the toner cartridge.
- 5 Load paper. (See "Loading paper in the tray" on page 4.5.)
- 6 Make sure that all the cables are connected to the machine.
- 7 Turn the machine on.
- 8 Install the software. See Software section.



### Caution

This equipment will be inoperable when mains power fails.



### Note

When the printer driver is in installation process, the driver installer detects the locale information of your operating system, and sets the default paper size for your machine. If you use the different Windows locale, you must change the paper size of your machine for matching your commonly used paper size. Go to the printer properties to change the paper size after installation completes.



### Caution

When you move the machine, do not tilt or turn it upside down. Otherwise, the inside of the machine may be contaminated by toner, which can cause damage to the machine or bad printing quality.



5 Kg (11 lbs)

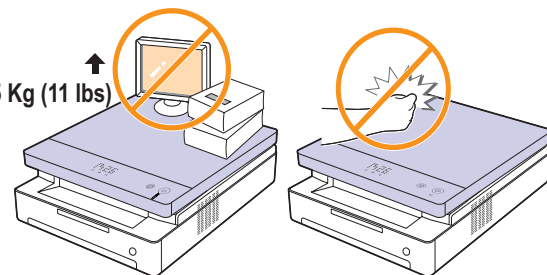

---

## Setting up the network

---

You need to set up the network protocols on the machine (;printer) to use it in the network environment. If you use your machine in the wired network, refer to 'Using a wired network'. If you use your network printer in the wireless network, refer to See "Using a wireless network" on page 3.4.



### Note

If you want to use the USB cable, connect the cable between a computer and you machine. Then, refer to the software installation in Software section.

## Supported network environments

The following table shows the network environments supported by the machine:

Item	Requirements
Network interface	10/100 Base-TX 802.11 b/g Wireless LAN
Network operating system	Windows 2000/XP/2003/2008/Vista/7/Server 2008 R2 Various Linux OS Macintosh Mac OS 10.3 ~ 10.6
Network protocols	TCP/IP, Standard TCP/IP, LPR, IPP/ HTTP, Bonjour, DHCP, BOOTP

---

## Using a wired network

---

You must set up the network protocols on your printer to use it on your network. This chapter will show you how this is easily accomplished.

## Printing Configuration report

Press and hold **Stop/Clear** button for about 4 seconds to print a machine report.

Please review your machines User's Guide to learn of additional details. Using this **Network Configuration Report**, you can find your machine MAC address and IP address.

For example:

MAC Address : 00:15:99:41:A2:78  
IP Address : 192.0.0.192

## Setting IP address

Firstly, you have to set up an IP address for network printing and managements. In most cases a new IP address will be automatically

assigned by a DHCP (Dynamic Host Configuration Protocol Server) located on the network.

In a few situations the IP address must be set manually. This is called a static IP and is often required in corporate Intranets for security reasons.

- **DHCP IP assignment:** Connect your machine to the network, and wait a few minutes for the DHCP server to assign an IP address to the machine. Then, print the Network Configuration Report as explained above. If the report shows that the IP address has changed, the assignment was successful. You will see the new IP address on the report.
- **Static IP assignment:** Use SetIP program to change the IP address from your computer.

In an office environment, we recommend that you contact a network administrator to set this address for you.

## IP setting using the SetIP program

The following procedure is based on Windows XP.

This program is for manually setting the network IP address of your machine using its MAC address to communicate with the machine. MAC address is a hardware serial number of the network interface and can be found in the Network Configuration Report.



### Note

- You only need to run this program if your network requires a static IP address. Otherwise, you may proceed to the Configuring the machine's wireless network part of this document. If you are unsure of this requirement ask the system administrator or the person who has set up your local network.
- You can only use the SetIP program when your machine is connected to a network or directly connected to a PC with the crossover network cable included with your machine. In most cases we recommend using the crossover cable. You will be asked to connect this cable in a moment.

## Installing the program

- 1 Insert the driver CD provided along with your machine. When the driver CD runs automatically, close the window.
- 2 Start Windows Explorer and open the X drive. (X represents your CD-ROM drive.)
- 3 Double click **Application > SetIP**.
- 4 Double click **Setup.exe** to install this program.
- 5 Click **OK**.  
If necessary, select a language from the drop-down list.
- 6 Follow the instruction on the window to complete the installation.

## Starting the program

- 1 Connect your machine and the computer using crossover network cable.

- Temporarily disable the computer firewall before continuing by doing the following:

Window XP	Macintosh OS
<ul style="list-style-type: none"> <li>Open <b>Control Panel</b>.</li> <li>Double click <b>Security Center</b>.</li> <li>Click <b>Windows Firewall</b>.</li> <li>Disable the firewall.</li> </ul>	<ul style="list-style-type: none"> <li>Open <b>System Preferences</b>.</li> <li>Click <b>Sharing</b>.</li> <li>Click the <b>Firewall</b> menu.</li> <li>Turn firewall off.</li> </ul>

- From the Windows Start menu, select **All Programs > Samsung Network Printer Utilities > SetIP > SetIP**.
- Click on the  icon (third from left) in the SetIP window to open the TCP/IP configuration window.
- Enter the machine's new information into the configuration window as follows:

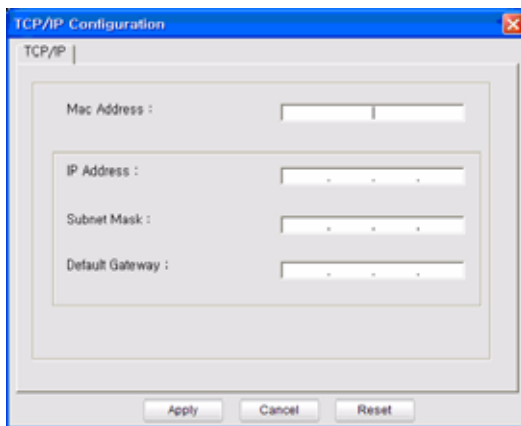

- MAC Address:** Find the machine's MAC address from the Network Configuration Report and enter it without the colons. For example, 00:15:99:29:51:A8 becomes 0015992951A8.



#### Note

MAC address is a hardware serial number of the machine's network interface and can be found in on the **Network Configuration Report**.

- IP Address:** Enter a new IP address for your printer the same as the computer's IP address except for the last number. For example, if your computer's IP address is 192.168.1.150, enter 192.168.1.X. (X is number between 1 and 254 other than the computer's address.)
  - Subnet Mask:** Enter this exactly the same as the computer's Subnet Mask.
  - Default Gateway:** Enter this exactly the same as the computer's Default Gateway.
- Click **Apply**, and then click **OK**. The machine will automatically print the Configuration report. Confirm that all the settings are correct.
  - Click **Exit** to close the SetIP program.
  - If necessary, restart the computer's firewall.

## Network parameter setting

You can also set up the various network settings through the network administration programs.

- SyncThru™ Web Admin Service:* Web-based printer management solution for network administrators. *SyncThru™ Web Admin Service* provides you with an efficient way of managing network devices and lets you remotely monitor and troubleshoot network machines from any site with corporate internet access. Download this program from <http://solution.samsungprinter.com>.
- SyncThru™ Web Service:* Web server embedded on your network print server, which allows you to: (A) Configure the network parameters necessary for the machine to connect to various network environments. (B) Customize machine settings.

## Installing the software

You must install the printer driver software for printing. The software includes drivers, applications, and other user friendly programs.



#### Note

The following procedure is based on Windows XP. The procedure and popup window which appears during the installation may differ depending on the operating system, machine features, or the interface in use.

Make sure that the network setup for your machine is completed. (See "Setting up the network" on page 3.2.) All applications should be closed on your computer before beginning the installation.

If your IP assignment method is DHCP and IP address can be changed whenever machine is turned on, we recommend you to use the **Bonjour** program. Go to the <http://developer.apple.com/networking/bonjour/download/>, select the program **Bonjour** for Windows according to your computer operating system, and install the program. In case of Mac OS X, this program might be already installed in your PC. This program will allow you to fix the network parameter automatically. This **Bonjour** program does not support Linux.

If your IP assignment method is static, follow the steps below.

- Insert the Printer Software CD-ROM into your CD-ROM drive. The CD-ROM should automatically run, and an installation window appears.
- Click **Next**.  
  
If the installation window does not appear, click **Start > Run**. Type X:\Setup.exe, replacing "X" with the letter which represents your drive and click **OK**.  
  
If you use Windows Vista, Windows 7 and Windows Server 2008 R2, click **Start > All Programs > Accessories > Run**, and type X:\Setup.exe.
- Select **Typical installation for a network printer**, and then click **Next**.



#### Note

The installation window may slightly differ, if you are reinstalling the driver.

- 4 The list of machines available on the network appears. Select the printer you want to install from the list and then click **Next**.



#### Note

•If you do not see your machine on the list, click **Update** to refresh the list, or select **Add TCP/IP Port** to add your machine to the network. To add the machine to the network, enter the port name and the IP address for the machine.

•To verify your machine's IP address or the MAC address, print a Network Configuration Report page.

5After the installation is finished, a window appears asking you to print a test page and to register yourself as a user of Samsung machines in order to receive information from Samsung. If you so desire, select the corresponding checkbox(es) and click **Finish**.



#### Note

If your machine does not work properly after the installation, try to reinstall the printer driver. See Software section.

---

## Using a wireless network

---

You must set up the network protocols on your machine to use it on your network. This chapter will show you how this is easily accomplished.

Before starting, please locate the crossover network cable and the Printer Software Installation CD-ROM provided with your machine (;printer). You may need to contact a network administrator or the person who has set up your wireless network for information regarding the configuration.

If you are already aware of your machine's IP address configuration and this IP address is available, you may go to **Configuring the machine's wireless network** part directly. Otherwise you have to follow all steps from **Checking your Network Environments** part.

## Checking your Network Environments

### IP address

Every device in a network is identified by a unique numerical address called an IP Address. Your machine came with a default IP address of 192.0.0.192, and you can verify this by printing out a Network Configuration Report. In most cases a new IP address will be automatically assigned by a DHCP (Dynamic Host Configuration Protocol Server) located on the network.

In a few situations the IP address must be set manually. This is called a static IP and is often required in corporate Intranets for security reasons. We have provided an easy to use utility program on the Printer Software CD-ROM named SetIP that can change the address for you.

In an office environment, we recommend that you contact a network administrator to set this address for you.

## Wireless Networks

- **Infrastructure mode:** An Infrastructure mode network is the most common wireless network configuration in a home or office consisting of a wireless router, or an access point, that connects all the computers and other networked devices into a common local area network (LAN).

The access point provides a special high speed connection to a Cable or DSL modem or other wide area network (WAN) device that connects the LAN to the Internet or a Corporate Intranet. Most Infrastructure mode networks use a DHCP Server to automatically assign the IP address and set other network parameters. If you know

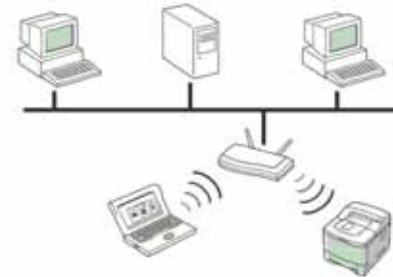

that you are connecting to an Infrastructure mode network with an access point, and the IP address is assigned by a DHCP server, you may proceed to the **Configuring the machine's wireless network** part after reviewing the following parts on printing a **Network Configuration Report**.

If you know that you are connecting to an Infrastructure mode network with an access point, but it does not have DHCP address assignment, or you are required to set a static IP, proceed to the **Setting IP address** part before going to **Configuring the machine's wireless network** part after reviewing the following parts on printing a **Network Configuration Report**.

- **Ad-hoc mode :** An Ad-hoc mode network provides peer to peer communication. In an Ad-hoc mode network, wireless devices and computers communicate directly with each other, without using an access point. They can share files and machines, but may not be able to access the Internet. The machine receives print jobs from wireless computers directly.



If you know that you are connecting to an ad-hoc mode network without an access point, proceed to the **Setting IP address** part before going to **Configuring the machine's wireless network** part after reviewing the following parts on printing a **Network Configuration Report**.



## Printing Configuration report

Press and hold **Stop/Clear** button for about 4 seconds to print a machine report.

Please review your machines User's Guide to learn of additional details. Using this **Network Configuration Report**, you can find your machine MAC address and IP address.

For example:

MAC Address : 00:15:99:41:A2:78  
IP Address : 192.0.0.192

## Setting IP address

Firstly, you have to set up an IP address for network printing and managements. In most cases a new IP address will be automatically assigned by a DHCP (Dynamic Host Configuration Protocol Server) located on the network.

In a few situations the IP address must be set manually. This is called a static IP and is often required in corporate Intranets for security reasons.

- **DHCP IP assignment:** Connect your machine to the network, and wait a few minutes for the DHCP server to assign an IP address to the machine. Then, print the Network Configuration Report as explained above. If the report shows that the IP address has changed, the assignment was successful. You will see the new IP address on the report.
- **Static IP assignment:** Use SetIP program to change the IP address from your computer.

In an office environment, we recommend that you contact a network administrator to set this address for you.

## IP setting using the SetIP program

The following procedure is based on Windows XP.

This program is for manually setting the network IP address of your machine using its MAC address to communicate with the machine. MAC address is a hardware serial number of the network interface and can be found in the Network Configuration Report.



### Note

- You only need to run this program if your network requires a static IP address. Otherwise, you may proceed to the Configuring the machine's wireless network part of this document. If you are unsure of this requirement ask the system administrator or the person who has set up your local network.
- You can only use the SetIP program when your machine is connected to a network or directly connected to a PC with the crossover network cable included with your machine. In most cases we recommend using the crossover cable. You will be asked to connect this cable in a moment.

## Installing the program

- 1 Insert the driver CD provided along with your machine. When the driver CD runs automatically, close the window.

- 2 Start Windows Explorer and open the X drive. (X represents your CD-ROM drive.)
- 3 Double click **Application > SetIP**.
- 4 Double click **Setup.exe** to install this program.
- 5 Click **OK**.  
If necessary, select a language from the drop-down list.
- 6 Follow the instruction on the window to complete the installation.

## Starting the program

- 1 Connect your machine and the computer using crossover network cable.
- 2 Temporarily disable the computer firewall before continuing by doing the following:

Window XP	Macintosh OS
<ul style="list-style-type: none"><li>• Open <b>Control Panel</b>.</li><li>• Double click <b>Security Center</b>.</li><li>• Click <b>Windows Firewall</b>.</li><li>• Disable the firewall.</li></ul>	<ul style="list-style-type: none"><li>• Open <b>System Preferences</b>.</li><li>• Click <b>Sharing</b>.</li><li>• Click the <b>Firewall</b> menu.</li><li>• Turn firewall off.</li></ul>

- 3 From the Windows Start menu, select **All Programs > Samsung Network Printer Utilities > SetIP > SetIP**.
- 4 Click on the  icon(third from left) in the SetIP window to open the TCP/IP configuration window.
- 5 Enter the machine's new information into the configuration window as follows:

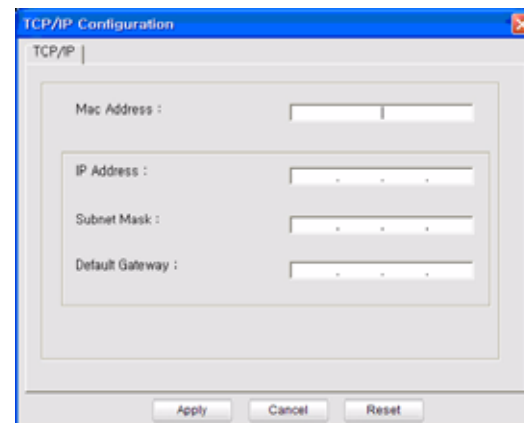

- **MAC Address:** Find the machine's MAC address from the Network Configuration Report and enter it without the colons. For example, 00:15:99:29:51:A8 becomes 0015992951A8.



### Note

MAC address is a hardware serial number of the machine's network interface and can be found in on the **Network Configuration Report**.



- **IP Address:** Enter a new IP address for your printer the same as the computer's IP address except for the last number. For example, if your computer's IP address is 192.168.1.150, enter 192.168.1.X. (X is number between 1 and 254 other than the computer's address.)
  - **Subnet Mask:** Enter this exactly the same as the computer's Subnet Mask.
  - **Default Gateway:** Enter this exactly the same as the computer's Default Gateway.
- 6 Click **Apply**, and then click **OK**. The machine will automatically print the Configuration report. Confirm that all the settings are correct.
  - 7 Click **Exit** to close the SetIP program.
  - 8 If necessary, restart the computer's firewall.

## Network parameter setting

You can also set up the various network settings through the network administration programs.

- *SyncThru™ Web Admin Service:* Web-based printer management solution for network administrators. *SyncThru™ Web Admin Service* provides you with an efficient way of managing network devices and lets you remotely monitor and troubleshoot network machines from any site with corporate internet access. Download this program from <http://solution.samsungprinter.com>.
- *SyncThru™ Web Service:* Web server embedded on your network print server, which allows you to: (A) Configure the network parameters necessary for the machine to connect to various network environments. (B) Customize machine settings.

## Restoring factory default settings

You can restore factory default settings to the machine by using *SyncThru™ Web Service*. You may need to reset the machine to the factory default settings when machine that you are using is connected to new network environment.

### Restoring factory default settings using SyncThru™ Web Service

- 1 Start a web browser such as Internet Explorer, Safari or Firefox and enter your machine's new IP address in the browser window. For example,

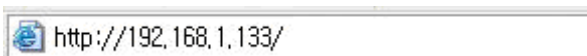

- 2 When the *SyncThru™ Web Service* window opens, click **Network Settings**.

- 3 Click **Reset**. Then, click **Clear** for network.

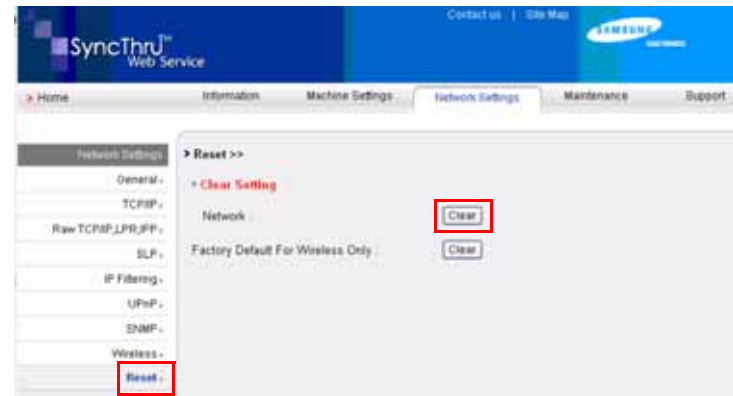

- 4 Turn off and restart machine to apply settings.

## Configuring the machine's wireless network

Before starting you will need to know the SSID of your wireless network and the Network Key if it is encrypted. This information was set when the access point was installed. If you do not know about your wireless environment, please ask the person who has set up your network.

### Using SyncThru™ Web Service

Before starting wireless parameter configuration, make sure cable connection status.

- 1 Start a web browser such as Internet Explorer, Safari or Firefox and enter your machine's new IP address in the browser window. For example,

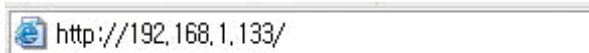

- 2 When the *SyncThru™ Web Service* window opens, click **Network Settings**.
- 3 Click **Wireless** and Select **Wizard**. Then, click **Next**.



#### Note

**Wizard** will help you setup the wireless network configuration. However, if you want to set the wireless network directly, select **Custom**.

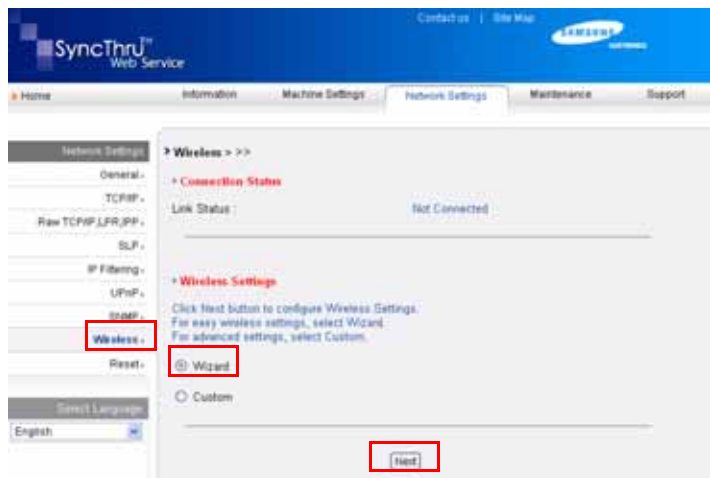

- 4 Select the one **Network Name(SSID)** in the list.

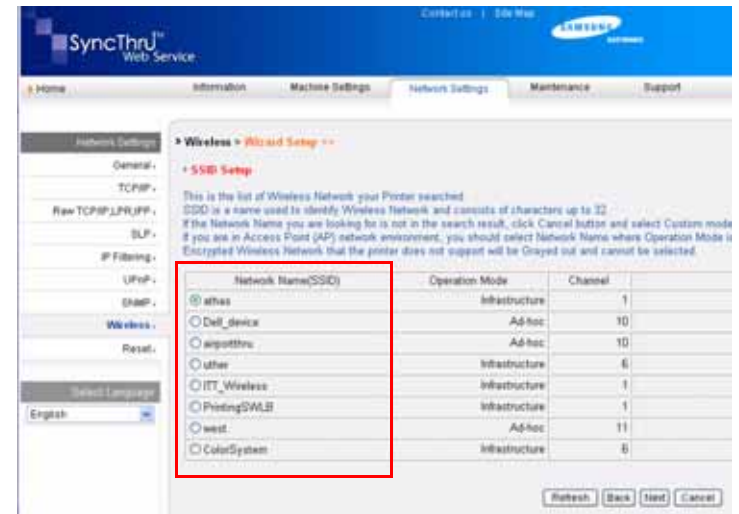

- **SSID:** SSID(Service Set Identifier) is a name that identifies a wireless network. Access points and wireless devices attempting to connect to a specific wireless network must use the same SSID. The SSID is case-sensitive.
- **Operation Mode:** **Operation Mode** refers to the type of wireless connections.
  - **Ad-hoc:** allows wireless devices to communicate directly with each other in a peer-to-peer environment.
  - **Infrastructure:** allows wireless devices to communicate with each other through an access point.



#### Note

If your network's operation mode is **Infrastructure**, select the **SSID** of the access point. If the operation mode is **Ad-hoc**, select the machine's **SSID**. Note that "airporthru" is the default **SSID** of your machine.

5 Click **Next**.

If wireless security setting window appears, enter the registered password (network key) and click **Next**.

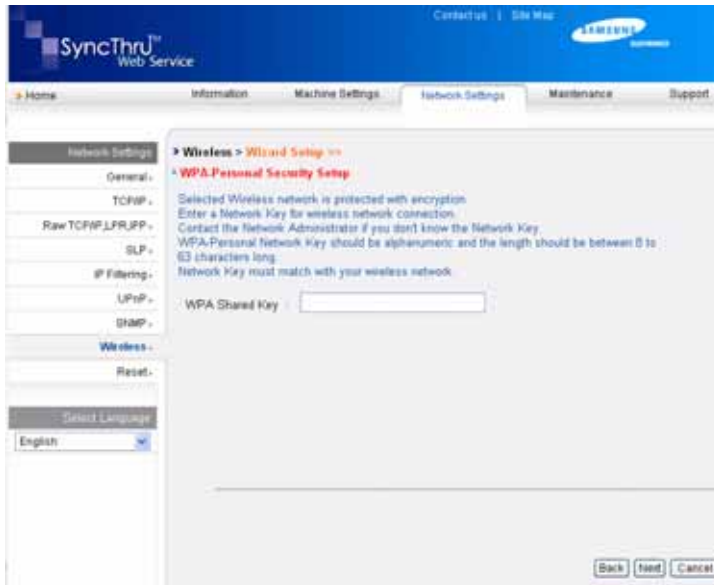

6 **Wizard Setup Confirmation** window appears, please check your wireless setup. If the setup is right, click **Apply**.

7 Click **OK**.



**Note**

- Disconnect the network cable (standard or crossover). Your machine should then start communicating wirelessly with the network. In case of **Ad-hoc** mode, you can use a wireless LAN and wired LAN simultaneously.
- If **Operation Mode** is **Infrastructure**, you must disconnect the network cable to activate wireless network after completing the network setting.

Now go to Installing the software.

## Installing the software

You must install the printer driver software for printing. The software includes drivers, applications, and other user friendly programs.



**Note**

The following procedure is based on Windows XP. The procedure and popup window which appears during the installation may differ depending on the operating system, machine features, or the interface in use.

Make sure that the network setup for your machine is completed. (See "Setting up the network" on page 3.2.) All applications should be closed on your computer before beginning the installation.

If your IP assignment method is DHCP and IP address can be changed whenever machine is turned on, we recommend you to use the **Bonjour** program. Go to the <http://developer.apple.com/networking/bonjour/download/>, select the program **Bonjour** for Windows according to your

computer operating system, and install the program. In case of Mac OS X, this program might be already installed in your PC. This program will allow you to fix the network parameter automatically. This **Bonjour** program does not support Linux.

If your IP assignment method is static, follow the steps below.

- 1 Insert the Printer Software CD-ROM into your CD-ROM drive. The CD-ROM should automatically run, and an installation window appears.

2 Click **Next**.

If the installation window does not appear, click **Start > Run**. Type **X:\Setup.exe**, replacing "X" with the letter which represents your drive and click **OK**.

If you use Windows Vista, Windows 7 and Windows Server 2008 R2, click **Start > All Programs > Accessories > Run**, and type **X:\Setup.exe**.



**Note**

The installation window may slightly differ, if you are reinstalling the driver.

- 3 Select **Typical installation for a network printer**, and then click **Next**.

- 4 The list of machines available on the network appears. Select the printer you want to install from the list and then click **Next**.



**Note**

•If you do not see your machine on the list, click **Update** to refresh the list, or select **Add TCP/IP Port** to add your machine to the network. To add the machine to the network, enter the port name and the IP address for the machine.

•To verify your machine's IP address or the MAC address, print a Network Configuration Report page. (See "Printing a machine report" on page 8.1.)

- 5 After the installation is finished, a window appears asking you to print a test page and to register yourself as a user of Samsung machines in order to receive information from Samsung. If you so desire, select the corresponding checkbox(es) and click **Finish**.



**Note**

If your machine does not work properly after the installation, try to reinstall the printer driver. See Software section.

---

## Altitude adjustment

---

The print quality is affected by atmospheric pressure, which is determined by the height of the machine above sea level. The following information will guide you on how to set your machine to the best print quality or best quality of print.

The altitude above 1,000 m (3,281 ft), may affect the print quality such as loose toner or light imaging.

Before you set the altitude setting, find the altitude where you are using the machine.

To set the machine for high altitude, follow next step:



### Note

The following procedure is for Windows XP. For other Windows OS, refer to the corresponding Windows User's Guide or online help.

- 1 Click the Windows **Start** menu.
- 2 Select **Printers and Faxes**.
- 3 Select **Samsung ML-1630W Series** icon.
- 4 Right-click on the printer driver icon and select **Properties**.
- 5 Click the **Printer** tab and select the **High Altitude Correction**.
- 6 Click **OK**.

# 4 Selecting and loading print media

This chapter introduces you how to load originals and print media into your machine.

This chapter includes:

- **Selecting print media**
- **Loading paper in the tray**
- **Setting the paper size and type**

---

## Selecting print media

---

You can print on a variety of print media, such as plain paper, labels, and transparencies. Always use print media that meet the guidelines for use with your machine. Print media that does not meet the guidelines outlined in this user's guide may cause the following problems:

- Poor print quality
- Increased paper jams
- Premature wear on the machine.

Properties, such as weight, composition, grain, and moisture content, are important factors that affect the machine's performance and the output quality. When you choose print materials, consider the following:

- The type, size and weight of the print media for your machine are described later in this section.
- Desired outcome: The print media you choose should be appropriate for your project.
- Brightness: Some print media are whiter than others and produce sharper, more vibrant images.
- Surface smoothness: The smoothness of the print media affects how crisp the printing looks on the paper.



### Note

- Some print media may meet all of the guidelines in this section and still not produce satisfactory results. This may be the result of improper handling, unacceptable temperature and humidity levels, or other variables over which Samsung has no control.
- Before purchasing large quantities of print media, ensure that it meets the requirements specified in this user's guide.



### Caution

Using print media that does not meet these specifications may cause problems, requiring repairs. Such repairs are not covered by Samsung's warranty or service agreements.

## Guidelines for selecting and storing print media

When selecting or loading paper, or other print materials, keep these guidelines in mind:

- Always use print media that conform with the specifications listed on page 4.3.
- Attempting to print on damp, curled, wrinkled, or torn paper can cause paper jams and poor print quality.
- For the best print quality, use only high quality copier grade paper specifically recommended for use in laser machines.
- Avoid using the following media types:
  - Paper with embossed lettering, perforations, or a texture that is too smooth or too rough
  - Erasable bond paper
  - Multi-paged paper
  - Synthetic paper and thermally reactive paper
  - Carbonless paper and Tracing paper.

Use of these types of paper could result in paper jams, chemical smells, and damage to your machine.

- Store print media in its ream wrapper until you are ready to use it. Place cartons on pallets or shelves, not on the floor. Do not place heavy objects on top of the paper, whether it is packaged or unpackaged. Keep it away from moisture or other conditions that can cause it to wrinkle or curl.
- Store unused print media at temperatures between 15 °C and 30 °C. The relative humidity should be between 10% and 70%.
- Store unused print media in a moisture-proof wrap, such as a plastic container or bag, to prevent dust and moisture from contaminating your paper.
- Load special media types one sheet at a time through the tray to avoid paper jams.
- To prevent print media, such as transparencies and label sheets, from sticking together, remove them as they print out.

## Specifications on print media



### Note

-  Due to the nature of the product, the envelope type of media cannot be used with your machine.
- Use the print media type mentioned below only.

Type	Size	Dimensions	Weight <sup>a</sup>	Capacity <sup>b</sup>
Plain paper	Letter	216 x 279 mm (8.5 x 11 inches)	60 to 120 g/m <sup>2</sup> (16 to 32 lb bond) for the tray	100 sheets of 75 g/m <sup>2</sup> (20 lb bond) paper for the tray
	A4	210 x 297 mm (8.26 x 11.69 inches)		
	JIS B5	182 x 257 mm (7.16 x 10.11 inches)		
	ISO B5	176 x 250 mm (6.93 x 9.84 inches)		
	A5	148 x 210 mm (5.82 x 8.26 inches)		
	A6	105 x 148 mm (4.13 x 5.82 inches)		
	Executive	184 x 267 mm (7.25 x 10.5 inches)		
Transparency <sup>c</sup>	Letter, A4	Refer to the Plain paper section	138 to 146 g/m <sup>2</sup> (37 to 39 lb bond)	1 sheet for the tray
Labels	Letter, A4	Refer to the Plain paper section	120 to 150 g/m <sup>2</sup> (32 to 40 lb bond)	1 sheet for the tray
Card stock	Letter, A4	Refer to the Plain paper section	60 to 120 g/m <sup>2</sup> (16 to 32 lb bond)	1 sheet for the tray
Minimum size (custom)		105 x 148 mm (4.13 x 5.83 inches)	60 to 120 g/m <sup>2</sup> (16 to 32 lb bond) for the tray	
Maximum size (custom)		216 x 297 mm (8.5 x 11.69 inches)		

a. If media weight is over 105 g/m<sup>2</sup> (28lb bond), load a paper into the tray one by one.

b. Maximum capacity may differ depending on media weight, thickness, and environmental conditions.

c. Recommended media: Transparency for a Laser Printers produced by HP, Xerox and 3M.



It is not recommended to use paperbacked transparencies such as Xerox 3R91334, which can cause a jam or be scratched.



### Note

- When you use the thick paper (90 to 120 g/m<sup>2</sup>, 24 to 32 lb bond), select **Thick Paper** in the paper type. See 4.6 page.
- When you use the thin paper (under 70 g/m<sup>2</sup>, under 19 lb bond), select **Thin Paper** in the paper type. See 4.6 page.
- When you use the recycled paper, select **Recycled Paper** in the paper type. See 4.6 page.

## Guidelines for special print media

Media type	Guidelines
Transparencies	<ul style="list-style-type: none"> <li>To avoid damaging the machine, use only transparencies designed for use in laser machines.</li> <li>Transparencies used in the machine must be able to withstand the machine's fusing temperature. Check your machine's specification to view the fusing temperature, see page 9.1.</li> <li>Place them on a flat surface after removing them from the machine.</li> <li>Do not leave them in the paper tray for long periods of time. Dust and dirt may accumulate on them, resulting in spotty printing.</li> <li>To avoid smudging caused by fingerprints, handle them carefully.</li> <li>To avoid fading, do not expose printed transparencies to prolonged sunlight.</li> <li>Ensure that transparencies are not wrinkled, curled, or have any torn edges.</li> </ul> <p><b>Caution</b>   Recommended media: Transparency for a Color Laser Printers produced by HP, Xerox and 3M. It is not recommended to use paperbacked transparencies such as Xerox 3R91334, which can cause a jam or be scratched.</p> <p><b>Note</b>   If your machine does not feed the transparency print media properly, put a blank sheet of paper under the transparency, and try again.</p>

Media type	Guidelines
Labels	<ul style="list-style-type: none"> <li>To avoid damaging the machine, use only labels designed for use in laser machines.</li> <li>When selecting labels, consider the following factors: <ul style="list-style-type: none"> <li>- Adhesives: The adhesive material should be stable at your machine's fusing temperature. Check your machine's specification to view the fusing temperature, see page 9.1.</li> <li>- Arrangement: Only use labels with no exposed backing between them. Labels can peel off sheets that have spaces between the labels, causing serious jams.</li> <li>- Curl: Prior to printing, labels must lie flat with no more than 13 mm of curl in any direction.</li> <li>- Condition: Do not use labels with wrinkles, bubbles, or other indications of separation.</li> </ul> </li> <li>Make sure that there is no exposed adhesive material between labels. Exposed areas can cause labels to peel off during printing, which can cause paper jams. Exposed adhesive can also cause damage to machine components.</li> <li>Do not run a sheet of labels through the machine more than once. The adhesive backing is designed for only a single pass through the machine.</li> <li>Do not use labels that are separating from the backing sheet or are wrinkled, bubbled, or otherwise damaged.</li> </ul>
Card stock or custom-sized materials	<ul style="list-style-type: none"> <li>Do not print on media smaller than 105 mm wide or 148 mm long.</li> <li>In the software application, set margins at least 6.4 mm away from the edges of the material.</li> </ul> <p><b>Note</b>   If you experience jams with card stock feeding, turn the paper around and try again.</p>
Preprinted paper	<ul style="list-style-type: none"> <li>Letterhead must be printed with heat-resistant ink that will not melt, vaporize, or release hazardous emissions when subjected to the printer's fusing temperature for 0.1 second. Check your machine's specification to view the fusing temperature, see page 9.1.</li> <li>Letterhead ink must be non-flammable and should not adversely affect printer rollers.</li> <li>Forms and letterhead should be sealed in a moisture-proof wrapping to prevent changes during storage.</li> <li>Before you load preprinted paper, such as forms and letterhead, verify that the ink on the paper is dry. During the fusing process, wet ink can come off preprinted paper, reducing print quality.</li> </ul>



## Loading paper in the tray

Load the print media you use for the majority of your print jobs in the tray. The tray can hold a maximum of 100 sheets of 75 g/m<sup>2</sup> (20 lb bond) plain paper.

- 1 Press the tray open button, then the tray pops out. Pull the tray completely out.

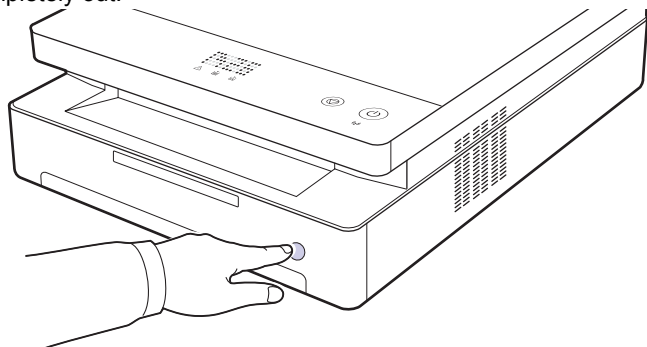

### Note

When the tray does not close properly, pull the tray half way out and try again.

- 2 Place paper with the side you want to print facing down.

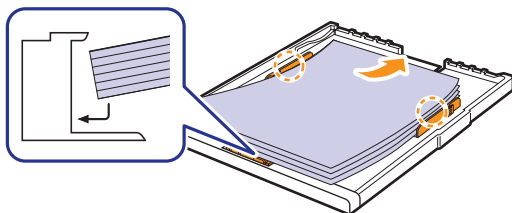

- 3 Align the tray with the slot, and slide it into the machine.

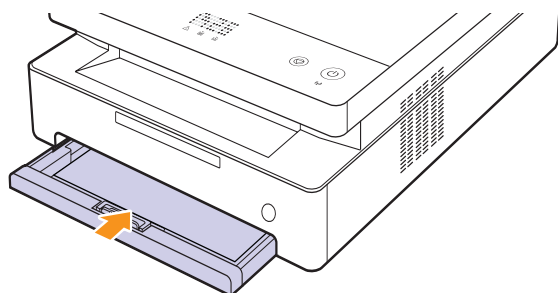

- 4 After loading paper, set the paper type and size for the tray. See Software section for PC-printing.



### Note

You can load previously printed paper. The printed side should be facing up with an uncurled edge at the rear. If you experience problems with paper feed, turn the paper around. Note that print quality is not guaranteed.

## Changing the paper size in the tray

To load different sizes of paper, such as custom-sized paper, you need to adjust the paper guides.

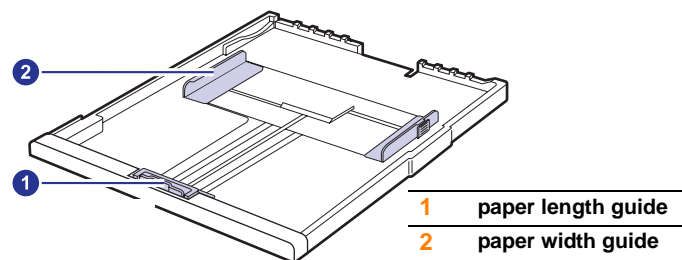

- 1 Adjust the paper length guide to the desired paper length. It is preset to Letter or A4 size depending on the country. To load another size, hold the lever and move the length guide to the corresponding position.

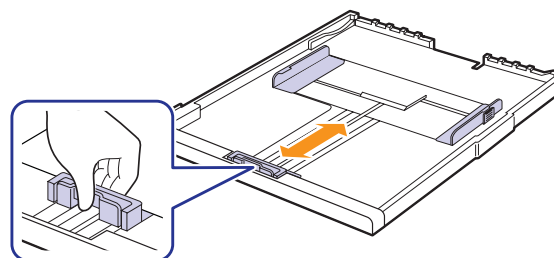

### Note

- The tray is preset to Letter or A4 size, depending on your country.
- For example, if you want to change the size to Letter, hold the lever at the back of the tray, and rotate the lever clockwise.

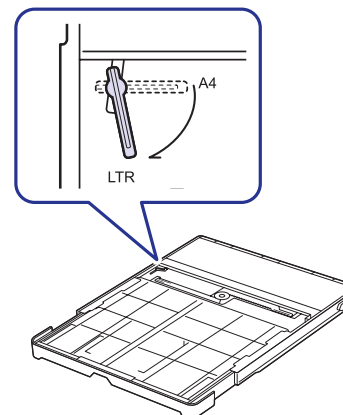

- 2 After inserting paper into the tray, while pinching the paper width guide as shown, move it toward the stack of paper until it lightly touches the side of the stack. Do not press the guide too tightly to the edge of the paper; the guide may bend the paper.

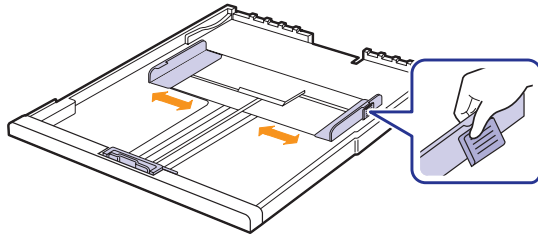

**Note**

- Do not push the paper width guides far enough to cause the materials to warp.
- If you do not adjust the paper width guides, it may cause paper jams.

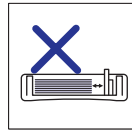
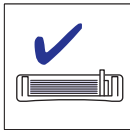

---

## Setting the paper size and type

---

The settings you change remain in effect only while you are using the current program. To make your changes permanent, make them in the Printers folder.



**Note**

The following procedure is for Windows XP. For other Windows OS, refer to the corresponding Windows User's Guide or online help.

- 1 Click the **Start** button on the computer screen.
- 2 Select **Printers and Faxes**.
- 3 Right-click on the printer driver icon and select **Printing Preferences**.
- 4 Click the **Paper** tab, and change the settings on **Paper Options**.
- 5 Click **OK**.

# 5 Basic printing

This chapter explains common printing tasks. Your machine allows you to print from various Windows, Macintosh, or Linux applications.



## Note

The following procedure is for Windows operating system. For Linux and Macintosh, see Software section.

---

## Printing a document

---

The exact steps for printing a document may vary depending on the application you use.

- 1 Open the document you want to print.
- 2 Select **Print** from the **File** menu. The Print window is displayed. It may look slightly different depending on your application.
- 3 Select your printer driver from the **Select Printer** list.
- 4 To start the print job, click **OK** or **Print** in the **Print** window.

For details about printing, see Software section.

---

## Canceling a print job

---

If the print job is waiting in a print queue or print spooler, such as the printer group in Windows, delete the job as follows:

- 1 Click the Windows **Start** menu.
- 2 For Windows 2000, select **Settings** and then **Printers**.  
For Windows XP/2003, select **Printers and Faxes**.  
For Windows Vista/2008, select **Control Panel > Hardware and Sound > Printers**.  
For Windows 7, select **Control Panel > Hardware and Sound > Devices and Printers**.  
For Windows Server 2008 R2, select **Control Panel > Hardware > Devices and Printers**.
- 3 For Windows 2000, XP, 2003, 2008 and Vista, double-click your machine.  
For Windows 7 and Windows Server 2008 R2, right click your printer icon > context menus > **See what's printing**.
- 4 From the **Document** menu, select **Cancel**.



## Note

You can also access this window by simply double-clicking the printer icon at the bottom right corner of the Windows desktop.

You can also cancel the current job by pressing  on the control panel.

# 6 Maintenance

This chapter provides information for maintaining your machine and the toner cartridge.

This chapter includes:

- **Printing a machine report**
- **Cleaning your machine**
- **Maintaining the cartridge**
- **Redistributing toner**
- **Replacing the toner cartridge**
- **Maintenance Parts**
- **Managing your machine from the website**

---

## Printing a machine report

---

Press and hold **Stop/Clear** button for about 4 seconds to print a machine report.

---

## Cleaning your machine

---

To maintain print quality, follow the cleaning procedures below each time the toner cartridge is replaced or if print quality problems occur.



### Caution

- Cleaning the machine cabinet with cleaning materials that contain large amounts of alcohol, solvent, or other strong substances can discolor or damage the cabinet.
- If your machine or its surrounding is contaminated with toner, we recommend you to use cloth or tissue dampened with water to clean it. If you use a vacuum cleaner, toner blows in the air and might be harmful for you.
- After cleaning, wipe the cabinet to remove any moisture.

## Cleaning the outside

Make sure to brush off the dirt on the cloth provided before cleaning the cabinet. Make sure to spray water 4 to 6 times onto the cloth provided, or another cloth suitable for this purpose before cleaning the cabinet, wiping in on direction.

## Cleaning the inside

During the printing process, paper, toner and dust particles can accumulate inside the machine. This buildup can cause print quality problems, such as toner specks or smearing. Cleaning the inside of the machine clears or reduces these problems. Contact a service representative to clean the parts inside the machine.

- 1 Press the top cover lever, completely open the top cover.

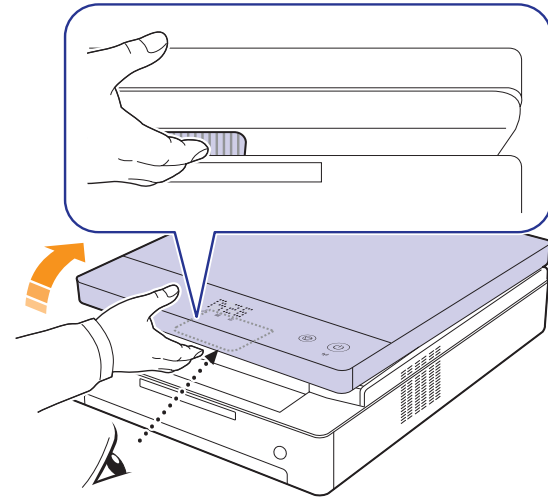

- 2 Grasp the handles on the toner cartridge and pull to remove the cartridge from the machine.

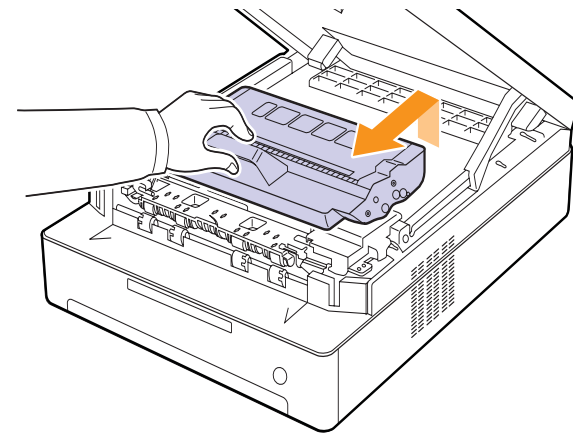

### Caution

- Do not touch the green surface, the OPC drum or the front of the toner cartridge, with your hands or any other material. Use the handle on each cartridge in order to avoid touching this area.
- If you leave the top cover open for more than a few minutes, the OPC drum can be exposed to light. This will cause damage to the OPC drum. Close the top cover should the installation need to be halted for any reason.

- 3 With a dry lint-free cloth, wipe away any dust and spilled toner from the toner cartridges area and their cavities.

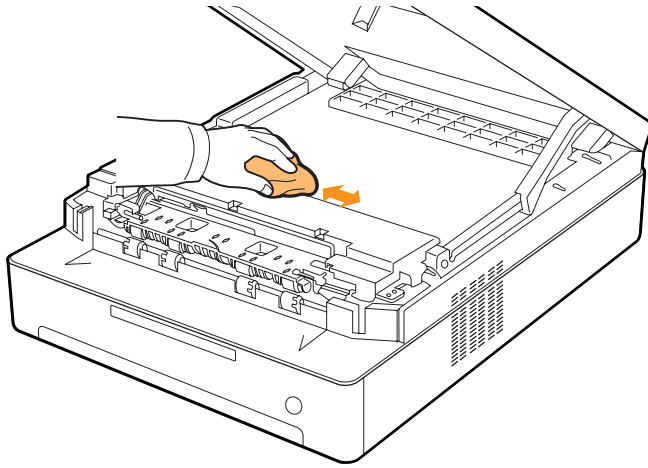

**Note**

If toner gets on your clothing, wipe it off with a dry cloth and wash it in cold water. Hot water sets toner into fabric.

- 4 Locate the long strip of glass (LSU) inside the front door, and gently swab the glass to see if dirt turns the white cotton black.

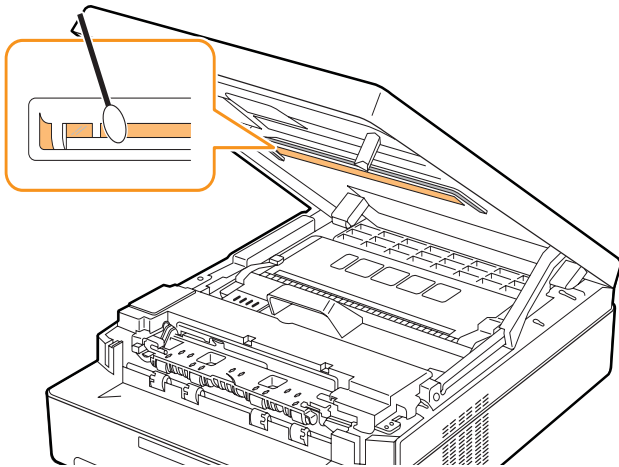

- 5 Slide the toner cartridge back into the machine.

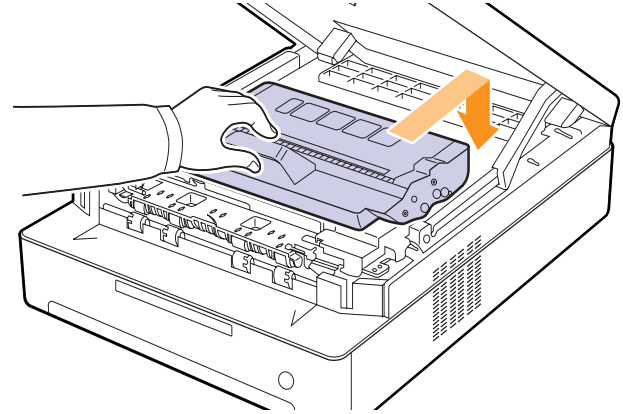

- 6 Hold the top cover and close it slowly and carefully, until the cover is securely latched.

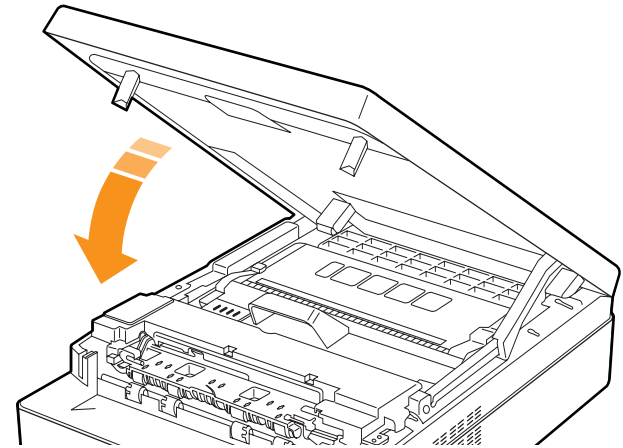

**Note**

If the top cover is not completely closed, the machine will not operate.



**Caution**

Be careful not to pinch your fingers, since the top cover is very heavy.

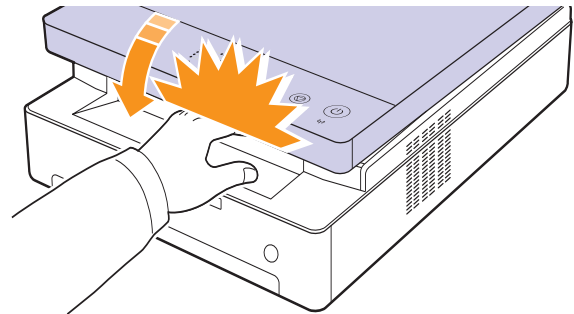

## Maintaining the cartridge

### Toner cartridge storage

Toner cartridges contain components that are sensitive to light, temperature, and humidity. Samsung suggests users follow the recommendations to ensure the optimum performance, highest quality, and longest life from your new Samsung toner cartridge.

Store this cartridge in the same environment as the printer it will be used in; this should be in controlled office temperature and humidity conditions. The toner cartridge should remain in its original, unopened package until installation – If original packaging is not available, cover the top opening of the cartridge with paper and store in a dark cabinet.

Opening the cartridge package prior to use dramatically shortens its useful shelf and operating life. Do not store on the floor. If the toner cartridge is removed from the printer, always store the cartridge:

- Inside the protective bag from the original package
- Correct side up in a horizontal position (not standing on end)
- Do not store consumables in;
  - Temperature greater than 40°C (104°F).
  - Humidity range less than 20% and not greater than 80%.
  - An environment with extreme changes in humidity or temperature.
  - Direct sunlight or room light.
  - Dusty places.
  - A car for a long period of time.
  - An environment where corrosive gases are present.
- An environment with salty air.

### Handling instructions

- Do not touch the surface of the photosensitive drum in the cartridge.
- Do not expose the cartridge to unnecessary vibrations or shock.
- Never manually rotate the drum, especially in the reverse direction; this can cause internal damage and toner spillage.

### Use of non-Samsung and refilled toner cartridge

Samsung Electronics does not recommend or approve the use of non-Samsung brand toner cartridges in your printer including generic, store brand, refilled, or remanufactured toner cartridges.



#### Caution

- Samsung's printer warranty does not cover damage to the machine caused by the use of a refilled, remanufactured, or non-Samsung brand toner cartridge.

### Estimated cartridge life

Estimated cartridge life (the life of the toner cartridge yield) depends on the amount of toner that print jobs require. The actual print-out number may vary depending on the print density of the pages you print on, operating environment, printing interval, media type, and/or media size. For example, if you print a lot of graphics, the consumption of the toner is high and you may need to change the cartridge more often.

## Redistributing toner

When small amount of toner is left in the cartridge, the toner LED ( ) blinks slowly. It may cause faded or light areas on a paper. You can temporarily improve print quality by redistributing the toner. For detailed information about error message, see page 7.7.



#### Note

In some cases, white streaks or light printing will still occur even after you have redistributed the toner.

- 1 Press the top cover lever, completely open the top cover.

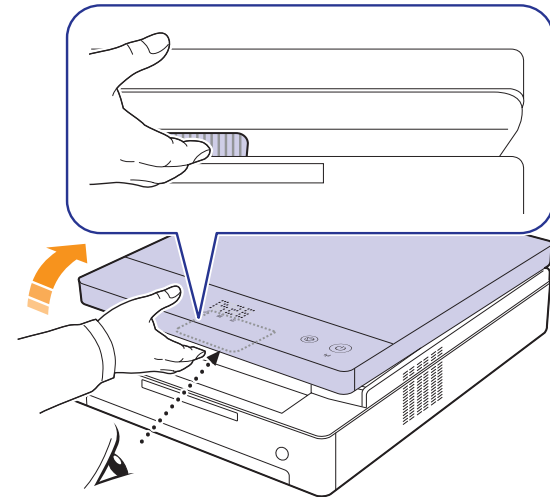

- 2 Grasp the handles on the toner cartridge and pull to remove the cartridge from the machine.

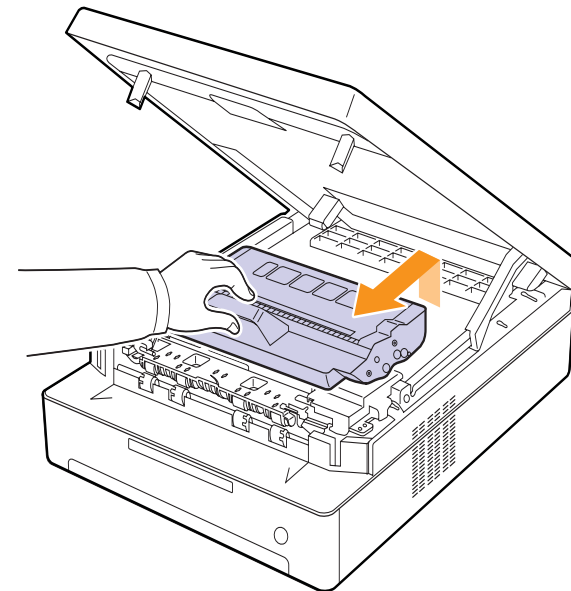

- 3 Holding side edges of the toner cartridge, thoroughly rock it from side to side to redistribute the toner.

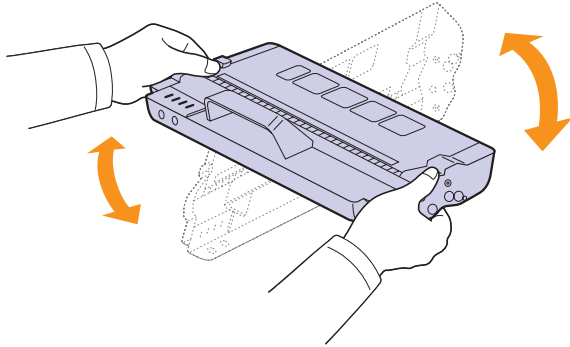

**Caution**

- Do not touch the green surface, the OPC drum or the front of the toner cartridge, with your hands or any other material. Use the handle on each cartridge in order to avoid touching this area.
- If you leave the top cover open for more than a few minutes, the OPC drum can be exposed to light. This will cause damage to the OPC drum. Close the top cover should the installation need to be halted for any reason.



**Note**

If toner gets on your clothing, wipe it off with a dry cloth and wash it in cold water. Hot water sets toner into fabric.

- 4 Slide the toner cartridge back into the machine.

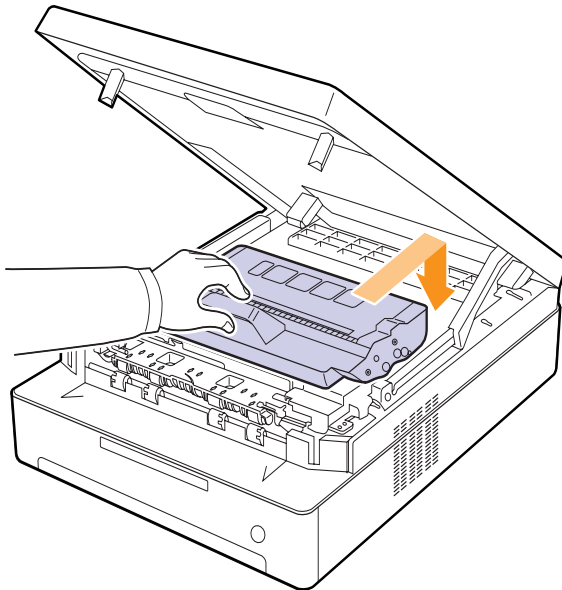

- 5 Hold the top cover and close it slowly and carefully, until the cover is securely latched.

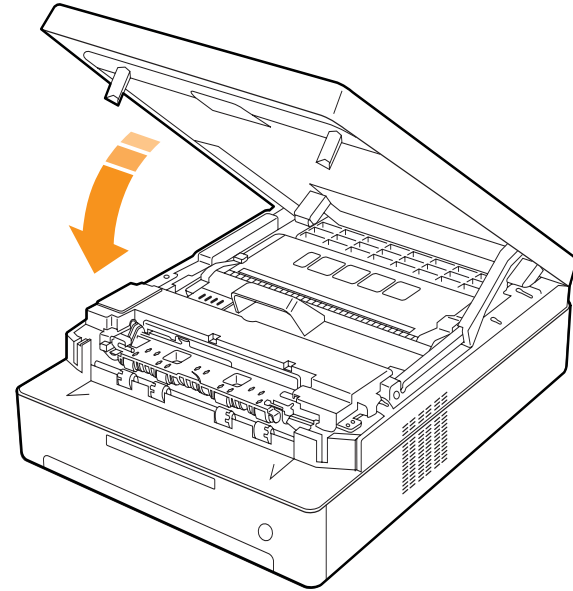

**Note**

If the top cover is not completely closed, the machine will not operate.



**Caution**

Be careful not to pinch your fingers, since the top cover is very heavy.

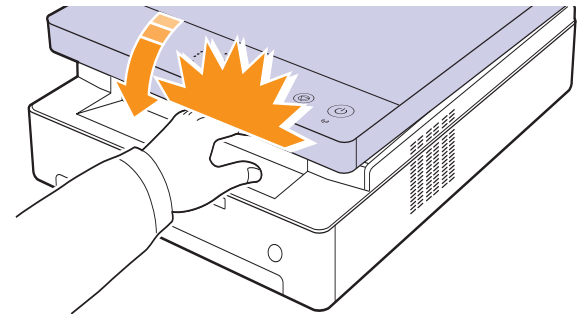



## Replacing the toner cartridge

- The toner LED (  ) blinks rapidly and the toner-related messages on the display indicate when toner cartridge should be replaced. For detailed information about error message, see page 7.7.
- The machine stops printing.

At this stage, the toner cartridge needs to be replaced. Check the type of toner cartridge for your machine. (See "Supplies" on page 8.1.)

- 1 Turn the machine off, then wait a few minutes for the machine to cool.
- 2 Press the top cover lever, completely open the top cover.

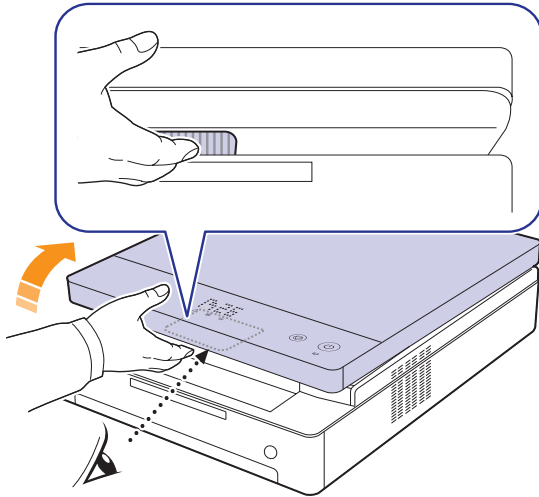

- 3 Grasp the handles on the toner cartridge and pull to remove the cartridge from the machine.

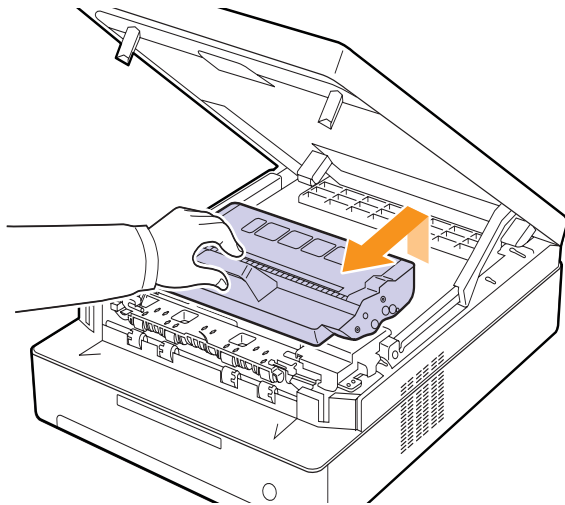

- 4 Take a new toner cartridge out of its package.

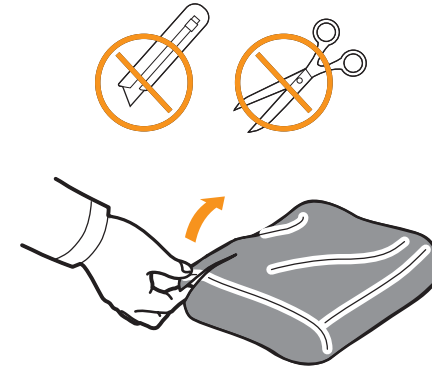

### Caution

- Don't use sharp objects, such as a knife or scissors, to open the toner cartridge package. You could damage the surface of the toner cartridge.
- To prevent damage, do not expose the toner cartridge to light for more than a few minutes. Cover it with a piece of paper to protect it if necessary.

- 5 Holding side edges of the toner cartridge, thoroughly rock it from side to side to redistribute the toner.

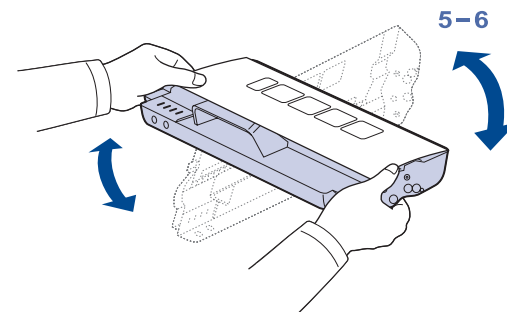

- 6 Place the toner cartridge on a flat surface, as shown, and remove the paper covering the toner cartridge.

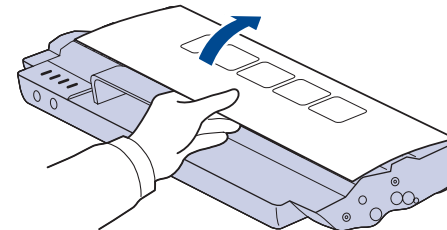



**Caution**

- Do not touch the green surface, the OPC drum or the front of each toner cartridge, with your hands or any other material. Use the handle on each cartridge in order to avoid touching this area.
- If you leave the top cover open for more than a few minutes, the OPC drum can be exposed to light. This will cause damage to the OPC drum. Close the top cover should the installation need to be halted for any reason.

**Note**

If toner gets on your clothing, wipe it off with a dry cloth and wash it in cold water. Hot water sets toner into fabric.

- 7 Insert the cartridge into place.

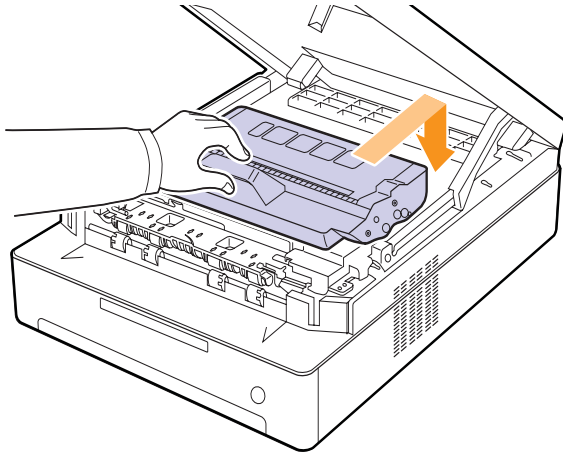

- 8 Hold the top cover and close it slowly and carefully, until the cover is securely latched.

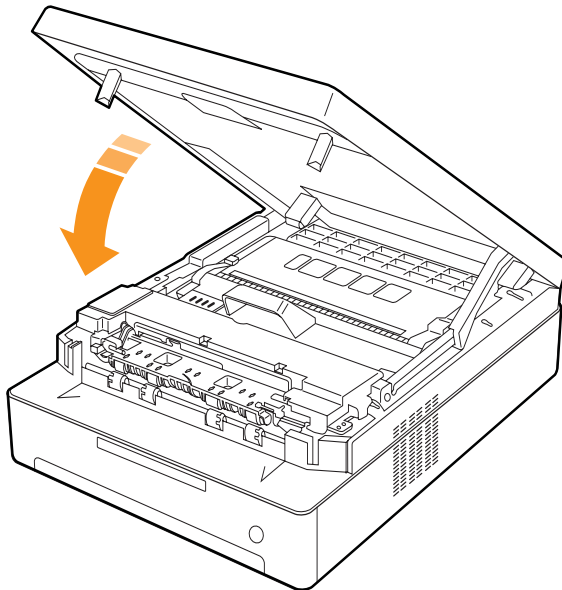
**Note**

If the top cover is not completely closed, the machine will not operate.

**Caution**

Be careful not to pinch your fingers, since the top cover is very heavy.

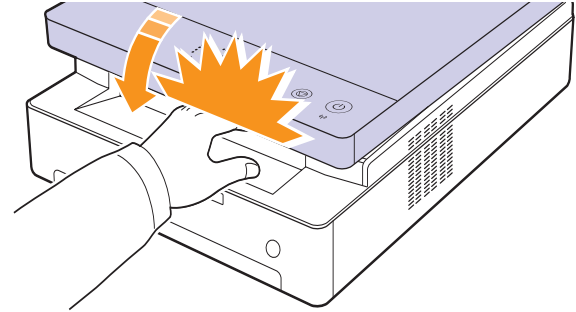

---

## Maintenance Parts

---

To avoid print quality and paper feed problems resulting from worn parts, and to maintain your machine in top working condition the following condition, the following items will need to be replaced after the specified number of pages, or when the life span of each item has expired.

Items	Yield (Average)
Transfer roller	Approx. 50,000 pages
Fuser unit	Approx. 50,000 pages
Paper feed roller	Approx. 50,000 pages

We highly recommend that this maintenance be performed by an authorized service provider, dealer or the retailer where you bought the machine. The warranty does not cover the replacement of the maintenance parts after their lifespan.

---

## Managing your machine from the website

---

If you have connected your machine to a network and set up TCP/IP network parameters correctly, you can manage the machine via Samsung's **SyncThru™ Web Service**, an embedded web server. Use **SyncThru™ Web Service** to:

- View the device information and check its current status.
- Change TCP/IP parameters and set up other network parameters.
- Change the printer properties.
- Set the machine to send email notifications and update you on the machine's status.
- Get support for using the machine.

To access **SyncThru™ Web Service**:

- 1 Start a web browser, such as Internet Explorer, from Windows.
- 2 Enter the machine IP address (http://xxx.xxx.xxx.xxx) in the address field and press the **Enter** key or click **Go**.

Your machine's embedded website opens.

# 7 Troubleshooting

This chapter gives helpful information on what to do if you encounter a problem.

This chapter includes:

- **Tips for avoiding paper jams**
- **Clearing paper jams**
- **Understanding display messages**
- **Solving other problems**

## Tips for avoiding paper jams

By selecting the correct media types, most paper jams can be avoided. When a paper jam occurs, follow the steps outlined on page 7.1.

- Follow the procedures on page 4.5. Ensure that the adjustable guides are positioned correctly.
- Do not overload the tray. Ensure that the paper level is below the paper capacity mark on the inside of the tray.
- Do not remove paper from the tray while your machine is printing.
- Flex, fan, and straighten paper before loading.
- Do not use creased, damp, or highly curled paper.
- Do not mix paper types in a tray.
- Use only recommended print media. (see page 4.6)
- Ensure that the recommended side of the print media is facing down in the tray.

## Clearing paper jams

Refer to the table below to locate and clear the paper jam.

Status display	Explanation	Solution
Paper jam LED(  ) blinks	In the paper feed area and rear the machine	Clear the jam. (Page 7.1)
	Rear and Inside the machine	Clear the jam. (Page 7.3)
	In the exit area	Clear the jam. (Page 7.5)



### Caution

To avoid tearing the paper, pull the jammed paper out gently and slowly. Follow the instructions in the following sections to clear the jam.

## In the paper feed area and rear the machine

If paper is jammed in the paper feed area and rear the machine, follow the next steps to release the jammed paper.

- 1 Press the tray open button.

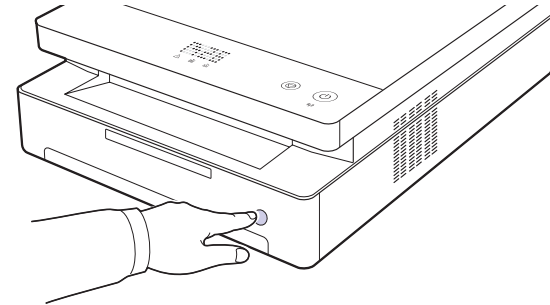

- 2 Pull the tray open.

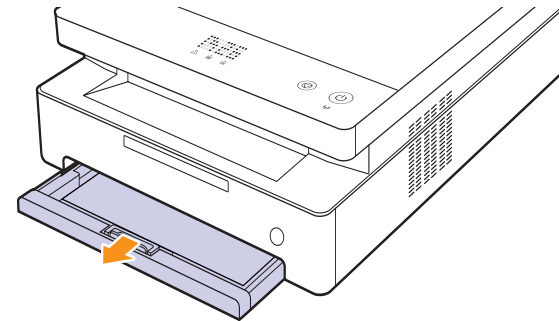

- 3 Remove the jammed paper by gently pulling it straight out as shown below.

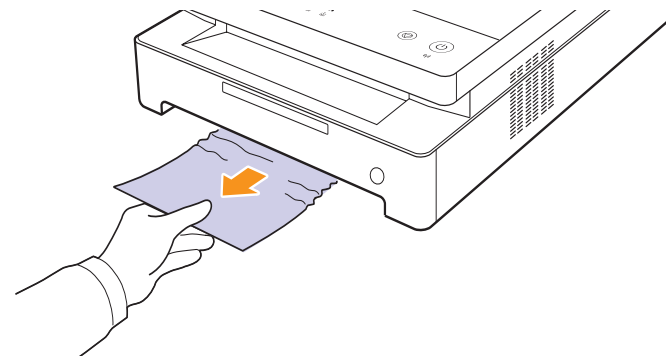

- 4 Align the tray with the slot, and slide it into the machine.

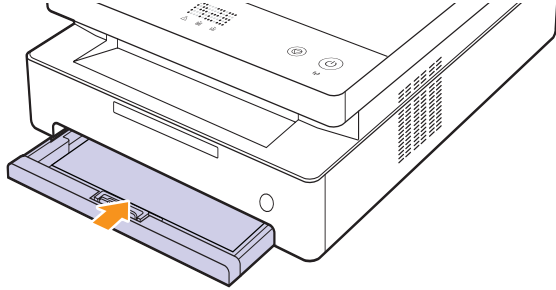

- 5 Press the top cover lever, completely open the top cover.

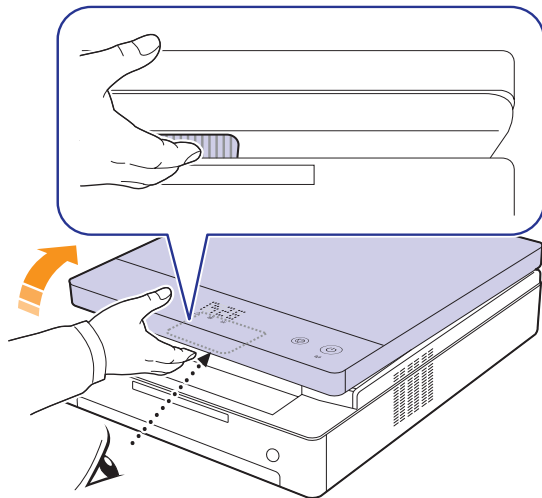

- 6 Hold the top cover and close it slowly and carefully, until the cover is securely latched.

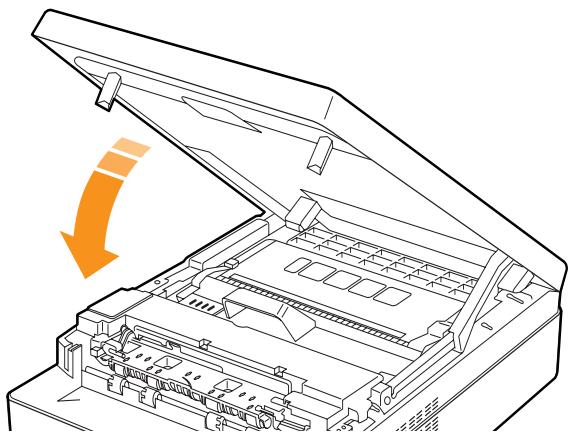

**Note**

If the top cover is not completely closed, the machine will not operate.



**Caution**

Be careful not to pinch your fingers, since the top cover is very heavy.

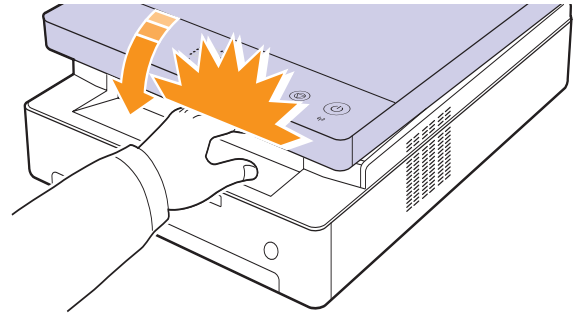

- 7 If the paper jam LED blinks, go to next step.

- 8 Open the rear cover.

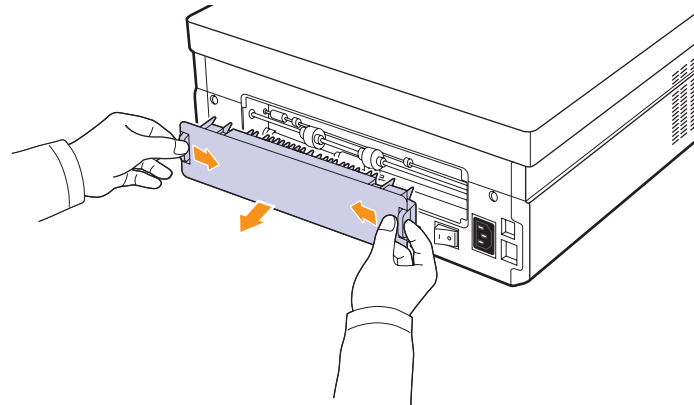

- 9 Carefully take the jammed paper out of the machine.

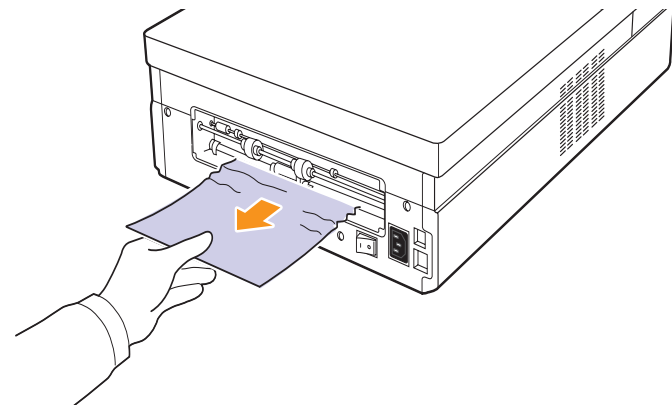

**Caution**

Do not touch the fuser inside the machine. It is hot and could cause burns! The fuser's operating temperature is very hot. Take care when removing paper from the machine.

- 10 Hold both edges of the rear cover, and align it as shown in the following figure. Press the rear cover firmly until it clicks.

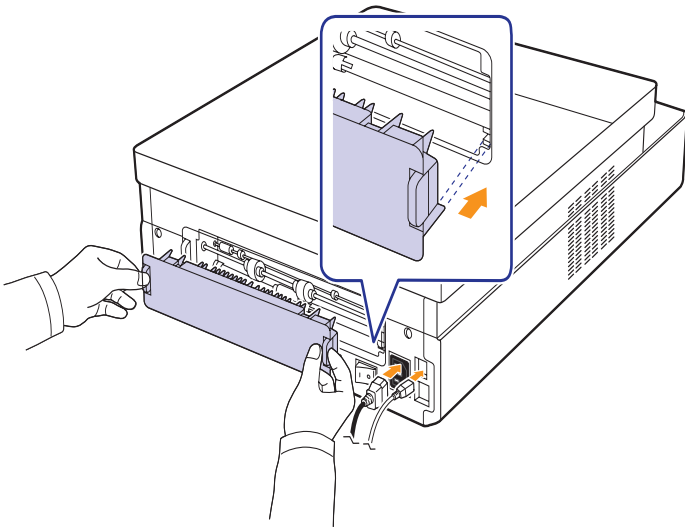

**Note**

If the rear cover is not completely closed, the paper jam may occur.

- 11 Open and close the top cover firmly. The machine will resume printing.

## Rear and inside the machine

If paper is jammed in the rear and inside the machine, follow the next steps to release the jammed paper.

- 1 Open the rear cover.

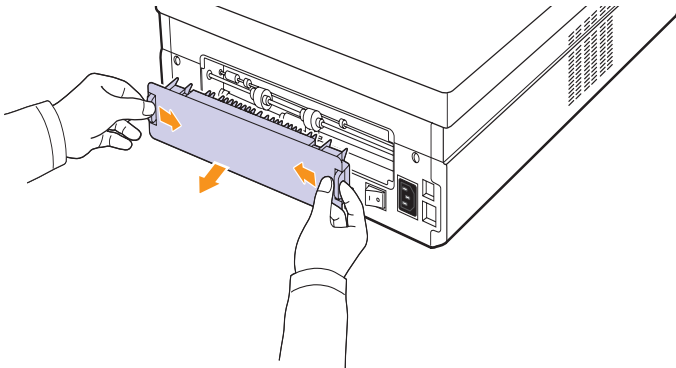

- 2 Carefully take the jammed paper out of the machine.

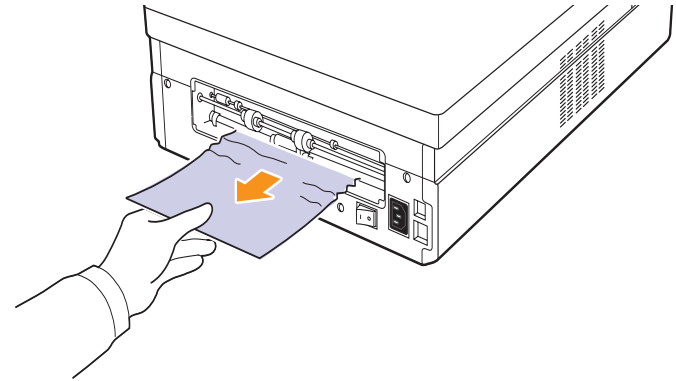

**Caution**

Do not touch the fuser inside the machine. It is hot and could cause burns! The fuser's operating temperature is very hot. Take care when removing paper from the machine.

- 3 Hold both edges of the rear cover, and align it as shown in the following figure. Press the rear cover firmly until it clicks.

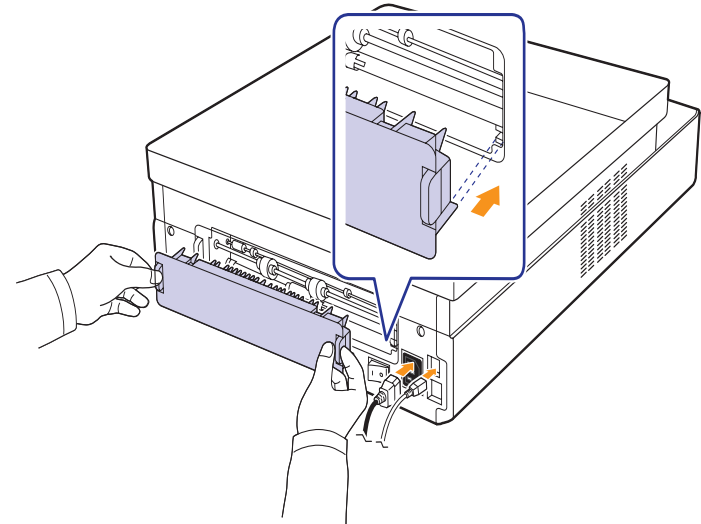

**Note**

If the rear cover is not completely closed, the paper jam may occur.

- 4 Press the top cover lever, completely open the top cover.

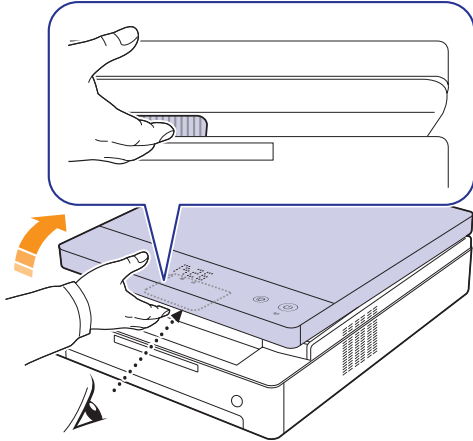

- 5 Hold the top cover and close it slowly and carefully, until the cover is securely latched.

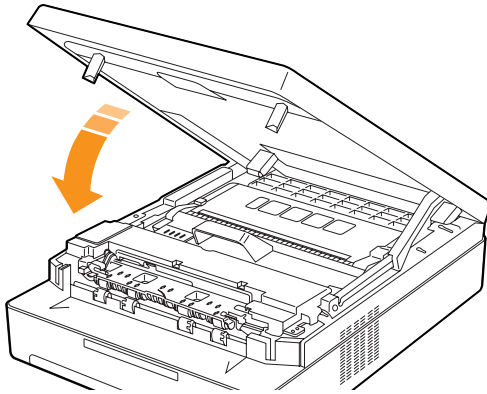

**Note**

If the top cover is not completely closed, the machine will not operate.



**Caution**

Be careful not to pinch your fingers, since the top cover is very heavy.

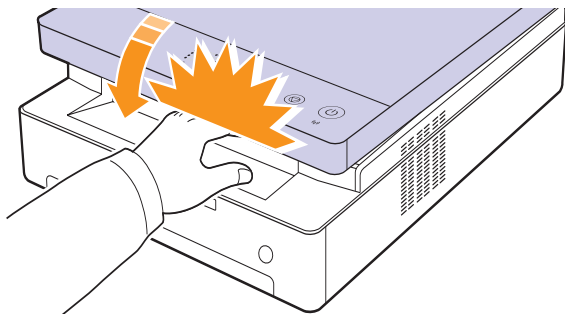

- 6 If the paper jam LED blinks, go to next step.

- 7 Press the top cover lever, completely open the top cover.

- 8 Grasp the handles on the toner cartridge and pull to remove the cartridge out of the machine.

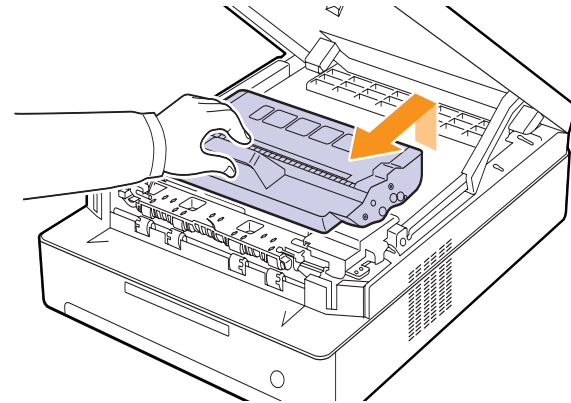

**Caution**

- Do not touch the green surface, the OPC drum or the front of the toner cartridge, with your hands or any other material. Use the handle on each cartridge in order to avoid touching this area.
- If you leave the top cover open for more than a few minutes, the OPC drum can be exposed to light. This will cause damage to the OPC drum. Close the top cover should the installation need to be halted for any reason.



**Note**

If toner gets on your clothing, wipe it off with a dry cloth and wash it in cold water. Hot water sets toner into fabric.

- 9 Carefully take the jammed paper out of the machine.

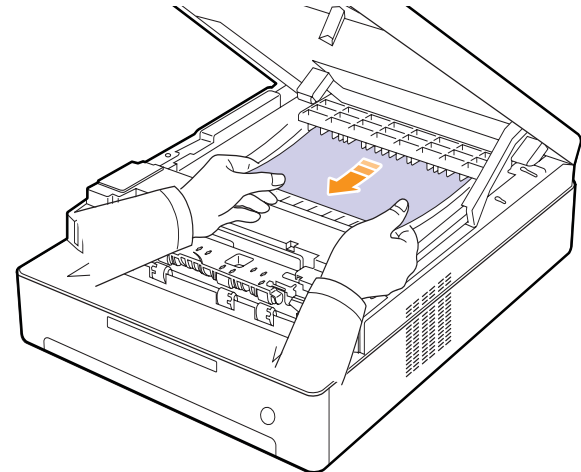

**Caution**

Do not touch the fuser inside the machine. It is hot and could cause burns! The fuser's operating temperature is very hot. Take care when removing paper from the machine.

10 After removing the jammed paper, check for paper which may be jammed in other parts of the machine.

11 Slide the toner cartridge back into the machine.

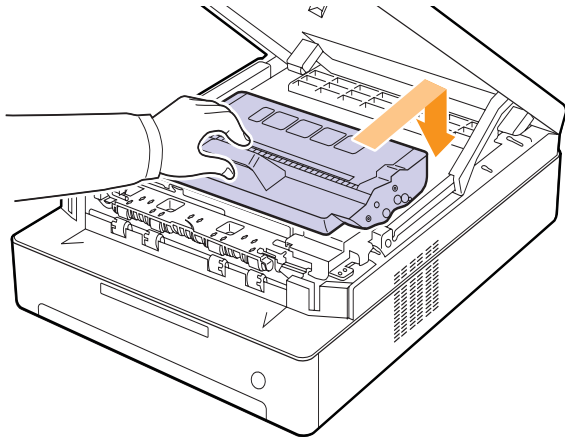

12 Close the top cover firmly. The machine will resume printing.

## In the exit area

If paper is jammed in the paper exit area, follow the next steps to release the jammed paper.

1 Press the top cover lever, completely open the top cover.

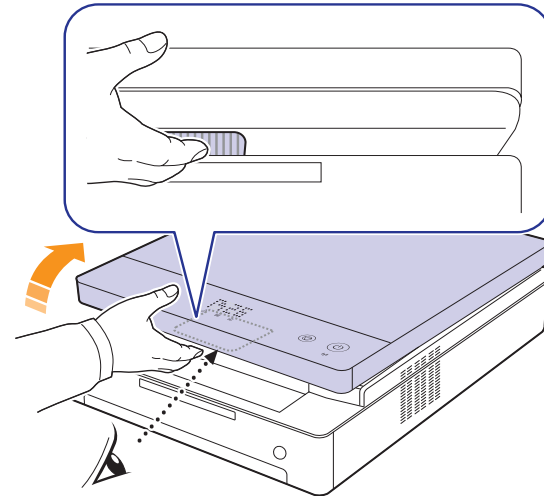

2 If a long portion of the paper is visible, pull it straight out.

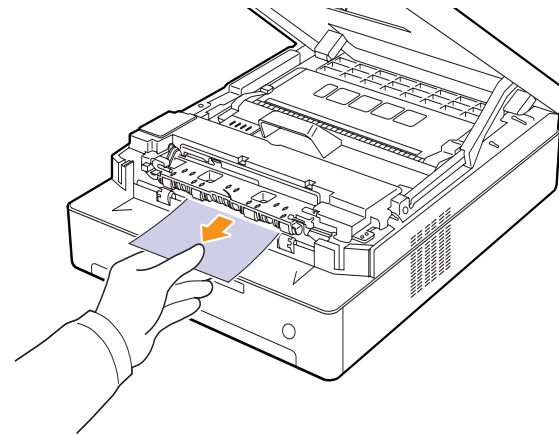

If there is any resistance removing the paper, stop pulling and go to step 4.



### Caution

Do not touch the fuser inside the machine. It is hot and could cause burns! The fuser's operating temperature is very hot. Take care when removing paper from the machine.



- 3 Hold the top cover and close it slowly and carefully, until the cover is securely latched.

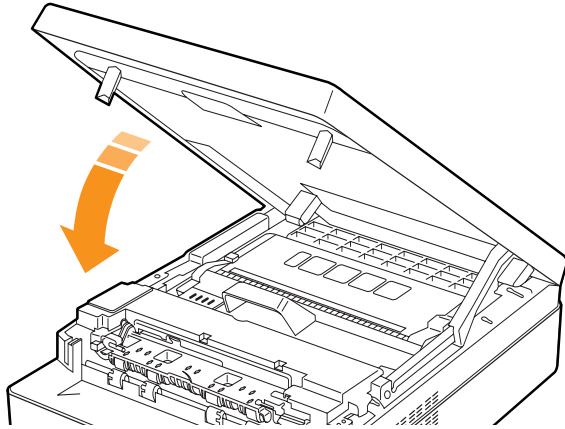

**Note**

If the top cover is not completely closed, the machine will not operate.



**Caution**

Be careful not to pinch your fingers, since the top cover is very heavy.

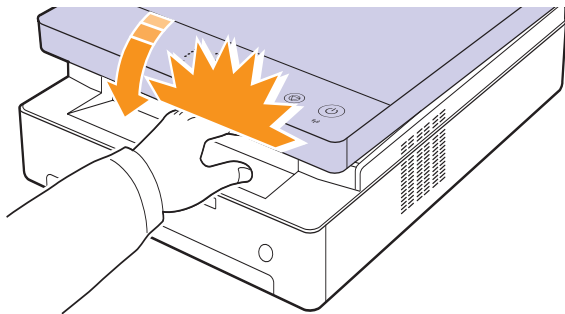

- 4 Open the inner cover.

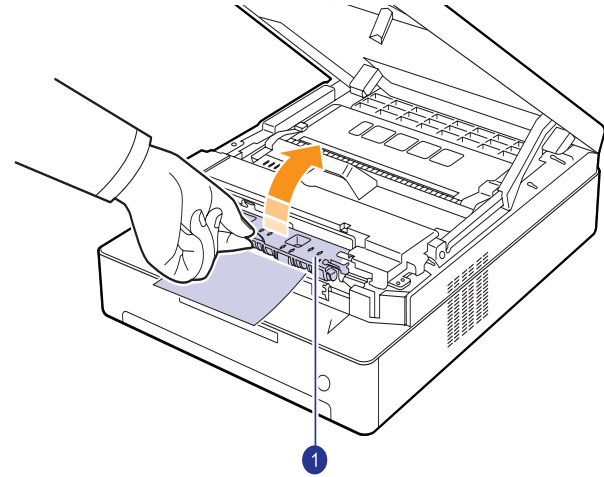

1 inner cover



**Caution**

Do not touch the fuser inside the machine. It is hot and could cause burns! The fuser's operating temperature is very hot. Take care when removing paper from the machine.

- 5 Carefully take the jammed paper out of the machine.

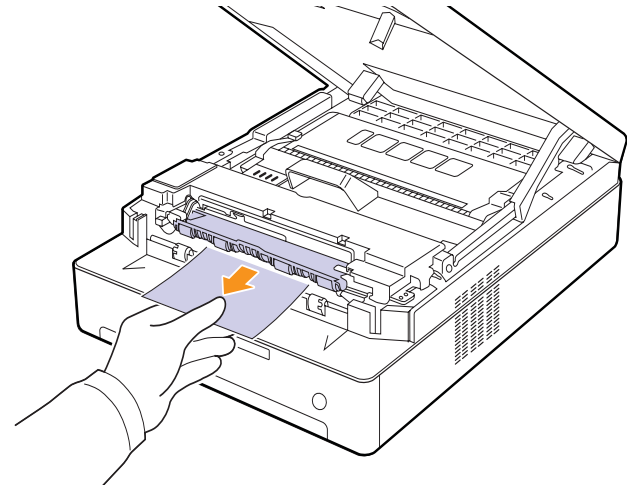

- 6 Close the inner cover.  
7 After removing the jammed paper, check for paper which may be jammed in other parts of the machine.  
8 Close the top cover firmly. The machine will resume printing.





## Understanding display messages

Messages appear on the Smart Panel program window or on the control panel display to indicate machine status or errors. Refer to the tables below to understand the messages meaning to correct the problem, if necessary.



### Note

When you call for service, it is very convenient to provide the service representative with the contents of the display message.

Status display	Explanation	Solution
OPEN	The covers is not completely closed.	Press the covers until it clicks.
 LED blinks	There is a problem in the machine.	Unplug the power cord and plug it back in. If the problem persists, contact the service representatives.
 LED blinks	There is no paper in the tray.	Load paper in the tray. (Page 4.5)
 LED blinks	In the paper feed area and rear the machine.	Clear the jam. (Page 7.1)
	Rear and Inside the machine.	Clear the jam. (Page 7.3)
	In the exit area.	Clear the jam. (Page 7.5)
 LED blinks slowly	Small amount of toner is left in the cartridge. The estimated cartridge life <sup>a</sup> of toner is close.	Take out the corresponding toner cartridge and thoroughly shake it. By doing this, you can temporarily reestablish printing operations. (Page 8.4)

Status display	Explanation	Solution
 LED blinks rapidly	A toner cartridge has almost reached its estimated cartridge life. <sup>a</sup>	Replace the toner cartridge for the best print quality when this message appears. Using a cartridge beyond this stage can result in printing quality issues. (See "Replacing the toner cartridge" on page 8.5.)
	The toner cartridge is installed improperly, or not installed.	Reinstall the toner cartridge two or three times. If the problem persists, the toner cartridge is not being detected. Please contact the service representatives. (Page 6.5)
T1	The toner cartridge which the arrow indicates is not suitable for your machine.	Install the a Samsung-genuine toner cartridge designed for your machine.
T2	A toner cartridge has almost reached its estimated cartridge life. <sup>a</sup>	It is recommended to replace the toner cartridge. (See "Replacing the toner cartridge" on page 8.5.)
T3	The toner cartridge which the arrow indicates is not a Samsung-genuine cartridge.	Replace the corresponding toner cartridge with a Samsung-genuine cartridge. (Page 6.5)

a. Estimated cartridge life means the expected or estimated toner cartridge life, which indicates the average capacity of print-outs and is designed pursuant to ISO/IEC 19752. (page 11.1) The number of pages may be affected by operating environment, printing interval, media type, and media size. Some amount of toner may remain in the cartridge even when the red LED turned on and the printer stops printing.



### Caution

Samsung does not recommend using non-genuine Samsung toner cartridge such as refilled or remanufactured. Samsung cannot guarantee non-genuine Samsung toner cartridge's quality. Service or repair required as a result of using non-genuine Samsung toner cartridges will not be covered under the machine warranty.

## Solving other problems

The following chart lists some conditions that may occur and the recommended solutions. Follow the suggested solutions until the problem is corrected. If the problem persists, please call for service.

### Paper feeding problems

Condition	Suggested solutions
Paper is jammed during printing.	Clear the paper jam. (See "Clearing paper jams" on page 7.1.)
Paper sticks together.	<ul style="list-style-type: none"> <li>• Ensure that there is not too much paper in the tray. The tray can hold up to 100 sheets of paper.</li> <li>• Make sure that you are using the correct type of paper. (See "Specifications on print media" on page 4.3.)</li> <li>• Remove paper from the tray and flex or fan the paper.</li> <li>• Humid conditions may cause some paper to stick together.</li> </ul>
Multiple sheets of paper do not feed.	<ul style="list-style-type: none"> <li>• Different types of paper may be stacked in the tray. Load paper of only one type, size, and weight.</li> <li>• If multiple sheets have caused a paper jam, clear the paper jam. (See "Clearing paper jams" on page 7.1.)</li> </ul>
Paper does not feed into the machine.	<ul style="list-style-type: none"> <li>• Paper has not been loaded correctly. Remove paper from the tray and reload it correctly.</li> <li>• There is too much paper in the tray. Remove excess paper from the tray.</li> <li>• The paper is too thick. Turn the paper around or upside down, and try again. Use only paper that meets the specifications required by the machine. (See "Specifications on print media" on page 4.3.)</li> <li>• Remove any obstructions from inside the machine.</li> </ul>
The paper keeps jamming.	<ul style="list-style-type: none"> <li>• There is too much paper in the tray. Remove excess paper from the tray.</li> <li>• An incorrect type of paper is being used. Use only paper that meets the specifications required by the machine. (See "Specifications on print media" on page 4.3.)</li> <li>• There may be debris inside the machine. Open the top cover and remove the debris.</li> </ul>

## Printing problems

Condition	Possible cause	Suggested solutions
The machine does not print.	The machine is not receiving power.	Check the power cord connections. Check the power switch and the power source.
	The machine is not selected as the default printer.	Select a machine name as your default printer in your Windows.
	Check the machine for the following: <ul style="list-style-type: none"> <li>• The cover is not closed. Close the cover.</li> <li>• Paper is jammed. Clear the paper jam. (See "Clearing paper jams" on page 7.1.)</li> <li>• No paper is loaded. Load paper. (See "Loading paper in the tray" on page 4.5.)</li> <li>• The toner cartridge is not installed. Install the toner cartridge.</li> </ul> If a system error occurs, contact your service representative.	
	The connection cable between the computer and the machine is not connected properly.	Disconnect the printer cable and reconnect it.
	The connection cable between the computer and the machine is defective.	If possible, attach the cable to another computer that is working properly and print a job. You can also try using a different printer cable.
	The port setting is incorrect.	Check the Windows printer setting to make sure that the print job is sent to the correct port. If the computer has more than one port, make sure that the machine is attached to the correct one.
	The machine may be configured incorrectly.	Check the printer properties to ensure that all of the print settings are correct.
	The printer driver may be incorrectly installed.	Repair the printer software. See Software section.
	The machine is malfunctioning.	Check the display message on the control panel to see if the machine is indicating a system error. Contact a service representative.



Condition	Possible cause	Suggested solutions
The machine selects print materials from the wrong paper source.	The paper option that was selected in the machine properties may be incorrect.	For many software applications, the paper source selection is found under the <b>Paper</b> tab within the printer properties. Select the correct paper source. See the printer driver help screen.
A print job is extremely slow.	The job may be very complex.	Reduce the complexity of the page or try adjusting the print quality settings such as adjusting the resolution.
Half the page is blank.	The page orientation setting may be incorrect.	Change the page orientation in your application. See the printer driver help screen.
	The paper size and the paper size settings do not match.	Ensure that the paper size in the printer driver settings matches the paper in the tray.  Or, ensure that the paper size in the printer driver settings matches the paper selection in the software application settings you use.
The machine prints, but the text is wrong, garbled, or incomplete.	The printer cable is loose or defective.	Disconnect the printer cable and reconnect. Try a print job that you have already printed successfully. If possible, attach the cable and the machine to another computer and try a print job that you know works. Finally, try a new printer cable.
	The wrong printer driver was selected.	Check the application's printer selection menu to ensure that your machine is selected.
	The software application is malfunctioning.	Try printing a job from another application.
	The operating system is malfunctioning.	Exit Windows and reboot the computer. Turn the machine off and then back on again.

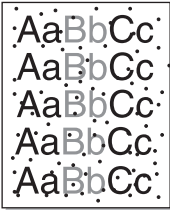
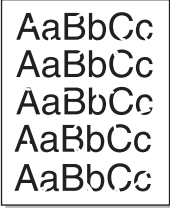

Condition	Possible cause	Suggested solutions
Pages print, but they are blank.	The toner cartridge is defective or out of toner.	Redistribute the toner, if necessary. If necessary, replace the toner cartridge.
	The file may have blank pages.	Check the file to ensure that it does not contain blank pages.
	Some parts, such as the controller or the board, may be defective.	Contact a service representative.
PDF file does not print correctly—some parts are missing in the graphics, text or illustrations.	Incompatibility between the PDF file and the Acrobat products.	Printing the PDF file as an image may enable the file to print. Turn on <b>Print As Image</b> from the Acrobat printing options.  <b>Note:</b> It will take longer to print when you print a PDF file as an image.
The print quality of photos is not good. Images are not clear.	The resolution of the photo is very low.	Reduce the photo size. If you increase the photo size in the software application, the resolution will be reduced.

## Printing quality problems

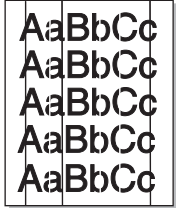
If the inside of the machine is dirty or paper has been loaded improperly, you may notice a reduction in print quality. See the table below to clear the problem.

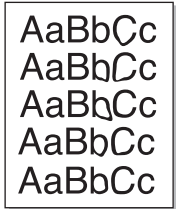
Condition	Suggested solutions
<b>Light or faded print</b> 	<p>If a vertical white streak or faded area appears on the page:</p> <ul style="list-style-type: none"> <li>The toner supply is low. You may be able to temporarily extend the toner cartridge life. If this does not improve the print quality, install a new toner cartridge.</li> <li>The paper may not meet paper specifications; for example, the paper may be too moist or rough. (See "Specifications on print media" on page 4.3.)</li> <li>If the entire page is light, the print resolution setting is too low or the toner save mode is on. Adjust the print resolution and turn the toner save mode off. See the help screen of the printer driver and refer to Software section, respectively.</li> <li>A combination of faded or smeared defects may indicate that the toner cartridge needs cleaning. Contact a service representative.</li> <li>The surface of the LSU part inside the machine may be dirty. Clean the LSU (see page 6.2).</li> </ul>
<b>Toner specks</b> 	<ul style="list-style-type: none"> <li>The paper may not meet specifications; for example, the paper may be too moist or rough. (See "Specifications on print media" on page 4.3.)</li> <li>The paper path may need cleaning. Contact a service representative.</li> </ul>
<b>Dropouts</b> 	<p>If faded areas, generally rounded, occur randomly on the page:</p> <ul style="list-style-type: none"> <li>A single sheet of paper may be defective. Try reprinting the job.</li> <li>The moisture content of the paper is uneven or the paper has moist spots on its surface. Try a different brand of paper. (See "Specifications on print media" on page 4.3.)</li> <li>The paper lot is bad. The manufacturing processes can cause some areas to reject toner. Try a different kind or brand of paper.</li> <li>If these steps do not correct the problem, contact a service representative.</li> </ul>

Condition	Suggested solutions
<b>White Spots</b> 	<p>White spots appear on the page:</p> <ul style="list-style-type: none"> <li>The paper path may need cleaning. Contact a service representative.</li> </ul>
<b>Vertical lines</b> 	<p>If black vertical streaks appear on the page:</p> <ul style="list-style-type: none"> <li>The toner cartridge has probably been scratched. Remove the toner cartridge and install a new one.</li> </ul> <p>If white vertical streaks appear on the page:</p> <ul style="list-style-type: none"> <li>The surface of the LSU part inside the machine may be dirty. Clean the LSU (see page 6.2).</li> </ul>
<b>Color or Black background</b> 	<p>If the amount of background shading becomes unacceptable:</p> <ul style="list-style-type: none"> <li>Change to a lighter weight paper. (See "Specifications on print media" on page 4.3.)</li> <li>Check the environmental conditions: very dry conditions (low humidity) or a high level of humidity (higher than 80% RH) can increase the amount of background shading.</li> <li>Remove the old toner cartridge, and then install a new one. (See "Replacing the toner cartridge" on page 6.5.)</li> </ul>
<b>Toner smear</b> 	<ul style="list-style-type: none"> <li>Clean the inside of the machine. Contact a service representative to clean the inside of the machine.</li> <li>Check the paper type and quality. (See "Specifications on print media" on page 4.3.)</li> </ul>

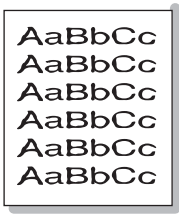
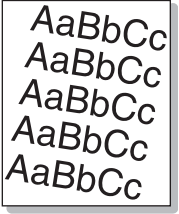
Condition	Suggested solutions
<p><b>Vertical repetitive defects</b></p> 	<p>If marks repeatedly appear on the printed side of the page at even intervals:</p> <ul style="list-style-type: none"> <li>• Clean the inside of the machine. Contact a service representative to clean the inside of the machine. After cleaning the inside of the machine, if you still have the same problems, install a new toner cartridge of the problem color. See "Replacing the toner cartridge" on page 6.5.</li> <li>• Parts of the machine may have toner on them. If the defects occur on the back of the page, the problem will likely correct itself after a few more pages.</li> <li>• The fusing assembly may be damaged. Contact a service representative.</li> </ul>
<p><b>Background scatter</b></p> 	<p>Background scatter results from bits of toner randomly distributed on the printed page.</p> <ul style="list-style-type: none"> <li>• The paper may be too damp. Try printing with a different batch of paper. Do not open packages of paper until necessary so that the paper does not absorb too much moisture.</li> <li>• If background scatter covers the entire surface area of a printed page, adjust the print resolution through your software application or in printer properties.</li> </ul>
<p><b>Misformed characters</b></p> 	<ul style="list-style-type: none"> <li>• If characters are improperly formed and producing hollow images, the paper stock may be too slick. Try different paper. (See "Specifications on print media" on page 4.3.)</li> <li>• If characters are improperly formed and producing a wavy effect, the scanner unit may need service. Contact a service representative.</li> </ul>
<p><b>Page skew</b></p> 	<ul style="list-style-type: none"> <li>• Ensure that the paper is loaded properly.</li> <li>• Check the paper type and quality. (See "Specifications on print media" on page 4.3.)</li> <li>• Ensure that the paper or other material is loaded correctly and the guides are not too tight or too loose against the paper stack.</li> </ul>

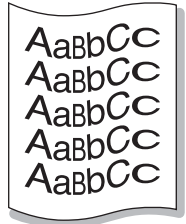
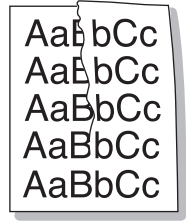
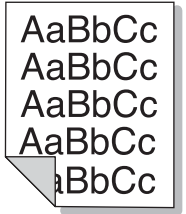
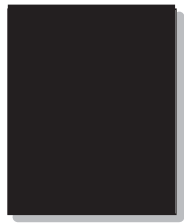
Condition	Suggested solutions
<p><b>Curl or wave</b></p> 	<ul style="list-style-type: none"> <li>• Ensure that the paper is loaded properly.</li> <li>• Check the paper type and quality. Both high temperature and humidity can cause paper curl. (See "Specifications on print media" on page 4.3.)</li> <li>• Turn the stack of paper over in the tray. Also try rotating the paper 180° in the tray.</li> </ul>
<p><b>Wrinkles or creases</b></p> 	<ul style="list-style-type: none"> <li>• Ensure that the paper is loaded properly.</li> <li>• Check the paper type and quality. (See "Specifications on print media" on page 4.3.)</li> <li>• Turn the stack of paper over in the tray. Also try rotating the paper 180° in the tray.</li> </ul>
<p><b>Back of printouts are dirty</b></p> 	<p>Check for leaking toner. Clean the inside of the machine. Contact a service representative.</p>
<p><b>Black pages</b></p> 	<ul style="list-style-type: none"> <li>• The toner cartridge may not be installed properly. Remove the cartridge and reinsert it.</li> <li>• The toner cartridge may be defective and need replacing. Remove the toner cartridge and install a new one. (See "Replacing the toner cartridge" on page 6.5.)</li> <li>• The machine may require repair. Contact a service representative.</li> </ul>

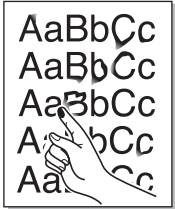
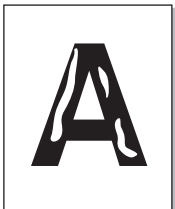
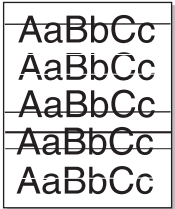
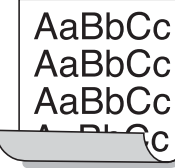

Condition	Suggested solutions
<b>Loose toner</b> 	<ul style="list-style-type: none"> <li>• Clean the inside of the machine. Contact a service representative to clean the inside of the machine. After cleaning the inside of the machine, if you still have the same problems, contact a service representative.</li> <li>• Check the paper type and quality. (See "Specifications on print media" on page 4.3.)</li> <li>• Remove the toner cartridge, and then install a new one. (See "Replacing the toner cartridge" on page 6.5.)</li> <li>• If the problem persists, the machine may require repair. Contact a service representative.</li> </ul>
<b>Character Voids</b> 	<p>Character voids are white areas within parts of characters that should be solid black:</p> <ul style="list-style-type: none"> <li>• If you are using transparencies, try another type of transparency. Because of the composition of transparencies, some character voids are normal.</li> <li>• You may be printing on the wrong surface of the paper. Remove the paper and turn it around.</li> <li>• The paper may not meet paper specifications. (See "Specifications on print media" on page 4.3.)</li> </ul>
<b>Horizontal stripes</b> 	<p>If horizontally aligned black streaks or smears appear:</p> <ul style="list-style-type: none"> <li>• The toner cartridge may be installed improperly. Remove the cartridge and reinsert it.</li> <li>• The toner cartridge may be defective. Remove the toner cartridge and install a new one. (See "Replacing the toner cartridge" on page 6.5.)</li> <li>• If the problem persists, the machine may require repair. Contact a service representative.</li> </ul>
<b>Curl</b> 	<p>If the printed paper is curled or paper does not feed into the machine:</p> <ul style="list-style-type: none"> <li>• Turn the stack of paper over in the tray. Also try rotating the paper 180° in the tray.</li> </ul>

Condition	Suggested solutions
An unknown image repetitively appears on the next few sheets or loose toner, light print, or contamination occurs.	Your machine is probably being used at an altitude of 1,000 m (3,281 ft) or above. The high altitude may affect the print quality from loose toner or light imaging. You can set this option through the <b>Printer</b> Tab in printer driver's properties. See page 3.9.

## Common Windows problems

Condition	Suggested solutions
"File in Use" message appears during installation.	Exit all software applications. Remove all software from the StartUp Group, then restart Windows. Reinstall the printer driver.
"General Protection Fault", "Exception OE", "Spool32", or "Illegal Operation" messages appear.	Close all other applications, reboot Windows and try printing again.
"Fail To Print", "A machine timeout error occurred." messages appear.	These messages may appear during printing. Just keep waiting until the machine finishes printing. If the message appears in standby mode or after printing has been completed, check the connection and/or whether an error has occurred.



### Note

Refer to Microsoft Windows User's Guide that came with your computer for further information on Windows error messages.



## Common Linux problems

Condition	Suggested solutions
The printer doesn't print.	<ul style="list-style-type: none"> <li>• Check if the printer driver is installed in your system. Open Unified Driver Configurator and switch to the Printers tab in Printers configuration window to look at the list of available printers. Make sure that your machine is displayed on the list. If not, please, invoke Add new printer wizard to set up your device.</li> <li>• Check if the printer is started. Open Printers configuration and select your machine on the printers list. Look at the description in the Selected printer pane. If its status contains "(stopped)" string, please, press the <b>Start</b> button. After that normal operation of the printer should be restored. The "stopped" status might be activated when some problems in printing occurred.</li> <li>• Check if your application has special print option such as "-oraw". If "-oraw" is specified in the command line parameter then remove it to print properly. For Gimp front-end, select "print" -&gt; "Setup printer" and edit command line parameter in the command item.</li> </ul>
I encounter error "Unable to open mfp port device file!" when printing a document.	Please avoid changing print job parameters (via LPR GUI, for example) while a print job is in progress. Known versions of CUPS server break the print job whenever print options are changed and then try to restart the job from the beginning. Since Unified Linux Driver locks mfp port while printing, the abrupt termination of the driver keeps the port locked and therefore unavailable for subsequent print jobs. If this situation occurred, please, try to release the mfp port.
When printing a document over the network in SuSE 9.2, the printer does not print.	The CUPS (Common Unix Printing System) version distributed with SuSE Linux 9.2 (cups-1.1.21) has a problem with ipp (Internet Printing Protocol) printing. Use the socket printing instead of ipp or install later version of CUPS (cups-1.1.22 or higher).

## Common Macintosh problems

Problem	Suggested solutions
PDF file does not print correctly-some parts are missing in the graphics, text or illustrations.	Incompatibility between the PDF file and the Acrobat products. Printing the PDF file as an image may enable the file to print. Turn on <b>Print As Image</b> from the Acrobat printing options. <b>Note:</b> It will take longer to print when you print a PDF file as an image.
The document has printed, but the print job has not disappeared from the spooler in Mac OS 10.3.2.	Update your Mac OS to OS 10.3.3. or higher.
Some fonts are not printed properly in the Adobe Illustrator program.	Those fonts may not supported by your machine. Start the Adobe Illustrator program, click <b>File &gt; Print &gt; Illustrator</b> tab. Then, check <b>Force Fonts to Download</b> , and try again.

# 8 Ordering supplies and accessories

This chapter provides information on purchasing cartridges and accessories available for your machine.

This chapter includes:

- **Supplies**
- **How to purchase**

---

## Supplies

---



### Note

The optional parts or features may differ by countries. Contact your sales representatives whether the part you want is available in your country.

When the toner runs out, you can order the following type of toner cartridge for your machine:

Type	Average yield <sup>a</sup>	Part number
Standard yield	Average cartridge yield 2,000 standard pages.	ML-D1630A

a. Declared yield value in accordance with ISO/IEC 19752.



### Caution

When you purchase a new toner cartridge or supplies, you must purchase them in the same country you have purchased your machine. Otherwise, the toner cartridge or supplies will be incompatible with your machine since the configuration of the toner cartridge or supplies vary depending on the countries.

---

## How to purchase

---

To order Samsung-authorized supplies or accessories, contact your local Samsung dealer or the retailer where you purchased your machine, or visit [www.samsungprinter.com](http://www.samsungprinter.com) and select your country/region to obtain information on calling for technical support.

# 9 Specifications

This chapter includes:

- **General specifications**
- **Printer specifications**



## Note

The numbers herein is subject to change according to its install environment.

## General specifications

Item	Specifications and Description
Paper input capacity <sup>a</sup>	100 multi-pages for plain paper (20 lb bond, 75 g/m <sup>2</sup> )
Paper output capacity	30 sheets (face up)
Consumables	1-piece toner cartridge system
Power rating	AC 110 - 127 V or AC 220 - 240 V See the Rating label on the machine for the correct voltage, frequency (hertz) and type of current for your machine.
Power consumption	Average operation mode: Less than 350 W Sleep mode: Less than 8.12 W Power off mode: 0 W
Noise level <sup>b</sup>	Standby mode: Less than 38 dBA
Operating environment	Temperature: 10 °C to 32 °C (50 ° F to 89.6 ° F ) Humidity: 20% to 80% RH
Display	Blue LED Module (65EA Dots)
toner cartridge yield <sup>c</sup>	Standard Yield: Average cartridge yield 2,000 standard pages. (Ships with 1,000 pages Starter/Standard Toner Cartridge) <sup>d</sup>  ** Declared yield value in accordance with ISO/IEC 19752.
Memory	8 MB (Non-extendable)
External dimension (W x D x H)	332 x 375 x 121.5mm (13.1 x 14.8 x 4.8 inches)
Weight	6.95 Kg (15.32 lbs) (including consumables)

Item	Specifications and Description
Package weight	Paper: 1.1 Kg (2.431 lbs)
	Plastic: 0.271 Kg (0.60 lbs)

a. For details about paper input capacity, see page 4.3.

b. Sound Pressure Level, ISO 7779

c. Average cartridge yield declared in accordance with ISO/IEC 19752. The number of pages may be affected by the operating environment, printing interval, media type, and media size.

d. It varies depending on the product configuration.

## Printer specifications

Item	Description
Printing method	Laser Beam Printing
Printing speed <sup>a</sup>	Up to 16 ppm in A4 (17 ppm in Letter)
First print out time	from coldboot: Less than 15 seconds
Print resolution	Up to 1200 dpi class(Best) Effective output
Printer language	SPL (Samsung Printer Language)
OS compatibility & driver <sup>b</sup>	Windows 2000/XP/2003/2008/Vista/7/Server 2008 R2, Various Linux OS, Mac 10.3 ~ 10.6
Interface	USB 2.0 Ethernet 10/100 Base TX 802.11 b/g Wireless LAN

a. Print speed will be affected by operating system used, computing performance, application software, connect on method, media type, media size, and job complexity.

b. Please visit [www.samsungprinter.com](http://www.samsungprinter.com) to download the latest software version.

# 10 Glossary

## Control Panel

A control panel is a flat area where control or monitoring instruments are displayed. They are typically found in top or front of the machine.

## Coverage

This is the printing term used for toner usage measurement on printing and generally used as 5% coverage. 5% coverage means that an A4 sided paper has about 5% image or text on it. So, if the paper or original has complicated images or lots of text on it, the coverage will be over 5% and at the same time, toner usage will be as much as the coverage.

## Default

The first set values.

## DPI

This is the measurement of resolution which is used for printing or scanning. Generally, more dots per inch result in a higher resolution, more visible detail in the image, and a larger file size.

## Duty Cycle

Duty cycle is the page quantity which does not affect printer performance for a month. Generally the printer has the lifespan limitation such as pages per year. The lifespan means the average capacity of print-outs, usually within the warranty period. For example, if the duty cycle is 48,000 pages per month assuming 20 working days, a printer limits 2,400 pages a day, which is not small amount.

## Fuser Unit

This is the part of a laser printer that melts the toner onto the print media. It consists of two hot rollers. After toner is transferred onto the paper, the fuser unit applies heat and pressure to ensure that the toner stays on the paper permanently, which is why paper is warm when it comes out of a laser printer.

## Grayscale

Shades of gray that represent light and dark portions of an image when color images are converted to grayscale; colors are represented by various shades of gray.

## Halftone

This is an image type that simulates grayscale by varying the number of dots. Highly colored areas consist of a large number of dots, while lighter areas consist of a smaller number of dots.

## ISO

The International Organization for Standardization (ISO) is an international standard-setting body composed of representatives from national standards bodies. It produces world-wide industrial and commercial standards.

## LED

A light-emitting diode (LED) is a semiconductor device that indicates the status of a machine.

## Print Media

Media such as papers, labels, and transparencies which can be used on a printer, a scanner, a fax or, a copier.

## OPC Drum

A mechanism that makes a virtual image for print using a laser beam emitted from a laser printer, and it is usually green or gray-colored and cylinder-shaped. An exposing unit of a drum is slowly worn away by its usage of the printer, and it should be replaced appropriately since it becomes scratched from grit in paper.

## PDF

Portable Document Format (PDF) is a proprietary file format developed by Adobe Systems for representing two-dimensional documents in a device-independent and resolution-independent format.

## PPM

Pages Per Minute. PPM shows the printer's speed, how many pages a printer can actually print per minute.

## PRN file

An interface for a device driver, this allows software to interact with the device driver using standard input/output system calls, which simplifies many tasks.

## Resolution

The sharpness of an image, measured in dots per inch (dpi). The higher the dpi, the greater the resolution.

## Toner cartridge

It is a kind of bottle within a machine like a printer which contains toner. Toner is a powder used in laser printers and photocopiers which forms the text and images on the printed paper. Toner can be melted by the heat of the fuser, causing it to bind to the fibers in the paper.

## URL

Uniform Resource Locator (URL) is the global address of documents and resources on the Internet. The first part of the address indicates what protocol to use, the second part specifies the IP address or the domain name where the resource is located.

## USB

Universal serial bus (USB) is a standard that was developed by the USB Implementers Forum, Inc., to connect computers and peripherals. Unlike the parallel port, USB is designed to concurrently connect a single computer USB port to multiple peripherals.

# INDEX

## C

cleaning  
    inside 6.1  
    outside 6.1  
control panel 1.2, 1.4

## D

driver  
    feature 2.2  
    installation 3.3, 3.8

## E

error message 7.7

## F

from the website 6.7

## J

jam  
    clearing paper from the tray 7.1  
    tips for avoiding paper jams 7.1

## L

Linux  
    requirements 2.2  
Linux problems 7.13

## M

Macintosh  
    problems 7.13  
    requirements 2.3  
Maintenance 6.1  
    maintenance parts 6.6  
    toner cartridge 6.3  
message on the display screen 7.7

## N

Network  
    port 1.3  
network  
    requirements 3.2

## O

ordering supplies 8.1  
output support 1.2  
output tray 1.2

## P

paper  
    changing the size 4.5  
    clearing jam 7.1  
    paper feeding problems 7.8  
    setting the paper size of the tray 4.6  
Power switch 1.3  
print media  
    guidelines 4.2  
    selecting print media 4.1  
    specification 4.3  
Printer software CD 2.1  
printing 5.1  
    problem solving 7.8  
printing report 6.1  
problem, solve  
    Linux 7.13  
problems  
    display message 7.7  
    Macintosh 7.13  
    paper feeder 7.8  
    printing 7.8  
    printing quality 7.10  
    Windows 7.12

## Q

quality  
    solving the printing problem 7.10

## R

replacing components  
    toner cartridge 6.5

## S

specifications 9.1, 10.1  
supplied software 2.1  
supplies  
    expected toner cartridge life 6.3  
    ordering supplies 8.1  
SyncThru Web Service 6.7

## T

toner cartridge 1.2  
top cover 1.2  
top cover lever 1.2  
tray 1.2  
    adjusting the width and length 4.5  
tray open button 1.2  
troubleshooting 7.1

## U

USB  
    port 1.3

## W

Windows  
    problems 7.12  
    requirements 2.2



Samsung Printer

---

# Software section

# SOFTWARE SECTION

# CONTENTS

## *Chapter 1:* **INSTALLING PRINTER SOFTWARE IN WINDOWS**

Installing Printer Software .....	4
Installing Software for Local Printing .....	4
Installing Software for Network Printing .....	7
Reinstalling Printer Software .....	11
Removing Printer Software .....	11

## *Chapter 2:* **BASIC PRINTING**

Printing a Document .....	12
Printing to a file (PRN) .....	13
Printer Settings .....	13
Layout Tab .....	14
Paper Tab .....	14
Graphics Tab .....	15
Extras Tab .....	16
About Tab .....	16
Printer Tab .....	16
Using a Favorite Setting .....	17
Using Help .....	17



### **Chapter 3: ADVANCED PRINTING**

Printing Multiple Pages on One Sheet of Paper (N-Up Printing) .....	18
Printing Posters .....	19
Printing a Reduced or Enlarged Document .....	19
Fitting Your Document to a Selected Paper Size .....	19
Using Watermarks .....	20
Using an Existing Watermark .....	20
Creating a Watermark .....	20
Editing a Watermark .....	20
Deleting a Watermark .....	20
Using Overlays .....	21
What is an Overlay? .....	21
Creating a New Page Overlay .....	21
Using a Page Overlay .....	21
Deleting a Page Overlay .....	21

### **Chapter 4: SHARING THE PRINTER LOCALLY**

Setting Up a Host Computer .....	22
Setting Up a Client Computer .....	22

### **Chapter 5: USING SMART PANEL**

Understanding Smart Panel .....	23
Opening the Troubleshooting Guide .....	24
Using Printer Settings Utility .....	24
Using Onscreen Help File .....	24
Changing the Smart Panel Program Settings .....	24

## Chapter 6: USING YOUR PRINTER IN LINUX

Getting Started .....	25
Installing the Unified Linux Driver .....	25
Installing the Unified Linux Driver .....	25
Uninstalling the Unified Linux Driver .....	26
Using SetIP program .....	27
Starting the program .....	27
Using the Unified Driver Configurator .....	27
Opening the Unified Driver Configurator .....	27
Printers Configuration .....	28
Ports Configuration .....	28
Configuring Printer Properties .....	29
Printing a Document .....	29
Printing from Applications .....	29
Printing Files .....	30

## Chapter 7: USING YOUR PRINTER WITH A MACINTOSH

Installing Software .....	31
Uninstalling software .....	31
Using SetIP program .....	32
Setting Up the Printer .....	32
For a Network-connected .....	32
For a USB-connected .....	33
Printing .....	34
Printing a Document .....	34
Changing Printer Settings .....	34
Printing Multiple Pages on One Sheet of Paper .....	35

# 1 Installing Printer Software in Windows

This chapter includes:

- **Installing Printer Software**
- **Reinstalling Printer Software**
- **Removing Printer Software**

---

**NOTE:** The following procedure is based on Windows XP, for other operating systems, refer to the corresponding Windows user's guide or online help.

---

---

## Installing Printer Software

You can install the printer software for local printing or network printing. To install the printer software on the computer, perform the appropriate installation procedure depending on the printer in use.

A printer driver is software that lets your computer communicate with your printer. The procedure to install drivers may differ depending on the operating system you are using.

All applications should be closed on your PC before beginning installation.

## Installing Software for Local Printing

A local printer is a printer directly attached to your computer using the printer cable supplied with your printer, such as a USB or parallel cable. If your printer is attached to a network, skip this step and go to "Installing Software for Network Printing" on page 7.

You can install the printer software using the typical or custom method.

---

**NOTE:** If the "New Hardware Wizard" window appears during the installation procedure, click  in the upper right corner of the box to close the window, or click **Cancel**.

---

## Typical Installation

This is recommended for most users. All components necessary for printer operations will be installed.

- 1 Make sure that the printer is connected to your computer and powered on.
- 2 Insert the supplied CD-ROM into your CD-ROM drive. The CD-ROM should automatically run, and an installation window appears. If the installation window does not appear, click **Start** and then **Run**. Type **X:\Setup.exe**, replacing "X" with the letter which represents your drive and click **OK**. If you use Windows Vista, Windows 7 and Windows Server 2008 R2, click **Start** → **All programs** → **Accessories** → **Run**, and type **X:\Setup.exe**. If the **AutoPlay** window appears in Windows Vista, Windows 7 and Windows Server 2008 R2, click **Run Setup.exe** in **Install or run program** field, and click **Continue** in the **User Account Control** window.
- 3 Click **Next**.

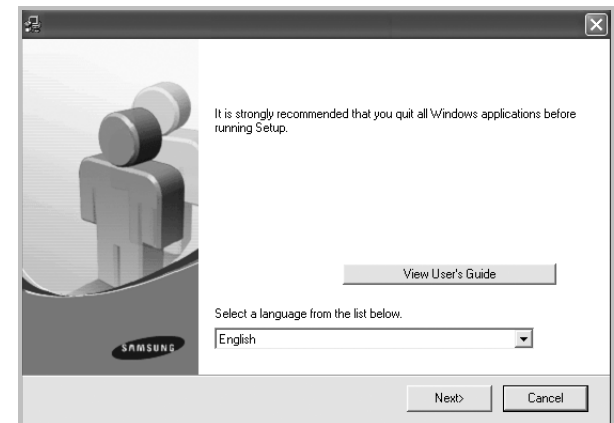

- If necessary, select a language from the drop-down list.
- **View User's Guide:** Allows you to view the User's Guide. If your computer doesn't have Adobe Acrobat, click on this option and it will automatically install Adobe Acrobat Reader for you.

- 4 Select **Typical installation for a local printer**. Click **Next**.

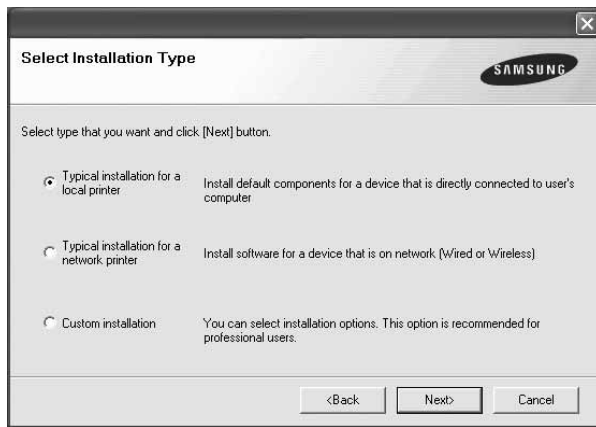

**NOTE:** If your printer is not already connected to the computer, the following window will appear.

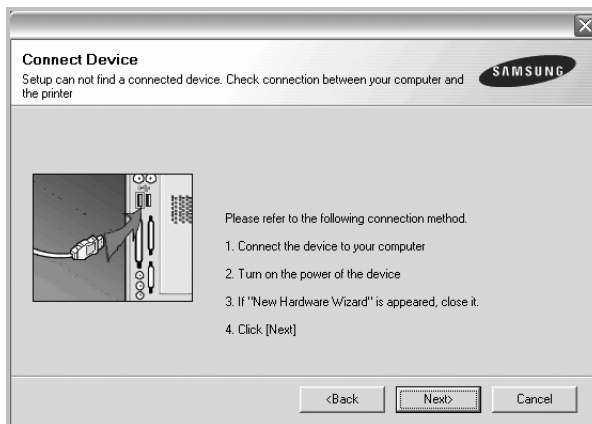

- After connecting the printer, click **Next**.
- If you don't want to connect the printer at this time, click **Next**, and **No** on the following screen. Then the installation will start and a test page will not be printed at the end of the installation.
- *The installation window that appears in this User's Guide may differ depending on the printer and interface in use.*

- 5 After the installation is finished, a window asking you to print a test page appears. If you choose to print a test page, select the checkbox and click **Next**.  
Otherwise, just click **Next** and skip to step 7.
- 6 If the test page prints out correctly, click **Yes**.  
If not, click **No** to reprint it.
- 7 To register yourself as a user of Samsung Printers in order to receive information from Samsung, select the checkbox

and click **Finish**. You are now sent to the Samsung web site.

Otherwise, just click **Finish**.

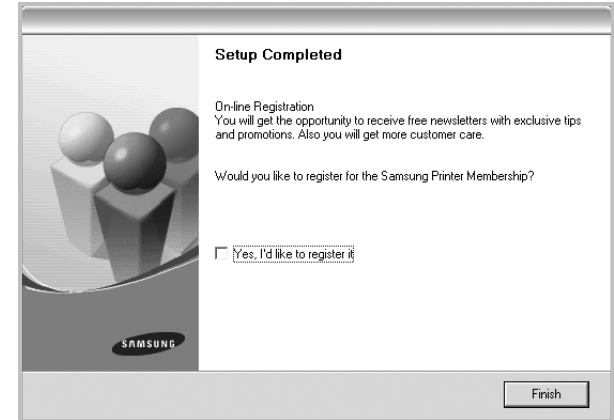

**NOTE:** After setup is complete, if your printer driver doesn't work properly, reinstall the printer driver. See "Reinstalling Printer Software" on page 11.

## Custom Installation

You can choose individual components to install.

- 1 Make sure that the printer is connected to your computer and powered on.
- 2 Insert the supplied CD-ROM into your CD-ROM drive.  
The CD-ROM should automatically run, and an installation window appears.  
If the installation window does not appear, click **Start** and then **Run**. Type **X:\Setup.exe**, replacing "X" with the letter which represents your drive and click **OK**.  
If you use Windows Vista, Windows 7 and Windows Server 2008 R2, click **Start** → **All programs** → **Accessories** → **Run**, and type **X:\Setup.exe**.  
If the **AutoPlay** window appears in Windows Vista, Windows 7 and Windows Server 2008 R2, click **Run Setup.exe** in **Install or run program** field, and click **Continue** in the **User Account Control** window.

### 3 Click **Next**.

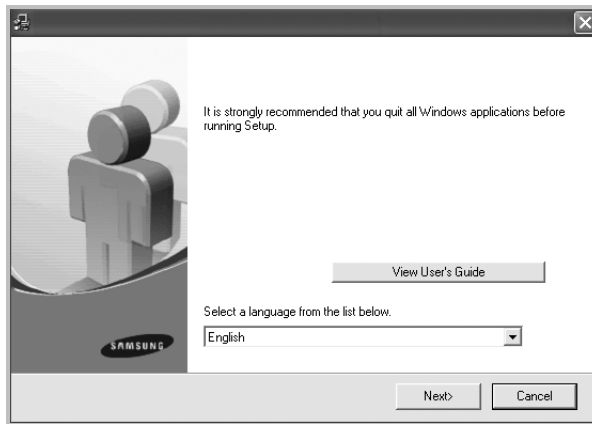

- If necessary, select a language from the drop-down list.
- **View User's Guide:** Allows you to view the User's Guide. If your computer doesn't have Adobe Acrobat, click on this option and it will automatically install Adobe Acrobat Reader for you.

### 4 Select **Custom installation**. Click **Next**.

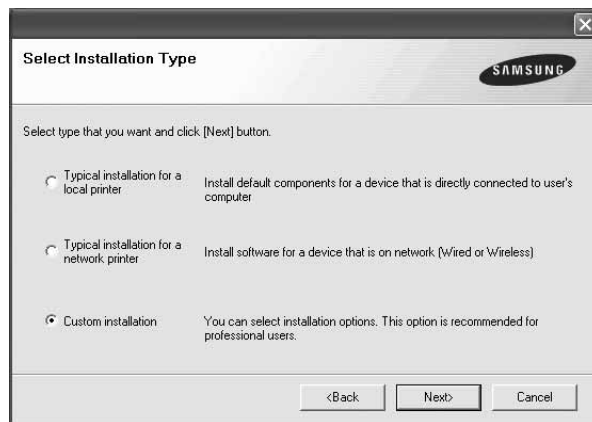

### 5 Select your printer and click **Next**.

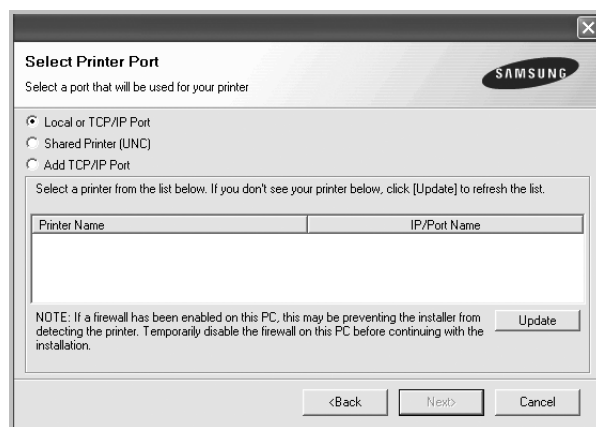

**NOTE:** If your printer is not already connected to the computer, the following window will appear.

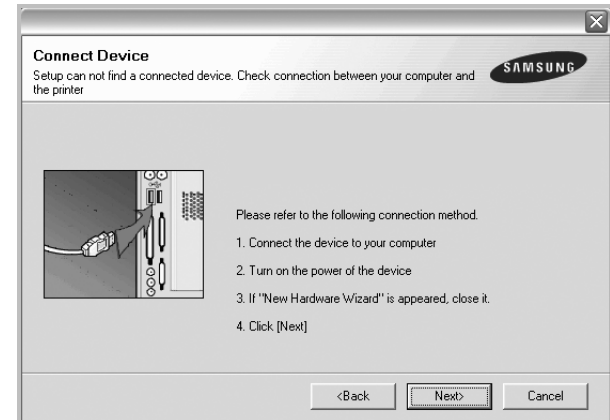

- After connecting the printer, click **Next**.
- If you don't want to connect the printer at this time, click **Next**, and **No** on the following screen. Then the installation will start and a test page will not be printed at the end of the installation.
- *The installation window that appears in this User's Guide may differ depending on the printer and interface in use.*

### 6 Select the components to be installed and click **Next**.

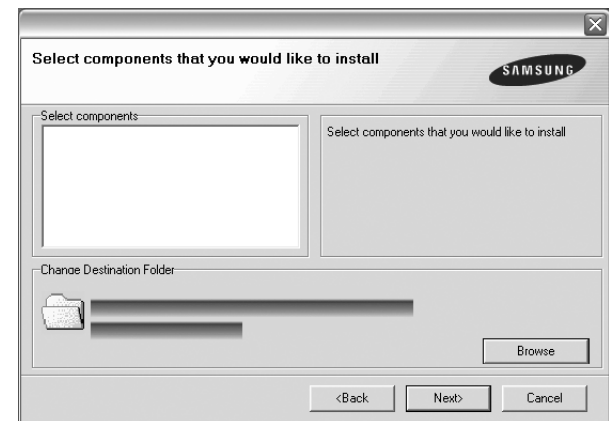

**NOTE:** You can change the desired installation folder by clicking [**Browse**].

**7** After the installation is finished, a window asking you to print a test page appears. If you choose to print a test page, select the checkbox and click **Next**.

Otherwise, just click **Next** and skip to step 9.

**8** If the test page prints out correctly, click **Yes**.

If not, click **No** to reprint it.

- 9 To register yourself as a user of Samsung Printers in order to receive information from Samsung, select the checkbox and click **Finish**. You are now sent to the Samsung web site.

Otherwise, just click **Finish**.

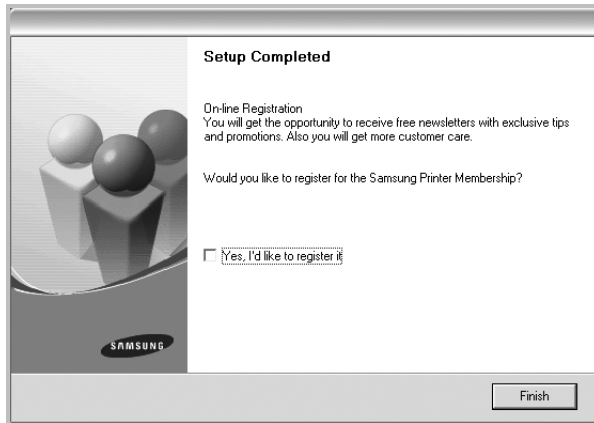

## Installing Software for Network Printing

When you connect your printer to a network, you must first configure the TCP/IP settings for the printer. After you have assigned and verified the TCP/IP settings, you are ready to install the software on each computer on the network.

You can install the printer software using the typical or custom method.

### Typical Installation

This is recommended for most users. All components necessary for printer operations will be installed.

- 1 Make sure that the printer is connected to your network and powered on. For details about connecting to the network, see the supplied printer's User's Guide.
- 2 Insert the supplied CD-ROM into your CD-ROM drive. The CD-ROM should automatically run, and an installation window appears.  
If the installation window does not appear, click **Start** and then **Run**. Type **X:\Setup.exe**, replacing "X" with the letter which represents your drive and click **OK**.  
If you use Windows Vista, Windows 7 and Windows Server 2008 R2, click **Start** → **All programs** → **Accessories** → **Run**, and type **X:\Setup.exe**.  
If the **AutoPlay** window appears in Windows Vista, Windows 7 and Windows Server 2008 R2, click **Run Setup.exe** in **Install or run program** field, and click **Continue** in the **User Account Control** window.
- 3 Click **Next**.

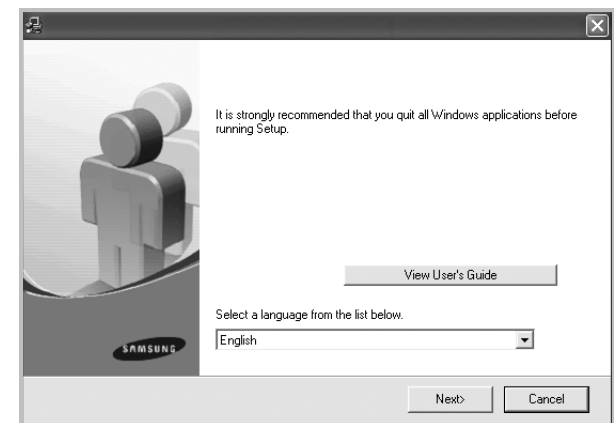

- If necessary, select a language from the drop-down list.
- **View User's Guide:** Allows you to view the User's Guide. If your computer doesn't have Adobe Acrobat, click on this option and it will automatically install Adobe Acrobat Reader for you.

- 4 Select **Typical installation for a network printer**. Click **Next**.

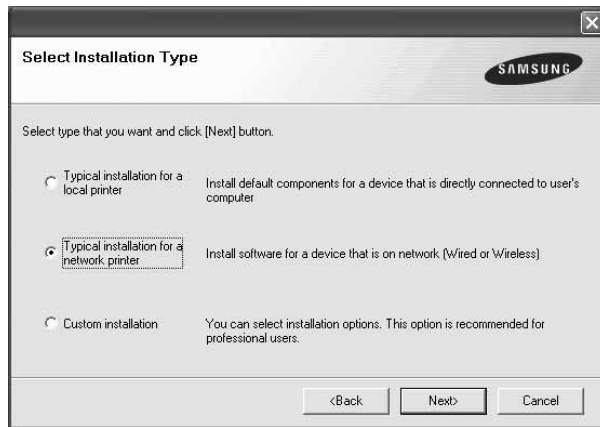

**NOTE:** If your printer is not connected to the network, the following window will appear. Select a setup option you want, click **Next**.

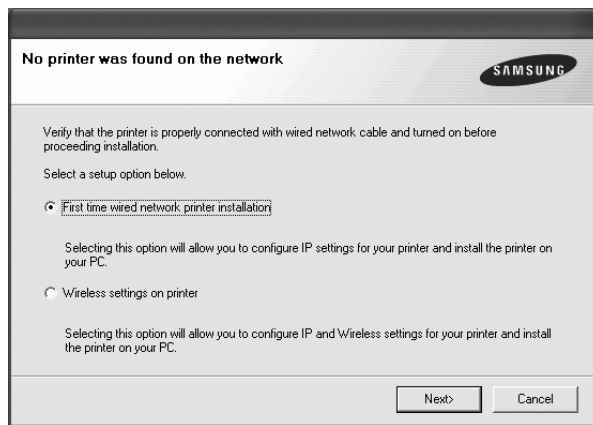

Then the **Set IP Address** window appears. Do as follows:

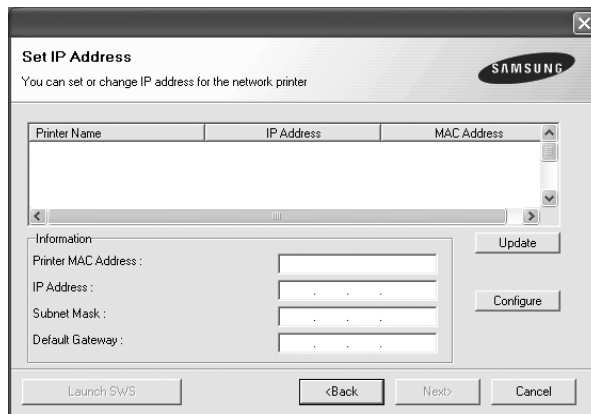

1. Select a printer to be set with a specific IP address from the list.

2. Configure an IP address, subnet mask, and gateway for the printer manually and click **Configure** to set the specific IP address for the network printer.

3. Click **Next**, and go to step 6.

- You can also set the network printer via SyncThru™ Web Service, an embedded web server. Click **Launch SWS** on **Set IP Address** window. Your machine's embedded website opens.

- 5 The list of printers available on the network appears. Select the printer you want to install from the list and then click **Next**.

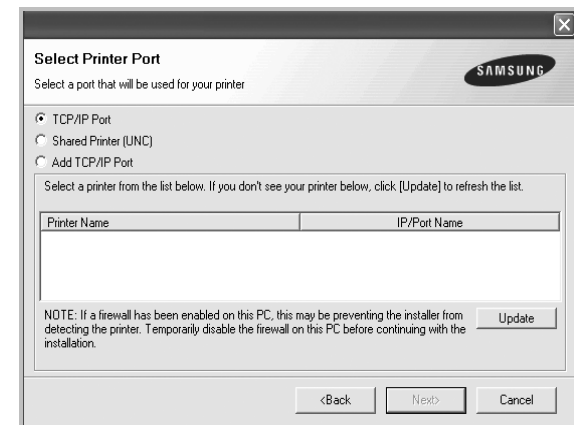

- If you do not see your printer on the list, click **Update** to refresh the list, or select **Add TCP/IP Port** to add your printer to the network. To add the printer to the network, enter the port name and the IP address for the printer.

To verify your printer's IP address or the MAC address, print a Network Configuration page.

- To find a shared network printer (UNC Path), select **Shared Printer [UNC]** and enter the shared name manually or find a shared printer by clicking the **Browse** button.

**NOTE:** If you cannot find your machine in network, please turn off the firewall and click **Update**.

For Windows operating system, click **Start** → **Control Panel** and start windows firewall, and set this option unactivated. For other operating system, refer to its on-line guide.

- 6 After the installation is finished, a window appears asking you to print a test page and to register yourself as a user of Samsung Printers in order to receive information from Samsung. If you so desire, select the corresponding checkbox(es) and click **Finish**.



Otherwise, just click **Finish**.

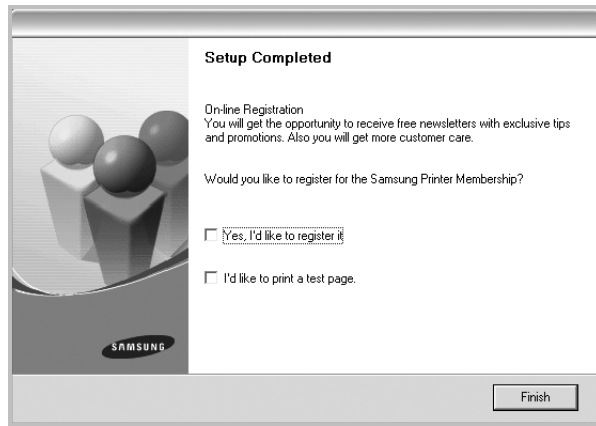

**NOTE:** After setup is complete, if your printer driver doesn't work properly, reinstall the printer driver. See "Reinstalling Printer Software" on page 11.

## Custom Installation

You can choose individual components to install and set a specific IP address.

- 1 Make sure that the printer is connected to your network and powered on. For details about connecting to the network, see the supplied printer's User's Guide.
- 2 Insert the supplied CD-ROM into your CD-ROM drive. The CD-ROM should automatically run, and an installation window appears. If the installation window does not appear, click **Start** and then **Run**. Type **X:\Setup.exe**, replacing "X" with the letter which represents your drive and click **OK**. If you use Windows Vista, Windows 7 and Windows Server 2008 R2, click **Start** → **All programs** → **Accessories** → **Run**, and type **X:\Setup.exe**. If the **AutoPlay** window appears in Windows Vista, Windows 7 and Windows Server 2008 R2, click **Run Setup.exe** in **Install or run program** field, and click **Continue** in the **User Account Control** window.

## 3 Click **Next**.

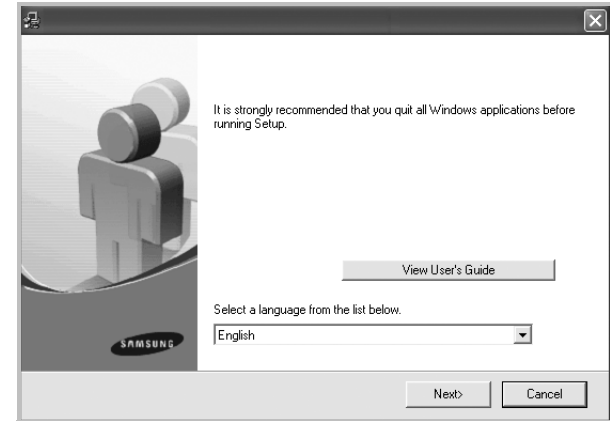

- If necessary, select a language from the drop-down list.
- **View User's Guide:** Allows you to view the User's Guide. If your computer doesn't have Adobe Acrobat, click on this option and it will automatically install Adobe Acrobat Reader for you.

## 4 Select **Custom installation**. Click **Next**.

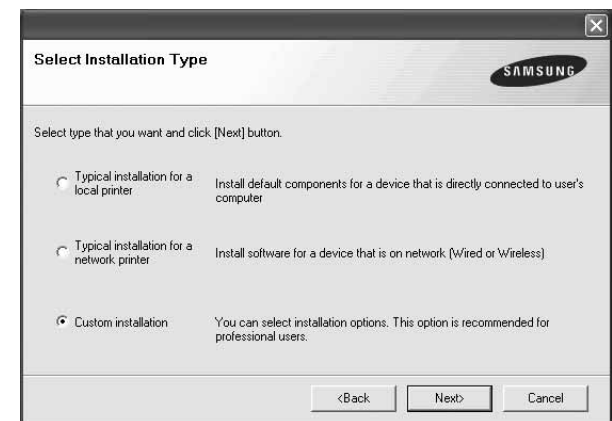

- 5 The list of printers available on the network appears. Select the printer you want to install from the list and then click **Next**.

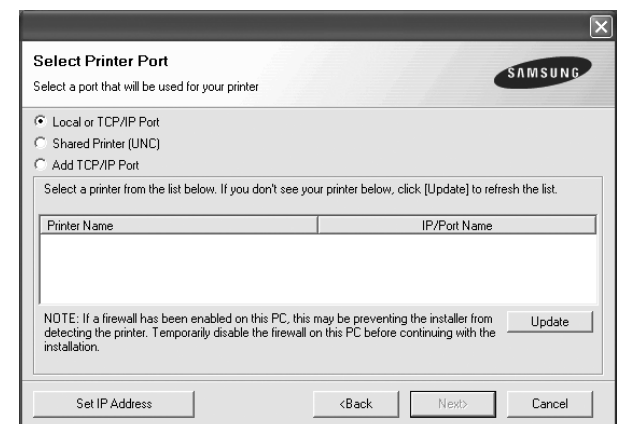

- If you do not see your printer on the list, click **Update** to refresh the list, or select **Add TCP/IP Port** to add your printer to the network. To add the printer to the network, enter the port name and the IP address for the printer.

To verify your printer's IP address or the MAC address, print a Network Configuration page.

- To find a shared network printer (UNC Path), select **Shared Printer [UNC]** and enter the shared name manually or find a shared printer by clicking the **Browse** button.

**NOTE:** If you cannot find your machine in network, please turn off the firewall and click **Update**.

For Windows operating system, click **Start** → **Control Panel** and start windows firewall, and set this option unactivated. For other operating system, refer to its on-line guide.

**TIP:** If you want to set a specific IP address on a specific network printer, click the **Set IP Address** button. The Set IP Address window appears. Do as follows:

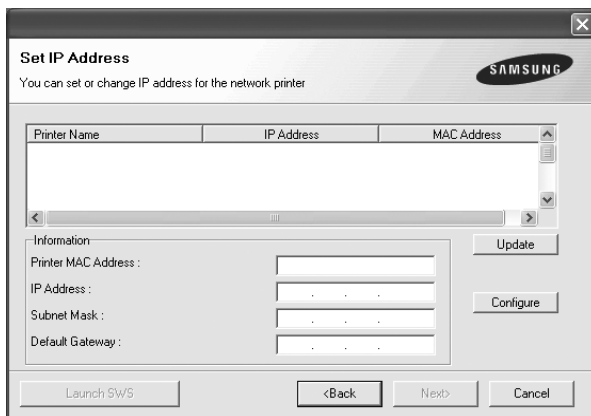

- Select a printer to be set with a specific IP address from the list.
- Configure an IP address, subnet mask, and gateway for the printer manually and click **Configure** to set the specific IP address for the network printer.
- Click **Next**.

- You can also set the network printer via SyncThru™ Web Service, an embedded web server. Click **Launch SWS** on **Set IP Address** window. Your machine's embedded website opens.

- 6 Select the components to be installed. After selecting the components, the following window appears. You can also change the printer name, set the printer to be shared on the network, set the printer as the default printer, and change the port name of each printer. Click **Next**.

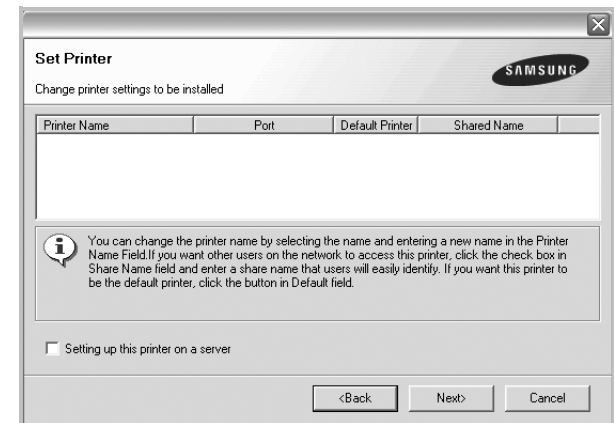

To install this software on a server, select the **Setting up this printer on a server** checkbox.

- 7 After the installation is finished, a window appears asking you to print a test page and to register yourself as a user of Samsung Printers in order to receive information from Samsung. If you so desire, select the corresponding checkbox(es) and click **Finish**.

Otherwise, just click **Finish**.

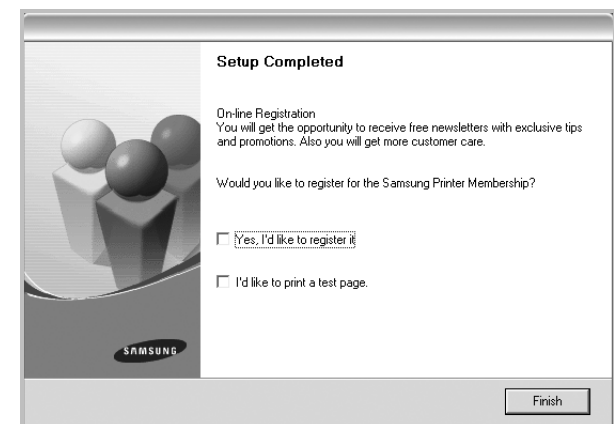

**NOTE:** After setup is complete, if your printer driver doesn't work properly, reinstall the printer driver. See "Reinstalling Printer Software" on page 11.

## Reinstalling Printer Software

You can reinstall the software if installation fails.

- 1 Start Windows.
- 2 From the **Start** menu select **Programs** or **All Programs** → **your printer driver name** → **Maintenance**.
- 3 Select **Repair** and click **Next**.
- 4 The list of printers available on the network appears. Select the printer you want to install from the list and then click **Next**.

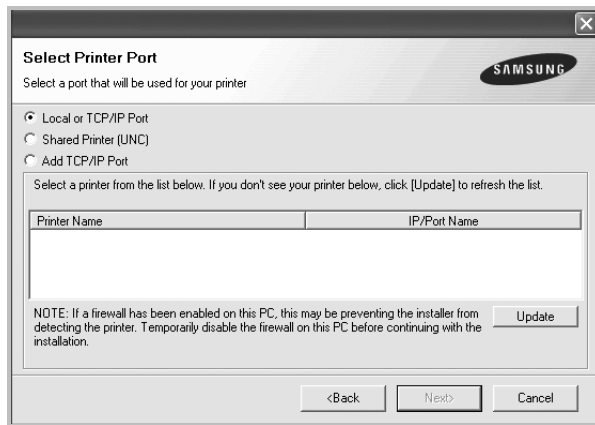

- If you do not see your printer on the list, click **Update** to refresh the list, or select **Add TCP/IP Port** to add your printer to the network. To add the printer to the network, enter the port name and the IP address for the printer.
- To find a shared network printer (UNC Path), select **Shared Printer [UNC]** and enter the shared name manually or find a shared printer by clicking the **Browse** button.

You will see a component list so that you can reinstall any item individually.

**NOTE:** If your printer is not already connected to the computer, the following window will appear.

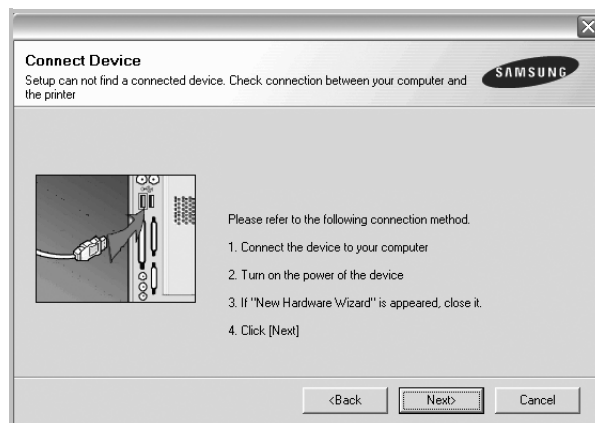

- After connecting the printer, click **Next**.
- If you don't want to connect the printer at this time, click **Next**, and **No** on the following screen. Then the installation will start and a test page will not be printed at the end of the installation.
- *The reinstallation window that appears in this User's Guide may differ depending on the printer and interface in use.*

- 5 Select the components you want to reinstall and click **Next**.  
If you installed the printer software for local printing and you select **your printer driver name**, the window asking you to print a test page appears. Do as follows:
  - a. To print a test page, select the check box and click **Next**.
  - b. If the test page prints out correctly, click **Yes**.  
If it doesn't, click **No** to reprint it.
- 6 When the reinstallation is done, click **Finish**.

## Removing Printer Software

- 1 Start Windows.
- 2 From the **Start** menu select **Programs** or **All Programs** → **your printer driver name** → **Maintenance**.
- 3 Select **Remove** and click **Next**.  
You will see a component list so that you can remove any item individually.
- 4 Select the components you want to remove and then click **Next**.
- 5 When your computer asks you to confirm your selection, click **Yes**.  
The selected driver and all of its components are removed from your computer.
- 6 After the software is removed, click **Finish**.

## 2 Basic Printing

This chapter explains the printing options and common printing tasks in Windows.

This chapter includes:

- **Printing a Document**
- **Printing to a file (PRN)**
- **Printer Settings**
  - **Layout Tab**
  - **Paper Tab**
  - **Graphics Tab**
  - **Extras Tab**
  - **About Tab**
  - **Printer Tab**
  - **Using a Favorite Setting**
  - **Using Help**

---

### Printing a Document

---

#### NOTES:

- Your printer driver **Properties** window that appears in this User's Guide may differ depending on the printer in use. However the composition of the printer properties window is similar.
  - *Check the Operating System(s) that are compatible with your printer. Please refer to the OS Compatibility section of Printer Specifications in your Printer User's Guide.*
  - If you need to know the exact name of your printer, you can check the supplied CD-ROM.
- 

The following procedure describes the general steps required for printing from various Windows applications. The exact steps for printing a document may vary depending on the application program you are using. Refer to the User's Guide of your software application for the exact printing procedure.

- 1 Open the document you want to print.
- 2 Select **Print** from the **File** menu. The Print window is displayed. It may look slightly different depending on your application.

The basic print settings are selected within the Print window. These settings include the number of copies and print range.

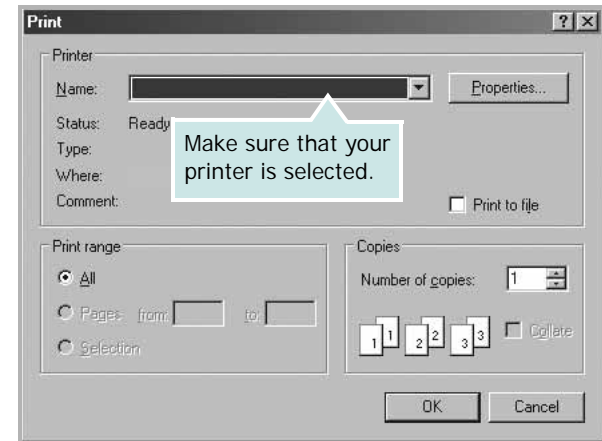

- 3 Select **your printer driver** from the **Name** drop-down list.

To take advantage of the printer features provided by your printer driver, click **Properties** or **Preferences** in the application's Print window. For details, see "Printer Settings" on page 13.

If you see **Setup**, **Printer**, or **Options** in your Print window, click it instead. Then click **Properties** on the next screen.

Click **OK** to close the printer properties window.

- 4 To start the print job, click **OK** or **Print** in the Print window.

---

## Printing to a file (PRN)

You will sometimes need to save the print data as a file for your purpose.

To create a file:

- 1 Check the **Print to file** box at the **Print** window.

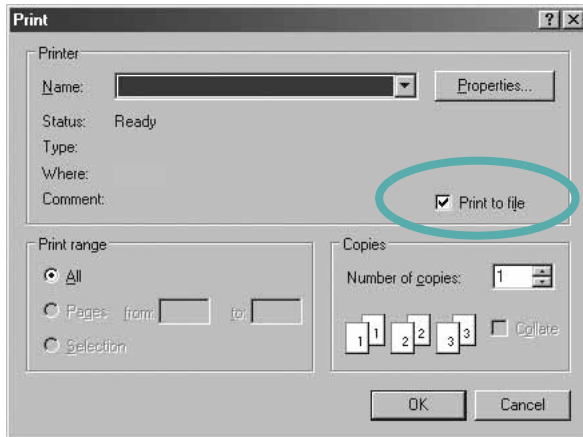

- 2 Select the folder and assign a name of the file and then click OK.

---

## Printer Settings

You can use the printer properties window, which allows you to access all of the printer options you need when using your printer. When the printer properties are displayed, you can review and change the settings needed for your print job.

Your printer properties window may differ, depending on your operating system. This Software User's Guide shows the Properties window for Windows XP.

Your printer driver **Properties** window that appears in this User's Guide may differ depending on the printer in use.

If you access printer properties through the Printers folder, you can view additional Windows-based tabs (refer to your Windows User's Guide) and the Printer tab (see "Printer Tab" on page 16).

---

### NOTES:

- Most Windows applications will override settings you specify in the printer driver. Change all print settings available in the software application first, and change any remaining settings using the printer driver.
  - The settings you change remain in effect only while you are using the current program. **To make your changes permanent**, make them in the Printers folder.
  - The following procedure is for Windows XP. For other Windows OS, refer to the corresponding Windows User's Guide or online help.
    1. Click the Windows **Start** button.
    2. Select **Printers and Faxes**.
    3. Select **your printer driver icon**.
    4. Right-click on the printer driver icon and select **Printing Preferences**.
    5. Change the settings on each tab, click OK.
-

## Layout Tab

The **Layout** tab provides options to adjust how the document appears on the printed page.

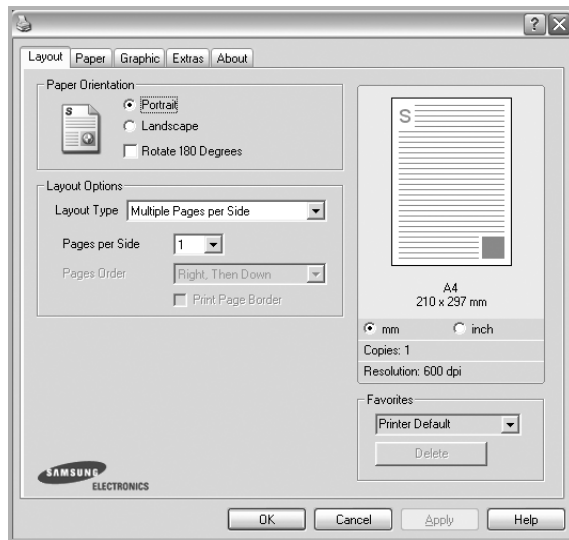

### Paper Orientation

**Paper Orientation** allows you to select the direction in which information is printed on a page.

- **Portrait** prints across the width of the page, letter style.
- **Landscape** prints across the length of the page, spreadsheet style.
- **Rotate** allows you to rotate the page the selected degrees.

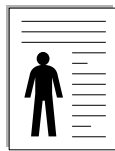

▲ Portrait

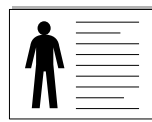

▲ Landscape

### Layout Options

**Layout Options** allows you to select advanced printing options. You can choose **Multiple Pages per Side** and **Poster Printing**.

- For details, see “Printing Multiple Pages on One Sheet of Paper (N-Up Printing)” on page 18.
- For details, see “Printing Posters” on page 19

## Paper Tab

Use the following options to set the basic paper handling specifications when you access the printer properties. See “Printing a Document” on page 12 for more information on accessing printer properties.

Click the **Paper** tab to access various paper properties.

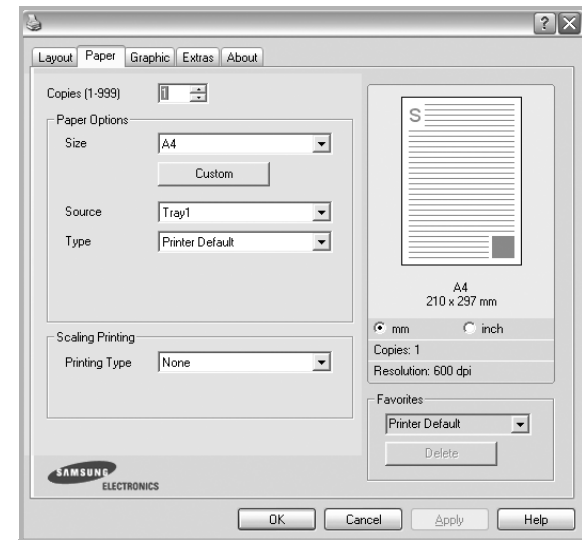

### Copies

**Copies** allows you to choose the number of copies to be printed. You can select 1 to 999 copies.

### Paper Options

#### Size

**Size** allows you to set the size of paper you loaded in the tray. If the required size is not listed in the **Size** box, click **Custom**. When the **Custom Paper Setting** window appears, set the paper size and click **OK**. The setting appears in the list so that you can select it.

#### Source

Make sure that **Source** is set to the corresponding paper tray.

#### Type

Set **Type** to correspond to the paper loaded in the tray from which you want to print. This will let you get the best quality printout. If not, print quality may not be achieved as you want.

### Scaling Printing

**Scaling Printing** allows you to automatically or manually scale your print job on a page. You can choose from **None**, **Reduce/Enlarge**, and **Fit to Page**.

- For details, see “Printing a Reduced or Enlarged Document” on page 19.
- For details, see “Fitting Your Document to a Selected Paper Size” on page 19.

## Graphics Tab

Use the following Graphic options to adjust the print quality for your specific printing needs. See “Printing a Document” on page 12 for more information on accessing printer properties.

Click the **Graphic** tab to display the properties shown below.

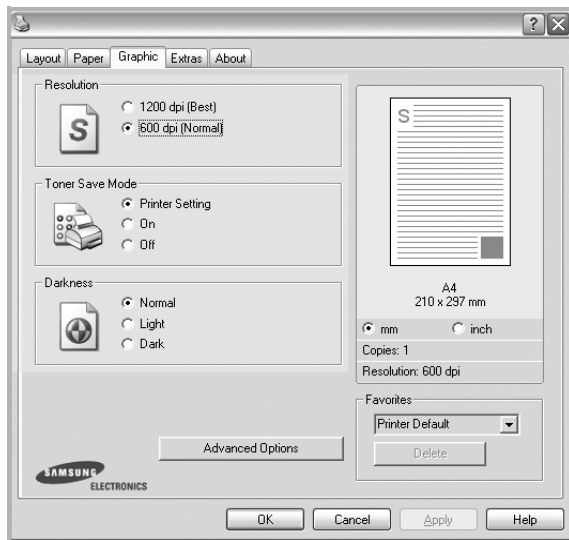

### Resolution

*The Resolution options you can select may vary depending on your printer model.* The higher the setting, the sharper the clarity of printed characters and graphics. The higher setting also may increase the time it takes to print a document.

### Toner Save Mode

Selecting this option extends the life of your toner cartridge and reduces your cost per page without a significant reduction in print quality. *Some printers do not support this feature.*

- **Printer Setting:** If you select this option, this feature is determined by the setting you've made on the control panel of the printer.
- **On:** Select this option to allow the printer to use less toner on each page.
- **Off:** If you don't need to save toner when printing a document, select this option.

### Darkness

Use this option to lighten or darken your print job. *Some printers do not support this feature.*

- **Normal:** This setting is for normal documents.
- **Light:** This setting is for bolder line widths or darker gray-scale images.
- **Dark:** This setting is for finer line width, higher definition in graphics, and lighter gray-scale images.

## Advanced Options

You can set advanced settings by clicking the **Advanced Options** button.

- **Grayscale Enhancement:** **Grayscale Enhancement** allows users to preserve the details of nature photos, and improve contrast and readability among gray-scaled colors, when printing color documents in grayscale.
- **Print All Text To Black:** When the **Print All Text To Black** option is checked, all text in your document prints solid black, regardless of the color it appears on the screen.
- **Print All Text to Darken:** When the **Print All Text to Darken** option is checked, all text in your document is allowed to print darker than on a normal document.



## Extras Tab

You can select output options for your document. See “Printing a Document” on page 12 for more information about accessing the printer properties.

Click the **Extras** tab to access the following feature:

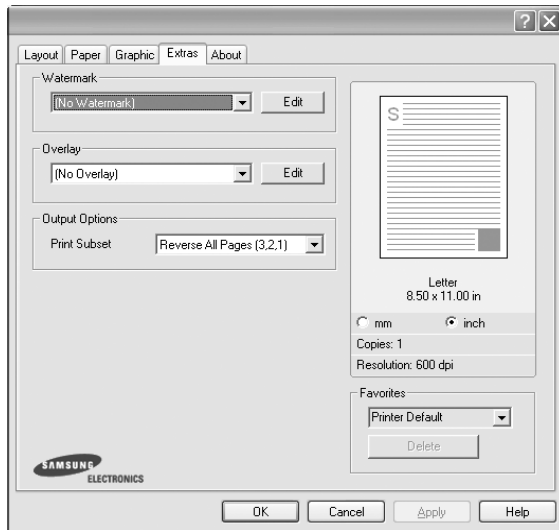

### Watermark

You can create a background text image to be printed on each page of your document. For details, see “Using Watermarks” on page 20.

### Overlay

Overlays are often used to take the place of preprinted forms and letterhead paper. For details, see “Using Overlays” on page 21.

### Output Options

- **Print Subset:** You can set the sequence in which the pages print. Select the print order from the drop-down list.
  - **Normal (1,2,3):** Your printer prints all pages from the first page to the last page.
  - **Reverse All Pages (3,2,1):** When you use this feature, you do not need to sort the print-out by stacks.
  - **Print Odd Pages:** Your printer prints only the odd numbered pages of the document.
  - **Print Even Pages:** Your printer prints only the even numbered pages of the document.
- **Reprint When Jammed:** When this option is checked, the printer retains the image of a printed page until the printer signals that the page has successfully exited the printer.

## About Tab

Use the **About** tab to display the copyright notice and the version number of the driver. If you have an Internet browser, you can connect to the Internet by clicking on the web site icon. See “Printing a Document” on page 12 for more information about accessing printer properties.

## Printer Tab

If you access printer properties through the **Printers** folder, you can view the **Printer** tab. You can set the printer configuration.

The following procedure is for Windows XP. For other Windows OS, refer to the corresponding Windows User's Guide or online help.

- 1 Click the Windows **Start** menu.
- 2 Select **Printers and Faxes**.
- 3 Select **your printer driver** icon.
- 4 Right-click on the printer driver icon and select **Properties**.
- 5 Click the **Printer** tab and set the options.

## Using a Favorite Setting

The **Favorites** option, which is visible on each properties tab, allows you to save the current properties settings for future use.

To save a **Favorites** item:

- 1 Change the settings as needed on each tab.
- 2 Enter a name for the item in the **Favorites** input box.

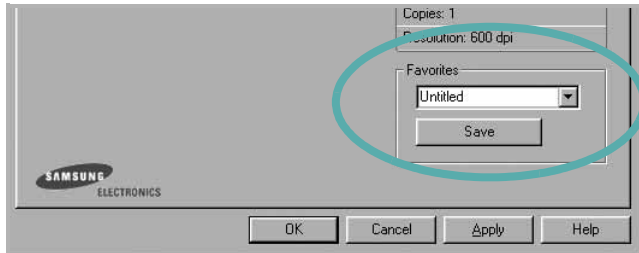

- 3 Click **Save**.

When you save **Favorites**, all current driver settings are saved.

To use a saved setting, select the item from the **Favorites** drop down list. The printer is now set to print according to the Favorites setting you selected.

To delete a Favorites item, select it from the list and click **Delete**.

You can also restore the printer driver's default settings by selecting **Printer Default** from the list.

## Using Help

Your printer has a help screen that can be activated by clicking the **Help** button in the printer properties window. These help screens give detailed information about the printer features provided by the printer driver.

You can also click  from the upper right corner of the window, and then click on any setting.

# 3 Advanced Printing

This chapter explains printing options and advanced printing tasks.

---

**NOTE:**

- Your printer driver **Properties** window that appears in this User's Guide may differ depending on the printer in use. However the composition of the printer properties window is similar.
  - If you need to know the exact name of your printer, you can check the supplied CD-ROM.
- 

This chapter includes:

- **Printing Multiple Pages on One Sheet of Paper (N-Up Printing)**
- **Printing Posters**
- **Printing a Reduced or Enlarged Document**
- **Fitting Your Document to a Selected Paper Size**
- **Using Watermarks**
- **Using Overlays**

---

## Printing Multiple Pages on One Sheet of Paper (N-Up Printing)

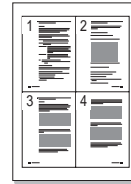

You can select the number of pages to print on a single sheet of paper. To print more than one page per sheet, the pages will be reduced in size and arranged in the order you specify. You can print up to 16 pages on one sheet.

- 1** To change the print settings from your software application, access printer properties. See “Printing a Document” on page 12.
- 2** From the **Layout** tab, choose **Multiple Pages per Side** in the **Layout Type** drop-down list.
- 3** Select the number of pages you want to print per sheet (1, 2, 4, 6, 9, or 16) in the **Pages per Side** drop-down list.
- 4** Select the page order from the **Page Order** drop-down list, if necessary.  
Check **Print Page Border** to print a border around each page on the sheet.
- 5** Click the **Paper** tab, select the paper source, size, and type.
- 6** Click **OK** and print the document.

## Printing Posters

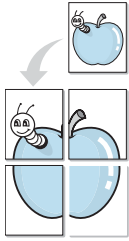

This feature allows you to print a single-page document onto 4, 9, or 16 sheets of paper, for the purpose of pasting the sheets together to form one poster-size document.

- 1 To change the print settings from your software application, access printer properties. See “Printing a Document” on page 12.
- 2 Click the **Layout** tab, select **Poster Printing** in the **Layout Type** drop-down list.
- 3 Configure the poster option:

You can select the page layout from **Poster<2x2>**, **Poster<3x3>** or **Poster<4x4>**. If you select **Poster<2x2>**, the output will be automatically stretched to cover 4 physical pages.

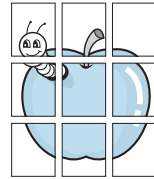
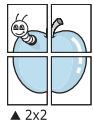

Specify an overlap in millimeters or inches to make it easier to pasting the sheets together.

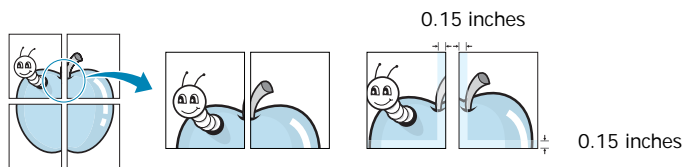

- 4 Click the **Paper** tab, select the paper source, size, and type.
- 5 Click **OK** and print the document. You can complete the poster by pasting the sheets together.

## Printing a Reduced or Enlarged Document

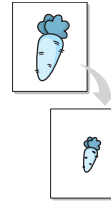

You can change the size of a page’s content to appear larger or smaller on the printed page.

- 1 To change the print settings from your software application, access printer properties. See “Printing a Document” on page 12.
- 2 From the **Paper** tab, select **Reduce/Enlarge** in the **Printing Type** drop-down list.
- 3 Enter the scaling rate in the **Percentage** input box. You can also click the ▼ or ▲ button.
- 4 Select the paper source, size, and type in **Paper Options**.
- 5 Click **OK** and print the document.

## Fitting Your Document to a Selected Paper Size

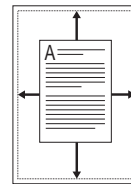

This printer feature allows you to scale your print job to any selected paper size regardless of the digital document size. This can be useful when you want to check fine details on a small document.

- 1 To change the print settings from your software application, access printer properties. See “Printing a Document” on page 12.
- 2 From the **Paper** tab, select **Fit to Page** in the **Printing Type** drop-down list.
- 3 Select the correct size from the **Output size** drop-down list.
- 4 Select the paper source, size, and type in **Paper Options**.
- 5 Click **OK** and print the document.

---

## Using Watermarks

The Watermark option allows you to print text over an existing document. For example, you may want to have large gray letters reading "DRAFT" or "CONFIDENTIAL" printed diagonally across the first page or all pages of a document.

There are several predefined watermarks that come with the printer, and they can be modified, or you can add new ones to the list.

### Using an Existing Watermark

- 1 To change the print settings from your software application, access printer properties. See "Printing a Document" on page 12.
- 2 Click the **Extras** tab, and select the desired watermark from the **Watermark** drop-down list. You will see the selected watermark in the preview image.
- 3 Click **OK** and start printing.

---

**NOTE:** The preview image shows how the page will look when it is printed.

---

### Creating a Watermark

- 1 To change the print settings from your software application, access printer properties. See "Printing a Document" on page 12.
- 2 Click the **Extras** tab, and click the **Edit** button in the **Watermark** section. The **Edit Watermark** window appears.
- 3 Enter a text message in the **Watermark Message** box. You can enter up to 40 characters. The message displays in the preview window.  
When the **First Page Only** box is checked, the watermark prints on the first page only.
- 4 Select watermark options.  
You can select the font name, style, size, or grayscale level from the **Font Attributes** section and set the angle of the watermark from the **Message Angle** section.
- 5 Click **Add** to add a new watermark to the list.
- 6 When you have finished editing, click **OK** and start printing.

To stop printing the watermark, select **(No Watermark)** from the **Watermark** drop-down list.

## Editing a Watermark

- 1 To change the print settings from your software application, access printer properties. See "Printing a Document" on page 12.
- 2 Click the **Extras** tab and click the **Edit** button in the **Watermark** section. The **Edit Watermark** window appears.
- 3 Select the watermark you want to edit from the **Current Watermarks** list and change the watermark message and options.
- 4 Click **Update** to save the changes.
- 5 Click **OK** until you exit the Print window.

## Deleting a Watermark

- 1 To change the print settings from your software application, access printer properties. See "Printing a Document" on page 12.
- 2 From the **Extras** tab, click the **Edit** button in the Watermark section. The **Edit Watermark** window appears.
- 3 Select the watermark you want to delete from the **Current Watermarks** list and click **Delete**.
- 4 Click **OK** until you exit the Print window.

---

## Using Overlays

### What is an Overlay?



An overlay is text and/or images stored in the computer hard disk drive (HDD) as a special file format that can be printed on any document. Overlays are often used to take the place of preprinted forms and letterhead paper. Rather than using preprinted letterhead, you can create an overlay containing the exact same information that is currently on your letterhead. To print a letter with your company's letterhead, you do not need to load preprinted letterhead paper in the printer. You need only tell the printer to print the letterhead overlay on your document.

### Creating a New Page Overlay



To use a page overlay, you must create a new page overlay containing your logo or image.

- 1 Create or open a document containing text or an image for use in a new page overlay. Position the items exactly as you wish them to appear when printed as an overlay.
- 2 To save the document as an overlay, access printer properties. See "Printing a Document" on page 12.
- 3 Click the **Extras** tab, and click **Edit** button in the **Overlay** section.
- 4 In the Edit Overlay window, click **Create Overlay**.
- 5 In the Create Overlay window, type a name of up to eight characters in the **File name** box. Select the destination path, if necessary. (The default is C:\Formover).
- 6 Click **Save**. The name appears on the **Overlay List** box.
- 7 Click **OK** or **Yes** to finish creating.  
The file is not printed. Instead it is stored on your computer hard disk drive.

---

**NOTE:** The overlay document size must be the same as the documents you print with the overlay. Do not create an overlay with a watermark.

---

## Using a Page Overlay

After an overlay has been created, it is ready to be printed with your document. To print an overlay with a document:

- 1 Create or open the document you want to print.
- 2 To change the print settings from your software application, access printer properties. See "Printing a Document" on page 12.
- 3 Click the **Extras** tab.
- 4 Select the desired overlay from the **Overlay** drop-down list box.
- 5 If the overlay file you want does not appear in the **Overlay** list, click **Edit** button and **Load Overlay**, and select the overlay file.

If you have stored the overlay file you want to use in an external source, you can also load the file when you access the **Load Overlay** window.

After you select the file, click **Open**. The file appears in the **Overlay List** box and is available for printing. Select the overlay from the **Overlay List** box.

- 6 If necessary, click **Confirm Page Overlay When Printing**. If this box is checked, a message window appears each time you submit a document for printing, asking you to confirm your wish to print an overlay on your document.  
If this box is not checked and an overlay has been selected, the overlay automatically prints with your document.
- 7 Click **OK** or **Yes** until printing begins.  
The selected overlay downloads with your print job and prints on your document.

---

**NOTE:** The resolution of the overlay document must be the same as that of the document you will print with the overlay.

---

## Deleting a Page Overlay

You can delete page overlays that you no longer use.

- 1 In the printer properties window, click the **Extras** tab.
- 2 Click the **Edit** button in the **Overlay** section.
- 3 Select the overlay you want to delete from the **Overlay List** box.
- 4 Click **Delete Overlay**.
- 5 When a confirming message window appears, click **Yes**.
- 6 Click **OK** until you exit the Print window.

# 4 Sharing the Printer Locally

You can connect the printer directly to a selected computer, which is called “host computer,” on the network.

The following procedure is for Windows XP. For other Windows OS, refer to the corresponding Windows User's Guide or online help.

---

## NOTES:

- Check the Operating System(s) that are compatible with your printer. Please refer to the OS Compatibility section of Printer Specifications in your Printer User's Guide.
  - If you need to know the exact name of your printer, you can check the supplied CD-ROM.
- 

---

## Setting Up a Host Computer

- 1 Start Windows.
- 2 From the **Start** menu select **Printers and Faxes**.
- 3 Double-click **your printer driver icon**.
- 4 From the **Printer** menu, select **Sharing**.
- 5 Check the **Share this printer** box.
- 6 Fill in the **Shared Name** field, and then click **OK**.

---

## Setting Up a Client Computer

- 1 Right-click the Windows **Start** button and select **Explore**.
- 2 Select **My Network Places** and then right-click **Search for Computers**.
- 3 Fill in the IP address of host computer in **Computer name** field, and click **Search**. (In case host computer requires **User name** and **Password**, fill in User ID and password of host computer account.)
- 4 Double-click **Printers and Faxes**.
- 5 Right-click printer driver icon, select **Connect**.
- 6 Click **Yes**, if the installation confirm message appears.



# 5 Using Smart Panel

Smart Panel is a program that monitors and informs you of the status of the printer, and allows you to customize the printer's settings. If you are a Windows or Macintosh OS user, Smart Panel is installed automatically when you install the printer software. If you are a Linux OS user, download Smart Panel from the Samsung website ([www.samsung.com/printer](http://www.samsung.com/printer)) and install.

## NOTES:

- To use this program, you need:
  - To check for Operating System(s) that are compatible with your printer, refer to Printer Specifications in your Printer User's Guide.
  - Mac OS X 10.3 or higher
  - Linux. To check for Linux systems that are compatible with your printer, refer to Printer Specifications in your Printer User's Guide.
  - Internet Explorer version 5.0 or higher for flash animation in HTML Help.
- If you need to know the exact name of your printer, you can check the supplied CD-ROM.

## Understanding Smart Panel

If an error occurs while printing, Smart Panel appears automatically, showing the error.

You can also launch Smart Panel manually. Double-click the Smart Panel icon on the Windows task bar (in Windows), or Notification Area (in Linux). You can also click it on the status bar (in Mac OS X).

Double-click this icon in Windows.

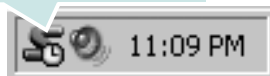

Click this icon in Mac OS X.



Click this icon in Linux.



If you are a Windows user, from the **Start** menu, select **Programs** or **All Programs** → **your printer driver name** → **Smart Panel**.

## NOTES:

- If you have already installed more than one Samsung printer, first select the printer model you want in order to use the corresponding Smart Panel. Right-click (in Windows or Linux) or click (in Mac OS X) the Smart Panel icon and select **your printer name**.
- The Smart Panel window and its contents shown in this Software User's Guide may differ depending on the printer or Operating System in use.

The Smart Panel program displays the current status of the printer, the level of toner remaining in the toner cartridge(s) and various other information. You can also change settings.

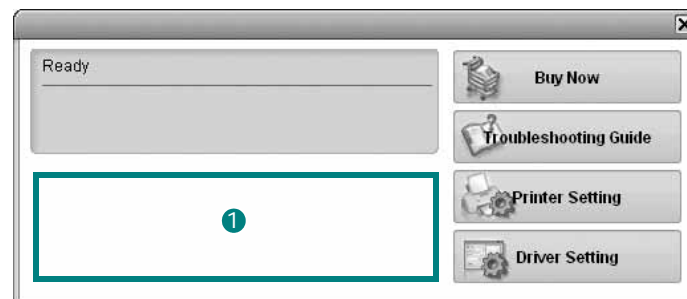

### 1 Toner Level

You can view the level of toner remaining in the toner cartridge(s). The printer and the number of toner cartridge(s) shown in the above window may differ depending on the printer in use. Any printers do not have this feature.

### Buy Now

You can order replacement toner cartridge(s) online.

### Troubleshooting Guide

You can view Help to solve problems.

### Printer Setting

You can configure various printer settings in the Printer Settings Utility window. Any printers do not have this feature.

---

**NOTE:** If your machine is connected a network, the **SyncThru Web Service** window appears instead of the Printer Settings Utility window. This program is supported in Windows, MAC OS X. But in Linux, it is supported only in certain software, such as Internet Explorer 5.5 or higher, Safari 1.3 or higher, Mozilla FireFox 1.5 or higher.

---

#### **Driver Setting (Only for Windows)**

You can use the printer properties window, which allows you to access all of the printer options you need for using your printer. For details, See “Printer Settings” on page 13.

---

## **Opening the Troubleshooting Guide**

Using the troubleshooting guide, you can view solutions for error status problems.

Right-click (in Windows or Linux) or click (in Mac OS X) the Smart Panel icon and select **Troubleshooting Guide**.

---

## **Using Printer Settings Utility**

Using the Printer Settings Utility, you can configure and check print settings.

- 1** Right-click the Smart Panel icon and select **Printer Setting**.
- 2** Change the settings.
- 3** To send the changes to the printer, click the **Apply** button.

---

**NOTES:** If your printer is connected to a network, the **SyncThru Web Service** window appears instead of the Printer Settings Utility window.

---

## **Using Onscreen Help File**

For more information about **Printer Settings Utility**, click .

---

## **Changing the Smart Panel Program Settings**

Right-click (in Windows or Linux) or click (in Mac OS X) the Smart Panel icon and select **Options**. Select the settings you want from the **Options** window.

# 6 Using Your Printer in Linux

You can use your machine in a Linux environment.

This chapter includes:

- **Getting Started**
- **Installing the Unified Linux Driver**
- **Using SetIP program**
- **Using the Unified Driver Configurator**
- **Configuring Printer Properties**
- **Printing a Document**

## Getting Started

You need to download Linux software package from the Samsung website ([www.samsung.com/printer](http://www.samsung.com/printer)) to install the printer softwares.

After the driver is installed on your Linux system, the driver package allows you to monitor a number of machine devices via fast ECP parallel ports and USB simultaneously.

The Unified Linux Driver package is supplied with a smart and flexible installation program. You don't need to search for additional components that might be necessary for the Unified Linux Driver software: all required packages will be carried onto your system and installed automatically; this is possible on a wide set of the most popular Linux clones.

## Installing the Unified Linux Driver

### Installing the Unified Linux Driver

- 1 Make sure that you connect your machine to your computer. Turn both the computer and the machine on.
- 2 When the Administrator Login window appears, type in *root* in the Login field and enter the system password.

**NOTE:** You must log in as a super user (*root*) to install the printer software. If you are not a super user, ask your system administrator.

- 3 From the Samsung website, download and unpack the Unified Linux Driver package to your computer.
- 4 Click the  icon at the bottom of the desktop. When the Terminal screen appears, type in:

```
[root@localhost root]#tar zxf [FilePath]/
UnifiedLinuxDriver.tar.gz[root@localhost root]#cd
[FilePath]/cdroot/Linux[root@localhost Linux]#./
install.sh
```

**NOTE:** If you do not use the graphical interface and failed to install the software, you have to use the driver in the text mode. Follow the steps 3 to 4, and then follow the instructions on the terminal screen.

- 5 When the welcome screen appears, click **Next**.

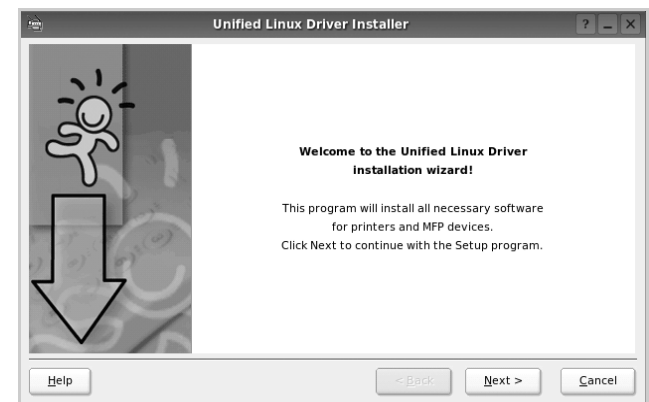

- 6 When the installation is complete, click **Finish**.

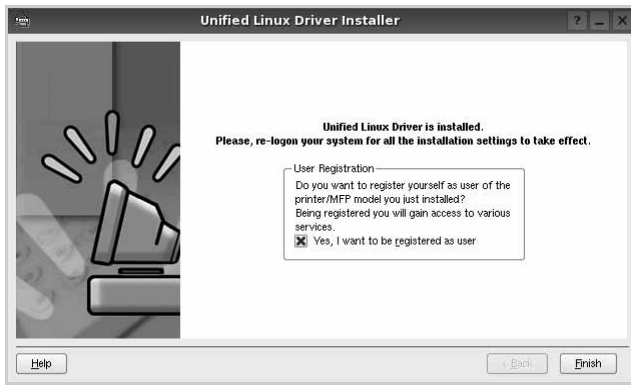

The installation program has added the Unified Driver Configurator desktop icon and Samsung Unified Driver group to the system menu for your convenience. If you have any difficulties, consult the onscreen help that is available through your system menu or can otherwise be called from the driver package windows applications, such as **Unified Driver Configurator**.

## Uninstalling the Unified Linux Driver

- 1 When the Administrator Login window appears, type in *root* in the Login field and enter the system password.

---

**NOTE:** You must log in as a super user (*root*) to install the printer software. If you are not a super user, ask your system administrator.

---

- 2 Click the  icon at the bottom of the desktop. When the Terminal screen appears, type in:  

```
[root@localhost root]#cd /opt/Samsung/mfp/uninstall/  
[root@localhost uninstall]#./uninstall.sh
```
- 3 Click **Uninstall**.
- 4 Click **Next**.

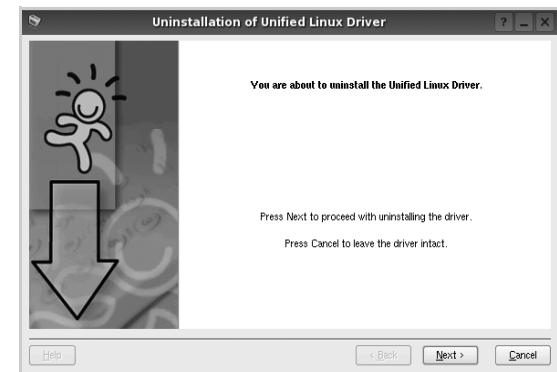

- 5 Click **Finish**.

## Using SetIP program

This program is for the network IP setting using the MAC address which is the hardware serial number of the network printer card or interface. Especially, it is for the network administrator to set several network IPs at the same time.

*You can only use SetIP program when your machine is connected to a network.*

SetIP program should be automatically installed during the printer driver installation.

### Starting the program

- 1 Print the machine's network information report which includes your machine's MAC address.
- 2 Open the `/opt/Samsung/mfp/share/utils/`.
- 3 Double click the `SetIPApplet.html` file.
- 4 Click  in the SetIP window to open the TCP/IP configuration window.
- 5 Enter the network card's MAC address, IP address, subnet mask, default gateway, and then click **Apply**.

**NOTE:** when you enter the MAC address, enter it without colon(:).

- 6 The machine prints the network information. Confirm all the settings are correct.
- 7 Close the SetIP program.

## Using the Unified Driver Configurator

Unified Linux Driver Configurator is a tool primarily intended for configuring Printer.

After installing the Unified Linux driver, the Unified Linux Driver Configurator icon will automatically be created on your desktop.

### Opening the Unified Driver Configurator

- 1 Double-click **Unified Driver Configurator** on the desktop.  
You can also click the Startup Menu icon and select **Samsung Unified Driver** and then **Unified Driver Configurator**.
- 2 Press each button on the Modules pane to switch to the corresponding configuration window.

Printers Configuration button

Ports Configuration button

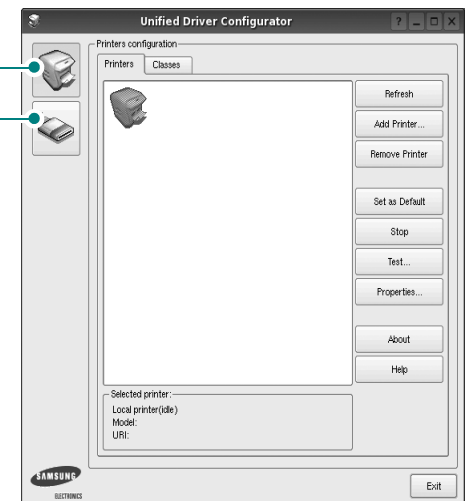

- 3 You can use the onscreen help by clicking **Help**.
- 3 After changing the configurations, click **Exit** to close the Unified Driver Configurator.

## Printers Configuration

Printers configuration has the two tabs: **Printers** and **Classes**.

### Printers Tab

You can see the current system's printer configuration by clicking on the printer icon button on the left side of the Unified Driver Configurator window.

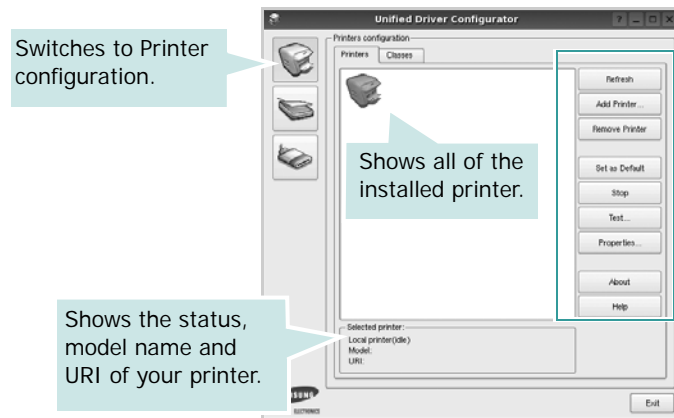

You can use the following printer control buttons:

- **Refresh**: renews the available printers list.
- **Add Printer**: allows you to add a new printer.
- **Remove Printer**: removes the selected printer.
- **Set as Default**: sets the current printer as a default printer.
- **Stop/Start**: stops/starts the printer.
- **Test**: allows you to print a test page to check if the machine is working properly.
- **Properties**: allows you to view and change the printer properties. For details, see page 29.

## Classes Tab

The Classes tab shows a list of available printer classes.

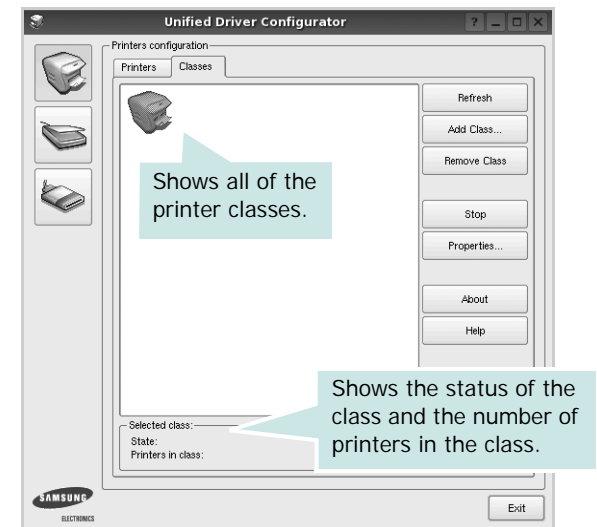

- **Refresh** : Renews the classes list.
- **Add Class...** : Allows you to add a new printer class.
- **Remove Class** : Removes the selected printer class.

## Ports Configuration

In this window, you can view the list of available ports, check the status of each port and release a port that is stalled in busy state when its owner is terminated for any reason.

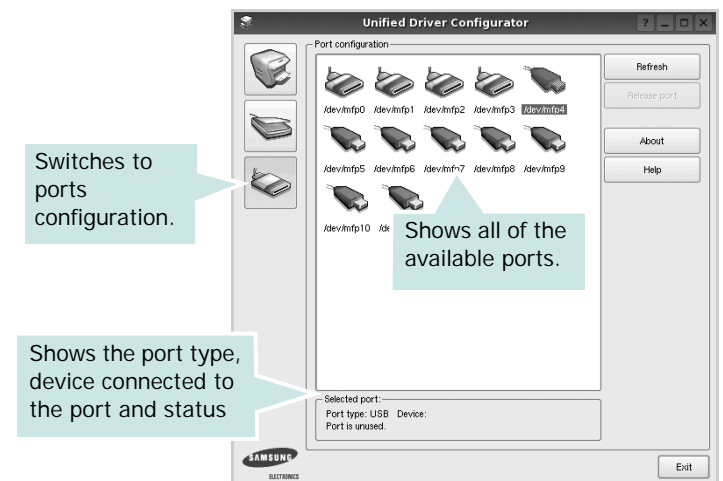

- **Refresh** : Renews the available ports list.
- **Release port** : Releases the selected port.

## Configuring Printer Properties

Using the properties window provided by the Printers configuration, you can change the various properties for your machine as a printer.

- 1 Open the Unified Driver Configurator.  
If necessary, switch to Printers configuration.
- 2 Select your machine on the available printers list and click **Properties**.
- 3 The Printer Properties window opens.

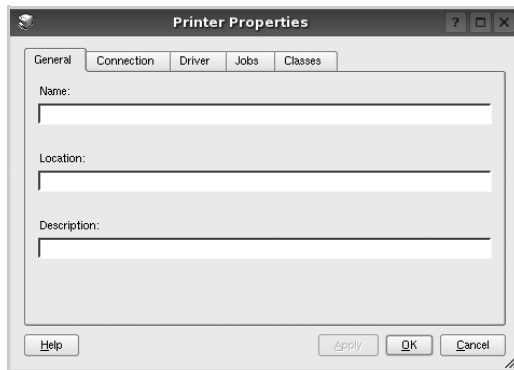

The following five tabs display at the top of the window:

- **General:** allows you to change the printer location and name. The name entered in this tab displays on the printer list in Printers configuration.
  - **Connection:** allows you to view or select another port. If you change the printer port from USB to parallel or vice versa while in use, you must re-configure the printer port in this tab.
  - **Driver:** allows you to view or select another printer driver. By clicking **Options**, you can set the default device options.
  - **Jobs:** shows the list of print jobs. Click **Cancel job** to cancel the selected job and select the **Show completed jobs** check box to see previous jobs on the job list.
  - **Classes:** shows the class that your printer is in. Click **Add to Class** to add your printer to a specific class or click **Remove from Class** to remove the printer from the selected class.
- 4 Click **OK** to apply the changes and close the Printer Properties Window.

## Printing a Document

### Printing from Applications

There are a lot of Linux applications that you are allowed to print from using Common UNIX Printing System (CUPS). You can print on your machine from any such application.

- 1 From the application you are using, select **Print** from the **File** menu.
- 2 Select **Print** directly using **lpr**.
- 3 In the LPR GUI window, select the model name of your machine from the Printer list and click **Properties**.

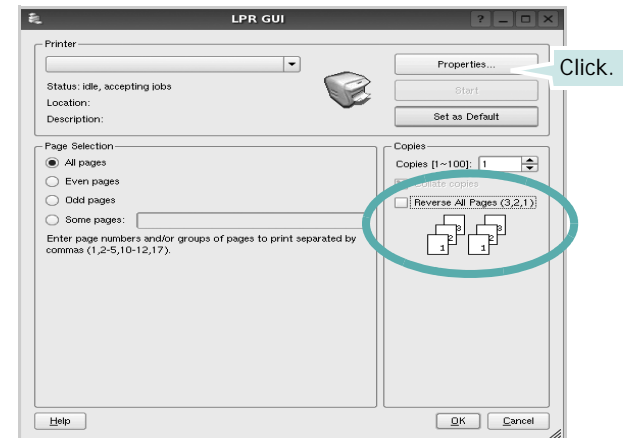

- **Reverse All Pages(3,2,1):** When you use this feature, you do not need to sort the print-out by stacks.
- 4 Change the printer and print job properties.

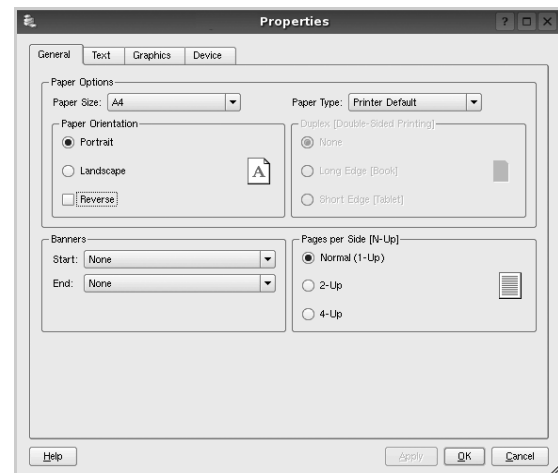



The following four tabs display at the top of the window.

- **General** - allows you to change the paper size, the paper type, and the orientation of the documents, enables the duplex feature, adds start and end banners, and changes the number of pages per sheet.
- **Text** - allows you to specify the page margins and set the text options, such as spacing or columns.
- **Graphics** - allows you to set image options that are used when printing images/files, such as color options, image size, or image position.
- **Device**: allows you to set the print resolution, paper source, and destination.

**5** Click **Apply** to apply the changes and close the Properties window.

**6** Click **OK** in the LPR GUI window to start printing.

**7** The Printing window appears, allowing you to monitor the status of your print job.

To abort the current job, click **Cancel**.

## Printing Files

You can print many different types of files on the Samsung machine device using the standard CUPS way - directly from the command line interface. The CUPS `lpr` utility allows you do that. But the drivers package replaces the standard `lpr` tool by a much more user-friendly LPR GUI program.

To print any document file:

**1** Type `lpr <file_name>` from the Linux shell command line and press **Enter**. The LPR GUI window appears.

When you type only `lpr` and press **Enter**, the Select file(s) to print window appears first. Just select any files you want to print and click **Open**.

**2** In the LPR GUI window, select your printer from the list, and change the printer and print job properties.

For details about the properties window, see page 29.

**3** Click **OK** to start printing.

# 7 Using Your Printer with a Macintosh

Your printer supports Macintosh systems with a built-in USB interface or 10/100 Base-TX network interface card. When you print a file from a Macintosh computer, you can use the CUPS driver by installing the PPD file.

---

**NOTE:** *Some printers do not support a network interface. Make sure that your printer supports a network interface by referring to Printer Specifications in your Printer User's Guide.*

---

This chapter includes:

- **Installing Software**
- **Uninstalling software**
- **Using SetIP program**
- **Setting Up the Printer**
- **Printing**

---

## Installing Software

The CD-ROM that came with your printer provides you with the PPD file that allows you to use the CUPS driver or Apple LaserWriter driver (*only available when you use a printer which supports the PostScript driver*), for printing on a Macintosh computer.

### Installing the Printer driver

- 1 Make sure that you connect your printer to the computer. Turn on your computer and printer.
- 2 Insert the CD-ROM which came with your printer into the CD-ROM drive.
- 3 Double-click **CD-ROM icon** that appears on your Macintosh desktop.
- 4 Double-click the **MAC\_Installer** folder.
- 5 Double-click the **Installer** icon.
- 6 Enter the password and click **OK**.
- 7 The Samsung Installer window opens. Click **Continue**
- 8 Select **Easy Install** and click **Install**. **Easy Install** is recommended for most users. All components necessary for printer operations will be installed. If you select **Custom Install**, you can choose individual components to install.
- 9 The message which warns all application will close on your computer appears, Click **Continue**.

- 10 Select **Typical installation for a local printer** and then click **OK**.

---

**NOTE:** If you select **Typical installation for a network printer**, see "Using SetIP program" on page 32 after the installation is finished.

---

- 11 After the installation is finished, click **Quit**.

---

**NOTE:** After the installation is finished, see "Setting Up the Printer" on page 32

---

---

## Uninstalling software

Uninstall is required if you are upgrading the software, or if installation fails.

- 1 Make sure that you connect your printer to the computer. Turn on your computer and printer.
- 2 Insert the CD-ROM which came with your printer into the CD-ROM drive.
- 3 Double-click **CD-ROM icon** that appears on your Macintosh desktop.
- 4 Double-click the **MAC\_Installer** folder.
- 5 Double-click the **Installer** icon.
- 6 Enter the password and click **OK**.
- 7 The Samsung Installer window opens. Click **Continue**
- 8 Select **Uninstall** and click **Uninstall**.
- 9 When the uninstallation is done, click **Quit**.

## Using SetIP program

This program is for the network IP setting using the MAC address which is the hardware serial number of the network printer card or interface. Especially, it is for the network administrator to set several network IPs at the same time.

*You can only use SetIP program when your machine is connected to a network.*

SetIP program should be automatically installed during the printer driver installation.

**NOTE:** If you select **Typical installation for a network printer** during the printer driver installation, the SetIP program automatically runs after the installation. Follow the below instruction.

- 1 The certificate window appears, click **Trust**.
- 2 Print the machine's network information report which includes your machine's MAC address.
- 3 Click  in the SetIP window to open the TCP/IP configuration window.
- 4 Enter the network card's MAC address, IP address, subnet mask, default gateway, and then click **Apply**.  
when you enter the MAC address, enter it without colon(:).
- 5 The machine prints the network information. Confirm all the settings are correct.
- 6 Close the SetIP program.

## Starting the program

If you want to change your network printer IP setting, follow the below instruction.

- 1 Print the machine's network information report which includes your machine's MAC address.
- 2 Open the **Library** folder → **Printers** → **Samsung** → **Your printer model name** → **SetIP**.
- 3 Double click the **SetIPApplet.html** file.
- 4 When a certificate window appears, click **Trust**.
- 5 Click  in the SetIP window to open the TCP/IP configuration window.
- 6 Enter the network card's MAC address, IP address, subnet mask, default gateway, and then click **Apply**.  
when you enter the MAC address, enter it without colon(:).
- 7 The machine prints the network information. Confirm all the settings are correct.
- 8 Close the SetIP program.

## Setting Up the Printer

Set up for your printer will be different depending on which cable you use to connect the printer to your computer—the network cable or the USB cable.

### For a Network-connected

**NOTE:** *Some printers do not support a network interface. Before connecting your printer, make sure that your printer supports a network interface by referring to Printer Specifications in your Printer User's Guide.*

- 1 Follow the instructions on "Installing Software" on page 31 to install the PPD and Filter files on your computer.
  - 2 Open the **Applications** folder → **Utilities**, and **Print Setup Utility**.
    - For MAC OS 10.5~10.6, open **System Preferences** from the **Applications** folder, and click **Print & Fax**.
  - 3 Click **Add** on the **Printer List**.
    - For MAC OS 10.5~10.6, press the "+" icon then a display window will pop up.
  - 4 For MAC OS 10.3, select the **IP Printing** tab.
    - For MAC OS 10.4, click **IP Printer**.
    - For MAC OS 10.5~10.6, click **IP**.
  - 5 Select **Socket/HP Jet Direct** in **Printer Type**.  
**WHEN PRINTING A DOCUMENT CONTAINING MANY PAGES, PRINTING PERFORMANCE MAY BE ENHANCED BY CHOOSING SOCKET FOR PRINTER TYPE OPTION.**
  - 6 Enter the printer's IP address in the **Printer Address** field.
  - 7 Enter the queue name in the **Queue Name** field. If you cannot determine the queue name for your printer server, try using the default queue first.
  - 8 For MAC OS 10.3, if Auto Select does not work properly, select **Samsung** in **Printer Model** and **your printer name** in **Model Name**.
    - For MAC OS 10.4, if Auto Select does not work properly, select **Samsung** in **Print Using** and **your printer name** in **Model**.
    - For MAC OS 10.5~10.6, if Auto Select does not work properly, select **Select a driver to use...** and **your printer name** in **Print Using**.
- Your printer's IP address appears on the **Printer List**, and is set as the default printer.
- 9 Click **Add**

## For a USB-connected

- 1 Follow the instructions on “Installing Software” on page 31 to install the PPD and Filter files on your computer.
- 2 Open the **Applications** folder → **Utilities**, and **Print Setup Utility**.
  - For MAC OS 10.5~10.6, open **System Preferences** from the **Applications** folder, and click **Print & Fax**.
- 3 Click **Add** on the **Printer List**.
  - For MAC OS 10.5~10.6, press the “+” icon then a display window will pop up.
- 4 For MAC OS 10.3, select the **USB** tab.
  - For MAC OS 10.4, click **Default Browser** and find the USB connection.
  - For MAC OS 10.5~10.6, click **Default** and find the USB connection.
- 5 Select **Samsung** in **Printer Model** and your printer in **Model Name**.
- 6 Click **Add**.

Your printer appears on the **Printer List**, and is set as the default printer.

# Printing

## NOTES:

- The Macintosh printer's properties window that appears in this User's Guide may differ depending on the printer in use. However the composition of the printer properties window is similar.
- *You can check your printer name in the supplied CD-ROM.*

## Printing a Document

When you print with a Macintosh, you need to check the printer software setting in each application you use. Follow these steps to print from a Macintosh.

- 1 Open a Macintosh application and select the file you want to print.
- 2 Open the **File** menu and click **Page Setup (Document Setup** in some applications).
- 3 Choose your paper size, orientation, scaling, and other options and click **OK**.

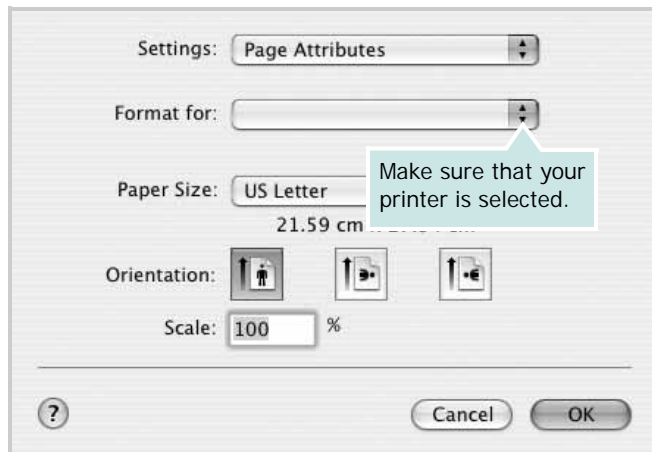

▲ Mac OS 10.3

- 4 Open the **File** menu and click **Print**.
- 5 Choose the number of copies you want and indicate which pages you want to print.
- 6 Click **Print** when you finish setting the options.

## Changing Printer Settings

You can use advanced printing features when using your printer.

From your Macintosh application, select **Print** from the **File** menu. The printer name which appears in the printer properties window may differ depending on the printer in use. Except for the name, the composition of the printer properties window is similar.

**NOTES:** The setting options may differ depending on printers and Macintosh OS version.

## Layout

The **Layout** tab provides options to adjust how the document appears on the printed page. You can print multiple pages on one sheet of paper. Select **Layout** from the **Presets** drop-down list to access the following features.

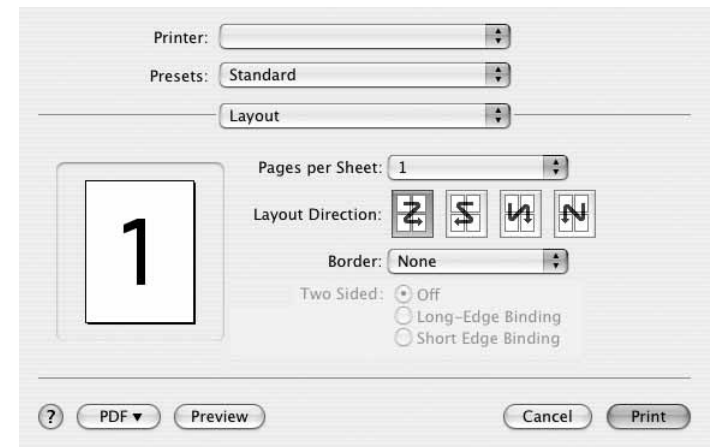

▲ Mac OS 10.4

- **Pages per Sheet:** This feature determines how many pages printed on one page. For details, see "Printing Multiple Pages on One Sheet of Paper" on the next column.
- **Layout Direction:** You can select the printing direction on a page as like the examples on UI.

## Graphics

The higher the setting, the sharper the clarity of printed characters and graphics. The higher setting also may increase the time it takes to print a document.

## Paper

Set **Paper Type** to correspond to the paper loaded in the tray from which you want to print. This will let you get the best quality printout. If you load a different type of print material, select the corresponding paper type.

## Printing Multiple Pages on One Sheet of Paper

You can print more than one page on a single sheet of paper. This feature provides a cost-effective way to print draft pages.

- 1 From your Macintosh application, select **Print** from the **File** menu.
- 2 Select **Layout**.

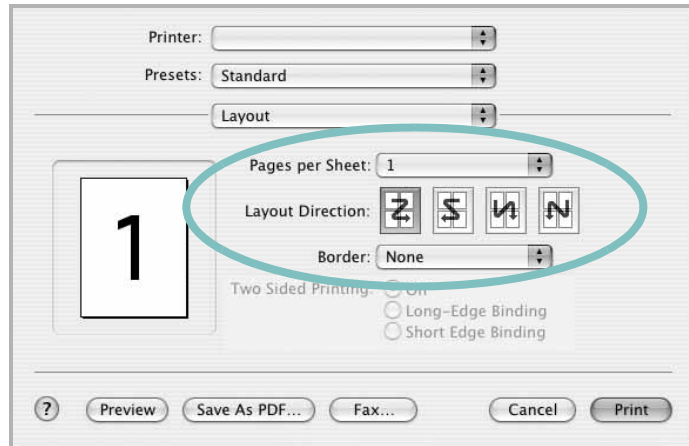

▲ Mac OS 10.3

- 3 Select the number of pages you want to print on one sheet of paper on the **Pages per Sheet** drop-down list.
- 4 Select the page order from the **Layout Direction** option.  
To print a border around each page on the sheet, select the option you want from the **Border** drop-down list.
- 5 Click **Print**, and the printer prints the selected number of pages on one side of each page.

# SOFTWARE SECTION

# INDEX

## A

advanced printing, use 18

## D

document, print  
Macintosh 34  
Windows 12

## E

Extras properties, set 16

## F

favorites settings, use 17

## G

Graphics properties, set 15

## H

help, use 17

## I

install  
printer driver  
Macintosh 31  
Windows 4  
installing  
Linux software 25

## L

Layout properties, set  
Windows 14  
Linux  
driver, install 25  
printer properties 29  
printing 29

## M

Macintosh  
driver  
install 31  
uninstall 31  
printing 34  
setting up the printer 32  
MFP driver, install  
Linux 25

## N

n-up printing  
Macintosh 35  
Windows 18

## O

orientation, print 30  
Windows 14  
overlay  
create 21  
delete 21  
print 21

## P

Paper properties, set 14  
paper size, set 14  
print 30  
paper source, set 30  
Windows 14  
paper type, set  
print 30  
poster, print 19  
print  
document 12  
fit to page 19  
from Macintosh 34  
from Windows 12  
N-up  
Macintosh 35  
Windows 18  
overlay 21

poster 20  
PRN 13  
scaling 19  
watermark 20  
print resolution 30  
printer driver, install  
Linux 25  
printer properties  
Linux 29  
printer properties, set  
Macintosh 34  
Windows 13  
printer resolution, set  
Windows 15  
printer software  
install  
Macintosh 31  
Windows 4  
uninstall  
Macintosh 31  
Windows 11  
printing  
from Linux 29

## R

resolution  
printing 30

## S

setting  
darkness 15  
favorites 17  
image mode 15  
resolution  
Windows 15  
toner save 15  
true-type option 15  
software  
install  
Macintosh 31  
Windows 4  
reinstall  
Windows 11



- system requirements
  - Macintosh 31
- uninstall
  - Macintosh 31
  - Windows 11
- status monitor, use 23

## T

- toner save, set 15

## U

- uninstall, software
  - Macintosh 31
  - Windows 11
- uninstalling
  - MFP driver
  - Linux 26

## W

- watermark
  - create 20
  - delete 20
  - edit 20
  - print 20

[www.samsungprinter.com](http://www.samsungprinter.com)