



SAMSUNG



SAMSUNG LASER MFP User's Guide

SCX-5x30 Series

© 2006 Samsung Electronics Co., Ltd. All rights reserved.

This manual is provided for information purposes only. All information included herein is subject to change without notice. Samsung Electronics is not responsible for any direct or indirect damages, arising from or related to use of this manual.

- SCX-5330N and SCX-5530FN are model names of Samsung Electronics Co., Ltd.
- Samsung and Samsung logo are trademarks of Samsung Electronics Co., Ltd.
- Centronics is a trademark of Centronics Data Computer Corporation.
- PCL and PCL 6 are trademarks of Hewlett-Packard company.
- Microsoft, Windows, Windows 98, Windows Me, Windows 2000, Windows NT 4.0, Windows XP, and Windows 2003 are registered trademarks of Microsoft Corporation.
- PostScript 3 is a trademark of Adobe System, Inc.
- UFST® and MicroType™ are registered trademarks of Monotype Imaging Inc.
- TrueType, LaserWriter and Macintosh are trademarks of Apple Computer, Inc.
- All other brand or product names are trademarks of their respective companies or organizations.

CONTACT SAMSUNG WORLDWIDE

If you have any comments or questions regarding Samsung products, contact the Samsung customer care center.

Country	Customer Care Center	Web Site
ARGENTINE	0800-333-3733	www.samsung.com/ar
AUSTRALIA	1300 362 603	www.samsung.com/au
AUSTRIA	0800-SAMSUNG (726-7864)	www.samsung.com/at
BELGIUM	0032 (0)2 201 24 18	www.samsung.com/be
BRAZIL	0800-124-421 4004-0000	www.samsung.com/br
CANADA	1-800-SAMSUNG (7267864)	www.samsung.com/ca
CHILE	800-726-7864 (SAMSUNG)	www.samsung.com/cl
CHINA	800-810-5858 010- 6475 1880	www.samsung.com.cn
COLOMBIA	01-8000-112-112	www.samsung.com/co
COSTA RICA	0-800-507-7267	www.samsung.com/latin
CZECH REPUBLIC	844 000 844 Distributor pro Českou republiku : Samsung Zrt., česká organizační složka Vyskočilova 4, 14000 Praha 4	www.samsung.com/cz
DENMARK	70 70 19 70	www.samsung.com/dk
ECUADOR	1-800-10-7267	www.samsung.com/latin
EL SALVADOR	800-6225	www.samsung.com/latin
ESTONIA	800-7267	www.samsung.ee
KAZAHSTAN	8-10-800-500-55-500	www.samsung.kz
KYRGYZSTAN	00-800-500-55-500	
FINLAND	030-6227 515	www.samsung.com/fi
FRANCE	3260 SAMSUNG or 08 25 08 65 65 (€ 0,15/min)	www.samsung.com/fr
GERMANY	01805 - 121213 (€ 0,14/min)	www.samsung.de
GUATEMALA	1-800-299-0013	www.samsung.com/latin
HONG KONG	3698 4698	www.samsung.com/hk
HUNGARY	06-80-SAMSUNG (7267864)	www.samsung.com/hu
INDIA	3030 8282 1800 110011	www.samsung.com/in/
INDONESIA	0800-112-8888	www.samsung.com/id
ITALIA	800-SAMSUNG(7267864) 800-048989	www.samsung.com/it
JAMAICA	1-800-234-7267	www.samsung.com/latin
JAPAN	0120-327-527	www.samsung.com/jp
LATVIA	800-7267	www.samsung.com/lv/ index.htm

Country	Customer Care Center	Web Site
LITHUANIA	8-800-77777	www.samsung.com/lt
LUXEMBURG	0035 (0)2 261 03 710	www.samsung.com/be
MALAYSIA	1800-88-9999	www.samsung.com/my
MEXICO	01-800-SAMSUNG (7267864)	www.samsung.com/mx
NETHERLANDS	0900 20 200 88 (€ 0,10/min)	www.samsung.com/nl
NEW ZEALAND	0800SAMSUNG(726-7864)	www.samsung.com/nz
NORWAY	815-56 480	www.samsung.com/no
PANAMA	800-7267	www.samsung.com/latin
PHILIPPINES	1800-10-SAMSUNG (7267864)	www.samsung.com/ph
POLAND	0 801 801 881 022-607-93-33	www.samsung.com/pl
PORTUGAL	80 8 200 128	www.samsung.com/pt
PUERTO RICO	1-800-682-3180	www.samsung.com/latin
REP. DOMINICA	1-800-751-2676	www.samsung.com/latin
REPUBLIC OF IRELAND	0818 717 100	www.samsung.com/uk
RUSSIA	8-800-555-55-55	www.samsung.ru
SINGAPORE	1800-SAMSUNG (7267864)	www.samsung.com/sg
SLOVAKIA	0800-SAMSUNG (726786)	www.samsung.com/sk
SOUTH AFRICA	0860 726 7864 (SAMSUNG)	www.samsung.com/za
SPAIN	902 10 11 30	www.samsung.com/es
SWEDEN	0771-400 200	www.samsung.com/se
SWITZERLAND	0800-7267864	www.samsung.com/ch/
TAIWAN	0800-329-999	www.samsung.com/tw
THAILAND	1800-29-3232 02-689-3232	www.samsung.com/th
TRINIDAD & TOBAGO	1-800-7267-864	www.samsung.com/latin
TURKEY	444 77 11	www.samsung.com.tr
U.A.E	800-SAMSUNG (7267864)	www.samsung.com/mea
U.K	0870 SAMSUNG (7267864)	www.samsung.com/uk
U.S.A.	1-800-SAMSUNG (7267864)	www.samsung.com
UKRAINE	8-800-502-0000	www.samsung.ua
UZBEKISTAN	8-800-120-0400	www.samsung.com.uz
VENEZUELA	0-800-100-5303	www.samsung.com/latin
VIETNAM	1 800 588 889	www.samsung.com/vn

CONTENTS

1. Introduction	
Special features	1.1
Printer overview	1.2
Understanding the Status LED	1.5
Finding more information	1.5
Selecting a location	1.6
2. System setup	
Menu overview	2.1
Changing the display language	2.2
Setting the date and time	2.2
Changing the default mode (SCX-5530FN only)	2.2
Setting sounds (SCX-5530FN only)	2.3
Entering characters using the number keypad	2.3
Using the save modes	2.4
Setting print job timeout	2.4
3. Software overview	
Supplied software	3.1
Printer driver features	3.2
System requirements	3.2
4. Network setup	
Introduction	4.1
Supported operating systems	4.1
Configuring TCP/IP	4.1
Configuring EtherTalk	4.2
Configuring IPX frame types	4.2
Setting Ethernet speed	4.3
Restoring the network configuration	4.3
Printing a network configuration page	4.3
Using SetIP program	4.3
5. Loading originals and print media	
Loading originals	5.1
Selecting print media	5.2
Loading paper	5.5
Setting the paper size and type	5.8
Selecting an output location	5.8
6. Copying	
Selecting the paper tray	6.1
Copying	6.1
Changing the settings for each copy	6.1
Changing the default copy settings	6.2
Using special copy features	6.2
Copying on both sides of paper (SCX-5530FN only)	6.4
Setting copy timeout	6.4

7. Basic printing	
Printing a document	7.1
Canceling a print job	7.1
8. Scanning	
Scanning basics	8.1
Scanning to an application using a local connection	8.1
Scanning using a network connection	8.2
Changing the settings for each scan job	8.5
Changing the default scan settings	8.5
Setting up Address Book	8.5
9. Faxing (SCX-5530FN only)	
Setting the fax header	9.1
Adjusting the document settings	9.1
Sending a fax automatically	9.2
Sending a fax manually	9.2
Confirming a transmission	9.3
Automatic redialing	9.3
Redialing the last number	9.3
Selecting the paper tray	9.3
Changing receiving modes	9.3
Receiving automatically in Fax mode	9.4
Receiving manually in Tel mode	9.4
Receiving manually using an extension telephone	9.4
Receiving automatically in Ans/Fax mode	9.4
Receiving faxes using DRPD mode	9.4
Receiving in secure receiving mode	9.5
Receiving faxes in memory	9.5
Printing received faxes on both sides of paper	9.6
Sending a fax to multiple destinations	9.6
Sending a delayed fax	9.7
Sending a priority fax	9.7
Forwarding faxes	9.8
10. Fax setup (SCX-5530FN only)	
Changing the fax setup options	10.1
Changing the default document settings	10.2
Printing sent fax report automatically	10.2
Setting up Phone Book	10.2
11. Using USB flash memory (SCX-5530FN only)	
About USB memory	11.1
Plugging in a USB memory device	11.1
Scanning to a USB memory device	11.1
Printing from a USB memory device	11.2
Backing up data	11.3
Managing USB memory	11.3
12. Ordering supplies and accessories	
Toner cartridges	12.1
Accessories	12.1
How to purchase	12.1

13. Maintenance

Printing reports	13.1
Cleaning your machine	13.2
Maintaining the toner cartridge	13.3
Maintenance Parts	13.6
Managing your machine from the website	13.8
Checking the machine's serial number	13.8

14. Troubleshooting

Clearing document jams	14.1
Clearing paper jams	14.2
Understanding display messages	14.7
Toner cartridge-related messages	14.10
Solving other problems	14.11

15. Installing accessories

Precautions when installing accessories	15.1
Installing a memory DIMM	15.1

16. Specifications

General specifications	16.1
Printer specifications	16.1
Scanner and copier specifications	16.2
Facsimile specifications (SCX-5530FN only)	16.2

Index

Important Precautions and Safety Information

When using this machine, these basic safety precautions should always be followed to reduce risk of fire, electric shock and injury to people:

- 1 Read and understand all instructions.
- 2 Use common sense whenever operating electrical appliances.
- 3 Follow all warnings and instructions marked on the machine and in the literature accompanying the machine.
- 4 If an operating instruction appears to conflict with safety information, heed the safety information. You may have misunderstood the operating instruction. If you cannot resolve the conflict, contact your sales or service representative for assistance.
- 5 Unplug the machine from the AC wall socket and/or telephone jack before cleaning. Do not use liquid or aerosol cleaners. Use only a damp cloth for cleaning.
- 6 Do not place the machine on an unstable cart, stand or table. It may fall, causing serious damage.
- 7 Your machine should never be placed on, near or over a radiator, heater, air conditioner or ventilation duct.
- 8 Do not allow anything to rest on the power. Do not locate your machine where the cords will be abused by persons walking on them.
- 9 Do not overload wall outlets and extension cords. This can diminish performance, and may result in the risk of fire or electric shock.
- 10 Do not allow pets to chew on the AC power, telephone or PC interface cords.
- 11 Never push objects of any kind into the machine through case or cabinet openings. They may touch dangerous voltage points, creating a risk of fire or shock. Never spill liquid of any kind onto or into the machine.
- 12 Your machine may have a heavy cover for optimal pressure on the document for the best scanning and/or faxing (usually the flatbed-type machine). In this case, replace the cover after placing document on the scan glass, by holding and moving it down slowly until it seats on its location.
- 13 To reduce the risk of electric shock, do not disassemble the machine. Take it to a qualified service technician when repair work is required. Opening or removing covers may expose you to dangerous voltages or other risks. Incorrect reassembly could cause electric shock when the unit is subsequently used.
- 14 Unplug the machine from the telephone jack, PC and AC wall outlet and refer servicing to qualified service personnel under the following conditions:
 - When any part of the power cord, plug or connecting cable is damaged or frayed.
 - If liquid has been spilled into the machine.
 - If the machine has been exposed to rain or water.
 - If the machine does not operate properly after instructions have been followed.
 - If the machine has been dropped, or the cabinet appears damaged.
 - If the machine exhibits a sudden and distinct change in performance.
- 15 Adjust only those controls covered by the operating instructions. Improper adjustment of other controls may result in damage, and may require extensive work by a qualified service technician to restore the machine to normal operation.
- 16 Avoid using this machine during a lightning storm. There may be a remote risk of electric shock from lightning. If possible, unplug the AC power and telephone cord for the duration of the lightning storm.

17 The Power cord supplied with your machine should be used for safe operation. If you are using a cord which is longer than 2 m with 110 V machine, then it should be 16 AWG¹ or bigger.

18 Use only No.26 AWG* or larger telephone line cord.

19 SAVE THESE INSTRUCTIONS.

Laser Safety Statement

The printer is certified in the U.S. to conform to the requirements of DHHS 21 CFR, chapter 1 Subchapter J for Class I(1) laser products, and elsewhere is certified as a Class I laser product conforming to the requirements of IEC 825.

Class I laser products are not considered to be hazardous. The laser system and printer are designed so there is never any human access to laser radiation above a Class I level during normal operation, user maintenance or prescribed service condition.

WARNING

Never operate or service the printer with the protective cover removed from Laser/Scanner assembly. The reflected beam, although invisible, can damage your eyes.

When using this product, these basic safety precautions should always be followed to reduce risk of fire, electric shock, and injury to persons:

	CAUTION - CLASS 3B LASER RADIATION WHEN OPEN AVOID EXPOSURE TO THE BEAM.
	DANGER - LASER RADIATION AVOID DIRECT EXPOSURE TO BEAM.
	DANGER - RADIATIONS INVISIBLES DU LASER EN CAS D'OUVERTURE. EVITER TOUTE EXPOSITION DIRECTE AU FAISCEAU.
	VORSICHT - UNSICHTBARE LASERSTRAHLUNG, WENN ABDECKUNG GEÖFFNET. NICHT DEM STRAHL AUSSETZEN.
	ATTENZIONE - RADIAZIONE LASER INVISIBILE IN CASO DI APERTURA. EVITARE L'ESPOSIZIONE AL FASCIO.
	PRECAUCIÓN - RADIACIÓN LASER INVISIBLE CUANDO SE ABRE. EVITAR EXPONERSE AL RAYO.
	PERIGO - RADIAÇÃO LASER INVISÍVEL AO ABRIR. EVITE EXPOSIÇÃO DIRECTA AO FEIXE.
	GEVAAR - ONZICHTBARE LASERSTRALEN BIJ GEOPENDE KLEP. DEZE KLEP NIET OPENEN.
	ADVARSEL - USYNLIG LASERSTRÅLNING VED ÅBNING. UNNGÅ UDSÆTTELSE FOR STRÅLNING.
	ADVARSEL - USYNLIG LASERSTRÅLNING NÅR DEKSEL ÅPNES. UNNGÅ EKSPONERING FOR STRÅLEN.
	VARNING - OSYNLIG LASERSTRÅLNING NÅR DENNA DEL ÅR ÖPPEN. STRÅLEN ÅR FARLIG.
	VAROITUS - NÄKYMÄTÖNTÄ LASERSÄTELYÄ AVATTAESSA. VARO SUORAA ALTISTUMISTA SÄTEELLE.
	注意 - 严禁揭开此盖, 以免激光泄露灼伤
	주의 - 이 덮개를 열면 레이저광에 노출될 수 있으므로 주의하십시오.

Ozone Safety



During normal operation, this machine produces ozone. The ozone produced does not present a hazard to the operator. However, it is advisable that the machine be operated in a well ventilated area.

If you need additional information about ozone, please request your nearest Samsung dealer.

¹ AWG: American Wire Gauge

Mercury Safety



LAMP(S) INSIDE THIS PRODUCT CONTAIN MERCURY AND MUST BE RECYCLED OR DISPOSED OF ACCORDING TO LOCAL, STATE OR FEDERAL LAWS. For details see lamprecycle.org, eiae.org, or call 1-800-Samsung

Power Saver

This printer contains advanced energy conservation technology that reduces power consumption when it is not in active use.

When the printer does not receive data for an extended period of time, power consumption is automatically lowered.

Recycling



Please recycle or dispose of the packaging material for this product in an environmentally responsible manner.

Correct Disposal of This Product (Waste Electrical & Electronic Equipment)

(Applicable in the European Union and other European countries with separate collection systems)



This marking shown on the product or its literature, indicates that it should not be disposed with other household wastes at the end of its working life. To prevent possible harm to the environment or human health from uncontrolled waste disposal, please separate this from other types of wastes and recycle it responsibly to promote the sustainable reuse of material resources.

Household users should contact either the retailer where they purchased this product, or their local government office, for details of where and how they can take this item for environmentally safe recycling.

Business users should contact their supplier and check the terms and conditions of the purchase contract. This product should not be mixed with other commercial wastes for disposal.

Radio Frequency Emissions

FCC Information to the User

This device complies with Part 15 of the FCC Rules. Operation is subject to the following two conditions:

- This device may not cause harmful interference, and
- This device must accept any interference received, including interference that may cause undesired operation.

This equipment has been tested and found to comply with the limits for a Class B digital device, pursuant to Part 15 of the FCC Rules. These limits are designed to provide reasonable protection against harmful interference in a residential installation. This equipment generates, uses and can radiate radio frequency energy and, if not installed and used in accordance with the instructions, may cause harmful interference to radio communications. However, there is no guarantee that interference will not occur in a particular installation. If this equipment does cause harmful interference to radio or

television reception, which can be determined by turning the equipment off and on, the user is encouraged to try to correct the interference by one or more of the following measures:

- Reorient or relocate the receiving antenna.
- Increase the separation between the equipment and receiver.
- Connect the equipment into an outlet on a circuit different from that to which the receiver is connected.
- Consult the dealer or experienced radio TV technician for help.

CAUTION: Change or modifications not expressly approved by the manufacturer responsible for compliance could void the user's authority to operate the equipment.

Canadian Radio Interference Regulations

This digital apparatus does not exceed the Class B limits for radio noise emissions from digital apparatus as set out in the interference-causing equipment standard entitled "Digital Apparatus", ICES-003 of the Industry and Science Canada.

Cet appareil numérique respecte les limites de bruits radioélectriques applicables aux appareils numériques de Classe B prescrites dans la norme sur le matériel brouilleur: "Appareils Numériques", ICES-003 édictée par l'Industrie et Sciences Canada.

Fax Branding

The Telephone Consumer Protection Act of 1991 makes it unlawful for any person to use a computer or other electronic device to send any message via a telephone facsimile machine unless such message clearly contains in a margin at the top or bottom of each transmitted page or on the first page of the transmission the following information:

- (1) the date and time of transmission
- (2) identification of either business, business entity or individual sending the message; and
- (3) telephone number of either the sending machine, business, business entity or individual.

The Telephone Company may make changes in its communications facilities, equipment operations or procedures where such action is reasonably required in the operation of its business and is not inconsistent with the rules and regulations in FCC Part 68. If such changes can be reasonably expected to render any customer terminal equipment incompatible with telephone company communications facilities, or require modification or alteration of such terminal equipment, or otherwise materially affect its use or performance, the customer shall be given adequate notice in writing, to allow the customer an opportunity to maintain uninterrupted service.

Ringer Equivalence Number

The Ringer Equivalence Number and FCC Registration Number for this machine may be found on the label located on the bottom or rear of the machine. In some instances you may need to provide these numbers to the telephone company.

The Ringer Equivalence Number (REN) is a measure of the electrical load placed on the telephone line, and is useful for determining whether you have "overloaded" the line. Installing several types of equipment on the same telephone line may result in problems making and receiving telephone calls, especially ringing when your line is called. The sum of all Ringer Equivalence Numbers of the equipment on your telephone line should be less than five in order to assure proper service from the telephone company. In some cases, a sum of five may not be usable on your line. If any of your telephone equipment is not operating properly, you should immediately remove it from your telephone line, as it may cause harm to the telephone network.

WARNING:

FCC Regulations state that changes or modifications to this equipment not expressly approved by the manufacturer could void the user's authority to operate this equipment. In the event that terminal equipment causes harm to the telephone network, the telephone company should notify the customer that service may be stopped. However, where prior notice is impractical, the company may temporarily cease service, providing that they:

- a) promptly notify the customer.
- b) give the customer an opportunity to correct the equipment problem.
- c) inform the customer of the right to bring a complaint to the Federal Communication Commission pursuant to procedures set out in FCC Rules and Regulations Subpart E of Part 68.

You should also know that:

- Your machine is not designed to be connected to a digital PBX system.
- If you intend to use a computer modem or fax modem on the same phone line as your machine, you may experience transmission and reception problems with all the equipment. It is recommended that no other equipment, except for a regular telephone, share the line with your machine.
- If your area experiences a high incidence of lightning or power surges, we recommend that you install surge protectors for both the power and the telephone lines. Surge protectors can be purchased from your dealer or telephone and electronic specialty stores.
- When programming emergency numbers and/or making test calls to emergency numbers, use a non-emergency number to advise the emergency service dispatcher of your intentions. The dispatcher will give you further instructions on how to actually test the emergency number.
- This machine may not be used on coin service or party lines.
- This machine provides magnetic coupling to hearing aids.
- You may safely connect this equipment to the telephone network by means of a standard modular jack, USOC RJ-11C.

Declaration of Conformity (European Countries)

Approvals and Certifications



The CE marking applied to this product symbolizes Samsung Electronics Co., Ltd. Declaration of Conformity with the following applicable 93/68/EEC Directives of the European Union as of the dates indicated:

January 1, 1995: Council Directive 73/23/EEC Approximation of the laws of the member states related to low voltage equipment.

January 1, 1996: Council Directive 89/336/EEC (92/31/EEC), approximation of the laws of the Member States related to electromagnetic compatibility.

March 9, 1999: Council Directive 1999/5/EC on radio equipment and telecommunications terminal equipment and the mutual recognition of their conformity.

A full declaration, defining the relevant Directives and referenced standards can be obtained from your Samsung Electronics Co., Ltd. representative.

EC Certification

Certification to 1999/5/EC Radio Equipment & Telecommunications Terminal Equipment Directive (FAX)

This Samsung product has been self-certified by Samsung for pan-European single terminal connection to the analogue public switched telephone network (PSTN) in accordance with Directive 1999/5/EC. The product has been designed to work with the national PSTNs and compatible PBXs of the European countries:

In the event of problems, you should contact the Euro QA Lab of Samsung Electronics Co., Ltd. in the first instance.

The product has been tested against TS103 021. To assist in the use and application of terminal equipment which complies with this standard, the European Telecommunication Standards Institute (ETSI) has issued an advisory document (EG 201 121) which contains notes and additional requirements to ensure network compatibility of TS103 021 terminals. The product has been designed against, and is fully compliant with, all of the relevant advisory notes contained in this document.

Replacing the Fitted Plug (for UK Only)

IMPORTANT

The mains lead for this machine is fitted with a standard (BS 1363) 13 amp plug and has a 13 amp fuse. When you change or examine the fuse, you must re-fit the correct 13 amp fuse. You then need to replace the fuse cover. If you have lost the fuse cover, do not use the plug until you have another fuse cover.

Please contact the people from you purchased the machine.

The 13 amp plug is the most widely used type in the UK and should be suitable. However, some buildings (mainly old ones) do not have normal 13 amp plug sockets. You need to buy a suitable plug adaptor. Do not remove the moulded plug.

WARNING

If you cut off the moulded plug, get rid of it straight away.

You cannot rewire the plug and you may receive an electric shock if you plug it into a socket.

IMPORTANT WARNING: You must earth this machine.

The wires in the mains lead have the following color code:

- Green and Yellow: Earth
- Blue: Neutral
- Brown: Live

If the wires in the mains lead do not match the colors marked in your plug, do the following:

You must connect the green and yellow wire to the pin marked by the letter "E" or by the safety 'Earth symbol' or colored green and yellow or green.

You must connect the blue wire to the pin which is marked with the letter "N" or colored black.

You must connect the brown wire to the pin which is marked with the letter "L" or colored red.

You must have a 13 amp fuse in the plug, adaptor, or at the distribution board.

OPENSSL LICENSE

Copyright (c) 1998-2001 The OpenSSL Project. All rights reserved.

Redistribution and use in source and binary forms, with or without modification, are permitted provided that the following conditions are met:

1. Redistributions of source code must retain the above copyright notice, this list of conditions and the following disclaimer.
2. Redistributions in binary form must reproduce the above copyright notice, this list of conditions and the following disclaimer in the documentation and/or other materials provided with the distribution.
3. All advertising materials mentioning features or use of this software must display the following acknowledgment: "This product includes software developed by the OpenSSL Project for use in the OpenSSL Toolkit. (<http://www.openssl.org/>)"
4. The names "OpenSSL Toolkit" and "OpenSSL Project" must not be used to endorse or promote products derived from this software without
5. prior written permission. For written permission, please contact openssl-core@openssl.org.
6. Products derived from this software may not be called "OpenSSL" nor may "OpenSSL" appear in their names without prior written permission of the OpenSSL Project.
7. Redistributions of any form whatsoever must retain the following acknowledgment: "This product includes software developed by the OpenSSL Project for use in the OpenSSL Toolkit (<http://www.openssl.org/>)"

THIS SOFTWARE IS PROVIDED BY THE OpenSSL PROJECT ``AS IS'' AND ANY EXPRESSED OR IMPLIED WARRANTIES, INCLUDING, BUT NOT LIMITED TO, THE IMPLIED WARRANTIES OF MERCHANTABILITY AND FITNESS FOR A PARTICULAR PURPOSE ARE DISCLAIMED. IN NO EVENT SHALL THE OpenSSL PROJECT OR ITS CONTRIBUTORS BE LIABLE FOR ANY DIRECT, INDIRECT, INCIDENTAL, SPECIAL, EXEMPLARY, OR CONSEQUENTIAL DAMAGES (INCLUDING, BUT NOT LIMITED TO, PROCUREMENT OF SUBSTITUTE GOODS OR SERVICES; LOSS OF USE, DATA, OR PROFITS; OR BUSINESS INTERRUPTION) HOWEVER CAUSED AND ON ANY THEORY OF LIABILITY, WHETHER IN CONTRACT, STRICT LIABILITY, OR TORT (INCLUDING NEGLIGENCE OR OTHERWISE) ARISING IN ANY WAY OUT OF THE USE OF THIS SOFTWARE, EVEN IF ADVISED OF THE POSSIBILITY OF SUCH DAMAGE.

This product includes cryptographic software written by Eric Young(eay@cryptsoft.com). This product includes software written by Tim Hudson (tjh@cryptsoft.com).

ORIGINAL SSLEAY LICENSE

Copyright (C) 1995-1998 Eric Young (eay@cryptsoft.com) All rights reserved.

This package is an SSL implementation written by Eric Young (eay@cryptsoft.com). The implementation was written so as to conform with Netscapes SSL.

This library is free for commercial and non-commercial use as long as the following conditions are aheared to. The following conditions apply to all code found in this distribution, be it the RC4, RSA, lhash, DES, etc., code; not just the SSL code. The SSL documentation included with this distribution is covered by the same copyright terms except that the holder is Tim Hudson (tjh@cryptsoft.com). Copyright remains Eric Young's, and as such any Copyright notices in the code are not to be removed. If this package is used in a product, Eric Young should be given attribution as the author of the parts of the library used. This can be in the form of a textual message at program startup or in documentation (online or textual) provided with the package.

Redistribution and use in source and binary forms, with or without modification, are permitted provided that the following conditions are met:

1. Redistributions of source code must retain the copyright notice, this list of conditions and the following disclaimer.
2. Redistributions in binary form must reproduce the above copyright notice, this list of conditions and the following disclaimer in the documentation and/or other materials provided with the distribution.
3. All advertising materials mentioning features or use of this software must display the following acknowledgement: "This product includes cryptographic software written by Eric Young (eay@cryptsoft.com)" The word 'cryptographic' can be left out if the rouines from the library being used are not cryptographic related:-).
4. If you include any Windows specific code (or a derivative thereof) from the apps directory (application code) you must include an acknowledgement: "This product includes software written by Tim Hudson (tjh@cryptsoft.com)"

THIS SOFTWARE IS PROVIDED BY ERIC YOUNG ``AS IS'' AND ANY EXPRESS OR IMPLIED WARRANTIES, INCLUDING, BUT NOT LIMITED TO, THE IMPLIED WARRANTIES OF MERCHANTABILITY AND FITNESS FOR A PARTICULAR PURPOSE ARE DISCLAIMED. IN NO EVENT SHALL THE AUTHOR OR CONTRIBUTORS BE LIABLE FOR ANY DIRECT, INDIRECT, INCIDENTAL, SPECIAL, EXEMPLARY, OR CONSEQUENTIAL DAMAGES (INCLUDING, BUT NOT LIMITED TO, PROCUREMENT OF SUBSTITUTE GOODS OR SERVICES; LOSS OF USE, DATA, OR PROFITS; OR BUSINESS INTERRUPTION) HOWEVER CAUSED AND ON ANY THEORY OF LIABILITY, WHETHER IN CONTRACT, STRICT LIABILITY, OR TORT (INCLUDING NEGLIGENCE OR OTHERWISE) ARISING IN ANY WAY OUT OF THE USE OF THIS SOFTWARE, EVEN IF ADVISED OF THE POSSIBILITY OF SUCH DAMAGE.

The licence and distribution terms for any publically available version or derivative of this code cannot be changed. i.e. this code cannot simply be copied and put under another distribution licence [including the GNU Public Licence.]



EU Declaration of Conformity (R&TTE)

We, Samsung Electronics Co., Ltd.

of Samsung Electronics Co., Ltd.
#259, Gongdan-Dong, Gumi-City, Kyungbuk, Korea 730-030
of Shandong Samsung Telecommunications Co., Ltd.
Sanxing Road, Weihai Hi-Tech, IDZ Shandong Province, China 264209
(factory name, address)

declare under our sole responsibility that the product

Multi-Function Printer
model "SCX-5530FN, SCX-5330N"

to which this declaration relates is in conformity with

R&TTE Directive 1999/5/EC (Annex II)
Low Voltage Directive 73/23/EEC
EMC Directive 89/336/EEC , 92/31/EEC

By application of the following standards

R&TTE : TS 103 021, EG 201 121 V1.1.3(2000-02)
.....
LVD : EN 60950-1:2001+ A11
.....
EMC : EN 55022:1998+A1:2000+A2:2003
.....
EN 55024:1998+A1:2001+A2:2003
.....
EN61000-3-2:2000 EN61000-3-3:1995+A1:2001
.....

(Manufacturer)

Samsung Electronics Co., Ltd.
#259, Gongdan-Dong, Gumi-City
Gyungbuk, Korea 730-030
2005-12-26

任煥淳

Whan-Soon Yim / Senior Manager

(place and date of issue)

(name and signature of authorized person)

(Representative in the EU)

Samsung Electronics Euro QA Lab.
Blackbushe Business Park, Saxony Way
Yateley, Hampshire, GU46 6GG, UK
2005-12-26

Y. S. Park

Yong-Sang Park / Manager

(place and date of issue)

(name and signature of authorized person)

1 Introduction

Thank you for purchasing this Samsung multifunctional product. Your machine provides printing, copying, scanning, and faxing (SCX-5530FN only) functions.

This chapter includes:

- **Special features**
- **Printer overview**
- **Understanding the Status LED**
- **Finding more information**
- **Selecting a location**

Special features

Your new machine is equipped with special features that improve print quality. You can:

Print with excellent quality and speed

DPI
1200

- You can print with a resolution of up to **1200 dpi [Best]**. See the **Software Section**.
- Your machine prints A4-sized paper at up to 28 ppm^a and letter-sized paper at up to 30 ppm.
- For duplex printing, your machine prints A4-sized paper at up to 19 ipm^b and letter-sized paper at up to 21 ipm.

Handle paper flexibly

250

- The **multi-purpose tray** supports letterhead, envelopes, labels, transparencies, custom-sized media, postcards, and heavy paper. The **multi-purpose tray** holds up to 50 sheets of plain paper.
- The **250-sheet tray 1** and **250-sheet optional tray 2** support plain paper in various sizes.

Create professional documents

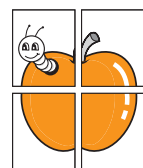

- Print **Watermarks**. You can customize your documents with words, such as "Confidential". See the **Software Section**.
- Print **Posters**. The text and pictures of each page of your document are magnified and printed across the sheet of paper and can then be taped together to form a poster. See the **Software Section**.

Save time and money

- You can print multiple pages on one single sheet of paper to save paper.
- You can use preprinted forms and letterhead with plain paper. See the **Software Section**.
- This machine automatically **conserves electricity** by substantially reducing power consumption when not in use.

a. pages per minute

b. images per minute

Expand your machine's capacity



- The SCX-5330N has 64 MB of memory which can be expanded to 320 MB. The SCX-5530FN has 96 MB of memory which can be expanded to 320 MB.
- You can add a 250-sheet **optional tray 2** to your machine. This tray lets you add paper to the machine less often.
- Zoran IPS Emulation* compatible with PostScript 3 (PS) enables PS printing (SCX-5530FN only).

* Zoran IPS Emulation compatible with PostScript 3



© Copyright 1995-2005, Zoran Corporation. All rights reserved. Zoran, the Zoran logo, IPS/PS3, and OneImage are trademarks of Zoran Corporation.

* 136 PS3 fonts

Contains UFST and MicroType from Monotype Imaging Inc.

Print in various environments

- You can print with **Windows 98/Me/NT 4.0/2000/XP/2003**.
- Your machine is compatible with a variety of **Linux** systems.
- Your machine is compatible with a variety of **Macintosh** systems. (SCX-5530FN only)
- Your machine comes with both **USB** and **Parallel** interfaces.

Use USB flash memory devices

If you have a USB memory device, you can use it in various ways with your machine.

- You can scan documents and save them to the device.
- You can directly print data stored to the device.
- You can back up data and restore backup files to the machine's memory.

Machine features

The table below lists a general overview of features supported by your machine.

(I: Installed, O: Option, NA: Not Available)

Features	SCX-5330N	SCX-5530FN
IEEE 1284 Parallel	I	I
USB 2.0	I	I
USB Memory	NA	I
PostScript Emulation	NA	I
Network Interface (Ethernet 10/100 Base TX)	I	I
Duplex printing ¹	NA	I

1. Printing on both sides of paper.

Printer overview

These are the main components of your machine:

Front view

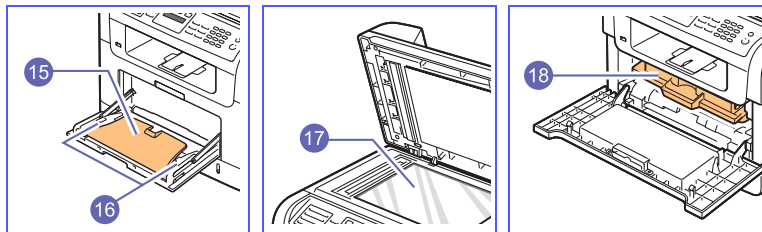
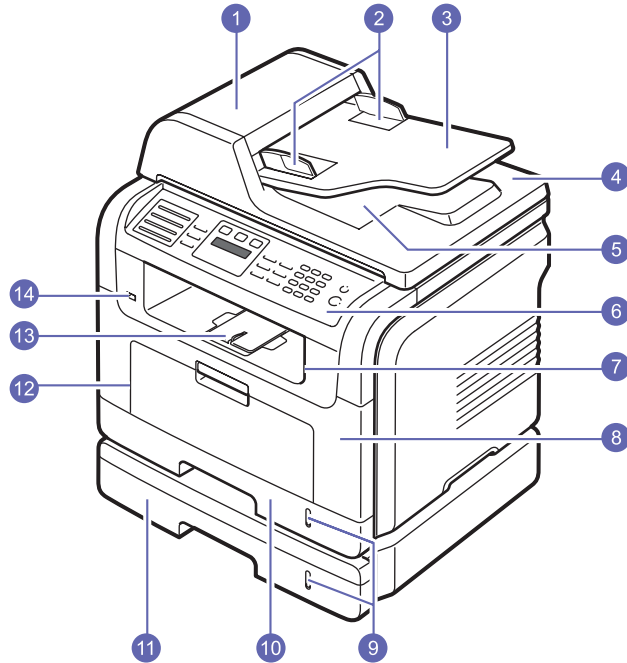

* The figure above shows an SCX-5530FN with all available accessories.

1	ADF (automatic document feeder)¹	10	tray 1
2	document width guides	11	optional tray 2
3	document input tray	12	multi-purpose tray
4	scanner lid	13	output support
5	document output tray	14	USB memory port
6	control panel	15	multi-purpose tray extension
7	output tray	16	multi-purpose tray paper width guides
8	front cover	17	scanner glass
9	paper level indicator	18	toner cartridge

1. Automatic document feeder is used as **ADF** in this user's guide.

Rear view

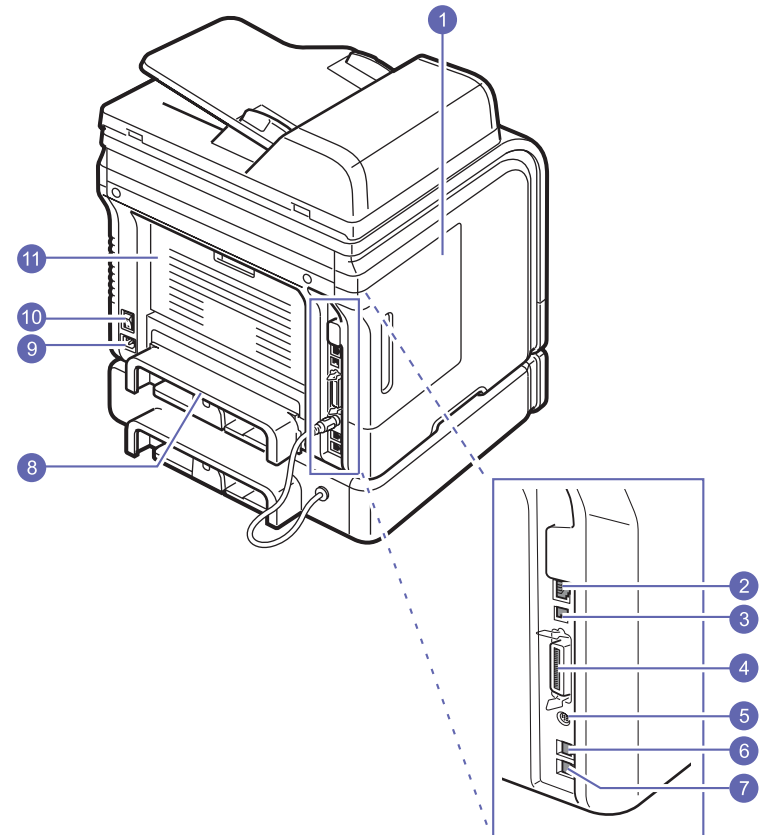

* The figure above shows an SCX-5530FN with all available accessories.

1	control board cover	7	extension telephone socket (EXT)¹
2	network port	8	duplex unit^a
3	USB port	9	power receptacle
4	parallel port	10	power switch
5	optional tray 2 cable connector	11	rear cover
6	telephone line socket (LINE)^a		

1. SCX-5530FN only.

Control panel overview (SCX-5530FN)

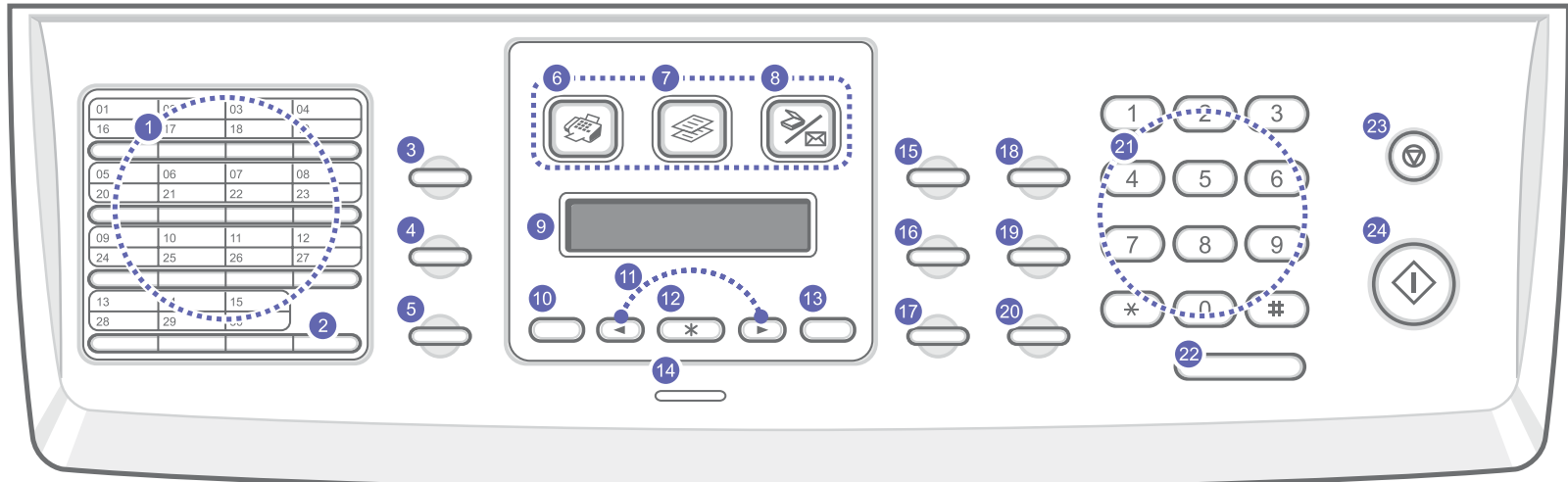

<p>1 Speed buttons: Allows you to store frequently-dialed fax numbers and email addresses and enter them with the touch of a few buttons.</p>	<p>13 Back: Sends you back to the upper menu level.</p>
<p>2 Shift: Allows you to shift the speed buttons to access numbers 16 through 30.</p>	<p>14 Status: Shows the status of your machine. See page 1.5.</p>
<p>3 Address Book: Allows you to store frequently used fax numbers in memory or search for stored fax numbers or email addresses. Also allows you to print an Address Book/Phone Book list.</p>	<p>15 Darkness: Adjusts the document brightness for the current copy job.</p>
<p>4 Resolution: Adjusts the document resolution for the current fax job.</p>	<p>16 Original Type: Selects the document type for the current copy job.</p>
<p>5 Redial/Pause: In Standby mode, redials the last number, or in Edit mode, inserts a pause into a fax number.</p>	<p>17 Reduce/Enlarge: Makes a copy smaller or larger than the original.</p>
<p>6 Fax: Activates Fax mode.</p>	<p>18 USB Print: Allows you to directly print files stored on a USB Memory device when it is inserted into the USB memory port on the front of your machine.</p>
<p>7 Copy: Activates Copy mode.</p>	<p>19 Duplex: Allows you to print documents on both sides of the paper.</p>
<p>8 Scan/Email: Activates Scan mode.</p>	<p>20 Toner Save: Allows you to save on toner by using less toner in printing.</p>
<p>9 Display: Shows the current status and prompts during an operation.</p>	<p>21 Number keypad: dials a number or enters alphanumeric characters.</p>
<p>10 Menu: Enters Menu mode and scrolls through the available menus.</p>	<p>22 On Hook Dial: Engages the telephone line.</p>
<p>11 Scroll buttons: Scroll through the options available in the selected menu, and increase or decrease values.</p>	<p>23 Stop/Clear: Stops an operation at any time. In Standby mode, clears/cancels the copy options, such as the darkness, the document type setting, the copy size, and the number of copies.</p>
<p>12 OK: Confirms the selection on the screen.</p>	<p>24 Start: Starts a job.</p>

Control panel overview (SCX-5330N)

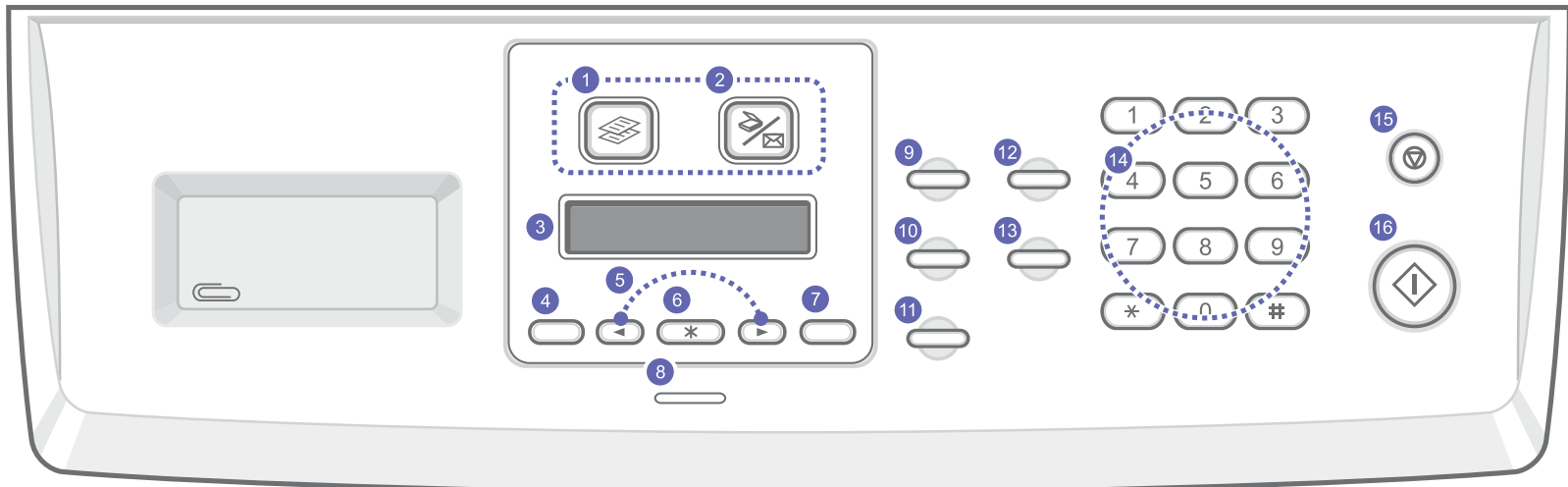

1	Copy: Activates Copy mode.	9	Darkness: Adjusts the document brightness for the current copy job.
2	Scan/Email: Activates Scan mode.	10	Original Type: Selects the document type for the current copy job.
3	Display: Shows the current status and prompts during an operation.	11	Reduce/Enlarge: Makes a copy smaller or larger than the original.
4	Menu: Enters Menu mode and scrolls through the available menus.	12	Address Book: Allows you to search for stored email addresses. Also, allows you to print an Address Book list.
5	Scroll buttons: Scroll through the options available in the selected menu, and increase or decrease values.	13	Toner Save: Allows you to save on toner by using less toner in printing.
6	OK: Confirms the selection on the screen.	14	Number keypad: Dials a number or enters alphanumeric characters.
7	Back: Sends you back to the upper menu level.	15	Stop/Clear: Stops an operation at any time. In Standby mode, clears/cancels the copy options, such as the resolution, the document type setting, the copy size, and the number of copies.
8	Status: Shows the status of your machine. See page 1.5.	16	Start: Starts a job.



Note

Use the recessed area on the right of the **control panel** for storing clips to bind printouts.



Understanding the Status LED

The **Status** LED on the control panel shows the status of your machine. See the table below to know your machine's status.

Status		Description
Off		<ul style="list-style-type: none"> The machine is off-line. The machine is in Power Save mode. When data is received, or any button is pressed, it switches to on-line automatically.
Green	On	The machine is on-line and can be used.
	Blinking	<ul style="list-style-type: none"> When the backlight slowly blinks, the machine is receiving data from the computer. When the backlight fast blinks, the machine is printing data.
Red	On	<ul style="list-style-type: none"> The toner cartridge is totally exhausted. Remove the old toner cartridge and install a new one. See page 13.5. A paper jam has occurred. To solve the problem, see page 14.2. The front cover is open. Close the front cover. There is no paper in the tray. Load paper in the tray. The toner cartridge installed is not a genuine cartridge, and you selected Stop at the NonGenuine Toner prompt. See page 14.10. The lifespan of the toner cartridge is reached, and you selected Stop at the Toner Exhausted prompt. See page 14.10. The machine has stopped due to a major error. Check the display message. See page 14.7 for details on the meaning of the error message.
	Blinking	<ul style="list-style-type: none"> A minor error occurs and the machine is waiting an error to be cleared. Check the display message. When the problem is cleared, the machine resumes. The toner cartridge installed is not a genuine cartridge, and you selected Continue at the NonGenuine Toner prompt. See page 14.10. The lifespan of the toner cartridge is reached, and you selected Continue at the Toner Exhausted prompt. See page 14.10. The toner cartridge is low. Order a new toner cartridge. You can temporarily improve print quality by redistributing the toner. See page 13.4.

Finding more information

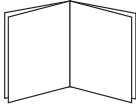
You can find information for setting up and using your machine from the following resources, either printed or onscreen.

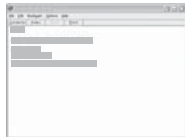
<p>Quick Install Guide</p> 	<p>Provides information on setting up your machine and, therefore, be sure to follow the instructions in the guide to get the machine ready.</p>
<p>Online User's Guide</p> 	<p>Provides you with step-by-step instructions for using your machine's full features, and contains information for maintaining your machine, troubleshooting, and installing accessories.</p> <p>This user's guide also contains the Software Section providing you with information on how to print documents with your machine on various operating systems, and how to use the supplied software utilities.</p> <p>Note  You can access the user's guides in other languages from the Manual folder on the printer software CD.</p>
<p>Printer Driver Help</p> 	<p>Provides you with help information on printer driver properties and instructions for setting up the properties for printing. To access a printer driver help screen, click Help from the printer properties dialog box.</p>
<p>website</p>	<p>If you have Internet access, you can get help, support, printer drivers, manuals, and order information from the Samsung website, www.samsungprinter.com.</p>

Selecting a location

Select a level, stable place with adequate space for air circulation. Allow extra space for opening covers and trays.

The area should be well-ventilated and away from direct sunlight or sources of heat, cold, and humidity. Do not set the machine close to the edge of your desk or table.

Clearance space

- **Front:** 482,6 mm (enough space so that the paper tray can be removed)
- **Back:** 100 mm (enough space for ventilation)
- **Right:** 100 mm (enough space for ventilation)
- **Left:** 100 mm (enough space for ventilation)

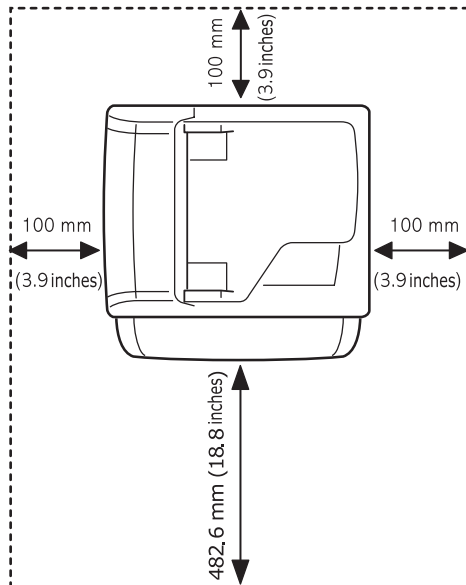

2 System setup

This chapter gives you an overview of menus available on your machine and step-by-step instructions for setting up the machine's systems.

This chapter includes:

- **Menu overview**
- **Changing the display language**
- **Setting the date and time**
- **Changing the default mode (SCX-5530FN only)**
- **Setting sounds (SCX-5530FN only)**
- **Entering characters using the number keypad**
- **Using the save modes**
- **Setting print job timeout**

Menus in the colored characters are available only with SCX-5530FN.

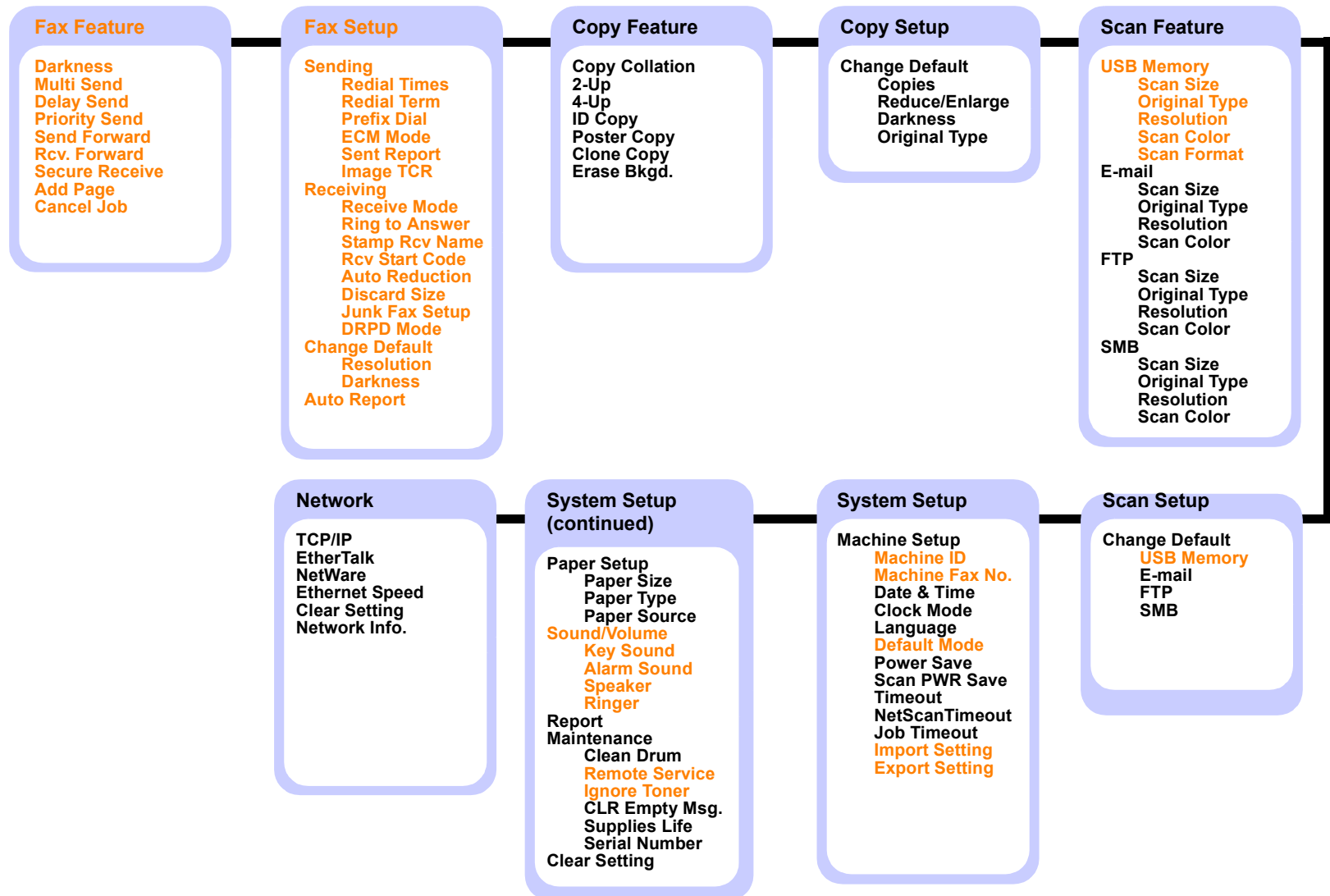

Changing the display language

To change the language that appears on the control panel, follow these steps:

- 1 Press **Menu** until **System Setup** appears on the bottom line of the display and press **OK**.
- 2 Press **OK** when **Machine Setup** appears.
- 3 Press the **Scroll** buttons until **Language** appears and press **OK**.
- 4 Press the **Scroll** buttons until the language you want appears and press **OK**.
- 5 Press **Stop/Clear** to return to Standby mode.

Setting the date and time

The current date and time are shown on the display when your machine is on and ready to work. For the SCX-5530FN, all of your faxes will have the date and time printed on them.



Note

If power to the machine is cut off, you need to reset the correct time and date once the power has been restored.

- 1 Press **Menu** until **System Setup** appears on the bottom line of the display and press **OK**.
- 2 Press **OK** when **Machine Setup** appears.
- 3 Press the **Scroll** buttons until **Date & Time** appears and press **OK**.
- 4 Enter the correct time and date using the number keypad.

Month = 01 to 12
Day = 01 to 31
Year = requires four digits
Hour = 01 to 12 (12-hour mode)
 00 to 23 (24-hour mode)
Minute = 00 to 59



Note

The date format may differ from country to country.

You can also use the **Scroll** buttons to move the cursor under the digit you want to correct and enter a new number.

- 5 To select **AM** or **PM** for 12-hour format, press the **✕** or **⌘** button or any number button.

When the cursor is not under the AM or PM indicator, pressing the **✕** or **⌘** button immediately moves the cursor to the indicator.

You can change the clock mode to 24-hour format (e.g. 01:00 PM as 13:00). For details, see the next section.

- 6 Press **OK** to save the time and date.

When you enter a wrong number, **Out of Range** appears and the machine does not proceed to the next step. If this happens, simply reenter the correct number.

- 7 Press **Stop/Clear** to return to Standby mode.

Changing the clock mode

You can set your machine to display the current time using either a 12-hour or 24-hour format.

- 1 Press **Menu** until **System Setup** appears on the bottom line of the display and press **OK**.
- 2 Press **OK** when **Machine Setup** appears.
- 3 Press the **Scroll** buttons until **Clock Mode** appears and press **OK**.
- 4 Press the **Scroll** buttons to select the other mode and press **OK**.
- 5 Press **Stop/Clear** to return to Standby mode.

Changing the default mode (SCX-5530FN only)

Your machine is preset to Fax mode. You can switch this default mode between Fax mode and Copy mode.

- 1 Press **Menu** until **System Setup** appears on the bottom line of the display and press **OK**.
- 2 Press **OK** when **Machine Setup** appears.
- 3 Press the **Scroll** buttons until **Default Mode** appears and press **OK**.
- 4 Press the **Scroll** buttons until the default mode you want appears and press **OK**.
- 5 Press **Stop/Clear** to return to Standby mode.

Setting sounds (SCX-5530FN only)

You can control the following sounds:

- **Key Sound:** Turns the key sound on or off. With this option set to **On**, a tone sounds each time a key is pressed.
- **Alarm Sound:** Turns the alarm sound on or off. With this option set to **On**, an alarm tone sounds when an error occurs or fax communication ends.
- **Speaker:** Turns on or off the sounds from the telephone line through the speaker, such as a dial tone or a fax tone. With this option set to **Comm.** which means "Common," the speaker is on until the remote machine answers.

You can adjust the volume level using **On Hook Dial**.

- **Ringer:** Adjusts the ringer volume. For the ringer volume, you can select **Off**, **Low**, **Mid**, and **High**.

Speaker, ringer, key sound, and alarm sound

- 1 Press **Menu** until **System Setup** appears on the bottom line of the display and press **OK**.
- 2 Press the **Scroll** buttons until **Sound/Volume** appears and press **OK**.
- 3 Press the **Scroll** buttons until the sound option you want appears and press **OK**.
- 4 Press the **Scroll** buttons until the desired status or volume for the sound you have selected appears and press **OK**.
- 5 If necessary, repeat steps 3 through 5 to set other sounds.
- 6 Press **Stop/Clear** to return to Standby mode.

Speaker volume

- 1 Press **On Hook Dial**. A dial tone sounds from the speaker.
- 2 Press the **Scroll** buttons until you hear the volume you want.
- 3 Press **On Hook Dial** to save the change and return to Standby mode.



Note

You can adjust the speaker volume only when the telephone line is connected.

Entering characters using the number keypad

As you perform various tasks, you may need to enter names and numbers. For example, when you set up your machine, you enter your name or your company's name, and the fax number. When you store fax numbers or email addresses in memory, you may also enter the corresponding names.

Entering alphanumeric characters

- 1 When you are prompted to enter a letter, locate the button labeled with the character you want. Press the button until the correct letter appears on the display.

For example, to enter the letter **O**, press **6**, labeled with **MNO**.

Each time you press **6**, the display shows a different letter, **M**, **N**, **O**, and finally **6**.

You can enter special characters, such as space, plus sign, and etc. For details, see the below section.

- 2 To enter additional letters, repeat step 1.

If the next letter is printed on the same button, move the cursor by pressing the right **Scroll** button and then press the button labeled with the letter you want. The cursor will move to the right and the next letter will appear on the display.

You can enter a space by pressing **1** twice.

- 3 When you have finished entering letters, press **OK**.

Keypad letters and numbers

Key	Assigned numbers, letters, or characters
1	1 Space
2	A B C a b c 2
3	D E F d e f 3
4	G H I g h i 4
5	J K L j k l 5
6	M N O m n o 6
7	P Q R S p q r s 7
8	T U V t u v 8
9	W X Y Z w x y z 9
0	+ - , . ' / * # & @ 0

Correcting numbers or names

If you make a mistake while entering a number or name, press the left **Scroll** button to delete the last digit or character. Then enter the correct number or character.

Inserting a pause

With some telephone systems, you must dial an access code (9, for example) and listen for a second dial tone. In such cases, you must insert a pause in the telephone number. You can insert a pause while you are setting up speed buttons or speed dial numbers.

To insert a pause, press **Redial/Pause** at the appropriate place while entering the telephone number. A - appears on the display at the corresponding location.

Using the save modes

Toner Save mode

Toner Save mode allows your machine to use less toner on each page. Activating this mode extends the life of the toner cartridge beyond what one would experience in the normal mode, but it reduces print quality.

To turn this mode on or off, press **Toner Save**.



Note

When PC-printing, you can also turn on or off Toner Save mode in the printer properties. See the **Software Section**.

Power Save mode

Power Save mode allows your machine to reduce power consumption when it is not in actual use. You can turn this mode on and select a length of time for which the machine waits after a job is printed before it switches to a reduced power state.

- 1 Press **Menu** until **System Setup** appears on the bottom line of the display and press **OK**.
- 2 Press **OK** when **Machine Setup** appears.
- 3 Press the **Scroll** buttons until **Power Save** appears and press **OK**.
- 4 Press the **Scroll** buttons until **On** appears and press **OK**.
- 5 Press the **Scroll** buttons until the time setting you want appears and press **OK**.
- 6 Press **Stop/Clear** to return to Standby mode.

Scan Power Save mode

Scan Power Save mode allows you to save power by turning off the scan lamp. The scan lamp under the scanner glass automatically turns off when it is not in actual use to reduce power consumption and extend the life of the lamp. The lamp automatically wakes up after some warm-up time when you start scanning.

You can set the length of time for which the scan lamp waits after a scan job is completed before it switches to the power save mode.

- 1 Press **Menu** until **System Setup** appears on the bottom line of the display and press **OK**.
- 2 Press **OK** when **Machine Setup** appears.
- 3 Press the **Scroll** buttons until **Scan PWR Save** appears and press **OK**.
- 4 Press the **Scroll** buttons until the time setting you want appears and press **OK**.
- 5 Press **Stop/Clear** to return to Standby mode.

Setting print job timeout

You can set the amount of time a single print job is active before it must print.

The machine handles incoming data as a single job if it comes in within the specified time. When an error occurs while processing data from the computer and the data flow stops, the machine waits the specified time and then cancels printing if data flow does not resume.

- 1 Press **Menu** until **System Setup** appears on the bottom line of the display and press **OK**.
- 2 Press **OK** when **Machine Setup** appears.
- 3 Press the **Scroll** buttons until **Job Timeout** appears and press **OK**.
- 4 Press the **Scroll** buttons until the time setting you want appears and press **OK**.
- 5 Press **Stop/Clear** to return to Standby mode.

3 Software overview

This chapter gives you an overview of the software that comes with your machine. Further details about installing and using the software are explained in the **Software Section**.

This chapter includes:

- **Supplied software**
- **Printer driver features**
- **System requirements**

Supplied software

You must install the printer and scanner software using the supplied CDs after you have set up your machine and connected it to your computer. Each CD provides you with the following software:

CD	Contents	
Printer software CD	Windows	<ul style="list-style-type: none"> • Printer driver: Use this driver to take full advantage of your printer's features. • Scanner driver: TWAIN and Windows Image Acquisition (WIA) drivers are available for scanning documents on your machine. • Smart Panel: This program allows you to monitor the machine's status and alerts you when an error occurs during printing. • SmarThru¹: This is the accompanying Windows-based software for your multifunctional machine. • Network Scan: This program allows you to scan a document on your machine and save it to a network-connected computer. • Direct Print Utility: This program allows you to print PDF files directly. • User's Guide in PDF • Set IP: Use this program to set your machine's TCP/IP addresses.
	Linux	<ul style="list-style-type: none"> • Printer driver: Use this driver to run your machine from a Linux computer and print documents. • SANE: Use this driver to scan documents. • Smart Panel: This program allows you to monitor the machine's status and alerts you when an error occurs during printing.

CD	Contents	
PostScript printer driver CD (SCX-5530FN only)	Windows	<ul style="list-style-type: none"> • Postscript Printer Description (PPD) file: Use the PostScript driver to print documents with complex fonts and graphics in the PS language. • User's Guide in PDF
	Macintosh	<ul style="list-style-type: none"> • Postscript Printer Description (PPD) file: Use this file to run your machine from a Macintosh computer and print documents. • Scan driver: TWAIN driver is available for scanning documents on your machine. • Smart Panel: This program allows you to monitor the machine's status and alerts you when an error occurs during printing.

1. Allows you to edit a scanned image in many ways using a powerful image editor and to send the image by email. You can also open another image editor program, like Adobe Photoshop, from SmarThru. For details, please refer to the onscreen help supplied on the SmarThru program.

Printer driver features

Your printer drivers support the following standard features:

- Paper source selection
- Paper size, orientation and media type
- Number of copies

In addition, you can use various special printing features. The following table shows a general overview of features supported by your printer drivers:

Feature	PCL 6	PostScript (SCX-5530FN only)		
	Windows	Windows	Macintosh	Linux
Toner save	○	○	X	○
Print quality option	○	○	○	○
Poster printing	○	X	X	X
Multiple pages per sheet (N-up)	○	○	○	○ (2, 4)
Fit to page printing	○	○	○	○
Scale printing	○	○	○	○
Different source for first page	○	X	X	X
Watermark	○	X	X	X
Overlay ¹	○	X	X	X

1. The Overlay feature is not supported in NT 4.0.

System requirements

Before you begin, ensure that your system meets the following requirements:

Windows

Item	Requirements		Recommended
Operating system	Windows 98/Me/NT 4.0/2000/XP/2003		
CPU	Windows 98/ Me/NT 4.0/2000	Pentium II 400 MHz or higher	Pentium III 933 MHz
	Windows XP/ 2003	Pentium III 933 MHz or higher	Pentium IV 1 GHz
RAM	Windows 98/ Me/NT 4.0/2000	64 MB or more	128 MB
	Windows XP/ 2003	128 MB or more	256 MB
Free disk space	Windows 98/ Me/NT 4.0/2000	300 MB or more	1 GB
	Windows XP/ 2003	1 GB or more	5 GB
Internet Explorer	5.0 or higher		



Note

For Windows NT 4.0/2000/XP/2003, users who have an administrator right can install the software.

Linux

Item	Requirements
Operating system	<ul style="list-style-type: none">• Red Hat 8.0 ~ 9.0• Fedora Core 1 ~ 3• Mandrake 9.2 ~ 10.1• SuSE 8.2 ~ 9.2
CPU	Pentium IV 1 GHz or higher
RAM	256 MB or higher
Free disk space	1 GB or higher
Software	<ul style="list-style-type: none">• Linux Kernel 2.4 or higher• Glibc 2.2 or higher• CUPS• SANE(for MFP device only)



Notes

- It is necessary to claim swap partition of 300 MB or larger for working with large scanned images.
- The Linux scanner driver supports the optical resolution at maximum.

Macintosh (SCX-5530FN only)

Item	Requirements
Operating system	Macintosh 10.3 ~ 10.4
RAM	128 MB
Free disk space	200 MB
Connection	USB interface, Network interface

4 Network setup

This chapter gives you step-by-step instructions for setting up your machine for network connections.

This chapter includes:

- **Introduction**
- **Supported operating systems**
- **Configuring TCP/IP**
- **Configuring EtherTalk**
- **Configuring IPX frame types**
- **Setting Ethernet speed**
- **Restoring the network configuration**
- **Printing a network configuration page**
- **Using SetIP program**

Introduction

Once you have connected your machine to a network with an RJ-45 Ethernet cable, you can share the machine with other network users.

You need to set up the network protocols on the machine to use it as your network printer. Protocols can be set up by the following two methods:

Via network administration programs

You can configure your machine's print server settings and manage the machine via the following programs that came with your machine:

- **SyncThru™ Web Admin Service:** Web-based printer management solution for network administrators. **SyncThru™ Web Admin Service** provides you with an efficient way of managing network devices and lets you remotely monitor and troubleshoot network machines from anywhere with corporate internet access. Download this program from <http://solution.samsungprinter.com>.
- **SyncThru™ Web Service:** A web server embedded to your network print server, which allows you to:
 - Configure the network parameters necessary for the machine to connect to various network environments.
 - Customize e-mail settings and set up **Address Book** for scanning to email.
 - Customize server settings and set up **Address Book** for scanning to an FTP or SMB servers.
 - Customize printer, copy, and fax settings.
- **SetIP:** Utility program allowing you to select a network interface and manually configure the IP addresses for use with the TCP/IP protocol. See Using SetIP program on page 4.3

Via the control panel

You can set up the following basic network parameters through the machine's control panel:

- Configure TCP/IP
- Configure IPX frame types for NetWare
- Configure EtherTalk

Supported operating systems

The following table shows the network environments supported by the machine:

Item	Requirements
Network interface	<ul style="list-style-type: none">• 10/100 Base-TX
Network operating system	<ul style="list-style-type: none">• Novell NetWare 4.x, 5.x, 6.x• Windows 98/Me/NT 4.0/2000/XP/2003• Various Linux OS• Macintosh OS 10.3 ~ 10.4
Network protocols	<ul style="list-style-type: none">• NetWare IPX/SPX• TCP/IP on Windows• EtherTalk (SCX-5530FN only)
Dynamic addressing server	<ul style="list-style-type: none">• DHCP, BOOTP

- IPX/SPX: Internet Packet eXchange/Sequenced Packet eXchange
- TCP/IP: Transmission Control Protocol/Internet Protocol
- DHCP: Dynamic Host Configuration Protocol
- BOOTP: Bootstrap Protocol

Configuring TCP/IP

Your machine can be set up with a variety of TCP/IP network information, such as an IP address, a subnet mask, a gateway, and DNS addresses. There are several ways in which your machine can be assigned a TCP/IP address, depending on your network.

- **Static addressing:** A TCP/IP address is assigned manually by the system administrator.
- **Dynamic addressing via BOOTP/DHCP (default):** A TCP/IP address is assigned automatically by the server.



Note

Before configuring TCP/IP, you need to set the network protocol to TCP/IP.

Static addressing

To enter a TCP/IP address from your machine's control panel, take the following steps:

- 1 Press **Menu** until **Network** appears on the bottom line of the display and press **OK**.
- 2 Press **OK** when **TCP/IP** appears.
- 3 Press the **Scroll** buttons until **Static** appears and press **OK**.
- 4 Press **OK** when **IP Address** appears.
- 5 Enter a byte between 0 and 255 using the number keypad and press the **Scroll** buttons to move between bytes.

Repeat this to complete the address from the 1st byte to the 4th byte.

- 6 When you have finished, press **OK**.
- 7 Repeat steps 5 and 6 to configure the other TCP/IP parameters: subnet mask and gateway address.
- 8 Press the **Scroll** buttons until **Static** appears and press **OK**.
- 9 Press the **Scroll** buttons until **Primary DNS** appears and press **OK**.
- 10 Enter each byte of the address and press **OK**.
- 11 Press the **Scroll** buttons until **Secondary DNS** appears and press **OK**.
- 12 Enter each byte of the address and press **OK**.
- 13 Press **Stop/Clear** to return to Standby mode.

Dynamic addressing (BOOTP/DHCP)

To have a TCP/IP address assigned automatically by the server, take the following steps:

- 1 Press **Menu** until **Network** appears on the bottom line of the display.
- 2 Press **OK** when **TCP/IP** appears.
- 3 Press the **Scroll** buttons until **DHCP** or **BOOTP** appears and press **OK**.
- 4 Press **Stop/Clear** to return to Standby mode.

Configuring EtherTalk

EtherTalk is AppleTalk used in an Ethernet network. This protocol is widely used in Macintosh network environments. To use EtherTalk, take the following steps:

- 1 Press **Menu** until **Network** appears on the bottom line of the display and press **OK**.
- 2 Press the **Scroll** buttons until **EtherTalk** appears and press **OK**.
- 3 Press the **Scroll** buttons until **On** appears and press **OK**.
- 4 Press **Stop/Clear** to return to Standby mode.

Configuring IPX frame types

To use IPX/SPX protocol networks (for example, Novell NetWare), the format of the network communication frames must be specified for the machine. In most cases, you can keep the **Auto** setting. However, you can manually set the frame type format, if required. Take the following steps to change the frame type format:

- 1 Press **Menu** until **Network** on the bottom line of the display and press **OK**.
- 2 Press the **Scroll** buttons until **NetWare** appears and press **OK**.
- 3 Press the **Scroll** buttons until the desired frame type appears.
 - **Auto**: Automatically senses and limits the frame type to the first one detected.
 - **802.2**: Limits the frame type to IPX over IEEE 802.2 with IEEE 802.3 frames. All others will be discarded.
 - **802.3**: Limits the frame type to IPX over IEEE 802.3 frames. All others will be discarded.
 - **Ethernet II**: Limits the frame type to IPX over Ethernet Frames. All others will be discarded.
 - **SNAP**: Limits the frame type to IPX over SNAP with IEEE 802.3 frames. All others will be discarded.
 - **Off**: The IPX/SPX protocol is disabled.
- 4 Press **OK** to save the selection.
- 5 Press **Stop/Clear** to return to Standby mode.

Setting Ethernet speed

You can select the communication speed for Ethernet connections.

- 1 Press **Menu** until **Network** appears on the bottom line of the display and press **OK**.
- 2 Press the **Scroll** buttons until **Ethernet Speed** appears and press **OK**.
- 3 Press the **Scroll** buttons until the speed you want appears and press **OK**.
- 4 Press **Stop/Clear** to return to Standby mode.

Restoring the network configuration

You can return the network configuration to its default settings.

- 1 Press **Menu** until **Network** appears on the bottom line of the display and press **OK**.
- 2 Press the **Scroll** buttons until **Clear Setting** appears and press **OK**.
- 3 Press **OK** when **Yes** appears to restore the network configuration.
- 4 Power the machine off and back on.

Printing a network configuration page

The Network Configuration page shows how the network interface card on your machine is configured.

- 1 Press **Menu** until **Network** appears on the bottom line of the display and press **OK**.
- 2 Press the **Scroll** buttons until **Network Info.** appears and press **OK**.
- 3 Press **OK** when **Yes** appears.

The Network Configuration page prints out.

Using SetIP program

This program is for the network IP setting using the MAC address which is the hardware serial number of the network printer card or interface. Especially, it is for the network administrator to set several network IPs at the same time.

- 1 Insert the driver CD provided along with your machine.
- 2 Start Windows Explorer and open the X drive. (X represents your CD-ROM drive.)
- 3 Double click **Application > SetIP**
- 4 Open the language folder you want to use.

- 5 Double click **Setup.exe** to install this program.
- 6 From the Windows Start menu, select **Programs > Samsung Network Printer Utilities > SetIP**.
- 7 Select the name of your printer and click “  ”.



Note

- If you cannot find your printer name click “  ” to refresh the list.

- 8 Enter the network card's MAC address, IP address, subnet mask, default gateway, and then click **Apply**.



Note

- If you do not know the network card's MAC address, print the machine's network information report.

- 9 Click **OK** to confirm the settings.
- 10 Click **Exit** to close the SetIP program.

5 Loading originals and print media

This chapter introduces you to how to load originals and print media into your machine.

This chapter includes:

- **Loading originals**
- **Selecting print media**
- **Loading paper**
- **Setting the paper size and type**
- **Selecting an output location**

Loading originals

You can use the scanner glass or ADF to load an original for copying, scanning, and sending a fax.

On the scanner glass

Make sure that no originals are in the ADF. If an original is detected in the ADF, the machine gives it priority over the original on the scanner glass. To get the best scan quality, especially for colored or gray-scaled images, use the scanner glass.

- 1 Lift and open the scanner lid.

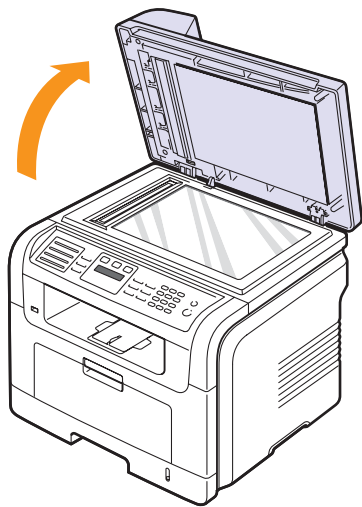

- 2 Place the original **face down** on the scanner glass and align it with the registration guide at the top left corner of the glass.

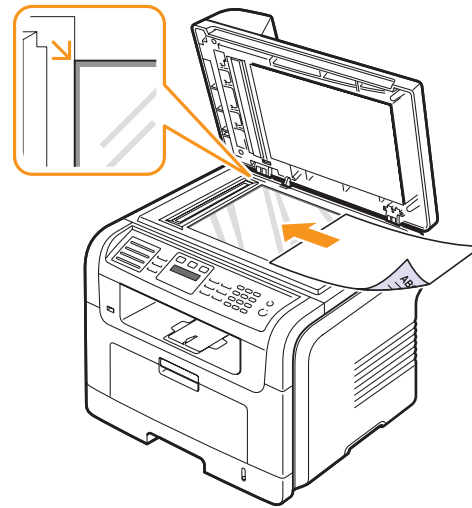

- 3 Close the scanner lid.



Notes

- Leaving the scanner lid open while copying may affect copy quality and toner consumption.
- Dust on the scanner glass may cause black spots on the printout. Always keep it clean.
- If you are copying a page from a book or magazine, lift the scanner lid until its hinges are caught by the stopper and then close the lid. If the book or magazine is thicker than 30 mm, start copying with the lid open.

In the ADF

Using the ADF, you can load up to 50 sheets of paper (75 g/m²) for one job.

When you use the ADF:

- Do not load paper smaller than 142 x 148 mm or larger than 216 x 356 mm.
- Do not attempt to load the following types of paper:
 - carbon-paper or carbon-backed paper
 - coated paper
 - onion skin or thin paper
 - wrinkled or creased paper
 - curled or rolled paper
 - torn paper
- Remove all staples and paper clips before loading.
- Make sure any glue, ink, or correction fluid on the paper is completely dry before loading.
- Do not load originals that include different sizes or weights of paper.
- Do not load booklets, pamphlets, transparencies, or documents having other unusual characteristics.

To load an original into the ADF:

- 1 Load the original face up into the ADF. Make sure that the bottom of the original stack matches the paper size marked on the document input tray.

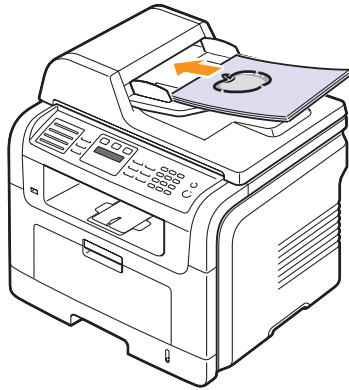

- 2 Adjust the document width guides to the paper size.

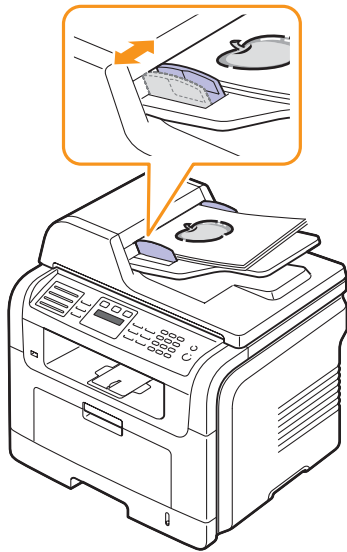

Note

Dust on the ADF glass may cause black lines on the printout. Always keep it clean.

Selecting print media

You can print on a variety of print media, such as plain paper, envelopes, labels, and transparencies. Always use print media that meet the guidelines for use with your machine. Print media that does not meet the guidelines outlined in this user's guide may cause the following problems:

- Poor print quality
- Increased paper jams
- Premature wear on the machine.

Properties, such as weight, composition, grain, and moisture content, are important factors that affect the machine's performance and the output quality. When you choose print materials, consider the following:

- The type, size and weight of the print media for your machine is described in following tables.
- Desired outcome: The print media you choose should be appropriate for your project.
- Brightness: Some print media are whiter than others and produce sharper, more vibrant images.
- Surface smoothness: The smoothness of the print media affects how crisp the printing looks on the paper.



Notes

- Some print media may meet all of the guidelines in this section and still not produce satisfactory results. This may be the result of improper handling, unacceptable temperature and humidity levels, or other variables over which Samsung has no control.
- Before purchasing large quantities of print media, ensure that it meets the requirements specified in this user's guide.



Caution

Using print media that does not meet these specifications may cause problems, requiring repairs. Such repairs are not covered by Samsung's warranty or service agreements.

Supported print media types and sizes

Type	Size	Dimensions	Weight ¹	Capacity ²
Plain paper	Letter	216 x 279 mm (8.5 x 11 inches)	<ul style="list-style-type: none"> • 60 to 90 g/m² (16 to 24 lb bond) for the tray • 60 to 163 g/m² (16 to 43 lb bond) for the multi-purpose tray 	<ul style="list-style-type: none"> • 250 sheets of 75 g/m² (20 lb bond) paper for the tray • 50 sheets for the multi-purpose tray
	Legal	216 x 356 mm (8.5 x 14 inches)		
	Folio	216 x 330.2 mm (8.5 x 13 inches)		
	Oficio	216 x 343 mm (8.5 x 13.5 inches)		
	A4	210 x 297 mm (8.27 x 11.69 inches)		
	JIS B5	182 x 257 mm (7.18 x 10.12 inches)		
	ISO B5	176 x 250 mm (6.93 x 9.84 inches)		
	Executive	184.2 x 266.7 mm (7.25 x 10.5 inches)		
	A5	148.5 x 210 mm (5.85 x 8.27 inches)		
	A6	105 x 148.5 mm (4.13 x 5.85 inches)		
Envelope	Envelope B5	176 x 250 mm (6.93 x 9.84 inches)	75 to 90 g/m ² (20 lb to 24 lb bond)	5 sheets of 75 g/m ² (20 lb bond) in the multi-purpose tray
	Envelope Monarch	98.4 x 190.5 mm (3.88 x 7.5 inches)		
	Envelope COM-10	105 x 241 mm (4.12 x 9.5 inches)		
	Envelope DL	110 x 220 mm (4.33 x 8.66 inches)		
	Envelope C5	162 x 229 mm (6.38 x 9.02 inches)		
	Envelope C6	114 x 162 mm (4.49 x 6.38 inches)		
Transparency	Letter, A4	Refer to the Plain paper section	138 to 146 g/m ² (37 to 39 lb bond)	5 sheets of 75 g/m ² (20 lb bond) in the multi-purpose tray
Labels	Letter, Legal, Folio, A4, JIS B5, ISO B5, Executive, A5, A6	Refer to the Plain paper section	120 to 150 g/m ² (32 to 40 lb bond)	5 sheets of 75 g/m ² (20 lb bond) in the multi-purpose tray
Card stock	Letter, Legal, Folio, A4, JIS B5, ISO B5, Executive, A5, A6	Refer to the Plain paper section	60 to 163 g/m ² (16 to 43 lb bond)	5 sheets of 75 g/m ² (20 lb bond) in the multi-purpose tray
Minimum size (custom)		76 x 127 mm (3 x 5 inches)	60 to 163 g/m ² (16 to 43 lb bond)	5 sheets of 75 g/m ² (20 lb bond) in the multi-purpose tray
Maximum size (custom)		215.9 x 356 mm (8.5 x 14 inches)		

1. If media weight is over 90 g/m² (24 lb bond), use the multi-purpose tray.

2. Maximum capacity may differ depending on media weight, thickness, and environmental conditions.

Media sizes supported in each mode

Mode	Size	Source
Copy mode	Letter, A4, Legal, Folio, Executive, ISO B5, JIS B5, A5, A6	<ul style="list-style-type: none"> • tray 1 • optional tray 2 • multi-purpose tray
Single side printing	All sizes supported by the machine	<ul style="list-style-type: none"> • tray 1 • optional tray 2 • multi-purpose tray
Duplex printing ¹	Letter, A4, Legal, Folio	<ul style="list-style-type: none"> • tray 1 • optional tray 2 • multi-purpose tray
Fax mode ²	Letter, A4, Legal	<ul style="list-style-type: none"> • tray 1 • optional tray 2

1. SCX-5530FN only
75 to 90 g/m² (20 to 24 lb bond) only

2. **SCX-5530FN** only

Guidelines for selecting and storing print media

When selecting or loading paper, envelopes, or other print materials, keep these guidelines in mind:

- Always use print media that conform with the specifications listed on page 5.3.
- Attempting to print on damp, curled, wrinkled, or torn paper can cause paper jams and poor print quality.
- For the best print quality, use only high quality copier grade paper specifically recommended for use in laser printers.
- Avoid using the following media types:
 - Paper with embossed lettering, perforations, or a texture that is too smooth or too rough
 - Erasable bond paper
 - Multi-paged paper
 - Synthetic paper and thermally reactive paper
 - Carbonless paper and Tracing paper.

Use of these types of paper could result in paper jams, chemical smells, and damage to your machine.

- Store print media in its ream wrapper until you are ready to use it. Place cartons on pallets or shelves, not on the floor. Do not place heavy objects on top of the paper, whether it is packaged or unpackaged. Keep it away from moisture or other conditions that can cause it to wrinkle or curl.
- Store unused print media at temperatures between 15 °C and 30 °C. The relative humidity should be between 10% and 70%.
- Store unused print media in a moisture-proof wrap, such as a plastic container or bag, to prevent dust and moisture from contaminating your paper.
- Load special media types one sheet at a time through the multi-purpose tray to avoid paper jams.
- To prevent print media, such as transparencies and label sheets, from sticking together, remove them as they print out.

Guidelines for special print media

Media type	Guidelines
Envelopes	<ul style="list-style-type: none"> • Successful printing on envelopes depends upon the quality of the envelopes. When selecting envelopes, consider the following factors: <ul style="list-style-type: none"> - Weight: The weight of the envelope paper should not exceed 90 g/m² or jamming may occur. - Construction: Prior to printing, envelopes should lie flat with less than 6 mm curl, and should not contain air. - Condition: Envelopes should not be wrinkled, nicked, or otherwise damaged. - Temperature: You should use envelopes that are compatible with the heat and pressure of the machine during operation. • Use only well-constructed envelopes with sharp and well creased folds. • Do not use stamped envelopes. • Do not use envelopes with clasps, snaps, windows, coated lining, self-adhesive seals, or other synthetic materials. • Do not use damaged or poorly made envelopes. • Be sure the seam at both ends of the envelope extends all the way to the corner of the envelope. <div style="text-align: center;"> </div> <ul style="list-style-type: none"> • Envelopes with a peel-off adhesive strip or with more than one flap that folds over to seal must use adhesives compatible with the machine's fusing temperature of 180 °C for 0,1 second. The extra flaps and strips might cause wrinkling, creasing, or jams, and may even damage the fuser. • For the best print quality, position margins no closer than 15 mm from the edges of the envelope. • Avoid printing over the area where the envelope's seams meet.

Media type	Guidelines
Transparencies	<ul style="list-style-type: none"> To avoid damaging the machine, use only transparencies designed for use in laser printers. Transparencies used in the machine must be able to withstand 180 °C, the machine's fusing temperature. Place them on a flat surface after removing them from the machine. Do not leave them in the paper tray for long periods of time. Dust and dirt may accumulate on them, resulting in spotty printing. To avoid smudging caused by fingerprints, handle them carefully. To avoid fading, do not expose printed transparencies to prolonged sunlight. Ensure that transparencies are not wrinkled, curled, or have any torn edges.
Labels	<ul style="list-style-type: none"> To avoid damaging the machine, use only labels designed for use in laser printers. When selecting labels, consider the following factors: <ul style="list-style-type: none"> - Adhesives: The adhesive material should be stable at 180 °C, the machine's fusing temperature. - Arrangement: Only use labels with no exposed backing between them. Labels can peel off sheets that have spaces between the labels, causing serious jams. - Curl: Prior to printing, labels must lie flat with no more than 13 mm of curl in any direction. - Condition: Do not use labels with wrinkles, bubbles, or other indications of separation. Make sure that there is no exposed adhesive material between labels. Exposed areas can cause labels to peel off during printing, which can cause paper jams. Exposed adhesive can also cause damage to machine components. Do not run a sheet of labels through the machine more than once. The adhesive backing is designed for only a single pass through the machine. Do not use labels that are separating from the backing sheet or are wrinkled, bubbled, or otherwise damaged.
Card stock or custom-sized materials	<ul style="list-style-type: none"> Do not print on media smaller than 98 mm wide or 148 mm long. In the software application, set margins at least 6,4 mm away from the edges of the material.

Media type	Guidelines
Preprinted paper	<ul style="list-style-type: none"> Letterhead must be printed with heat-resistant ink that will not melt, vaporize, or release hazardous emissions when subjected to the machine's fusing temperature of 180 °C for 0,1 second. Letterhead ink must be non-flammable and should not adversely affect printer rollers. Forms and letterhead should be sealed in a moisture-proof wrapping to prevent changes during storage. Before you load preprinted paper, such as forms and letterhead, verify that the ink on the paper is dry. During the fusing process, wet ink can come off preprinted paper, reducing print quality.

Loading paper

In the tray 1

Load the print media you use for the majority of your print jobs in the tray 1. The tray 1 can hold a maximum of 250 sheets of 75 g/m² plain paper.

You can purchase an optional tray (tray 2) and attach it below the standard tray to load an additional 250 sheets of paper. For order information for an optional tray, see page 12.1.

The paper level indicator on the front of the tray 1 and the optional tray 2 shows the amount of paper currently left in the tray. When the tray is empty, the indicator of the bar is completely lowered.

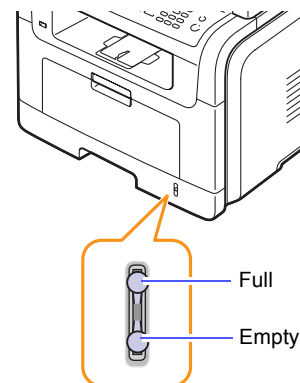

Loading paper in the tray 1 or optional tray 2

- 1 Pull open the paper tray and load paper.

You can load letterhead with the design side face down. The top edge of the sheet with the logo should be placed at the front of the tray.

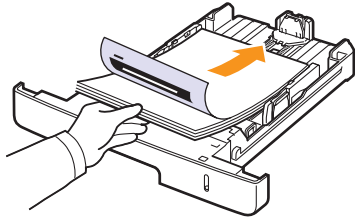

- 2 After loading paper, set the paper type and size for the multi-purpose tray. See page 5.8 for copying and faxing or the **Software Section** for PC-printing.



Notes

- If you experience problems with paper feed, place one sheet at a time in the multi-purpose tray.
- You can load previously printed paper. The printed side should be facing up with an uncurled edge at the front. If you experience problems with paper feed, turn the paper around. Note that print quality is not guaranteed.

Changing the size of the paper in the paper tray

To load longer sizes of paper, such as Legal-sized paper, you need to adjust the paper guides to extend the paper tray.

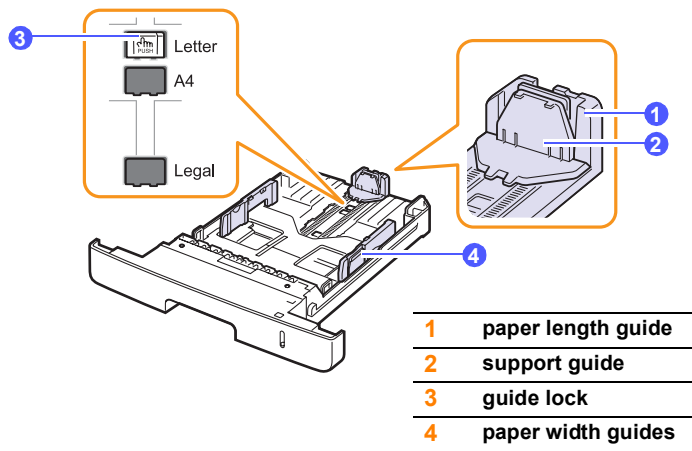

- 1 Press and hold the guide lock, and slide the paper length guide to locate it in the correct paper size slot.

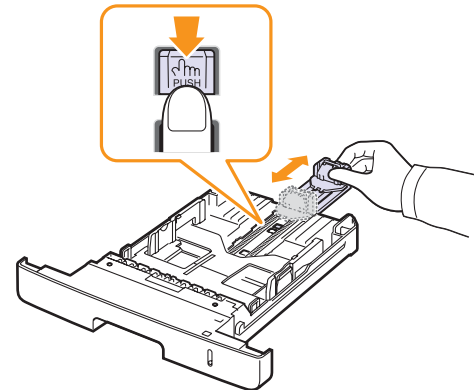

- 2 After inserting paper into the tray, adjust the support guide so that it lightly touches the paper stack.

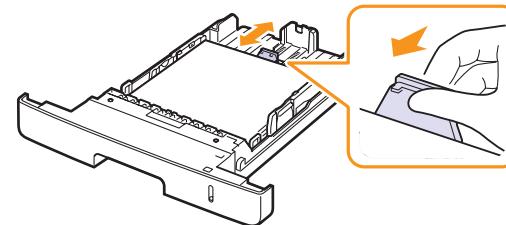

- 3 Squeeze the paper width guides, as shown and slide them to the stack of paper until it lightly touches the side of the stack.

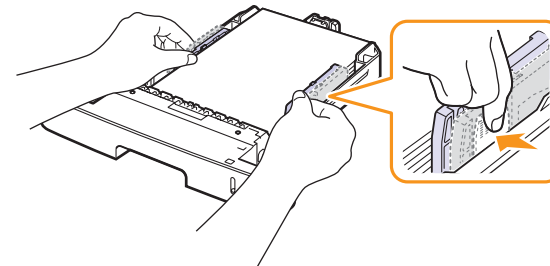

Notes

- Do not push the paper width guides far enough to cause the materials to warp.
- If you do not adjust the paper width guides, it may cause paper jams.

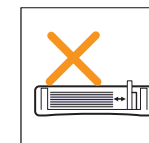
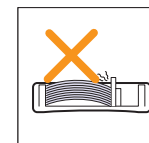
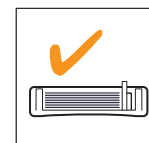

In the multi-purpose tray

The multi-purpose tray can hold special sizes and types of print material, such as transparencies, postcards, note cards, and envelopes. It is useful for single page printing on letterhead or colored paper.

To load paper in the multi-purpose tray:

- 1 Open the multi-purpose tray and unfold the multi-purpose tray extension, as shown.

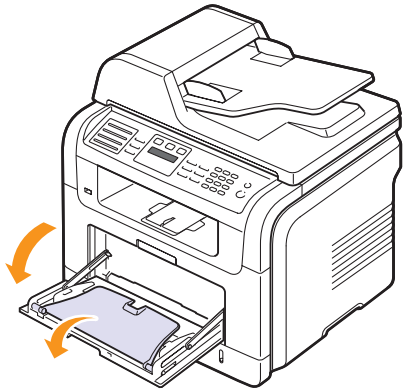

- 2 If you are using paper, flex or fan the edge of the paper stack to separate the pages before loading.



For transparencies, hold them by the edges and avoid touching the print side. Oils from your fingers can cause print quality problems.

- 3 Load the paper **with the side to be printed on facing up**.

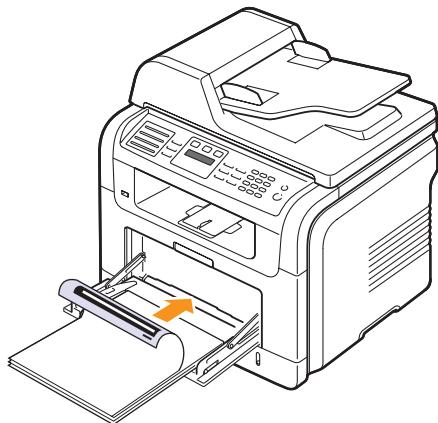

Notes

Depending on the media type you are using, keep the following loading guidelines:

- Envelopes: Flap side down and with the stamp area on the top left side.
 - Transparencies: Print side up and the top with the adhesive strip entering the machine first.
 - Labels: Print side up and top short edge entering the machine first.
 - Preprinted paper: Design side up with the top edge toward the machine.
 - Card stock: Print side up and the short edge entering the machine first.
 - Previously printed paper: Previously printed side down with an uncurled edge toward the machine.
- 4 Squeeze the multi-purpose tray paper width guides and adjust them to the width of the paper. Do not force too much, or the paper will be bent, which will result in a paper jam or skew.

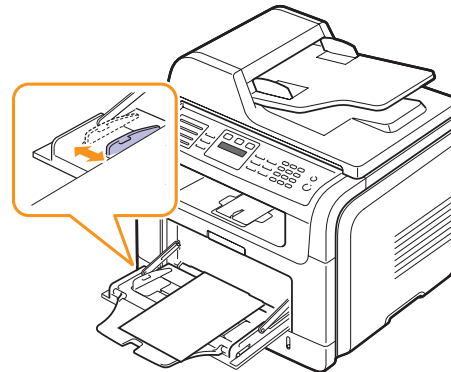

- 5 After loading paper, set the paper type and size for the multi-purpose tray. See page 5.8 for copying and faxing or the **Software Section** for PC-printing.



Note

The settings made from the printer driver override the settings on the control panel.



Caution

Make sure to open the rear cover when you print on transparencies. If not, they may tear while exiting the machine.

- 6 After printing, fold the multi-purpose tray extension and close the multi-purpose tray.

Tips on using the multi-purpose tray

- Load only one size of print media at a time in the multi-purpose tray.
- To prevent paper jams, do not add paper when there is still paper in the multi-purpose tray. This also applies to other types of print media.
- Print media should be loaded face up with the top edge going into the multi-purpose tray first and be placed in the center of the tray.
- Always load only the print media specified in page 5.2 to avoid paper jams and print quality problems.
- Flatten any curl on postcards, envelopes, and labels before loading them into the multi-purpose tray.
- Make sure to open the rear cover when you print on transparencies. If not, they may tear while exiting the machine.

Setting the paper size and type

After loading paper in the paper tray, you need to set the paper size and type using the control panel buttons. These settings will apply to Copy and Fax modes. For PC-printing, you need to select the paper size and type in the application program you use on your PC.

- 1 Press **Menu** until **System Setup** appears on the bottom line of the display and press **OK**.
- 2 Press the **Scroll** buttons until **Paper Setup** appears and press **OK**.
- 3 Press **OK** when **Paper Size** appears.
- 4 Press the **Scroll** buttons until the paper tray you want appears and press **OK**.
- 5 Press the **Scroll** buttons until the paper size you are using appears and press **OK**.
- 6 Press **Back** to return to the upper level.
- 7 Press the **Scroll** buttons until **Paper Type** appears and press **OK**.
- 8 Press the **Scroll** buttons until the paper type you are using appears and press **OK**.
- 9 Press **Stop/Clear** to return to Standby mode.

Selecting an output location

The machine has two output locations: the rear cover (face up) and the output tray (face down).

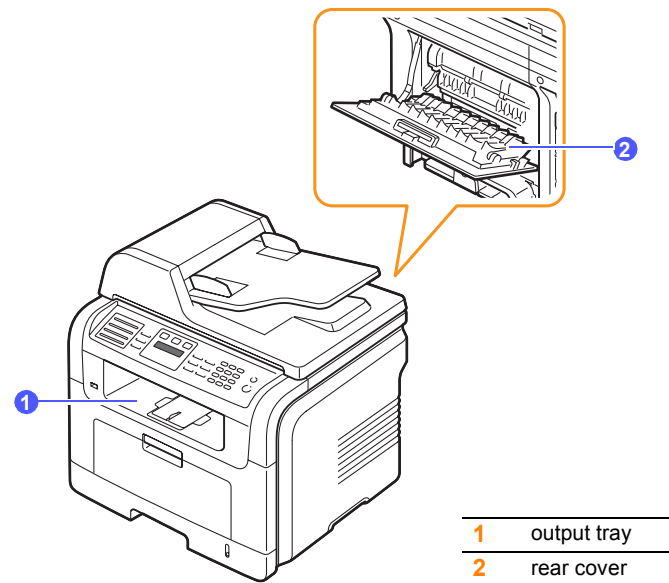

The printer sends output to the output tray by default. To use the output tray, make sure that the rear cover is closed.



Notes

- If paper coming out of the output tray has problems, such as excessive curl, try printing to the rear cover.
- To avoid paper jams, do not open or close the rear cover while the machine is printing.

Printing to the output tray

The output tray collects printed paper **face down**, in the order in which the sheets were printed. The tray should be used for most print jobs.

Printing to the rear cover

Using the rear cover, paper comes out of the machine **face up**.

Printing from the multi-purpose tray to the rear cover provides a straight paper path. Using the rear cover might improve the output quality with special print media.

To use the rear cover, open it by pulling down.

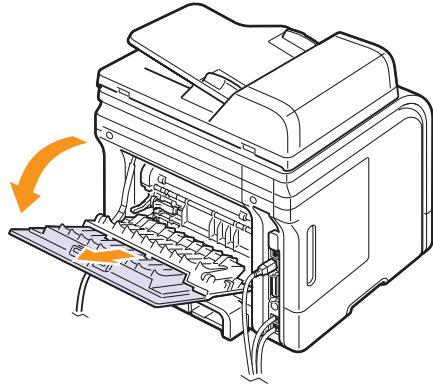

Caution

The fuser area inside the rear cover of your machine becomes very hot when in use. Take care when you access this area.

6 Copying

This chapter gives you step-by-step instructions for copying documents.

This chapter includes:

- **Selecting the paper tray**
- **Copying**
- **Changing the settings for each copy**
- **Changing the default copy settings**
- **Using special copy features**
- **Copying on both sides of paper (SCX-5530FN only)**
- **Setting copy timeout**

Selecting the paper tray

After loading the print media for copy output, you must select the paper tray you will use for copy jobs.

- 1 Press **Menu** until **System Setup** appears on the bottom line of the display and press **OK**.
- 2 Press the **Scroll** buttons until **Paper Setup** appears and press **OK**.
- 3 Press the **Scroll** buttons until **Paper Source** appears and press **OK**.
- 4 Press **OK** when **Copy Tray** appears.
- 5 Press the **Scroll** buttons until the paper tray you want appears and press **OK**.
- 6 Press **Stop/Clear** to return to Standby mode.

Copying

- 1 Press **Copy**.
Ready to Copy appears on the top line of the display.
- 2 Load originals face up into the ADF, or place a single original face down on the scanner glass.
For details about loading an original, see page 5.1.
- 3 Enter the number of copies using the number keypad, if necessary.
- 4 If you want to customize the copy settings including copy size, darkness, and original type, by using the **control panel** buttons, see page 6.1.
If necessary, you can use special copy features, such as poster copying, 2- or 4-up copying. See page 6.2.
- 5 Press **Start** to begin copying.



Note

You can cancel the copy job during an operation. Press **Stop/Clear**, and the copying will stop.

Changing the settings for each copy

Your machine provides default settings for copying so that you can quickly and easily make a copy. However, if you want to change the options for each copy, use the copy function buttons on the control panel.



Note

If you press **Stop/Clear** while setting the copy options, all of the options you have set for the current copy job will be canceled and returned to their default status. Or, they will automatically return to their default status after the machine completes the copy in progress.

Darkness

If you have an original containing faint markings and dark images, you can adjust the brightness to make a copy that is easier to read.

To adjust the darkness of copies, press **Darkness**. Each time you press the button, the following modes are available:

- **Normal**: Works well with standard typed or printed originals.
- **Light**: Works well with dark print.
- **Dark**: Works well with light print or faint pencil markings.

Original Type

The original type setting is used to improve the copy quality by selecting the document type for the current copy job.

To select the document type, press **Original Type**. Each time you press the button, the following modes are available:

- **Text**: Use for originals containing mostly text.
- **Text/Photo**: Use for originals with mixed text and photographs.
- **Photo**: Use when the originals are photographs.

Reduced or enlarged copy

By using the **Reduce/Enlarge** button, you can reduce or enlarge the size of a copied image from 25% to 400% when you copy original documents from the scanner glass, or from 25% to 100% from the ADF.

To select from the predefined copy sizes:

- 1 Press **Reduce/Enlarge**.
- 2 Press **Reduce/Enlarge** or the **Scroll** buttons until the size setting you want appears and press **OK**.

To scale the copy by directly entering the scale rate:

- 1 Press **Reduce/Enlarge**.
- 2 Press **Reduce/Enlarge** or the **Scroll** buttons until **Custom** appears and press **OK**.
- 3 Enter the scale rate and press **OK** to save the selection.



Note

When you make a reduced copy, black lines may appear at the bottom of your copy.

Changing the default copy settings

The copy options, including darkness, original type, copy size, and number of copies, can be set to those most frequently used. When you copy a document, the default settings are used unless they have been changed by using the corresponding buttons on the control panel.

- 1 Press **Copy**.
- 2 Press **Menu** until **Copy Setup** appears on the bottom line of the display and press **OK**.
- 3 Press **OK** when **Change Default** appears.
- 4 Press the **Scroll** buttons until the setup option you want appears and press **OK**.
- 5 Press the **Scroll** buttons until the setting you want appears and press **OK**.
- 6 Repeat steps 4 through 5, as needed.
- 7 Press **Stop/Clear** to return to Standby mode.



Note

While you are setting copy options, pressing **Stop/Clear** cancels the changed settings and restores the defaults.

Using special copy features

You can use the following copy features:

Collation

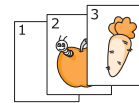
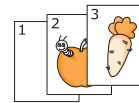

You can set the machine to sort the copy job. For example, if you make 2 copies of a 3 page original, one complete 3 page document will print followed by a second complete document.

- 1 Press **Copy**.
- 2 Load originals face up into the ADF.
For details about loading an original, see page 5.1.
- 3 Enter the number of copies using the number keypad.
- 4 Press **Menu** until **Copy Feature** appears on the bottom line of the display and press **OK**.
- 5 Press **OK** when **Copy Collation** appears.
- 6 Press the **Scroll** buttons to select **Yes**.
- 7 Press **OK** or **Start** to begin copying.

One complete document will print followed by the second complete document.

2-up or 4-up copying

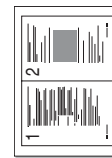

▲ 2-up copying



▲ 4-up copying

Your machine can print 2 or 4 original images reduced to fit onto one sheet of paper.

- 1 Press **Copy**.
- 2 Load originals face up in the ADF.
For details about loading an original, see page 5.1.
- 3 Press **Menu** until **Copy Feature** appears on the bottom line of the display and press **OK**.
- 4 Press the **Scroll** buttons until **2-Up** or **4-Up** appears and press **OK**.
- 5 Press the **Scroll** buttons to select **Yes**.
- 6 Press **OK** or **Start** to begin copying.



Note

You cannot adjust the copy size using the **Reduce/Enlarge** button for making a 2- or 4-up copy.

ID card copying

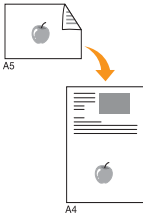

Your machine can print 2-sided originals on one sheet of A4-, Letter-, Legal-, Folio-, Executive-, B5-, A5-, or A6-sized paper.

When you copy using this feature, the machine prints one side of the original on the upper half of the paper and the other side on the lower half without reducing the size of the original. This feature is helpful for copying a small-sized item, such as a name card.

This copy feature is available only when you place originals on the scanner glass.

- 1 Press **Copy**.
- 2 Place a single original face down on the scanner glass.
For details about loading an original, see page 5.1.
- 3 Press **Menu** until **Copy Feature** appears on the bottom line of the display and press **OK**.
- 4 Press the **Scroll** buttons until **ID Copy** appears and press **OK**.

Place Front Side and Press[Start] appears on the display.

- 5 Press **OK** or **Start**.

Your machine begins scanning the front side and shows **Place Back Side and Press[Start]**.

- 6 Open the scanner lid and turn the original over.



Note

If you press **Stop/Clear** or if no buttons are pressed for approximately 30 seconds, the machine cancels the copy job and returns to Standby mode.

- 7 Press **Start** to begin copying.



Note

If the original is larger than the printable area, some portions may not be printed.

Poster copying

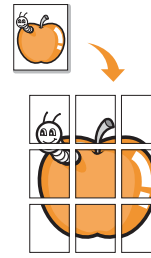

Your machine can print an image onto 9 sheets of paper (3x3). You can paste the printed pages together to make one poster-sized document.

This copy feature is available only when you place originals on the scanner glass.

- 1 Press **Copy**.
- 2 Place a single original face down on the scanner glass.
For details about loading an original, see page 5.1.
- 3 Press **Menu** until **Copy Feature** appears on the bottom line of the display and press **OK**.
- 4 Press the **Scroll** buttons until **Poster Copy** appears and press **OK**.
- 5 Press the **Scroll** buttons to select **Yes**.
- 6 Press **OK** or **Start** to begin copying.



Note

You cannot adjust the copy size using the **Reduce/Enlarge** button when making a poster.

Your original is divided into 9 portions. Each portion is scanned and printed one by one in the following order:

1	2	3
4	5	6
7	8	9

Clone copying

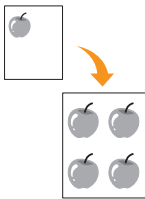

Your machine can print multiple image copies from the original document on a single page. The number of images is automatically determined by the original image and paper size.

This copy feature is available only when you place originals on the scanner glass.

- 1 Press **Copy**.
- 2 Place a single original face down on the scanner glass.

For details about loading an original, see page 5.1.
- 3 Press **Menu** until **Copy Feature** appears on the bottom line of the display and press **OK**.
- 4 Press the **Scroll** buttons until **Clone Copy** appears and press **OK**.
- 5 Press the **Scroll** buttons to select **Yes**.
- 6 Press **OK** or **Start** to begin copying.



Note

You cannot adjust the copy size using the **Reduce/Enlarge** button while making a clone copy.

Erasing background images

You can set the machine to print an image without its background. This copy feature removes the background color and can be helpful when copying an original containing color in the background, such as a newspaper or a catalog.

- 1 Press **Copy**.
- 2 Load originals face up into the ADF, or place a single original face down on the scanner glass.

For details about loading an original, see page 5.1.
- 3 Press **Menu** until **Copy Feature** appears on the bottom line of the display and press **OK**.
- 4 Press the **Scroll** buttons until **Erase Bkgd.** appears and press **OK**.
- 5 Press the **Scroll** buttons to select **On** and press **OK**.
- 6 Press **Stop/Clear** to return to Standby mode.
- 7 Enter the number of copies using the number keypad.
- 8 Press **Start** to begin copying.

Copying on both sides of paper (SCX-5530FN only)

By using the **Duplex** button on your machine, you can set the machine to print copies on both sides of paper.

- 1 Press **Duplex**.
- 2 Press the **Scroll** buttons until the binding option you want appears.
 - **Off**: Prints in Normal mode.
 - **1->2Side Short**: Prints pages to be read by flipping like a note pad.
 - **1->2Side Long**: Prints pages to be read like a book.

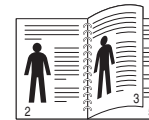

▲ 1->2Side Long

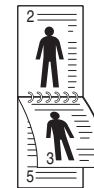

▲ 1->2Side Short

- 3 Press **OK** to save your selection.

If the mode is enabled, the **Duplex** button is backlit.
- 4 Start copying a document.

Setting copy timeout

You can set the time the machine waits before it restores the default copy settings, if you do not start copying after changing them on the control panel.

- 1 Press **Menu** until **System Setup** appears on the bottom line of the display and press **OK**.
- 2 Press **OK** when **Machine Setup** appears.
- 3 Press the **Scroll** buttons until **Timeout** appears and press **OK**.
- 4 Press the **Scroll** buttons until the time setting you want appears.

Selecting **Off** means that the machine does not restore the default settings until you press **Start** to begin copying, or **Stop/Clear** to cancel.
- 5 Press **OK** to save your selection.
- 6 Press **Stop/Clear** to return to Standby mode.

7 Basic printing

This chapter explains common printing tasks.

Printing a document

Your machine allows you to print from various Windows, Macintosh¹, or Linux applications. The exact steps for printing a document may vary depending on the application you use.

For details about printing, see the **Software Section**.

Canceling a print job

If the print job is waiting in a print queue or print spooler, such as the printer group in Windows, delete the job as follows:

- 1 Click the Windows **Start** menu.
- 2 For Windows 98/NT 4.0/2000/Me, select **Settings** and then **Printers**.
For Windows XP/2003, select **Printers and Faxes**.
- 3 Double-click the **Samsung SCX-5x30 Series** icon.
- 4 From the **Document** menu, select **Cancel Printing** (Windows 98/Me) or **Cancel** (Windows NT 4.0/2000/XP/2003).



Note

You can also access this window by simply double-clicking the printer icon at the bottom right corner of the Windows desktop.

You can also cancel the current job by pressing **Stop/Clear** on the control panel.

¹.SCX-5530FN only

8 Scanning

Scanning with your machine lets you turn pictures and text into digital files that can be stored on your computer. Then you can fax or email the files, upload them to your website, or use them to create projects that you can print.

This chapter includes:

- **Scanning basics**
- **Scanning to an application using a local connection**
- **Scanning using a network connection**
- **Changing the settings for each scan job**
- **Changing the default scan settings**
- **Setting up Address Book**

Scanning basics

Your machine offers the following ways to scan an image using a local connection:

- Via one of the preset imaging applications. Scanning an image launches the selected application, enabling you to control the scanning process. See the next section.
- Via the **SmarThru™** program supplied with your machine. Scanning an image launches **SmarThru™** and enables you to control the scanning process.
- Via the Windows Images Acquisition (WIA) driver. See the **Software Section**.
- To a portable USB memory device, if inserted into the USB memory port on your machine. See page 11.1.

Also, you can send scanned images to several destinations using a network connection:

- To your networked computer via the **Network Scan** program. You can scan an image from the machine, if network-connected, to the computer where the **Network Scan** program is running.
- To Email. You can send the scanned image as an attachment to an email. See page 8.4.
- To an FTP file server: You can scan an image and upload it to an FTP server. See page 8.4.
- To a computer networked via SMB (NetBEUI)^a protocol: You can scan an image and send it to a shared folder on an SMB server. See page 8.5.

a. A network protocol provided by Microsoft Corporation for Windows network systems.

Scanning to an application using a local connection

- 1 Make sure that your machine and computer are turned on and properly connected to each other.
- 2 Load originals face up into the ADF, or place a single original face down on the scanner glass.
For details about loading an original, see page 5.1.
- 3 Press **Scan/Email**.
Ready to Scan appears on the top line of the display.
- 4 Press the **Scroll** buttons until **Scan to Appl.** appears on the bottom line of the display and press **OK**.
- 5 Press the **Scroll** buttons until the application you want to use appears and press **OK**.
 - **Microsoft Paint:** Sends the scanned image to Microsoft Paint.
 - **Email:** Sends the scanned image to your default email program on your computer. A new message window opens with the image attached.
 - **My Document:** Saves the scanned image in the default folder, **My Documents**, on your computer.
 - **SmarThru:** Sends the scanned image to **SmarThru™**, installed with the printer driver.
 - **OCR:** Sends the scanned image to the OCR program for text recognition.
- 6 On the selected application, adjust the scan settings and begin scanning. For details, please refer to the application user's guide.



Note

You can add more TWAIN-compliant software for scanning, such as Adobe Photoshop Deluxe, or Adobe Photoshop, from the **Printer Settings Utility**. See the **Software Section**.

Scanning using a network connection

If you have connected your machine to a network and set up network parameters correctly, you can scan and send images over the network.

Preparing for network scanning

Before using your machine's network scanning features, you need to configure the following settings depending on your scan destination:

- Adding the machine to the Network Scan program for scanning to a network client
- Registering as an authorized user for scanning to Email, FTP, or SMB
- Setting up an account for scanning to Email
- Setting up FTP servers for scanning to FTP
- Setting up SMB servers for scanning to SMB

Adding the machine to the Network Scan program

First, install the **Network Scan** program. See the **Software Section**.

To scan images from your machine to your computer through the network, you need to register the machine as an authorized network scanner in the **Network Scan** program.

- 1 In Windows, select **Start** → **Programs** → **Samsung Network Printer Utilities** → **Network Scan** → **Network Scan**.
The **Samsung Network Scan Manager** window opens.
- 2 Click the **Add Device** button or double-click the **Add Device** icon.
- 3 Click **Next**.
- 4 Select **Browse for a scanner. (recommended)**, or select **Connect to this scanner.** and enter the IP address of your machine.
- 5 Click **Next**.
A list of the scanners on your network appears.
- 6 Select your machine from the list and enter a name, user ID, and PIN (Personal Identification Number) for the machine.



Notes

- For the scanner name, the model name of your machine is automatically entered, but can be changed.
- You can enter an ID of up to 8 characters. The first character must be a letter.
- The PIN must be 4 digits.

- 7 Click **Next**.
- 8 Click **Finish**.

Your machine is added to the **Network Scan** program and you can now scan images through the network.



Note

You can change the scanner properties of your machine and the scan settings from the **Samsung Network Scan Manager** window. Click **Properties** and set the options in each tab.

Registering authorized users

To use an FTP server or SMB server, or to send an email, you need to register authorized users using SyncThru™ Web Service. You can add up to 50 users.

- 1 Enter your machine's IP address as the URL in a browser and click **Go** to access the web site of your machine.
- 2 Click **Machine Settings** and **User Authentication**.
- 3 Click **Add**.
- 4 Select the index number where the corresponding entry will be stored, from 1 to 50.
- 5 Enter your name, user ID, password, and e-mail address.
You need to enter the registered user ID and password in the machine when you start scanning to FTP, SMB or e-mail from the control panel.
- 6 Click **Apply**.

Setting up an e-mail account

To scan and send an image as an email attachment, you need to set up network parameters using SyncThru™ Web Service.

- 1 Enter your machine's IP address as the URL in a browser and click **Go** to access the web site of your machine.
- 2 Click **Machine Settings** and **E-mail Setup**.
- 3 Select **IP Address** or **Host Name**.
- 4 Enter the IP address in dotted decimal notation or as a host name.
- 5 Enter the server port number, from 1 to 65535.
The default port number is 25.
- 6 Put a check mark in **SMTP Requires Authentication** to require authentication.
- 7 Enter the SMTP server login name and password.

Setting up an FTP server

To use an FTP server, you need to set up parameters for access to FTP servers using SyncThru™ Web Service.

- 1 Enter your machine's IP address as the URL in a browser and click **Go** to access the web site of your machine.
- 2 Click **Machine Settings** and **FTP Setup**.
- 3 Click **Server List**.

- 4 Click **Add**.
- 5 Select the index number, from 1 to 20.
- 6 Enter a name in **Alias for the Setup** for the corresponding Server List entry. This name will be displayed on your machine.
- 7 Select **IP Address** or **Host Name**.
- 8 Enter the server address in dotted decimal notation or as a host name.
- 9 Enter the server port number, from 1 to 65535.
The default port number is 21.
- 10 Put a check mark in **Anonymous** if you want to allow the FTP server to be accessed by unauthorized persons.
By default, this is unchecked.
- 11 Enter the login name and password.
- 12 Enter the location the scanned image will be stored. This is the location you have entered in the step 6.
- 13 Click **Apply**.

Setting up an SMB server

To use an SMB server, you need to set up parameters for access to SMB servers using SyncThru™ Web Service.

- 1 Enter your machine's IP address as the URL in a browser and click **Go** to access the web site of your machine.
- 2 Click **Machine Settings** and **SMB Setup**.
- 3 Click **Server List**.
- 4 Click **Add**.
- 5 Select the index number, from 1 to 20.
- 6 Enter a name in **Alias for the Setup** for the corresponding Server List entry. This name will be displayed on your machine.
- 7 Select **IP Address** or **Host Name**.
- 8 Enter the server address in dotted decimal notation or as a host name.
- 9 Enter the server port number, from 1 to 65535.
The default port number is 139.
- 10 Enter the share name of the server.
- 11 Put a check mark in **Anonymous** if you want to allow the SMB server to be accessed by unauthorized persons.
By default, this is unchecked.
- 12 Enter the login name and password.

- 13 Enter the domain name of the SMB server.
- 14 Enter the location the scanned image will be stored. This is the location you have entered in the step 6.
- 15 Click **Apply**.

Scanning to a network client

Network client allows you to remotely scan an original from your network-connected machine to your computer in JPEG, TIFF, or PDF file format.

Scanning

- 1 Make sure that your machine and the computer are connected to a network and **Network Scan** is running on the computer.
- 2 Load originals face up into the ADF, or place a single original face down on the scanner glass.
For details about loading an original, see page 5.1.
- 3 Press **Scan/Email**.
- 4 Press the **Scroll** buttons until **NetScan** appears on the bottom line of the display and press **OK**.
- 5 Enter the ID you have set in the **Samsung Network Scan Manager** window and press **OK**.
- 6 Enter the PIN you have set in the **Samsung Network Scan Manager** window and press **OK**.
- 7 If the scan destination is folder type, press the **Scroll** buttons until the scan setting option you want appears and press **OK**. Or, press **Start** to immediately start scanning using the default settings.
 - **Scan Size**: Sets the image size.
 - **Original Type**: Sets the original document's type.
 - **Resolution**: Sets the image resolution.
 - **Scan Color**: Sets the color mode.
 - **Scan Format**: Sets the file format in which the image is to be saved. If you select TIFF or PDF, you can select to scan multiple pages.

If the scan destination is application type, go to the step 11.
- 8 Press the **Scroll** buttons until the desired status appears and press **OK**.
- 9 Press **Start** to start scanning.
Your machine begins scanning the original to the computer where the program is running.
- 10 Press the **Scroll** buttons until the application you want appears and press **OK**. Scanning is started.

Setting network scan timeout

If the **Network Scan** program on your computer does not send a refresh request and does not scan a job within a specified timeout period, your machine cancels the scan job. You can change this timeout setting as needed.

- 1 Press **Menu** until **System Setup** appears on the bottom line of the display and press **OK**.
- 2 Press **OK** when **Machine Setup** appears.
- 3 Press the **Scroll** buttons until **NetScanTimeout** appears and press **OK**.
- 4 Enter the desired timeout value and press **OK**.
The change will be broadcast over the network and will apply to all clients connected to the network.
- 5 Press **Stop/Clear** to return to Standby mode.

Scanning to Email

You can scan and send an image as an email attachment. You first need to set up your email account in **SyncThru™ Web Service**. See page 8.2.

Before scanning, you can set the scan options for your scan job. See page 8.5.

- 1 Make sure that your machine is connected to a network.
- 2 Load originals face up into the ADF, or place a single original face down on the scanner glass.
For details about loading an original, see page 5.1.
- 3 Press **Scan/Email**.
- 4 Press the **Scroll** buttons until **Scan to Email** appears on the bottom line of the display and press **OK**.
- 5 Enter the recipient's email address and press **OK**.
If you have set up **Address Book**, you can use a speed button or a speed email or group email number to retrieve an address from memory. See page 8.5.
- 6 To enter additional addresses, press **OK** when **Yes** appears and repeat step 5.
To continue to the next step, press the **Scroll** buttons to select **No** and press **OK**.
- 7 If the display asks if you want to send the email to your account, press the **Scroll** buttons to select **Yes** or **No** and press **OK**.



Note

This prompt does not appear if you have activated the **Send To Self** option in the email account setup.

- 8 Enter an email subject and press **OK**.

- 9 Press the **Scroll** buttons until the file format you want appears and press **OK** or **Start**.

The machine begins scanning and then sends the email.

- 10 If the machine asks if you want to log off your account, press the **Scroll** buttons to select **Yes** or **No** and press **OK**.
- 11 Press **Stop/Clear** to return to Standby mode.

Scanning to an FTP server

You can scan an image and then upload it to an FTP server. You need to set up parameters for access to FTP servers from **SyncThru™ Web Service**. See page 8.2.

Before scanning, you can set the scan options for your scan job. See page 8.5.

- 1 Make sure that your machine is connected to a network.
- 2 Load originals face up into the ADF or place a single original on the scanner glass.
For details about loading an original, see page 5.1.
- 3 Press **Scan/Email**.
- 4 Press the **Scroll** buttons until **Scan to FTP** appears on the bottom line of the display and press **OK**.
- 5 Enter the user ID and press **OK**.
- 6 Enter the password and press **OK**.
- 7 Press the **Scroll** buttons until the FTP server you want appears and press **OK** or **Start**.
- 8 Press the **Scroll** buttons until the file type you want appears and press **OK** or **Start**.
The machine begins scanning and then sends the file to the specified server.

Scanning to an SMB server

You can scan an image and then send it to an SMB server. You need to set up parameters for access to SMB servers from **SyncThru™ Web Service**. See page 8.3.

Before scanning, you can set the scan options for your scan job. See page 8.5.

- 1 Make sure that your machine is connected to a network.
- 2 Load originals face up into the ADF or place a single original on the scanner glass.
For details about loading an original, see page 5.1.
- 3 Press **Scan/Email**.
- 4 Press the **Scroll** buttons until **Scan to SMB** appears on the bottom line of the display and press **OK**.
- 5 Enter the user ID and press **OK**.
- 6 Enter the password and press **OK**.
- 7 Press the **Scroll** buttons until the SMB server you want appears and press **OK** or **Start**.
- 8 Press the **Scroll** buttons until the file format you want appears and press **OK** or **Start**.

The machine begins scanning and then sends the file to the specified server.

Changing the settings for each scan job

Your machine provides you with the following setting options to allow you to customize your scan jobs.

- **Scan Size:** Sets the image size.
- **Original Type:** Sets the original document's type.
- **Resolution:** Sets the image resolution.
- **Scan Color:** Sets the color mode.
- **Scan Format:** Sets the file format in which the image is to be saved. If you select TIFF or PDF, you can select to scan multiple pages. Depending on the selected scan type, this option may not appear.

To customize the settings before starting a scan job:

- 1 Press **Scan/Email**.
- 2 Press **Menu** until **Scan Feature** appears on the bottom line of the display and press **OK**.
- 3 Press the **Scroll** buttons until the scan type you want appears and press **OK**.
- 4 Press the **Scroll** buttons until the scan setting option you want appears and press **OK**.

- 5 Press the **Scroll** buttons until the desired status appears and press **OK**.
- 6 Repeat steps 4 and 5 to set other setting options.
- 7 When you have finished, press **Stop/Clear** to return to Standby mode.

Changing the default scan settings

To avoid having to customize the scan settings for each job, you can set up default scan settings for each scan type.

- 1 Press **Scan/Email**.
- 2 Press **Menu** until **Scan Setup** appears on the bottom line of the display and press **OK**.
- 3 Press **OK** when **Change Default** appears.
- 4 Press the **Scroll** buttons until the scan type you want appears and press **OK**.
- 5 Press the **Scroll** buttons until the scan setting option you want appears and press **OK**.
- 6 Press the **Scroll** buttons until the desired status appears and press **OK**.
- 7 Repeat steps 5 and 6 to change other settings.
- 8 To change the default settings for other scan types, press **Back** and repeat from step 4.
- 9 Press **Stop/Clear** to return to Standby mode.

Setting up Address Book

You can set up **Address Book** with the email addresses you use frequently via **SyncThru™ Web Service** and then easily and quickly enter email addresses by entering the location numbers assigned to them in **Address book**.

Registering speed email numbers

- 1 Enter your machine's IP address as the URL in a browser and click **Go** to access the web site of your machine.
- 2 Click **Machine Settings** and **Local Address Book**.
- 3 Click **Add**.
- 4 Select a location number and enter the user name and e-mail address you want.
- 5 Click **Apply**.



Note

You can also click **Import** and obtain your address book from your computer.

Configuring group email numbers

- 1 Enter your machine's IP address as the URL in a browser and click **Go** to access the web site of your machine.
- 2 Click **Machine Settings** and **Group Address Book**.
- 3 Click **Add**.
- 4 Select a group number and enter the group name you want.
- 5 Select speed email numbers that will be included in the group.
- 6 Click **Apply**.

Retrieving global email addresses from the LDAP^a server

You can use not only local addresses stored in your machine's memory but also ones in the LDAP server. To use the global addresses, configure the LDAP server first via **SyncThru™ Web Service** as following:

- 1 Enter your machine's IP address as the URL in a browser and click **Go** to access the web site of your machine.
- 2 Click **Machine Settings** and **LDAP Server Setup**.
- 3 Select **IP Address** or **Host Name**.
- 4 Enter the IP address in dotted decimal notation or as a host name.
- 5 Enter the server port number, from 1 to 65535.
The default port number is 389.
- 6 Click **Add**.

Using Address Book entries

To retrieve an email address, use the following ways:

Speed email numbers

When you are prompted to enter a destination address while sending an email, enter the speed email number at which you stored the address you want.

- For a one-digit speed email location, press and hold the corresponding digit button from the number keypad.
- For a two- or three-digit speed email location, press the first digit button(s) and then hold down the last digit button.

If you are an SCX-5530FN user, you can also press the speed buttons at which you stored the address you want.

You can also search through memory for an entry by pressing **Address Book**. See page 8.7.

Group email numbers

To use a group email entry, you need to search for and select it from memory.

When you are prompted to enter a destination address while sending an email, press **Address Book**. See page 8.7.

Global email addresses

To use a global email addresses in the LDAP server, you need to search for and select it from memory.

When you are prompted to enter a destination address while sending an email, press **Address Book**. See page 8.7.

a. LightWeight Directory Access Protocol: An Internet protocol that email and other programs use to look up information from a server.

Searching Address Book for an entry

There are two ways to search for an address in memory. You can either scan from A to Z sequentially or search by entering the first letters of the name associated with the address.

Searching sequentially through memory

- 1 If necessary, press **Scan/Email**.
- 2 Press **Address Book** until **Search&Send** appears on the bottom line of the display and press **OK**.
- 3 Press the **Scroll** buttons until the number category you want appears and press **OK**.
- 4 Press **OK** when **All** appears.
- 5 Press the **Scroll** buttons until the name and address you want appears. You can search upwards or downwards through the entire memory in alphabetical order.

Searching with a particular first letter

- 1 If necessary press **Scan/Email**.
- 2 Press **Address Book** until **Search&Send** appears on the bottom line of the display and press **OK**.
- 3 Press the **Scroll** buttons until the number category you want appears and press **OK**.
- 4 Press the **Scroll** buttons until **ID** appears and press **OK**.
- 5 Enter the first few letters of the name you want and press **OK**.
- 6 Press the **Scroll** buttons until the name you want appears and press **OK**.

Printing Address Book

You can check your **Address Book** settings by printing a list.

- 1 Press **Address Book** until **Print** appears on the bottom line of the display.
- 2 Press **OK**. A list showing your speed button settings, and the speed/group email entries print out.

9 Faxing (SCX-5530FN only)

The fax feature is available only on the SCX-5530FN. This chapter gives you information about using your machine as a fax machine.

This chapter includes:

Sending a fax

- **Setting the fax header**
- **Adjusting the document settings**
- **Sending a fax automatically**
- **Sending a fax manually**
- **Confirming a transmission**
- **Automatic redialing**
- **Redialing the last number**

Receiving a fax

- **Selecting the paper tray**
- **Changing receiving modes**
- **Receiving automatically in Fax mode**
- **Receiving manually in Tel mode**
- **Receiving automatically in Ans/Fax mode**
- **Receiving manually using an extension telephone**
- **Receiving faxes using DRPD mode**
- **Receiving in secure receiving mode**
- **Receiving faxes in memory**
- **Printing received faxes on both sides of paper**

Other ways to fax

- **Sending a fax to multiple destinations**
- **Sending a delayed fax**
- **Sending a priority fax**
- **Forwarding faxes**

Sending a fax

Setting the fax header

In some countries, you are required by law to indicate your fax number on any fax you send. The Machine ID, containing your telephone number and name or company name, will be printed at the top of each page sent from your machine.

- 1 Press **Menu** until **System Setup** appears on the bottom line of the display and press **OK**.
- 2 Press **OK** when **Machine Setup** appears.
- 3 Press **OK** when **Machine ID** appears.
- 4 Enter your name or the company name using the number keypad.
You can enter alphanumeric characters using the number keypad, and include special symbols by pressing the **0** button.
For details on how to enter alphanumeric characters, see page 2.3.
- 5 Press **OK** to save the ID.
- 6 Press the **Scroll** buttons until **Machine Fax No.** appears and press **OK**.
- 7 Enter your fax number using the number keypad and press **OK**.
- 8 Press **Stop/Clear** to return to Standby mode.

Adjusting the document settings

Before starting a fax, change the following settings according to your original's status to get the best quality.

Resolution

The default document settings produce good results when using typical text-based originals. However, if you send originals that are of poor quality, or contain photographs, you can adjust the resolution to produce a higher quality Fax.

- 1 Press **Resolution**.
- 2 Press **Resolution** or the **Scroll** buttons until the option you want appears.
- 3 Press **OK** to save your selection.

Recommended resolution settings for different original document types are described in the table below:

Mode	Recommended for:
Standard	Originals with normal sized characters.
Fine	Originals containing small characters or thin lines or originals printed using a dot-matrix printer.
Super Fine	<p>Originals containing extremely fine detail. Super Fine mode is enabled only if the machine with which you are communicating also supports the Super Fine resolution.</p> <p> Notes</p> <ul style="list-style-type: none"> • For memory transmission, Super Fine mode is not available. The resolution setting is automatically changed to Fine. • When your machine is set to Super Fine resolution and the fax machine with which you are communicating does not support Super Fine resolution, the machine transmits using the highest resolution mode supported by the other fax machine.
Photo Fax	Originals containing shades of gray or photographs.
Color Fax	Originals with colors. Sending a color fax is enabled only if the machine with which you are communicating supports color fax reception and you send the fax manually. In this mode, memory transmission is not available.



Note

The resolution setting is applied to the current fax job. To change the default setting, see page 10.2.

Darkness

You can select the default contrast mode to fax your originals lighter or darker.

- 1 Press **Fax**.
- 2 Press **Menu**, and then **OK** when **Fax Feature** appears on the bottom line of the display.
- 3 Press **OK** when **Darkness** appears.
- 4 Press the **Scroll** buttons until the option you want appears and press **OK**.
- 5 Press **Stop/Clear** to return to Standby mode.



Note

The darkness setting is applied to the current fax job. To change the default setting, see page 10.2.

Sending a fax automatically

- 1 Press **Fax**.
- 2 Load originals face up into the ADF, or place a single original face down on the scanner glass.
For details about loading an original, see page 5.1.
Ready to Fax appears on the top line of the display.
- 3 Adjust the resolution and the darkness to suit your fax needs.
- 4 Enter the receiving fax machine's number.
You can use speed buttons, speed dial numbers, or group dial numbers. For details about storing and searching for a number, see page 10.2.
- 5 Press **Start**.
- 6 If an original is placed on the scanner glass, select **Yes** to add another page. Load another original and press **OK**.
- 7 When you have finished, select **No** at the **Another Page?** prompt.
After the number is dialed, the machine begins sending the fax when the receiving fax machine answers.



Note

When you want to cancel a fax job, press **Stop/Clear** at any time while sending.

Sending a fax manually

- 1 Press **Fax**.
- 2 Load originals face up into the ADF, or place a single original face down on the scanner glass.
For details about loading an original, see page 5.1.
- 3 Adjust the resolution and the darkness to suit your fax needs. See page 9.1.
- 4 Press **On Hook Dial**. You hear a dial tone.
- 5 Enter the receiving fax machine's number.
You can use speed buttons, speed dial numbers, or group dial numbers. For details about storing and searching for a number, see page 10.2.
- 6 Press **Start** when you hear a high-pitched fax signal from the remote fax machine.



Note

When you want to cancel a fax job, press **Stop/Clear** at any time while sending.

Confirming a transmission

When the last page of your original has been sent successfully, the machine beeps and returns to Standby mode.

When something goes wrong while sending your fax, an error message appears on the display. For a list of error messages and their meanings, see page 14.7. If you receive an error message, press **Stop/Clear** to clear the message and try to send the fax again.

You can set your machine to print a confirmation report automatically each time sending a fax is completed. For further details, see page 10.1.

Automatic redialing

When the number you have dialed is busy or there is no answer when you send a fax, the machine automatically redials the number every three minutes, up to seven times according to the factory default settings.

When the display shows **Retry Redial?**, press **OK** to redial the number without waiting. To cancel the automatic redialing, press **Stop/Clear**.

To change the time interval between redials and the number of redial attempts. See page 10.1.

Redialing the last number

To redial the number you called last:

- 1 Press **Redial/Pause**.
- 2 When an original is loaded in the ADF, the machine automatically begins to send.

If an original is placed on the scanner glass, select **Yes** to add another page. Load another original and press **OK**. When you have finished, select **No** at the **Another Page?** prompt.

Receiving a fax

Selecting the paper tray

After loading the print media for fax output, you have to select the paper tray you will use for the fax reception.

- 1 Press **Menu** until **System Setup** appears on the bottom line of the display and press **OK**.
- 2 Press the **Scroll** buttons until **Paper Setup** appears and press **OK**.
- 3 Press the **Scroll** buttons until **Paper Source** appears and press **OK**.
- 4 Press the **Scroll** buttons until **Fax Tray** appears and press **OK**.
- 5 Press the **Scroll** buttons until the paper tray you want appears and press **OK**.
- 6 Press **Stop/Clear** to return to Standby mode.

Changing receiving modes

- 1 Press **Fax**.
- 2 Press **Menu** until **Fax Setup** appears on the bottom line of the display and press **OK**.
- 3 Press the **Scroll** buttons until **Receiving** appears and press **OK**.
- 4 Press **OK** when **Receive Mode** appears.
- 5 Press the **Scroll** buttons until the fax reception mode you want appears.
 - In **Fax** mode, the machine answers an incoming fax call and immediately goes into the fax reception mode.
 - In **Tel** mode, you can receive a fax by pressing **On Hook Dial** and then **Start**. You can also pick up the handset of the extension phone and then press the remote receive code. See page 9.4.
 - In **Ans/Fax** mode, an answering machine attached to your machine answers an incoming call, and the caller can leave a message on the answering machine. If the fax machine senses a fax tone on the line, the machine automatically switches to **Fax** mode to receive the fax. See page 9.4.
 - In **DRPD** mode, you can receive a call using the Distinctive Ring Pattern Detection (DRPD) feature. Distinctive Ring is a telephone company service which enables an user to use a single telephone line to answer several different telephone numbers. For further details, see page 9.4.
- 6 Press **OK** to save your selection.

7 Press **Stop/Clear** to return to Standby mode.



Notes

- When the memory is full, the printer can no longer receive any incoming fax. Secure free memory to resume by removing data stored in the memory.
- To use the **Ans/Fax** mode, attach an answering machine to the EXT socket on the back of your machine.
- If you do not want other people to view your received documents, you can use secure receiving mode. In this mode, all of the received faxes are stored in memory. For further details, see page 9.5.

Receiving automatically in Fax mode

Your machine is preset to **Fax** mode at the factory. When you receive a fax, the machine answers the call on a specified number of rings and automatically receives the fax.

To change the number of rings, see page 10.1.

Receiving manually in Tel mode

You can receive a fax call by pressing **On Hook Dial** and then pressing **Start** when you hear a fax tone from the remote machine.

The machine begins receiving a fax and returns to Standby mode when the reception is completed.

Receiving manually using an extension telephone

This feature works best when you are using an extension telephone connected to the EXT socket on the back of your machine. You can receive a fax from someone you are talking to on the extension telephone without going to the fax machine.

When you receive a call on the extension phone and hear fax tones, press the keys ***9*** on the extension phone. The machine receives the fax.

Press the buttons slowly in sequence. If you still hear the fax tone from the remote machine, try pressing ***9*** once again.

9 is the remote receive code preset at the factory. The first and the last asterisks are fixed, but you can change the middle number to whatever you wish. For details about changing the code, see page 10.1.

Receiving automatically in Ans/Fax mode

To use this mode, you must attach an answering machine to the EXT socket on the back of your machine.

If the caller leaves a message, the answering machine stores the message as it would normally. If your machine detects a fax tone on the line, it automatically starts to receive the fax.



Notes

- If you have set your machine to **Ans/Fax** mode and your answering machine is switched off, or no answering machine is connected to EXT socket, your machine automatically goes into **Fax** mode after a predefined number of rings.
- If your answering machine has a user-selectable ring counter, set the machine to answer incoming calls within 1 ring.
- If you are in **Tel** mode (manual reception) when the answering machine is connected to your machine, you must switch off the answering machine, or the outgoing message from the answering machine will interrupt your phone conversation.

Receiving faxes using DRPD mode

Distinctive Ring is a telephone company service which enables an user to use a single telephone line to answer several different telephone numbers. The particular number someone uses to call you is identified by different ringing patterns, which consist of various combinations of long and short ringing sounds. This feature is often used by answering services who answer telephones for many different clients and need to know which number someone is calling in on to properly answer the phone.

Using the Distinctive Ring Pattern Detection (DRPD) feature, your fax machine can learn the ring pattern you designate to be answered by the fax machine. Unless you change it, this ringing pattern will continue to be recognized and answered as a fax call, and all other ringing patterns will be forwarded to the extension telephone or answering machine plugged into the EXT socket. You can easily suspend or change DRPD at any time.

Before using the DRPD option, Distinctive Ring service must be installed on your telephone line by the telephone company. To set up DRPD, you will need another telephone line at your location, or someone available to dial your fax number from outside.

To set up the **DRPD** mode:

- 1 Press **Fax**.
- 2 Press **Menu** until **Fax Setup** appears on the bottom line of the display and press **OK**.
- 3 Press the **Scroll** buttons until **Receiving** appears and press **OK**.
- 4 Press the **Scroll** buttons until **DRPD Mode** appears and press **OK**.
Waiting Ring appears on the display.

- 5 Call your fax number from another telephone. It is not necessary to place the call from a fax machine.
- 6 When your machine begins to ring, do not answer the call. The machine requires several rings to learn the pattern.

When the machine completes learning, the display shows **Completed DRPD Setup**.

If the DRPD setup fails, **Error DRPD Ring** appears. Press **OK** when **DRPD Mode** appears and start over from step 4.

- 7 Press **Stop/Clear** to return to Standby mode.

When the DRPD feature is set up, the **DRPD** option is available for the receiving mode setting. To receive faxes in DRPD mode, you need to set the menu to **DRPD**.



Notes

- DRPD must be set up again if you re-assign your fax number, or connect the machine to another telephone line.
- After DRPD has been set up, call your fax number again to verify that the machine answers with a fax tone. Then have a call placed to a different number assigned to that same line to be sure the call is forwarded to the extension telephone or answering machine plugged into the EXT socket.

Receiving in secure receiving mode

You may need to prevent your received faxes from being accessed by unauthorized people. You can turn on secure receiving mode to restrict printing of received faxes when the machine is unattended. In secure receiving mode, all incoming faxes go into memory. When the mode is deactivated, any stored faxes are printed.

Activating secure receiving mode

- 1 Press **Fax**.
- 2 Press **Menu** and then press **OK** when **Fax Feature** appears on the bottom line of the display.
- 3 Press the **Scroll** buttons until **Secure Receive** appears and press **OK**.
- 4 Press the **Scroll** buttons until **On** appears and press **OK**.
- 5 Enter a four-digit password you want to use and press **OK**.



Note

You can activate secure receiving mode without setting a password, but cannot protect your faxes.

- 6 Re-enter the password to confirm it and press **OK**.
- 7 Press **Stop/Clear** to return to Standby mode.

When a fax is received in secure receiving mode, your machine stores it in memory and shows **Secure Receive** to let you know that there is a fax received.

Printing received faxes

- 1 Access the **Secure Receive** menu by following steps 1 through 3 in “Activating secure receiving mode”.
- 2 Press the **Scroll** buttons until **Print** appears and press **OK**.
- 3 Enter the four-digit password and press **OK**.
The machine prints all of the faxes stored in memory.

Deactivating secure receiving mode

- 1 Access the **Secure Receive** menu by following steps 1 through 3 in “Activating secure receiving mode”.
- 2 Press the **Scroll** buttons until **Off** appears and press **OK**.
The mode is deactivated and the machine prints all faxes stored in memory.
- 3 Enter the four-digit password and press **OK**.
- 4 Press **Stop/Clear** to return to Standby mode.

Receiving faxes in memory

Since your machine is a multi-tasking device, it can receive faxes while you are making copies or printing. If you receive a fax while you are copying or printing, your machine stores incoming faxes in its memory. Then, as soon as you finish copying or printing, the machine automatically prints the fax.

Printing received faxes on both sides of paper

By using the **Duplex** button on your machine, you can set the machine to print received faxes on both sides of paper.

- 1 Press **Duplex**.
- 2 Press the **Scroll** buttons until the binding option you want appears.
 - **Off**: Prints in Normal mode.
 - **1->2Side Short**: Prints pages to be read by flipping like a note pad.
 - **1->2Side Long**: Prints pages to be read like a book.



▲ 1->2Side Long

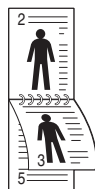

▲ 1->2Side Short

- 3 Press **OK** to save your selection.
If the mode is enabled, the **Duplex** button is backlit.

Other ways to fax

Sending a fax to multiple destinations

You can use the Multiple Send feature, which allows you to send a fax to multiple locations. Originals are automatically stored in memory and sent to a remote station. After transmission, the originals are automatically erased from memory.

- 1 Press **Fax**.
- 2 Load originals face up into the ADF, or place a single original face down on the scanner glass.
For details about loading an original, see page 5.1.
- 3 Adjust the document resolution and darkness to suit your fax needs. See page 9.1.
- 4 Press **Menu** until **Fax Feature** appears on the bottom line of the display and press **OK**.
- 5 Press the **Scroll** buttons until **Multi Send** appears and press **OK**.
- 6 Enter the number of the first receiving fax machine and press **OK**.
You can use speed buttons, speed dial numbers, or group dial numbers. For details, see page 10.2.
- 7 Enter the second fax number and press **OK**.
The display asks you to enter another fax number to send the document.
- 8 To enter more fax numbers, press **OK** when **Yes** appears and repeat steps 6 and 7. You can add up to 209 destinations.



Note

You cannot use group dial numbers for another fax number.

- 9 When you have finished entering fax numbers, select **No** at the **Another No.?** prompt and press **OK** or **Start**.
The original is scanned into memory before transmission. The display shows memory capacity and the number of pages being stored in memory.
- 10 If an original is placed on the scanner glass, select **Yes** to add another pages. Load another original and press **OK**.
When you have finished, select **No** at the **Another Page?** prompt.
The machine begins sending the fax to the numbers you entered in the order in which you entered them.

Sending a delayed fax

You can set your machine to send a fax at a later time when you will not be present.

- 1 Press **Fax**.
- 2 Load originals face up into the ADF, or place a single original face down on the scanner glass.
For details about loading an original, see page 5.1.
- 3 Adjust the document resolution and darkness to suit your fax needs. See page 9.1.
- 4 Press **Menu** until **Fax Feature** appears on the bottom line of the display and press **OK**.
- 5 Press the **Scroll** buttons until **Delay Send** appears and press **OK**.
- 6 Enter the number of the receiving machine using the number keypad.
You can use speed buttons, speed dial numbers, or group dial numbers. For details, see page 10.2.
- 7 Press **OK** to confirm the number. The display asks you to enter another fax number to which to send the document.
- 8 To enter more fax numbers, press **OK** when **Yes** appears and repeat steps 6 and 7. You can add up to 10 destinations.



Note

You cannot use group dial numbers for another fax number.

- 9 When you have finished entering fax numbers, press the **Scroll** buttons to select **No** at the **Another No.?** prompt and press **OK**.
- 10 Enter the job name you want and press **OK**.
For details on how to enter alphanumeric characters, see page 2.3.
If you do not want to assign a name, skip this step.
- 11 Enter the time using the number keypad and press **OK** or **Start**.



Note

If you set a time earlier than the current time, the fax will be sent at that time on the following day.

The original is scanned into memory before transmission. The display shows memory capacity and the number of pages being stored in memory.

- 12 If an original is placed on the scanner glass, select **Yes** to add another page. Load another original and press **OK**.
When you have finished, select **No** at the **Another Page?** prompt.
The machine returns to Standby mode. The display reminds you that you are in Standby mode and that a delayed fax is set.

Adding pages to a delayed fax

You can add pages to the delayed transmissions previously reserved in your machine's memory.

- 1 Load the originals to be added and adjust document settings.
- 2 Press **Menu** until **Fax Feature** appears on the bottom line of the display and press **OK**.
- 3 Press **OK** when **Add Page** appears.
- 4 Press the **Scroll** buttons until the fax job you want appears and press **OK**.

The machine scans the original into memory and shows the total number of pages and the number of the added pages.

Canceling a delayed fax

- 1 Press **Menu** until **Fax Feature** appears on the bottom line of the display and press **OK**.
- 2 Press the **Scroll** buttons until **Cancel Job** appears and press **OK**.
- 3 Press the **Scroll** buttons until the fax job you want appears and press **OK**.
- 4 Press **OK** when **Yes** appears.

The selected fax is deleted from memory.

Sending a priority fax

Using the Priority Fax feature, a high priority fax can be sent ahead of reserved operations. The original is scanned into memory and immediately transmitted when the current operation is finished. In addition, priority transmission will interrupt a Multiple Send operation between stations (i.e., when the transmission to station A ends, before transmission to station B begins) or between redial attempts.

- 1 Press **Fax**.
- 2 Load originals face up into the ADF, or place a single original face down on the scanner glass.
For details about loading an original, see page 5.1.
- 3 Adjust the document resolution and darkness to suit your fax needs. See page 9.1.
- 4 Press **Menu** until **Fax Feature** appears on the bottom line of the display and press **OK**.
- 5 Press the **Scroll** buttons until **Priority Send** appears and press **OK**.
- 6 Enter the number of the receiving machine.
You can use speed buttons or speed dial numbers. For details, see page 10.2.
- 7 Press **OK** to confirm the number.

- 8 Enter the job name you want and press **OK**.
The original is scanned into memory before transmission. The display shows memory capacity and the number of pages being stored in memory.
- 9 If an original is placed on the scanner glass, select **Yes** to add another page. Load another original and press **OK**.
When you have finished, select **No** at the **Another Page?** prompt.
The machine shows the number being dialed and begins sending the fax.

Forwarding faxes

You can forward your incoming and outgoing faxes to another fax machine or email address.

Forwarding sent faxes to another fax machine

You can set the machine to send copies of all outgoing faxes to a specified destination, in addition to the fax numbers you entered.

- 1 Press **Fax**.
- 2 Press **Menu** until **Fax Feature** appears on the bottom line of the display and press **OK**.
- 3 Press the **Scroll** buttons until **Forward** appears and press **OK**.
- 4 Press **OK** when **Fax** appears.
- 5 Press the **Scroll** buttons until **Send Forward** appears and press **OK**.
- 6 Press the **Scroll** buttons to select **On** and press **OK**.
- 7 Enter the number of the fax machine to which faxes are to be sent and press **OK**.
- 8 Press **Stop/Clear** to return to Standby mode.
Subsequent sent faxes will be forwarded to the specified fax machine.

Forwarding sent faxes to email address

You can set the machine to send copies of all outgoing faxes to a specified destination, in addition to the email address you entered.

- 1 Press **Fax**.
- 2 Press **Menu** until **Fax Feature** appears on the bottom line of the display and press **OK**.
- 3 Press the **Scroll** buttons until **Forward** appears and press **OK**.
- 4 Press the **Scroll** buttons until **E-mail** appears and press **OK**.
- 5 Press the **Scroll** buttons until **Send Forward** appears and press **OK**.
- 6 Press the **Scroll** buttons to select **On** and press **OK**.
- 7 Enter your email address and press **OK**.
- 8 Enter the email address to which faxes are to be sent and press **OK**.

- 9 Press **Stop/Clear** to return to Standby mode.
Subsequent sent faxes will be forwarded to the specified email address.

Forwarding received faxes to another fax machine

You can set your machine to forward incoming faxes to another fax number during a specified time period. When a fax arrives at your machine, it is stored in memory. Then, the machine dials the fax number that you have specified and sends the fax.

- 1 Press **Fax**.
- 2 Press **Menu** until **Fax Feature** appears on the bottom line of the display and press **OK**.
- 3 Press the **Scroll** buttons until **Forward** appears and press **OK**.
- 4 Press **OK** when **Fax** appears.
- 5 Press the **Scroll** buttons until **Rcv. Forward** appears and press **OK**.
- 6 Press the **Scroll** buttons until **Forward** appears and press **OK**.
To set the machine to print out a fax when fax forwarding has been completed, select **Forward&Print**.
- 7 Enter the number of the fax machine to which faxes are to be sent and press **OK**.
- 8 Enter the starting time and press **OK**.
- 9 Enter the ending time and press **OK**.
- 10 Press **Stop/Clear** to return to Standby mode.
Subsequent received faxes will be forwarded to the specified fax machine.

Forwarding received faxes to email address

You can set your machine to forward incoming faxes to the email address you entered.

- 1 Press **Fax**.
- 2 Press **Menu** until **Fax Feature** appears on the bottom line of the display and press **OK**.
- 3 Press the **Scroll** buttons until **Forward** appears and press **OK**.
- 4 Press the **Scroll** buttons until **E-mail** appears and press **OK**.
- 5 Press the **Scroll** buttons until **Rcv. Forward** appears and press **OK**.
- 6 Press the **Scroll** buttons until **Forward** appears and press **OK**.
To set the machine to print out a fax when fax forwarding has been completed, select **Forward&Print**.
- 7 Enter your email address and press **OK**.
- 8 Enter the email address to which faxes are to be sent and press **OK**.
- 9 Press **Stop/Clear** to return to Standby mode.
Subsequent received faxes will be forwarded to the specified email address.

10 Fax setup (SCX-5530FN only)

This chapter gives you information on setting up your machine for receiving and sending faxes.

This chapter includes:

- **Changing the fax setup options**
- **Changing the default document settings**
- **Printing sent fax report automatically**
- **Setting up Phone Book**

Changing the fax setup options

Your machine provides you with various user-selectable options for setting up the fax system. You can change the default settings for your preferences and needs.

To change the fax setup options:

- 1 Press **Fax**.
- 2 Press **Menu** until **Fax Setup** appears on the bottom line of the display and press **OK**.
- 3 Press the **Scroll** buttons to select **Sending** or **Receiving** and press **OK**.
- 4 Press the **Scroll** buttons until the menu item you want appears and press **OK**.
- 5 Press the **Scroll** buttons until the desired status appears or enter the value for the option you have selected, and press **OK**.
- 6 If necessary, repeat steps 4 through 5.
- 7 Press **Stop/Clear** to return to Standby mode.

Sending options

Option	Description
Redial Times	You can specify the number of redial attempts. If you enter 0 , the machine will not redial.
Redial Term	Your machine can automatically redial a remote fax machine if it was busy. You can set an interval between attempts.
Prefix Dial	You can set a prefix of up to five digits. This number dials before any automatic dial number is started. It is useful for accessing a PABX exchange.
ECM Mode^a	This mode helps with poor line quality and makes sure any faxes you send are sent smoothly to any other ECM-equipped fax machine. Sending a fax using ECM may take more time.

Option	Description
Sent Report	You can set your machine to print a confirmation report showing whether a transmission was successful, how many pages were sent, and more. The available options are On , Off , and On-Error , which prints only when a transmission is not successful.
Image TCR^b	You can prevent the actual faxed material from being included in the confirmation report for privacy or security protection.
Dial Mode	This setting may not be available depending on your country. If you cannot reach this option, your machine does not support this feature. You can set the dial mode for your machine to either tone dialing or pulse dialing. If you have a public telephone system or a private branch exchange (PBX) system, you may need to select Pulse . Contact your local telephone company if you are not sure which dial mode to use. Note If you select Pulse , some phone system features might not be available. It can also take longer to dial a fax or phone number.

a. Error Correction Mode

b. Transmission Confirmation Report

Receiving options

Option	Description
Receive Mode	You can select the default fax receiving mode. For details on receiving faxes in each mode, see page 9.3.
Ring to Answer	You can specify the number of times the machine rings before answering an incoming call.
Stamp Rcv Name	This option allows the machine to automatically print the page number, and the date and time of reception at the bottom of each page of a received fax.
Rcv Start Code	This code allows you to initiate fax reception from an extension phone plugged into the EXT socket on the back of the machine. If you pick up the extension phone and hear fax tones, enter the code. It is preset to *9* at the factory.

Option	Description
Auto Reduction	<p>When receiving a fax containing pages as long as or longer than the paper loaded in the paper tray, the machine can reduce the size of the original to fit the size of the paper loaded in the machine. Turn on this feature if you want to automatically reduce an incoming page.</p> <p>With this feature set to Off, the machine cannot reduce the original to fit onto one page. The original will be divided and printed in actual size on two or more pages.</p>
Discard Size	<p>When receiving a fax containing pages as long as or longer than the paper in your machine, you can set the machine to discard a specific length from the end of the received fax. The machine will print the received fax on one or more sheets of paper, minus the data that would have been on the specified discard segment.</p> <p>When the received fax contains pages larger than the paper in your machine, and Auto Reduction has been turned on, the machine will reduce the fax to fit on the existing paper, and nothing will be discarded.</p>
Junk Fax Setup	<p>Using this feature, the system will not accept faxes sent from remote stations whose numbers are stored in the memory as junk fax numbers. This feature is useful for blocking any unwanted faxes.</p> <p>When you turn on this feature, you can access the following options to set junk fax numbers.</p> <ul style="list-style-type: none"> • Add: allows you to set up to 10 fax numbers. • Delete: allows you to delete the desired junk fax number. • Delete All: allows you to delete all junk fax numbers.
DRPD Mode^a	<p>This mode enables a user to use a single telephone line to answer several different telephone numbers. In this menu, you can set the machine to recognize which ring patterns to answer. For details about this feature, see page 9.4.</p>

a. Distinctive Ring Pattern Detection

Changing the default document settings

The fax options, including resolution and darkness, can be set to the most frequently used modes. When you send a fax, the default settings are used if they are not changed by using the corresponding button and menu.

- 1 Press **Fax**.

- 2 Press **Menu** until **Fax Setup** appears on the bottom line of the display and press **OK**.
- 3 Press the **Scroll** buttons until **Change Default** appears and press **OK**.
- 4 Press **OK** when **Resolution** appears.
- 5 Press the **Scroll** buttons until the resolution you want appears and press **OK**.
- 6 Press the **Scroll** buttons until **Darkness** appears and press **OK**.
- 7 Press the **Scroll** buttons until the darkness you want appears and press **OK**.
- 8 Press **Stop/Clear** to return to Standby mode.

Printing sent fax report automatically

You can set the machine to print a report with detailed information about the previous 50 communication operations, including time and dates.

- 1 Press **Fax**.
- 2 Press **Menu** until **Fax Setup** appears on the bottom line of the display and press **OK**.
- 3 Press the **Scroll** buttons until **Auto Report** appears and press **OK**.
- 4 Press the **Scroll** buttons until **On** appears and press **OK**.
- 5 Press **Stop/Clear** to return to Standby mode.

Setting up Phone Book

You can set up **Phone Book** with the fax numbers you use most frequently. Your machine provides you with the following features for setting up **Phone Book**:

- Speed buttons
- Speed/Group dial numbers



Note

Before beginning to store fax numbers, make sure that your machine is in Fax mode.

Speed buttons

The 15 speed buttons on the control panel lets you store frequently-used fax numbers. You will be able to enter a fax number with the touch of a button. By utilizing the **Shift** button, you can store up to 30 numbers on the speed buttons.

There are two ways to assign numbers to speed buttons. Examine the procedures below and use the appropriate way which you prefer:

Registering after pressing a speed button

- 1 Press **Fax**.
- 2 Press one of the speed buttons.
- 3 Press **OK** when **Yes** appears.
- 4 Enter the name you want and press **OK**.
For details on how to enter alphanumeric characters, see page 2.3.
- 5 Enter the fax number you want to store and press **OK**.

Registering after entering a number first

- 1 Press **Fax**.
- 2 Enter the fax number you want to store.
- 3 Press one of the speed buttons.
- 4 Press **OK** when **Yes** appears.



Note

If you press a speed button already assigned, the display asks if you want to overwrite. Press **OK** to confirm **Yes** and continue. To start over with another speed button, select **No**.

- 5 Enter the name you want and press **OK**.
For details on how to enter alphanumeric characters, see page 2.3.
- 6 Press **OK** to confirm the number.

Using speed buttons

When you are prompted to enter a fax number while sending a fax:

- To retrieve a number from speed buttons 1 to 15, press the corresponding speed button and press **OK**.
- To retrieve a number from speed buttons 16 to 30, press **Shift** and then the corresponding speed button, and press **OK**.

Speed dial numbers

You can store up to 240 frequently-used fax numbers in speed dial numbers.

Registering a speed dial number

- 1 Press **Fax**.
- 2 Press **Address Book** until **New&Edit** appears on the bottom line of the display and press **OK**.
- 3 Press **OK** when **Speed Dial** appears.
- 4 Enter a speed dial number between 0 and 239 and press **OK**.
If an entry is already stored in the number you choose, the display shows the name to allow you to change it. To start over with another speed dial number, press **Back**.

- 5 Enter the name you want and press **OK**.
For details on how to enter alphanumeric characters, see page 2.3.
- 6 Enter the fax number you want and press **OK**.
- 7 Press **Stop/Clear** to return to Standby mode.

Editing speed dial numbers

- 1 Press **Address Book** until **New&Edit** appears on the bottom line of the display and press **OK**.
- 2 Press **OK** when **Speed Dial** appears.
- 3 Enter the speed dial number you want to edit and press **OK**.
- 4 Change the name and press **OK**.
- 5 Change the fax number and press **OK**.
- 6 Press **Stop/Clear** to return to Standby mode.

Using speed dial numbers

When you are prompted to enter a destination number while sending a fax, enter the speed dial number at which you stored the number you want.

- For a one-digit (0-9) speed dial number, press and hold the corresponding digit button on the number keypad.
- For a two- or three-digit speed dial number, press the first digit button(s) and then hold down the last digit button.

You can also search through memory for an entry by pressing **Address Book**. See page 10.4.

Group dial numbers

If you frequently send the same document to several destinations, you can group these destinations and set them under a group dial number. You can then use a group dial number to send a document to all of the destinations within the group. You can set up to 200 (0 through 199) group dial numbers using the destination's existing speed dial numbers.

Registering a group dial number

- 1 Press **Fax**.
- 2 Press **Address Book** until **New&Edit** appears on the bottom line of the display and press **OK**.
- 3 Press the **Scroll** buttons until **Group Dial** appears and press **OK**.
- 4 Enter a group dial number between 0 and 199 and press **OK**.
- 5 Enter a speed dial number and press **OK**.
- 6 Press **OK** when **Yes** appears.
- 7 Repeat steps 5 and 6 to include other speed dial numbers into the group.

- 8 When you have finished, press the **Scroll** buttons to select **No** at the **Another No.?** prompt and press **OK**.
- 9 Press **Stop/Clear** to return to Standby mode.

Editing a group dial number

You can delete a specific entry from a group or add a new number to the selected group.

- 1 Press **Address Book** until **New&Edit** appears on the bottom line of the display and press **OK**.
- 2 Press the **Scroll** buttons until **Group Dial** appears and press **OK**.
- 3 Enter the group dial number you want to edit and press **OK**.
- 4 Enter the speed dial number you want to add or delete and press **OK**.

If you entered a new speed dial number, **Add?** appears.

If you enter a speed dial number stored in the group, **Delete?** appears.

- 5 Press **OK** to add or delete the number.
- 6 Press **OK** when **Yes** appears to add or delete more numbers and repeat from step 4.
- 7 When you have finished, press the **Scroll** buttons to select **No** at the **Another No.?** prompt and press **OK**.
- 8 Press **Stop/Clear** to return to Standby mode.

Using group dial numbers

To use a group dial entry, you need to search for and select it from memory.

When you are prompted to enter a fax number while sending a fax, press **Address Book**. See below.

Searching Phone Book for an entry

There are two ways to search for a number in memory. You can either scan from A to Z sequentially, or you can search by entering the first letters of the name associated with the number.

Searching sequentially through the memory

- 1 If necessary, press **Fax**.
- 2 Press **Address Book** until **Search&Dial** appears on the bottom line of the display and press **OK**.
- 3 Press the **Scroll** buttons until the number category you want appears and press **OK**.
- 4 Press **OK** when **All** appears.
- 5 Press the **Scroll** buttons until the name and number you want appears. You can search upwards or downwards through the entire memory in alphabetical order.

Searching with a particular first letter

- 1 If necessary, press **Fax**.
- 2 Press **Address Book** until **Search&Dial** appears on the bottom line of the display and press **OK**.
- 3 Press the **Scroll** buttons until the number category you want appears and press **OK**.
- 4 Press the **Scroll** buttons until **ID** appears and press **OK**.
- 5 Enter the first few letters of the name you want and press **OK**.
- 6 Press the **Scroll** buttons until the name you want appears and press **OK**.

Deleting a Phone Book entry

You can delete entries in **Phone Book** one by one.

- 1 Press **Address Book** until **Delete** appears on the bottom line of the display and press **OK**.
- 2 Press the **Scroll** buttons until the number category you want appears and press **OK**.
- 3 Press the **Scroll** buttons until the searching method you want appears and press **OK**.
Select **Search All** to search for an entry by scanning through all entries in **Phone Book**.
Select **Search ID** to search for an entry by the first few letters of the name.
- 4 Press the **Scroll** buttons until the name you want appears and press **OK**.
Or, enter the first letters and press **OK**. Press the **Scroll** buttons until the name you want appears and press **OK**.
- 5 Press **OK**.
- 6 Press **OK** when **Yes** appears to confirm the deletion.
- 7 Press **Stop/Clear** to return to Standby mode.

Printing Phone Book

You can check your **Phone Book** settings by printing a list.

- 1 Press **Address Book** until **Print** appears on the bottom line of the display.
- 2 Press **OK**. A list showing your speed button settings, and speed dial and group dial entries prints out.

11 Using USB flash memory

(SCX-5530FN only)

This chapter explains how to use a USB memory device with your machine.

This chapter includes:

- **About USB memory**
- **Plugging in a USB memory device**
- **Scanning to a USB memory device**
- **Printing from a USB memory device**
- **Backing up data**
- **Managing USB memory**

About USB memory

USB memory devices are available with a variety of memory capacities to give you more room for storing documents, presentations, downloaded music and videos, high resolution photographs, or whatever other files you want to store or move.

You can do the following on your machine using a USB memory device:

- Scan documents and save them on a USB memory device.
- Print data stored on a USB memory device.
- Back up **Address Book/Phone Book** entries and the system settings of your machine.
- Restore backup files to the machine's memory.
- Format the USB memory device.
- Check the available memory space.

Plugging in a USB memory device

The USB memory port on the front of your machine is designed for USB V1.1 and USB V2.0 memory devices. Your machine supports USB memory devices with capacity of up to 512 MB.

You must use only an authorized USB memory device with an A plug type connector.

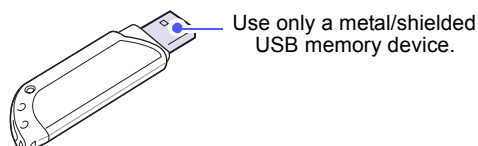

Note

There are two USB plug types.



Insert a USB memory device into the USB memory port on the front of your machine.

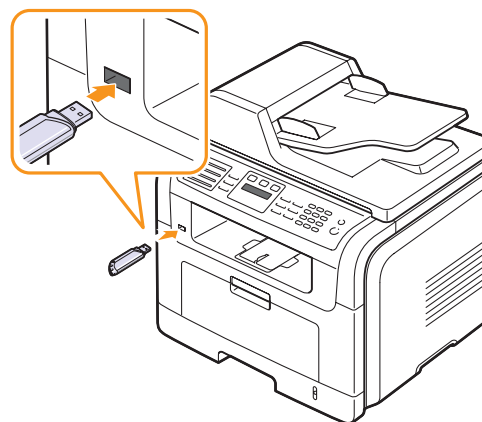

Cautions

- Do not remove the USB memory device while the machine is in operation, or writing to or reading from USB memory. This may damage your machine.
- If your USB memory device has certain features, such as security settings and password settings, your machine may not automatically detect it. For details about these features, see the device's User's Guide.

Scanning to a USB memory device

You can scan a document and save the scanned image onto a USB memory device. There are two ways of doing this: you can scan to the device using the default settings, or you can customize your own scan settings.

Scanning

- 1 Insert a USB memory device into the USB memory port on your machine.
- 2 Load originals face up into the ADF, or place a single original face down on the scanner glass.
For details about loading an original, see page 5.1.
- 3 Press **Scan/Email**.
- 4 Press **OK** when **Scan to USB** appears on the bottom line of the display.

- 5 Press **OK** or **Start** when **USB** appears.

Your machine begins scanning the original, and then asks if you want to scan another page.

- 6 Press **OK** when **Yes** appears to scan more pages. Load an original and press **Start**.

Otherwise, press the **Scroll** buttons to select **No** and press **OK**.

After scanning is complete, you can remove the USB memory device from the machine.

Customizing Scan to USB

You can specify image size, file format, or color mode for each scanning to USB job.

- 1 Press **Scan/Email**.
- 2 Press **Menu** until **Scan Feature** appears on the bottom line of the display and press **OK**.
- 3 Press **OK** when **USB Memory** appears.
- 4 Press the **Scroll** buttons until the setting option you want appears and press **OK**.
You can set the following options:
 - **Scan Size**: Sets the image size.
 - **Original Type**: Sets the original document's type.
 - **Resolution**: Sets the image resolution.
 - **Scan Color**: Sets the color mode.
 - **Scan Format**: Sets the file format in which the image is to be saved. When you select TIFF or PDF, you can select to scan multiple pages.
- 5 Press the **Scroll** buttons until the desired status appears and press **OK**.
- 6 Repeat steps 4 and 5 to set other setting options.
- 7 When you have finished, press **Stop/Clear** to return to Standby mode.

Printing from a USB memory device

You can directly print files stored on a USB memory device. You can print TIFF, BMP, JPEG, PDF, and PRN files.

Direct Print option supported file types:

- PRN: Samsung PCL 6 compatible.
- PRN files can be created by selecting the Print to file check box when you print a document. The document will be saved as a PRN file, rather than printed on paper. Only PRN files created in this fashion can be printed directly from USB memory.
See the Software Section to learn how to create a PRN file.

- BMP: BMP Uncompressed
- TIFF: TIFF 6.0 Baseline
- JPEG: JPEG Baseline
- PDF: PDF 1.4 and below

To print a document from a USB memory device:

- 1 Insert a USB memory device into the USB memory port on your machine. If one has already been inserted, press **USB Print**.
Your machine automatically detects the device and reads data stored on it.
- 2 Press the **Scroll** buttons until the folder or file you want appears and press **OK**.
If you see **D** in the front of a folder name, there are one or more folders in the selected folder.
- 3 If you selected a file, skip to the next step.
If you selected a folder, press the **Scroll** buttons until the file you want appears.
- 4 Press **OK**, **Start**, or **USB Print** to start printing the selected file.
- 5 If you selected a TIFF, BMP, or JPEG file in step 2, press the **Scroll** buttons to select the number of copies to be printed or enter the number and press **OK**.
After printing the file, the display asks if you want to print another job.
- 6 Press **OK** when **Yes** appears to print another job, and repeat from step 2.
Otherwise, press the **Scroll** buttons to select **No** and press **OK**.
- 7 Press **Stop/Clear** to return to Standby mode.

Printing on both sides of paper

By using the **Duplex** button on your machine, you can set the machine to print documents on both sides of paper.

- 1 Press **Duplex**.
- 2 Press the **Scroll** buttons until the binding option you want appears.
 - **Off**: Prints in Normal mode.
 - **1->2Side Short**: Prints pages to be read by flipping like a note pad.
 - **1->2Side Long**: Prints pages to be read like a book.

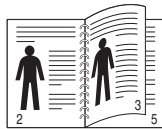

▲ 1->2Side Long

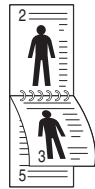

▲ 1->2Side Short

- 3 Press **OK** to save your selection.
If the mode is enabled, the **Duplex** button is backlit.

Backing up data

Data in the machine's memory can be accidentally erased due to power failure or storage failure. Backup helps you protect your **Address Book/Phone Book** entries and the system settings by storing them as backup files on a USB memory device.

Backing up data

- 1 Insert the USB memory device into the USB memory port on your machine.
- 2 Press **Menu** until **System Setup** appears on the bottom line of the display and press **OK**.
- 3 Press **OK** when **Machine Setup** appears.
- 4 Press the **Scroll** buttons until **Export Setting** appears and press **OK**.
- 5 Press the **Scroll** buttons until the option you want appears.
 - **Address Book**: Backs up all **Address Book/Phone Book** entries.
 - **Setup Data**: Backs up all system settings.
- 6 Press **OK** to begin backing up the data.
The data is backed up to the USB memory.
- 7 Press **Stop/Clear** to return to Standby mode.

Restoring data

- 1 Insert the USB memory device on which the backup data is stored in to the USB memory port.
- 2 Press **Menu** until **System Setup** appears on the bottom line of the display and press **OK**.
- 3 Press **OK** when **Machine Setup** appears.
- 4 Press the **Scroll** buttons until **Import Setting** appears and press **OK**.
- 5 Press the **Scroll** buttons until the data type you want appears and press **OK**.
- 6 Press the **Scroll** buttons until the file containing the data you want to restore appears and press **OK**.
- 7 Press **OK** when **Yes** appears to restore the backup file to the machine.
- 8 Press **Stop/Clear** to return to Standby mode.

Managing USB memory

You can delete image files stored on a USB memory device one by one or all at once by reformatting the device.



Caution

After deleting files or reformatting a USB memory device, files cannot be restored. Therefore, confirm that you no longer need the data before deleting it.

Deleting an image file

- 1 Insert the USB memory device into the USB memory port on your machine.
- 2 Press **Scan/Email**.
- 3 Press **OK** when **Scan to USB** appears on the bottom line of the display.
- 4 Press the **Scroll** buttons until **File Manage** appears and press **OK**.
- 5 Press **OK** when **Delete** appears.
- 6 Press the **Scroll** buttons until the folder or file you want appears and press **OK**.



Note

If you see **D** in the front of a folder name, there are one or more folders in the selected folder.

If you selected a file, the display shows the size of the file for about 2 seconds. Go to the next step.

If you selected a folder, press the **Scroll** buttons until the file you want to delete appears and press **OK**.

- 7 Press **OK** when **Yes** appears to confirm your selection.
- 8 Press **Stop/Clear** to return to Standby mode.

Formatting a USB memory device

- 1 Insert the USB memory device into the USB memory port on your machine.
- 2 Press **Scan/Email**.
- 3 Press **OK** when **Scan to USB** appears on the bottom line of the display.
- 4 Press the **Scroll** buttons until **File Manage** appears and press **OK**.
- 5 Press the **Scroll** buttons until **Format** appears and press **OK**.
- 6 Press **OK** when **Yes** appears to confirm your selection.
- 7 Press **Stop/Clear** to return to Standby mode.

Viewing the USB memory status

You can check the amount of memory space available for scanning and saving documents.

- 1 Insert the USB memory device into the USB memory port on your machine.
- 2 Press **Scan/Email**.
- 3 Press **OK** when **Scan to USB** appears on the bottom line of the display.
- 4 Press the **Scroll** buttons until **Check Space** appears and press **OK**.
The available memory space appears on the display.
- 5 Press **Stop/Clear** to return to the Standby mode.

12 Ordering supplies and accessories

This chapter provides information on purchasing toner cartridges and accessories available for your machine.

Toner cartridges

When the toner runs out, you can order the following types of toner cartridges for your machine:

Type	Yield ^a	Part number
Standard yield	4,000 pages	SCX-D5530A
High yield	8,000 pages	SCX-D5530B

a. ISO 19752 5% coverage

Accessories

You can purchase and install accessories to enhance your machine's performance and capacity.

The following accessories are available for your machine:

Accessory	Description	Part number
Optional tray	If you are experiencing frequent paper supply problems, you can attach an additional 250 sheet tray. You can print documents on various sizes and types of print materials.	SCX-S5530A
Memory DIMM	Extends your machine's memory capacity.	<ul style="list-style-type: none">• ML-00MA: 16 MB• ML-00MB: 32 MB• ML-00MC: 64 MB• ML-00MD: 128 MB• ML-MEM140: 256 MB



Note

The SCX-5530FN comes with 64 MB of on-board memory and a 32 MB DIMM. To expand the memory of your machine, you must remove the existing DIMM and purchase a larger one.

How to purchase

To order Samsung-authorized supplies or accessories, contact your local Samsung dealer or the retailer where you purchased your machine, or visit www.samsungprinter.com and select your country/region for information on calling for technical support.

13 Maintenance

This chapter provides information for maintaining your machine and the toner cartridge.

This chapter includes:

- **Printing reports**
- **Clearing memory**
- **Cleaning your machine**
- **Maintaining the toner cartridge**
- **Maintenance Parts**
- **Managing your machine from the website**
- **Checking the machine's serial number**

Printing reports

Your machine can provide various reports with useful information you will need. The following reports are available:

Reports in the colored cells are only available with SCX-5530FN.

Report/List	Description
Configuration	This list shows the status of the user-selectable options. You may print this list to confirm your changes after changing settings.
Address Book	This list shows all of the fax numbers and email addresses currently stored in the machine's memory.
Send Report	This report shows the fax number, the number of pages, the elapsed time of the job, the communication mode, and the communication results for a particular fax job. You can set up your machine to automatically print a transmission confirmation report after each fax job. See page 10.1.
Sent Report	This report shows information on the faxes and emails you have recently sent. You can set the machine to automatically print this report every 50 communications. See page 10.2.
Fax Rcv Report	This report shows information on the faxes you have recently received.
Schedule Jobs	This list shows the documents currently stored for delayed faxes along with the starting time and type of each operation.

Report/List	Description
JunkFax Report	This list shows the fax numbers specified as junk fax numbers. To add or delete numbers to or from this list, access the Junk Fax Setup menu.
Network Info.	This list shows information on your machine's network connection and configuration.
NetScan Report	This report shows information for the Network Scan records including IP address, time and date, the number of pages scanned, and results. This report is automatically printed every 50 network scan jobs.
User Auth List	This list shows authorized users who are allowed to use the email function.

Printing a report

- 1 Press **Menu** until **System Setup** appears on the bottom line of the display and press **OK**.
- 2 Press the **Scroll** buttons until **Report** appears and press **OK**.
- 3 Press the **Scroll** buttons until the report or list you want to print appears and press **OK**.
To print all reports and lists, select **All Report**.
- 4 Press **OK** when **Yes** appears to confirm printing.
The selected information prints out.

Other available reports (SCX-5530FN only)

Your machine prints the following reports automatically or depending on your setting.

- **Multi-communication Report:** prints automatically after sending faxes from more than one location.
- **Power Failure Report:** prints out automatically when power is restored after a power failure if any data loss occurs due to the power failure.

Clearing memory

You can selectively clear information stored in your machine's memory.



Caution

For SCX-5530FN users, before clearing the memory, make sure that all fax jobs have been completed, or you will lose those jobs.

- 1 Press **Menu** until **System Setup** appears on the bottom line of the display and press **OK**.
- 2 Press the **Scroll** buttons until **Clear Setting** appears and press **OK**.
- 3 Press the **Scroll** buttons until the item you want to clear appears.

The options in the colored cells are available only with SCX-5530FN.

Options	Description
All Settings	Clears all of the data stored in memory and resets all of your settings to the factory default.
Fax Setup	Restores all of the fax options to the factory default.
Copy Setup	Restores all of the copy options to the factory default.
Scan Setup	Restores all of the scan options to the factory default.
System Setup	Restores all of the system options to the factory default.
Network	Restores all of the network options to the factory default.
Address Book	Clears all of the fax number and email address entries stored in memory.
Sent Report	Clears all records of sent faxes and emails.
Fax Rcv Report	Clears all records of received faxes.
NetScan Report	Clears the information on network scan sessions in memory.

- 4 Press **OK** when **Yes** appears.
- 5 Press **OK** again to confirm clearing.
- 6 Repeat steps 3 through 5 to clear another item.
- 7 Press **Stop/Clear** to return to Standby mode.

Cleaning your machine

To maintain print and scan quality, follow the cleaning procedures below each time the toner cartridge is replaced or if print and scan quality problems occur.



Caution

Cleaning the cabinet of the machine with cleaning materials containing large amounts of alcohol, solvent, or other strong substances can discolor or distort the cabinet.

Cleaning the outside

Clean the cabinet of the machine with a soft lint-free cloth. You can dampen the cloth slightly with water, but be careful not to let any water drip onto or into the machine.

Cleaning the inside

During the printing process, paper, toner, and dust particles can accumulate inside the machine. This buildup can cause print quality problems, such as toner specks or smearing. Cleaning the inside of the machine clears or reduces these problems.

- 1 Turn the machine off and unplug the power cord. Wait for the machine to cool down.
- 2 Open the front cover and pull the toner cartridge out. Set it on a clean flat surface.

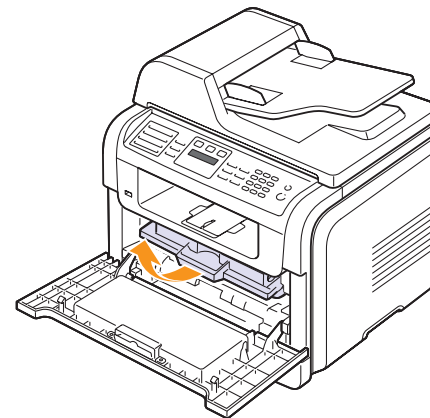

Cautions



- To prevent damage to the toner cartridge, do not expose it to light for more than a few minutes. Cover it with a piece of paper, if necessary.
- Do not touch the green surface underside of the toner cartridge. Use the handle on the cartridge to avoid touching this area.

- 3 With a dry lint-free cloth, wipe away any dust and spilled toner from the toner cartridge area and the toner cartridge cavity.

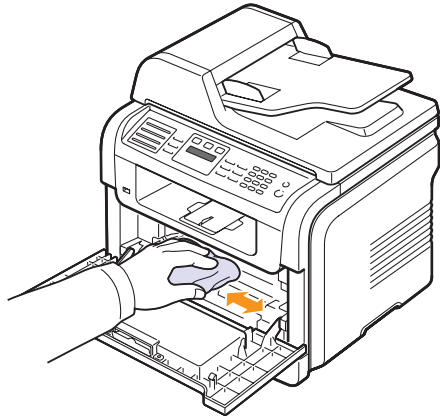

Caution

While cleaning the inside of the machine, be careful not to touch the transfer roller, located underneath the toner cartridge. Oil from your fingers can cause print scan quality problems.

- 4 Locate the long strip of glass (LSU) inside the top of the cartridge compartment, and gently swab the glass to see if dirt turns the white cotton black.

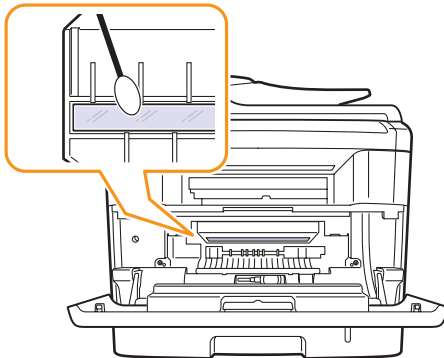

- 5 Reinsert the toner cartridge and close the front cover.
- 6 Plug in the power cord and turn the machine on.

Cleaning the scan unit

Keeping the scan unit clean helps ensure the best possible copies. We suggest that you clean the scan unit at the start of each day and during the day, as needed.

- 1 Slightly dampen a soft lint-free cloth or paper towel with water.
- 2 Open the scanner lid.
- 3 Wipe the surface of the scanner glass and ADF glass until it is clean and dry.

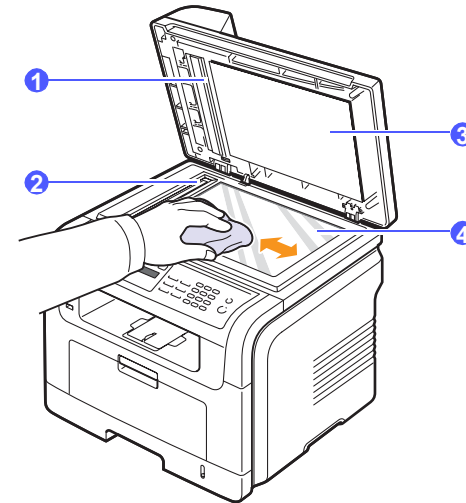

- | | |
|---|---------------|
| 1 | white sheet |
| 2 | ADF glass |
| 3 | scanner lid |
| 4 | scanner glass |

- 4 Wipe the underside of the scanner lid and white sheet until it is clean and dry.
- 5 Close the scanner lid.

Maintaining the toner cartridge

Toner cartridge storage

To get the most from the toner cartridge, keep the following guidelines in mind:

- Do not remove the toner cartridge from its package until ready for use.
- Do not refill the toner cartridge. The machine warranty does not cover damage caused by using a refilled cartridge.
- Store toner cartridges in the same environment as your machine.
- To prevent damage to the toner cartridge, do not expose it to light for more than a few minutes.

Expected cartridge life

The life of the toner cartridge depends on the amount of toner that print jobs require. When printing text at ISO 19752 5% coverage, a new toner cartridge lasts an average of either 8,000 or 4,000 pages. (The original toner cartridge supplied with the machine lasts an average of 4,000 pages.) The actual number may also be different depending on the print density of the pages you print on, and the number of pages may be affected by operating environment, printing interval, media type, and media size. If you print a lot of graphics, you may need to change the cartridge more often.

Redistributing toner

When the toner cartridge is near the end of its life:

- White streaks or light printing occurs.
- **Toner Low** appears on the display.
- The **Status** LED blinks red.

If this happens, you can temporarily reestablish print quality by redistributing the remaining toner in the cartridge. In some cases, white streaks or light printing will still occur even after you have redistributed the toner.

- 1 Open the front cover.
- 2 Pull the toner cartridge out.

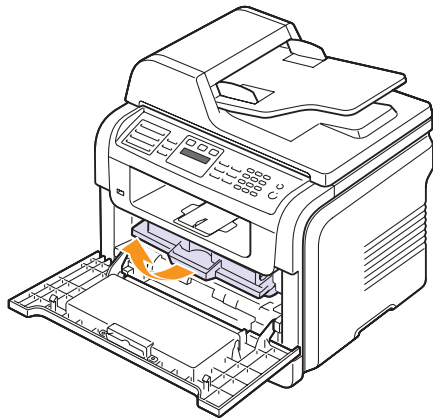

- 3 Thoroughly roll the cartridge 5 or 6 times to distribute the toner evenly inside the cartridge.

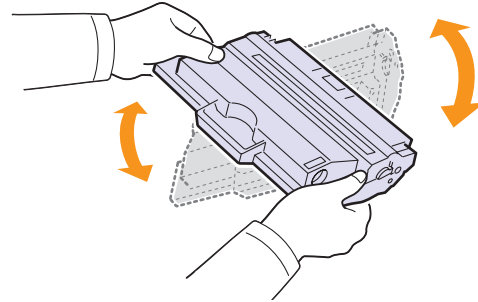

Note

If toner gets on your clothing, wipe it off with a dry cloth and wash clothing in cold water. Hot water sets toner into fabric.



Caution

Do not touch the green underside of the toner cartridge. Use the handle on the cartridge to avoid touching this area.

- 4 Hold the toner cartridge by the handle and slowly insert the cartridge into the opening in the machine.

Tabs on the sides of the cartridge and corresponding grooves within the machine will guide the cartridge into the correct position until it locks into place completely.

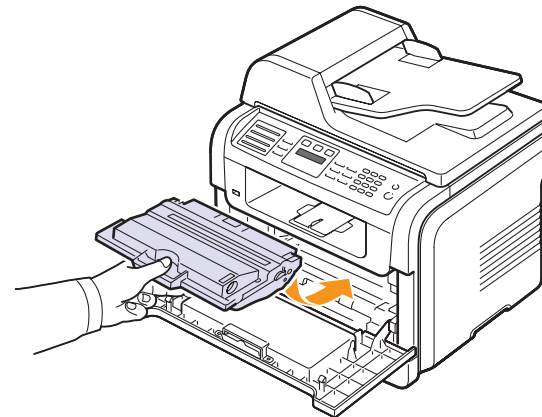

- 5 Close the front cover. Make sure that the cover is securely closed.

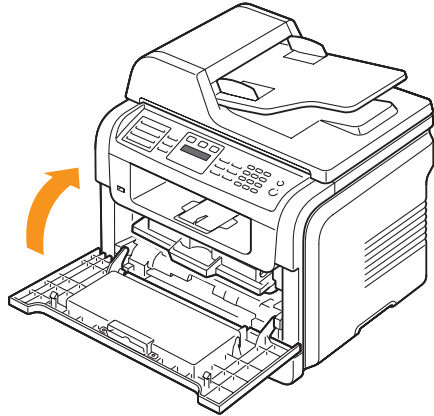

Replacing the toner cartridge

When the toner cartridge is completely empty:

- **Toner Empty** appears on the display.
- The **Status** LED blinks red.
- The machine stops printing. For the SCX-5530FN, incoming faxes are saved in memory.

At this stage, the toner cartridge needs to be replaced. For order information for toner cartridges, see page 12.1.



Note

You can set the machine to disregard the **Toner Empty** message and to continue printing. See page 13.6.

- 1 Open the front cover.
- 2 Pull the toner cartridge out.

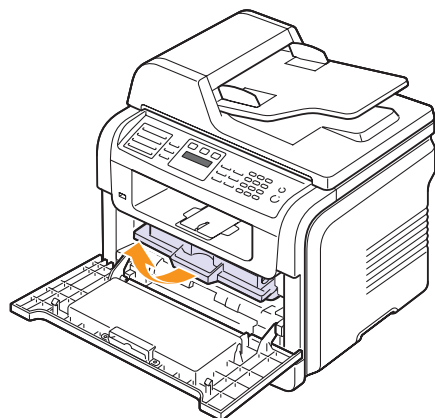

- 3 Remove the new toner cartridge from its bag.
- 4 Remove the packing tape and roll the cartridge 5 or 6 items to distribute the toner.

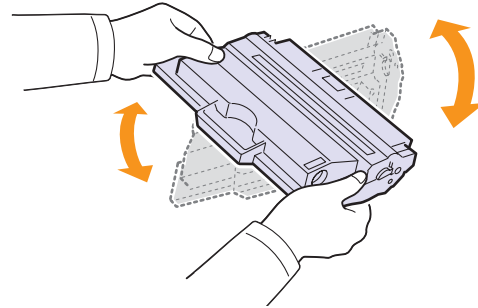

Thoroughly roll the cartridge to assure maximum copies per cartridge. Save the box and the plastic bag for shipping.



Note

If toner gets on your clothing, wipe it off with a dry cloth and wash clothing in cold water. Hot water sets toner into fabric.



Caution

Do not touch the green underside of the toner cartridge. Use the handle on the cartridge to avoid touching this area.

- 5 Hold the toner cartridge by the handle and slowly insert the cartridge into the opening in the machine.

Tabs on the sides of the cartridge and corresponding grooves within the machine will guide the cartridge into the correct position until it locks into place completely.

- 6 Close the front cover. Make sure that the cover is securely closed.

Cleaning the drum

If there are streaks or spots on your print, the OPC drum of the toner cartridge may require cleaning.

- 1 Before starting the cleaning procedure, make sure that paper is loaded in the machine.
- 2 Press **Menu** until **System Setup** appears on the bottom line of the display and press **OK**.
- 3 Press the **Scroll** buttons until **Maintenance** appears and press **OK**.
- 4 Press **OK** when **Clean Drum** appears.

The machine prints out a cleaning page. Toner particles on the drum surface are affixed to the paper.

If the problem remains, repeat steps 1 through 4.

Sending new toner notification (SCX-5530FN only)

You can set your machine to automatically send a fax to your service company or dealer to notify them that your machine requires a new toner cartridge when the toner cartridge needs to be replaced. The fax number needs to be set by your dealer prior to using this feature, otherwise the machine cannot send a notification even though you turn this service on.

- 1 Press **Menu** until **System Setup** appears on the bottom line of the display and press **OK**.
- 2 Press the **Scroll** buttons until **Maintenance** appears and press **OK**.
- 3 Press the **Scroll** buttons until **Remote Service** appears and press **OK**.
- 4 Enter a password and press **OK**.
- 5 Re-enter the password and press **OK**.
- 6 Press the **Scroll** buttons to select **On** and press **OK**.
- 7 Press **Stop/Clear** to return to Standby mode.

Once this feature has been enabled, you need to enter the password each time you disable or enable it.

Printing continuously when the Toner Empty message appears

When the toner cartridge is nearly empty, the machine shows the **Toner Empty** message and stops printing. You can set the machine to disregard this message when it appears and to continue printing, even though print quality is not optimal.

- 1 Press **Menu** until **System Setup** appears on the bottom line of the display and press **OK**.
- 2 Press the **Scroll** buttons until **Maintenance** appears and press **OK**.
- 3 Press the **Scroll** buttons until **Ignore Toner** appears and press **OK**.
- 4 Press the **Scroll** buttons until the desired status appears and press **OK**.

If you select off, the received fax cannot be printed until you install a new toner cartridge. However, faxes can be received into memory as long as it allows

- 5 Press **Stop/Clear** to return to Standby mode.

Clearing the Toner Empty Replace Toner message

When the **Toner Empty Replace Toner** message appears you can configure not to see this message again not to disturb you.

- 1 Press **Menu** until **System Setup** appears on the bottom line of the display and press **OK**.
- 2 Press the **Scroll** buttons until **Maintenance** appears and press **OK**.
- 3 Press the **Scroll** buttons until **CLR Empty Msg.** appears and press **OK**.
- 4 Select **On** and press **OK**.
- 5 Now the **Toner Empty Replace Toner** message does not appear but the **Replace Toner** message will remain for reminding you that the new cartridge needs to be installed for quality.



Caution

Once you have selected **On**, this setting will be permanently written to the memory of the toner cartridge, and this menu will be disappeared from the **Maintenance** menu.

Maintenance Parts

To avoid print quality and paper feed problems resulting from worn parts and to maintain your printer in top working condition the following items will need to be replaced at the specified number of pages or when the life span of each item has expired.

Items	Yield (Average)
ADF rubber pad	Approx. 20,000 pages
Transfer roller	Approx. 70,000 pages
Fuser unit	Approx. 80,000 pages
Tray rubber pad	Approx. 250,000 pages
Pickup roller	Approx. 150,000 pages

Samsung highly recommends that an authorized service provider, dealer or the retailer where you bought printer performs this maintenance activity.

Checking replaceables

If you experience frequent paper jams or printing problems, check the number of pages the machine has printed or scanned. Replace the corresponding parts, if necessary.

The following information are available for checking the replaceable elements of your machine:

- **Total:** displays the total number of pages printed.
- **Toner:** displays how much toner remains in the cartridge.
- **Drum:** displays the number of pages printed.
- **Platen Scan:** displays the number of pages scanned using the scanner glass.



Note

While the following messages are appearing on the display, the sub-menu(s) under **Supplies Life** can be changed:

- **Invalid Toner**
- **NonGenuine Toner**
- **Replace Toner**
- **Toner Exhausted**

To check the replaceables:

- 1 Press **Menu** until **System Setup** appears on the bottom line of the display and press **OK**.
- 2 Press the **Scroll** buttons until **Maintenance** appears and press **OK**.
- 3 Press the **Scroll** buttons until **Supplies Life** appears and press **OK**.
- 4 Press the **Scroll** buttons until the item you want appears and press **OK**.
- 5 If you selected to print a supply information page, press **OK** to confirm.
- 6 Press **Stop/Clear** to return to Standby mode.

Replacing the ADF rubber pad

You will need to replace the ADF rubber pad when there seems to be a consistent problem with paper pickup or when its specified yield is reached.

- 1 Open the ADF cover.
- 2 Rotate the bushing on the right end of the ADF roller toward the ADF and remove the roller from the slot.

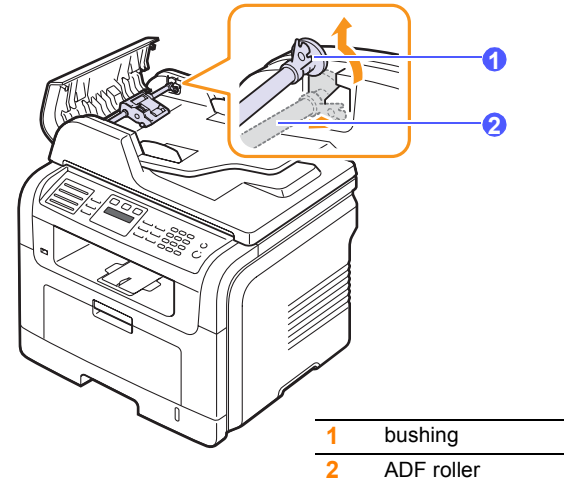

- 3 Remove the ADF rubber pad from the ADF, as shown.

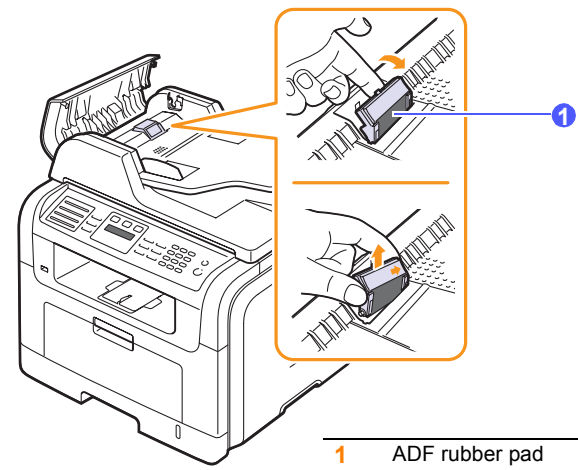

- 4 Insert a new ADF rubber pad into place.

- 5 Align the left end of the ADF roller with the slot and push the right end of the roller into the right slot. Rotate the bushing on the right end of the roller toward the document input tray.

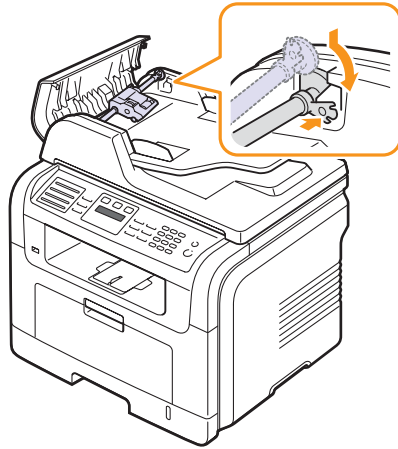

- 6 Close the ADF cover.

Managing your machine from the website

If you have connected your machine to a network and set up TCP/IP network parameters correctly, you can manage the machine via Samsung's **SyncThru™ Web Service**, an embedded web server. Use **SyncThru™ Web Service** to:

- View the machine's device information and check its current status.
- Change TCP/IP parameters and set up other network parameters.
- Change the printer properties.
- Set the machine to send email notifications to let you know the machine's status.
- Get support for using the machine.

To access **SyncThru™ Web Service**:

- 1 Start a web browser, such as Internet Explorer, from Windows.
- 2 Enter the machine IP address (<http://xxx.xxx.xxx.xxx>) in the address field and press the **Enter** key or click **Go**.

Your machine's embedded website opens.

Checking the machine's serial number

When you call for service or register as a user on the Samsung website, the machine's serial number may be required.

You can check the serial number by taking the following steps:

- 1 Press **Menu** until **System Setup** appears on the bottom line of the display and press **OK**.
- 2 Press the **Scroll** buttons until **Maintenance** appears and press **OK**.
- 3 Press the **Scroll** buttons until **Serial Number** appears and press **OK**.
- 4 Check your machine's serial number.
- 5 Press **Stop/Clear** to return to Standby mode.

14 Troubleshooting

This chapter gives helpful information for what to do if you encounter an error.

This chapter includes:

- **Clearing document jams**
- **Clearing paper jams**
- **Understanding display messages**
- **Solving other problems**

Clearing document jams

When an original jams while passing through the ADF, **Document Jam** appears on the display.



Caution

To avoid tearing the document, pull out the jammed document gently and slowly.

- 1 Remove any remaining pages from the ADF.
- 2 Open the ADF cover.

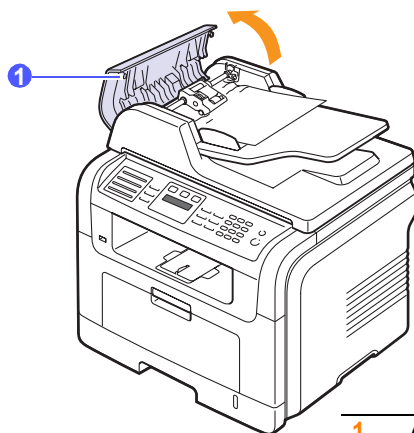

1 ADF cover

- 3 Pull the jammed paper gently out of the ADF.

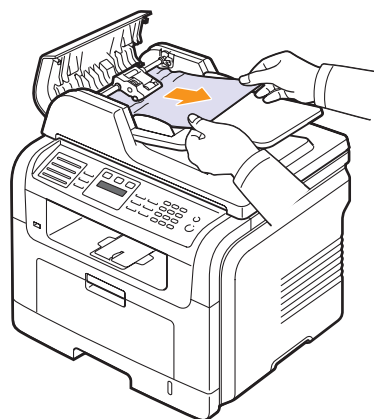

Note

If you do not see the paper in this area, refer to Roller misfeed. See page 14.2.

- 4 Close the ADF cover. Then load the removed pages, if any, back into the ADF.

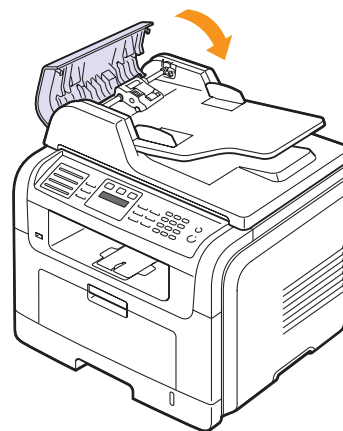

Note

To prevent document jams, use the scanner glass for thick, thin, or mixed paper-type originals.

Roller misfeed

- 1 Open the scanner lid.
- 2 Seize the misfed paper, and remove the paper from the feed area by carefully pulling it to the right using both hands.

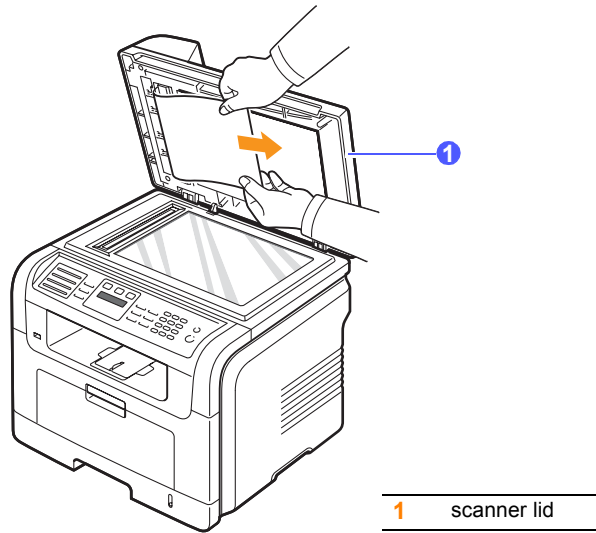

- 3 Close the scanner lid. Then load the removed pages back into the ADF.

Clearing paper jams

When a paper jam occurs, **Paper Jam** appears on the display. Refer to the table below to locate and clear the paper jam.

Message	Location of jam	Go to
[Paper Jam 0] Open/Close Door	In the paper feed area (tray 1, optional tray 2, or multi-purpose tray)	below and page 14.3
[Paper Jam 1] Open/Close Door	In the fuser area or around the toner cartridge	page 14.3
[Paper Jam 2] Check Inside	In the paper exit area	page 14.4
[Duplex Jam 0]^a Check Inside	In the duplex unit	page 14.5
[Duplex Jam 1]^a Check Inside	Between the duplex unit and fuser area	page 14.6

a. SCX-5530FN only



Caution

To avoid tearing the paper, pull out the jammed paper gently and slowly. Follow the instructions in the following sections to clear the jam.

In the tray 1

- 1 Open and close the front cover. The jammed paper is automatically ejected from the machine.
If the paper does not exit, go to the next step.
- 2 Pull the tray 1 open.



- 3 Remove the jammed paper by gently pulling it straight out.

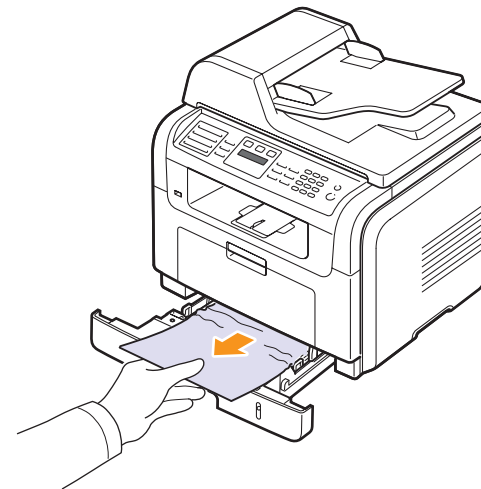

If the paper does not move when you pull, or if you do not see the paper in this area, check the fuser area around the toner cartridge. See page 14.3.

- 4 Insert the tray 1 into the machine until it snaps into place. Printing automatically resumes.

In the optional tray 2

- 1 Pull the optional tray 2 open.
- 2 Remove the jammed paper from the machine.

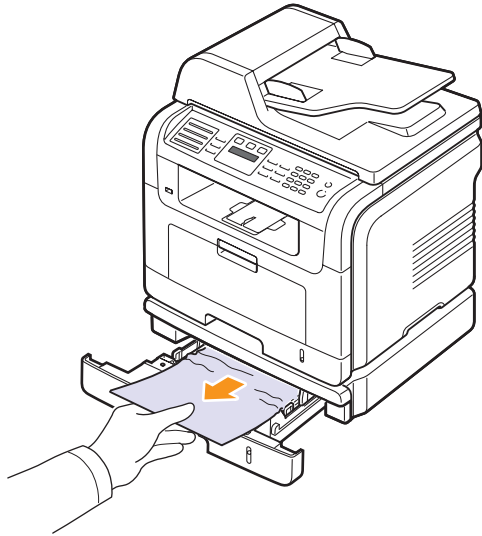

If the paper does not move when you pull, or if you do not see the paper in this area, stop and go to step 3.

- 3 Pull the tray 1 half.
- 4 Pull the paper straight up and out.

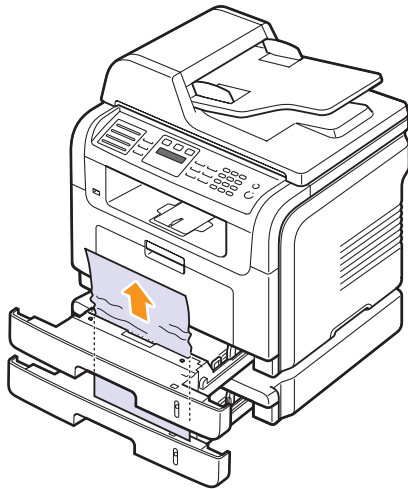

- 5 Insert the trays back into the machine. Printing automatically resumes.

In the multi-purpose tray

- 1 If the paper is not feeding properly, pull the paper out of the machine.

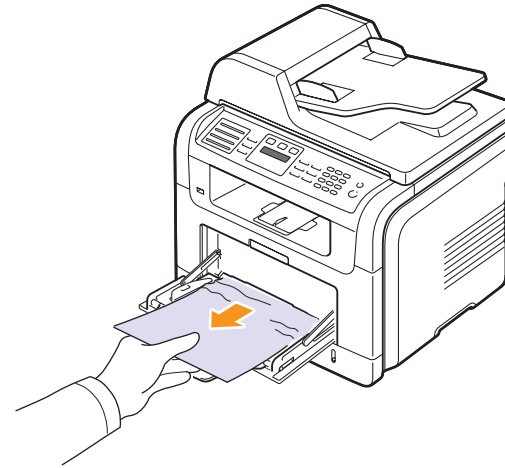

- 2 Open and close the front cover to resume printing.

In the fuser area or around the toner cartridge



Note

The fuser area is hot. Take care when removing paper from the machine.

- 1 Open the front cover and pull the toner cartridge out, lightly pushing it down.

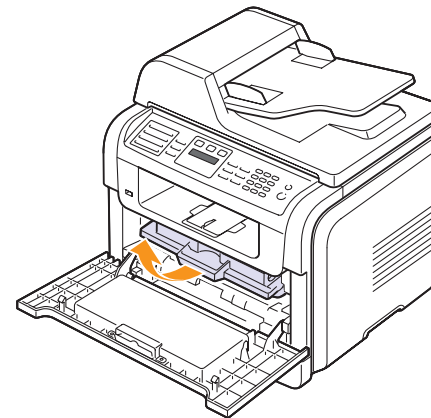

- 2 Remove the jammed paper by gently pulling it straight out.

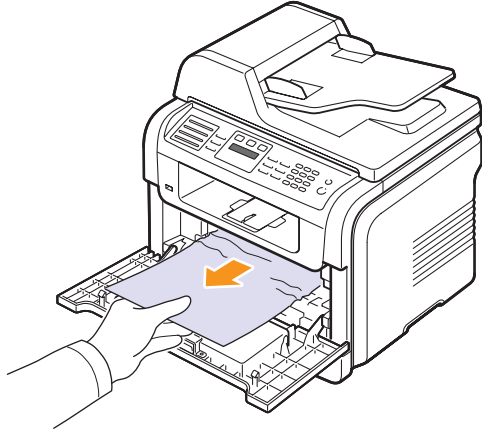

- 3 Replace the toner cartridge and close the front cover. Printing automatically resumes.

In the paper exit area

- 1 Open and close the front cover. The jammed paper is automatically ejected from the machine.
- 2 Gently pull the paper out of the output tray.

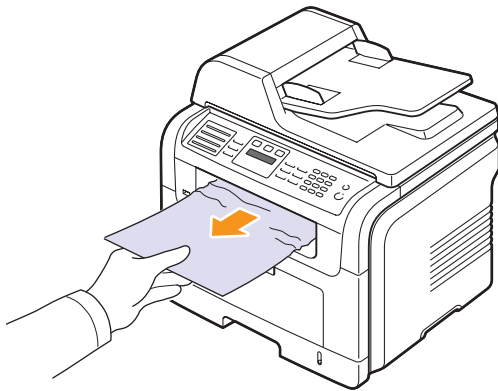

If you do not see the jammed paper or if there is any resistance when you pull, stop and go to the next step.

- 3 Open the rear cover.

- 4 If you see the jammed paper, push the pressure lever on each side up and remove the paper. Skip to step 9.

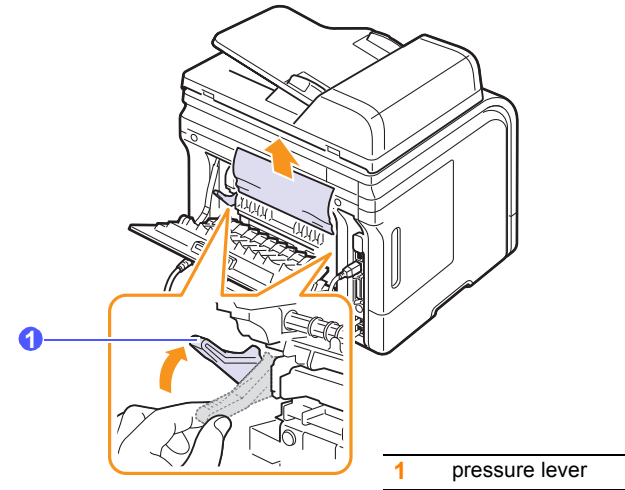

If you still do not see the paper, go to the next step.

- 5 Release the white strip, the rear cover stopper, and fully open the rear cover, as shown.

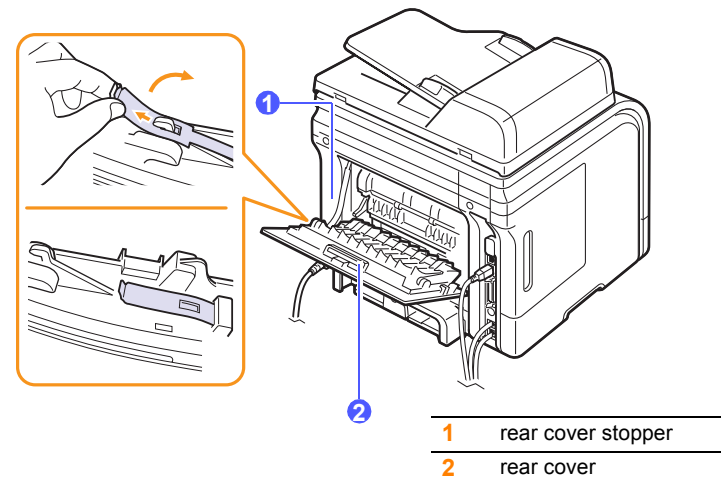

- 6 Unfold the duplex guide fully.

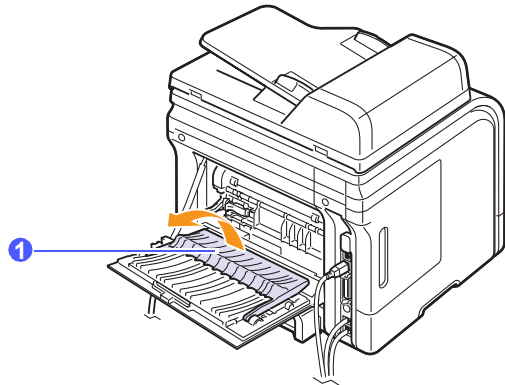

1 duplex guide

- 7 While pushing the fuser lever to the right, open the fuser door.

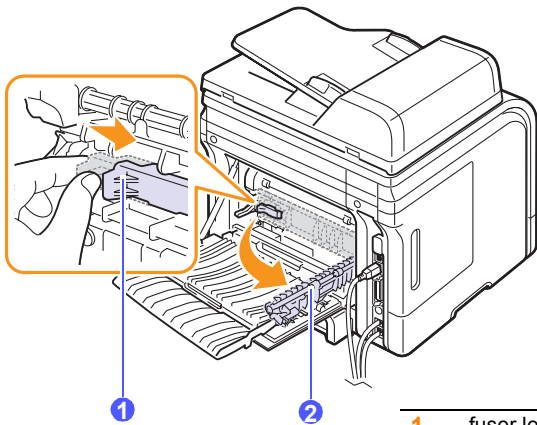

1 fuser lever

2 fuser door

- 8 Pull the jammed paper out.

If the jammed paper does not move when you pull, push the pressure lever on each side up to loose the paper, and then remove it.

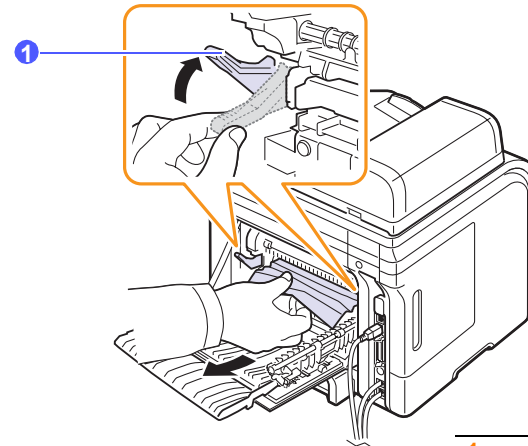

1 pressure lever

- 9 Return the lever, door, stopper, and guide to their original position.

- 10 Close the rear cover. Printing automatically resumes.

In the duplex unit area (SCX-5530FN only)

If the duplex unit is not inserted correctly, paper jam may occur. Make sure that the duplex unit is inserted correctly.

Duplex Jam 0

- 1 Pull the duplex unit out of the machine.

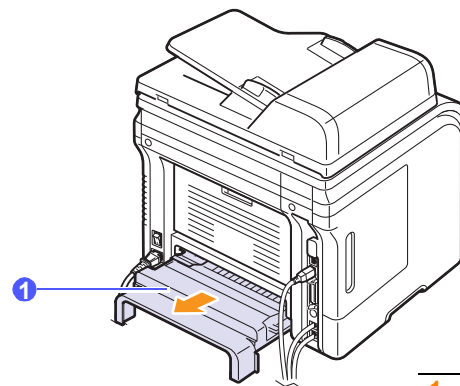

1 duplex unit

- 2 Remove the jammed paper from the duplex unit.

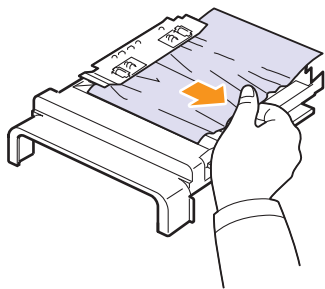

If the paper does not come out with the duplex unit, remove the paper from the bottom of the machine.

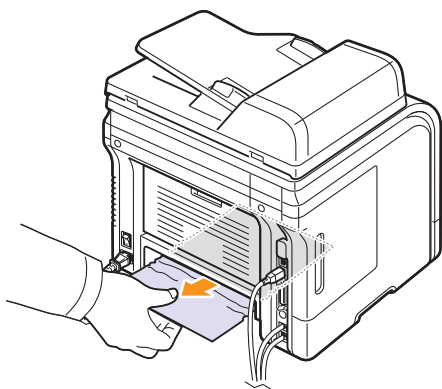

Duplex Jam 1

- 1 Open the rear cover.
- 2 Unfold the duplex guide fully.

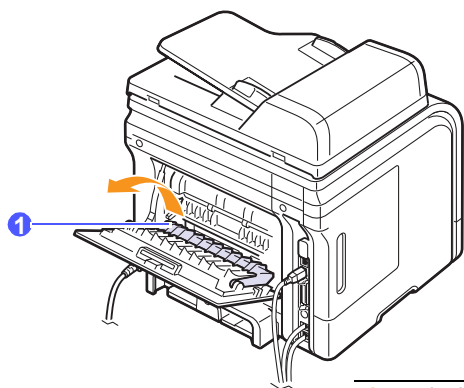

1 duplex guide

- 3 Pull the jammed paper out.

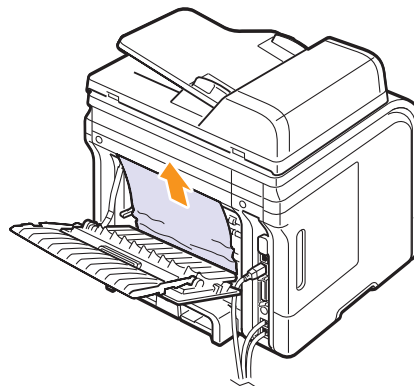

Tips for avoiding paper jams

By selecting the correct media types, most paper jams can be avoided. When a paper jam occurs, follow the steps outlined on page 14.2.

- Follow the procedures on page 5.5. Ensure that the adjustable guides are positioned correctly.
- Do not overload the tray. Ensure that the paper level is below the paper capacity mark on the inside wall of the tray.
- Do not remove paper from the tray while your machine is printing.
- Flex, fan, and straighten paper before loading.
- Do not use creased, damp, or highly curled paper.
- Do not mix paper types in a tray.
- Use only recommended print media. See page 5.8.
- Ensure that the recommended print side of print media is facing down in the tray, or facing up in the multi-purpose tray.
- If paper jams occur frequently when you print on A5-sized paper:
Load the paper into the tray with the long edge facing the front of the tray.

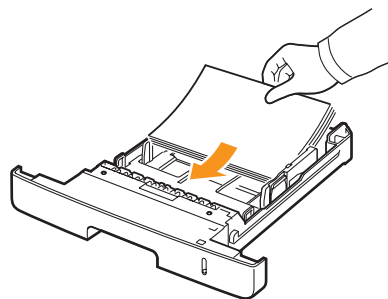

In the printer properties window, set the page orientation to be rotated 90 degrees. See the **Software Section**.

Understanding display messages

Messages appear on the Smart Panel program window or the control panel display to indicate the machine's status or errors. Refer to the tables below to understand the messages' meaning and correct the problem if necessary. Messages and their meanings are listed in alphabetical order.



Note

When you call for service, it is very convenient to tell the service representative the display message.

Messages in the colored cells are available only with SCX-5530FN.

Message	Meaning	Suggested solutions
Authentication Failure	The ID or password you entered is incorrect.	Enter the correct ID or password.
Cancel? ◀ Yes ▶	Your machine's memory has become full while trying to store an original into memory.	To cancel the fax job, press the OK button to accept Yes . If you want to send those pages that have been successfully stored, press the OK button to accept No . You should send the remaining pages later, when memory is available.
[COMM. Error]	The machine has a communication problem.	Ask the sender to try again.
Connection Error	Connection with the SMTP server failed.	Check the server settings and the network cable.
Connection Failed	The protocol you have entered is not supported or server port is wrong.	Check the protocol or server port.
Data Read Fail Check USB Mem.	Time expired while reading data.	Try again.
Data Write Fail Check USB Mem.	Storing to the USB memory failed.	Check the available USB memory space.
Document Jam	The loaded original has jammed in the ADF.	Clear the jam. See page 14.1.
Door Open	The front cover or rear cover is not securely latched.	Close the cover until it locks into place.

Message	Meaning	Suggested solutions
Duplex Jam 0 Check Inside	Paper has jammed during duplex printing.	Clear the jam. See page 14.5.
Duplex Jam 1 Open/Close Door	Paper has jammed during duplex printing.	Clear the jam. See page 14.6.
Enter Again	You entered an unavailable item.	Enter the correct item again.
File Access Denied	Login to the network server was successful. However, access to the file on the network server was denied.	Change the server settings.
File Name Exist	The file name you have entered already exists.	Enter a different file name.
File Name Over Limit	The file names you can use are from doc001 to doc999. However, all file names are used already.	Delete unnecessary files.
File Format Not Supported	The selected file format is not supported.	Use the correct file format.
Fuser Door Open	The fuser door is not securely latched.	Open the rear cover and close the fuser door until it locks into place. For the location of the fuser door, see page 14.5.
Global Address Not Found	When the device is unable to locate the given address of the Global server.	Check the search ID.
Global Query Size Exceeded	This is an error message and displays when the global query size has been exceeded.	<ul style="list-style-type: none"> • There are too many search results. Refine your search by entering more letters. • Contact a LDAP Server administrator.

Message	Meaning	Suggested solutions
Global Server Auth Failed	When there is a authentication fail while connecting to the global server this message displays.	Check the authentication account and password.
Global Server Comm. Error	This error message displays when there is a communication error between the global server and the device.	<ul style="list-style-type: none"> • Try again. • Contact a LDAP Server administrator.
Global Server Not Configured	When no global server is configured, this message displays.	Check the LDAP server configuration settings.
Global Server Not Found	When the device is unable to find the Global server.	Check the LDAP server address, The LDAP server address is incorrect, or the server has failed.
Group Not Available	You have tried to select a group location number where only a single location number can be used, such as when adding locations for a Multiple Send operation.	Use a speed dial number or dial a number manually using the number keypad.
[Incompatible]	The machine has received a fax from which is registered as a junk fax..	The received fax data will be deleted. Reconfirm junk fax setup, see page 10.2.
Invalid Server Address	The server address you have entered is invalid.	Enter the correct server address.
Line Busy	The receiving fax machine did not answer or the line is already engaged.	Try again after a few minutes.
[Line Error]	Your machine cannot connect with the receiving fax machine or has lost contact because of a problem with the phone line.	Try again. If the problem persists, wait an hour or so for the line to clear and try again. Or, turn the ECM mode on. See page 10.1.

Message	Meaning	Suggested solutions
Low Heat Error Cycle Power	There is a problem in the fuser unit.	Unplug the power cord and plug it back in. If the problem persists, please call for service.
LSU Motor Error Cycle Power	A problem has occurred in the LSU (Laser Scanning Unit).	Unplug the power cord and plug it back inches. If the problem persists, please call for service.
LSU Hsync Error Cycle Power	A problem has occurred in the LSU (Laser Scanning Unit).	Unplug the power cord and plug it back inches. If the problem persists, please call for service.
Main Motor Locked	There is a problem in the main motor.	Open and then close the front cover.
Mail Exceeds Server Support	The mail size is larger than the supported size by SMTP server.	Divide your mail or reduce the resolution.
Memory Full	The memory is full.	Delete unnecessary fax jobs and retransmit after more memory becomes available. Alternatively, split the transmission into more than one operation.
MP Tray Paper Empty	There is no paper in the multi-purpose tray.	Load paper in the multi-purpose tray. See page 5.7.
Network Error	There is a problem with the network.	Contact your network administrator.
[No Answer]	The receiving fax machine has not answered after several redial attempts.	Try again. Make sure that the receiving machine is operational.
Not Assigned	The speed button or speed dial number you tried to use has no number or email address assigned to it.	Enter the number or email address manually using the number keypad or store the number or address.
[No Paper] Add Paper	The paper in the tray has run out.	Load paper in the tray. See page 5.5.
One Page is Too Large	Single page data exceeds the configured mail size.	Reduce the resolution and try again.

Message	Meaning	Suggested solutions
Open Heat Error Cycle Power	There is a problem in the fuser unit.	Unplug the power cord and plug it back in. If the problem persists, please call for service.
Operation Not Assigned	You are in the Add Page/Cancel Job operation, but there are no jobs stored.	Check the display to see if there are any scheduled jobs.
Over Heat Error Cycle Power	There is a problem in the fuser unit.	Unplug the power cord and plug it back in. If the problem persists, please call for service.
Paper Jam 0 Open/Close Door	Paper has jammed in the feeding area of the tray.	Clear the jam. See page 14.2 and page 14.3.
Paper Jam 1 Open/Close Door	Paper has jammed in the fuser area.	Clear the jam. See page 14.3.
Paper Jam 2 Check Inside	Paper has jammed in the paper exit area.	Clear the jam. See page 14.4.
Power Failure	Power has turned off then on and the machine's memory has not been back up.	The job which you were trying to do before the power failure must be completely re-done.
Retry Redial?	The machine is waiting for a specified time interval to redial a previously busy station.	You can press OK to immediately redial, or Stop/Clear to cancel the redial operation.
Scanner locked	The scanner module is locked	Unlock the scanner and press Stop/Clear .
Self Diagnostic LSU	The LSU (Laser Scanning Unit) in your printer is checking some problems detected.	Please wait a few minutes.
Self Diagnostic Temperature	The engine in your machine is checking some problems detected.	Please wait a few minutes.
Send Error (AUTH)	There is a problem in SMTP authentication.	Configure the authentication setting.

Message	Meaning	Suggested solutions
Send Error (DNS)	There is a problem in DNS.	Configure the DNS setting.
Send Error (POP3)	There is a problem in POP3.	Configure the POP3 setting.
Send Error (SMTP)	There is a problem in SMTP.	Change to the available server.
Send Error (Wrong Config)	There is a problem on the network interface card.	Configure your network interface card correctly.
[Stop Pressed]	Stop/Clear has been pressed during a fax transmission.	Try again.
Tray 1 Paper Empty	There is no paper in the tray 1.	Load paper in the tray 1. See page 5.5.
Tray 2 Paper Empty	There is no paper in the optional tray 2.	Load paper in the optional tray 2. See page 5.5.

Toner cartridge-related messages

Message	Meaning	Suggested solutions
Install Toner	A toner cartridge is not installed.	Install a toner cartridge.
Invalid Toner	The toner cartridge you have installed is not for your printer.	Install a Samsung-genuine toner cartridge, designed for your printer.
Toner Low	The toner cartridge is almost empty.	Take out the toner cartridge and thoroughly shake it. By doing this, you can temporarily reestablish printing operations.
NonGenuine Toner ◀ Stop ▶	The toner cartridge installed is not a genuine cartridge.	<p>You can select either Stop or Continue. If you do not select any, the printer will work as Stop is selected.</p> <p>If you select Stop, you cannot print until the genuine cartridge is installed. However, you can still print any kind of reports.</p> <p>If you select Continue, you can keep printing but the quality cannot be guaranteed, and the product support is no longer provided.</p> <p>If you want to change the selection, turn the printer off and on to have this message appear again, and then re-select Stop or Continue.</p>
NonGenuine Toner Replace Toner1	The toner cartridge installed is not a genuine cartridge.	This message appears when you selected Stop at the NonGenuine Toner prompt. Install the genuine toner cartridge.
NonGenuine Toner Replace Toner	The toner cartridge installed is not a genuine cartridge.	This message appears when you selected Continue at the NonGenuine Toner prompt. Install the genuine toner cartridge.
Toner Empty Replace Toner	The toner in the cartridge has run out.	<p>Install a new genuine toner cartridge.</p> <p>You can keep printing but the quality cannot be guaranteed, and the product support is no longer provided.</p> <p>You can configure not to see the Toner Empty Replace Toner message. See page 13.6.</p>
Replace Toner	The toner in the cartridge has run out.	<p>This message appears when you turned off the Toner Empty Replace Toner message. See page 13.6.</p> <p>Install a new genuine toner cartridge.</p> <p>You can keep printing but the quality cannot be guaranteed, and the product support is no longer provided.</p>
Toner Exhausted ◀ Stop ▶	The lifespan of the toner cartridge is reached.	<p>You can select either Stop or Continue. If you do not select any, the printer will work as Stop is selected.</p> <p>If you select Stop, you cannot print until the genuine cartridge is installed.</p> <p>If you select Continue, you can keep printing but the quality cannot be guaranteed, and the product support is no longer provided.</p> <p>If you want to change the selection, turn the printer off and on to have this message appear again, and then re-select Stop or Continue.</p>
Toner Exhausted Replace Toner1	The lifespan of the toner cartridge is reached.	This message appears when you selected Stop at the Toner Exhausted prompt. Install the genuine toner cartridge.
Toner Exhausted Replace Toner	The lifespan of the toner cartridge is reached.	This message appears when you selected Continue at the Toner Exhausted prompt. Install the genuine toner cartridge.

Solving other problems

The following chart lists some conditions that may occur and the recommended solutions. Follow the suggested solutions until the problem is corrected. If the problem persists, please call for service.

Paper feeding problems

Condition	Suggested solutions
Paper is jammed during printing.	Clear the paper jam. See page 14.2.
Paper sticks together.	<ul style="list-style-type: none"> Ensure that there is not too much paper in the tray. The tray can hold up to 250 sheets of paper, depending on the thickness of your paper. Make sure that you are using the correct type of paper. See page 5.8. Remove paper from the tray and flex or fan the paper. Humid conditions may cause some paper to stick together.
Multiple sheets of paper do not feed.	<ul style="list-style-type: none"> Different types of paper may be stacked in the tray. Load paper of only one type, size, and weight. If multiple sheets have caused a paper jam, clear the paper jam. See page 14.2.
Paper does not feed into the machine.	<ul style="list-style-type: none"> Remove any obstructions from inside the machine. Paper has not been loaded correctly. Remove paper from the tray and reload it correctly. There is too much paper in the tray. Remove excess paper from the tray. The paper is too thick. Use only paper that meets the specifications required by the machine. See page 5.8. If an original does not feed into the machine, the ADF rubber pad may require to be replaced. See page 13.7.
The paper keeps jamming.	<ul style="list-style-type: none"> There is too much paper in the tray. Remove excess paper from the tray. If you are printing on special materials, use the multi-purpose tray. An incorrect type of paper is being used. Use only paper that meets the specifications required by the machine. See page 5.8. There may be debris inside the machine. Open the front cover and remove the debris. If an original does not feed into the machine, the ADF rubber pad may require to be replaced. See page 13.7.
Transparencies stick together in the paper exit.	Use only transparencies specifically designed for laser printers. Remove each transparency as it exits from the machine.
Envelopes skew or fail to feed correctly.	Ensure that the paper guides are against both sides of the envelopes.



Printing problems



Condition	Possible cause	Suggested solutions
The machine does not print.	The machine is not receiving power.	Check the power cord connections. Check the power switch and the power source.
	The machine is not selected as the default printer.	Select Samsung SCX-5x30 Series PCL 6 as your default printer in your Windows.
	Check the machine for the following: <ul style="list-style-type: none"> The front cover is not closed. Close the cover. Paper is jammed. Clear the paper jam. See page 14.2. No paper is loaded. Load paper. See page 5.5. The toner cartridge is not installed. Install the toner cartridge. If a system error occurs, contact your service representative.	
	The connection cable between the computer and the machine is not connected properly.	Disconnect the printer cable and reconnect it.
	The connection cable between the computer and the machine is defective.	If possible, attach the cable to another computer that is working properly and print a job. You can also try using a different printer cable.
	The port setting is incorrect.	Check the Windows printer setting to make sure that the print job is sent to the correct port. If the computer has more than one port, make sure that the machine is attached to the correct one.
	The machine may be configured incorrectly.	Check the printer properties to ensure that all of the print settings are correct.
	The printer driver may be incorrectly installed.	Repair the printer software. See the Software Section .
	The machine is malfunctioning.	Check the display message on the control panel to see if the machine is indicating a system error.

Condition	Possible cause	Suggested solutions
The machine selects print materials from the wrong paper source.	The paper source selection in the printer properties may be incorrect.	For many software applications, the paper source selection is found under the Paper tab within the printer properties. Select the correct paper source. See the printer driver help screen.
A print job is extremely slow.	The job may be very complex.	Reduce the complexity of the page or try adjusting the print quality settings.
	If you are using Windows 98/Me, the Spool Setting may be set incorrectly.	From the Start menu, choose Settings and then Printers . Right-click the Samsung SCX-5x30 Series PCL 6 machine icon, choose Properties , click the Details tab, and then choose the Spool Settings button. Select the desired spool setting.
Half the page is blank.	The page orientation setting may be incorrect.	Change the page orientation in your application. See the printer driver help screen.
	The paper size and the paper size settings do not match.	Ensure that the paper size in the printer driver settings matches the paper in the tray. Or, ensure that the paper size in the printer driver settings matches the paper selection in the software application settings you use.
The machine prints, but the text is wrong, garbled, or incomplete.	The printer cable is loose or defective.	Disconnect the printer cable and reconnect. Try a print job that you have already printed successfully. If possible, attach the cable and the machine to another computer and try a print job that you know works. Finally, try a new printer cable.
	The wrong printer driver was selected.	Check the application's printer selection menu to ensure that your machine is selected.
	The software application is malfunctioning.	Try printing a job from another application.
	The operating system is malfunctioning.	Exit Windows and reboot the computer. Turn the machine off and then back on again.

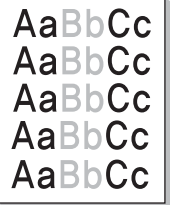
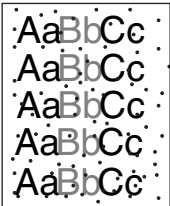

Condition	Possible cause	Suggested solutions
Pages print, but are blank.	The toner cartridge is defective or out of toner.	Redistribute the toner, if necessary. See page 13.4. If necessary, replace the toner cartridge.
	The file may have blank pages.	Check the file to ensure that it does not contain blank pages.
	Some parts, such as the controller or the board, may be defective.	Contact a service representative.
The illustrations print incorrectly in Adobe Illustrator.	The setting in the software application is wrong.	Select Download as Bit Image in the TrueType Options window of the graphic properties and print the document again.
The printer does not print PDF file correctly. Some parts of graphics, text, or illustrations are missing.		Incompatibility between the PDF file and the Acrobat products: Printing the PDF file as an image may solve this problem. Turn on Print As Image from the Acrobat printing options. NOTE: It will take longer to print when you print a PDF file as an image.

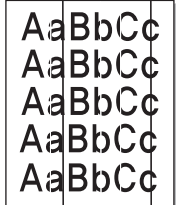
If the inside of the machine is dirty or paper has been loaded improperly, you may notice a reduction in print quality. See the table below to clear the problem.

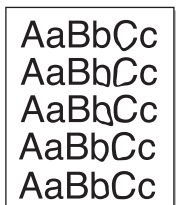
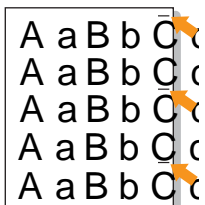
Condition	Suggested solutions
Light or faded print 	<p>If a vertical white streak or faded area appears on the page:</p> <ul style="list-style-type: none"> The toner supply is low. You may be able to temporarily extend the toner cartridge life. See page 13.4. If this does not improve the print quality, install a new toner cartridge. The paper may not meet paper specifications; for example, the paper is too moist or too rough. See page 5.8. If the entire page is light, the print resolution setting is too low or the toner save mode is on. Adjust the print resolution and turn the toner save mode off. See the help screen of the printer driver and page 2.4, respectively. A combination of faded or smeared defects may indicate that the toner cartridge needs cleaning. See page 13.5. The surface of the LSU part inside the machine may be dirty. Clean the LSU. See page 13.2.
Toner specks 	<ul style="list-style-type: none"> The paper may not meet specifications; for example, the paper is too moist or too rough. See page 5.8. The transfer roller may be dirty. Clean the inside of your machine. See page 13.2. The paper path may need cleaning. See page 13.2.
Dropouts 	<p>If faded areas, generally rounded, occur randomly on the page:</p> <ul style="list-style-type: none"> A single sheet of paper may be defective. Try reprinting the job. The moisture content of the paper is uneven or the paper has moist spots on its surface. Try a different brand of paper. See page 5.8. The paper lot is bad. The manufacturing processes can cause some areas to reject toner. Try a different kind or brand of paper. If these steps do not correct the problem, contact a service representative.

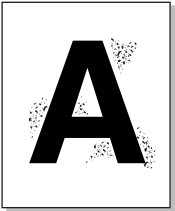
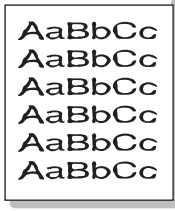
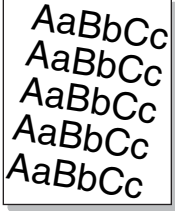
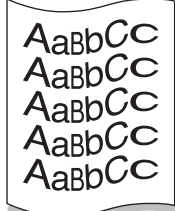
Condition	Suggested solutions
Vertical lines 	<p>If black vertical streaks appear on the page:</p> <ul style="list-style-type: none"> The drum inside the toner cartridge has probably been scratched. Remove the toner cartridge and install a new one. See page 13.5. <p>If white vertical streaks appear on the page:</p> <ul style="list-style-type: none"> The surface of the LSU part inside the machine may be dirty. Clean the LSU. See page 13.2.
Gray background 	<p>If the amount of background shading becomes unacceptable:</p> <ul style="list-style-type: none"> Change to a lighter weight paper. See page 5.8. Check the machine's environment: very dry (low humidity) or high humidity (higher than 80% RH) conditions can increase the amount of background shading. Remove the old toner cartridge and install a new one. See page 13.5.
Toner smear 	<ul style="list-style-type: none"> Clean the inside of the machine. See page 13.2. Check the paper type and quality. See page 5.8. Remove the toner cartridge and install a new one. See page 13.5.
Vertical repetitive defects 	<p>If marks repeatedly appear on the printed side of the page at even intervals:</p> <ul style="list-style-type: none"> The toner cartridge may be damaged. If a repetitive mark occurs on the page, print a cleaning sheet several times to clean the cartridge; see page 13.5. After the printout, if you still have the same problems, remove the toner cartridge and install a new one. See page 13.5. Parts of the machine may have toner on them. If the defects occur on the back of the page, the problem will likely correct itself after a few more pages. The fusing assembly may be damaged. Contact a service representative.

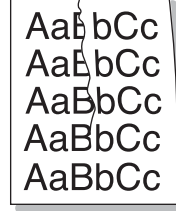
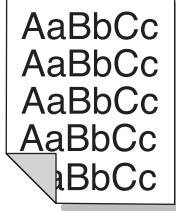
Condition	Suggested solutions
Background scatter 	<p>Background scatter results from bits of toner randomly distributed on the printed page.</p> <ul style="list-style-type: none"> The paper may be too damp. Try printing with a different batch of paper. Do not open packages of paper until necessary so that the paper does not absorb too much moisture. If background scatter occurs on an envelope, change the printing layout to avoid printing over areas that have overlapping seams on the reverse side. Printing on seams can cause problems. If background scatter covers the entire surface area of a printed page, adjust the print resolution through your software application or the printer properties.
Misformed characters 	<ul style="list-style-type: none"> If characters are improperly formed and producing hollow images, the paper stock may be too slick. Try a different paper. See page 5.8. If characters are improperly formed and producing a wavy effect, the scanner unit may need service. For service, contact a service representative.
Page skew 	<ul style="list-style-type: none"> Ensure that the paper is loaded properly. Check the paper type and quality. See page 5.8. Ensure that the paper or other material is loaded correctly and the guides are not too tight or too loose against the paper stack.
Curl or wave 	<ul style="list-style-type: none"> Ensure that the paper is loaded properly. Check the paper type and quality. Both high temperature and humidity can cause paper curl. See page 5.8. Turn over the stack of paper in the tray. Also try rotating the paper 180° in the tray. Try printing to the rear cover.

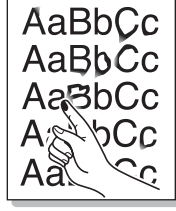
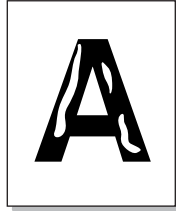
Condition	Suggested solutions
Wrinkles or creases 	<ul style="list-style-type: none"> Ensure that the paper is loaded properly. Check the paper type and quality. See page 5.8. Turn over the stack of paper in the tray. Also try rotating the paper 180° in the tray. Try printing to the rear cover.
Back of printouts are dirty 	<p>Check for leaking toner. Clean the inside of the machine. See page 13.2.</p>
Black pages 	<ul style="list-style-type: none"> The toner cartridge may not be installed properly. Remove the cartridge and reinsert it. The toner cartridge may be defective and need replacing. Remove the toner cartridge and install a new one. See page 13.5. The machine may require repair. Contact a service representative.
Loose toner 	<ul style="list-style-type: none"> Clean the inside of the machine. See page 13.2. Check the paper type and quality. See page 5.8. Remove the toner cartridge and install a new one. See page 13.5. If the problem persists, the machine may require repair. Contact a service representative.
Character Voids 	<p>Character voids are white areas within parts of characters that should be solid black:</p> <ul style="list-style-type: none"> If you are using transparencies, try another type of transparency. Because of the composition of transparencies, some character voids are normal. You may be printing on the wrong surface of the paper. Remove the paper and turn it around. The paper may not meet paper specifications. See page 5.8.

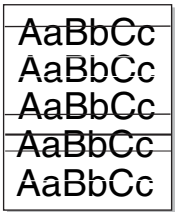
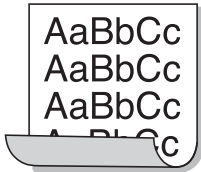
Condition	Suggested solutions
Horizontal stripes 	<p>If horizontally aligned black streaks or smears appear:</p> <ul style="list-style-type: none"> The toner cartridge may be installed improperly. Remove the cartridge and reinsert it. The toner cartridge may be defective. Remove the toner cartridge and install a new one. See page 13.5. If the problem persists, the machine may require repair. Contact a service representative.
Curl 	<p>If the printed paper is curled or paper does not feed into the machine:</p> <ul style="list-style-type: none"> Turn over the stack of paper in the tray. Also try rotating the paper 180° in the tray. Try printing to the rear cover.
<p>An unknown image repetitively appears on a next few sheets or loose toner, light print, or contamination occurs.</p>	<p>Your printer is probably being used at an altitude of 2,500 m (8,200 ft) or above. The high altitude may affect the print quality such as loose toner or light imaging. You can set this option through Printer Settings Utility or Printer tab in printer driver's properties. Refer to the Software Section for details.</p>

Copying problems

Condition	Suggested solutions
Copies are too light or too dark.	Use Darkness to darken or lighten the background of the copies.
Smears, lines, marks, or spots appears on copies.	<ul style="list-style-type: none"> If defects are on the original, press Darkness to lighten the background of your copies. If no defects are on the original, clean the scan unit. See page 13.3.
Copy image is skewed.	<ul style="list-style-type: none"> Ensure that the original is face down on the scanner glass or face up in the ADF. Check that the copy paper is loaded correctly.
Blank copies print out.	Ensure that the original is face down on the scanner glass or face up in the ADF.
Image rubs off the copy easily.	<ul style="list-style-type: none"> Replace the paper in the tray with paper from a new package. In high humidity areas, do not leave paper in the machine for extended periods of time.
Frequent copy paper jams occur.	<ul style="list-style-type: none"> Fan the stack of paper, then turn it over in the tray. Replace the paper in the tray with a fresh supply. Check/adjust the paper guides, if necessary. Ensure that the paper is the proper paper weight. 75 g/m² bond paper is recommended. Check for copy paper or pieces of copy paper remaining in the machine after a paper jam has been cleared.
Toner cartridge produces fewer copies than expected before running out of toner.	<ul style="list-style-type: none"> Your originals may contain pictures, solids, or heavy lines. For example, your originals may be forms, newsletters, books, or other documents that use more toner. The machine may be turned on and off frequently. The scanner lid may be left open while copies are being made.

Scanning problems

Condition	Suggested solutions
The scanner does not work.	<ul style="list-style-type: none"> • Make sure that you place the original to be scanned face down on the scanner glass, or face up in the ADF. • There may not be enough available memory to hold the document you want to scan. Try the Prescan function to see if that works. Try lowering the scan resolution rate. • Check that the USB or parallel cable is connected properly. • Make sure that the USB or parallel cable is not defective. Switch the cable with a known good cable. If necessary, replace the cable. • If you are using a parallel cable, ensure that it is compliant with IEEE 1284 standards. • Check that the scanner is configured correctly. Check scan setting in the SmarThru Configuration or the application you want to use to make certain that the scanner job is being sent to the correct port.
The unit scans very slowly.	<ul style="list-style-type: none"> • Check if the machine is printing received data. If so, scan the document after the received data has been printed. • Graphics are scanned more slowly than text. • Communication speed slows in scan mode because of the large amount of memory required to analyze and reproduce the scanned image. Set your computer to the ECP printer mode through BIOS setting. It will help to increase the speed. For details about how to set BIOS, refer to your computer user's guide.

Condition	Suggested solutions
<p>Message appears on your computer screen:</p> <ul style="list-style-type: none"> • "Device can't be set to the H/W mode you want." • "Port is being used by another program." • "Port is Disabled." • "Scanner is busy receiving or printing data. When the current job is completed, try again." • "Invalid handle." • "Scanning has failed." 	<ul style="list-style-type: none"> • There may be a copying or printing job in progress. When that job is complete, try your job again. • The Selected port is currently being used. Restart your computer and try again. • The printer cable may be improperly connected or the power may be off. You must use a parallel cable that supports IEEE 1284 bi-directional communications. • The scanner driver is not installed or the operating environment is not set up properly. • Ensure that the machine is properly connected and the power is on, Then restart your computer. • The USB cable may be improperly connected or the power may be off. • Do not use parallel and USB cables at the same time.

Network Scan problems

Condition	Suggested solutions
I cannot find a scanned image file.	You can check the scanned file's destination in the Advanced page in the Network Scan program's Properties screen.
I cannot find the scanned image file after scanning.	<ul style="list-style-type: none"> • Check if the scanned file's application is on your computer. • Check Send image immediately to the specified folder using an associated default application in the Advanced page in the Network Scan program's Properties screen to open the scanned image immediately after scanning.
I forgot my ID and PIN.	Check your ID and PIN in the Server page in the Network Scan program's Properties screen.
I cannot view the Help file.	To view the Help file, you need to have Internet Explorer 4 service pack 2 or above.
I cannot use the Samsung Network Scan Manager	Check your operating system. Supporting operating systems are Windows 98/Me/NT 4.0/2000/XP/2003.

Fax problems (SCX-5530FN only)

Condition	Suggested solutions
The machine is not working, there is no display and the buttons are not working.	<ul style="list-style-type: none"> • Unplug the power cord and plug it in again. • Ensure that there is power to the electrical outlet.
No dial tone sounds.	<ul style="list-style-type: none"> • Check that the phone line is connected properly. • Check that the phone socket in the wall is working by plugging in another phone.
The numbers stored in memory do not dial correctly.	Make sure that the numbers are stored in memory correctly. Print a Phone Book list, referring to page 10.4.
The original does not feed into the machine.	<ul style="list-style-type: none"> • Make sure that the paper is not wrinkled and you are putting it in correctly. Check that the original is the right size, not too thick or thin • Make sure that the ADF is firmly closed. • The ADF rubber pad may need to be replaced. See page 13.7.

Condition	Suggested solutions
Faxes are not received automatically.	<ul style="list-style-type: none"> • The receiving mode should be set to Fax. • Make sure that there is paper in the tray. • Check to see if the display shows any error message. If it does, clear the problem.
The machine does not send.	<ul style="list-style-type: none"> • Make sure that the original is loaded in the ADF or on the scanner glass. • Sending should show up on the display. • Check the fax machine you are sending to, to see if it can receive your fax.
The incoming fax has blank spaces or is of poor-quality.	<ul style="list-style-type: none"> • The fax machine sending you the fax may be faulty. • A noisy phone line can cause line errors. • Check your machine by making a copy. • The toner cartridge may be empty. Replace the toner cartridge, referring to page 13.5.
Some of the words on an incoming fax are stretched.	The fax machine sending you the fax had a temporary document jam.
There are lines on the originals you send.	Check your scan unit for marks and clean it. See page 13.3.
The machine dials a number, but a connection with the other fax machine fails.	The other fax machine may be turned off, out of paper, or cannot answer incoming calls. Speak with the other machine operator and ask her/him to sort out the problem.
Faxes do not store in memory.	There may not be enough memory space to store the fax. If the display shows the Memory Full message, delete from memory any faxes you no longer need and then try again to store the fax.
Blank areas appear at the bottom of each page or on other pages, with a small strip of text at the top.	You may have chosen the wrong paper settings in the user option setting. For details about paper settings, see page 5.8.

Common Windows problems

Condition	Suggested solutions
"File in Use" message appears during installation.	Exit all software applications. Remove all software from the StartUp Group, then restart Windows. Reinstall the printer driver.
"Error Writing to LPTx" message appears.	<ul style="list-style-type: none"> • Ensure that the cables are connected correctly, the machine is on. • If bi-directional communication is not turned on in the driver, it will also cause this message.
"General Protection Fault", "Exception OE", "Spool32", or "Illegal Operation" messages appear.	Close all other applications, reboot Windows and try printing again.
"Fail To Print", "A printer timeout error occurred." messages appear.	These messages may appear during printing. Just keep waiting until the machine finishes printing. If the message appears in standby mode or after printing has been completed, check the connection and/or whether an error has occurred.



Note

Refer to Microsoft Windows 98/Me/NT 4.0/2000/XP User's Guide that came with your PC for further information on Windows error messages.

Common PostScript problems (SCX-5530FN only)

The following situations are PS language specific and may occur when several printer languages are being used.



Note

To receive a printed or screen-displayed message when PostScript errors occur, open the Print Options window and click the desired selection next to the PostScript errors section.

Problem	Possible Cause	Solution
PostScript file cannot be printed.	The PostScript driver may not be installed correctly.	<ul style="list-style-type: none"> • Install the PostScript driver, referring to the Software Section. • Print a configuration page and verify that the PS version is available for printing. • If the problem persists, contact a service representative.
"Limit Check Error" message appears.	The print job was too complex.	You might need to reduce the complexity of the page or install more memory.
A PostScript error page prints.	The print job may not be PostScript.	Make sure that the print job is a PostScript job. Check to see whether the software application expected a setup or PostScript header file to be sent to the machine.
The optional tray 2 is not selected in the driver.	The printer driver has not been configured to recognize the optional tray 2.	Open the PostScript driver properties, select the Device Settings tab, and set the Tray2 option of the Installable Options section to Installed .
When print a document in Macintosh with Acrobat Reader 6.0 or higher, colors print incorrectly.	The resolution setting in the printer driver may not be matched with that in Acrobat Reader.	Make sure that the resolution setting in your printer driver matches that in Acrobat Reader.

Common Linux problems

Problem	Possible Cause and Solution
The machine does not print	<ul style="list-style-type: none"> • Check if the printer driver is installed in your system. Open Unified Driver configurator and switch to the Printers tab in Printers configuration window to look at the list of available printers. Make sure that your machine is displayed on the list. If not, please, invoke Add new printer wizard to set up your device. • Check if the printer is started. Open Printers configuration and select your machine on the printers list. Look at the description in the Selected printer pane. If its status contains "(stopped)" string, please, press the Start button. After that normal operation of the printer should be restored. The "stopped" status might be activated when some problems in printing occurred. For instance, this could be an attempt to print document when port is claimed by a scanning application. • Check if the port is not busy. Since functional components of MFP (printer and scanner) share the same I/O interface (port), the situation of simultaneous access of different "consumer" application to the same port is possible. To avoid possible conflicts, only one of them at a time is allowed to gain control over the device. The other "consumer" will encounter "device busy" response. You should open ports configuration and select the port assigned to your printer. In the Selected port pane you can see if the port is occupied by some other application. If this is the case, you should wait for completion of the current job or should press Release port button, if you are sure that the present owner is not functioning properly. • Check if your application has special print option such as "-oraw". If "-oraw" is specified in the command line parameter then remove it to print properly. For Gimp front-end, select "print" -> "Setup printer" and edit command line parameter in the command item.

Problem	Possible Cause and Solution
The machine does not appear on the scanners list	<ul style="list-style-type: none"> • Check if your machine is attached to your computer. Make sure that it is connected properly via the USB port and is turned on. • Check if the scanner driver for your machine is installed in your system. Open Unified Driver configurator, switch to Scanners configuration, then press Drivers. Make sure that driver with a name corresponding to your machine's name is listed in the window. Check if the port is not busy. Since functional components of MFP (printer and scanner) share the same I/O interface (port), the situation of simultaneous access of different "consumer" application to the same port is possible. To avoid possible conflicts, only one of them at a time is allowed to gain control over the device. The other "consumer" will encounter "device busy" response. This can usually happen while starting scan procedure, and appropriate message box appears. • To identify the source of the problem, you should open ports configuration and select the port assigned to your scanner. port's symbol /dev/mfp0 corresponds to LP:0 designation displayed in the scanners' options, /dev/mfp1 relates to LP:1 and so on. USB ports start at /dev/mfp4, so scanner on USB:0 relates to /dev/mfp4 respectively and so forth sequentially. In the Selected port pane you can see if the port is occupied by some other application. If this is the case, you should wait for completion of the current job or should press Release port button, if you are sure that the present port's owner is not functioning properly.

Problem	Possible Cause and Solution
The machine does not scan	<ul style="list-style-type: none"> • Check if a document is loaded into the machine. • Check if your machine is connected to the computer. Make sure if it is connected properly if I/O error is reported while scanning. • Check if the port is not busy. Since functional components of MFP (printer and scanner) share the same I/O interface (port), the situation of simultaneous access of different “consumer” application to the same port is possible. To avoid possible conflicts, only one of them at a time is allowed to gain control over the device. The other “consumer” will encounter “device busy” response. This can usually happen while starting scan procedure, and appropriate message box will be displayed. To identify the source of the problem, you should open ports configuration and select the port assigned to your scanner. port’s symbol /dev/mfp0 corresponds to LP:0 designation displayed in the scanners’ options, /dev/mfp1 relates to LP:1 and so on. USB ports start at /dev/mfp4, so scanner on USB:0 relates to /dev/mfp4 respectively and so forth sequentially. In the Selected port pane you can see if the port is occupied by some other application. If this is the case, you should wait for completion of the current job or should press Release port button, if you are sure that the present port’s owner is not functioning properly.
I cannot scan via Gimp Front-end.	<ul style="list-style-type: none"> • Check if Gimp Front-end has “Xsane: Device dialog.” on the “Acquire” menu. If not, you should install Xsane plug-in for Gimp on the your computer. You can find Xsane plug-in package for Gimp on Linux distribution CD or Gimp home page. For the detail information, refer to the Help for Linux distribution CD or Gimp Front-end application. If you wish to use other kind of scan application, refer to the Help for application.

Problem	Possible Cause and Solution
I encounter error “Cannot open port device file” when printing a document.	Please avoid changing print job parameters (via LPR GUI, for example) while a print job is in progress. Known versions of CUPS server break the print job whenever print options are changed and then try to restart the job from the beginning. Since Unified Linux Driver locks port while printing, the abrupt termination of the driver keeps the port locked and therefore unavailable for subsequent print jobs. If this situation occurred, please, try to release the port.

Common Macintosh problems (SCX-5530FN only)

Problem	Suggested solutions
The document has printed, but the print job has not disappeared from the spooler in Mac OS 10.3.2.	Update your Mac OS to OS 10.3.3. or higher.

15 Installing accessories

Your machine is a full-featured one that has been optimized to meet most of your printing needs. Recognizing that each user may have different requirements, however, Samsung makes several accessories available to enhance your machine's capabilities.

This chapter includes:

- **Precautions when installing accessories**
- **Installing a memory DIMM**

Precautions when installing accessories

Disconnect the power cord

Never remove the control board cover while the power is being supplied.

To avoid the possibility of an electrical shock, always disconnect the power cord when installing or removing ANY internal or external accessories.

Discharge static electricity

The control board and internal accessories (network interface card or memory DIMM) are sensitive to static electricity. Before installing or removing an internal accessories, discharge static electricity from your body by touching something metal, such as the metal back plate on any device plugged into a grounded power source. If you walk round before finishing installation, discharge any static electricity once again.

Installing a memory DIMM

Your machine has a dual in-line memory module (DIMM) slot. Use this DIMM slot to install additional memory.

The SCX-5330N has 64 MB of memory and the SCX-5530FN has 96 MB of memory. Both can be expanded to 320 MB. However, SCX-5530FN users must remove the preinstalled memory DIMM before upgrading the memory.

For order information for optional memory DIMMs, see page 12.1.

- 1 Turn the machine off and unplug all cables from the machine.

- 2 Grasp the control board cover and slide toward you to open it.

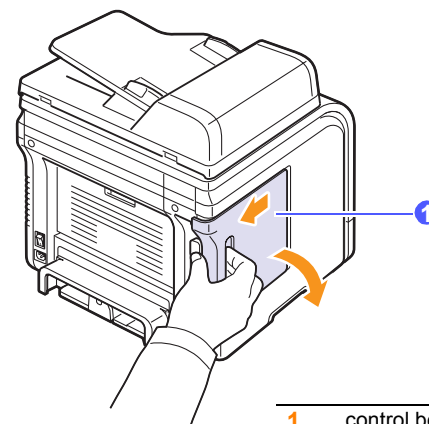

1 control board cover

- 3 Completely open the latch on each side of the DIMM slot. If you are using an SCX-5530FN, remove the preinstalled memory DIMM.

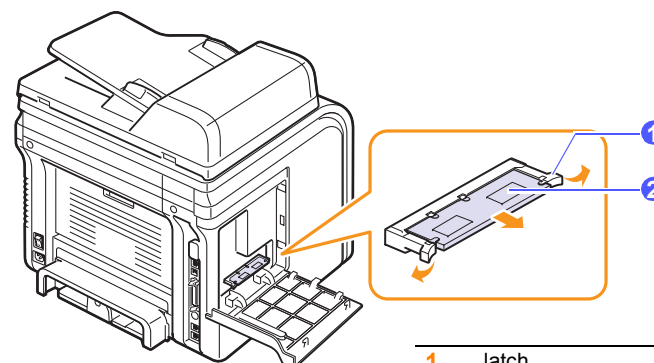

1 latch
2 memory DIMM

- 4 Take out a new memory DIMM from the plastic bag.
- 5 Holding the memory DIMM by the edges, align the notches on the memory DIMM with the grooves on the memory DIMM slot.

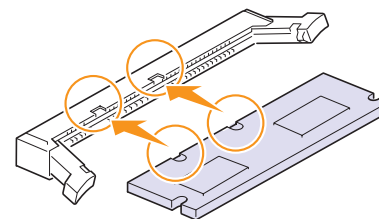

Note

The notches and grooves illustrated above may not match those on an actual DIMM and the slot.

- 6 Push the DIMM straight into the DIMM slot until it snaps into place. Make sure the latches fit over the notches located on either side of the DIMM.

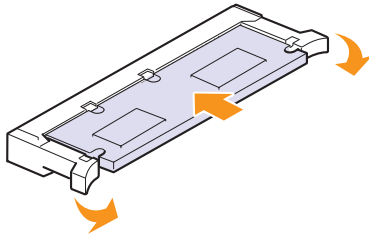

- 7 Replace the control board cover.

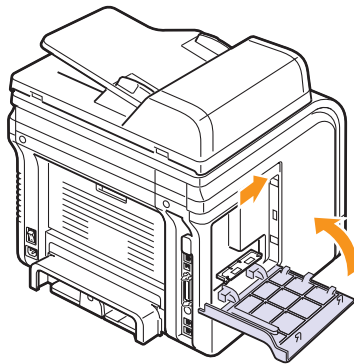

- 8 Reconnect the power cord and printer cable, and turn the machine on.

Activating the added memory in the PS printer properties (SCX-5530FN only)

After installing the memory DIMM, you need to select it in the printer properties of the PostScript printer driver so that you can use it.

- 1 Make sure that the PostScript printer driver is installed on your computer. For details about installing the PS printer driver, see the **Software Section**.
- 2 Click the Windows **Start** menu.
- 3 For Windows 98/Me/NT 4.0/2000, select **Settings** and then **Printers**.
For Windows XP, select **Printers and Faxes**.
- 4 Select the **Samsung SCX-5x30 Series** PS printer.
- 5 Click the right mouse button on the machine icon and select **Properties**.
- 6 For Windows 98/Me, select **Device Options**.
For Windows NT 4.0/2000/XP, select **Device Settings**.
- 7 Select the amount of memory you installed from **Printer Memory** in the **Installable Options** section.
For Windows 98, select **Installable Options** → **VMOption** → **change setting for:VMOption** → **change memory**.
- 8 Click **OK**.

16 Specifications

This chapter includes:

- **General specifications**
- **Scanner and copier specifications**
- **Printer specifications**
- **Facsimile specifications (SCX-5530FN only)**

General specifications

Item	Description
ADF	Up to 50 sheets (75 g/m ²)
ADF document size	Width: 142 to 216 mm Length: 148 to 356 mm
Paper input capacity	Tray 1/2: 250 multi-pages for plain paper (75 g/m ²) Multi-purpose tray: 50 pages for plain paper, 5 pages for card stock, labels, transparencies, and envelopes (60 to 163 g/m ²)
Paper output capacity	Output tray: 150 sheets (face down) Rear cover: 1 sheet (face up)
Consumables	1-piece toner cartridge system
Power rating	110 - 127 VAC, 50/60 Hz, 6.4 A 220 - 240 VAC, 50/60 Hz, 3.2 A
Power consumption	Average: Less than 520 W Power save mode: Less than 20 W
Noise level ^a	Standby mode: Less than 39 dBA Printing: Less than 54 dBA Copying mode: Less than 55 dBA Warm up: Less than 49 dBA
Warm-up time	Less than 20 seconds (from sleep mode)
Operating environment	Temperature: 10 °C to 32 °C Humidity: 20% to 80% RH
Display	16 characters x 2 lines
Toner cartridge life ^b	4,000 or 8,000 pages at ISO 19752 5% coverage
Memory	SCX-5330N: 64 MB (max. 320 MB) SCX-5530FN: 96 MB (max. 320 MB)

Item	Description
External dimension (W x D x H)	466 x 435.4 x 458 mm (18.3 x 17.1 x 18 in)
Weight (including consumables)	SCX-5330N : 18.1 Kg (39.9 lb) SCX-5530FN : 18.9 Kg (41.6 lb)
Package weight	Paper: 2.8 Kg (6.17 lb) Plastic: 0.7 Kg (1.54 lb)
Duty cycle	Monthly print: Up to 25,000 pages

a. Sound Pressure Level, ISO 7779

b. The number of pages may be affected by operating environment, printing interval, media type, and media size.

Printer specifications

Item	Description
Printing method	Laser Beam Printing
Printing speed ^a	Up to 28 ppm in A4 (30 ppm in Letter)
Duplex printing speed ^b	Up to 19 ipm in A4 (21 ipm in Letter)
First print out time	8,5 seconds (from ready)
Print resolution	Up to 1,200 x 1,200 dpi effective output
Printer language	PCL 6, PS 3 (SCX-5530FN only)
OS Compatibility ^c	Windows 98/Me/NT 4.0/2000/XP/2003 Various Linux OS (USB only) Macintosh 10.3 ~ 10.4 (SCX-5530FN only)
Interface	IEEE 1284 Parallel High Speed USB 2.0 Ethernet 10/100 Base TX (Embedded type)

a. Print speed will be affected by operating system used, computing performance, application software, connecting method, media type, media size, and job complexity.

b. SCX-5530FN only

c. Please visit www.samsungprinter.com to download the latest software version.

Scanner and copier specifications

Item	Description
Compatibility	TWAIN standard / WIA standard
Scanning method	ADF and Flat-bed Color CCD (Charge Coupled Device) module
Resolution	Optical: 600 x 1,200 dpi (mono and color) Enhanced: 4,800 x 4,800 dpi
Effective scanning length	Scanner glass: 297 mm ADF: 356 mm
Effective scanning width	Max 208 mm
Color bit depth	24 bit
Mono bit depth	1 bit for Black & White mode 8 bit for Gray mode
Copy speed ^a	Up to 28 ppm in A4 (30 ppm in Letter)
Copy resolution	Scan: up to 600 x 300 (text, text/photo) up to 600 x 600 (photo using platen) up to 600 x 300 (photo using ADF) Print: up to 600 x 600 (text, text/photo, photo)
Zoom rate	Scanner glass: 25 to 400% ADF: 25 to 100%
Multiple copies	1 to 99 pages
Grayscale	256 levels

a. Copy Speed is based on Single Document Multiple Copy.

Facsimile specifications (SCX-5530FN only)

Item	Description
Compatibility	ITU-T Group 3
Applicable line	Public Switched Telephone Network (PSTN) or behind PABX
Data coding	MH/MR/MMR/JPEG/ECM (Error Correction Mode)
Modem speed	33,6 Kbps
Transmission speed	Approx. 3 seconds/page ^a
Maximum document length	Scanner glass: 297 mm Automatic document glass: 356 mm
Resolution	Standard: 203 x 98 dpi Fine: 203 x 196 dpi Super Fine: 300 x 300 dpi Photo: 203 x 196 dpi Color: 200 x 200 dpi
Memory	6 MB
Halftone	256 levels
Auto dialer	Speed dialing (up to 240 numbers)

a. Transmission time applies to memory transmission of text data with ECM compression using only ITU-T No.1 Chart.

INDEX

Numerics

2/4-up, special copy 6.2

A

accessories
 installing
 memory DIMM 15.1
 order information 12.1
Address Book, use 8.5
ADF 1.2
ADF rubber pad, replace 13.7
ADF, load 5.1
alarm sound 2.3
Ans/Fax mode, receiving mode 9.4

B

background image, erase 6.4

C

characters, enter 2.3
cleaning
 drum 13.5
 inside 13.2
 LSU 13.3
 outside 13.2
 scan unit 13.3
clock mode 2.2
clone, special copy 6.4
collation, special copy 6.2
component location 1.2
control panel 1.3
copying
 2/4-up 6.2
 collation 6.2
 default setting, change 6.2
 erasing background 6.4
 ID card copy 6.3
 poster 6.3
 time out, set 6.4

D

date and time, set 2.2
default mode, change 2.2
delayed fax 9.7
DIMM, install 15.1
display language, change 2.2
DRPD (Distinctive Ring Pattern Detection)
9.4
drum, clean 13.5

E

Erasing background, special copy 6.4
error messages 14.7

F

fax header, set 9.1
Fax mode, receiving mode 9.4
fax number, set 9.1
faxing
 default settings, change 10.2
 delayed faxes 9.7
 fax setup 10.1
 forwarding faxes 9.8
 Multiple Send faxes 9.6
 original settings 9.1
 priority faxes 9.7
 receiving faxes 9.3
 sending faxes 9.2
forwarding faxes 9.8

G

Group dial numbers, set 10.3

H

high altitude 14.15

I

ID card, special copy 6.3

installing accessories
 memory 15.1

J

jam, clear
 document 14.1
 paper 14.2
job timeout, set 2.4

K

key sound 2.3

L

Linux problems 14.19
loading originals
 ADF 5.1
 scanner glass 5.1
loading paper
 multi-purpose tray 5.7
 tray 1/optional tray2 5.5

M

machine ID, set 9.1
Macintosh problems 14.20
memory DIMM, install 15.1
memory, clear 13.2
Multiple Sned faxes 9.6
multi-purpose tray 5.7

N

network scan
 scanning 8.3
 timeout, set 8.4
Network Scan program
 adding scanners 8.2
 problems 14.17
network setup
 EtherTalk 4.2
 IPX frame types 4.2

- operating systems 4.1
 - TCP/IP 4.1
- new toner notification, send 13.6
- n-up (multiple pages per sheet)
 - copying 6.2

O

- originals
 - jam, clear 14.1
 - loading 5.1
- output location, select 5.8
- output tray 5.8

P

- paper guidelines 5.4
- paper jam, clear
 - duplex area 14.5
 - fuser area or around toner cartridge 14.3
 - multi-purpose tray 14.3
 - optional tray 2 14.3
 - paper exit area 14.4
 - tray 1 14.2
- paper level indicator 5.5
- paper load
 - multi-purpose tray 5.7
 - tray 1/optional tray 2 5.5
- paper size
 - setting 5.8
 - specifications 5.3
- paper tray, set
 - copy 6.1
 - fax 9.3
- paper type
 - setting 5.8
 - specifications 5.3
- Phone Book
 - group dial numbers 10.3
 - speed buttons 10.2
 - speed dial numbers 10.3
- poster, special copy 6.3
- PostScript problems 14.18
- power save mode 2.4
- printing
 - reports 13.1
 - USB memory 11.2
- priority fax 9.7
- problem, solve
 - copying 14.15
 - error messages 14.7
 - faxing 14.17
 - Linux 14.19
 - Macintosh 14.20

- Network Scan 14.17
- paper feeding 14.11
- PostScript errors 14.18
- printing 14.11
- scanning 14.16
- Windows 14.18

R

- rear cover, use 5.9
- receiving a fax
 - in Ans/Fax mode 9.4
 - in DRPD mode 9.4
 - in Fax mode 9.4
 - in Secure Receiving mode 9.5
 - in Tel mode 9.4
 - in the memory 9.6
- receiving modes 9.3
- redialing
 - automatically 9.3
 - manually 9.3
- replacement parts 13.6
- replacing
 - ADF rubber pad 13.7
 - toner cartridge 13.5
- replacing, toner cartridge 13.6
- reports, print 13.1
- ringer 2.3

S

- scan power save mode 2.4
- scanner glass
 - cleaning 13.3
 - loading documents 5.1
- scanning
 - default setting, change 8.5
 - scan settings 8.5
 - to application 8.1
 - to email 8.4
 - to FTP server 8.4
 - to network computer 8.3
 - to SMB server 8.5
 - USB flash memory 11.1
- secure receiving mode 9.5
- sending a fax
 - automatically 9.2
 - manually 9.2
- sounds, set 2.3
- speaker sound 2.3
- speaker volume 2.3
- special copy features 6.2
- special print media, guidelines 5.4
- specifications
 - facsimile 16.2

- general 16.1
- paper 5.3
- printer 16.1
- scanner and copier 16.2
- speed buttons, set 10.2
- speed dial numbers, set 10.3
- Status LED 1.5
- supplies
 - checking life 13.7
 - order information 12.1
- system requirements
 - Macintosh 3.3

T

- Tel mode, receiving mode 9.4
- toner cartridge
 - checking remaining toner 13.7
 - cleaning 13.5
 - maintaining 13.3
 - redistributing 13.4
 - replacing 13.5, 13.6
- toner save mode, use 2.4

U

- USB flash memory
 - data backup 11.3
 - managing 11.3
 - printing 11.2
 - scanning 11.1

V

- volume, adjust
 - ringer 2.3
 - speaker 2.3

W

- Windows problems 14.18



Samsung Printer

Software section

SOFTWARE SECTION

CONTENTS

Chapter 1: **INSTALLING PRINTER SOFTWARE IN WINDOWS**

Installing Printer Software	5
Installing Software for Local Printing	5
Installing Software for Network Printing	8
Reinstalling Printer Software	11
Removing Printer Software	12

Chapter 2: **BASIC PRINTING**

Printing a Document	13
Printing to a file (PRN)	13
Printer Settings	14
Layout Tab	14
Paper Tab	15
Graphics Tab	16
Extras Tab	17
About Tab	17
Printer Tab	17
Using a Favorite Setting	18
Using Help	18

Chapter 3: **ADVANCED PRINTING**

Printing Multiple Pages on One Sheet of Paper (N-Up Printing)	19
Printing Posters	20
Printing Booklets	20
Printing on Both Sides of Paper	21
Printing a Reduced or Enlarged Document	21
Fitting Your Document to a Selected Paper Size	21
Using Watermarks	22
Using an Existing Watermark	22
Creating a Watermark	22

Editing a Watermark	22
Deleting a Watermark	22
Using Overlays	23
What is an Overlay?	23
Creating a New Page Overlay	23
Using a Page Overlay	23
Deleting a Page Overlay	23

Chapter 4: USING WINDOWS POSTSCRIPT DRIVER

Printer Settings	24
Advanced	24
Using Help	24

Chapter 5: USING DIRECT PRINT UTILITY

Overview Direct Print Utility	25
Printing	25
From the Direct Print Utility window	25
Using the shortcut icon	25
Using the right-click menu	25

Chapter 6: SHARING THE PRINTER LOCALLY

Setting Up a Host Computer	26
Setting Up a Client Computer	26

Chapter 7: USING SMART PANEL

Understanding Smart Panel	27
Opening the Troubleshooting Guide	28
Using Printer Settings Utility	28
Using Onscreen Help File	28
Changing the Smart Panel Program Settings	28

Chapter 8: SCANNING

Scanning Using Samsung SmarThru	29
Uninstalling Samsung SmarThru	29
Using Samsung SmarThru	30
Using Onscreen Help File	31

Scanning Process with TWAIN-enabled Software	31
Scanning Using the WIA Driver	31

Chapter 9: USING YOUR PRINTER IN LINUX

Getting Started	32
Installing the Unified Linux Driver	32
Installing the Unified Linux Driver	32
Uninstalling the Unified Linux Driver	33
Using the Unified Driver Configurator	34
Opening the Unified Driver Configurator	34
Printers Configuration	34
Scanners Configuration (for MFP device only)	35
Ports Configuration	35
Configuring Printer Properties	36
Printing a Document	36
Printing from Applications	36
Printing Files	37
Scanning a Document (for MFP device only)	37
Using the Image Manager	38

Chapter 10: USING YOUR PRINTER WITH A MACINTOSH (SCX-5530FN ONLY)

Installing Software for Macintosh	40
Setting Up the Printer	41
For a Network-connected Macintosh	41
For a USB-connected Macintosh	41
Printing	42
Printing a Document	42
Changing Printer Settings	42
Printing Multiple Pages on One Sheet of Paper	43
Duplex Printing	44
Scanning	44

1 Installing Printer Software in Windows

This chapter includes:

- **Installing Printer Software**
- **Reinstalling Printer Software**
- **Removing Printer Software**

Installing Printer Software

You can install the printer software for local printing or network printing. To install the printer software on the computer, perform the appropriate installation procedure depending on the printer in use.

A printer driver is software that lets your computer communicate with your printer. The procedure to install drivers may differ depending on the operating system you are using.

All applications should be closed on your PC before beginning installation.

Installing Software for Local Printing

A local printer is a printer directly attached to your computer using the printer cable supplied with your printer, such as a USB or parallel cable. If your printer is attached to a network, skip this step and go to “Installing Software for Network Printing” on page 8.

You can install the printer software using the typical or custom method.

NOTE: If the “New Hardware Wizard” window appears during the installation procedure, click  in the upper right corner of the box to close the window, or click **Cancel**.

Typical Installation

This is recommended for most users. All components necessary for printer operations will be installed.

- 1 Make sure that the printer is connected to your computer and powered on.
- 2 Insert the supplied CD-ROM into your CD-ROM drive. The CD-ROM should automatically run, and an installation window appears. If the installation window does not appear, click **Start** and then **Run**. Type **X:\Setup.exe**, replacing “X” with the letter which represents your drive and click **OK**.

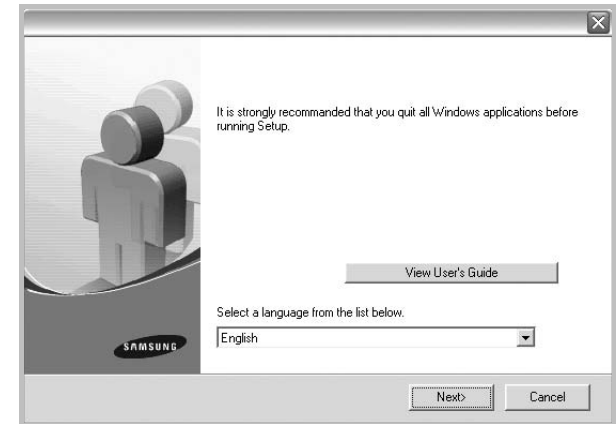

- 3 Click **Next**.
 - If necessary, select a language from the drop-down list.
 - **View User's Guide:** Allows you to view the User's Guide. If your computer doesn't have Adobe Acrobat, click on this option and it will automatically install Adobe Acrobat Reader for you.
- 4 Select **Typical installation for a local printer**. Click **Next**.

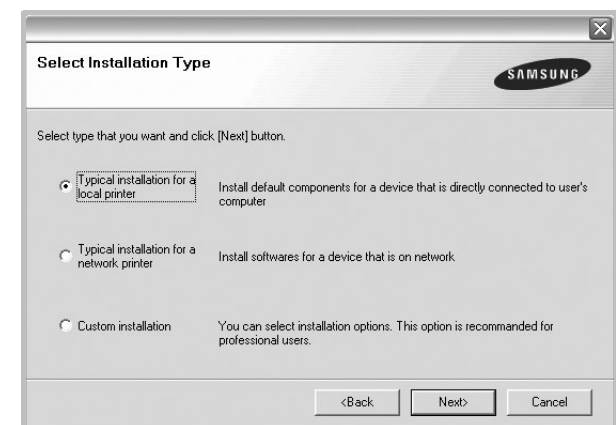

NOTE: If your printer is not already connected to the computer, the following window will appear.

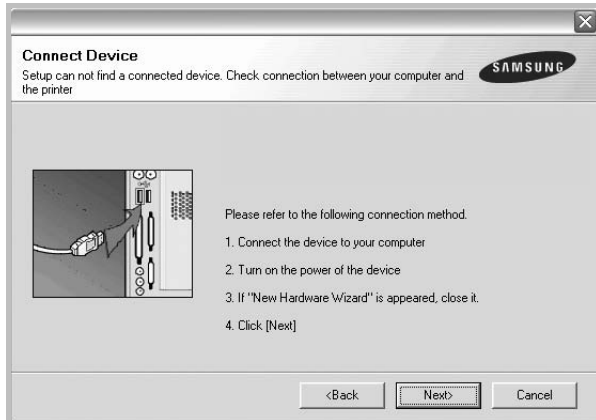

- After connecting the printer, click **Next**.
- If you don't want to connect the printer at this time, click **Next**, and **No** on the following screen. Then the installation will start and a test page will not be printed at the end of the installation.
- *The installation window that appears in this User's Guide may differ depending on the printer and interface in use.*

- 5** After the installation is finished, a window asking you to print a test page appears. If you choose to print a test page, select the checkbox and click **Next**. Otherwise, just click **Next** and skip to step 7.
- 6** If the test page prints out correctly, click **Yes**. If not, click **No** to reprint it.

- 7** To register yourself as a user of Samsung Printers in order to receive information from Samsung, select the checkbox and click **Finish**. You are now sent to the Samsung web site.

Otherwise, just click **Finish**.

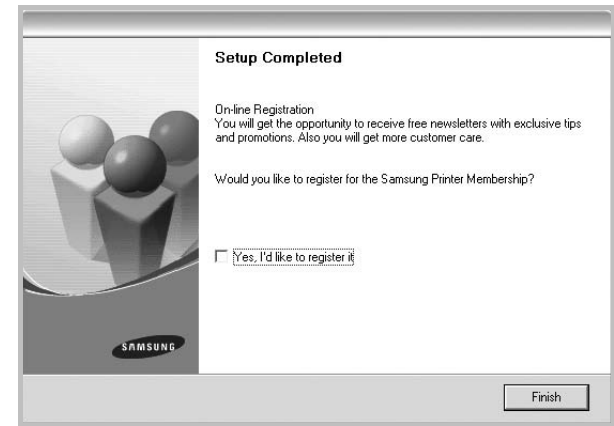

NOTE: After setup is complete, if your printer driver doesn't work properly, reinstall the printer driver. See "Reinstalling Printer Software" on page 11.

Custom Installation

You can choose individual components to install.

- 1** Make sure that the printer is connected to your computer and powered on.
- 2** Insert the supplied CD-ROM into your CD-ROM drive. The CD-ROM should automatically run, and an installation window appears. If the installation window does not appear, click **Start** and then **Run**. Type **X:\Setup.exe**, replacing "X" with the letter which represents your drive and click **OK**.

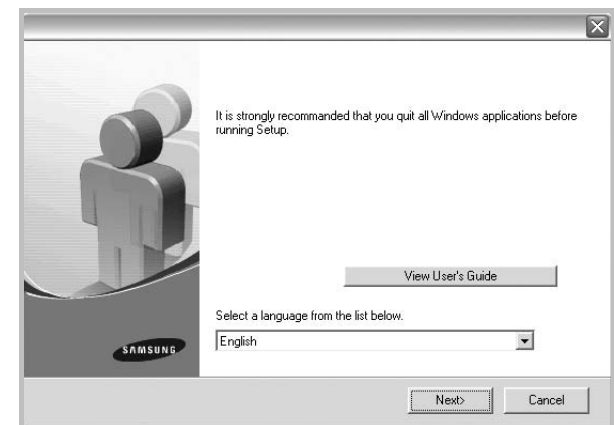

3 Click **Next**.

- If necessary, select a language from the drop-down list.
- **View User's Guide:** Allows you to view the User's Guide. If your computer doesn't have Adobe Acrobat, click on this option and it will automatically install Adobe Acrobat Reader for you.

4 Select **Custom installation**. Click **Next**.

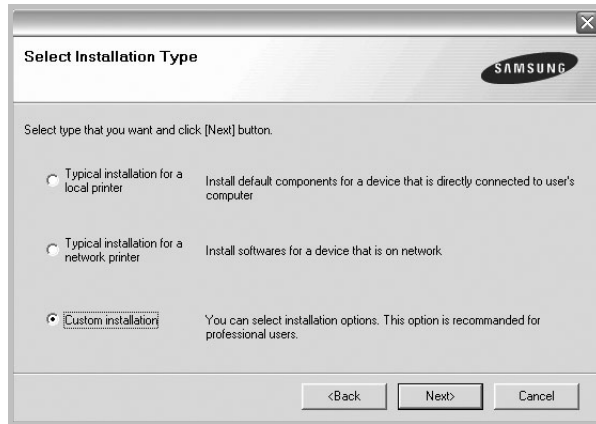

5 Select your printer and click **Next**.

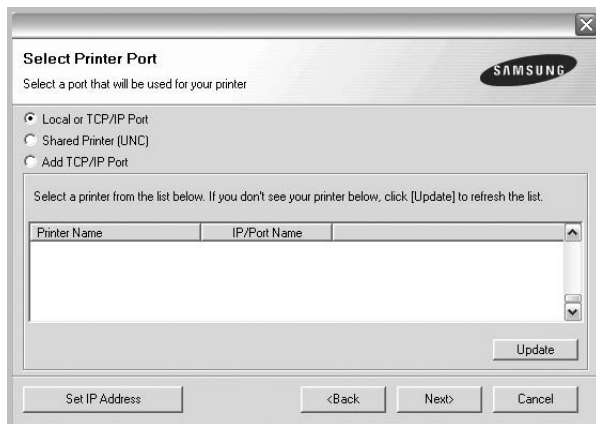

NOTE: If your printer is not already connected to the computer, the following window will appear.

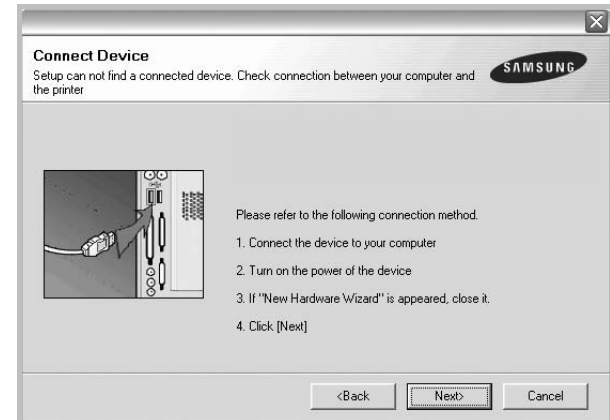

- After connecting the printer, click **Next**.
- If you don't want to connect the printer at this time, click **Next**, and **No** on the following screen. Then the installation will start and a test page will not be printed at the end of the installation.
- *The installation window that appears in this User's Guide may differ depending on the printer and interface in use.*

6 Select the components to be installed and click **Next**.

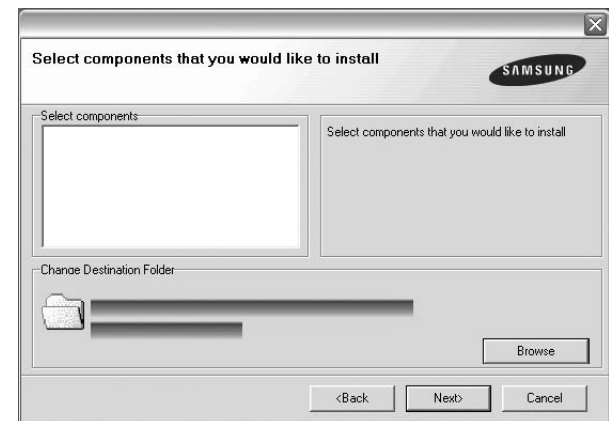

NOTE: You can change the desired installation folder by clicking [**Browse**].

- 7** After the installation is finished, a window asking you to print a test page appears. If you choose to print a test page, select the checkbox and click **Next**. Otherwise, just click **Next** and skip to step 9.
- 8** If the test page prints out correctly, click **Yes**. If not, click **No** to reprint it.

- 9 To register yourself as a user of Samsung Printers in order to receive information from Samsung, select the checkbox and click **Finish**. You are now sent to the Samsung web site.

Otherwise, just click **Finish**.



Installing Software for Network Printing

When you connect your printer to a network, you must first configure the TCP/IP settings for the printer. After you have assigned and verified the TCP/IP settings, you are ready to install the software on each computer on the network.

You can install the printer software using the typical or custom method.

Typical Installation

This is recommended for most users. All components necessary for printer operations will be installed.

- 1 Make sure that the printer is connected to your network and powered on. For details about connecting to the network, see the supplied printer's User's Guide.
- 2 Insert the supplied CD-ROM into your CD-ROM drive. The CD-ROM should automatically run, and an installation window appears.

If the installation window does not appear, click **Start** and then **Run**. Type **X:\Setup.exe**, replacing "X" with the letter which represents your drive and click **OK**.

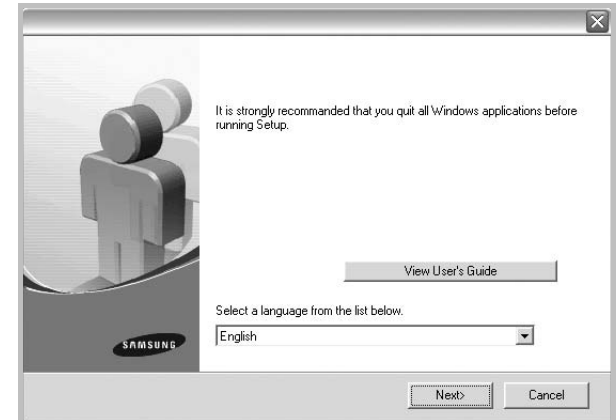

- 3 Click **Next**.
 - If necessary, select a language from the drop-down list.
 - **View User's Guide**: Allows you to view the User's Guide. If your computer doesn't have Adobe Acrobat, click on this option and it will automatically install Adobe Acrobat Reader for you.
- 4 Select **Typical installation for a network printer**. Click **Next**.

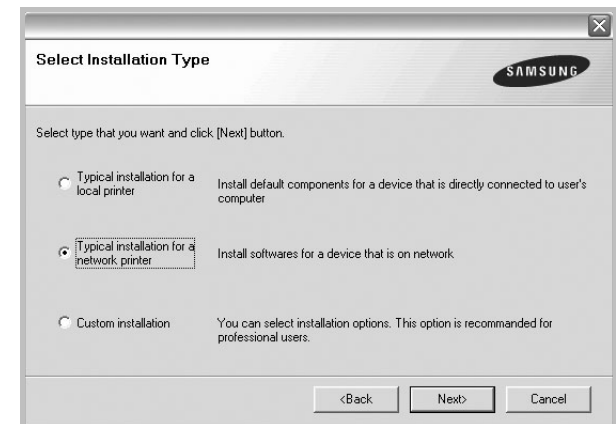

- 5 The list of printers available on the network appears. Select the printer you want to install from the list and then click **Next**.

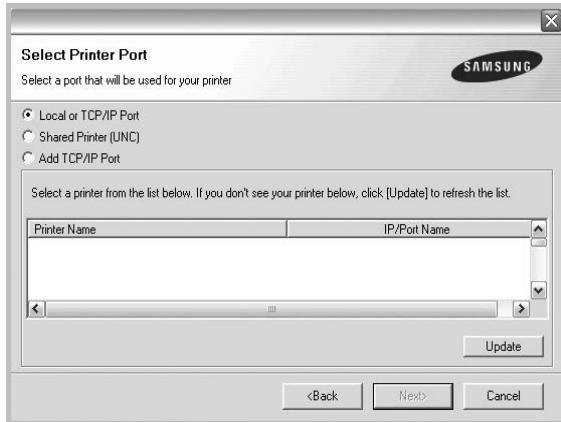

- If you do not see your printer on the list, click **Update** to refresh the list, or select **Add TCP/IP Port** to add your printer to the network. To add the printer to the network, enter the port name and the IP address for the printer.
- To find a shared network printer (UNC Path), select **Shared Printer [UNC]** and enter the shared name manually or find a shared printer by clicking the **Browse** button.

- 6 After the installation is finished, a window appears asking you to print a test page and to register yourself as a user of Samsung Printers in order to receive information from Samsung. If you so desire, select the corresponding checkbox(es) and click **Finish**.

Otherwise, just click **Finish**.

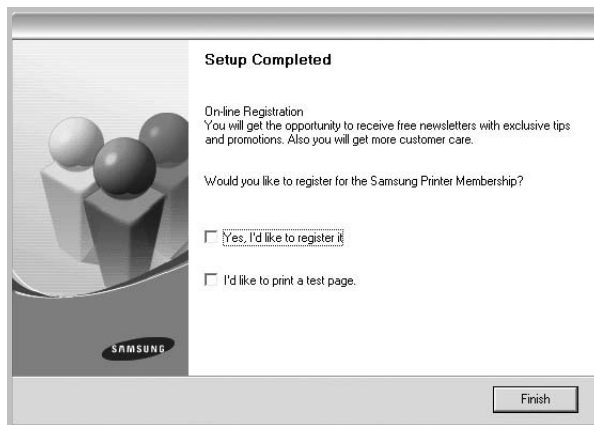

NOTE: After setup is complete, if your printer driver doesn't work properly, reinstall the printer driver. See "Reinstalling Printer Software" on page 11.

Custom Installation

You can choose individual components to install and set a specific IP address.

- 1 Make sure that the printer is connected to your network and powered on. For details about connecting to the network, see the supplied printer's User's Guide.
- 2 Insert the supplied CD-ROM into your CD-ROM drive. The CD-ROM should automatically run, and an installation window appears. If the installation window does not appear, click **Start** and then **Run**. Type **X:\Setup.exe**, replacing "X" with the letter which represents your drive and click **OK**.

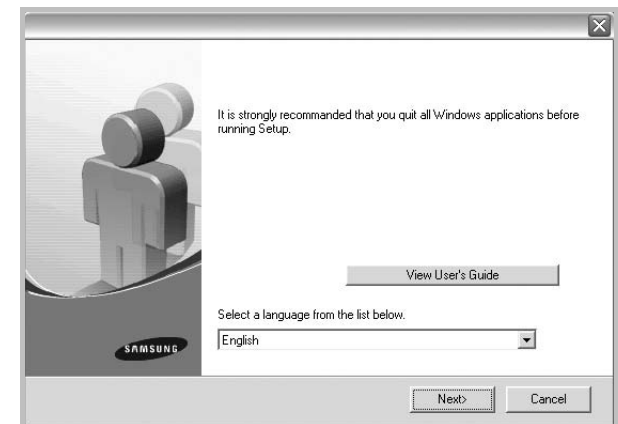

- 3 Click **Next**.
 - If necessary, select a language from the drop-down list.
 - **View User's Guide:** Allows you to view the User's Guide. If your computer doesn't have Adobe Acrobat, click on this option and it will automatically install Adobe Acrobat Reader for you.
- 4 Select **Custom installation**. Click **Next**.

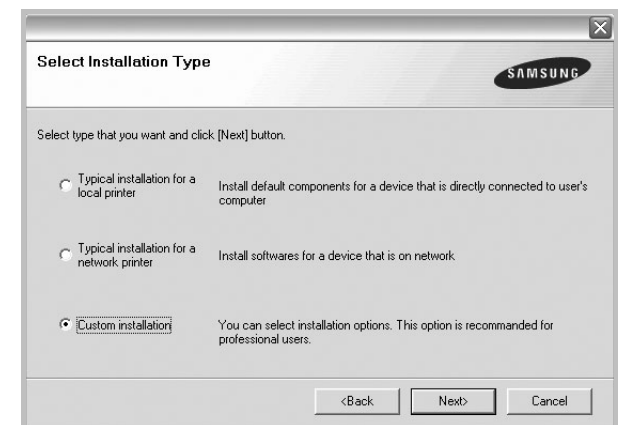

- 5 The list of printers available on the network appears. Select the printer you want to install from the list and then click **Next**.

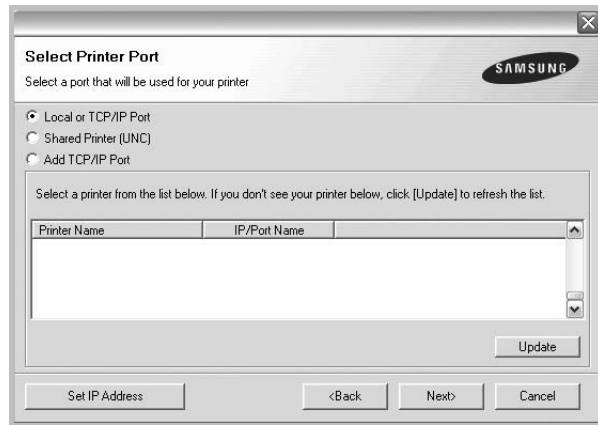

- If you do not see your printer on the list, click **Update** to refresh the list, or select **Add TCP/IP Port** to add your printer to the network. To add the printer to the network, enter the port name and the IP address for the printer.
- To find a shared network printer (UNC Path), select **Shared Printer [UNC]** and enter the shared name manually or find a shared printer by clicking the **Browse** button.

TIP: If you want to set a specific IP address on a specific network printer, click the **Set IP Address** button. The Set IP Address window appears. Do as follows:

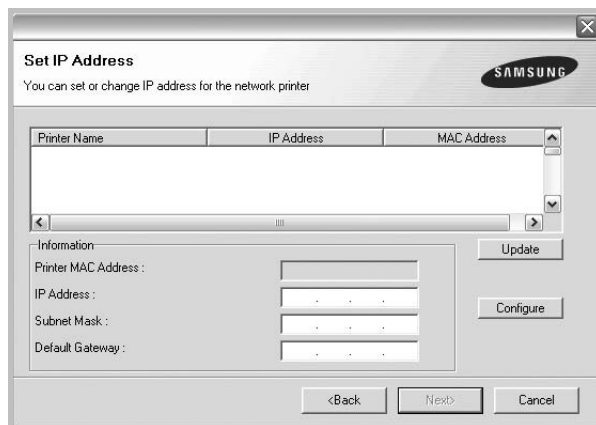

- a. Select a printer to be set with a specific IP address from the list.
- b. Configure an IP address, subnet mask, and gateway for the printer manually and click **Configure** to set the specific IP address for the network printer.
- c. Click **Next**.

- 6 Select the components to be installed. After selecting the components, the following window appears. You can also change the printer name, set the printer to be shared on the network, set the printer as the default printer, and change the port name of each printer. Click **Next**.



To install this software on a server, select the **Setting up this printer on a server** checkbox.

- 7 After the installation is finished, a window appears asking you to print a test page and to register yourself as a user of Samsung Printers in order to receive information from Samsung. If you so desire, select the corresponding checkbox(es) and click **Finish**.

Otherwise, just click **Finish**.

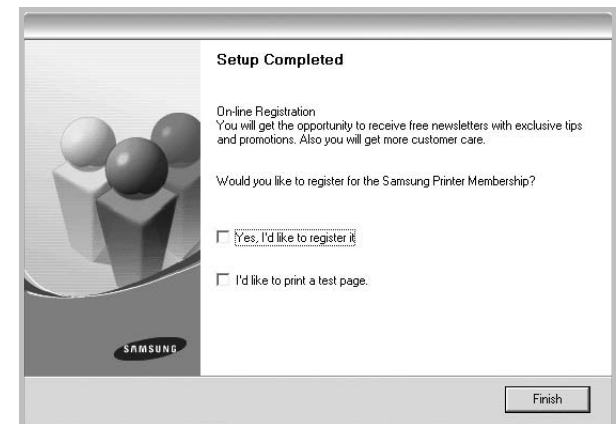

NOTE: After setup is complete, if your printer driver doesn't work properly, reinstall the printer driver. See "Reinstalling Printer Software" on page 11.

Reinstalling Printer Software

You can reinstall the software if installation fails.

- 1 Start Windows.
- 2 From the **Start** menu select **Programs** or **All Programs** → **your printer driver name** → **Maintenance**.
- 3 Select **Repair** and click **Next**.
- 4 The list of printers available on the network appears. Select the printer you want to install from the list and then click **Next**.

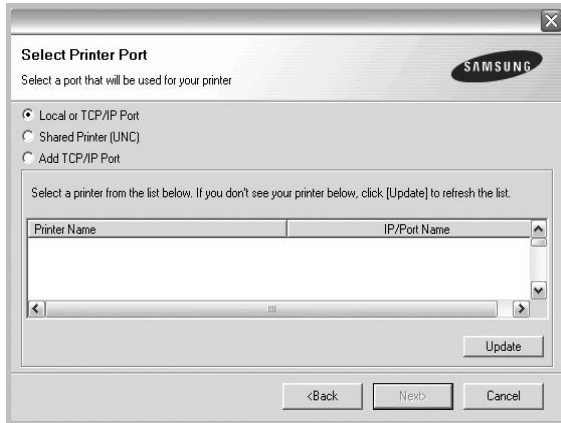

- If you do not see your printer on the list, click **Update** to refresh the list, or select **Add TCP/IP Port** to add your printer to the network. To add the printer to the network, enter the port name and the IP address for the printer.
- To find a shared network printer (UNC Path), select **Shared Printer [UNC]** and enter the shared name manually or find a shared printer by clicking the **Browse** button.

You will see a component list so that you can reinstall any item individually.

NOTE: If your printer is not already connected to the computer, the following window will appear.

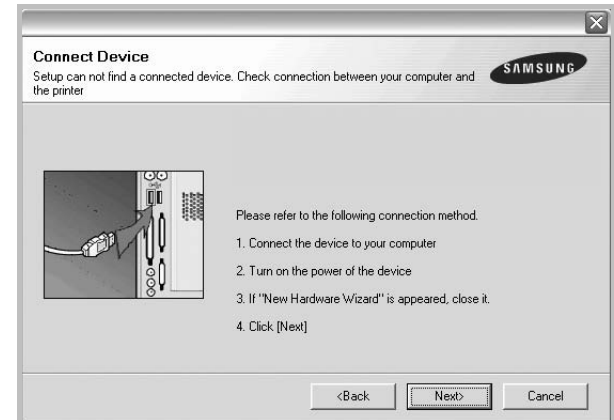

- After connecting the printer, click **Next**.
- If you don't want to connect the printer at this time, click **Next**, and **No** on the following screen. Then the installation will start and a test page will not be printed at the end of the installation.
- *The reinstallation window that appears in this User's Guide may differ depending on the printer and interface in use.*

- 5 Select the components you want to reinstall and click **Next**.

If you installed the printer software for local printing and you select **your printer driver name**, the window asking you to print a test page appears. Do as follows:

- a. To print a test page, select the check box and click **Next**.
 - b. If the test page prints out correctly, click **Yes**.
If it doesn't, click **No** to reprint it.
- 6 When the reinstallation is done, click **Finish**.

Removing Printer Software

- 1 Start Windows.
- 2 From the **Start** menu select **Programs** or **All Programs** →**your printer driver name** →**Maintenance**.
- 3 Select **Remove** and click **Next**.
You will see a component list so that you can remove any item individually.
- 4 Select the components you want to remove and then click **Next**.
- 5 When your computer asks you to confirm your selection, click **Yes**.
The selected driver and all of its components are removed from your computer.
- 6 After the software is removed, click **Finish**.

2 Basic Printing

This chapter explains the printing options and common printing tasks in Windows.

This chapter includes:

- **Printing a Document**
- **Printing to a file (PRN)**
- **Printer Settings**
 - **Layout Tab**
 - **Paper Tab**
 - **Graphics Tab**
 - **Extras Tab**
 - **About Tab**
 - **Printer Tab**
 - **Using a Favorite Setting**
 - **Using Help**

Printing a Document

NOTES:

- Your printer driver **Properties** window that appears in this User's Guide may differ depending on the printer in use. However the composition of the printer properties window is similar.
 - *Check the Operating System(s) that are compatible with your printer. Please refer to the OS Compatibility section of Printer Specifications in your Printer User's Guide.*
 - If you need to know the exact name of your printer, you can check the supplied CD-ROM.
-

The following procedure describes the general steps required for printing from various Windows applications. The exact steps for printing a document may vary depending on the application program you are using. Refer to the User's Guide of your software application for the exact printing procedure.

- 1 Open the document you want to print.
- 2 Select **Print** from the **File** menu. The Print window is displayed. It may look slightly different depending on your application.

The basic print settings are selected within the Print window. These settings include the number of copies and print range.

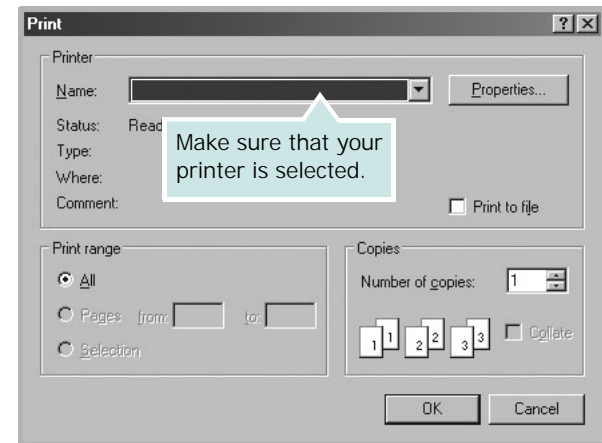

- 3 Select **your printer driver** from the **Name** drop-down list.

To take advantage of the printer features provided by your printer driver, click **Properties** or **Preferences** in the application's Print window. For details, see "Printer Settings" on page 14.

If you see **Setup**, **Printer**, or **Options** in your Print window, click it instead. Then click **Properties** on the next screen.

Click **OK** to close the printer properties window.

- 4 To start the print job, click **OK** or **Print** in the Print window.

Printing to a file (PRN)

You will sometimes need to save the print data as a file for your purpose.

To create a file:

- 1 Check the **Print to file** box at the **Print** window.
- 2 Select the folder and assign a name of the file and then click **OK**.

Printer Settings

You can use the printer properties window, which allows you to access all of the printer options you need when using your printer. When the printer properties are displayed, you can review and change the settings needed for your print job.

Your printer properties window may differ, depending on your operating system. This Software User's Guide shows the Properties window for Windows 98.

Your printer driver **Properties** window that appears in this User's Guide may differ depending on the printer in use.

If you access printer properties through the Printers folder, you can view additional Windows-based tabs (refer to your Windows User's Guide) and the Printer tab (see "Printer Tab" on page 17).

NOTES:

- Most Windows applications will override settings you specify in the printer driver. Change all print settings available in the software application first, and change any remaining settings using the printer driver.
- The settings you change remain in effect only while you are using the current program. **To make your changes permanent**, make them in the Printers folder.
- The following procedure is for Windows XP. For other Windows OS, refer to the corresponding Windows User's Guide or online help.
 1. Click the Windows **Start** button.
 2. Select **Printers and Faxes**.
 3. Select **your printer driver icon**.
 4. Right-click on the printer driver icon and select **Printing Preferences**.
 5. Change the settings on each tab, click OK.

Layout Tab

The **Layout** tab provides options to adjust how the document appears on the printed page. The **Layout Options** includes **Multiple Pages per Side** and **Poster Printing**. See "Printing a Document" on page 13 for more information on accessing printer properties.

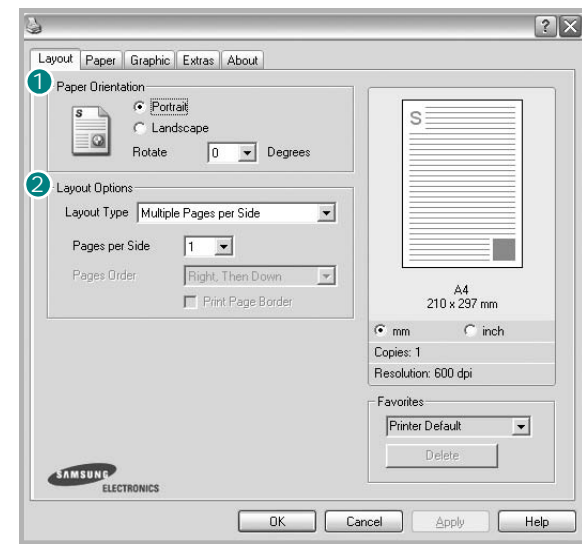

Paper Orientation

Paper Orientation allows you to select the direction in which information is printed on a page.

- **Portrait** prints across the width of the page, letter style.
- **Landscape** prints across the length of the page, spreadsheet style.
- **Rotate** allows you to rotate the page the selected degrees.



▲ Portrait



▲ Landscape

Layout Options

Layout Options allows you to select advanced printing options. You can choose **Multiple Pages per Side** and **Poster Printing**.

- For details, see "Printing Multiple Pages on One Sheet of Paper (N-Up Printing)" on page 19.
- For details, see "Printing Posters" on page 20

Double-sided Printing

Double-sided Printing allows you to print on both sides of paper. *If this option does not appear, your printer does not have this feature.*

- For details, see "Printing on Both Sides of Paper" on page 21.

Paper Tab

Use the following options to set the basic paper handling specifications when you access the printer properties. See “Printing a Document” on page 13 for more information on accessing printer properties.

Click the **Paper** tab to access various paper properties.

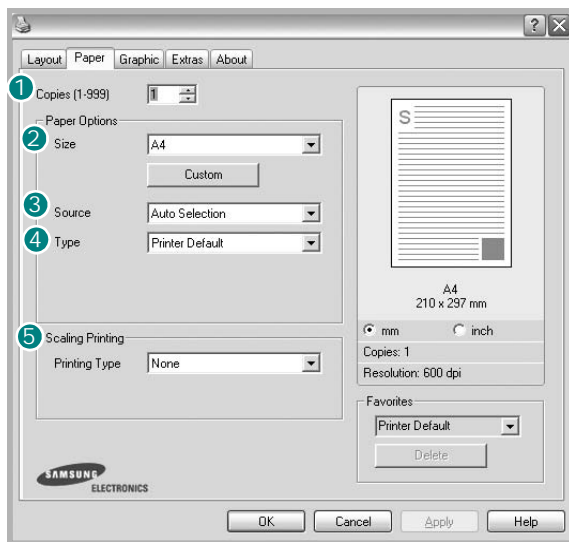

1 Copies

Copies allows you to choose the number of copies to be printed. You can select 1 to 999 copies.

2 Size

Size allows you to set the size of paper you loaded in the tray. If the required size is not listed in the **Size** box, click **Custom**. When the **Custom Paper Setting** window appears, set the paper size and click **OK**. The setting appears in the list so that you can select it.

3 Source

Make sure that **Source** is set to the corresponding paper tray. Use **Manual Feed** when printing on special materials like envelopes and transparencies. You have to load one sheet at a time into the Manual Tray or Multi-Purpose Tray. If the paper source is set to **Auto Select**, the printer automatically picks up print material in the following tray order: Manual Tray or Multi-Purpose Tray, Tray1, Optional Tray2

4 Type

Set **Type** to correspond to the paper loaded in the tray from which you want to print. This will let you get the best quality printout. If not, print quality may not be achieved as you want.
Cotton: 20 lb to 24 lb (75~90 g/m²) cotton paper such as Gilbert 25 % and Gilbert 100 %.
Plain Paper: Normal plain paper. Select this type if your printer is monochrome and printing on the 16 lb (60 g/m²) cotton paper.
Recycled: 20 lb to 24 lb (75~90 g/m²) recycled paper.
Color Paper: 20 lb to 24 lb (75~90 g/m²) color-backgroundd paper.

First Page

This property allows you to print the first page using a different paper type from the rest of the document. You can select the paper source for the first page. For example, load thick stock for the first page into the Multi-purpose Tray, and plain paper into Tray1. Then, select **Tray1** in the **Source** option and **Multi-Purpose Tray** in the **First Page** option. *Some printers do not support this feature.*

5 Scaling Printing

Scaling Printing allows you to automatically or manually scale your print job on a page. You can choose from **None**, **Reduce/Enlarge**, and **Fit to Page**.

- For details, see “Printing a Reduced or Enlarged Document” on page 21.
- For details, see “Fitting Your Document to a Selected Paper Size” on page 21.

Graphics Tab

Use the following Graphic options to adjust the print quality for your specific printing needs. See “Printing a Document” on page 13 for more information on accessing printer properties.

Click the **Graphic** tab to display the properties shown below.

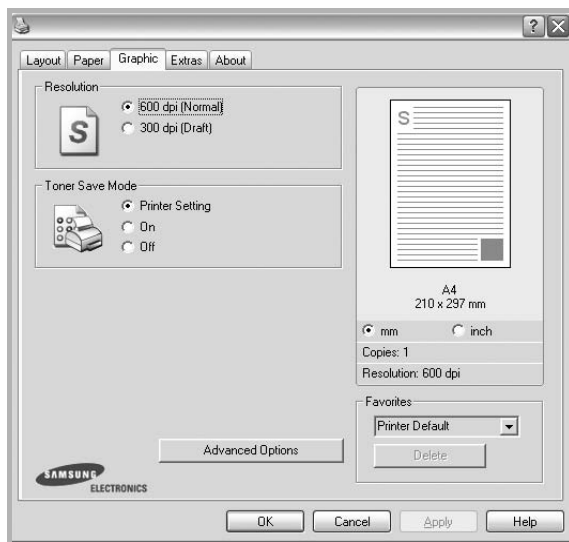

Resolution

The Resolution options you can select may vary depending on your printer model. The higher the setting, the sharper the clarity of printed characters and graphics. The higher setting also may increase the time it takes to print a document.

Image Mode

The available options are Normal and Text Enhance. *Some printers do not support this feature.*

- **Printer Setting:** If you select this option, this feature is determined by the setting you've made on the control panel of the printer.
- **Normal(1,2,3):** This setting is for normal documents.
- **Text Enhance:** Image Mode allows the user to enhance printouts.

Toner Save Mode

Selecting this option extends the life of your toner cartridge and reduces your cost per page without a significant reduction in print quality. *Some printers do not support this feature.*

- **Printer Setting:** If you select this option, this feature is determined by the setting you've made on the control panel of the printer.
- **On:** Select this option to allow the printer to use less toner on each page.
- **Off:** If you don't need to save toner when printing a document, select this option.

Advanced Options

You can set advanced settings by clicking the **Advanced Options** button.

- **TrueType Options:** This option determines what the driver tells the printer about how to image the text in your document. Select the appropriate setting according to the status of your document. *This option may be available only in Windows 9x/Me, depending on your particular printer model.*
 - **Download as Outline:** When this option is selected, the driver will download any TrueType fonts that are used in your document not already stored (resident) on your printer. If, after printing a document, you find that the fonts did not print correctly, choose Download as bit image and resubmit your print job. The Download as bit image setting is often useful when printing Adobe. *This feature is available only when you use the PCL printer driver.*
 - **Download as Bitmap:** When this option is selected, the driver will download the font data as bitmap images. Documents with complicated fonts, such as Korean or Chinese, or various other fonts, will print faster in this setting.
 - **Print as Graphics:** When this option is selected, the driver will download any fonts as graphics. When printing documents with high graphic content and relatively few TrueType fonts, printing performance (speed) may be enhanced in this setting.
- **Print All Text To Black:** When the **Print All Text To Black** option is checked, all text in your document prints solid black, regardless of the color it appears on the screen.

Extras Tab

You can select output options for your document. See “Printing a Document” on page 13 for more information about accessing the printer properties.

Click the **Extras** tab to access the following feature:

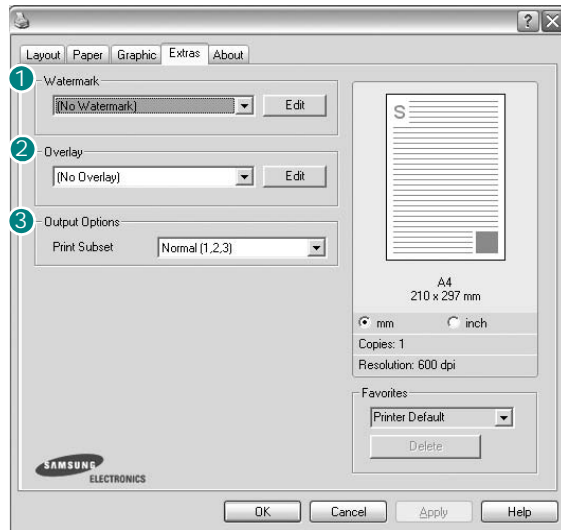

1 Watermark

You can create a background text image to be printed on each page of your document. For details, see “Using Watermarks” on page 22.

2 Overlay

Overlays are often used to take the place of preprinted forms and letterhead paper. For details, see “Using Overlays” on page 23.

3 Output Options

- **Print Subset:** You can set the sequence in which the pages print. Select the print order from the drop-down list.
 - **Normal(1,2,3):** Your printer prints all pages from the first page to the last page.
 - **Reverse All Pages(3,2,1):** Your printer prints all pages from the last page to the first page.
 - **Print Odd Pages:** Your printer prints only the odd numbered pages of the document.
 - **Print Even Pages:** Your printer prints only the even numbered pages of the document.
- **Use Printer Fonts:** When Use Printer Fonts is checked, the printer uses the fonts that are stored in its memory (resident fonts) to print your document, rather than downloading the fonts used in your document. Because downloading fonts takes time, selecting this option can speed up your printing time. When using Printer fonts, the printer will try to match the fonts used in your document to those stored in its memory. If, however, you use fonts in your document that are very different from those resident in the printer, your printed output will appear very different from what it looks like on the screen.
This feature is available only when you use the PCL printer driver.

About Tab

Use the **About** tab to display the copyright notice and the version number of the driver. If you have an Internet browser, you can connect to the Internet by clicking on the web site icon. See “Printing a Document” on page 13 for more information about accessing printer properties.

Printer Tab

If you access printer properties through the **Printers** folder, you can view the **Printer** tab. You can set the printer configuration.

The following procedure is for Windows XP. For other Windows OS, refer to the corresponding Windows User's Guide or online help.

- 1 Click the Windows **Start** menu.
- 2 Select **Printers and Faxes**.
- 3 Select **your printer driver** icon.
- 4 Right-click on the printer driver icon and select **Properties**.
- 5 Click the **Printer** tab and set the options.

Using a Favorite Setting

The **Favorites** option, which is visible on each properties tab, allows you to save the current properties settings for future use.

To save a **Favorites** item:

- 1 Change the settings as needed on each tab.
- 2 Enter a name for the item in the **Favorites** input box.

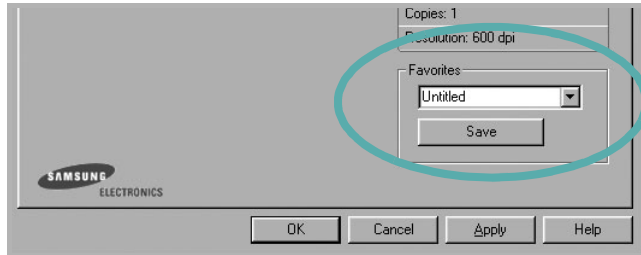

- 3 Click **Save**.

When you save **Favorites**, all current driver settings are saved.

To use a saved setting, select the item from the **Favorites** drop down list. The printer is now set to print according to the Favorites setting you selected.

To delete a Favorites item, select it from the list and click **Delete**.

You can also restore the printer driver's default settings by selecting **Printer Default** from the list.

Using Help

Your printer has a help screen that can be activated by clicking the **Help** button in the printer properties window. These help screens give detailed information about the printer features provided by the printer driver.

You can also click **?** from the upper right corner of the window, and then click on any setting.

3 Advanced Printing

This chapter explains printing options and advanced printing tasks.

NOTE:

- Your printer driver **Properties** window that appears in this User's Guide may differ depending on the printer in use. However the composition of the printer properties window is similar.
 - If you need to know the exact name of your printer, you can check the supplied CD-ROM.
-

This chapter includes:

- **Printing Multiple Pages on One Sheet of Paper (N-Up Printing)**
- **Printing Posters**
- **Printing Booklets**
- **Printing on Both Sides of Paper**
- **Printing a Reduced or Enlarged Document**
- **Fitting Your Document to a Selected Paper Size**
- **Using Watermarks**
- **Using Overlays**

Printing Multiple Pages on One Sheet of Paper (N-Up Printing)



You can select the number of pages to print on a single sheet of paper. To print more than one page per sheet, the pages will be reduced in size and arranged in the order you specify. You can print up to 16 pages on one sheet.

- 1** To change the print settings from your software application, access printer properties. See "Printing a Document" on page 13.
- 2** From the **Layout** tab, choose **Multiple Pages per Side** in the **Layout Type** drop-down list.
- 3** Select the number of pages you want to print per sheet (1, 2, 4, 6, 9, or 16) in the **Pages per Side** drop-down list.
- 4** Select the page order from the **Page Order** drop-down list, if necessary.
Check **Print Page Border** to print a border around each page on the sheet.
- 5** Click the **Paper** tab, select the paper source, size, and type.
- 6** Click **OK** and print the document.

Printing Posters

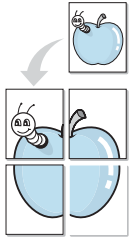

This feature allows you to print a single-page document onto 4, 9, or 16 sheets of paper, for the purpose of pasting the sheets together to form one poster-size document.

- 1 To change the print settings from your software application, access printer properties. See “Printing a Document” on page 13.
- 2 Click the **Layout** tab, select **Poster Printing** in the **Layout Type** drop-down list.
- 3 Configure the poster option:

You can select the page layout from **Poster<2x2>**, **Poster<3x3>**, or **Poster<4x4>**. If you select **Poster<2x2>**, the output will be automatically stretched to cover 4 physical pages.

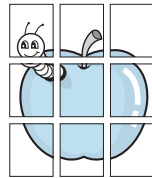
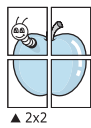

Specify an overlap in millimeters or inches to make it easier to pasting the sheets together.

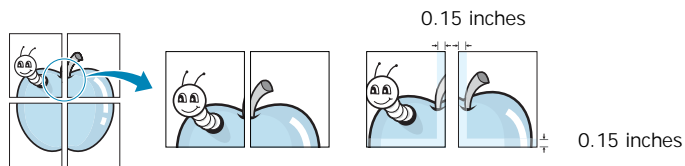

- 4 Click the **Paper** tab, select the paper source, size, and type.
- 5 Click **OK** and print the document. You can complete the poster by pasting the sheets together.

Printing Booklets

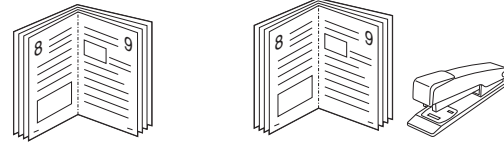

This printer feature allows you to print your document on both sides of the paper and arranges the pages so that the paper can be folded in half after printing to produce a booklet.

- 1 To change the print settings from your software application, access the printer properties. See “Printing a Document” on page 13.
- 2 From the **Layout** tab, choose **Booklet Printing** from the **Type** drop-down list.

NOTE: The booklet printing option is available when A4, Letter, Legal, or Folio size is selected in the **Size** option on the **Paper** tab.

- 3 Click the **Paper** tab, and select the paper source, size, and type.
- 4 Click **OK** and print the document.
- 5 After printing, fold and staple the pages.

Printing on Both Sides of Paper

You can print on both sides of a sheet of paper. Before printing, decide how you want your document oriented.

The options are:

- **Printer Setting**, if you select this option, this feature is determined by the setting you've made on the control panel of the printer. *If this option does not appear, your printer does not have this feature.*
- **None**
- **Long Edge**, which is the conventional layout used in book binding.
- **Short Edge**, which is the type often used with calendars.

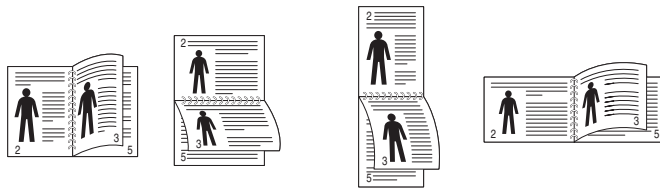

▲ Long Edge

▲ Short Edge

- **Reverse Duplex**, allows you to select general print order compare to duplex print order. *If this option does not appear, your printer does not have this feature.*

NOTE:

- Do not print on both sides of labels, transparencies, envelopes, or thick paper. Paper jamming and damage to the printer may result.
- To use double-sided printing, you can use only the following paper sizes: A4, Letter, Legal, and Folio, with a weight of 20~24 lbs (75~90 g/m²).

- 1 To change the print settings from your software application, access printer properties. "Printing a Document" on page 13.
- 2 From the **Layout** tab, select the paper orientation.
- 3 From the **Double-sided Printing** section, select the binding option you want.
- 4 Click the **Paper** tab and select the paper source, size, and type.
- 5 Click **OK** and print the document.

NOTE: If your printer does not have a duplex unit, you should complete the printing job manually. The printer prints every other page of the document first. After printing the first side of your job, the Printing Tip window appears. Follow the on-screen instructions to complete the printing job.

Printing a Reduced or Enlarged Document

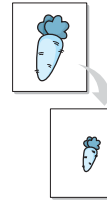

You can change the size of a page's content to appear larger or smaller on the printed page.

- 1 To change the print settings from your software application, access printer properties. See "Printing a Document" on page 13.
- 2 From the **Paper** tab, select **Reduce/Enlarge** in the **Printing Type** drop-down list.
- 3 Enter the scaling rate in the **Percentage** input box. You can also click the ▼ or ▲ button.
- 4 Select the paper source, size, and type in **Paper Options**.
- 5 Click **OK** and print the document.

Fitting Your Document to a Selected Paper Size

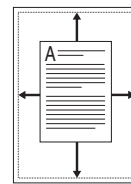

This printer feature allows you to scale your print job to any selected paper size regardless of the digital document size. This can be useful when you want to check fine details on a small document.

- 1 To change the print settings from your software application, access printer properties. See "Printing a Document" on page 13.
- 2 From the **Paper** tab, select **Fit to Page** in the **Printing Type** drop-down list.
- 3 Select the correct size from the **Target Page** drop-down list.
- 4 Select the paper source, size, and type in **Paper Options**.
- 5 Click **OK** and print the document.

Using Watermarks

The Watermark option allows you to print text over an existing document. For example, you may want to have large gray letters reading "DRAFT" or "CONFIDENTIAL" printed diagonally across the first page or all pages of a document.

There are several predefined watermarks that come with the printer, and they can be modified, or you can add new ones to the list.

Using an Existing Watermark

- 1 To change the print settings from your software application, access printer properties. See "Printing a Document" on page 13.
- 2 Click the **Extras** tab, and select the desired watermark from the **Watermark** drop-down list. You will see the selected watermark in the preview image.
- 3 Click **OK** and start printing.

NOTE: The preview image shows how the page will look when it is printed.

Creating a Watermark

- 1 To change the print settings from your software application, access printer properties. See "Printing a Document" on page 13.
- 2 Click the **Extras** tab, and click the **Edit** button in the **Watermark** section. The **Edit Watermark** window appears.
- 3 Enter a text message in the **Watermark Message** box. You can enter up to 40 characters. The message displays in the preview window.
When the **First Page Only** box is checked, the watermark prints on the first page only.
- 4 Select watermark options.
You can select the font name, style, size, or grayscale level from the **Font Attributes** section and set the angle of the watermark from the **Message Angle** section.
- 5 Click **Add** to add a new watermark to the list.
- 6 When you have finished editing, click **OK** and start printing.

To stop printing the watermark, select **<No Watermark>** from the **Watermark** drop-down list.

Editing a Watermark

- 1 To change the print settings from your software application, access printer properties. See "Printing a Document" on page 13.
- 2 Click the **Extras** tab and click the **Edit** button in the **Watermark** section. The **Edit Watermark** window appears.
- 3 Select the watermark you want to edit from the **Current Watermarks** list and change the watermark message and options.
- 4 Click **Update** to save the changes.
- 5 Click **OK** until you exit the Print window.

Deleting a Watermark

- 1 To change the print settings from your software application, access printer properties. See "Printing a Document" on page 13.
- 2 From the **Extras** tab, click the **Edit** button in the Watermark section. The **Edit Watermark** window appears.
- 3 Select the watermark you want to delete from the **Current Watermarks** list and click **Delete**.
- 4 Click **OK** until you exit the Print window.

Using Overlays

What is an Overlay?



An overlay is text and/or images stored in the computer hard disk drive (HDD) as a special file format that can be printed on any document. Overlays are often used to take the place of preprinted forms and letterhead paper. Rather than using preprinted letterhead, you can create an overlay containing the exact same information that is currently on your letterhead. To print a letter with your company's letterhead, you do not need to load preprinted letterhead paper in the printer. You need only tell the printer to print the letterhead overlay on your document.

Creating a New Page Overlay

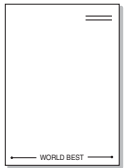

To use a page overlay, you must create a new page overlay containing your logo or image.

- 1 Create or open a document containing text or an image for use in a new page overlay. Position the items exactly as you wish them to appear when printed as an overlay.
- 2 To save the document as an overlay, access printer properties. See "Printing a Document" on page 13.
- 3 Click the **Extras** tab, and click **Edit** button in the **Overlay** section.
- 4 In the Edit Overlay window, click **Create Overlay**.
- 5 In the Create Overlay window, type a name of up to eight characters in the **File name** box. Select the destination path, if necessary. (The default is C:\Formover).
- 6 Click **Save**. The name appears on the **Overlay List** box.
- 7 Click **OK** or **Yes** to finish creating.
The file is not printed. Instead it is stored on your computer hard disk drive.

NOTE: The overlay document size must be the same as the documents you print with the overlay. Do not create an overlay with a watermark.

Using a Page Overlay

After an overlay has been created, it is ready to be printed with your document. To print an overlay with a document:

- 1 Create or open the document you want to print.
- 2 To change the print settings from your software application, access printer properties. See "Printing a Document" on page 13.
- 3 Click the **Extras** tab.
- 4 Select the desired overlay from the **Overlay** drop-down list box.
- 5 If the overlay file you want does not appear in the **Overlay** list, click **Edit** button and **Load Overlay**, and select the overlay file.

If you have stored the overlay file you want to use in an external source, you can also load the file when you access the **Load Overlay** window.

After you select the file, click **Open**. The file appears in the **Overlay List** box and is available for printing. Select the overlay from the **Overlay List** box.

- 6 If necessary, click **Confirm Page Overlay When Printing**. If this box is checked, a message window appears each time you submit a document for printing, asking you to confirm your wish to print an overlay on your document.
If this box is not checked and an overlay has been selected, the overlay automatically prints with your document.
- 7 Click **OK** or **Yes** until printing begins.
The selected overlay downloads with your print job and prints on your document.

NOTE: The resolution of the overlay document must be the same as that of the document you will print with the overlay.

Deleting a Page Overlay

You can delete page overlays that you no longer use.

- 1 In the printer properties window, click the **Extras** tab.
- 2 Click the **Edit** button in the **Overlay** section.
- 3 Select the overlay you want to delete from the **Overlay List** box.
- 4 Click **Delete Overlay**.
- 5 When a confirming message window appears, click **Yes**.
- 6 Click **OK** until you exit the Print window.

4 Using Windows PostScript Driver

If you want to use the PostScript driver provided with your system CD-ROM to print a document.

PPDs, in combination with the PostScript driver, access printer features and allow the computer to communicate with the printer. An installation program for the PPDs is provided on the supplied software CD-ROM.

This chapter includes:

Printer Settings

You can use the printer properties window, which allows you to access all of the printer options you need when using your printer. When the printer properties are displayed, you can review and change the settings needed for your print job.

Your printer properties window may differ, depending on your operating system. This Software User's Guide shows the Properties window for Windows XP.

Your printer driver **Properties** window that appears in this User's Guide may differ depending on the printer in use.

NOTES:

- Most Windows applications will override settings you specify in the printer driver. Change all print settings available in the software application first, and change any remaining settings using the printer driver.
 - The settings you change remain in effect only while you are using the current program. **To make your changes permanent**, make them in the Printers folder.
 - The following procedure is for Windows XP. For other Windows OS, refer to the corresponding Windows User's Guide or online help.
 1. Click the Windows **Start** button.
 2. Select **Printers and Faxes**.
 3. Select **your printer driver icon**.
 4. Right-click on the printer driver icon and select **Printing Preferences**.
 5. Change the settings on each tab, click OK.
-

Advanced

You can use advanced settings by clicking the **Advanced** button.

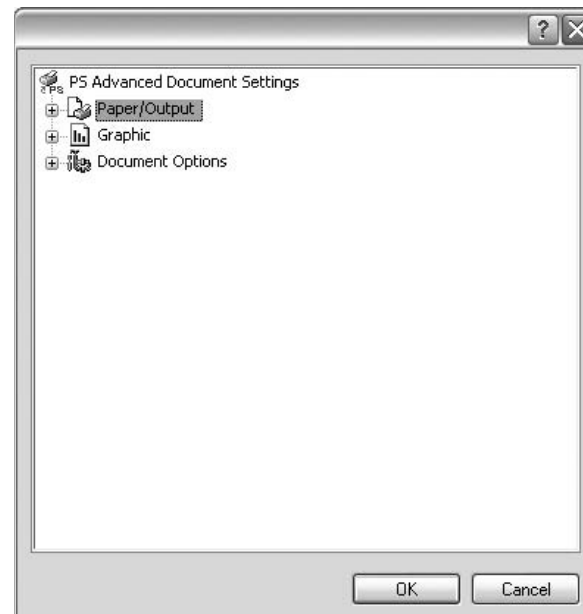

- **Paper/Output** this option allows you to select the size of the paper loaded in the tray.
- **Graphic** this option allows you to adjust the print quality for your specific printing needs.
- **Document Options** this options allow you to set the PostScript options or printer features.

Using Help

You can click  from the upper right corner of the window, and then click on any setting.

5 Using Direct Print Utility

This chapter explains how to use Direct Print Utility to print PDF files without having to open the files.

CAUTION

- You can not print PDF files that are restricted to print. Deactivate the printing restriction feature, and retry printing.
- You can not print PDF files that are restricted by a password. Deactivate the password feature, and retry printing.
- Depending on how a PDF file was created, it may not be able to be printed using the **Direct Print Utility** program.
- Depending on the memory size supported by your printer, PDF files can not be printed using the **Direct Print Utility** program. Expand the memory.
- The **Direct Print Utility** program supports PDF version 1.4 and below. For a higher version, you must open the file to print it.

Overview Direct Print Utility

Direct Print Utility is a program that sends a PDF file directly to your printer without having to open the file. It sends data through the Windows spooler using the port of the printer driver. It only supports PDF format.

To installing this program, you should select **Custom** and put a check mark in this program when you install the printer driver.

Printing

There are several ways you can print using Direct Print Utility.

From the Direct Print Utility window

- 1 From the **Start** menu select **Programs** or **All Programs** → **Direct Print Utility** → **Direct Print Utility**.
Or, double-click the Direct Print Utility shortcut icon on your desk top.
The Direct Print Utility window opens.
- 2 Select the printer you will use in the Select Printer section and click **Browse**.
- 3 Select the PDF file you will print and click **Open**.
The PDF file is added in the Select Files section.
- 4 Customize the printer settings for your needs. See the next column.
- 5 Click **Print**.
The selected PDF file is sent to the printer.

Using the shortcut icon

- 1 Select the PDF file you will print and by dragging drop it to the Direct Print Utility shortcut icon on your desk top.
The selected PDF file is sent to the default printer.

NOTE : If the default printer does not support Direct Print Utility, the message window alerting you to select the appropriate printer opens. Select the appropriate printer in the Select Printer section.

- 2 Customize the printer settings for your needs.
- 3 Click **Print**.
The selected PDF file is sent to the printer.

Using the right-click menu

- 1 Right-click on the PDF file you will print and select **Direct Printing**.
The Direct Print Utility window opens with the PDF file is added.
- 2 Select the printer you will use.
- 3 Customize the printer settings for your needs. See the below part.
- 4 Click **Print**.
The selected PDF file is sent to the printer.

6 Sharing the Printer Locally

You can connect the printer directly to a selected computer, which is called “host computer,” on the network.

The following procedure is for Windows XP. For other Windows OS, refer to the corresponding Windows User's Guide or online help.

NOTES:

- Check the Operating System(s) that are compatible with your printer. Please refer to the OS Compatibility section of Printer Specifications in your Printer User's Guide.
 - If you need to know the exact name of your printer, you can check the supplied CD-ROM.
-

Setting Up a Host Computer

- 1 Start Windows.
- 2 From the **Start** menu select **Printers and Faxes**.
- 3 Double-click **your printer driver icon**.
- 4 From the **Printer** menu, select **Sharing**.
- 5 Check the **Share this printer** box.
- 6 Fill in the **Shared Name** field, and then click **OK**.

Setting Up a Client Computer

- 1 Right-click the Windows **Start** button and select **Explorer**.
- 2 Open your network folder in the left column.
- 3 Click the shared name.
- 4 From the **Start** menu select **Printers and Faxes**.
- 5 Double-click **your printer driver icon**.
- 6 From the **Printer** menu, select **Properties**.
- 7 From the **Ports** tab, click **Add Port**.
- 8 Select **Local Port** and click **New Port**.
- 9 Fill in the **Enter a port name** field with the shared name.
- 10 Click **OK** and click **Close**.
- 11 Click **Apply** and click **OK**.

7 Using Smart Panel

Smart Panel is a program that monitors and informs you of the status of the printer, and allows you to customize the printer's settings. Smart Panel is installed automatically when you install the printer software.

NOTES:

- To use this program, you need:
 - Windows 98 or higher (Windows NT 4.0 can be used only for network-supported printers.) To check for Operating System(s) that are compatible with your printer, refer to Printer Specifications in your Printer User's Guide.
 - Mac OS X 10.3 or higher
 - Linux. To check for Linux systems that are compatible with your printer, refer to Printer Specifications in your Printer User's Guide.
 - Internet Explorer version 5.0 or higher for flash animation in HTML Help.
- If you need to know the exact name of your printer, you can check the supplied CD-ROM.

Understanding Smart Panel

If an error occurs while printing, Smart Panel appears automatically, showing the error.

You can also launch Smart Panel manually. Double-click the Smart Panel icon on the Windows task bar (in Windows), or Notification Area (in Linux). You can also click it on the status bar (in Mac OS X).

Double-click this icon in Windows.

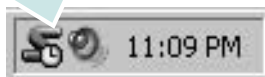

Click this icon in Mac OS X.



Double-click this icon in Linux.



If you are a Windows user, from the **Start** menu, select **Programs** or **All Programs** → **your printer driver name** → **Smart Panel**.

NOTES:

- If you have already installed more than one Samsung printer, first select the printer model you want in order to use the corresponding Smart Panel. Right-click (in Windows or Linux) or click (in Mac OS X) the Smart Panel icon and select **your printer name**.
- The Smart Panel window and its contents shown in this Software User's Guide may differ depending on the printer or Operating System in use.

The Smart Panel program displays the current status of the printer, the level of toner remaining in the toner cartridge(s) and various other information. You can also change settings.

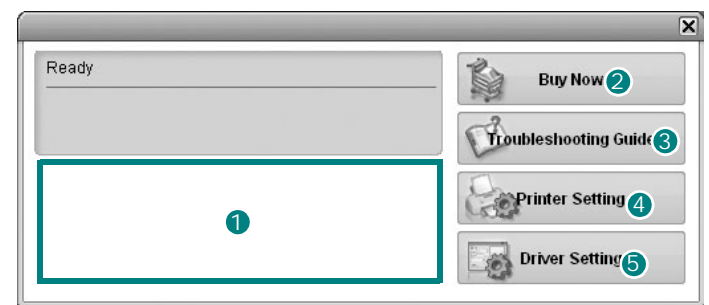

1 Toner Level

You can view the level of toner remaining in the toner cartridge(s). The printer and the number of toner cartridge(s) shown in the above window may differ depending on the printer in use. Any printers do not have this feature.

2 Buy Now

You can order replacement toner cartridge(s) online.

3 Troubleshooting Guide

You can view Help to solve problems.

4 Printer Setting

You can configure various printer settings in the Printer Settings Utility window. Any printers do not have this feature.

NOTE: If your printer is connected to a network and you are a Windows user, the **SyncThru Web Service** window appears instead of the Printer Settings Utility window. Mac OS X and Linux do not support network environments.

5 Driver Setting (Only for Windows)

You can use the printer properties window, which allows you to access all of the printer options you need for using your printer. For details, See “Printer Settings” on page 14.

Opening the Troubleshooting Guide

Using the troubleshooting guide, you can view solutions for error status problems.

Right-click (in Windows or Linux) or click (in Mac OS X) the Smart Panel icon and select **Troubleshooting Guide**.

Using Printer Settings Utility

Using the Printer Settings Utility, you can configure and check print settings.

- 1 Right-click (in Windows or Linux) or click (in Mac OS X) the Smart Panel icon and select **Printer Setting**.
- 2 Change the settings.
- 3 To send the changes to the printer, click the **Apply** button.

NOTES: If your printer is connected to a network, the **SyncThru Web Service** window appears instead of the Printer Settings Utility window.

Using Onscreen Help File

For more information about **Printer Settings Utility**, click  .

Changing the Smart Panel Program Settings

Right-click (in Windows or Linux) or click (in Mac OS X) the Smart Panel icon and select **Options**.

Select the settings you want from the **Options** window.

8 Scanning

Scanning with your machine lets you turn pictures and text into digital files on your computer. Then you can fax or e-mail the files, display them on your web site or use them to create projects that you can print using Samsung SmarThru software or the WIA driver.

This chapter includes:

- **Scanning Using Samsung SmarThru**
- **Scanning Process with TWAIN-enabled Software**
- **Scanning Using the WIA Driver**

NOTES:

- *Check the Operating System(s) that are compatible with your printer. Please refer to the OS Compatibility section of Printer Specifications in your Printer User's Guide.*
 - *You can check your printer name in the supplied CD-ROM.*
 - *The maximum resolution that can be achieved depends upon various factors, including computer speed, available disk space, memory, the size of the image being scanned, and bit depth settings. Thus, depending on your system and what you are scanning, you may not be able to scan at certain resolutions, especially using enhanced dpi.*
-

Scanning Using Samsung SmarThru

Samsung SmarThru is the accompanying software for your machine. With SmarThru, scanning is the proverbial piece of cake.

NOTE: You can use SmarThru 4 in Windows 98 or higher.

Uninstalling Samsung SmarThru

NOTE: Before beginning uninstallation, ensure that all applications are closed on your computer.

- 1** From the **Start** menu, select **Programs**.
- 2** Select **SmarThru 4**, and then select **Uninstall SmarThru 4**.
- 3** When your computer asks you to confirm, click **OK**.
- 4** Click **Finish**.

You may be prompted to restart your computer. In this case you must shut the computer down and then restart it before the changes will be saved.

Using Samsung SmarThru

Follow these steps to start scanning using the SmarThru:

- 1 Make sure that your machine and computer are turned on and properly connected to each other.
- 2 Place your photograph or page on the document glass or ADF.
- 3 Once you have installed Samsung SmarThru, you will see the **SmarThru 4** icon on your desktop. Double-click the **SmarThru 4** icon.

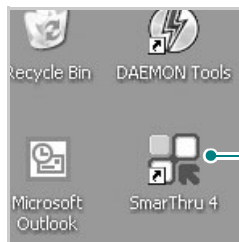

Double-click this icon.

The SmarThru 4 window opens.

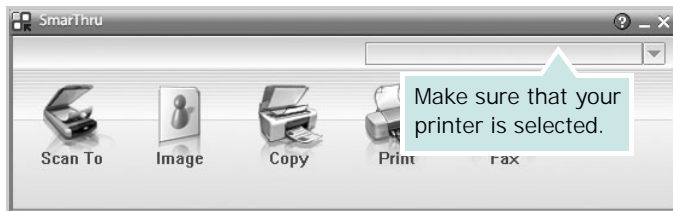

• Scan To

Allows you to scan an image and save it to an application or folder, email it, or publish it on a web site.

• Image

Allows you to edit an image you have saved as a graphic file and send it to a selected application or folder, email it, or publish it on a web site.

• Copy

Allows you to produce professional quality copies. You can make black and white or color copies of an image if your machine supports it, and customize the copy settings.

• Print

Allows you to print images you have saved. You can print images in black and white or color mode if your machine supports it.

• Fax

Allows you to fax images or files you have saved on your computer. This is available when your machine supports the fax feature.

- 4 Click **Scan To**. The **Scan To** menu bar appears on the SmarThru 4 window.

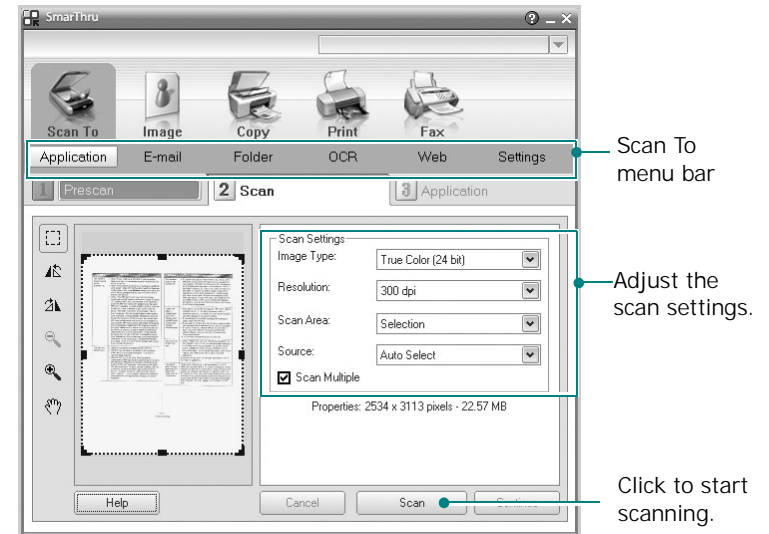

Scan To lets you use the following services:

• Application

Scanning an image and placing it in an image editor application, such as Paint or Adobe Photoshop.

• E-mail

Scanning an image and emailing it. Allows you to scan an image, preview it, and email it.

NOTE: To send an image by e-mail, you must have a mail client program, like Outlook Express, which has been set up with your e-mail account.

• Folder

Scanning an image and saving it to a folder. Allows you to scan an image, preview it, and save it to the folder of your choice.

• OCR

Scanning an image and performing text recognition. Allows you to scan an image, preview it, and send it to the OCR program for text recognition.

- Recommended Scan Option for OCR
- Resolution: 200 or 300 dpi
- Image Type: Grayscale or Black & White

• Web

Scanning an image, previewing it, and publishing it on a web site, using the specified file format for the image you want to publish.

• Settings

Customizing settings of **Scan To** basic functions. Allows you to customize settings for **Application**, **E-mail**, **OCR**, and **Web** functions.

- 5 Click the service icon according to your job.
- 6 SmarThru 4 opens for the selected service. Adjust the scan settings.
- 7 To start scanning, click **Scan**.

NOTE: If you want to cancel the scan job, click **Cancel**.

Using Onscreen Help File

For more information about SmarThru, click  at the top right corner of the window. The SmarThru Help window opens and allows you to view onscreen help supplied on the SmarThru program.

Scanning Process with TWAIN-enabled Software

If you want to scan documents using other software, you will need to use TWAIN-compliant software, such as Adobe PhotoDeluxe or Adobe Photoshop. The first time you scan with your machine, select it as your TWAIN source in the application you use.

The basic scanning process involves a number of steps:

- 1 Make sure that your machine and computer are turned on and properly connected to each other.
- 2 Load the document(s) face up into the ADF.
OR
Place a single document face down on the document glass.
- 3 Open an application, such as PhotoDeluxe or Photoshop.
- 4 Open the TWAIN window and set the scan options.
- 5 Scan and save your scanned image.

NOTE: You need to follow the program's instructions for acquiring an image. Please refer to the user's guide of the application.

Scanning Using the WIA Driver

Your machine also supports the Windows Image Acquisition (WIA) driver for scanning images. WIA is one of the standard components provided by Microsoft® Windows® XP and works with digital cameras and scanners. Unlike the TWAIN driver, the WIA driver allows you to scan and easily manipulate images without using additional software.

NOTE: The WIA driver works only on Windows XP with USB port.

- 1 Load the document(s) face up into the ADF.
OR
Place a single document face down on the document glass.
- 2 From the **Start** menu on your desktop window, select **Settings, Control Panel**, and then **Scanners and Cameras**.
- 3 Double click **your scanner driver** icon. The Scanner and Camera Wizard launches.
- 4 Choose your scanning preferences and click **Preview** to see how your preferences affect the picture.
- 5 Click **Next**.
- 6 Enter a picture name, and select a file format and destination to save the picture.
- 7 Follow the on-screen instructions to edit the picture after it is copied to your computer.

NOTE: If you want to cancel the scan job, press the Cancel button on the Scanner and Camera Wizard.

9 Using Your Printer in Linux

You can use your machine in a Linux environment.

This chapter includes:

- **Getting Started**
- **Installing the Unified Linux Driver**
- **Using the Unified Driver Configurator**
- **Configuring Printer Properties**
- **Printing a Document**
- **Scanning a Document (for MFP device only)**

Getting Started

The supplied CD-ROM provides you with Samsung's Unified Linux Driver package for using your machine with a Linux computer.

Samsung's Unified Linux Driver package contains printer and scanner drivers, providing the ability to print documents and scan images. The package also delivers powerful applications for configuring your machine and further processing of the scanned documents.

After the driver is installed on your Linux system, the driver package allows you to monitor a number of machine devices via fast ECP parallel ports and USB simultaneously. The acquired documents can then be edited, printed on the same local or network machine devices, sent by e-mail, uploaded to an FTP site, or transferred to an external OCR system.

The Unified Linux Driver package is supplied with a smart and flexible installation program. You don't need to search for additional components that might be necessary for the Unified Linux Driver software: all required packages will be carried onto your system and installed automatically; this is possible on a wide set of the most popular Linux clones.

Installing the Unified Linux Driver

Installing the Unified Linux Driver

- 1 Make sure that you connect your machine to your computer. Turn both the computer and the machine on.
- 2 When the Administrator Login window appears, type in *root* in the Login field and enter the system password.

NOTE: You must log in as a super user (*root*) to install the printer software. If you are not a super user, ask your system administrator.

- 3 Insert the printer software CD-ROM. The CD-ROM will automatically run.

If the CD-ROM does not automatically run, click the  icon at the bottom of the desktop. When the Terminal screen appears, type in:

If the CD-ROM is secondary master and the location to mount is `/mnt/cdrom`,

```
[root@localhost root]#mount -t iso9660 /dev/hdc /mnt/cdrom
```

```
[root@localhost root]#cd /mnt/cdrom/Linux
```

```
[root@localhost root]#./install.sh
```

NOTE: The installation program runs automatically if you have an autorun software package installed and configured.

- 4 When the welcome screen appears, click **Next**.



- 5 When the installation is complete, click **Finish**.

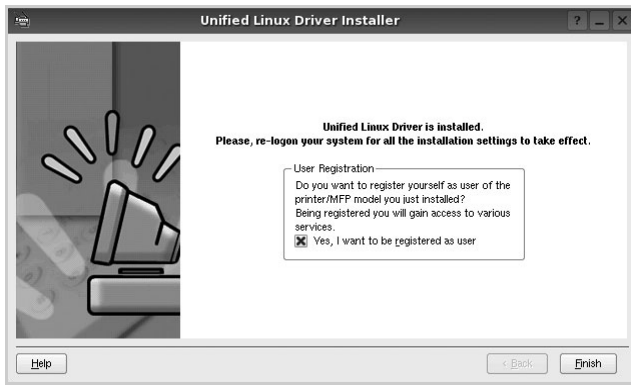

The installation program has added the Unified Driver Configurator desktop icon and Samsung Unified Driver group to the system menu for your convenience. If you have any difficulties, consult the onscreen help that is available through your system menu or can otherwise be called from the driver package windows applications, such as **Unified Driver Configurator** or **Image Manager**.

Uninstalling the Unified Linux Driver

- 1 When the Administrator Login window appears, type in *root* in the Login field and enter the system password.

NOTE: You must log in as a super user (*root*) to install the printer software. If you are not a super user, ask your system administrator.

- 2 Insert the printer software CD-ROM. The CD-ROM will automatically run.

If the CD-ROM does not automatically run, click the  icon at the bottom of the desktop. When the Terminal screen appears, type in:

If the CD-ROM is secondary master and the location to mount is `/mnt/cdrom`,

```
[root@localhost root]#mount -t iso9660 /dev/hdc /mnt/cdrom
```

```
[root@localhost root]#cd /mnt/cdrom/Linux
```

```
[root@localhost root]#./uninstall.sh
```

NOTE: The installation program runs automatically if you have an autorun software package installed and configured.

- 3 Click **Uninstall**.
- 4 Click **Next**.

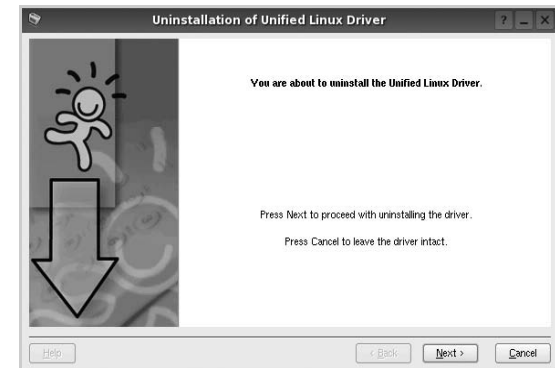

- 5 Click **Finish**.

Using the Unified Driver Configurator

Unified Linux Driver Configurator is a tool primarily intended for configuring Printer or MFP devices. Since an MFP device combines the printer and scanner, the Unified Linux Driver Configurator provides options logically grouped for printer and scanner functions. There is also a special MFP port option responsible for the regulation of access to an MFP printer and scanner via a single I/O channel.

After installing the Unified Linux driver (see page A.3), the Unified Linux Driver Configurator icon will automatically be created on your desktop.

Opening the Unified Driver Configurator

- 1 Double-click **Unified Driver Configurator** on the desktop.
You can also click the Startup Menu icon and select **Samsung Unified Driver** and then **Unified Driver Configurator**.
- 2 Press each button on the Modules pane to switch to the corresponding configuration window.

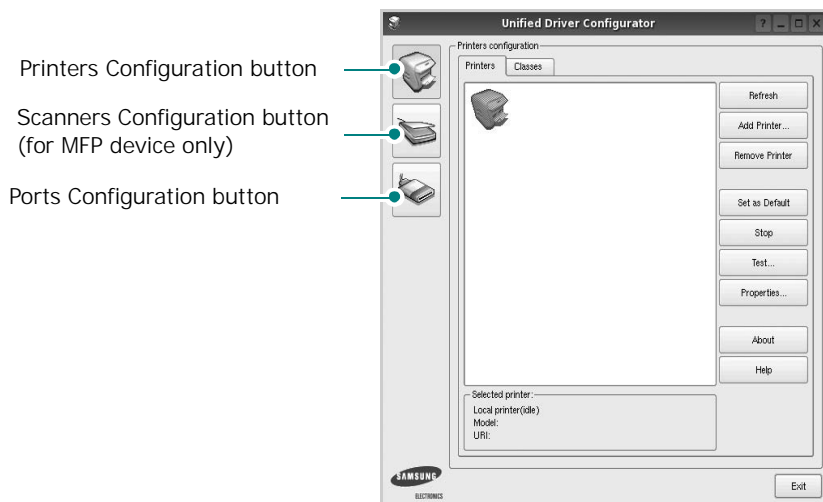

- 3 You can use the onscreen help by clicking **Help**.
After changing the configurations, click **Exit** to close the Unified Driver Configurator.

Printers Configuration

Printers configuration has the two tabs; **Printers** and **Classes**.

Printers Tab

You can see the current system's printer configuration by clicking on the printer icon button on the left side of the Unified Driver Configurator window.

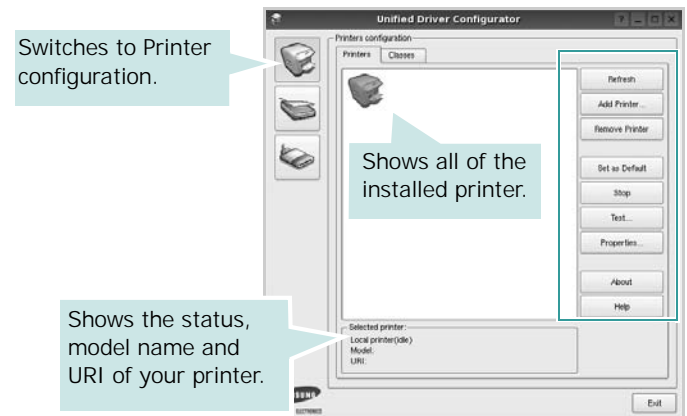

You can use the following printer control buttons:

- **Refresh:** renews the available printers list.
- **Add Printer:** allows you to add a new printer.
- **Remove Printer:** removes the selected printer.
- **Set as Default:** sets the current printer as a default printer.
- **Stop/Start:** stops/starts the printer.
- **Test:** allows you to print a test page to check if the machine is working properly.
- **Properties:** allows you to view and change the printer properties. For details, see page 36.

Classes Tab

The Classes tab shows a list of available printer classes.

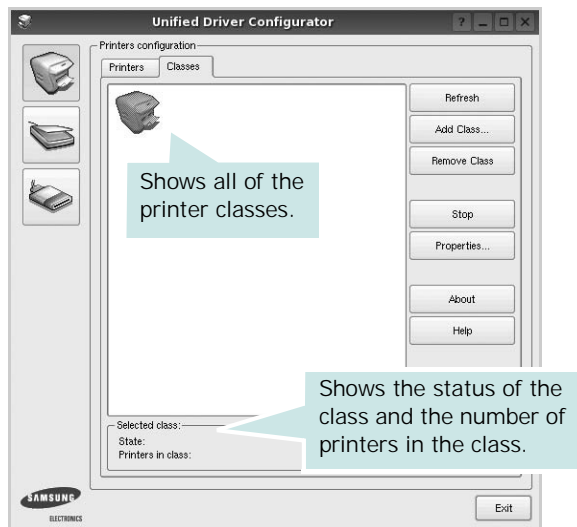

- **Refresh** : Renews the classes list.
- **Add Class...** : Allows you to add a new printer class.
- **Remove Class** : Removes the selected printer class.

Scanners Configuration (for MFP device only)

In this window, you can monitor the activity of scanner devices, view a list of installed Samsung MFP devices, change device properties, and scan images.

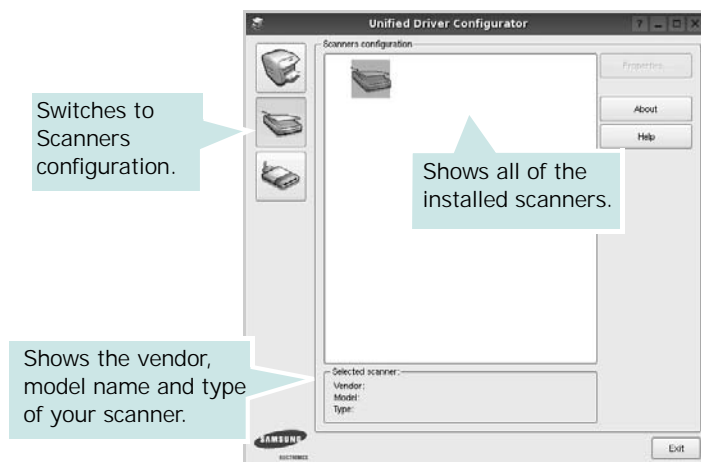

- **Properties...** : Allows you to change the scan properties and scan a document. See page 37.
- **Drivers...** : Allows you to monitor the activity of the scan drivers.

Ports Configuration

In this window, you can view the list of available ports, check the status of each port and release a port that is stalled in busy state when its owner is terminated for any reason.

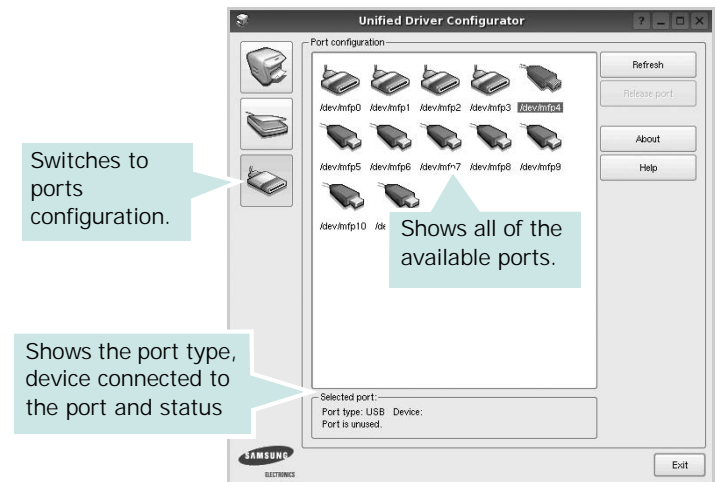

- **Refresh** : Renews the available ports list.
- **Release port** : Releases the selected port.

Sharing Ports Between Printers and Scanners (for MFP device only)

Your machine may be connected to a host computer via the parallel port or USB port. Since the MFP device contains more than one device (printer and scanner), it is necessary to organize proper access of "consumer" applications to these devices via the single I/O port.

The Samsung Unified Linux Driver package provides an appropriate port sharing mechanism that is used by Samsung printer and scanner drivers. The drivers address their devices via so-called MFP ports. The current status of any MFP port can be viewed via the Ports Configuration. The port sharing prevents you from accessing one functional block of the MFP device, while another block is in use.

When you install a new MFP device onto your system, it is strongly recommended you do this with the assistance of an Unified Driver Configurator. In this case you will be asked to choose I/O port for the new device. This choice will provide the most suitable configuration for MFP's functionality. For MFP scanners I/O ports are being chosen by scanner drivers automatically, so proper settings are applied by default.

Configuring Printer Properties

Using the properties window provided by the Printers configuration, you can change the various properties for your machine as a printer.

- 1 Open the Unified Driver Configurator.
If necessary, switch to Printers configuration.
- 2 Select your machine on the available printers list and click **Properties**.
- 3 The Printer Properties window opens.

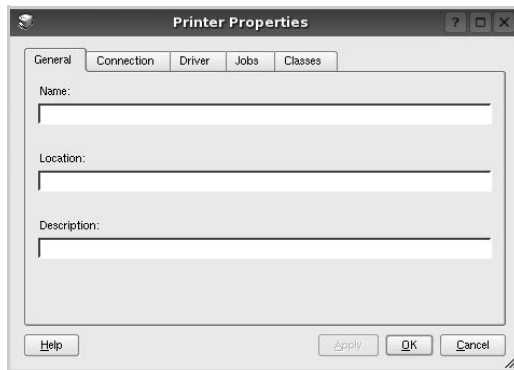

The following five tabs display at the top of the window:

- **General:** allows you to change the printer location and name. The name entered in this tab displays on the printer list in Printers configuration.
 - **Connection:** allows you to view or select another port. If you change the printer port from USB to parallel or vice versa while in use, you must re-configure the printer port in this tab.
 - **Driver:** allows you to view or select another printer driver. By clicking **Options**, you can set the default device options.
 - **Jobs:** shows the list of print jobs. Click **Cancel job** to cancel the selected job and select the **Show completed jobs** check box to see previous jobs on the job list.
 - **Classes:** shows the class that your printer is in. Click **Add to Class** to add your printer to a specific class or click **Remove from Class** to remove the printer from the selected class.
- 4 Click **OK** to apply the changes and close the Printer Properties Window.

Printing a Document

Printing from Applications

There are a lot of Linux applications that you are allowed to print from using Common UNIX Printing System (CUPS). You can print on your machine from any such application.

- 1 From the application you are using, select **Print** from the **File** menu.
- 2 Select **Print** directly using **lpr**.
- 3 In the LPR GUI window, select the model name of your machine from the Printer list and click **Properties**.

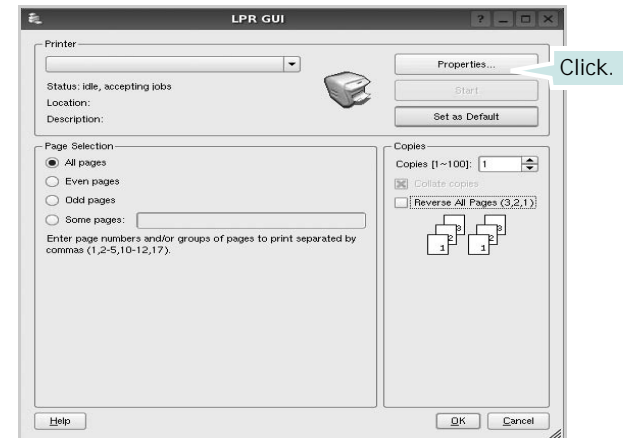

- 4 Change the printer and print job properties.



The following four tabs display at the top of the window.

- **General** - allows you to change the paper size, the paper type, and the orientation of the documents, enables the duplex feature, adds start and end banners, and changes the number of pages per sheet.
- **Text** - allows you to specify the page margins and set the text options, such as spacing or columns.
- **Graphics** - allows you to set image options that are used when printing images/files, such as color options, image size, or image position.
- **Device**: allows you to set the print resolution, paper source, and destination.

- 5 Click **OK** to apply the changes and close the Properties window.
- 6 Click **OK** in the LPR GUI window to start printing.
- 7 The Printing window appears, allowing you to monitor the status of your print job.

To abort the current job, click **Cancel**.

Printing Files

You can print many different types of files on the Samsung machine device using the standard CUPS way - directly from the command line interface. The CUPS `lpr` utility allows you to do that. But the drivers package replaces the standard `lpr` tool by a much more user-friendly Samsung LPR program.

To print any document file:

- 1 Type `lpr <file_name>` from the Linux shell command line and press **Enter**. The LPR GUI window appears.

When you type only `lpr` and press **Enter**, the Select file(s) to print window appears first. Just select any files you want to print and click **Open**.
- 2 In the LPR GUI window, select your printer from the list, and change the printer and print job properties.

For details about the properties window, see page 36.
- 3 Click **OK** to start printing.

Scanning a Document (for MFP device only)

You can scan a document using the Unified Driver Configurator window.

- 1 Double-click the Unified Driver Configurator on your desktop.
- 2 Click the  button to switch to Scanners Configuration.
- 3 Select the scanner on the list.



When you have only one MFP device and it is connected to the computer and turned on, your scanner appears on the list and is automatically selected.

If you have two or more scanners attached to your computer, you can select any scanner to work at any time. For example, while acquisition is in progress on the first scanner, you may select the second scanner, set the device options and start the image acquisition simultaneously.

NOTE: The scanner name shown in Scanners configuration can be different from the device name.

- 4 Click **Properties**.
- 5 Load the document to be scanned face up into the ADF (Automatic Document Feeder) or face down on the document glass.
- 6 Click **Preview** in the Scanner Properties window.

The document is scanned and the image preview appears in the Preview Pane.

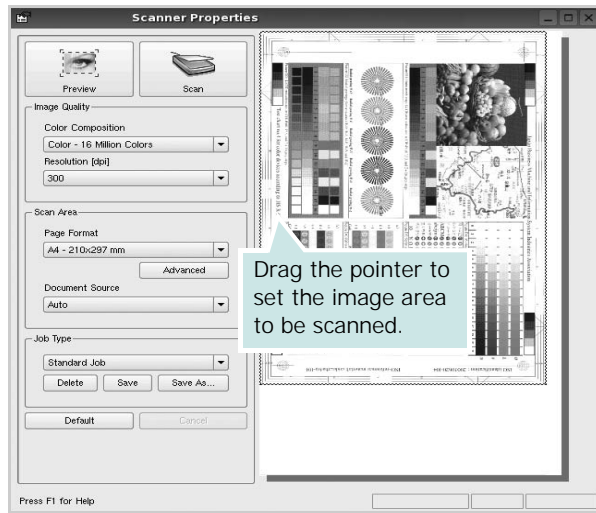

- 7 Change the scan options in the Image Quality and Scan Area sections.

- **Image Quality:** allows you to select the color composition and the scan resolution for the image.
- **Scan Area:** allows you to select the page size. The **Advanced** button enables you to set the page size manually.

If you want to use one of the preset scan option settings, select from the Job Type drop-down list. For details about the preset Job Type settings, see page 38.

You can restore the default setting for the scan options by clicking **Default**.

- 8 When you have finished, click **Scan** to start scanning.

The status bar appears on the bottom left of the window to show you the progress of the scan. To cancel scanning, click **Cancel**.

- 9 The scanned image appears in the new Image Manager tab.

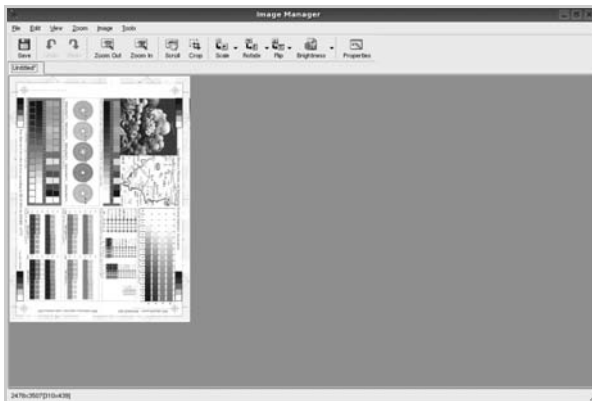

If you want to edit the scanned image, use the toolbar. For further details about editing an image, see page 38.

- 10 When you are finished, click **Save** on the toolbar.
- 11 Select the file directory where you want to save the image and enter the file name.
- 12 Click **Save**.

Adding Job Type Settings

You can save your scan option settings to retrieve for a later scanning.

To save a new Job Type setting:

- 1 Change the options from the Scanner Properties window.
- 2 Click **Save As**.
- 3 Enter the name for your setting.
- 4 Click **OK**.

Your setting is added to the Saved Settings drop-down list.

To save a Job Type setting for the next scan job:

- 1 Select the setting you want to use from the Job Type drop-down list.
- 2 Click **Save**.

The next time you open the Scanner Properties window, the saved setting is automatically selected for the scan job.

To delete a Job Type setting:

- 1 Select the setting you want to delete from the Job Type drop-down list.
- 2 Click **Delete**.







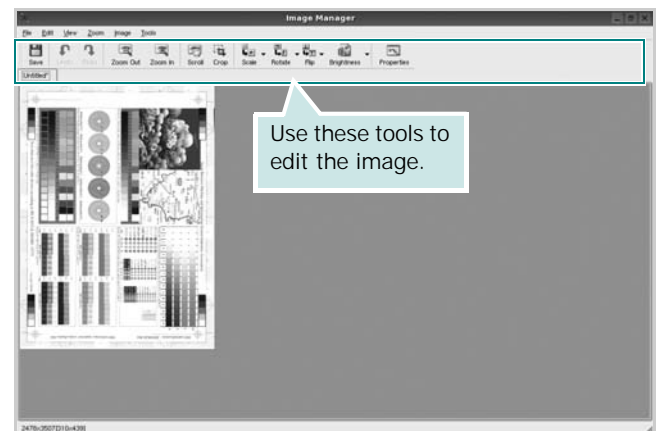





The setting is deleted from the list

Using the Image Manager

The Image Manager application provides you with menu commands and tools to edit your scanned image.



You can use the following tools to edit the image:

Tools	Function
 Save	Saves the image.
 Undo	Cancels your last action.
 Redo	Restores the action you canceled.
 Scroll	Allows you to scroll through the image.
 Crop	Crops the selected image area.
 Zoom Out	Zooms the image out.
 Zoom In	Zooms the image in.
 Scale	Allows you to scale the image size; you can enter the size manually, or set the rate to scale proportionally, vertically, or horizontally.
 Rotate	Allows you to rotate the image; you can select the number of degrees from the drop-down list.
 Flip	Allows you to flip the image vertically or horizontally.
 Effect	Allows you to adjust the brightness or contrast of the image, or to invert the image.
 Properties	Shows the properties of the image.

For further details about the Image Manager application, refer to the onscreen help.

10

Using Your Printer with a Macintosh (SCX-5530FN only)

Your machine supports Macintosh systems with a built-in USB interface or a 10/100 Base-TX network interface card. When you print a file from a Macintosh computer, you can use the PostScript driver by installing the PPD file.

NOTE: *Some printers do not support a network interface. Make sure that your printer supports a network interface by referring to Printer Specifications in your Printer User's Guide.*

This chapter includes:

- **Installing Software for Macintosh**
- **Setting Up the Printer**
- **Printing**
- **Scanning**

Installing Software for Macintosh

The PostScript driver CD-ROM that came with your machine provides you with the PPD file to use the PS driver, Apple LaserWriter driver, for printing on a Macintosh computer.

Also, it provides you with the Twain driver for scanning on a Macintosh computer.

- 1** Connect your machine to the computer using the USB cable or the Ethernet cable.
- 2** Turn on your computer and the machine.
- 3** Insert the PostScript driver CD-ROM which came with your machine into the CD-ROM drive.
- 4** Double-click the **Samsung_MFP** on your Macintosh desktop.
- 5** Double-click the **MAC_Installer** folder.
- 6** Double-click the **Samsung_MFP Installer OSX** icon.
- 7** Click **Continue**.
- 8** Click **Install**.
- 9** After the installation is finished, click **Quit**.

Install the Scan driver

- 1 Make sure that you connect your printer to the computer. Turn on your computer and printer.
- 2 Insert the CD-ROM which came with your printer into the CD-ROM drive.
- 3 Double-click **CD-ROM icon** that appears on your Macintosh desktop.
- 4 Double-click the **MAC_Installer** folder.
- 5 Double-click the **Twain** folder.
- 6 Double-click the **Samsung ScanThru Installer** icon.
- 7 Enter the password and click **OK**.
- 8 Click **Continue**.
- 9 Click **Install**.
- 10 After the installation is finished, click **Quit**.

Uninstalling the Scan driver

- 1 Insert the CD-ROM which came with your printer into the CD-ROM drive.
- 2 Double-click **CD-ROM icon** that appears on your Macintosh desktop.
- 3 Double-click the **MAC_Installer** folder.
- 4 Double-click the **Twain** folder.
- 5 Double-click the **Samsung ScanThru Installer** icon.
- 6 Enter the password and click **OK**.
- 7 Click **Continue**.
- 8 Select **Uninstall** from the Installation Type and then Click **Uninstall**.
- 9 When the uninstallation is done, click **Quit**.

Setting Up the Printer

Set up for your printer will be different depending on which cable you use to connect the printer to your computer—the network cable or the USB cable.

For a Network-connected Macintosh

NOTE: *Some printers do not support a network interface. Before connecting your printer, make sure that your printer supports a network interface by referring to Printer Specifications in your Printer User's Guide.*

- 1 Follow the instructions on “Installing Software for Macintosh” on page 40 to install the PPD file on your computer.
- 2 Open **Print Center** or **Printer Setup Utility** from the Utilities folder.
- 3 Click **Add** on the Printer List.
- 4 Select the **AppleTalk** tab.
The name of your machine appears on the list. Select **SEC000xxxxxxxxxx** from the printer box, where the **xxxxxxxxxx** varies depending on your machine.
- 5 Click **Add**.
- 6 If Auto Select does not work properly, select **Samsung** in **Printer Model** and **your printer name** in **Model Name**.
Your machine appears on the Printer List and is set as the default printer.

For a USB-connected Macintosh

- 1 Follow the instructions on “Installing Software for Macintosh” on page 40 to install the PPD file on your computer.
- 2 Open **Print Center** or **Printer Setup Utility** from the Utilities folder.
- 3 Click **Add** on the Printer List.
- 4 Select the **USB** tab.
- 5 Select **your printer name** and click **Add**.
- 6 If Auto Select does not work properly, select **Samsung** in **Printer Model** and **your printer name** in **Model Name**.
Your machine appears on the Printer List and is set as the default printer.

Printing

NOTES:

- The Macintosh printer's properties window that appears in this User's Guide may differ depending on the printer in use. However the composition of the printer properties window is similar.
- *You can check your printer name in the supplied CD-ROM.*

Printing a Document

When you print with a Macintosh, you need to check the printer software setting in each application you use. Follow these steps to print from a Macintosh.

- 1 Open a Macintosh application and select the file you want to print.
- 2 Open the **File** menu and click **Page Setup (Document Setup** in some applications).
- 3 Choose your paper size, orientation, scaling, and other options and click **OK**.

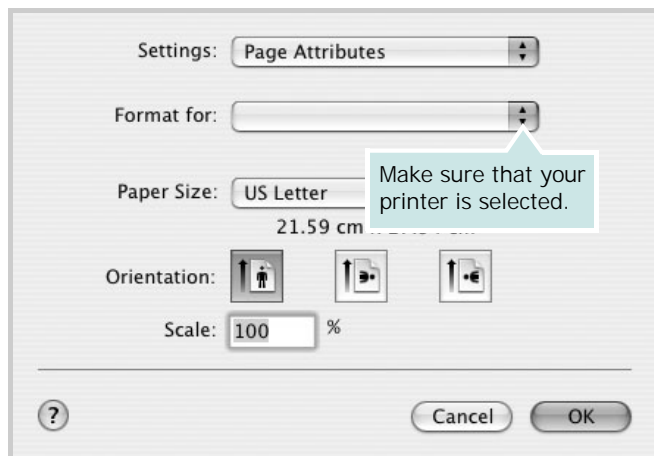

▲ Mac OS 10.3

- 4 Open the **File** menu and click **Print**.
- 5 Choose the number of copies you want and indicate which pages you want to print.
- 6 Click **Print** when you finish setting the options.

Changing Printer Settings

You can use advanced printing features when using your printer.

From your Macintosh application, select **Print** from the **File** menu. The printer name which appears in the printer properties window may differ depending on the printer in use. Except for the name, the composition of the printer properties window is similar.

Layout Setting

The **Layout** tab provides options to adjust how the document appears on the printed page. You can print multiple pages on one sheet of paper.

Select **Layout** from the **Presets** drop-down list to access the following features. For details, see "Printing Multiple Pages on One Sheet of Paper" on the next column.

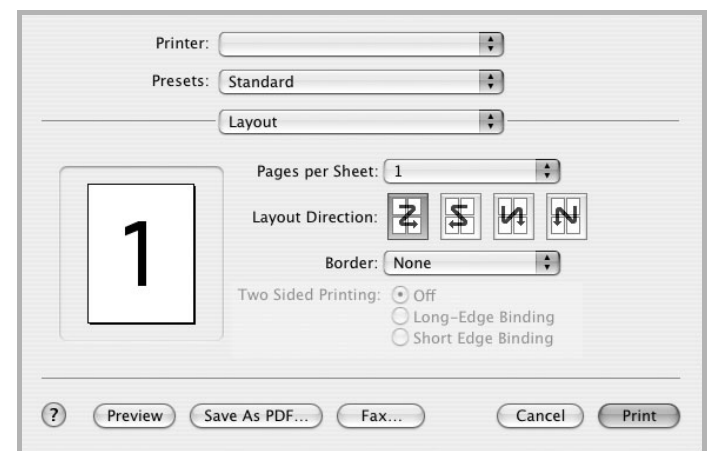

▲ Mac OS 10.3

Printer Features Setting

The **Printer Features** tab provides options for selecting the paper type and adjusting print quality.

Select **Printer Features** from the **Presets** drop-down list to access the following features:



▲ Mac OS 10.3

Image Mode

Image Mode allows the user to enhance printouts. The available options are Normal and Text Enhance.

Fit to Page

This printer feature allows you to scale your print job to any selected paper size regardless of the digital document size. This can be useful when you want to check fine details on a small document.

Paper Type

Set **Type** to correspond to the paper loaded in the tray from which you want to print. This will let you get the best quality printout. If you load a different type of print material, select the corresponding paper type.

Resolution(Quality)

The Resolution options you can select may vary depending on your printer model. You can select the printing resolution. The higher the setting, the sharper the clarity of printed characters and graphics. The higher setting also may increase the time it takes to print a document.

Printing Multiple Pages on One Sheet of Paper

You can print more than one page on a single sheet of paper. This feature provides a cost-effective way to print draft pages.

- 1 From your Macintosh application, select **Print** from the **File** menu.
- 2 Select **Layout**.

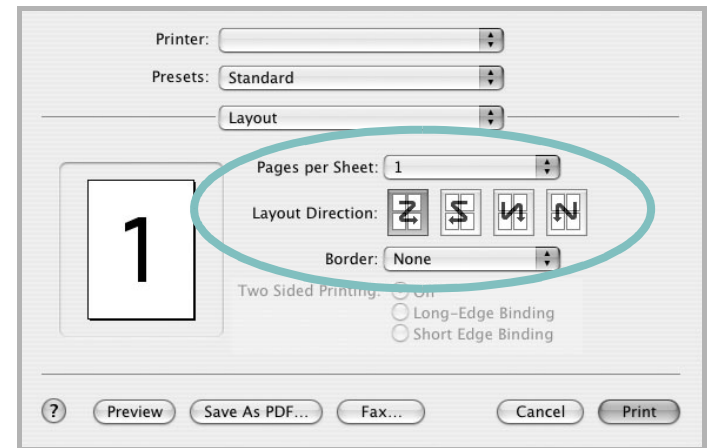

▲ Mac OS 10.3

- 3 Select the number of pages you want to print on one sheet of paper on the **Pages per Sheet** drop-down list.
- 4 Select the page order from the **Layout Direction** option. To print a border around each page on the sheet, select the option you want from the **Border** drop-down list.
- 5 Click **Print**, and the printer prints the selected number of pages on one side of each page.

Duplex Printing

You can print on both sides of the paper. Before printing in the duplex mode, decide on which edge you will be binding your finished document. The binding options are:

Long-Edge Binding: Which is the conventional layout used in book binding.

Short-Edge Binding: Which is the type often used with calendars.

- 1 From your Macintosh application, select **Print** from the **File** menu.
- 2 Select the **Layout**.

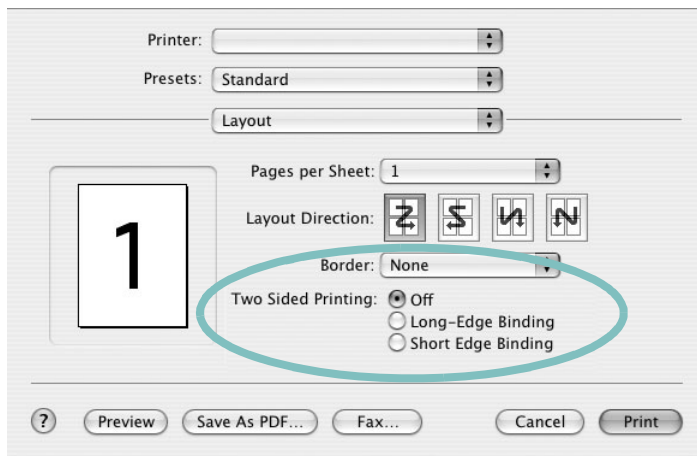

▲ Mac OS 10.3

- 3 Select a binding orientation from **Two Sided Printing** option.
- 4 Click **Print** and the printer prints on both sides of the paper.

CAUTION: If you have selected duplex printing and then try to print multiple copies of a document, the printer may not print the document in the way you want. In case of "Collated copy", if your document has odd pages, the last page of the first copy and the first page of the next copy will be printed on the front and back of one sheet. In case of "Uncollated copy", the same page will be printed on the front and back of one sheet. Therefore, if you need multiple copies of a document and you want those copies on both sides of the paper, you must print them one at a time, as separate print jobs.

Scanning

If you want to scan documents using other software, you will need to use TWAIN-compliant software, such as Adobe PhotoDeluxe or Adobe Photoshop. The first time you scan with your machine, select it as your TWAIN source in the application you use.

The basic scanning process involves a number of steps:

- Place your photograph or page on the document glass or ADF.
- Open an application, such as PhotoDeluxe or Photoshop.
- Open the TWAIN window and set the scan options.
- Scan and save your scanned image.

NOTE: You need to follow the program's instructions for acquiring an image. Please refer to the User's Guide of the application.

SOFTWARE SECTION

INDEX

A

advanced printing, use 19

B

booklet printing 20

C

canceling
scan 31

D

document, print
Macintosh 42
Windows 13
double-sided printing 21

E

Extras properties, set 17

F

favorites settings, use 18

G

Graphics properties, set 16

H

help, use 18, 24

I

install
printer driver
Macintosh 40
Windows 5
installing
Linux software 32

L

Layout properties, set
Macintosh 42
Windows 14
Linux
driver, install 32
printer properties 36
printing 36
scanning 37

M

Macintosh
driver
install 40
printing 42
scanning 44
setting up the printer 41
MFP driver, install
Linux 32

N

n-up printing
Macintosh 43
Windows 19

O

orientation, print 37
Windows 14
overlay
create 23
delete 23
print 23

P

Paper properties, set 15
paper size, set 15
print 37
paper source, set 37
Windows 15

paper tray, set
copy 25
paper type, set
Macintosh 43
print 37
poster, print 20
PostScript driver
installing 24
print
document 13
fit to page 21
from Macintosh 42
from Windows 13
N-up
Macintosh 43
Windows 19
overlay 23
poster 22
PRN 13
scaling 21
watermark 22
print resolution 37
printer driver, install
Linux 32
printer properties
Linux 36
printer properties, set
Macintosh 42
Windows 14, 24
printer resolution, set
Macintosh 43
Windows 16
printer software
install
Macintosh 40
Windows 5
uninstall
Windows 12
printing
booklets 20
double-sided 21
from Linux 36

R

resolution
printing 37

S

scanning
Linux 37
SmarThru 29
TWAIN 31
WIA driver 31
scanning from Macintosh 44
setting
darkness 16
favorites 18
image mode 16
resolution
Macintosh 43
Windows 16
toner save 16
true-type option 16
software
install
Macintosh 40
Windows 5
reinstall
Windows 11
system requirements
Macintosh 40
uninstall
Windows 12
status monitor, use 27

T

toner save, set 16
TWAIN, scan 31

U

uninstall, software
Windows 12
uninstalling
MFP driver
Linux 33

W

watermark
create 22
delete 22
edit 22
print 22
WIA, scan 31

