

SCX-5835NX_5935NX Series

Multi Functional Printer User's Guide

imagine the possibilities

Thank you for purchasing a Samsung product.

SAMSUNG

copyright

© 2010 Samsung Electronics Co., Ltd. All rights reserved.

This user's guide is provided for information purposes only. All information included herein is subject to change without notice.

Samsung Electronics is not responsible for any direct or indirect damages, arising from or related to use of this user's guide.

- Samsung and Samsung logo are trademarks of Electronics Co., Ltd.
- PCL and PCL 6 are trademarks of Hewlett-Packard Company.
- Microsoft, Windows, Windows Vista, Windows 7 and Windows 2008 Server R2 are either registered trademarks or trademarks of Microsoft Corporation.
- PostScript 3 is a trademark of Adobe System, Inc.
- UFST® and MicroType™ are registered trademarks of Monotype Imaging Inc.
- TrueType, LaserWriter and Macintosh are trademarks of Apple Computer, Inc.
- All other brand or product names are trademarks of their respective companies or organizations.
- Refer to the 'LICENSE.txt' file in the provided CD-ROM for the open source license information.

REV.1.01

safety information









These warnings and precautions are included in order to prevent injury to you and others, as well as preventing any potential damage to your machine. Be sure to read and understand all of these instructions before using the machine.

Use common sense for operating any electrical appliance and whenever using your machine. Also, follow all warnings and instructions marked on the machine and in the accompanying literature. After reading this section, keep it in a safe place for future reference.

IMPORTANT SAFETY SYMBOLS

This section explains the meanings of all icons and signs in the user's guide. These safety symbols are in order, according to the degree of danger.

Explanation of all icons and signs used in the user's guide:

	Warning	Hazards or unsafe practices that may result in severe personal injury or death.
	Caution	Hazards or unsafe practices that may result in minor personal injury or property damage.
		Do not attempt.
		Do not disassemble.
		Do not touch.
		Unplug the power cord from the wall socket.
		Make sure the machine is grounded to prevent electric shock.
		Call the service center for help.
		Follow directions explicitly.

OPERATING ENVIRONMENT

Warning



Do not use if the power cord is damaged or if the electrical outlet is not grounded.
▶ This could result in electric shock or fire.

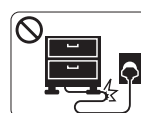

Do not bend, or place heavy objects on the power cord.
▶ Stepping on or allowing the power cord to be crushed by a heavy object could result in electric shock or fire.



Do not place anything on top of the machine (water, small metal or heavy objects, candles, lit cigarettes, etc.).
▶ This could result in electric shock or fire.



Do not remove the plug by pulling on the cord; do not handle the plug with wet hands.
▶ This could result in electric shock or fire.

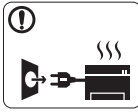

If the machine gets overheated, it releases smoke, makes strange noises, or generates an odd odor, immediately turn off the power switch and unplug the machine.

► This could result in electric shock or fire.

Caution

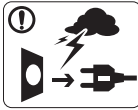



During an electrical storm or for a period of non-operation, remove the power plug from the electrical outlet.

► This could result in electric shock or fire.

-  Be careful, the paper output area is hot.
 - Burns could occur.

-  If the machine has been dropped, or if the cabinet appears damaged, unplug the machine from all interface connections and request assistance from qualified service personnel.
 - Otherwise, this could result in electric shock or fire..

-  If the machine exhibits a sudden and distinct change in performance, unplug the machine from all interface connections and request assistance from qualified service personnel.
 - Otherwise, this could result in electric shock or fire.

-  If the plug does not easily enter the electrical outlet, do not attempt to force it in.
 - Call an electrician to change the electrical outlet, or this could result in electric shock.

-  Do not allow pets to chew on the AC power, telephone or PC interface cords.
 - This could result in electric shock or fire.

-  If the machine does not operate properly after these instructions have been followed, unplug the machine from all interface connections and request assistance from qualified service personnel.
 - Otherwise, this could result in electric shock or fire.

OPERATING METHOD

Caution





Do not forcefully pull the paper out during printing.

- It can cause damage to the machine.



Be careful not to put your hand between the machine and paper tray.

- You may get injured.

-  Do not block or push objects into the ventilation opening.
 - This could result in elevated component temperatures which can cause damage or fire.
-  Use care to avoid paper cuts when replacing paper or removing jammed paper.
 - You may get hurt.





When printing large quantities, the bottom part of the paper output area may get hot. Do not allow children to touch.

- You (children) may be burned.



When removing jammed paper, do not use tweezers or sharp metal objects.

- It can cause damage to the machine.

-  Do not allow too many papers to stack up in the paper output tray.
 - It could cause damage to the machine.
-  This machine's power interception device is the power cord.
 - To switch off the power supply, remove the power cord from the electrical outlet.

INSTALLATION / MOVING

Warning

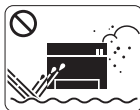

Do not place the machine in an area with dust, humidity or water leaks.

▶ This could result in electric shock or fire.

Caution



When moving the machine, turn the power off and disconnect all cords; then lift the machine with at least two people.

▶ The machine could fall, causing human injury or machine damage.



Do not place the machine on an unstable surface.

▶ The machine could fall, causing human injury or machine damage.



The machine should be connected to the power level which is specified on the label.

▶ If you are unsure and want to check the power level you are using, contact the electrical utility company.



Use only No.26 AWG^a or larger, telephone line cord, if necessary.

▶ Otherwise, it can cause damage to the machine.



Do not put a cover over the machine or place it in an airtight location, such as a closet.

▶ If the machine is not well-ventilated, this could result in fire.



Make sure you plug the power cord into a grounded electrical outlet.

▶ Otherwise, this could result in electric shock or fire.



Do not overload wall outlets and extension cords.

▶ This can diminish performance, and could result in electric shock or fire.



Use the power cord supplied with your machine for safe operation. If you are using a cord which is longer than 2 meters (79") with a 140V machine, then the gauge should be 16 AWG or larger.

▶ Otherwise, it can cause damage to the machine, and could result in electric shock or fire.

a. AWG: American Wire Gauge

MAINTENANCE / CHECKING

Caution



Unplug this product from the wall outlet before cleaning the inside of the machine. Do not clean the machine with benzene, paint thinner or alcohol; do not spray water directly into the machine.

▶ This could result in electric shock or fire.



Keep cleaning supplies away from children.

▶ Children (you) may get hurt.



When you are working inside the machine replacing supplies or cleaning the inside, do not operate the machine.

▶ You may get injured.



Do not disassemble, repair or rebuild the machine by yourself.

▶ It can cause damage to the machine. Call a certified technician when the machine needs repair.

- ⚠ Keep the power cable and the contact surface of the plug clean from dust or water.
 - ▶ This could result in electric shock or fire.

- ⊗ Do not remove any covers or guards that are fastened with screws.
 - ▶ The machine should only be repaired by Samsung service technician.

- ⚠ To clean and operate the machine, strictly follow the user's guide provided with the machine.
 - ▶ Otherwise, it can cause damage to the machine.

SUPPLY USAGE

Caution



- Do not disassemble the toner cartridge.
 - ▶ Toner dust can be dangerous to humans.



- Do not burn any of the supplies such as toner cartridge or fuser unit.
 - ▶ It can cause an explosion or fire.

- ⚠ When changing the toner cartridge or removing jammed paper, be careful not to let toner dust touch your body or clothes.
 - ▶ Toner dust can be dangerous to humans.



- When storing supplies such as toner cartridges, keep them away from children.
 - ▶ Toner dust can be dangerous to humans.

- ⊘ Using recycled supplies, such as toner, can cause damage to the machine.
 - ▶ In case of damage due to the use of recycled supplies, a service fee will be charged.

regulatory information

This machine is designed for our sound environment and certified with several regulatory statements.

LASER SAFETY STATEMENT

The printer is certified in the U.S. to conform to the requirements of DHHS 21 CFR, chapter 1 Subchapter J for Class I(1) laser products, and elsewhere is certified as a Class I laser product conforming to the requirements of IEC 825.

Class I laser products are not considered to be hazardous. The laser system and printer are designed so there is never any human access to laser radiation above a Class I level during normal operation, user maintenance or prescribed service condition.

WARNING

Never operate or service the printer with the protective cover removed from Laser/Scanner assembly. The reflected beam, although invisible, can damage your eyes.

When using this product, these basic safety precautions should always be followed to reduce risk of fire, electric shock, and injury to persons:



CAUTION - CLASS 3B LASER RADIATION WHEN OPEN
AVOID EXPOSURE TO THE BEAM.

DANGER - LASER RADIATION AVOID DIRECT
EXPOSURE TO BEAM.

DANGER - RADIATIONS INVISIBLES DU LASER EN CAS
D'OUVERTURE. EVITER TOUTE EXPOSITION
DIRECTE AU FAISCEAU.

VORSICHT - UNSICHTBARE LASERSTRAHLUNG, WENN
ABDECKUNG GEÖFFNET.
NICHT DEM STRAHL AUSSETZEN.

ATTENZIONE - RADIAZIONE LASER INVISIBILE IN CASO DI
APERTURA. EVITARE L'ESPOSIZIONE AL FASCIO.

PRECAUCIÓN - RADIACIÓN LASER INVISIBLE CUANDO SE ABRE.
EVITAR EXPONERSE AL RAYO.

PERIGO - RADIAÇÃO LASER INVISÍVEL AO ABRIR, EVITE
EXPOSIÇÃO DIRECTA AO FEIXE.

GEVAAR - ONZICHTBARE LASERSTRALEN BIJ GEOPENDE
KLEP. DEZE KLEP NIET OPENEN.

ADVARSEL - USYNLIG LASERSTRÅLNING VED ÅBNING.
UNNGÅ UDSAETTELSE FOR STRÅLNING.

ADVARSEL - USYNLIG LASERSTRÅLNING NÅR DEKSEL
ÅPNES. UNNGÅ EKSPONERING FOR STRÅLEN.

VARNING - OSYNLIG LASERSTRÅLNING NÅR DENNA DEL
ÄR ÖPPEN. STRÅLEN ÄR FARLIG.

VAROITUS - NÄKYMÄTÖNTÄ LASERSÄTELYÄ AVATTAESSA.
VARO SUORAA ALTISTUMISTA SÄTEELLE.

注意 - 严禁揭开此盖, 以免激光泄露灼伤

주의 - 이 덮개를 열면 레이저광에 노출될 수 있으므로
주의하십시오.

TAIWAN ONLY

警告使用者：

此為甲類資訊技術設備，於居住環境中使用時，可能會造成射頻擾動，在此種情況下，使用者會被要求採取某此適當的對策。

OZONE SAFETY



During normal operation, this machine produces ozone. The ozone produced does not present a hazard to the operator. However, it is advisable that the machine be operated in a well ventilated area.

If you need additional information about ozone, request your nearest Samsung dealer.

MERCURY SAFETY



Contains Mercury, Dispose According to Local, State or Federal Laws.(U.S.A. only)

PERCHLORATE WARNING

This Perchlorate warning applies only to primary CR (Manganese Dioxide) Lithium coin cells in the product sold or distributed ONLY in California USA.

Perchlorate Material - special handling may apply.

See www.dtsc.ca.gov/hazardouswaste/perchlorate. (U.S.A. only)

RECYCLING



Recycle or dispose of the packaging material for this product in an environmentally responsible manner.

CHINA ONLY

回收和再循环

为了保护环境，我公司已经为废弃的产品建立了回收和再循环系统。

我们会为您无偿提供回收同类废旧产品的服务。

当您要废弃您正在使用的产品时，请您及时与工厂取得联系，

我们会及时为您提供服务。

CORRECT DISPOSAL OF THIS PRODUCT (WASTE ELECTRICAL & ELECTRONIC EQUIPMENT)

(Applicable in the European Union and other European countries with separate collection systems)



This marking shown on the product or its literature, indicates that it should not be disposed with other household wastes at the end of its working life. To prevent possible harm to the environment or human health from uncontrolled waste disposal, separate this from other types of wastes and recycle it responsibly to promote the sustainable reuse of material resources.

Household users should contact either the retailer where they purchased this product, or their local government office, for details of where and how they can take this item for environmentally safe recycling.

Business users should contact their supplier and check the terms and conditions of the purchase contract. This product should not be mixed with other commercial wastes for disposal.

CORRECT DISPOSAL OF BATTERIES IN THIS PRODUCT

(Applicable in the European Union and other European countries with separate battery return systems.)



This marking on the battery, manual or packaging indicates that the batteries in this product should not be disposed of with other household waste at the end of their working life. Where marked, the chemical symbols Hg, Cd or Pb indicate that the battery contains mercury, cadmium or lead above the reference levels in EC Directive 2006/66. If batteries are not properly disposed of, these substances can cause harm to human health or the environment.

To protect natural resources and to promote material reuse, please separate batteries from other types of waste and recycle them through your local, free battery return system.

RADIO FREQUENCY EMISSIONS

FCC Information to the User

This device complies with Part 15 of the FCC Rules. Operation is subject to the following two conditions:

- This device may not cause harmful interference, and
- This device must accept any interference received, including interference that may cause undesired operation.

This equipment has been tested and found to comply with the limits for a Class A digital device, pursuant to Part 15 of the FCC Rules. These limits are designed to provide reasonable protection against harmful interference in a residential installation. This equipment generates, uses and can radiate radio frequency energy and, if not installed and used in accordance with the instructions, may cause harmful interference to radio communications. However, there is no guarantee that interference will not occur in a particular installation. If this equipment does cause harmful interference to radio or television reception, which can be determined by turning the equipment off and on, the user is encouraged to try to correct the interference by one or more of the following measures:

- Reorient or relocate the receiving antenna.
- Increase the separation between the equipment and receiver.
- Connect the equipment into an outlet on a circuit different from that to which the receiver is connected.
- Consult the dealer or experienced radio TV technician for help.

 Change or modifications not expressly approved by the manufacturer responsible for compliance could void the user's authority to operate the equipment.

Canadian Radio Interference Regulations

This digital apparatus does not exceed the Class A limits for radio noise emissions from digital apparatus as set out in the interference-causing equipment standard entitled "Digital Apparatus", ICES-003 of the Industry and Science Canada.

Cet appareil numérique respecte les limites de bruits radioélectriques applicables aux appareils numériques de Classe A prescrites dans la norme sur le matériel brouilleur: "Appareils Numériques", ICES-003 édictée par l'Industrie et Sciences Canada.

RFID (RADIO FREQUENCY INTERFACE DEVICE)

RFID operation is subject to the following two conditions:(1) this device may not cause interference, and (2) this device must accept any interference, including interference that may cause undesired operation of the device. (U.S.A., France, Taiwan only)

TAIWAN ONLY

低功率電波輻射性電機管理辦法

- 第十二條** 經型式認證合格之低功率射頻電機，非經許可，公司、商號或使用者均不得擅自變更頻率、加大功率或變更原設計之特性及功能。
- 第十四條** 低功率射頻電機之使用不得影響飛航安全及干擾合法通信；經發現有干擾現象時，應立即停用，並改善至無干擾時方得繼續使用。前項合法通信，指依電信法規定作業之無線電通信。低功率射頻電機須忍受合法通信或工業、科學及醫療用電波輻射性電機設備之干擾。

RUSSIA ONLY



Минсвязи России



FAX BRANDING

The Telephone Consumer Protection Act of 1991 makes it unlawful for any person to use a computer or other electronic device to send any message via a telephone facsimile machine unless such message clearly contains in a margin at the top or bottom of each transmitted page or on the first page of the transmission the following information:

1. the date and time of transmission
2. identification of either business, business entity or individual sending the message; and
3. telephone number of either the sending machine, business, business entity or individual.

The Telephone Company may make changes in its communications facilities, equipment operations or procedures where such action is reasonably required in the operation of its business and is not inconsistent with the rules and regulations in FCC Part 68. If such changes can be reasonably expected to render any customer terminal equipment incompatible with telephone company communications facilities, or require modification or alteration of such terminal equipment, or otherwise materially affect its use or performance, the customer shall be given adequate notice in writing, to allow the customer an opportunity to maintain uninterrupted service

RINGER EQUIVALENCE NUMBER

The Ringer Equivalence Number and FCC Registration Number for this machine may be found on the label located on the bottom or rear of the machine. In some instances you may need to provide these numbers to the telephone company.

The Ringer Equivalence Number (REN) is a measure of the electrical load placed on the telephone line, and is useful for determining whether you have “overloaded” the line. Installing several types of equipment on the same telephone line may result in problems making and receiving telephone calls, especially ringing when your line is called. The sum of all Ringer Equivalence Numbers of the equipment on your telephone line should be less than five in order to assure proper service from the telephone company. In some cases, a sum of five may not be usable on your line. If any of your telephone equipment is not operating properly, you should immediately remove it from your telephone line, as it may cause harm to the telephone network.

The equipment complies with Part 68 of the FCC rules and the requirements adopted by the ACTA. On the left side of this equipment is a label that contains, among other information, a product identifier in the format US:AAAEQ##TXXXX. If requested, this number must be provided to the telephone company.

 FCC Regulations state that changes or modifications to this equipment not expressly approved by the manufacturer could void the user’s authority to operate this equipment. In the event that terminal equipment causes harm to the telephone network, the telephone company should notify the customer that service may be stopped. However, where prior notice is impractical, the company may temporarily cease service, providing that they:

- a) promptly notify the customer.
- b) give the customer an opportunity to correct the equipment problem.
- c) inform the customer of the right to bring a complaint to the Federal Communication Commission pursuant to procedures set out in FCC Rules and Regulations Subpart E of Part 68.

You should also know that:

- Your machine is not designed to be connected to a digital PBX system.
- If you intend to use a computer modem or fax modem on the same phone line as your machine, you may experience transmission and reception problems with all the equipment. It is recommended that no other equipment, except for a regular telephone, share the line with your machine.
- If your area experiences a high incidence of lightning or power surges, we recommend that you install surge protectors for both the power and the telephone lines. Surge protectors can be purchased from your dealer or telephone and electronic specialty stores.
- When programming emergency numbers and/or making test calls to emergency numbers, use a non-emergency number to advise the emergency service dispatcher of your intentions. The dispatcher will give you further instructions on how to actually test the emergency number.
- This machine may not be used on coin service or party lines.
- This machine provides magnetic coupling to hearing aids.

You may safely connect this equipment to the telephone network by means of a standard modular jack, USOC RJ-11C.

REPLACING THE FITTED PLUG (FOR UK ONLY)

Important

The mains lead for this machine is fitted with a standard (BS 1363) 13 amp plug and has a 13 amp fuse. When you change or examine the fuse, you must re-fit the correct 13 amp fuse. You then need to replace the fuse cover. If you have lost the fuse cover, do not use the plug until you have another fuse cover.

Contact the people from you purchased the machine.

The 13 amp plug is the most widely used type in the UK and should be suitable. However, some buildings (mainly old ones) do not have normal 13 amp plug sockets. You need to buy a suitable plug adaptor. Do not remove the moulded plug.

 If you cut off the moulded plug, get rid of it straight away.

You cannot rewire the plug and you may receive an electric shock if you plug it into a socket.

Important warning:



You must earth this machine.

The wires in the mains lead have the following color code:

- **Green and Yellow:** Earth
- **Blue:** Neutral
- **Brown:** Live

If the wires in the mains lead do not match the colors marked in your plug, do the following:

You must connect the green and yellow wire to the pin marked by the letter "E" or by the safety 'Earth symbol' or colored green and yellow or green.

You must connect the blue wire to the pin which is marked with the letter "N" or colored black.

You must connect the brown wire to the pin which is marked with the letter "L" or colored red.

You must have a 13 amp fuse in the plug, adaptor, or at the distribution board.

DECLARATION OF CONFORMITY (EUROPEAN COUNTRIES)

Approvals and Certifications



The CE marking applied to this product symbolizes Samsung Electronics Co., Ltd. Declaration of Conformity with the following applicable 93/68/EEC Directives of the European Union as of the dates indicated:

The declaration of conformity may be consulted at www.samsung.com/printer, go to Support > Download center and enter your printer name to browse the EuDoC.

January 1, 1995: Council Directive 2006/95/EC Approximation of the laws of the member states related to low voltage equipment.

January 1, 1996: Council Directive 2004/108/EC (92/31/EEC), approximation of the laws of the Member States related to electromagnetic compatibility.

March 9, 1999: Council Directive 1999/5/EC on radio equipment and telecommunications terminal equipment and the mutual recognition of their conformity. A full declaration, defining the relevant Directives and referenced standards can be obtained from your Samsung Electronics Co., Ltd. representative.

EC Certification

Certification to 1999/5/EC Radio Equipment & Telecommunications Terminal Equipment Directive (FAX)

This Samsung product has been self-certified by Samsung for pan-European single terminal connection to the analogue public switched telephone network (PSTN) in accordance with Directive 1999/5/EC. The product has been designed to work with the national PSTNs and compatible PBXs of the European countries:

In the event of problems, you should contact the Euro QA Lab of Samsung Electronics Co., Ltd. in the first instance.

The product has been tested against TBR21. To assist in the use and application of terminal equipment which complies with this standard, the European Telecommunication Standards Institute (ETSI) has issued an advisory document (EG 201 121) which contains notes and additional requirements to ensure network compatibility of TBR21 terminals. The product has been designed against, and is fully compliant with, all of the relevant advisory notes contained in this document.

OPENSSL LICENSE

Copyright (c) 1998-2001 The OpenSSL Project. All rights reserved.

Redistribution and use in source and binary forms, with or without modification, are permitted provided that the following conditions are met:

1. Redistributions of source code must retain the above copyright notice, this list of conditions and the following disclaimer.
2. Redistributions in binary form must reproduce the above copyright notice, this list of conditions and the following disclaimer in the documentation and/or other materials provided with the distribution.
3. All advertising materials mentioning features or use of this software must display the following acknowledgment: "This product includes software developed by the OpenSSL Project for use in the OpenSSL Toolkit. (<http://www.openssl.org/>)"
4. The names "OpenSSL Toolkit" and "OpenSSL Project" must not be used to endorse or promote products derived from this software without prior written permission. For written permission, please contact openssl-core@openssl.org.
5. Products derived from this software may not be called "OpenSSL" nor may "OpenSSL" appear in their names without prior written permission of the OpenSSL Project.
6. Redistributions of any form whatsoever must retain the following acknowledgment: "This product includes software developed by the

OpenSSL Project for use in the OpenSSL Toolkit (<http://www.openssl.org/>)"
THIS SOFTWARE IS PROVIDED BY THE OpenSSL PROJECT ``AS IS" AND ANY EXPRESSED OR IMPLIED WARRANTIES, INCLUDING, BUT NOT LIMITED TO, THE IMPLIED WARRANTIES OF MERCHANTABILITY AND FITNESS FOR A PARTICULAR PURPOSE ARE DISCLAIMED. IN NO EVENT SHALL THE OpenSSL PROJECT OR ITS CONTRIBUTORS BE LIABLE FOR ANY DIRECT, INDIRECT, INCIDENTAL, SPECIAL, EXEMPLARY, OR CONSEQUENTIAL DAMAGES (INCLUDING, BUT NOT LIMITED TO, PROCUREMENT OF SUBSTITUTE GOODS OR SERVICES; LOSS OF USE, DATA, OR PROFITS; OR BUSINESS INTERRUPTION) HOWEVER CAUSED AND ON ANY THEORY OF LIABILITY, WHETHER IN CONTRACT, STRICT LIABILITY, OR TORT (INCLUDING NEGLIGENCE OR OTHERWISE) ARISING IN ANY WAY OUT OF THE USE OF THIS SOFTWARE, EVEN IF ADVISED OF THE POSSIBILITY OF SUCH DAMAGE.
This product includes cryptographic software written by Eric Young(eay@cryptsoft.com). This product includes software written by Tim Hudson (tjh@cryptsoft.com).

ORIGINAL SSLEAY LICENSE

Copyright (C) 1995-1998 Eric Young (eay@cryptsoft.com) All rights reserved.

This package is an SSL implementation written by Eric Young (eay@cryptsoft.com). The implementation was written so as to conform with Netscapes SSL.

This library is free for commercial and non-commercial use as long as the following conditions are aheared to. The following conditions apply to all code found in this distribution, be it the RC4, RSA, lhash, DES, etc., code; not just the SSL code. The SSL documentation included with this distribution is covered by the same copyright terms except that the holder is Tim Hudson (tjh@cryptsoft.com). Copyright remains Eric Young's, and as such any Copyright notices in the code are not to be removed. If this package is used in a product, Eric Young should be given attribution as the author of the parts of the library used. This can be in the form of a textual message at program startup or in documentation (online or textual) provided with the package.

Redistribution and use in source and binary forms, with or without modification, are permitted provided that the following conditions are met:

1. Redistributions of source code must retain the copyright notice, this list of conditions and the following disclaimer.
2. Redistributions in binary form must reproduce the above copyright notice, this list of conditions and the following disclaimer in the documentation and/or other materials provided with the distribution.
3. All advertising materials mentioning features or use of this software must display the following acknowledgement: "This product includes cryptographic software written by Eric Young (eay@cryptsoft.com)" The word 'cryptographic' can be left out if the rouines from the library being used are not cryptographic related:-).
4. If you include any Windows specific code (or a derivative thereof) from the apps directory (application code) you must include an acknowledgement: "This product includes software written by Tim Hudson (tjh@cryptsoft.com)"

THIS SOFTWARE IS PROVIDED BY ERIC YOUNG ``AS IS" AND ANY EXPRESS OR IMPLIED WARRANTIES, INCLUDING, BUT NOT LIMITED TO, THE IMPLIED WARRANTIES OF MERCHANTABILITY AND FITNESS FOR A PARTICULAR PURPOSE ARE DISCLAIMED. IN NO EVENT SHALL THE AUTHOR OR CONTRIBUTORS BE LIABLE FOR ANY DIRECT, INDIRECT, INCIDENTAL, SPECIAL, EXEMPLARY, OR CONSEQUENTIAL DAMAGES (INCLUDING, BUT NOT LIMITED TO, PROCUREMENT OF SUBSTITUTE GOODS OR SERVICES; LOSS OF USE, DATA, OR PROFITS; OR BUSINESS INTERRUPTION) HOWEVER CAUSED AND ON ANY THEORY OF LIABILITY, WHETHER IN CONTRACT, STRICT LIABILITY, OR TORT (INCLUDING NEGLIGENCE OR OTHERWISE) ARISING IN ANY WAY OUT OF THE USE OF THIS SOFTWARE, EVEN IF ADVISED OF THE POSSIBILITY OF SUCH DAMAGE.

The licence and distribution terms for any publically available version or derivative of this code cannot be changed. i.e. this code cannot simply be copied and put under another distribution licence [including the GNU Public Licence.

产品中有毒有害物质或元素的名称及含量

部件名称	有毒有害物质或元素					
	铅 (Pb)	汞 (Hg)	镉 (Cd)	六价铬 (Cr ⁶⁺)	多溴联苯 (PBB)	多溴联苯醚 (PBDE)
塑料	○	○	○	○	○	○
金属 (机箱)	X	○	○	○	○	○
印刷电路部件 (PCA)	X	○	○	○	○	○
电缆 / 连接器	X	○	○	○	○	○
电源设备	X	○	○	○	○	○
电源线	X	○	○	○	○	○
机械部件	X	○	○	○	○	○
卡盒部件	X	○	○	○	○	○
定影部件	X	○	○	○	○	○
扫描仪部件 - CCD (如果有)	X	X	○	○	○	○
扫描仪部件 - 其它 (如果有)	X	○	○	○	○	○
印刷电路板部件 (PBA)	X	○	○	○	○	○
墨粉	○	○	○	○	○	○
滚筒	○	○	○	○	○	○

○：表示该有毒有害物质在该部件所有均质材料中的含量均在 SJ/T 11363-2006 标准规定的限量要求以下。

×：表示该有毒有害物质至少在该部件的某一均质材料中的含量超出 SJ/T 11363-2006 标准规定的限量要求。

以上表为目前本产品含有有毒有害物质的信息。本信息由本公司的配套厂家提供，经本公司审核后而做成，本产品的部分部件含有有毒有害物质，这些部件是在现有科学技术水平下暂时无可替代物质，但三星电子将会一直为满足 SJ/T 11363-2006 标准而做不懈的努力。

about this user's guide

This user's guide provides information about basic understanding of the machine as well as detailed explanation on each step during actual usage. Valuable for both novice and professional users can refer to this as a guide for installing and using the machine.



-  Read the safety information before using the machine.
- If you have a problem using the machine, refer to the troubleshooting chapter. (See "Troubleshooting" on page 101.)
- Terms used in this user's guide are explained in the glossary chapter. (See "Glossary" on page 129.)
- Use Index to find information.
- All illustrations in this user's guide may differ from your machine depending on its options or models.
- The procedures in this user's guide are mainly based on Windows XP.

CONVENTION

Some terms in this guide are used interchangeably, as below:



- Document is synonymous with original.
- Paper is synonymous with media, or print media.
- Machine refers to printer or MFP.

The following table offers the conventions of this guide:

CONVENTION	DESCRIPTION	EXAMPLE
Bold	For texts on the display or button names on the machine.	Start
Note	Provides additional information or detailed specification of the machine function and feature.	 The date format may differ from country to country.
Caution	Gives users information to protect the machine from possible mechanical damage or malfunction.	 Do not touch the green underside of the toner cartridge.
Footnote	Provides additional more detailed information on certain words or a phrase.	a. pages per minute
(“Cross-reference”)	Guides users to a reference page for the additional detailed information.	(See "Finding more information" on page 16.)

FINDING MORE INFORMATION

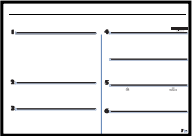
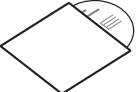
You can find information for setting up and using your machine from the following resources, either as a print-out or on screen.

MATERIAL NAME	DESCRIPTION
Quick Install Guide 	This guide provides information on setting up your machine and this requires that you follow the instructions in the guide to prepare the machine.
Online User's Guide 	This guide provides you with step-by-step instructions for using your machine's full features, and contains information for maintaining your machine, troubleshooting, and installing accessories.
Network Website	You can set the network environment from your computer using network-managing programs, such as SetIP, SyncThru™ Web Admin Service, etc. This Website will be convenient for network administrators who need to manage many machines simultaneously. You can download the SyncThru™ Web Admin Service on http://solution.samsungprinter.com . SetIP program is provided in the software CD.
Driver Help 	This help provides you with help information on printer driver and instructions for setting up the options for printing. (See "Samsung tab" on page 49.)
Samsung website	If you have Internet access, you can get help, support, machine drivers, manuals, and order information from the Samsung website, www.samsungprinter.com .

features of your new product

Your new machine is equipped with a number of special features that improve the quality of the documents you print.

SPECIAL FEATURES

Print with excellent quality and speed



- You can print with a resolution of up to 1200 dpi effective output.
- Your machine prints A4-sized paper at up to 33 ppm and letter-sized paper at up to 35 ppm.
- For duplex printing, your machine prints A4-sized paper at up to 17 ipm and letter-sized paper at up to 18 ipm.

Handle many different types of printable material

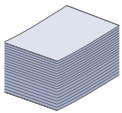

- The multi-purpose tray supports envelopes, labels, custom-sized media, postcards, and heavy paper. The multi-purpose tray holds up to 100 sheets of plain paper.
- The 500-sheet tray 1 and 500-sheet optional tray support plain paper in various sizes.

Create professional documents

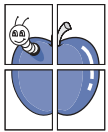

- Print Watermarks. You can customize your documents with words, such as "Confidential". (See "Using watermarks" on page 46.)
- Print Posters. The text and pictures of each page of your document are magnified and printed across the sheet of paper and can then be taped together to form a poster. (See "Printing posters" on page 44.)
- You can use preprinted forms and letterhead with plain paper. (See "Using overlay" on page 46.)

Save time and money

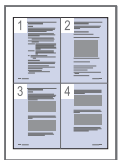

- To save paper, you can print multiple pages on one single sheet of paper. (See "Printing multiple pages on one sheet of paper" on page 44.)
- This machine automatically conserves electricity by substantially reducing power consumption when not in use.
- To save paper, you can print on both sides of the paper (double-sided printing). (See "Printing on both sides of paper" on page 45.)

Expand your machine's capacity

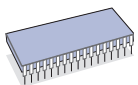

- Your machine has an extra memory slot to expand their memory. (See "Available accessories" on page 118.)
- Zoran IPS Emulation* compatible with PostScript 3 (PS) enables PS printing.

ZORAN* Zoran IPS Emulation compatible with PostScript 3:

©Copyright 1995-2005, Zoran Corporation. All rights reserved. Zoran, the Zoran logo, IPS/PS3, and OneImage are trademarks of Zoran Corporation.

136 PS3 fonts: Contains UFST and MicroType from Monotype Imaging Inc.

Print in various environments



- You can print with various operating system such as Windows, Linux and Macintosh systems.
- Your machine is equipped with a USB interface and a network interface.

Copy originals in several formats

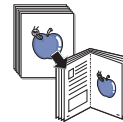

- Your machine can copy multiple image copies from the original document on a single page. (See "2-up or 4-up copying (N-up)" on page 59.)
- There are special functions to erase catalog and newspaper background. (See "Erasing background images" on page 61.)
- The print quality and image size may be adjusted and enhance at the same time.

Scan the originals and send it right away

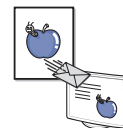

- Scan in color and use the precise compressions of JPEG, TIFF and PDF formats.
- Quickly scan and send files to multiple destinations using Networks scanning. (See "Sending a scanned image to several destinations as an email attachment" on page 72.)

Set a specific time to transmit a Fax

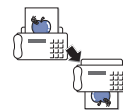

- You can specify a certain time to transmit the fax and also send the fax to several stored destinations.
- After the transmission, the machine may print out the fax reports according to the setting.

Use USB flash memory devices



If you have a USB memory device, you can use it in various ways with your machine.

- You can scan documents and save them to the device.
- You can directly print data stored to the device.

Support XOA applications



The machine supports XOA custom applications.

- Regarding the XOA custom applications, please contact your XOA custom application provider.



FEATURES BY MODELS

The machine is designed to support all of your document needs from printing and copying to more advanced networking solutions for your business. Features by models include:

FEATURES	SCX-5835NX	SCX-5935NX
USB 2.0	•	•
USB Memory Interface	•	•
Document Feeder	•	•
Hard Disk	•	•
Network Interface Ethernet 10/100 Base TX wired LAN	•	•
Duplex (2-sided) printing	•	•
FAX	•	•

(•: Included, Blank: Not available)

introduction

These are the main components of your machine:

This chapter includes:

- Machine overview
- Control panel overview
- Understanding the Status LED
- Introducing the touch screen and useful buttons

MACHINE OVERVIEW

Front view

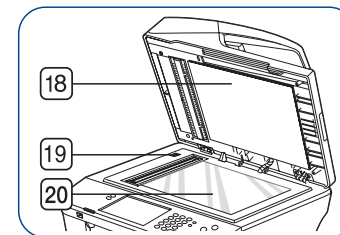
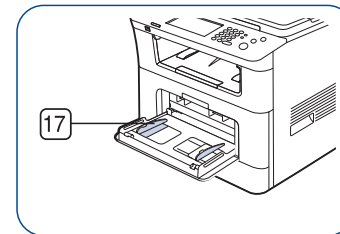
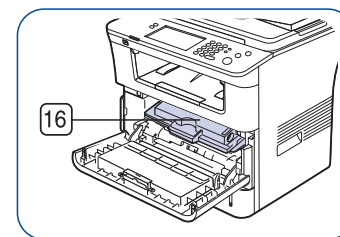
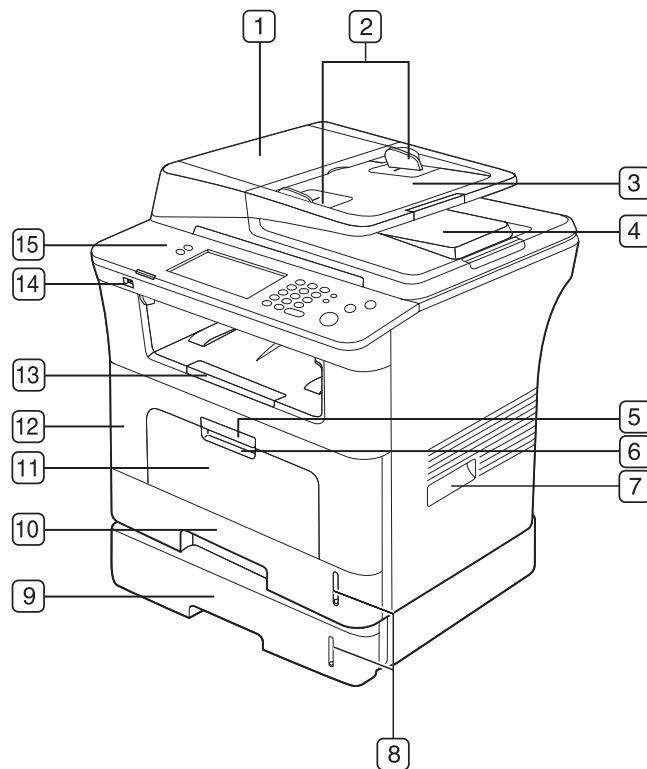

1 Document feeder cover	11 Multi-purpose tray
2 Document feeder width guides	12 Front cover
3 Document feeder input tray	13 Document output tray
4 Document feeder output tray	14 USB memory port
5 Front cover handle	15 Control panel
6 Multi-purpose tray handle	16 Toner cartridge
7 Handle	17 Multi-purpose tray paper width guides
8 Paper level indicator	18 Scanner lid

9 Optional tray 2 ^a	19 Scanner lock switch
10 Tray 1	20 Scanner glass

a. Optional device.

Rear view

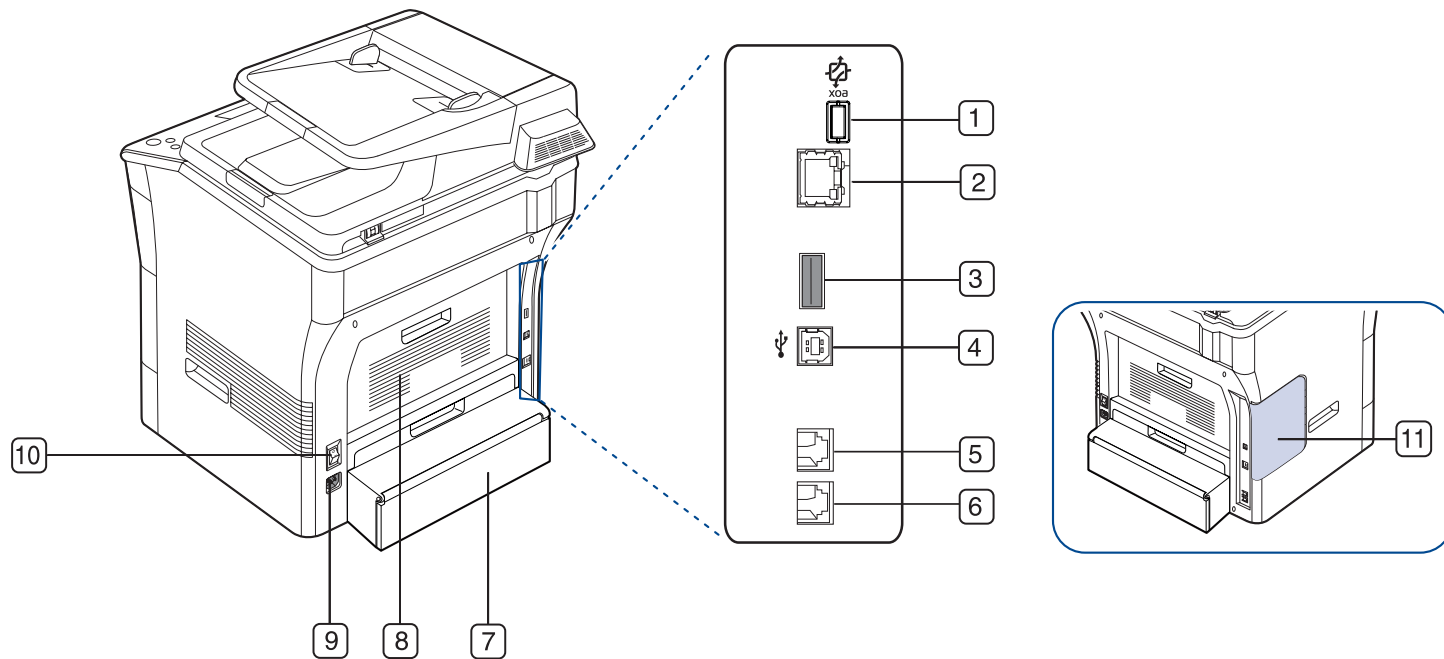

1	XOA port	7	Duplex unit
2	Network port	8	Rear cover
3	USB host port	9	Power receptacle
4	USB port	10	Power-switch
5	Telephone line socket	11	Control board cover
6	Extension telephone socket (EXT)		

CONTROL PANEL OVERVIEW



1	Machine Setup	Guides you to the machine setup and advanced settings. (See "Machine Setup" on page 85.)
2	Job Status	Shows jobs currently running, queued jobs and completed.
3	Status	Shows the status of your machine. (See "Understanding the Status LED" on page 22.)
4	Display screen	Displays machine's current status and prompts during an operation. Set menus easily using the touch screen.
5	Numeric keypad	Dials fax number, and enters the number value for document copies or other options.
6	Clear	Deletes characters in the edit area.
7	Redial/Pause	In standby mode, redials the last number. Also in edit mode, inserts a pause into a fax number.
8	On Hook Dial	Performs same as you hold a handset under the telephone line is engaged.
9	Interrupt	Stops a job in process to do an urgent copy job.
10	Clear All	Reverts the current settings to default values.
11	Power Saver	Sends the machine into power saver mode. You can also turn the power on and off with this button. (See "Power Saver button" on page 23.)
12	Stop	Stops an operation at any time. The pop-up window appears on the screen showing the current job that the user can stop or resume.
13	Start	Starts a job.



When you use the touch screen, use your finger only. The screen may be damaged with a sharpen pen or anything else.

UNDERSTANDING THE STATUS LED

The color of the status LED indicates the machine's current status.

STATUS		DESCRIPTION
Off		<ul style="list-style-type: none"> The machine is off-line. The machine is in power saver mode. When data is received, or any button is pressed, it switches to on-line automatically.
Green	Blinking	<ul style="list-style-type: none"> When the backlight slowly blinks, the machine is receiving data from the computer. When the backlight blinks rapidly, the machine is printing data.
	On	The machine is on-line and can be used.
Red	Blinking	<ul style="list-style-type: none"> A minor error has occurred and the machine is waiting for the error to be cleared. Check the display message. When the problem is cleared, the machine resumes. The toner cartridge is near the end of its life. Order a new toner cartridge. You can temporarily improve print quality by redistributing the toner. (See "Replacing the toner cartridge" on page 119, "Redistributing toner" on page 101.)
	On	<ul style="list-style-type: none"> The toner cartridge is totally empty. Remove the old toner cartridge and install a new one. (See "Replacing the toner cartridge" on page 119.) A paper jam has occurred. (See "Clearing paper jams" on page 103.) The cover is opened. Close the cover. There is no paper in the tray. Load paper in the tray. The machine has stopped due to a major error. Check the display message. (See "Understanding display messages" on page 107.)





 Check the message on the display screen. Follow the instructions in the message or refer to troubleshooting part. (See "Understanding display messages" on page 107.) If the problem persists, call for service.

INTRODUCING THE TOUCH SCREEN AND USEFUL BUTTONS

Touch screen

The touch screen on the control panel allows user-friendly operation of the machine. Once you press the home icon () on the screen, it shows the main screen.



- : Shows Help. You can find the explanation by feature contents.
 - XOA**: Enters the **XOA** menu. (See "XOA button" on page 23.) In order to use this menu, XOA applications should be installed. For more information, contact your local Samsung dealer or the retailer where you purchased your machine.
 - Copy**: Enters the **Copy** menu.
 - Fax**: Enters the **Fax** menu.
 - Scan**: Enters **Scan to Email**, **Scan to PC**, **Scan to Server** menu.
 - Stored Documents**: Enters the **Stored Documents** menu. (See "Checking Stored Documents" on page 98.)
 - USB**: When USB memory is inserted into the USB memory port on your machine, USB icon shows on the display screen.
 - SmarThru Workflow**: Enters the **SmarThru Workflow** menu. (Optional)
 - Toner Info**: Shows amount of toner used.
 - LCD Brightness**: Adjusts the brightness of the touch screen.
 - : Changes the display language on the touch screen.
 - : This icon appears only when you connect a USB memory module.
 - Logout**: Logs out from the currently logged-in account.
-  • Icons shown on the display screen such as **SmarThru Workflow** may be grayed out, depending on the optional kit or program installed in your machine.
- To switch the display screen and see other available icons, press the left/right arrow on the display screen.

Machine Setup button

When you press the **Machine Setup** button, you can browse current machine settings or change machine values. (See "Machine Setup" on page 85.)

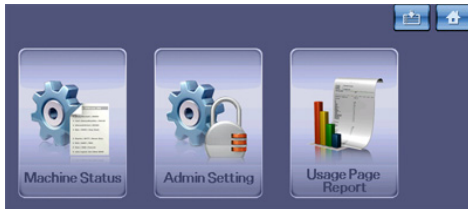

- **Machine Setup**: Allows you to move directly to the **Copy, Fax, Scan, Stored Documents** menu directly.
- **Machine Status**: Shows machine's current status.
- **Admin Setting**: Allows an administrator to set up the machine.
- **Usage Page Report**: You can print the report on the given amount of printouts depending on the paper size and type.

Job Status button

When you press **Job Status** button, the screen lists the currently running, queued and completed jobs.

No.	Job Name	Status	User	Job Type
000	Copy JobJobName_0	Scanning	JobOwner_0	Copy
001	Copy JobJobName_1	Scanning	JobOwner_1	Copy
002	Copy JobJobName_2	Scanning	JobOwner_2	Copy
003	Copy JobJobName_3	Scanning	JobOwner_3	Copy
004	Copy JobJobName_4	Scanning	JobOwner_4	Copy
005	Copy JobJobName_5	Scanning	JobOwner_5	Copy

- **Current Job tab**: Shows the list of jobs in progress and pending.
- **Completed Job tab**: Provides the list of completed jobs.
- **Active Notice tab**: Displays any error codes that have occurred.
- **No.:** Gives the order of jobs.
- **Job Name**: Shows job information, such as name and type.
- **Status**: Gives the current status of each job.
- **User**: Provides user name-mainly computer name.
- **Job Type**: Displays details of the active job, such as job type, recipient phone number and other information.
- **Detail**: Shows detailed information of selected option on the **Current Job, Completed Job** and **Active Notice** list.
- **Delete**: Removes selected job from the list.
- **Delete All**: Removes all jobs from the list.
- **Close**: Closes the job status window and switches to previous view.

XOA button

When you press this button, you can use the XOA applications from the display screen. Before using the XOA applications, they should be installed. If the **XOA** button is not displayed, make sure that the machine gets XOA license. For more information, contact your local Samsung dealer or the retailer where you purchased your machine.



- If the message asking **Auth.ID, Password, and Realm Name**, it means the network administrator has set the authentication in SyncThru™ Web Service. (See "Using SyncThru™ Web Service" on page 93.)

Power Saver button

When the machine is not in use, save electricity by pressing the power save mode button. Pressing this button for one second puts the machine into power save mode. (See "Using power saving feature" on page 34.)

If you press this button for more than three seconds, a window appears, requesting that you turn the power off. If you choose **Yes**, the power is turned off. This button can also be used to turn the button on.

STATUS		DESCRIPTION
Off		The machine is not in the power save mode.
Blue	On	The machine is in the power save mode.

Interrupt button

When you press **Interrupt** button, the machine goes into interrupt mode, which means it stops a printing job for urgent copy job. When the urgent copy job completes, the previous printing job continues.

STATUS		DESCRIPTION
Off		The machine is not in interrupt printing mode.
Blue	On	The machine is in interrupt printing mode.

- Interrupt mode is resumed at default value (Off) after the machine is shut down or reset.

getting started

This chapter gives you step-by-step instructions for setting up the USB connected machine and software.

This chapter includes:

- Setting up the hardware
- Supplied software
- System requirements
- Installing USB connected machine's driver
- Sharing your machine locally

SETTING UP THE HARDWARE

This section shows the steps to set up the hardware, as is explained in the Quick Install Guide. Make sure you read the Quick Install Guide first and follow the steps below:

1. Select a stable location.

Select a level, stable place with adequate space for air circulation. Allow extra space to open covers and trays.

The area should be well ventilated and away from direct sunlight or sources of heat, cold, and humidity. Do not set the machine close to the edge of your desk or table.

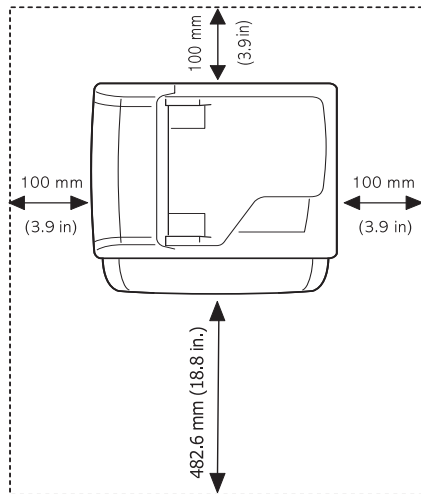

Printing is suitable for altitudes under 1,500 m (4,921 ft). Refer to the altitude setting to optimize your printing. (See "Altitude adjustment" on page 33.)

Place the machine on a flat, stable surface so that there is no incline greater than 2 mm (0.08 inch). Otherwise, printing quality may be affected.

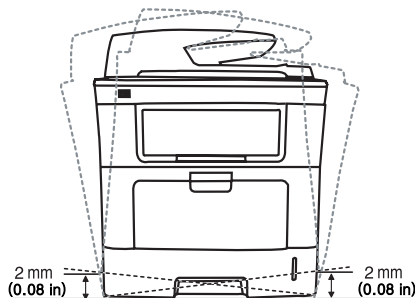

2. Unpack the machine and check all the enclosed items.
3. Remove tape holding the machine securely.
4. Install the toner cartridge.
5. Load paper. (See "Loading paper in the tray" on page 38.)
6. Make sure that all cables are connected to the machine.
7. Turn the machine on.

SUPPLIED SOFTWARE

After you have set up your machine and connected it to your computer, you must install the printer software. If you are a Windows or Macintosh OS, install the software from the supplied CD and if you are a Linux OS user, download the software from the Samsung website (www.samsung.com/printer) and install.

- Machine software are occasionally updated due to release of new operating system and etc. If needed, download the latest version from the Samsung website. (www.samsung.com/printer)

OS	CONTENTS
Windows	<ul style="list-style-type: none"> • Printer driver: Use this driver to take full advantage of your machine's features. • PostScript printer driver: Use the PostScript driver to print documents with complex fonts and graphics in the PS language. • Scanner driver: TWAIN and Windows Image Acquisition (WIA) drivers are available for scanning documents on your machine. • Smart Panel: This program allows you to monitor the machine's status and alerts you when an error occurs during printing. • SmarThru Office^a: This program is the accompanying Windows-based software for your multifunctional machine. • Direct Printing Utility: This program allows you to print PDF files directly. • Scan and Fax Manager 2: You can find out about Scan and Fax Manager 2 program information and installed scan driver's condition. • SetIP: Use this program to set your machine's TCP/IP addresses.
Macintosh	<ul style="list-style-type: none"> • PostScript Printer Description (PPD) file: Use this file to run your machine from a Macintosh computer and print documents. • Scanner driver: TWAIN driver is available for scanning documents on your machine. • Smart Panel: This program allows you to monitor the machine's status and alerts you when an error occurs during printing. • Scan and Fax Manager: You can find out about Scan and Fax Manager program information and installed scan driver's condition.
Linux	<ul style="list-style-type: none"> • Unified Linux Driver: Use this driver to take full advantage of your machine's features. • Printer Description (PPD) file: Use this file to run your machine from a Linux computer and print documents. • SANE: Use this driver to scan documents. • Smart Panel: This program allows you to monitor the machine's status and alerts you when an error occurs during printing.

a. Allows you to edit a scanned image in various ways using a powerful image editor and to send the image by email. You can also open another image editor program, such as Adobe Photoshop, from SmarThru Office . For details, refer to the on screen help supplied on the SmarThru Office program. (See "Smarthru Office" on page 94.)

SYSTEM REQUIREMENTS

Before you begin, ensure that your system meets the following requirements:

Windows

Your machine supports the following Windows operating systems.

OPERATING SYSTEM	REQUIREMENT (RECOMMENDED)		
	CPU	RAM	FREE HDD SPACE
Windows 2000	Pentium II 400 MHz (Pentium III 933 MHz)	64 MB (128 MB)	600 MB
Windows XP	Pentium III 933 MHz (Pentium IV 1 GHz)	128 MB (256 MB)	1.5 GB
Windows Server 2003	Pentium III 933 MHz (Pentium IV 1 GHz)	128 MB (512 MB)	1.25 GB to 2 GB
Windows Vista	Pentium IV 3 GHz	512 MB (1024 MB)	15 GB
Windows Server 2008	Pentium IV 1 GHz (Pentium IV 2 GHz)	512 MB (2048 MB)	10 GB
Windows 7	Pentium IV 1 GHz 32-bit or 64-bit processor or higher	1 GB (2 GB)	16 GB
Windows Server 2008 R2	Pentium IV 1 GHz (x86) or 1.4 GHz (x64) processors (2 GHz or faster)	512 MB (2048 MB)	10 GB

-  Internet Explorer 5.0 or higher is the minimum requirement for all Windows operating systems.
- Users who have an administrator right can install the software.
- **Windows Terminal Service** is compatible with this machine.

Macintosh

OPERATING SYSTEM	REQUIREMENTS (RECOMMENDED)		
	CPU	RAM	FREE HDD SPACE
Mac OS X 10.4 or lower	<ul style="list-style-type: none"> • Intel Processors • PowerPC G4/ G5 	<ul style="list-style-type: none"> • 128 MB for a PowerPC based Mac (512 MB) • 512 MB for a Intel-based Mac (1 GB) 	1 GB
Mac OS X 10.5	<ul style="list-style-type: none"> • Intel Processors • 867 MHz or faster Power PC G4/ G5 	512 MB (1 GB)	1 GB
Mac OS X 10.6	<ul style="list-style-type: none"> • Intel Processors 	1 GB (2 GB)	1 GB

Linux

ITEM	REQUIREMENTS
Operating system	RedHat 8.0, 9.0 (32bit) RedHat Enterprise Linux WS 4, 5 (32/64bit) Fedora Core 1~7 (32/64bit) Mandrake 9.2 (32bit), 10.0, 10.1 (32/64bit) Mandriva 2005, 2006, 2007 (32/64bit) SuSE Linux 8.2, 9.0, 9.1 (32bit) SuSE Linux 9.2, 9.3, 10.0, 10.1, 10.2 (32/64bit) SuSE Linux Enterprise Desktop 9, 10 (32/64bit) Ubuntu 6.06, 6.10, 7.04 (32/64bit) Debian 3.1, 4.0 (32/64bit)
CPU	Pentium IV 2.4GHz (IntelCore2)
RAM	512 MB (1024 MB)
Free HDD space	1 GB (2GB)

- It is necessary to claim swap partition of 300 MB or larger for working with large scanned images.
- The Linux scanner driver supports the optical resolution at maximum.

INSTALLING USB CONNECTED MACHINE'S DRIVER

A locally connected machine is a machine directly attached to your computer using the USB cable. If your machine is attached to a network, skip the following steps below and go on to installing network connected machine's driver. (See "Installing network connected machine's driver" on page 31.)

- Selecting **Custom installation** allows you to choose programs to install.
Only use an USB cable no longer then 3m (118 inch.). Data might not be transferred to your machine.

Windows

You can install the machine software using the typical or custom method. The following steps below are recommended for most users who use a machine directly connected to your computer. All components necessary for machine operations will be installed.

- Make sure that the machine is connected to your computer and powered on.
 - If the "**New Hardware Wizard**" window appears during the installation procedure, click  in the upper right corner of the box to close the window, or click **Cancel**.
- Insert the supplied software CD into your CD-ROM drive.
 - The software CD should automatically run and an installation window appear.
 - If the installation window does not appear, click **Start** and then **Run**. Type X:\Setup.exe, replacing "X" with the letter which represents your drive. Click **OK**.
 - If you use Windows Vista, Windows 7 and Windows 2008 Server R2 click **Start > All programs > Accessories > Run**. Type X:\Setup.exe replacing "X" with the letter which represents your drive and click **OK**.
 - If the **AutoPlay** window appears in Windows Vista, Windows 7 and

Windows 2008 Server R2, click **Run Setup.exe** in **Install or run program** field, and click **Continue** or **Yes** in the **User Account Control** windows.

- Click **Next**.

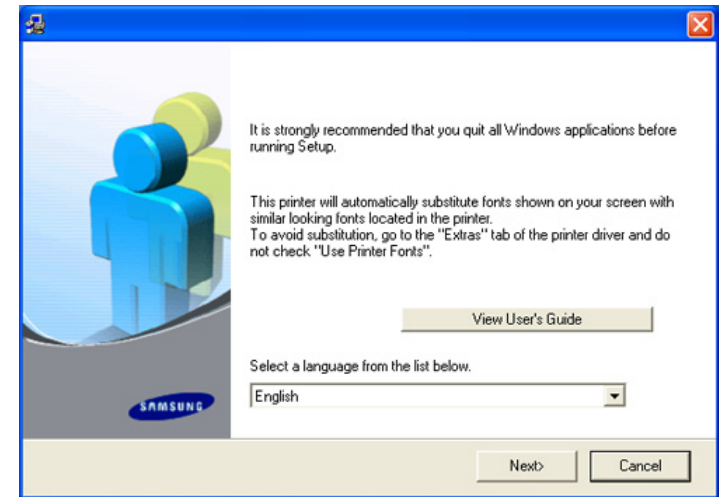

If necessary, select a language from the drop-down list.

- Select **Typical installation for a local printer**. and then click **Next**.

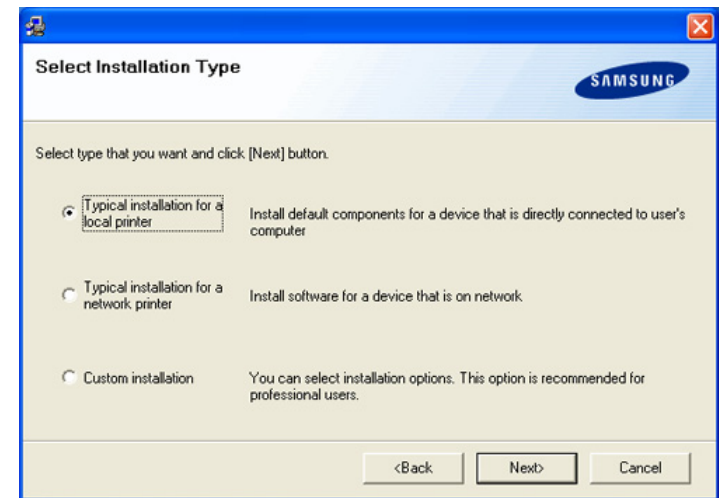

- If your machine is not already connected to the computer, the following window will appear.

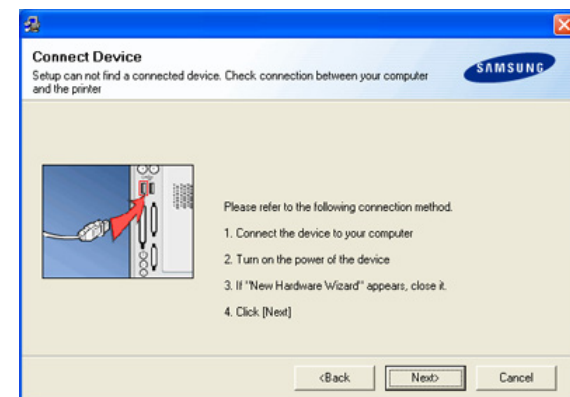

- After connecting the machine, click **Next**.

- If you don't want to connect the machine at this time, click **Next**, and **No** on the following screen. The installation will then start and a test page will not be printed at the end of the installation.
 - The installation window that appears in this User's Guide may differ depending on the machine and interface in use.
5. After the installation is finished, a window asking you to print a test page appears. If you choose to print a test page, select the checkbox and click **Next**. Otherwise, just click **Next** and skip.
 6. If the test page prints out correctly, click **Yes**.
If not, click **No** to reprint it.
 7. To register as a user of the machine in order to receive information from Samsung, select the checkbox and click **Finish**. You are now registered to the Samsung web site.
Otherwise, just click **Finish**.

 If the printer driver does not work properly, uninstall the driver and reinstall it.

For windows follow the steps below to uninstall the driver.

- a) Make sure that the machine is connected to your computer and powered on.
- b) From the **Start** menu, select **Programs** or **All Programs** > your printer driver name > **Maintenance**.
- c) Select **Remove** and click **Next**.
You will see a component list so that you can remove any item individually.
- d) Select the components you want to remove and then click **Next**.
- e) When your computer asks you to confirm your selection, click **Yes**.
The selected driver and all of its components are removed from your computer.
- f) After the software is removed, click **Finish**.

Macintosh

The software CD that came with your machine provides you with the PPD file that allows you to use the CUPS driver or PostScript driver (only available when you use a machine which supports the PostScript driver) for printing on a Macintosh computer.

Also, it provides you with the TWAIN driver for scanning on a Macintosh computer.

1. Make sure that the machine is connected to your computer and powered on.
2. Insert the supplied software CD into your CD-ROM drive.
3. Double-click the CD-ROM icon that appears on your Macintosh desktop.
4. Double-click the **MAC_Installer** folder.
5. Double-click the **Installer** icon.
6. Enter the password and click **OK**.
7. The Samsung Installer window opens. Click **Continue**.
8. Select **Easy Install** and click **Install**. **Easy Install** is recommended for most users. All components necessary for machine operations will be installed.
If you select **Custom Install**, you can choose individual components to install.
9. When the message which warns that all applications will close on your computer appears, click **Continue**.
10. After the installation is finished, click **Quit**.

 If you have installed scan driver, click **Restart**.

11. Open the **Applications** folder > **Utilities** > **Print Setup Utility**.

- For Mac OS X 10.5~10.6, open the **Applications** folder > **System Preferences** and click **Print & Fax**.

12. Click **Add** on the **Printer List**.

- For Mac OS X 10.5~10.6, click the "+" icon; a display window will pop up.

13. For Mac OS X 10.3, select the **USB** tab.

- For Mac OS X 10.4, click **Default Browser** and find the USB connection.
- For Mac OS X 10.5~10.6, click **Default** and find the USB connection.

14. For Mac OS X 10.3, if Auto Select does not work properly, select **Samsung** in **Printer Model** and your machine name in **Model Name**.

- For Mac OS X 10.4, if Auto Select does not work properly, select **Samsung** in **Print Using** and your machine name in **Model**.
- For Mac OS X 10.5~10.6, if Auto Select does not work properly, select **Select a driver to use...** and your machine name in **Print Using**.

Your machine appears on the **Printer List**, and is set as the default machine.

15. Click **Add**.

 If the printer driver does not work properly, uninstall the driver and reinstall it.

Follow steps below to uninstall the driver for Macintosh.

- a) Make sure that the machine is connected to your computer and powered on.
- b) Insert the supplied software CD into your CD-ROM drive.
- c) Double-click CD-ROM icon that appears on your Macintosh desktop.
- d) Double-click the **MAC_Installer** folder.
- e) Double-click the **Installer** icon.
- f) Enter the password and click **OK**.
- g) The Samsung Installer window opens. Click **Continue**.
- h) Select **Uninstall** and click **Uninstall**.
- i) When the message which warns that all applications will close on your computer appears, click **Continue**.
- j) When the uninstall is done, click **Quit**.

Linux

You need to download Linux software package from the Samsung website to install the printer softwares.

Follow the steps below to install the softwares.

Installing the Linux Unified Driver

1. Make sure that the machine is connected to your computer and powered on.
2. When the **Administrator Login** window appears, type in root in the **Login** field and enter the system password.

 You must log in as a super user (root) to install the machine software. If you are not a super user, ask your system administrator.

3. From the Samsung website, download the Unified Linux Driver package to your computer.
4. Right click the **Unified Linux Driver** package and extract the package.
5. Double click **cdroot** > **autorun**.

6. When the welcome screen appears, click **Next**.

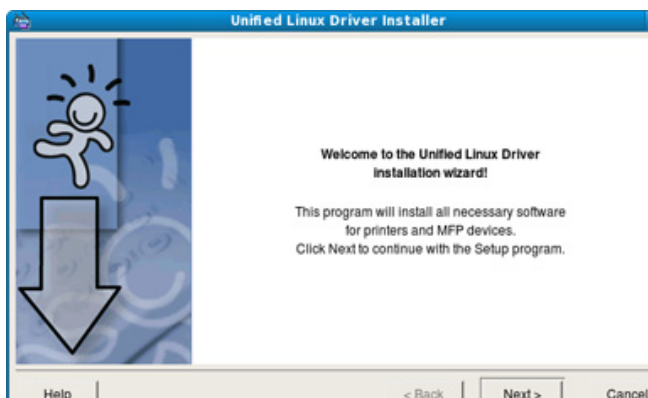

7. When the installation is complete, click **Finish**.

The installation program has added the Unified Driver Configurator desktop icon and the Unified Driver group to the system menu for your convenience. If you have any difficulties, consult the on screen help that is available through your system menu or can otherwise be called from the driver package Windows applications, such as **Unified Driver Configurator** or **Image Manager**.

Installing the SmartPanel

1. Make sure that the machine is connected to your computer and powered on.
2. When the **Administrator Login** window appears, type in root in the **Login** field and enter the system password.

 You must log in as a super user (root) to install the machine software. If you are not a super user, ask your system administrator.

3. From the Samsung website, download the **Smart Panel** package to your computer.
4. Right click the Smart Panel package and extract the package.
5. Double click **cdroot > Linux > smartpanel > install.sh**.

Installing the Printer Setting Utility

1. Make sure that the machine is connected to your computer and powered on.
2. When the **Administrator Login** window appears, type in root in the **Login** field and enter the system password.

 You must log in as a super user (root) to install the machine software. If you are not a super user, ask your system administrator.

3. From the Samsung website, download the Printer Setting Utility package to your computer.
4. Right click the **Printer Setting Utility** package and extract the package.
5. Double click **cdroot > Linux > psu > install.sh**.

 If the printer driver does not work properly, uninstall the driver and reinstall it.

Follow the steps below steps to uninstall the driver for Linux.

- a) Make sure that the machine is connected to your computer and powered on.
- b) When the **Administrator Login** window appears, type in "root" in the **Login** field and enter the system password.
You must log in as a super user (root) to uninstall the printer

driver. If you are not a super user, ask your system administrator.

- c) Click the icon at the bottom of the desktop. When the Terminal screen appears, type in:
[root@localhost root]#cd /opt/Samsung/mfp/uninstall/
[root@localhost uninstall]#./uninstall.sh
- d) Click **Uninstall**.
- e) Click **Next**.
- f) Click **Finish**.

SHARING YOUR MACHINE LOCALLY

Follow the steps below to set up the computers to share your machine locally.

If the Host computer is directly connected to the machine with USB cable and is also connected to the local network environment, the client computer connected to the local network can use the shared machine through the host computer to print.

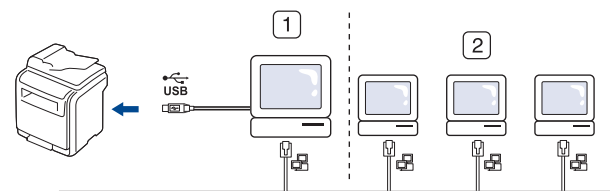

1	Host computer	A computer which is directly connected to the machine by USB cable.
2	Client computers	Computers which use the machine shared through the host computer.

Windows

Setting up a host computer

1. Install your printer driver. (See "Installing USB connected machine's driver" on page 26 , "Installing network connected machine's driver" on page 31.)
2. Click the Windows **Start** menu.
3. For Windows 2000, select **Settings > Printers**.
 - For Windows XP/2003, select **Printers and Faxes**.
 - For Windows 2008/Vista, select **Control Panel > Hardware and Sound > Printers**.
 - For Windows 7, select **Control Panel > Hardware and Sound > Devices and Printers**.
 - For Windows Server 2008 R2, select **Control Panel > Hardware > Devices and Printers**.
4. Right click your printer icon.
5. For Windows XP/2003/2008/Vista, press **Properties**.
For Windows 7 and Windows Server 2008 R2, from context menus, select the **Printer properties**.
 If **Printer properties** item has ► mark, you can select other printer drivers connected with selected printer.
6. Select the **Sharing** tab.
7. Check the **Change Sharing Options**.
8. Check the **Share this printer**.
9. Fill in the **Share Name** field. Click **OK**.

Setting up a client computer

1. Install your printer driver. (See "Installing USB connected machine's driver" on page 26 , "Installing network connected machine's driver" on page 31.)
2. Click the Windows **Start** menu.
3. Select **All programs > Accessories > Window Explorer**.
4. Enter in IP address of the host computer and press Enter in your keyboard.



 In case host computer requires **User name** and **Password**, fill in User ID and password of the host computer account.

5. Right click the printer icon you want to share and select **Connect**.
6. If a set up complete message appears, click **OK**.
7. Open the file you want to print and start printing.

Macintosh

 The following steps are for Mac OS X 10.5~10.6. Refer to Mac Help for other OS versions.

Setting up a host computer

1. Install your printer driver. (See "Installing USB connected machine's driver" on page 26 , "Installing network connected machine's driver" on page 31.)
2. Open the **Applications** folder > **System Preferences** and click **Print & Fax**.
3. Select the printer to share in the **Printers list**.
4. Select **"Share this printer"**.

Setting up a client computer

1. Install your printer driver. (See "Installing USB connected machine's driver" on page 26 , "Installing network connected machine's driver" on page 31.)
2. Open the **Applications** folder > **System Preferences** and click **Print & Fax**.
3. Press the **+** icon.
A display window showing the name of your shared printer appears.
4. Select your machine and click **Add**.

network setup

This chapter gives you step-by-step instructions for setting up the network connected machine and software.

This chapter includes:

- Network environment
- Introducing useful network programs

NETWORK ENVIRONMENT

You can use network after connecting network cable to a corresponding port on your machine.

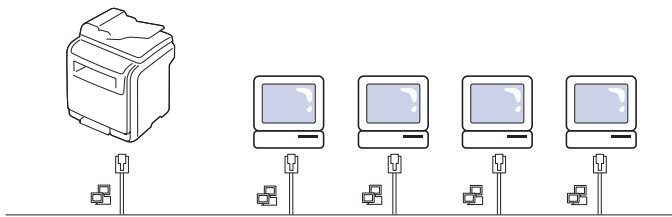

You need to set up the network protocols on the machine to use it as your network machine. You can set up the basic network settings through the machine's control panel.

The following table shows the network environments supported by the machine:

ITEM	REQUIREMENTS
Network interface	Ethernet 10/100 Base-TX
Network operating system	<ul style="list-style-type: none">• Novell NetWare 5.x, 6.x (TCP/IP Only)• Windows 2000/XP/2003/2008/Vista/7/2008 Server R2• Various Linux OS• Mac OS X 10.3 ~ 10.6
Network protocols	<ul style="list-style-type: none">• TCP/IP on Windows• IPP• DHCP• SNMP• BOOTP

 If you want to setup DHCP network protocol, go to the <http://developer.apple.com/networking/bonjour/download/>, select the program Bonjour for Windows due to your computer operating system, and install the program. This program will allow you to fix the network parameter automatically. Follow the instruction in the installation window. This program does not support Linux.

INTRODUCING USEFUL NETWORK PROGRAMS

There are several programs available to setup the network settings easily in network environment. For the network administrator especially, managing several machines on the network is possible.

- Configuring TCP/IP
- Installing network connected machine's driver

SyncThru™ Web Service

Web server embedded on your network machine server. If you login with administrator's ID and password on the web server, it allows you to:

- Configure the network parameters necessary for the machine to connect to various network environments.
- Customize machine settings.
(See "Using SyncThru™ Web Service" on page 93.)

SyncThru™ Web Admin Service

Web-based machine management solution for network administrators. SyncThru™ Web Admin Service provides you with an efficient way of managing network devices and lets you remotely monitor and troubleshoot network machines from any site with corporate internet access. Download this program from <http://solution.samsungprinter.com>.

SetIP

This utility program allows you to select a network interface and manually configure the IP addresses for use with the TCP/IP protocol. (See "Using SetIP Program" on page 95.)

CONFIGURING TCP/IP

When you connect your machine to a network, you must first configure the TCP/IP settings for the machine. After you have assigned and verified the TCP/IP settings, you are ready to install the software on each computer on the network.

Setting the network address

 Contact the network administrator if you are not sure how to configure. You can set up TCP/IP network parameters, follow the steps below:

1. Connect your machine to the network with an RJ-45 Ethernet cable.
2. Turned on the machine.
3. Press **Machine Setup** on the control panel.
4. Press **Admin Setting**.
5. When the login message appears, enter password.
Touch the password input area, then the question marks appears. Use the number keypad on the control panel to enter the password. Once the password is entered, press **OK**. (Factory setting:1111)
6. Press the **Setup** tab > **Network Setup**.
7. Select **TCP/IP Protocol**.
8. Press **IP Setting**.
9. Select **Static** and then enter **IP Address**, **Subnet Mask** and **Gateway** address fields. Touch the input area, then enter addresses by number keypad on the control panel.
10. Press **OK**.

INSTALLING NETWORK CONNECTED MACHINE'S DRIVER

Selecting **Custom installation** allows you to choose programs to install.

Windows

You can set up the machine driver, follow the steps below.

This is recommended for most users. All components necessary for machine operations will be installed.

1. Make sure that the machine is connected to your network and powered on. Also, your machine's IP address should have been set. For details about connecting to the network, see the supplied machine's Quick Install Guide.
2. Insert the supplied software CD into your CD-ROM drive.
 - The software CD should automatically run and an installation window appear.
 - If the installation window does not appear, click **Start** and then **Run**. Type **X:\Setup.exe**, replacing "X" with the letter which represents your drive. Click **OK**.
 - If you use Windows Vista, Windows 7 and Windows 2008 Server R2, click **Start > All programs > Accessories > Run**. Type **X:\Setup.exe** replacing "X" with the letter which represents your drive and click **OK**.
 - If the **AutoPlay** window appears in Windows Vista, Windows 7 and Windows 2008 Server R2, click **Run Setup.exe** in **Install or run program** field, and click **Continue** or **Yes** in the **User Account Control** windows.
3. Click **Next**.

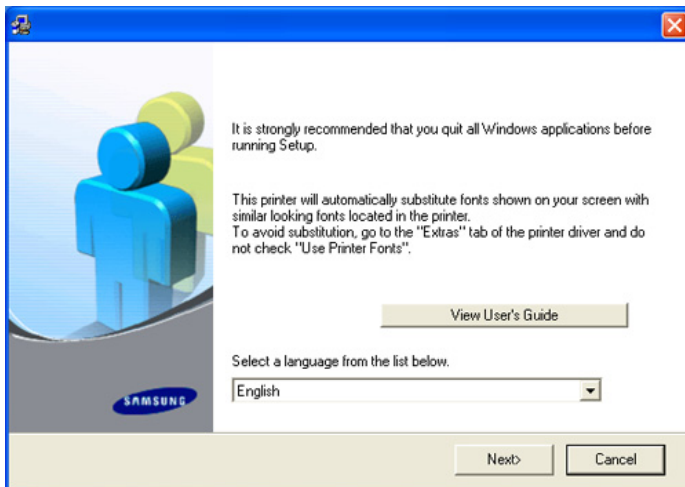

If necessary, select a language from the drop-down list.

4. Select **Typical installation for a network printer** and then click **Next**.

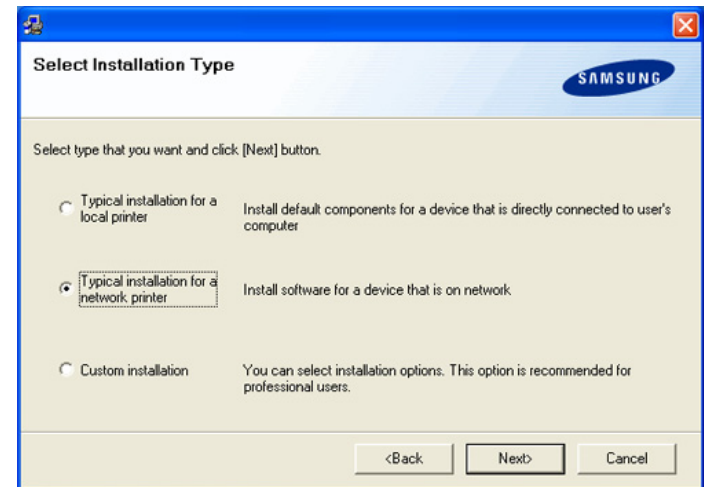

5. The list of machines available on the network appears. Select the machine you want to install from the list and then click **Next**.



- If you click the **Advanced** button, you can search a printer with the **SNMP Community Name**. Default name is 'public'.
- If you do not see your machine on the list, click **Update** to refresh the list, or select **Add TCP/IP Port** to add your machine to the network. To add the machine to the network, enter the port name and the IP address for the machine. To verify your machine's IP address or the MAC address, print a Network Configuration page.
- To find a shared machine (UNC Path), select **Shared Printer [UNC]** and enter the shared name manually or find a shared printer by clicking the **Browse** button.
- If you cannot find your machine in network, turn off the firewall and click **Update**. For Windows operating system, click **Start > Control Panel > Windows Firewall**, and inactivate this option. For other operating system, refer to its on-line guide.

6. After the installation is finished, a window asking you to print a test page appears. If you choose to print a test page, select the checkbox and click **Next**. Otherwise, just click **Next** and skip.
7. If the test page prints out correctly, click **Yes**. If not, click **No** to reprint it.

- To register as a user of the machine in order to receive information from Samsung, select the checkbox and click **Finish**. You are now registered to the Samsung web site.

Otherwise, just click **Finish**.

-  If the printer driver does not work properly, uninstall the driver and reinstall it.

For windows follow the steps below to uninstall the driver.

- Make sure that the machine is connected to your computer and powered on.
- From the **Start** menu, select **Programs** or **All Programs** > your printer driver name > **Maintenance**.
- Select **Remove** and click **Next**.
You will see a component list so that you can remove any item individually.
- Select the components you want to remove and then click **Next**.
- When your computer asks you to confirm your selection, click **Yes**.
The selected driver and all of its components are removed from your computer.
- After the software is removed, click **Finish**.

Macintosh

- Make sure that the machine is connected to your network and powered on. Also, your machine's IP address should have been set.
- Insert the supplied software CD into your CD-ROM drive.
- Double-click the CD-ROM icon that appears on your Macintosh desktop.
- Double-click the **MAC_Installer** folder.
- Double-click the **Installer** icon.
- Enter the password and click **OK**.
- The Samsung Installer window opens. Click **Continue**.
- Select **Easy Install** and click **Install**. **Easy Install** is recommended for most users. All components necessary for machine operations will be installed.
If you select **Custom Install**, you can choose individual components to install.
- When the message which warns that all applications will close on your computer appears, click **Continue**.
- After the installation is finished, click **Quit**.

-  If you have installed scan driver, click **Restart**.

- Open the **Applications** folder > **Utilities** > **Print Setup Utility**.
 - For Mac OS X 10.5~10.6, open the **Applications** folder > **System Preferences** and click **Print & Fax**.
- Click **Add** on the **Printer List**.
 - For Mac OS X 10.5~10.6, click the "+" icon; a display window will pop up.
- For Mac OS X 10.3, select the **IP Printing** tab.
 - For Mac OS X 10.4, click **IP Printer**.
 - For Mac OS X 10.5~10.6, click **IP**.
- Select **Socket/HP Jet Direct** in **Printer Type**.
When printing a document containing many pages, printing performance may be enhanced by choosing Socket for **Printer Type** option.
- Enter the machine's IP address in the **Printer Address** field.
- Enter the queue name in the **Queue Name** field. If you cannot determine the queue name for your machine server, try using the default queue first.
- For Mac OS X 10.3, if Auto Select does not work properly, select **Samsung** in **Printer Model** and your machine name in **Model Name**.

- For Mac OS X 10.4, if Auto Select does not work properly, select **Samsung** in **Print Using** and your machine name in **Model**.
- For Mac OS X 10.5~10.6, if Auto Select does not work properly, choose **Select a driver to use...** and your machine name in **Print Using**.

Your machine's IP address appears on the **Printer List**, and is set as the default machine.

18. Click **Add**.

-  If the printer driver does not work properly, uninstall the driver and reinstall it.
- Follow steps below to uninstall the driver for Macintosh.
- Make sure that the machine is connected to your computer and powered on.
 - Insert the supplied software CD into your CD-ROM drive.
 - Double-click CD-ROM icon that appears on your Macintosh desktop.
 - Double-click the **MAC_Installer** folder.
 - Double-click the **Installer** icon.
 - Enter the password and click **OK**.
 - The Samsung Installer window opens. Click **Continue**.
 - Select **Uninstall** and click **Uninstall**.
 - When the message which warns that all applications will close on your computer appears, click **Continue**.
 - When the uninstall is done, click **Quit**.

Linux

Install Linux Driver

- Make sure that the machine is connected to your network and powered on. Also, your machine's IP address should have been set.
- From the Samsung website, download the Unified Linux Driver package to your computer.
- Right click the **Unified Linux Driver** package and extract the package.
- Double click **cdroot > autorun**.
- The Samsung Installer window opens. Click **Continue**.
- The Add printer wizard window opens. Click **Next**.
- Select Network printer and click **Search** button.
- The Printer's IP address and model name appears on list field.
- Select your machine and click **Next**.
- Input the printer description and Next
- When the add printer is done, click Finish
- When the install is done, click Finish

Add network Printer

- Double-click the **Unified Driver Configurator**.
- Click **Add Printer...**
- The **Add printer wizard** window opens. Click **Next**.
- Select **Network printer** and click the **Search** button.
- The printer's IP address and model name appears on list field.
- Select your machine and click **Next**.
- Input the printer description and **Next**
- When the add printer is done, click **Finish**.

basic setup

After installation is complete, you may want to set the machine's default settings. Refer to the next section if you would like to set or change values. This chapter gives you step-by-step instructions for setting up the machine.

This chapter includes:

- Altitude adjustment
- Setting the authentication password
- Setting the date and time
- Changing the display language
- Changing the country
- Setting job timeout

ALTITUDE ADJUSTMENT

The print quality is affected by atmospheric pressure, which is determined by the height of the machine above sea level. The following information will guide you on how to set your machine to the best print quality or best quality of print.

Before you set the altitude value, find the altitude where you are using the machine.

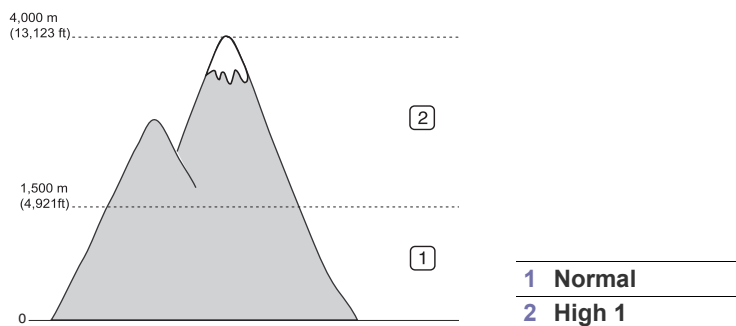

1. Turn your networked computer on and open the web browser.
2. Enter your machine's IP address as the URL in a browser.
3. Click **Go** to access the SyncThru™ Web Service.
4. Click **Machine Settings**.
5. Click **Altitude Adj.**
6. Select the appropriate altitude value.
7. Click **Apply**.

 If your machine is connected via a USB cable, set the altitude in **Altitude Adjustment** option on the machine's display screen. (See "General settings" on page 85.)

SETTING THE AUTHENTICATION PASSWORD

To set up your machine or change the settings, you must first login. To change password, follow the steps below:

1. Press **Machine Setup** on the control panel.
2. Press **Admin Setting**.

- Using power saving feature
- Setting the default tray and paper
- Changing the default settings
- Changing the font setting
- Understanding the keyboard

3. When the login message appears, enter password with the number keypad on the control panel to enter the password. Then, press **OK**. (Factory setting:1111)
4. Press the **Setup** tab > **Authentication**.
5. Press **Change Admin. Password**.
6. Enter old and new password, and then confirm the new password.
7. Press **OK**.

SETTING THE DATE AND TIME

When you set the time and date, they are used in delay fax and delay print. They are printed on reports. If, however, they are not correct, you need to change it for the correct time being.

 If the machine's power is cut off, you need to reset the correct time and date once the power has been restored.

1. Press **Machine Setup** on the control panel.
 2. Press **Admin Setting**.
 3. When the login message appears, enter password with number keypad and press **OK**. (See "Setting the authentication password" on page 33.)
 4. Press the **General** tab > **Date & Time** > **Date & Time**.
 5. Select date and time using left/right arrows. Or touch the insert area and use the numeric keypad on the control panel.
 6. Press **OK**.
-  To change the format of date and time, press **Date Format** and **Time Format**.

CHANGING THE DISPLAY LANGUAGE

To change the language that appears on the display, follow the steps below:

1. Press **Machine Setup** on the control panel.
2. Press **Admin Setting**.
3. When the login message appears, enter password with number keypad and press **OK**. (See "Setting the authentication password" on page 33.)
4. Press the **General** tab.
5. Press the down arrow to switch the screen and press **Language**.
6. Select the appropriate language.
7. Press **OK**.

CHANGING THE COUNTRY

You can change the country, then some the values for fax and paper size will be changed automatically for your country.

1. Press **Machine Setup** on the control panel.
2. Press **Admin Setting**.
3. When the login message appears, enter password with number keypad and press **OK**. (See "Setting the authentication password" on page 33.)
4. Press the **General** tab.
5. Press the down arrow to switch the screen and press **Country**.
6. Select the desired country.
7. Press **OK**.

SETTING JOB TIMEOUT

When there is no input for a certain period of time, the machine exits the current menu and goes in to the default settings. You can set the amount of time the machine will wait.

1. Press **Machine Setup** on the control panel.
2. Press **Admin Setting**.
3. When the login message appears, enter password with number keypad and press **OK**. (See "Setting the authentication password" on page 33)
4. Press the **General** tab.
5. Press **Timers**.
6. Select appropriate option.
 - **System Timeout:** The machine returns to the default value after certain time the machine waits. The maximum time you can set is 10 minutes.
 - **Held Job Timeout:** When error occurs while printing and there is no signal from the computer, the machine holds a job for a specific time period. You can set a time period for at least an hour.
7. Select **On**.
8. Select a duration using left/right arrows.
9. Press **OK**.

USING POWER SAVING FEATURE

When you are not using the machine for a while, use this feature to save power.

1. Press **Machine Setup** on the control panel.
2. Press **Admin Setting**.
3. When the login message appears, enter password with number keypad and press **OK**. (See "Setting the authentication password" on page 33.)
4. Press the **General** tab.
5. Press down arrow to switch the screen. Press **Power Saver**.
6. Press **Power Save**.
7. Select appropriate time.
8. Press **OK**.

SETTING THE DEFAULT TRAY AND PAPER

You can select the tray and paper you would like to keep using for printing job. (See "General settings" on page 85.)

In the control panel

1. Press **Machine Setup** on the control panel.
2. Press **Admin Setting**.
3. When the login message appears, enter password with number keypad and press **OK**. (See "Setting the authentication password" on page 33.)
4. Press the **General** tab.
5. Press the down arrow to switch the screen and press **Tray Management**.
6. Select tray and its options, such as paper size and type.
7. Press **OK**.

 If the optional tray is not installed, the tray options on the screen are grayed out.

In the computer

Windows

1. Click the Windows **Start** menu.
2. For Windows 2000, select **Settings > Printers**.
 - For Windows XP/2003, select **Printers and Faxes**.
 - For Windows 2008/Vista, select **Control Panel > Hardware and Sound > Printers**.
 - For Windows 7, select **Control Panel > Hardware and Sound > Devices and Printers**.
 - For Windows Server 2008 R2, select **Control Panel > Hardware > Devices and Printers**.
3. Right-click your machine.
4. For Windows XP/2003/2008/Vista, press **Printing Preferences**. For Windows 7 and Windows Server 2008 R2, from context menus, select the **Printing Preferences**.

 If **Printing Preferences** item has ► mark, you can select other printer drivers connected with selected printer.

5. Click **Paper** tab.
6. Select tray and its options, such as paper size and type.
7. Press **OK**.

Macintosh

Macintosh does not support this function. Macintosh users need to change the default setting manually each time they want to print using other settings.

1. Open a Macintosh application and select the file you want to print.
2. Open the **File** menu and click **Print**.
3. Go to **Paper Feed** pane.
4. Set appropriate tray from which you want to print.
5. Go to **Paper** pane.
6. Set paper type to correspond to the paper loaded in the tray from which you want to print.
7. Click **Print** to print.

CHANGING THE DEFAULT SETTINGS

You can set the default values for copy, fax, email, scan and paper all at once.

1. Press **Machine Setup** on the control panel.
2. Press **Admin Setting**.

- When the login message appears, enter password with number keypad and press OK. (See "Setting the authentication password" on page 33)
- Press the **General** tab > **Default Settings** > **Default Option**.
- Press the function you want to change, and change its settings.
For example, if you want to change the default brightness & darkness setting for a copy job, press **Copy** > **Darkness** and adjust the brightness & darkness.
- Press **OK**.

CHANGING THE FONT SETTING

Your machine has preset the font for your region or country.

If you want to change the font or set the font for special condition, such as the DOS environment, you can change the font setting as follows:

- Turn your networked computer on and open the web browser.
- Enter your machine's IP address as the URL in a browser.
- Click **Go** to access the SyncThru™ Web Service.
- Click **Machine Settings**.
- Click **PCL**.
- Select your preferred font in the **Symbol Set** list.
- Click **Apply**.

 Following information shows the proper font list for corresponding languages.

- Russian:** CP866, ISO 8859/5 Latin Cyrillic
- Hebrew:** Hebrew 15Q, Hebrew-8, Hebrew-7 (Israel only)
- Greek:** ISO 8859/7 Latin Greek, PC-8 Latin/Greek
- Arabic & Farsi:** HP Arabic-8, Windows Arabic, Code Page 864, Farsi, ISO 8859/6 Latin Arabic
- OCR:** OCR-A, OCR-B

UNDERSTANDING THE KEYBOARD

You can enter alphabet characters, numbers, or special symbols using the keyboard on the touch screen. This keyboard is the same as a normal keyboard for easy usability.

Touch the input area where you need to enter characters, then the keyboard pops up on the screen. The keyboard below is the default showing the lowercase letters.



2	Backspace	Deletes the character on the left side of the cursor.
3	Delete	Deletes the character on the right side of the cursor.
4	Clear	Deletes all characters in the input area.
5	Input area	Enters letters within this line.
6	Shift	Toggles between lowercase keys and uppercase keys or vice versa.
7	Symbols	Switches from the alphanumeric keyboard to the symbol keyboard.
8	Space	Enters a blank between characters.
9	OK	Saves and closes input result.
10	Cancel	Cancel and closes input result.

 When you enter an email address, the email keyboard for email pops up. After you enter the address, press **OK** to activate entered address. Press the arrow key on the side for rotating between **From**, **To**, **Cc**, **Bcc**, **Subject**, **Message**.

1	Left/Right	Moves the cursor between characters in the input area.
---	-------------------	--

media and tray

This chapter provides information on how to load originals and print media into your machine.

This chapter includes:

- Preparing originals
- Loading originals
- Selecting print media
- Changing the tray size

PREPARING ORIGINALS

- Do not load paper smaller than 142 x 148 mm (5.6 x 5.8 inches) or larger than 216 x 356 mm (8.5 x 14 inches).
- Do not attempt to load the following types of paper, in order to prevent paper jam, low print quality, machine damage.
 - Carbon-paper or carbon-backed paper
 - Coated paper
 - Onion skin or thin paper
 - Wrinkled or creased paper
 - Curled or rolled paper
 - Torn paper
- Remove all staples and paper clips before loading.
- Make sure any glue, ink, or correction fluid on the paper is completely dry before loading.
- Do not load originals that include different sizes or weights of paper.
- Do not load booklets, pamphlets, transparencies, or documents with other unusual characteristics.

LOADING ORIGINALS

You can use the scanner glass or the automatic document feeder to load an original for copying, scanning, and sending a fax.

On the scanner glass

Make sure that no originals are in the document feeder. If an original is detected in the document feeder, the machine gives it priority over the original on the scanner glass. To get the best scan quality, especially for colored or gray-scaled images, use the scanner glass.

- Loading paper in the tray
- Printing on special media
- Setting the paper size and type
- Using the output support

1. Lift and open the scanner lid.

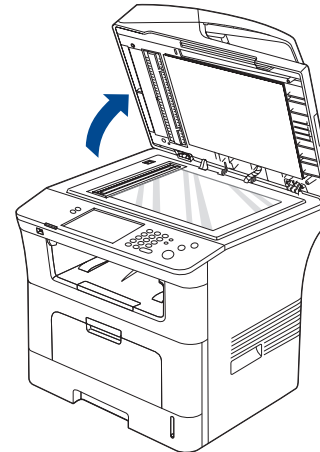

2. Place the original face down on the scanner glass. And align it with the registration guide at the top left corner of the glass.

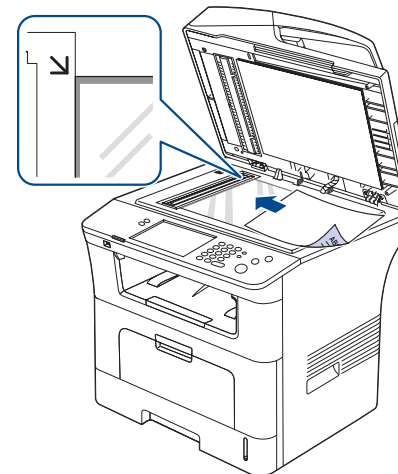

3. Close the scanner lid.



- Leaving the scanner lid open while copying may affect copy quality and toner consumption.
- Dust on the scanner glass may cause black spots on the printout. Always keep it clean. (See "Cleaning the scan unit" on page 99.)
- If you are copying a page from a book or magazine, lift the scanner lid until its hinges are caught by the stopper and then

close the lid. If the book or magazine is thicker than 30 mm, start copying with the lid open.



- Be careful not to break the scanner glass. You may get hurt.
- Do not put hands while closing the scanner lid. The scanner lid may fall on your hands and get hurt.
- Do not look the light from inside of the scanner while copying or scanning. It is harmful to eyes.

In the document feeder

Using the document feeder, you can load up to 50 sheets of paper (80 g/m², 20 lb bond) for one job.

1. Flex or fan the edge of the paper stack to separate the pages before loading originals.

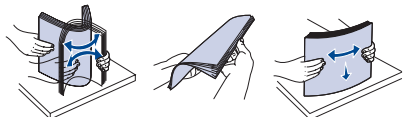

2. Load the original face up into the document feeder. Make sure that the bottom of the original stack matches the paper size marked on the document input tray.

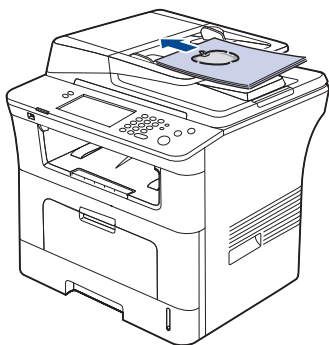

3. Adjust the document width guides to the paper size.

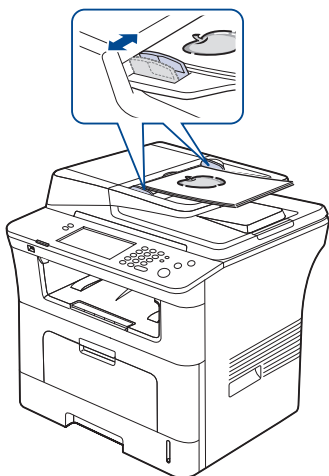

Dust on the document feeder glass may cause black lines on the printout. Always keep the glass clean. (See "Cleaning the scan unit" on page 99.)

SELECTING PRINT MEDIA

You can print on a variety of print media, such as plain paper, envelopes, labels, and transparencies. Always use print media that meet the guidelines for use with your machine.

Guidelines to select the print media

Print media that does not meet the guidelines outlined in this user's guide may cause the following problems:

- Poor print quality
- Increased paper jams
- Premature wear on the machine.

Properties, such as weight, composition, grain, and moisture content, are important factors that affect the machine's performance and the output quality. When you choose print materials, consider the following:

- The type, size and weight of the print media for your machine are described in print media specifications. (See "Print media specifications" on page 126.)
- Desired outcome: The print media you choose should be appropriate for your project.
- Brightness: Some print media are whiter than others and produce sharper, more vibrant images.
- Surface smoothness: The smoothness of the print media affects how crisp the printing looks on the paper.
- Some print media may meet all of the guidelines in this section and still not produce satisfactory results. This may be the result of improper handling, unacceptable temperature and humidity levels, or other variables over which cannot be controlled.
- Before purchasing large quantities of print media, ensure that it meets the requirements specified in this user's guide.



Using print media that does not meet these specifications may cause problems, requiring repairs. Such repairs are not covered by the warranty or service agreements.

The amount of paper put into the tray may differ according to media type used. (See "Print media specifications" on page 126.)

Media sizes supported in each mode

MODE	SIZE	SOURCE
Copy mode	All sizes supported by the machine	<ul style="list-style-type: none"> • tray 1 (Legal, US Folio, Letter, A4, Oficio, JIS B5, ISO B5, Executive, A5) • optional tray 2 (Legal, US Folio, Letter, A4, Oficio, JIS B5, ISO B5, Executive, A5) • multi-purpose tray
Print mode		
Fax mode		
Duplex printing ^a	Letter, A4, Legal, US Folio, Oficio	<ul style="list-style-type: none"> • tray 1 • optional tray 2 • multi-purpose tray

a. 75 to 90 g/m² (20~24 lb bond) only

CHANGING THE TRAY SIZE

The tray is preset to Letter or A4 size, depending on your country. To change the size, you need to adjust the paper guides.

1. Push the back plate of the tray outwards completely so that it can extend the length of the tray.

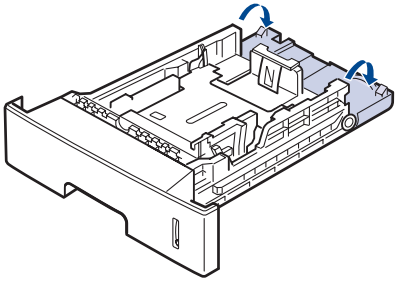

2. Squeeze the paper length guide and slide it to the correct position for the paper size you are loading, which is marked at the bottom of the tray.

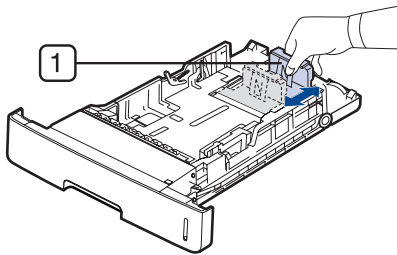

1 Paper length guide

3. Flex or fan the edge of the paper stack to separate the pages before loading originals.

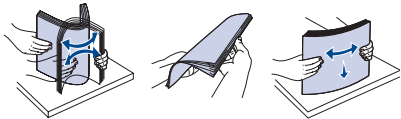

4. After inserting paper into the tray, squeeze the paper width guides and slide them to the desired paper size marked at the bottom of the tray.

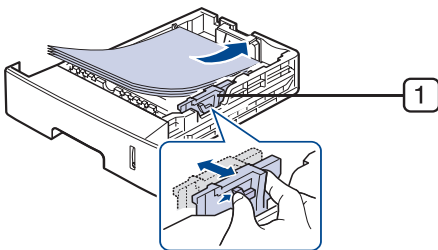

1 Paper width guide

- Do not push the paper width guide too far causing the media to warp.
- If you do not adjust the paper width guide, it may cause paper jams.

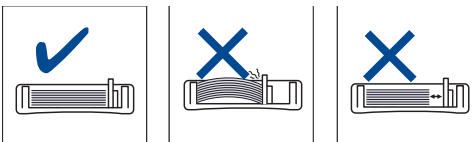

LOADING PAPER IN THE TRAY

Tray 1 / optional tray

Load the print media you use for the majority of your print jobs into tray 1. Tray 1 can hold a maximum of 500 sheets of plain paper.

You can purchase an optional tray and attach it below the standard tray to load an additional 500 sheets of plain paper. (See "Available supplies" on page 118.)

- Using photographic paper or coated paper may cause problems, requiring repairs. Such repairs are not covered by the warranty or service agreements.

1. Pull out tray. And adjust the tray size to the media size you are loading. (See "Changing the tray size" on page 38.)
2. Flex or fan the edge of the paper stack to separate the pages before loading originals.



3. Place paper with the side you want to print facing down.

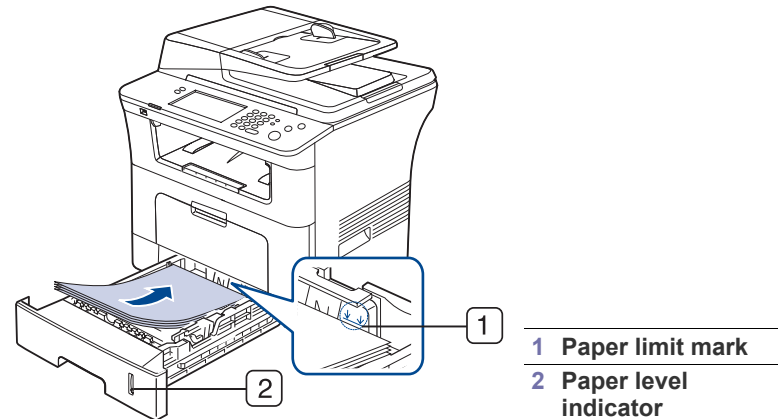

1 Paper limit mark
2 Paper level indicator

- Paper quantity indicator shows the amount of paper in the tray.

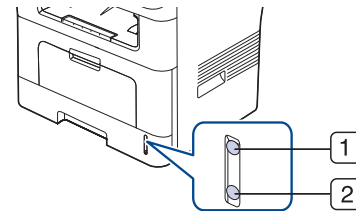

1 Full
2 Empty

4. When you print a document, set the paper type and size for the tray. For information about setting the paper type and size on the control panel. (See "Setting the paper size and type" on page 42.)

- If you experience problems with paper feeding, check whether the paper meets the media specification. Then, try placing one sheet at a time in the multi-purpose tray. (See "Print media specifications" on page 126.)
- The settings made from the machine driver override the settings on the control panel.

- a) To print in application, open an application and start the print menu.
- b) Open **Printing Preferences**. (See "Opening Printing Preferences" on page 47.)
- c) Press the **Paper** tab in **Printing Preferences**, and select an appropriate paper type.
For example, if you want to use a label, set the paper type to **Label**.
- d) Select tray in paper source, then press **OK**.
- e) Start printing in application.

Multi-purpose tray

The multi-purpose tray can hold special sizes and types of print material, such as postcards, note cards, and envelopes. It is useful for single page printing on colored paper.

Tips on using the multi-purpose tray

- Load only one type, size and weight of print media at a time in the multi-purpose tray.
- To prevent paper jams, do not add paper while printing when there is still paper in the multi-purpose tray. This also applies to other types of print media.
- Print media should be loaded face up with the top edge going into the multi-purpose tray first and be placed in the center of the tray.
- Always load the specified print media only to avoid paper jams and print quality problems. (See "Print media specifications" on page 126.)
- Flatten any curl on postcards, envelopes, and labels before loading them into the multi-purpose tray.

1. Hold the handle of multi-purpose tray and pull it down to open.

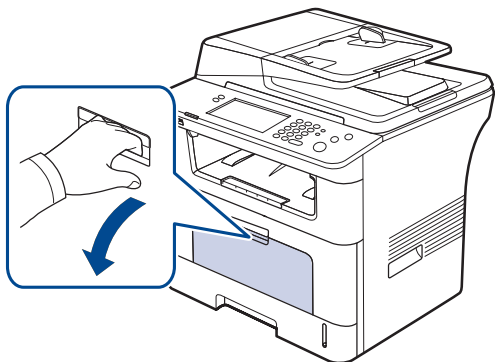

2. Flex or fan the edge of the paper stack to separate the pages before loading originals.



3. Load the paper.

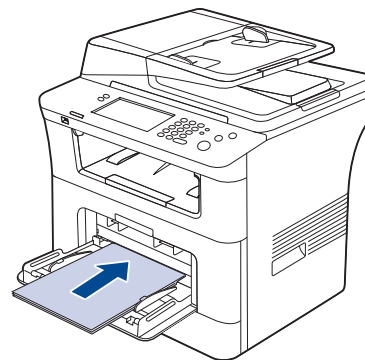

4. Squeeze the multi-purpose tray paper width guides and adjust them to the width of the paper. Do not force too much, or the paper will be bent, which will result in a paper jam or skew.

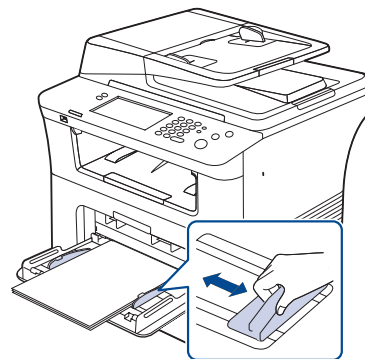

- When printing the special media, you must follow the loading guideline. (See "Printing on special media" on page 40.)
- When papers overlap when printing using Multi-purpose tray, open tray 1 and remove overlapping papers then try printing again.
- When paper does not feed well while printing, push the paper in manually until it starts feeding automatically.

5. When you print a document, set the paper type and size for the multi-purpose tray.

For information about setting the paper type and size on the control panel. (See "Setting the paper size and type" on page 42.)

- The settings made from the machine driver override the settings on the control panel.
 - a) To print in application, open an application and start the print menu.
 - b) Open **Printing Preferences**. (See "Opening Printing Preferences" on page 47.)
 - c) Press the **Paper** tab in **Printing Preferences**, and select an appropriate paper type.
For example, if you want to use a label, set the paper type to **Label**.
 - d) Select **Manual Feeder** in paper source, then press **OK**.
 - e) Start printing in application.
 - f) After printing, close the multi-purpose tray.

PRINTING ON SPECIAL MEDIA

The table below shows the available special media for each tray.

 When using special media, we recommend you feed one paper at a time. Check the maximum input number of media for each tray. (See "Print media specifications" on page 126.)

TYPES	TRAY 1	OPTIONAL TRAY	MULTI-PURPOSE TRAY
Plain ^a	○	○	○
Thick ^a	○	○	○
Thin ^a	○	○	○
Cotton	X	X	○
Color	X	X	○
Preprinted ^a	○	○	○
Recycle ^a	○	○	○
Envelope	X	X	○
Transparency	X	X	○
Labels	X	X	○
CardStock	X	X	○
Bond	X	X	○
Archive ^a	○	○	○

a. A6, Statement are supported only in the multi-purpose tray.

Envelope

Successful printing on envelopes depends upon the quality of the envelopes.

To print an envelope, place it flap side down with the stamp area on the top left side.

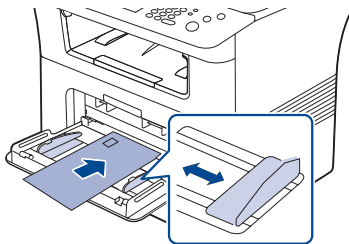

If you need to do the printing job with a wrinkled envelopes, open the rear cover. And push the pressure lever on each side down.

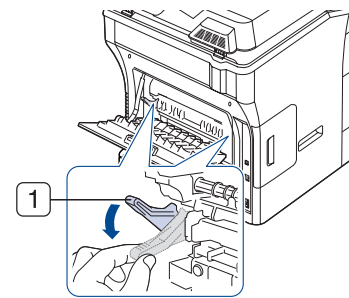

1 Pressure lever

- When selecting envelopes, consider the following factors:
 - Weight:** The weight of the envelope paper should not exceed 90 g/m² otherwise, jam may occur.
 - Construction:** Prior to printing, envelopes should lie flat with less than 6 mm curl, and should not contain air.
 - Condition:** Envelopes should not be wrinkled, nicked, either damaged.
 - Temperature:** Use envelopes that are compatible with the heat and pressure of the machine during operation.
- Use only well-constructed envelopes with sharp-and well-creased folds.
- Do not use stamped envelopes.
- Do not use envelopes with clasps, snaps, windows, coated lining, self-adhesive seals, or other synthetic materials.
- Do not use damaged or poorly made envelopes.
- Be sure the seam at both ends of the envelope extends all the way to the corner of the envelope.



1 Acceptable

2 Unacceptable

- Envelopes with a peel-off adhesive strip or with more than one flap that folds over to seal must use adhesives compatible with the machine's fusing temperature for 0.1 second. To view the fusing temperature, check your machine's specification. (See "General specifications" on page 122.) The extra flaps and strips might cause wrinkling, creasing, or jams, and may even damage the fuser.
- For the best print quality, position margins no closer than 15 mm from the edges of the envelope.
- Avoid printing over the area where the envelope's seams meet.

Transparency

To avoid damaging the machine, use only transparencies designed for use in laser printers.

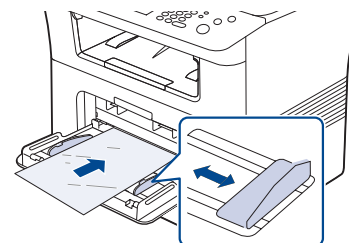

- Transparencies used in the machine must be able to withstand machine's fusing temperature.
- Place them on a flat surface after removing them from the machine.
- Do not leave unused transparencies in the paper tray for long periods of time. Dust and dirt may accumulate on them, resulting in spotty printing.
- To avoid smudging caused by fingerprints, handle them carefully.
- To avoid fading, do not expose printed transparencies to prolonged sunlight.
- Ensure that transparencies are not wrinkled, curled, or have any torn edges.
- Do not use transparencies that separates from the backing sheet.
- To prevent transparencies from sticking to each other, do not let the printed sheets stack up as they are begin printed out.
- Recommended media: Transparency for a color laser printer by Xerox, such as 3R 91331(A4), 3R 2780(Letter)

Labels

To avoid damaging the machine, use only labels designed for use in laser machines.

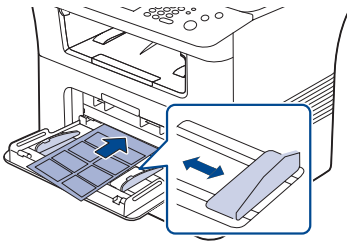

- When selecting labels, consider the following factors:
 - **Adhesives:** The adhesive material should be stable at your machine's fusing temperature. Check your machine's specification to view the fusing temperature. (See "General specifications" on page 122.)
 - **Arrangement:** Only use labels with no exposed backing between them. Labels can peel off sheets that have spaces between the labels, causing serious jams.
 - **Curl:** Prior to printing, labels must lie flat with no more than 13 mm of curl in any direction.
 - **Condition:** Do not use labels with wrinkles, bubbles, or other indications of separation.
- Make sure that there is no exposed adhesive material between labels. Exposed areas can cause labels to peel off during printing, which can cause paper jams. Exposed adhesive can also cause damage to machine components.
- Do not run a sheet of labels through the machine more than once. The adhesive backing is designed for only a single pass through the machine.
- Do not use labels that are separating from the backing sheet or are wrinkled, bubbled, or otherwise damaged.

Card stock/ Custom-sized paper

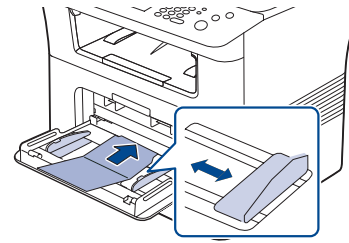

- Do not print on media smaller than 76.2 mm (3 inches) wide or 127 mm (4 inches) long.
- In the software application, set margins at least 6.4 mm (0.25 inches) away from the edges of the material.

Preprinted paper

When loading preprinted paper, printed side should be facing down with an uncurled edge at the front. If you experience problems with paper feed, turn the paper around. Note that print quality is not guaranteed.

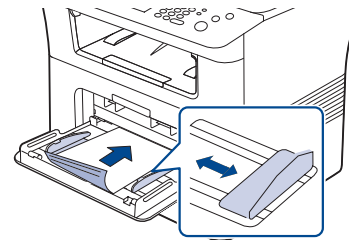

- Preprinted paper must be printed with heat-resistant ink that will not melt, vaporize, or release hazardous emissions when subjected to the machine's fusing temperature for 0.1 second. Check your machine's specification to view the fusing temperature. (See "General specifications" on page 122.)
- Preprinted paper ink must be non-flammable and should not adversely affect machine rollers.
- Before you load preprinted paper, verify that the ink on the paper is dry. During the fusing process, wet ink can come off preprinted paper, reducing print quality.

Photo

- Make sure not to use the inkjet photo paper with this machine. It could cause damage to the machine.

Glossy

 Load one paper to the multi-purpose tray at a time, glossy side facing up.

- Recommended media: Glossy paper (Letter) for this machine by HP Brochure Paper (Product: Q6611A) only.
- Recommended media: Glossy paper (A4) for this machine by HP Superior Paper 160 glossy (Product: Q6616A).

SETTING THE PAPER SIZE AND TYPE

After loading paper in the paper tray, set the paper size and type using the control panel. These settings will apply to copy and fax modes. For computer printing, select the paper size and type in the application program you use on your computer. (See "Paper tab" on page 48.)

 The settings made from the machine driver override the settings on the control panel.

1. Press **Machine Setup** on the control panel.
2. Press **Admin Setting**.
3. When the login message appears, enter password with number keypad and press **OK**. (See "Setting the authentication password" on page 33.)
4. Press the **General** tab.
5. Press the down arrow to switch the screen, press **Tray Management**.
6. Select tray and its options such as paper size and type.
7. Press **OK**.

 If you want to use special-sized paper-such as a billing paper, select **Custom** in the **Paper** tab in the **Printing Preferences**. (See "Paper tab" on page 48.)

USING THE OUTPUT SUPPORT

 The surface of the output tray may become hot if you print a large number of pages at once. Make sure that you do not touch the surface, and do not allow children near it.

The printed pages stack on the output support, and the output support will help the printed pages to align. Pull out the output support and expand it.

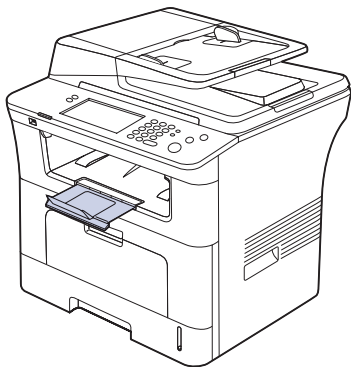

 If paper coming out of the output tray has problems, such as excessive curl, try printing to the rear cover. The rear cover can only hold one piece of paper at a time, do not let the papers stack on the rear cover.

This chapter explains common printing tasks.

This chapter includes:

- Printer driver features
- Basic printing
- Using special print features
- Understanding Printing Preferences
- Using direct printing utility
- Changing the default print settings

 The procedures in this chapter are mainly based on Windows XP.

PRINTER DRIVER FEATURES

Your printer drivers support the following standard features:

- Paper orientation, size, source, and media type selection
- Number of copies

In addition, you can use various special printing features. The following table shows a general overview of features supported by your printer drivers:

 Some models or operating system may not support the certain feature(s) in the following table.

PCL printer driver

FEATURE	WINDOWS
Machine quality option	○
Poster printing	○
Multiple pages per sheet	○
Fit to page printing	○
Reduce and enlarge printing	○
Different source for first page	○
Watermark	○
Overlay	○
Double-sided printing (duplex)	○

PostScript printer driver

FEATURE	WINDOWS	LINUX	MACINTOSH
Machine quality option	○	○	○
Poster printing	X	X	X
Multiple pages per sheet	○	○ (2, 4)	○
Fit to page printing	○	X	○





- Setting your machine as a default machine
- Printing to a file (PRN)
- Macintosh printing
- Linux printing
- Printing with PS driver

FEATURE	WINDOWS	LINUX	MACINTOSH
Reduce and enlarge printing	○	X	○
Different source for first page	X	X	○
Watermark	X	X	X
Overlay	X	X	X
Double-sided printing (duplex) ^a	○	○	○

a. The machine with Duplex feature prints both side of a paper.

BASIC PRINTING

Your machine allows you to print from various Windows, Macintosh, or Linux applications. The exact steps for printing a document may vary depending on the application you use.

-  Your **Printing Preferences** window that appears in this user's guide may differ depending on the machine in use. However, the composition of the **Printing Preferences** window is similar. Check the operating system(s) that are compatible with your machine. Refer to the OS compatibility section of Printer Specifications . (See "Printer specifications" on page 123.)
- When you select an option in **Printing Preferences**, you may see a warning mark, , or . An exclamation mark () means you can select that certain option but it is not recommended, and () mark means you cannot select that option due to the machine's setting or environment.

The following procedure describes the general steps required for printing from various Windows applications.

-  Macintosh basic printing. (See "Macintosh printing" on page 51.)
- Linux basic printing. (See "Linux printing" on page 53.)

The following **Printing Preferences** window is for Notepad in Windows XP. Your **Printing Preferences** window may differ, depending on your operating system or the application you are using.

1. Open the document you want to print.
2. Select **Print** from the **File** menu. The **Print** window appears.

3. Select your machine from the **Select Printer** list.

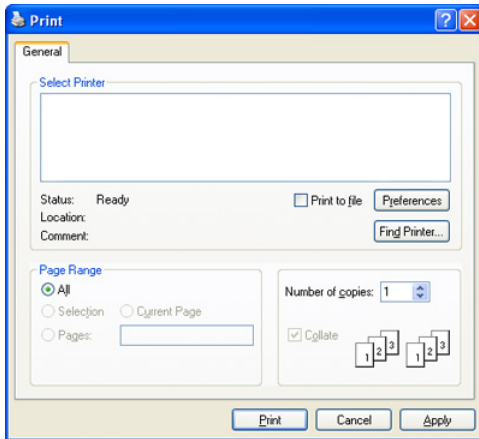

The basic print settings including the number of copies and print range are selected within the **Print** window.

-  To take advantage of the printer features provided by your printer driver, click **Properties** or **Preferences** in the application's **Print** window to change the print setting. (See "Understanding Printing Preferences" on page 47.)

4. To start the print job, click **OK** or **Print** in the **Print** window.



Canceling a print job

If the print job is waiting in a print queue or print spooler, cancel the job as follows:

1. For Windows 2000, select **Settings > Printers**.
 - For Windows XP/2003, select **Printers and Faxes**.
 - For Windows 2008/Vista, select **Control Panel > Hardware and Sound > Printers**.
 - For Windows 7, select **Control Panel > Hardware and Sound > Devices and Printers**.
 - For Windows Server 2008 R2, select **Control Panel > Hardware > Devices and Printers**.
2. For Windows 2000, XP, 2003, Vista and 2008, double-click your machine.
For Windows 7 and Windows Server 2008 R2, right click your printer icon > context menus > **See what's printing**.

-  If **See what's printing** item has ► mark, you can select other printer drivers connected with selected printer.

3. From the **Document** menu, select **Cancel**.

-  You can also access this window by simply double-clicking the machine icon () in the Windows task bar.

You can also cancel the current job by pressing **Stop** on the control panel.

USING SPECIAL PRINT FEATURES

Special print features include:

- "Printing multiple pages on one sheet of paper" on page 44.
- "Printing posters" on page 44.
- "Printing booklets" on page 45.
- "Printing on both sides of paper" on page 45.

- "Change percentage of your document" on page 45.
- "Fitting your document to a selected paper size" on page 45.
- "Using watermarks" on page 46.
- "Using overlay" on page 46.

Printing multiple pages on one sheet of paper

You can select the number of pages to print on a single sheet of paper. To print more than one page per sheet, the pages will be reduced in size and arranged in the order you specify. You can print up to 16 pages on one sheet.

1. To change the print settings from your software application, access **Printing Preferences**. (See "Opening Printing Preferences" on page 47.)
2. Click the **Basic** tab, select **Multiple Pages per Side** in the **Type** drop-down list.
3. Select the number of pages you want to print per sheet (2, 4, 6, 9, or 16) in the **Pages per Side** drop-down list.
4. Select the page order from the **Page Order** drop-down list, if necessary.
5. Check **Print Page Border** to print a border around each page on the sheet.
6. Click the **Paper** tab, select the **Size**, **Source**, and **Type**.
7. Click **OK** or **Print** until you exit the **Print** window.

Printing posters

This feature allows you to print a single-page document onto 4, 9, or 16 sheets of paper, for the purpose of pasting the sheets together to form one poster-size document.

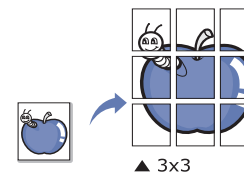

1. To change the print settings from your software application, access **Printing Preferences**. (See "Opening Printing Preferences" on page 47.)
2. Click the **Basic** tab, select **Poster Printing** in the **Type** drop-down list.
3. Select the page layout you want.
Specification of the page layout:
 - **Poster 2x2**: Document will be enlarged and be divided into 4 pages.
 - **Poster 3x3**: Document will be enlarged and be divided into 9 pages.
 - **Poster 4x4**: Document will be enlarged and be divided into 16 pages.
4. Select the **Poster Overlap** value. Specify **Poster Overlap** in millimeters or inches by selecting the radio button on the upper right of **Basic** tab to make it easier to paste the sheets together.

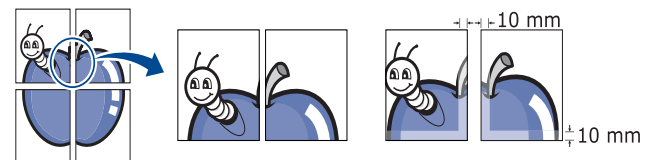

5. Click the **Paper** tab, select the **Size**, **Source**, and **Type**.
6. Click **OK** or **Print** until you exit the **Print** window.
7. You can complete the poster by pasting the sheets together.

Printing booklets

This feature prints your document on both sides of a paper and arranges the pages so that the paper can be folded in half after printing to produce a booklet.

 If you want to make a booklet, you need to print on Letter, Legal, A4, Us Folio, or Oficio sized print media.

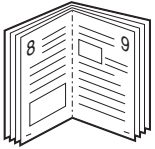

1. To change the print settings from your software application, access the **Printing Preferences**. (See "Opening Printing Preferences" on page 47.)
2. Click the **Basic** tab, select **Booklet Printing** from the **Type** drop-down list.
3. Click the **Paper** tab, select the **Size**, **Source**, and **Type**.

 The **Booklet Printing** option is not available for all paper sizes. In order to find out the available paper size for this feature, select the available paper size in the **Size** option on the **Paper** tab.

If you select an unavailable paper size, this option can be automatically canceled. Select only available paper. (paper without

 or  mark).

4. Click **OK** or **Print** until you exit the **Print** window.
5. After printing, fold and staple the pages.

Printing on both sides of paper

You can print on both sides of a paper; duplex. Before printing, decide how you want your document oriented. You can only use this feature with Letter, Legal, A4, US Folio, or Oficio sized paper.

 Do not print on both sides of the special media, such as labels, envelopes, or thick paper to print on both sides of paper. It may cause a paper jam or damage the machine.

1. To change the print settings from your software application, access **Printing Preferences**. (See "Opening Printing Preferences" on page 47.)
2. Click the **Basic** tab.
3. From the **Double-sided Printing** section, select the binding option you want.
 - **Printer Default:** If you select this option, this feature is determined by the setting you've made on the control panel of the machine.
 - **None**
 - **Long Edge:** This option is the conventional layout used in bookbinding.

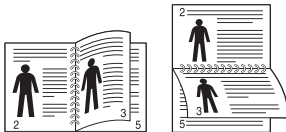

- **Short Edge:** This option is the conventional layout used in

calendars.

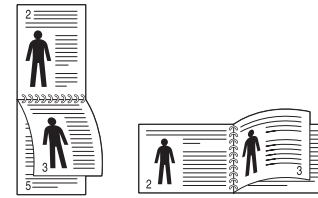

- **Reverse Double-Sided Printing:** Check this option to reverse the print order when duplex printing.
4. Click the **Paper** tab, select the **Size**, **Source**, and **Type**.
 5. Click **OK** or **Print** until you exit the **Print** window.
-  If your machine does not have a duplex unit, you should complete the printing job manually. The machine prints every other page of the document first. After that, a message appears on your computer. Follow the on-screen instructions to complete the printing job.

Change percentage of your document

You can change the size of a document to appear larger or smaller on the printed page by typing in a percentage you want.

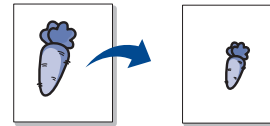

1. To change the print settings from your software application, access **Printing Preferences**. (See "Opening Printing Preferences" on page 47.)
2. Click the **Paper** tab.
3. Enter the scaling rate in the **Percentage** input box.

You can also click the up/down arrows to select the scaling rate.
4. Select the **Size**, **Source**, and **Type** in **Paper Options**.
5. Click **OK** or **Print** until you exit the **Print** window.

Fitting your document to a selected paper size

This printer feature allows you to scale your print job to any selected paper size regardless of the document size. This can be useful when you want to check fine details on a small document.

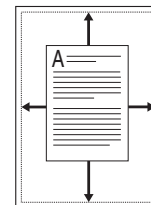

1. To change the print settings from your software application, access **Printing Preferences**. (See "Opening Printing Preferences" on page 47.)
2. Click the **Paper** tab.
3. Select the paper size you want from the **Fit to page**.
4. Select the **Size**, **Source**, and **Type** in **Paper Options**.
5. Click **OK** or **Print** until you exit the **Print** window.

Using watermarks

The watermark option allows you to print text over an existing document. For example, you use it when you want to have large gray letters reading "DRAFT" or "CONFIDENTIAL" printed diagonally across the first page or all pages of a document.

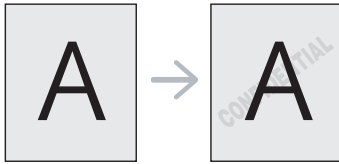

There are several predefined watermarks that come with the machine. They can be modified, or you can add new ones to the list.

Using an existing watermark

1. To change the print settings from your software application, access **Printing Preferences**. (See "Opening Printing Preferences" on page 47.)
2. Click the **Advanced** tab, and select the desired watermark from the **Watermark** drop-down list. You will see the selected watermark in the preview image.
3. Click **OK** or **Print** until you exit the print window.

Creating a watermark

1. To change the print settings from your software application, access **Printing Preferences**. (See "Opening Printing Preferences" on page 47.)
2. From the **Advanced** tab, select **Edit** from the **Watermark** drop-down list. The **Edit Watermarks** window appears.
3. Enter a text message in the **Watermark Message** box. You can enter up to 256 characters. The message displays in the preview window.

When the **First Page Only** box is checked, the watermark prints on the first page only.

4. Select watermark options.
You can select the font name, style, size, and shade from the **Font Attributes** section, as well as set the angle of the watermark from the **Message Angle** section.
5. Click **Add** to add a new watermark to the **Current Watermarks** list.
6. When you have finished editing, click **OK** or **Print** until you exit the **Print** window.

To stop printing the watermark, select **None** from the **Watermark** drop-down list.

Editing a watermark

1. To change the print settings from your software application, access **Printing Preferences**. (See "Opening Printing Preferences" on page 47.)
2. Click the **Advanced** tab, select **Edit** from the **Watermark** drop-down list. The **Edit Watermarks** window appears.
3. Select the watermark you want to edit from the **Current Watermarks** list and change the watermark message and options.
4. Click **Update** to save the changes.
5. Click **OK** or **Print** until you exit the **Print** window.

Deleting a watermark

1. To change the print settings from your software application, access **Printing Preferences**. (See "Opening Printing Preferences" on page 47.)
2. Click the **Advanced** tab, select **Edit** from the **Watermark** drop-down list. The **Edit Watermarks** window appears.
3. Select the watermark you want to delete from the **Current Watermarks** list and click **Delete**.
4. Click **OK** or **Print** until you exit the **Print** window.

Using overlay

What is an overlay?

An overlay is text and/or images stored in the computer hard disk drive (HDD) as a special file format that can be printed on any document. Overlays are often used to take the place of letterhead paper. Rather than using preprinted letterhead, you can create an overlay containing exactly the same information that is currently on your letterhead. To print a letter with your company's letterhead, you do not need to load preprinted letterhead paper in the machine just print the letterhead overlay on your document.

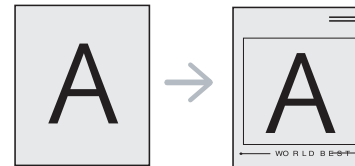

Creating a new page overlay

To use a page overlay, you must create a new page overlay containing your logo or image.

1. Create or open a document containing text or an image for use in a new page overlay. Position the items exactly as you wish them to appear when printed as an overlay.
2. To save the document as an overlay, access **Printing Preferences**. (See "Opening Printing Preferences" on page 47.)
3. Click the **Advanced** tab, and select **Edit** from the **Text** drop-down list. **Edit Overlay** window appears.
4. In the **Edit Overlay** window, click **Create**.
5. In the **Save As** window, type a name of up to eight characters in the **File name** box. Select the destination path, if necessary. (The default is C:\Formover.)
6. Click **Save**. The name appears on the **Overlay List**.
7. Click **OK** or **Print** until you exit the **Print** window.
8. The file is not printed. Instead, it is stored on your computer hard disk drive.

 The overlay document size must be the same as the document you print with the overlay. Do not create an overlay with a watermark.

Using a page overlay

After an overlay has been created, it is ready to be printed with your document. To print an overlay with a document:

1. Create or open the document you want to print.
2. To change the print settings from your software application, access **Printing Preferences**. (See "Opening Printing Preferences" on page 47.)
3. Click the **Advanced** tab.

4. Select the desired overlay from the **Text** drop-down list.
5. If the overlay file you want does not appear in the **Text** drop-down list, select **Edit** from the list and click **Load**. Select the overlay file you want to use.

If you have stored the overlay file you want to use in an external source, you can also load the file when you access the **Load Overlay** window.

After you select the file, click **Open**. The file appears in the **Overlay List** box and is available for printing. Select the overlay from the **Overlay List** box.

6. If necessary, check **Confirm Page Overlay When Printing** box. If this box is checked, a message window appears each time you submit a document for printing, asking you to confirm your wish to print an overlay on your document.

If this box is not checked and an overlay has been selected, the overlay automatically prints with your document.

7. Click **OK** or **Print** until you exit the **Print** window. The selected overlay prints on your document.



The resolution of the overlay document must be the same as that of the document you will print with the overlay.

Deleting a page overlay

You can delete page overlays that you no longer use.

1. In the **Printing Preferences** window, click the **Advanced** tab.
2. Select **Edit** in the **Overlay** drop down list.
3. Select the overlay you want to delete from the **Overlay List** box.
4. Click **Delete**.
5. When a confirming message window appears, click **Yes**.
6. Click **OK** or **Print** until you exit the **Print** window.

UNDERSTANDING PRINTING PREFERENCES

You can preview the settings you selected on the upper right of the **Printing Preferences**.

Opening Printing Preferences

1. Open the document you want to print.
2. Select **Print** from the **File** menu. The **Print** window appears.
3. Select your machine from the **Select Printer**.
4. Click **Properties** or **Preferences**.

Basic tab

Use **Basic** tab to adjust how the document appear on the printed page. Click the **Basic** tab to display the options shown below.

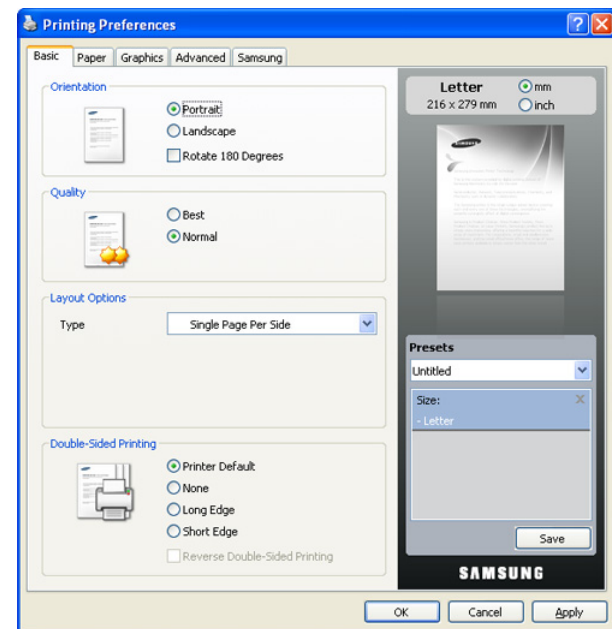

Orientation

This option allows you to select the direction in which information is printed on a page.

- **Portrait:** This option prints across the width of the page, letter style.
- **Landscape:** This option prints across the length of the page, spreadsheet style.
- **Rotate 180 Degrees:** This option allows you to rotate the page, 180 degrees.

Quality

The available **Quality** options may vary depending on your machine. The higher the setting, the sharper the clarity of printed characters and graphics. The higher setting may also increase the printing time of a document.

Layout Options

This option allows you to select various ways to layout your document.

- **Single Page Per Side:** This option is a basic layout option. This option allows you to print a page on one side of a paper.
- **Multiple Pages Per Side:** This option allows you to print several pages on one side of a paper. (See "Printing multiple pages on one sheet of paper" on page 44.)
- **Poster Printing:** This option allows you to print your document into a poster-size document. This option prints your document into several pages. Paste printed pages together to form one poster-size document. (See "Printing posters" on page 44)
- **Booklet Printing:** This option allows you to print your document on both sides of the paper to make into a booklet. (See "Printing booklets" on page 45.)

Double-Sided Printing

This option allows you to print on both sides of paper. (See "Printing on both sides of paper" on page 45.)

Paper tab

Use the **Paper** tab options to set the basic paper handling specifications. Click the **Paper** tab to display the options shown below.

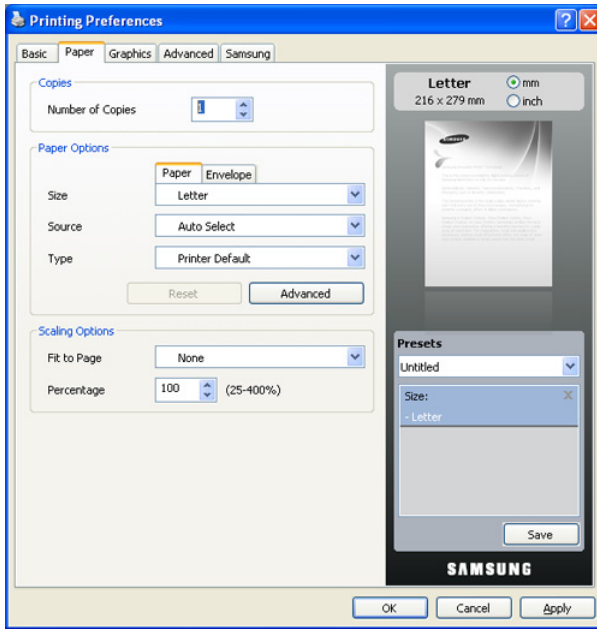

Copies

This option allows you to choose the number of copies to be printed. You can select 1 to 999 copies.

Paper Options

This option allows you to choose paper tray you want to use.

 When printing on an envelope, select the **Envelope** tab to set the options.

- **Size:** This option allows you to set the size of paper to be loaded in the tray. This setting appears in the list, so that you can select it.
- **Source:** Make sure that **Source** is set to the corresponding paper tray. Use **MP Tray** when printing on special materials, such as envelopes and transparencies.
- **Type:** This option allows you to set the type of paper to be loaded in the tray. This setting appears in the list, so that you can select it. This will let you get the best quality printout. If not, the desired print quality may not be achieved.
 - **Plain:** Normal plain paper. Select this type if your machine is monochrome and printing on the 60 G./m² (16 lb) cotton paper.
 - **Thick:** 90 to 105 g/m² (24 to 28 lb) thick paper.
 - **Thin:** 60 to 70 g/m² (16 to 19 lb) thin paper.
 - **Cotton:** 75 to 90 g/m² (20 to 24 lb) cotton paper such as Gilbert 25 % and Gilbert 100 %.
 - **Color:** 75 to 90 g/m² (20 to 24 lb) color-backgrounded paper.
 - **Preprinted:** 75 to 90 g/m² (20 to 24 lb) preprinted paper.
 - **Recycled:** 75 to 90 g/m² (20 to 24 lb) recycled paper.
 - **Envelope:** 75 to 90 g/m² (20 to 24 lb) envelope.
 - **Transparency:** 138 to 146 g/m² (37 to 39 lb) transparency paper.
 - **Labels:** 120 to 150 g/m² (32 to 40 lb) label.

- **CardStock:** 90 to 163 g/m² (24 to 43 lb) cardstock.
 - **Bond:** 105 to 120 g/m² (28 to 32 lb) bond.
 - **Archive:** 70 to 90 g/m² (19 to 24 lb) If you need to keep the print-out for a long period time, such as archives, select this option.
 - **Advanced:** This option allows you to print the first page using a different paper type from the rest of the document by choosing the tray to use for printing the first page. For example, if you want to print the first page using color paper, load color paper into the **MP Tray**, and plain paper into **Tray 1**. Then, select **Tray 1**. in the **Source** option and **MP Tray** in this **Advanced** option.
-  If you click **Reset**, settings in the **Advanced** option returns to the default setting.

Scaling Options

This option allows you to automatically or manually scale your print job on a page. This option can be grayed out according to the **Layout Options** setting in the **Basic** tab.

- **Fit to Page:** This option allows you to scale your print job to any selected paper size regardless of the document size. (See "Fitting your document to a selected paper size" on page 45.)
- **Percentage:** This option allows you to change the size of a page's contents to appear larger or smaller on the printed page by typing in a percentage you want. (See "Change percentage of your document" on page 45.)

Graphics tab

Use the **Graphic** tab options to adjust the print quality for your specific printing needs.

Click the **Graphic** tab to display the options shown below.

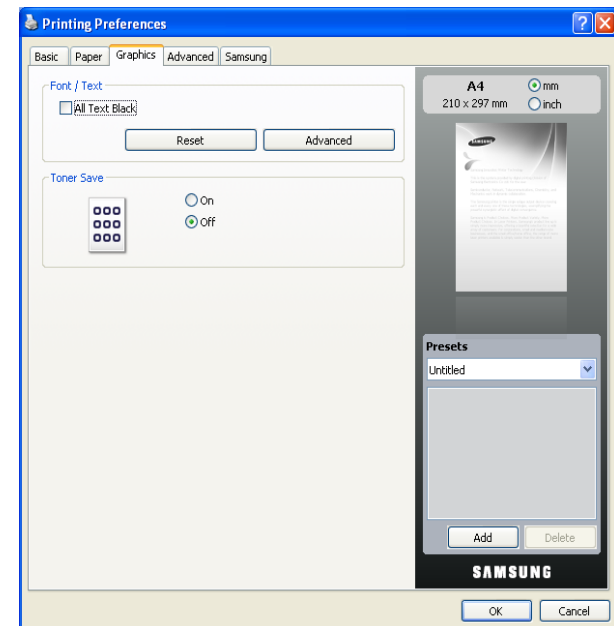

Font/Text

Check **All Text Black** box to print all the texts in your document in solid black, regardless of the color it appears on the screen.

Advanced

- **Download as Outline:** This option allows the driver to download any TrueType fonts that are used in your document not stored

(resident) on your machine. If, after printing a document, you find that the fonts did not print correctly, choose **Download as Bit image** and resubmit your print job. This feature is available only when you use the PCL printer driver.

- **Download as Bit Image:** This option allows the driver to download the font data as bitmap images. Documents with complicated fonts, such as Korean or Chinese, or various other fonts, will print faster in this setting. **Download as bit image** is useful when printing from Adobe programs.
- **Print as Graphics:** This option allows the driver to download any fonts as graphics. When printing documents with high graphic content and relatively few TrueType fonts, printing performance (speed) may be enhanced in this setting.

Use Printer Fonts: When **Use Printer Fonts** is checked, the printer uses the fonts that are stored in its memory (resident fonts) to print your document, rather than downloading the fonts used in your document. Because downloading fonts takes time, selecting this option can speed up your printing time. When using Printer fonts, the printer will try to match the fonts used in your document to those stored in its memory. If, however, you use fonts in your document that are very different from those resident in the printer, your printed output will appear very different from what it looks like on the screen.

 If you click **Reset**, settings in the **Advanced** option returns to the default setting.

Toner Save

This option allows you to extend the life of your toner cartridge and reduces the cost per page without a significant reduction in print quality.

- **On:** This option to allows the printer to use less toner on each page.
- **Off:** If you do not need to save toner when printing a document, select this option.

Advanced tab

Use the **Advanced** tab to set various printing options.

Click the **Advanced** tab to display the options shown below.

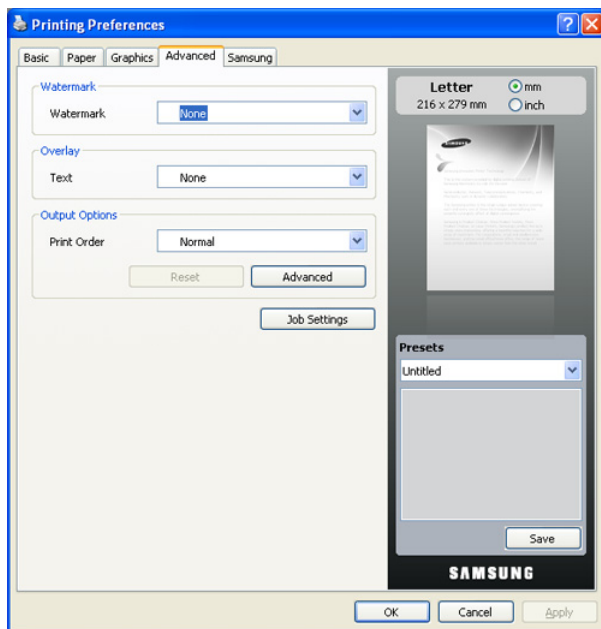

Watermark

This option allows you to print text over an existing document. (See "Using watermarks" on page 46.)

Overlay

Overlays are often used to take the place of letterhead paper. (See "Using overlay" on page 46.)

Output options

This options allows you to set the sequence in which the pages will print. Select the print order from the drop-down list.

- **Normal:** This option allows you to print all pages from the first page to the last page.
- **Reverse All Pages:** This option allows you to print all pages from the last page to the first page.
- **Print Odd Pages:** This option allows you to print only the odd numbered pages of the document.
- **Print Even Pages:** This option allows you to print only the even numbered pages of the document.
- **Advanced:** This option allows you to set advanced output options for printing, such as printing an information page, and saving as a form to later use as an overlay.

 If you click **Reset**, settings in the **Advanced** option returns to the default setting.

Job Settings

This option allows you to choose how to print or save the printing file by using the optional HDD.

- **Print Mode:** The default **Print Mode** is **Normal** which is for printing without saving the printing file in the optional HDD.
- **User ID:** This option is used when you need to find a saved file using the control panel.
- **Job Name:** This option is used when you need to find a saved file using the control panel.

Samsung tab

Use the **Samsung** tab to display the copyright and the version number of the driver. If your computer is connected to the Internet, you can have access to following services:

Click the **Samsung** tab to display the options.

Help

This option allows you to open the **Help** file by searching a keyword.

Service

- **Buy Supplies:** This option allows you to order supplies on-line.
- **Samsung Website:** This option directly connects you to Samsung Website.
- **Registration:** This option allows you to register your machine.
- **Check for updates:** This option allows you to download updates for your printer driver.

Using a favorite setting

The **Presets** option, which is visible on each preferences tab except for **Samsung** tab, allows you to save the current preferences settings for future use.

To save a **Presets** item:

1. Change the settings as needed on each tab.
2. Enter a name for the item in the **Presets** input box.

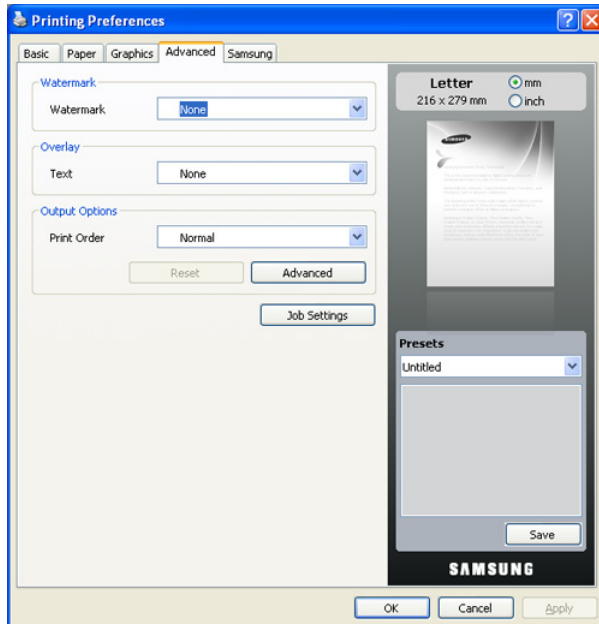

3. Click **Save**. When you save **Presets**, all current driver settings are saved.

To use a saved setting, select it from the **Presets** drop down list. The machine is now set to print according to the setting you selected.

To delete saved setting, select it from the **Presets** drop down list and click **Delete**.

You can also restore the printer driver's default settings by selecting **Default Printer** from the **Presets** drop down list.

Using help

Click  from the upper-right corner of the window, and then click on any option. The help screen gives detailed information about the printing features provided by the printer driver.

USING DIRECT PRINTING UTILITY

This chapter explains how to use the Direct Printing Utility to print PDF files without having to open the files.



- HDD should be installed on your machine, to print PDF files using this program.
- You cannot print PDF files that are restricted to print. Deactivate the printing restriction feature, and retry printing.
- You cannot print PDF files that are restricted by a password. Deactivate the password feature, and retry printing.
- Whether or not a PDF file can be printed using the Direct Printing Utility program depends on how the PDF file was created.
- The Direct Printing Utility program supports the PDF version 1.4 and below. For a higher version, you must open the file to print it.

What is Direct Printing Utility?

Direct Printing Utility is a program that sends a PDF file directly to your machine to print without having to open the file. It sends data through the Windows spooler using the port of the printer driver. It only supports PDF format.

To install this program, select **Custom installation** and put a check mark in this program when you install the printer driver.

Printing

There are several ways you can print using the Direct Printing Utility.

From the Direct Printing Utility window

1. From the **Start** menu select **Programs** or **All Programs** > Direct Printing Utility > Direct Printing Utility.
Or, double-click the Direct Printing Utility shortcut icon on your desktop.
The Direct Printing Utility window opens.
2. Select your machine from the **Select Printer** drop-down list and click **Browse**.
3. Select the PDF file you wish to print and click **Open**.
The PDF file is added in the **Select Files** section.
4. Customize the machine settings for your needs.
5. Click **Print**. The selected PDF file is sent to the machine.

Using the shortcut icon

1. Select the PDF file you wish to print, drag and drop it to the Direct Printing Utility shortcut icon on your desk top. The selected PDF file is sent to the default machine.



If the default machine does not support Direct Printing Utility, the message window alerting you to select the appropriate machine opens. Select the appropriate machine in the **Select Printer** section.

2. Customize the machine settings for your needs.
3. Click **Print**. The selected PDF file is sent to the machine.

Using the right-click menu

1. Right-click on the PDF file you wish to print and select **Direct Printing**.
The Direct Printing Utility window opens with the PDF file is added.
2. Select the machine you wish to use.
3. Customize the machine settings for your needs.
4. Click **Print**. The selected PDF file is sent to the machine.

CHANGING THE DEFAULT PRINT SETTINGS

1. Click the Windows **Start** menu.
2. For Windows 2000, select **Settings** > **Printers**.
 - For Windows XP/2003, select **Printers and Faxes**.
 - For Windows 2008/Vista, select **Control Panel** > **Hardware and Sound** > **Printers**.
 - For Windows 7, select **Control Panel** > **Hardware and Sound** > **Devices and Printers**.
 - For Windows Server 2008 R2, select **Control Panel** > **Hardware** > **Devices and Printers**.
3. Right-click your machine.
4. For Windows XP/2003/2008/Vista, press **Printing Preferences**.
For Windows 7 and Windows Server 2008 R2, from context menus,

select the **Printing preferences**.

 If **Printing preferences** item has ► mark, you can select other printer drivers connected with selected printer.

5. Change the settings on each tab.
6. Click **OK**.

 If you want to change the settings for each print job, change it in **Printing Preferences**.

SETTING YOUR MACHINE AS A DEFAULT MACHINE

1. Click the Windows **Start** menu.
2. For Windows 2000, select **Settings > Printers**.
 - For Windows XP/2003, select **Printers and Faxes**.
 - For Windows 2008/Vista, select **Control Panel > Hardware and Sound > Printers**.
 - For Windows 7, select **Control Panel > Hardware and Sound > Devices and Printers**.
 - For Windows Server 2008 R2, select **Control Panel > Hardware > Devices and Printers**.
3. Select your machine.
4. Right-click your machine and select **Set as Default Printer**.

 For Windows 7 and Windows Server 2008 R2 If **Set as default printer** item has ► mark, you can select other printer drivers connected with selected printer.

PRINTING TO A FILE (PRN)

You will sometimes need to save the print data as a file.

To create a file:

1. Check the **Print to file** box at the **Print** window.

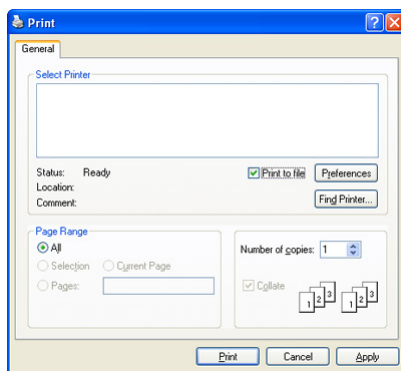

2. Select the folder, assign a name to the file, and then click **Print**.

MACINTOSH PRINTING

This section explains how to print using Macintosh. You need to set the print environment before printing.

- USB connected (See "Macintosh" on page 27.)
- Network connected (See "Macintosh" on page 32.)

Printing a document

When you print with a Macintosh, you need to check the printer driver setting in each application you use. Follow the steps below to print from a Macintosh:

1. Open the document you want to print.
2. Open the **File** menu and click **Page Setup (Document Setup** in some applications).
3. Choose your paper size, orientation, scaling, other options, and make sure that your machine is selected. Click **OK**.

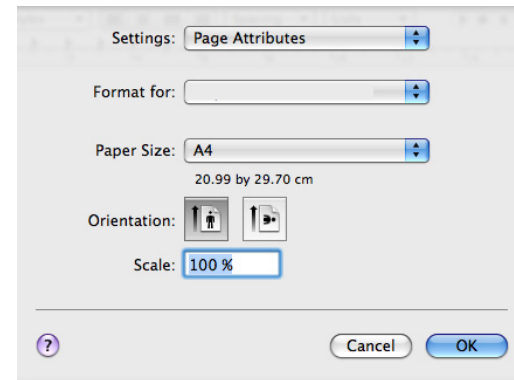

4. Open the **File** menu and click **Print**.
5. Choose the number of copies you want and indicate which pages you want to print.
6. Click **Print**.

Changing printer settings

You can use advanced printing features provided by your machine.

Open an application and select **Print** from the **File** menu. The machine name, which appears in the printer properties window may differ depending on the machine in use. Except for the name, the composition of the printer properties window is similar to the following.

 The setting options may differ depending on printers and Macintosh OS version.

Layout

The **Layout** tab provides options to adjust how the document appears on the printed page. You can print multiple pages on one sheet of paper. Select **Layout** from the drop-down list to access the following features.

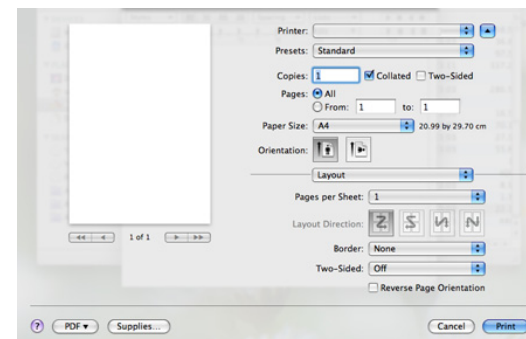

- **Pages per Sheet:** This option determines how many pages to be printed on one page. (See "Printing multiple pages on one sheet of paper" on page 52.)
- **Layout Direction:** This option allows you to select the printing direction on a page similar to the examples on UI.

- **Border:** This option allows you to print a border around each page on the sheet.
- **Two-Sided:** This option allows you to print on both sides of a paper. (See "Printing on both sides of paper" on page 52.)
- **Reverse Page Orientation:** This option allows you to rotate paper 180 degrees.

Graphics

The **Graphics** tab provides options for selecting **Resolution**. Select **Graphics** from the drop-down list to access the graphic features.

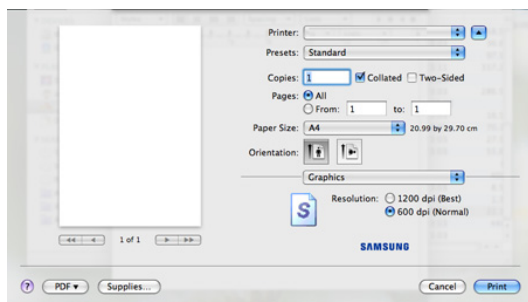

- **Resolution:** This option allows you to select the printing resolution. The higher the setting, the sharper the clarity of printed characters and graphics. The higher setting also may increase the time it takes to print a document.

Paper

Set **Paper Type** to correspond to the paper loaded in the tray from which you want to print. This will let you get the best quality printout. If you load a different type of print material, select the corresponding paper type.

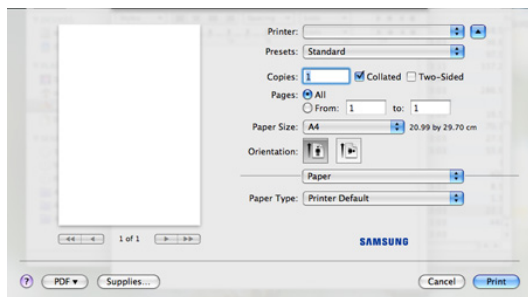

Printer Features

Printer Features tab provides **Reverse Duplex Printing** and **Fit to Page** options. Select **Printer Features** from the drop-down list to access the following features.

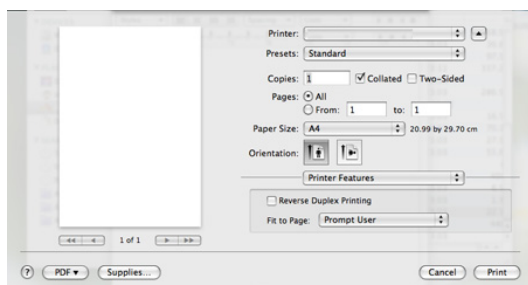

- **Reverse Duplex Printing:** This option allows you to select general print order compared to duplex print order. If this option does not appear, your machine does not have this feature.

- **Fit to Page:** This option allows you to scale your print job to any selected paper size regardless of the document size. This can be useful when you want to check fine details on a small document.

Printing multiple pages on one sheet of paper

You can print more than one page on a single sheet of paper. This feature provides a cost-effective way to print draft pages.

1. Open an application, and select **Print** from the **File** menu.
2. Select **Layout** from the drop-down list. In the **Pages per Sheet** drop-down list, select the number of pages you want to print on one sheet of paper.

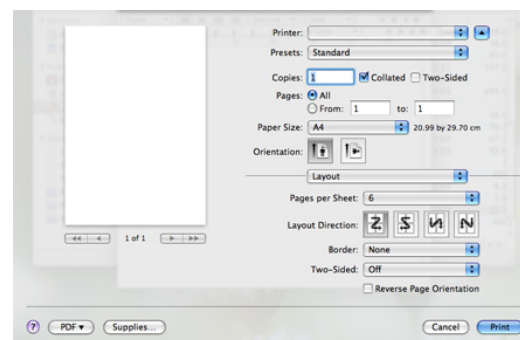

3. Select the other options you want to use.
4. Click **Print**, then machine prints the selected number of pages you want to print on one sheet of paper.

Printing on both sides of paper

You can print on both sides of the paper. Before printing in the duplex mode, decide on which edge you will be binding your finished document. The binding options are, as follows:

- **Long-Edge Binding:** This option is the conventional layout used in book binding.
 - **Short-Edge Binding:** This option is the type often used with calendars.
1. From your Macintosh application, select **Print** from the **File** menu.
 2. Select **Layout** from the drop-down list.
 3. Select a binding orientation from **Two Sided Printing** option.
 4. Select the other options you want to use.
 5. Click **Print** and; the machine prints on both sides of the paper.

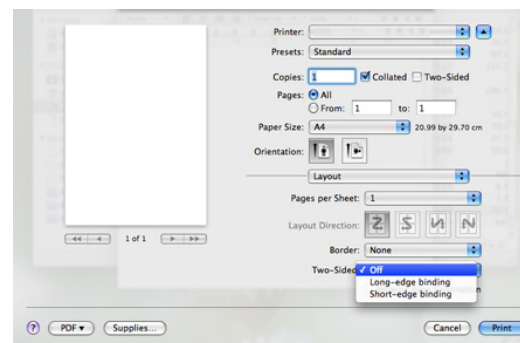

⚠ If you print more than 2 copies, the first copy and the second copy might print on same sheet of paper. Avoid printing on both sides of paper when you are printing more than 1 copy.

LINUX PRINTING

Printing from applications

There are a lot of Linux applications that allow you to print using Common UNIX Printing System (CUPS). You can print on your machine from any such application.

1. Open an application, and select **Print** from the **File** menu
2. Select **Print** directly using `lpr`.
3. In the LPR GUI window, select the model name of your machine from the printer list and click **Properties**.

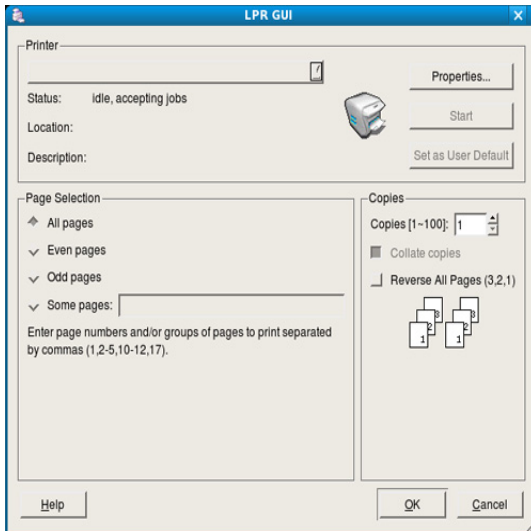

4. Change the print job properties using the following four tabs displayed at the top of the window.

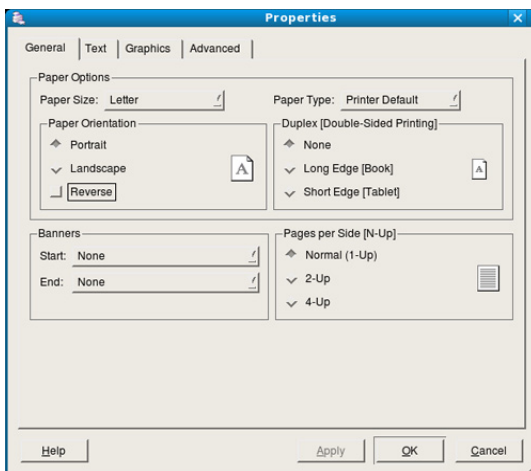

- **General:** This option allows you to change the paper size, the paper type, and the orientation of the documents. It enables the duplex feature, adds start and end banners, and changes the number of pages per sheet.
- **Text:** This option allows you to specify the page margins and set the text options, such as spacing or columns.
- **Graphics:** This option allows you to set image options that are used when printing image files, such as color options, image size, or image position.
- **Advanced:** This option allows you to set the print resolution, paper source, and destination.

5. Click **Apply** to apply the changes and close the **Properties** window.
6. Click **OK** in the **LPR GUI** window to start printing.
7. The Printing window appears, allowing you to monitor the status of your print job.
To abort the current job, click **Cancel**.

Printing files

You can print many different types of files on your machine using the standard CUPS way, directly from the command line interface. The CUPS `lpr` utility allows you to do that. But the drivers package replaces the standard `lpr` tool by a much more user-friendly LPR GUI program.

To print any document file:

1. Type `lpr <file_name>` from the Linux shell command line and press Enter. The **LPR GUI** window appears.
When you type only `lpr` and press **Enter**, the **Select file(s) to print** window appears first. Just select any files you want to print and click **Open**.
2. In the **LPR GUI** window, select your machine from the list, and change the print job properties.
3. Click **OK** to start printing.

Configuring Printer Properties

Using the **Printer Properties** window provided by the **Printers configuration**, you can change the various properties for your machine as a printer.

1. Open the **Unified Driver Configurator**.
If necessary, switch to **Printers configuration**.
2. Select your machine on the available printers list and click **Properties**.
3. The **Printer Properties** window opens.

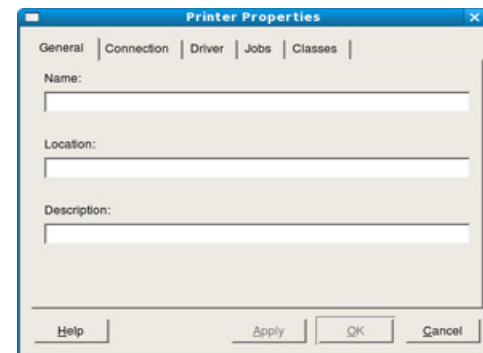

The following five tabs display at the top of the window:

- **General:** This option allows you to change the printer location and name. The name entered in this tab displays on the printer list in **Printers configuration**.
- **Connection:** This option allows you to view or select another port. If you change the machine port from USB to parallel or vice versa while in use, you must re-configure the machine port in this tab.
- **Driver:** This option allows you to view or select another machine driver. By clicking **Options**, you can set the default device options.
- **Jobs:** This option shows the list of print jobs. Click **Cancel job** to cancel the selected job and select the **Show completed jobs** check box to see previous jobs on the job list.
- **Classes:** This option shows the class that your machine is in. Click **Add to Class** to add your machine to a specific class or click **Remove from Class** to remove the machine from the selected class.

- Click **OK** to apply the changes and close the **Printer Properties** window.

PRINTING WITH PS DRIVER

PS printer driver is provided on the supplied software CD.

If you select **Typical installation for a local printer** or **Typical installation for a network printer** when installing machine's driver, PS driver will automatically be installed. (See "Installing USB connected machine's driver" on page 26 or "Installing network connected machine's driver" on page 31.)

 After installing the memory module, you need to select it in the printer properties of the PostScript printer driver in order to use it. (See "Activating the added accessories in PS printer properties" on page 120.)

- Open the document you want to print.
- Select **Print** from the **File** menu. The **Print** window appears. It may look slightly different depending on your application.

The basic print settings are selected within the **Print** window. These settings include the number of copies and print range.

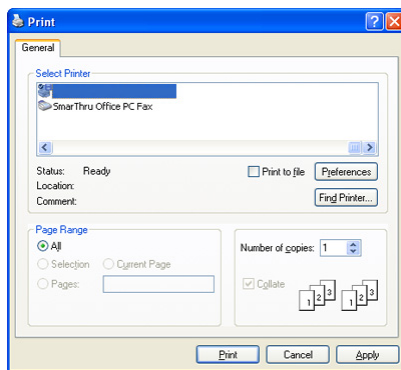

- Select your machine's PS driver from the **Select Printer** list.

 To take advantage of the printer features provided by your printer driver, click **Properties** or **Preferences** in the application's **Print** window to change the print setting. (See "Understanding PS driver's Printing Preferences" on page 54.)

- To start the print job, click **OK** or **Print** in the **Print** window.

Understanding PS driver's Printing Preferences

Opening Printing Preferences

- Open the document you want to print.
- Select **Print** from the **File** menu. The **Print** window appears.
- Select your machine's PS driver from the **Select Printer**.
- Click **Properties** or **Preferences**.

Layout tab

The **Layout** tab provides options to adjust how the document appears on the printed page.

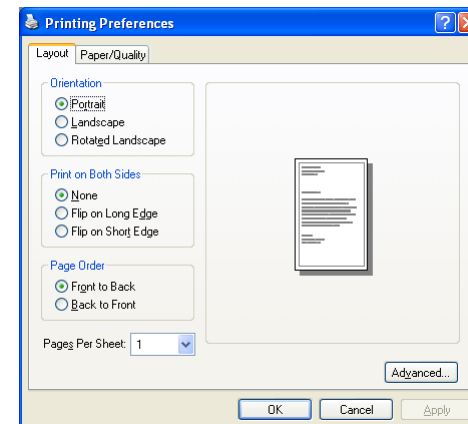

Orientation

This option allows you to select the direction in which the information is printed on a page.

- Portrait:** This option prints across the width of the page, letter style.
- Landscape:** This option prints across the length of the page, spreadsheet style.
- Rotate Landscape:** This option allows you to rotate the page, 180 degrees.

Print on Both Sides

You can print on both sides of a sheet of paper. Before printing, decide how you want your document oriented.

- None**
- Flip on Long Edge:** This option is the conventional layout used in bookbinding.

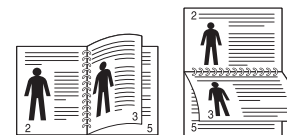

- Flip on Short Edge:** This option is the type often used with calendars.

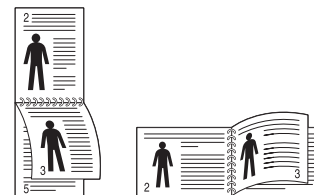

 Do not print on both sides of labels, transparencies, envelopes, or thick papers. It may result in paper jam and damage to the machine.

Pages Per Sheet

You can select the number of pages to print on a single sheet of paper. To print more than one page per sheet, the pages will be reduced in size and arranged in the order you specify. You can print up to 16 pages on one sheet.

Advanced

You can select **Paper Size**, **Graphic**, and **Document Options**.

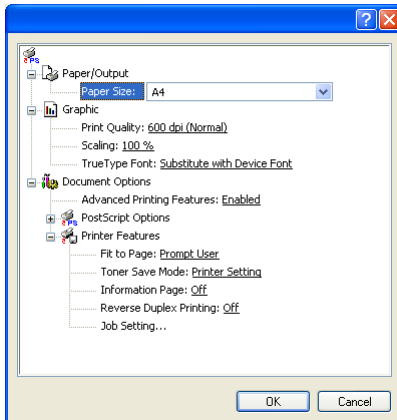

- **Paper/Output:** This option allows you to choose paper size you want to use.
- **Graphic:** This option allows you to select printing quality options.
- **Document Options:** This option allows you to select options such as **PostScript Options** and, **Printer Features**.

Paper/Quality tab

You can select paper tray and media type.

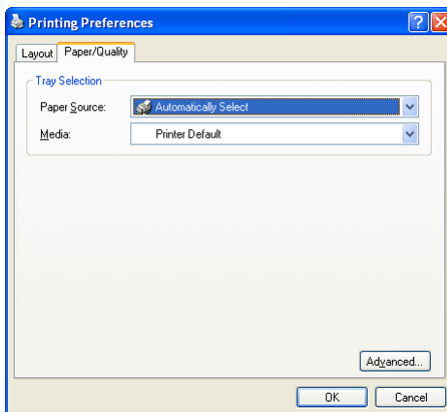

- **Paper Source:** This option allows you to choose which tray to use.
- **Media:** This option allows you to choose which media to use.

This chapter gives you step-by-step instructions for copying documents.

This chapter includes:

- Understanding the Copy screen
- Basic copy
- Changing the settings for each copy
- Using special copy features
- Changing the default copy settings

UNDERSTANDING THE COPY SCREEN

When you press **Copy** on the main screen, the **Copy** screen appears which has several tabs and lots of copying options. All the options are grouped by features so that you can configure your selections easily.

If the screen displays an other menu, press () to go to the main screen.

Basic tab



- **Original Size:** Selects the size of the originals. (See "Selecting the size of originals" on page 57.)
- **Reduce/Enlarge:** Reduces or enlarges the size of a copied image. (See "Reducing or enlarging copies" on page 57.)
- **Duplex:** Sets the machine to print copies on both sides of the paper. (See "Copying on both sides of originals" on page 57.)
- **Output:** Selects **Collated** or **Uncollated** copy options.
- **Original Type:** Improves the copy quality by selecting the document type for the current copy job. (See "Selecting the type of originals" on page 58.)
- **Light, Dark:** Adjusts the brightness level to make a copy that is easier to read, when the original contains faint markings and dark images. (See "Changing the darkness" on page 58.)
- **Paper Supply:** Selects the paper supply tray.

Advanced tab



- **ID Copy:** Prints 2-sided originals on one sheet of paper. This feature is helpful for copying a small-sized item, such as a business card. (See "ID card copying" on page 59.)
- **N-Up:** Prints 2 or 4 original images, reduced to fit onto one sheet of paper. (See "2-up or 4-up copying (N-up)" on page 59.)
- **Poster Copy:** Prints a large image into divided 9 pages. (See "Poster copying" on page 59.)
- **Clone Copy:** Prints multiple image copies from the original document on a single page. (See "Clone copying" on page 59.)
- **Book Copy:** Allows you to copy an entire book. (See "Book copying" on page 60.)
- **Booklet:** Creates booklets from a sequential set of either 1-sided or 2-sided originals. (See "Booklet copying" on page 60.)
- **Covers:** Automatically adds covers to your copied set using stock taken from a different tray. (See "Cover copying" on page 60.)
- **Transparencies:** Adds a blank or printed divider between transparencies within a set. (See "Transparency copying" on page 60.)

Image tab

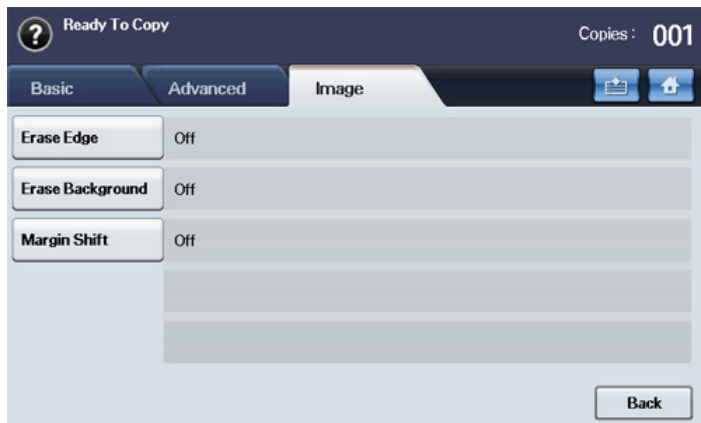

- **Erase Edge:** Allows you to erase punch holes, staple marks, and fold creases along any of the four documents edges. (See "Erasing edges" on page 61.)
- **Erase Background:** Prints an image with no background. (See "Erasing background images" on page 61.)
- **Margin Shift:** Creates a binding edge for the document. (See "Shifting margins" on page 61.)

BASIC COPY

This is the normal and usual procedure for copying your originals.

1. Press **Copy** from the main screen.
2. Place originals, face up, in the document feeder. Or you can use the scanner glass with a single original document face down and closed the scanner lid.

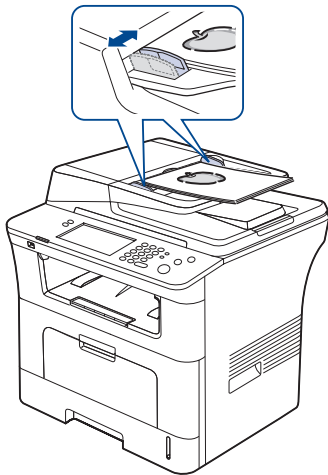

3. If necessary, adjust the settings for each copy such as **Original Size**, **Reduce/Enlarge**, **Duplex** and more. (See "Changing the default copy settings" on page 61.)
4. Select the tray by pressing the appropriate tray on screen.
5. Enter the number of copies using the number keypad, if necessary.
 - ☞ If you want to copy originals on the scanner glass and copy more than two copies, the message **Another Page?** appears after the first page copied. At this time, if you select **No**, the machine starts copying the rest of your originals and sorts the copied papers in order. Because the default value of the **Output** option is **Collated**.

6. Press **Start** on the control panel to begin copying.

☞ To cancel the current copy job, press **Stop** on the control panel. Or you can delete the current and pending job using **Job Status** on the control panel. Select the job you want to cancel and press **Delete**.

CHANGING THE SETTINGS FOR EACH COPY

On the **Basic** tab of the **Copy** screen, you can select copy features before starting to copy.

☞ The **Basic** tab setting is only for each copy. That means that the setting does not apply to the next copy job. After finishing the current copy job, the machine automatically restores the default settings after certain time. Or the machine resume to default setting when you press the **Clear All** button on the control panel.

The default copy setting can be changed in **Admin Setting**. (See "Copy Setup" on page 87)

Selecting the size of originals

Press the **Basic** tab > **Original Size**, then use left/right arrows to set the original size.

Press **more** to see the detail values.

- **Custom:** Selects the scanning area of the original. Press the cardinal point arrows to set the size.
- **Auto:** Automatically detects the size of originals, but this option supports only when originals are Legal, Letter, A4, or A5 sized. If the originals is mixed-sized, then the machine detects the largest original size and select the largest-sized paper in the tray.
- **Mixed Size (Letter & Legal):** Allows for the use of both of Letter and Legal sized papers together, and the machine uses the proper-sized paper from several trays. For example, if the originals are total 3 pages, 1st page is the letter-sized paper, 2nd page is the legal-sized paper, and 3rd page is the letter-sized paper, then the machine prints the output first letter, legal, and letter in order from several trays.
- **Other preset values:** Allows user to easily select commonly used values.

Reducing or enlarging copies

Press the **Basic** tab > **Reduce/Enlarge**, then use left/right arrows to reduce or enlarge an image on the paper.

Press **more** to see the detail values.

- **Original (100%):** Prints texts or images the same size as originals.
- **Auto Fit:** Reduces or enlarges the original based on the size of the output paper.
- **Other preset values:** Allows you to easily select commonly used values.

☞ The **Custom** option is different depending on where the originals is placed. In the document feeder, 25~200% adjustment is possible. And in the scanner glass, 25~400% adjustment is possible.

Copying on both sides of originals

Press the **Basic** tab > **Duplex**, then use left/right arrows to select **Duplex** value.

☞ If you want to copy originals on the scanner glass and copy both sides of original, the message **Another Page?** appears after the first page copied. At this time, load the original's the other side facing down and press **Yes**, then the machine starts scanning the second page of your original.

Press **more** to see the detail values.

- **1 -> 1 Sided:** Scans one side of an original and prints on one side of the paper. This function produces exactly the same print out from originals.

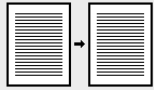

- **1 -> 2 Sided:** Scans one side of originals and prints them on both sides of the paper.

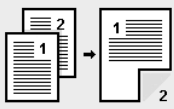

- **1 -> 2 Sided, Rotate Side 2:** Scans one side of the originals and prints on both sides of the paper. But, the information on the back side of the print out is rotated 180°.

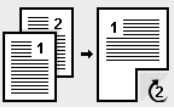

- **2 -> 1 Sided:** Scans both sides of the originals and prints each of one on a separate sheet.

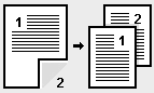

- **2 -> 2 Sided:** Scans both sides of the original and prints on both sides of the paper. This function produces exactly the same print out from the originals.

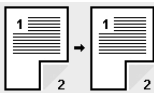

- **2 -> 1 Sided, Rotate Side 2:** Scans both sides of the original and prints each one on a separate sheet. But, the information on the back side of the printout is rotated 180°.

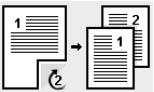

- **Reverse 1 -> 2 Sided:** Scans originals and prints them on both sides of a paper. But the machine reverses the print out order of the originals. The machine prints the second original first, which means the firstly input original is printed on the back side of a paper. For instance, if you print 6 sheet of original papers, every even numbered pages of originals will be printed on the front side of a paper, and every odd numbered pages of originals will be printed on the back side of a paper.

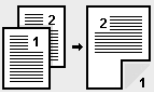

- **Reverse 1 -> 2 Sided, Rotate Sided 2:** Scans originals and prints them on both sides of a paper. But the machine reverses the print out order of the originals. The machine prints the second original first, which means the firstly input original is printed on the back side of a paper. For instance, if you print 6 sheet of original papers, every even numbered pages of originals will be printed on the front side of a paper, and every odd numbered pages of originals will be printed on the back side of a paper. The information on the back side of the print out is rotated 180

degree.



- **Reverse 2 -> 2 Sided:** Scans the both sides of originals and prints them on both sides of a paper. But the machine reverses the print out order of the originals. The machine prints the back sides of originals first, which means the front sides of originals is printed on the back side of a paper.

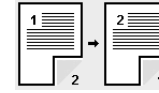

Deciding the form of copy output

Press the **Basic** tab > **Output**, then use left/right arrows to select **Collated** or **Uncollated**.

- If you want to copy originals on the scanner glass and copy both sides of original, the message **Another Page?** appears after the first page copied. At this time, load the original's the other side facing down and press **Yes**, then the machine starts scanning the second page of your original.

Press **more** to see the values.

- **Collated:** Prints output in sets to match the sequence of originals.

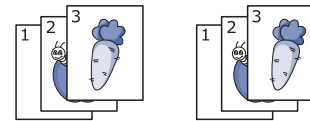

- **Uncollated:** Prints output sorted into stacks of individual pages.

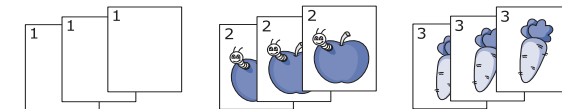

Selecting the type of originals

Press the **Basic** tab and select an appropriate original type.

- **Text:** Use for originals containing mostly text.
- **Text/Photo:** Use for originals with mixed text and photographs.
- **Photo:** Use when originals are photographs.

Changing the darkness

Press the **Basic** tab and this defines the degree of darkness. Use left/right arrows to change the level of light and dark in the printouts.

USING SPECIAL COPY FEATURES

On the **Advanced** tab or the **Image** tab of the **Copy** screen, you can select specific copy features.

ID card copying

The machine prints one side of the original on the upper half of the paper and the other side on the lower half without reducing the size of the original. This feature is helpful for copying a small-sized item, such as a business card.

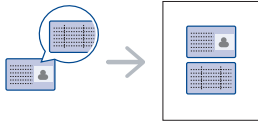

- This copy feature is available only when you place originals on the scanner glass.
- The size of the 2-sided originals should be smaller than A5, if not, some of it won't be copied.

1. Place the front side of an original facing down on the scanner glass where arrows indicate as shown, and close the scanner lid.

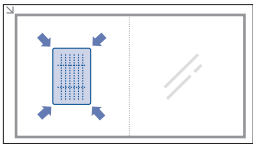

2. Press **Copy** from the main screen.
3. Select the tray in **Paper Supply**.
4. Press the **Advanced** tab > **ID Copy**.
5. Press **Start** on the control panel.

Then the machine starts scanning the front side.

6. Turn the original over and place it on the scanner glass, where arrows indicate as shown then, close the scanner lid.

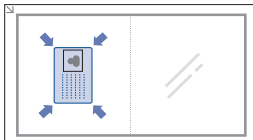

7. Press **Start** on the control panel to begin copying.

- If the original is larger than the printable area, some portions may not be printed.
- If this option is grayed out, select the **Duplex** option to **1 -> 1 Sided**, the **Output** option to **Collated**.

2-up or 4-up copying (N-up)

The machine reduces the size of the original images and prints 2 or 4 pages onto one sheet of paper.

2 or 4-up copying is available only when you load originals into the document feeder.

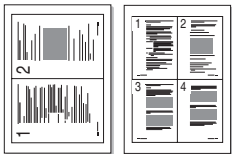

1. Place the originals face up in the document feeder. (See "Loading originals" on page 36.)
2. Press **Copy** from the main screen.
3. Select the tray in **Paper Supply**.
4. Press the **Advanced** tab > **N-Up**.

5. Select **Off**, **2Up**, or **4Up**.

- **Off**: Copies an original onto one sheet of paper.
- **2Up**: Copies two separate originals onto one page.
- **4Up**: Copies four separate originals onto one page.

6. Press **Start** on the control panel.

- You cannot adjust the copy size using the **Reduce/Enlarge** for the **N-Up** feature.

Poster copying

Your original will be divided into 9 portions. You can paste the printed pages together to make one poster-sized document.

This copy feature is available only when you place originals on the scanner glass.

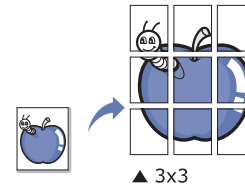

1. Place a single original face down on the scanner glass and close the scanner lid. (See "Loading originals" on page 36.)
2. Press **Copy** from the main screen.
3. Select the tray in **Paper Supply**.
4. Press the **Advanced** tab > **Poster Copy**.

- This feature is available only when the options in the **Basic** tab are selected as below;

- **Duplex** to **1 -> 1 Sided**
- **Reduce/Enlarge** to **Original (100%)**
- **Paper Supply** to **Tray**

5. Press **On** to activate this feature.

6. Press **OK**.

7. Press **Start** on the control panel to begin copying.

- Your original is divided into 9 portions. Each portion is scanned and printed one by one in the following order:

1	2	3
4	5	6
7	8	9

Clone copying

The machine prints multiple original images on a single page. The number of images is automatically determined by the original image and the paper size.

This copy feature is available only when you place originals on the scanner glass.

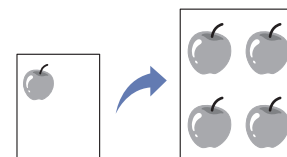



1. Place a single original face down on the scanner glass and close the scanner lid. (See "Loading originals" on page 36.)
2. Press **Copy** from the main screen.
3. Select the tray in **Paper Supply**.
4. Press the **Advanced** tab > **Clone Copy**.
 -  This feature is available only when the options in the **Basic** tab are selected as below;
 - **Duplex** to **1 -> 1 Sided**
 - **Reduce/Enlarge** to **Original (100%)**
 - **Paper Supply** to **Tray**.
5. Press **On** to activate this feature.
6. Press **OK**.
7. Press **Start** on the control panel to begin copying.

Book copying

Use this feature to copy a book. If the book is too thick, lift the scanner lid until its hinges are engaged by the stopper and then close the scanner lid. If the book or magazine is thicker than 30 mm (1.18 inches), start copying with the scanner lid open.

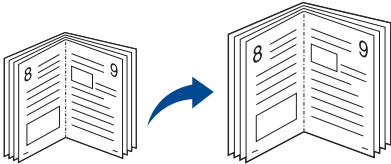
This copy feature is available only when you place originals on the scanner glass.





1. Place the originals face down on the scanner glass and close the scanner lid. (See "Loading originals" on page 36.)
2. Press **Copy** from the main screen.
 -  To remove shadows of a book edge, press the **Image** tab > **Edge Erase** > **Book Center** and **Edges Erase**.
3. Press the **Advanced** tab > **Book Copy**.
4. Select the appropriate option.
 - **Off**: Disables this feature.
 - **Left Page**: Prints left page of the book.
 - **Right Page**: Prints right page of the book.
 - **Both Page**: Prints both facing pages of the book.
5. Press **OK**.
6. Press **Start** on the control panel to begin copying.

Booklet copying

The machine automatically prints on one or both sides of the paper, which are then folded to produce a booklet with all of the pages in the correct sequence.

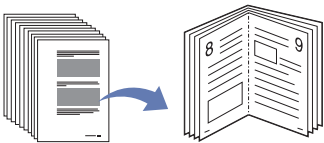
The machine will also reduce and correctly adjust the position of each image to fit on the selected paper.



1. Place the originals face up in the document feeder. Or place a single original face down on the scanner glass and close the scanner lid. (See "Loading originals" on page 36.)
2. Press **Copy** from the main screen.
3. Select the tray in **Paper Supply**.
4. Press the **Advanced** tab > **Booklet**.
5. Press **On** to use this feature, and select detailed settings for each option.
 - **1 Sided Original**: Copies on one side of originals.
 - **2 Sided Original**: Copies on both sides of originals.
6. Press **OK**.
7. Press **Start** on the control panel to begin copying.
 -  This feature is possible only with A4, Letter, Legal, Folio, Oficio, JIS B5, ISO B5, Executive, A5 and Statement sized paper.

Cover copying

The machine automatically adds covers to your copied set using stock taken from a different tray. Covers must be the same size and orientation as the main body of the job.

1. Place the originals face up in the document feeder. Or place a single original face down on the scanner glass and close the scanner lid. (See "Loading originals" on page 36.)
2. Press **Copy** from the main screen.
3. Select the tray in **Paper Supply**.
4. Press the **Advanced** tab > **Covers**.
 -  Once you have set the **Paper Supply** option to **Auto**, you cannot use this feature.
5. Press **On** to use this feature, and select detailed settings for each option.
 - **Position**: Selects whether the cover will be placed at the front, back, or both.
 - **Cover Sheet**: Selects whether the cover will be 1 sided, 2 sided, or blank paper.
 - **Paper Source**: Select the paper tray, where the cover sheet is loaded.
6. Press **OK**.
7. Press **Start** on the control panel to begin copying.

Transparency copying

When you prepare transparencies for presentations, use this feature to copy the information.

-  Before you start this special copy job, set the tray's **Paper Types** and **Paper Size** to **Transparency**. (See "Setting the paper size and type" on page 42.)
1. Place the originals face up in the document feeder. Or place a single original face down on the scanner glass. (See "Loading originals" on page 36.)
2. Load the right-sized transparencies into the tray you have set.
3. Set the paper type to **Transparency**.
4. Press **Copy** from the main screen.
5. Press the **Advanced** tab > **Transparencies**.
6. Select **Transparencies** option.
 - **No Separator**: Does not place separator sheets between transparencies.
 - **Blank Sheet**: Places a blank sheet between transparencies.

- **Printed Sheet:** Places the same image on the divider sheets as printed on the transparency.
7. Select media sources, in case you selected either **Blank Sheet** or **Printed Sheet**.
 8. Press **OK**.
 9. Press **Start** on the control panel to begin copying.

Erasing edges

You can copy the original without any edges or margins.

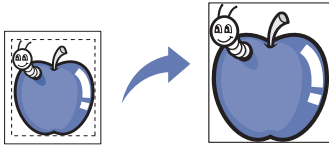

1. Place a single original face down on the scanner glass and close the scanner lid. Or load the originals face up in the document feeder. (See "Loading originals" on page 36.)
2. Press **Copy** from the main screen.
3. Press the **Image** tab > **Edge Erase**.
4. Select the appropriate option.
 - **Off:** Disables this feature.
 - **Border Erase:** Erases equal amounts on all edges of the copies.
 - **Small Original Erase:** Erases 6 mm (0.25 inches) from the edge of the copies. The original must be placed on the scanner glass to use this feature.
 - **Hole Punch Erase:** Erases hole punch marks from the left edge of the copies.
 - **Book Center and Edges Erase:** Erases shadows of a binding or book edge from the center and side edges of the copies. This feature only applies when you do copying a book. (See "Book copying" on page 60.)

 If you have set the **Book Copy** option to **Off**, you cannot use **Book Center and Edge Erase**.

5. Press **OK**.
6. Press **Start** on the control panel to begin copying.

Erasing background images

This feature is helpful when copying originals containing color in the background, as in newspapers or catalogs.

1. Load the originals, face up, in the document feeder. Or place a single original face down on the scanner glass and close the scanner lid. (See "Loading originals" on page 36.)
2. Press **Copy** from the main screen.
3. Press the **Image** tab > **Erase Background**.
4. Select the appropriate option.
 - **Off:** Disables this feature.
 - **Auto:** Optimizes the background.
 - **Enhance:** The higher the number is, the more vivid the background is.
 - **Erase:** The higher the number is, the lighter the background is.
5. Press **OK**.
6. Press **Start** on the control panel to begin copying.

Shifting margins

You can secure a room for binding by shifting the margin of a page.

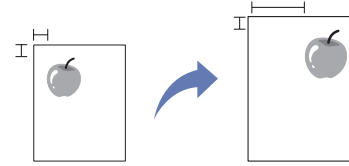

1. Place the originals face up in the document feeder. Or place a single original face down on the scanner glass and close the scanner lid. (See "Loading originals" on page 36.)
2. Press **Copy** from the main screen.
3. Press the **Image** tab > **Margin Shift**.
4. Select **Margin Shift** option.
 - **Off:** Disables this feature.
 - **Auto Center:** Adjusts centers of the paper copy automatically. The original must be loaded on the scanner glass to use this feature.
 - **Custom Margin:** Adjusts the margin of the left and right, top and bottom as you want using arrows. This option supports both on the scanner glass or in the document feeder.
5. Press **OK**.
6. Press **Start** on the control panel to begin copying.

CHANGING THE DEFAULT COPY SETTINGS

If you want to copy always in the same setting, adjust the default copy settings at once. See "Changing the default settings" on page 34.

This chapter gives you information about using your machine as a fax machine.

This chapter includes:

- Preparing to fax
- Understanding the fax screen
- Sending a fax
- Receiving a fax
- Adjusting the document settings
- Setting up a fax phone book

-  We recommend you to use traditional analog phone services (PSTN: public switched telephone network) when connecting telephone lines to use Fax. If you use other Internet services (DSL, ISDN, VoIP), you can improve the connection quality by using the Micro-filter. The Micro-filter eliminates unnecessary noise signals and improves connection quality or Internet quality. Since the DSL Micro-filter is not provided with the machine, contact your Internet Service provider for use on DSL Micro-filter.

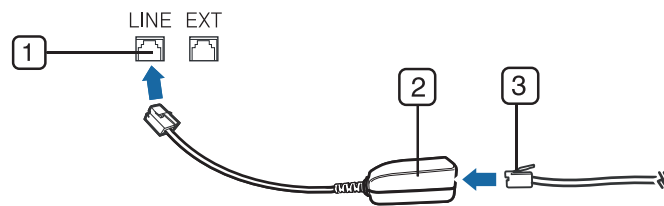

- 1 Line port
- 2 Micro filter
- 3 DSL modem / Telephone line

- To use advanced features of the fax, press **Machine Setup** on the control panel and **Admin Setting > Setup > Fax Setup**. (See "Fax Setup" on page 87.)

PREPARING TO FAX

Before you send or receive a fax, you need to connect the supplied line cord to the wall jack. Refer to the Quick Install Guide how to make a connection. The method of making a telephone connection is varies from one country to another.

- Using the polling option
- Using mailbox
- Printing a report after sending a fax
- Sending a fax in toll save time
- Forwarding a fax to other destination
- Setting up the fax ending tone

UNDERSTANDING THE FAX SCREEN

To use the fax feature, press **Fax** on the main screen. If the screen displays an other menu, press  to go to the main screen.



Basic tab

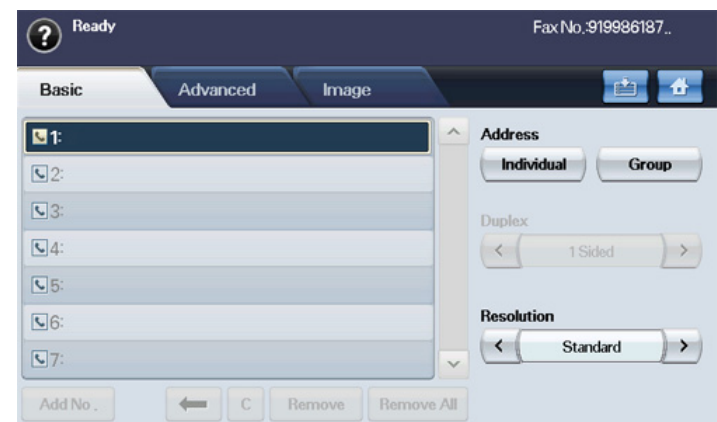

- **Fax number input area:** Shows the recipient's fax number using the number keypad on the control panel. If you configured the phone book, press **Individual** or **Group**. (See "Setting up a fax phone book" on page 66.)
- **Add No.:** Lets you add more destinations.:
- : Deletes the last digit entered.

- **C**: Removes all digits of the selected entry.
- **Remove**: Removes the selected fax number entry.
- **Remove All**: Removes all the fax numbers in the input area.
- **Address**: Picks up the frequently used fax numbers directly from your machine or from SyncThru™ Web Service. (See "Setting up a fax phone book using SyncThru™ Web Service" on page 67.)
- **Duplex**: Selects whether the machine send faxes one side of the original, both sides of the original.
- **Resolution**: Adjusts the resolution options.

Advanced tab

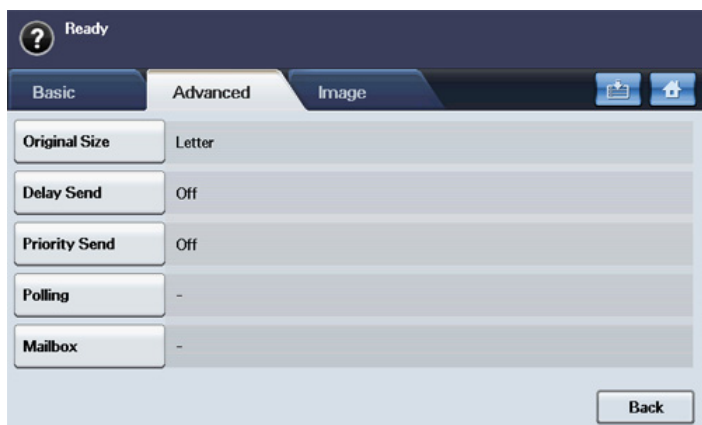

- **Original Size**: Selects the size of the original document. Press **OK** to update current setting.
- **Delay Send**: Sets the machine to send a fax at a later time without your intervention. (See "Delaying a fax transmission" on page 64.)
- **Priority Send**: Sends an urgent fax before reserved operations. (See "Sending a priority fax" on page 65.)
- **Polling**: Used when the receiver requests the document to be faxed remotely at sender's absence or vice versa. In order to use the polling function, the originals must be previously stored in the machine. (See "Storing the originals for polling" on page 67.)
- **Mailbox**: Used to store a received fax or originals in the machine memory which are ready to be polled. You can use a mailbox on the same machine you are using, or the one on a remote machine. Each mailbox has a corresponding mailbox number, name and password. (See "Using mailbox" on page 68.)
- **Back**: Returns to the **Basic** tab.

Image tab

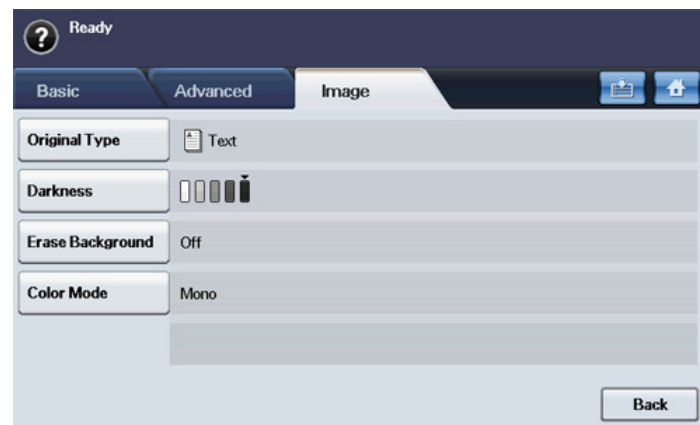

- **Original Type**: Enhances the fax quality based on the type of the original document being scanned. (See "Original Type" on page 66.)
- **Darkness**: Adjusts the level of lightness or darkness of the fax. (See "Darkness" on page 66.)
- **Erase Background**: Reduces dark backgrounds or paper patterns as in newspaper originals. (See "Erase Background" on page 66.)
- **Color Mode**: Selects whether the user sends the fax in mono or color. (See "Color Mode" on page 66.)
- **Back**: Returns to the **Basic** tab.

SENDING A FAX

This part explains how to send a fax and the special methods of transmission.

-  When you place the originals, you can use either the document feeder or the scanner glass. (See "Loading originals" on page 36.) If the originals are placed on both the document feeder and the scanner glass, the machine will read the originals on the document feeder first, which has higher priority in scanning.

Setting the fax header

In some countries, you are required by law to indicate your fax number on any fax you send.

1. Press **Machine Setup** on the control panel.
2. Press **Admin Setting**. When the login message pops up, enter password and press **OK**. (See "Setting the authentication password" on page 33.)
3. Press the **Setup** tab > **Fax Setup** > **Machine ID & Fax**.
4. Touch the input area to enter the machine name and your fax number.
5. Press **OK**.

Sending a fax

1. Press **Fax** from the main screen.
2. Place the originals face up in the document feeder.

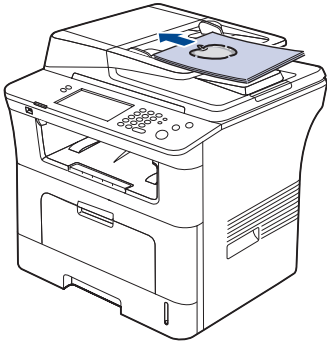

3. Adjust the document settings in the **Image** tab.
 4. Select **Duplex** and **Resolution** options in the **Basic** tab.
-  If the originals are printed on both sides of the paper, select **2 Sided** with left/right arrows in the **Duplex** feature.
5. When the cursor is blinking in the input line, enter the fax number using the number keypad on the control panel. Or use **Address** on the right side of the screen, if you have stored frequently used fax numbers. To add a number, press **Add No.**
 6. Press **Start** on the control panel. The machine starts to scan and send a fax to destinations.

-  • If you want to send fax directly from your computer, use SmarThru Office. (See "Using SmarThru Office" on page 94.)
- When you want to cancel a fax job, press **Stop** before the machine start transmission. Or press the **Job Status** button, and select the job you want to delete, press **Delete**.
 - If you used the scanner glass, the machine shows the message asking to place another page.
 - While the machine is sending a fax, you can not send an email at the same time. (See "Scanning originals and sending through email (Scan to Email)" on page 72.)

Sending a fax manually

This method is sending a fax using **On Hook Dial** on the control panel.

1. Press **Fax** from the main screen.
2. Place the originals face up into the document feeder.

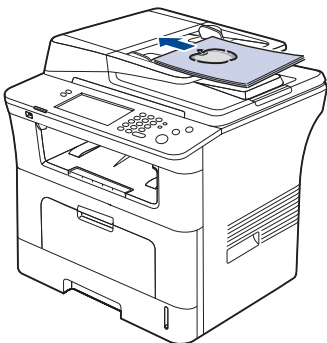

3. Adjust the document settings in the **Image** tab.
 4. Select **Duplex** and **Resolution** options in the **Basic** tab.
-  If the originals are printed on both sides of the paper, select **2 Sided** with left/right arrows in the **Duplex** feature.

5. Press **On Hook Dial** on the control panel.
6. Enter a fax number using the number keypad on the control panel. If the number is which you have dialed recently, press the **Redial/Pause** button on the control panel to show ten recent fax numbers and select a fax number.
7. Press **Start** when you hear a high-pitched fax signal from the remote fax machine.

 Color faxes are only supported when faxes are sent manually. (See "Color Mode" on page 66.)

Resending Automatically

When the number you have dialed is busy or there is no answer, the machine automatically redials the number.

To change the time interval between redials and/or the number of redial attempts, follow the steps below:

1. Press **Machine Setup** on the control panel.
2. Select **Admin Setting**. When the login message pops up, then enter password and press **OK**. (See "Setting the authentication password" on page 33.)
3. Press the **Setup** tab > **Fax Setup**.
4. Press **Redial**.
Select **Redial Term** and **Redial Times**.
5. Press **OK**.

Redialing the last number

1. Press **Fax** from the main screen.
2. Adjust the document settings in the **Image** tab.
3. Place the originals face up into the document feeder.
4. Press the **Redial/Pause** button on the control panel to show ten recent fax numbers.
5. Select a fax number in the list and press **OK**.
The machine automatically begins to send.

Delaying a fax transmission

You can set your machine to send a fax at a later time when you will not be present.

1. Press **Fax** from the main screen.
2. Place the originals face up in the document feeder.
3. Adjust the document settings in the **Image** tab and the **Basic** tab.
4. Press the **Advanced** tab > **Delay Send**.
Press **On**.
5. Enter **Job Name** using the keyboard on the display, select **Start Time** with left/right arrows.

If you do not enter **Job Name**, the machine assigns the job name as '**Fax Send Job xxx**'. 'xxx' number are set in order.

 **Start Time** is the specific time you want the fax to be sent. You can set **Start Time** on a 24 hour basis and 15 minutes later than the current time. For example, if it is 1:00, then you can set the time starting from 1:15. If the set time is incorrect, the warning message will appear machine resets it to the current time.

6. Press **OK** to start storing the scanned original data into memory.

 To cancel delaying a fax, press **Off** before sending is activated.

Adding documents to a reserved delay fax job

You can add additional documents to the delayed fax job which is saved in memory.

1. Press **Machine Setup** on the control panel.
2. Press **Admin Setting**. When the login message pops up, enter password and press **OK**. (See "Setting the authentication password" on page 33.)
3. Press the **Setup** tab > **Fax Setup**.
4. Press down arrow on the right side to move down.
5. Press **Send Batch**.
6. Press **On**.
7. Press **OK**.

When you send a fax, if a fax number is same as the number in delay fax, the machine asks whether you want to add more documents to reserved delay fax.

Sending a priority fax

This function is used when a high priority fax need to be sent ahead of reserved operations. The original is scanned into memory and immediately transmitted when the current operation is finished. In addition, priority transmission will interrupt a sending to multiple destinations between stations (example, when the transmission to station A ends, before transmission to station B begins) or between redial attempts.

1. Press **Fax** from the main screen.
2. Place the originals face up in the document feeder.
3. Adjust the document settings in the **Image** tab and the **Basic** tab.
4. Press the **Advanced** tab > **Priority Send**.
5. Press **On**.
6. Press **OK**.
7. Press **Start** to start the urgent fax job.

RECEIVING A FAX

This part explains how to receive a fax, and the special receiving methods available.

Changing the receive modes

Your machine is preset to **Fax** mode at the factory. When you receive a fax, the machine answers the call on a specified number of rings and automatically receives the fax. But if you want to change the Fax mode to another mode, follow the steps below:

1. Press **Machine Setup** on the control panel.
2. Select **Admin Setting**. When the login message pops up, then enter password and press **OK**. (See "Setting the authentication password" on page 33.)
3. Press the **Setup** tab > **Fax Setup** > **Fax Initial Setup** > **Receive Mode**.
4. Select the option.
 - **Telephone:** Receives a fax by pressing **On Hook Dial** and then **Start**.
 - **Fax:** Answers an incoming fax call and immediately goes into the fax reception mode.
 - **Answering Machine/Fax:** Is for when an answering machine attached to your machine. Your machine answers an incoming call, and the caller can leave a message on the answering machine. If the fax machine senses a fax tone on the line, the machine automatically switches to Fax mode to receive the fax.
5. Press **OK**.

 When the memory is full, the machine can no longer receive any incoming fax. Secure free memory to resume by removing data stored in the memory.

Receiving manually in Telephone mode

You can receive a fax call by pressing **On Hook Dial** and then pressing **Start** when you hear a fax tone from the remote machine. The machine begins receiving a fax.

Receiving automatically in Answering Machine/Fax mode

To use this mode, you must attach an answering machine to the EXT socket on the back of your machine. (See "Rear view" on page 20.)

If the caller leaves a message, the answering machine stores the message as it would normally. If your machine detects a fax tone on the line, it automatically starts to receive the fax.



- If you have set your machine to this mode and your answering machine is switched off, or no answering machine is connected to EXT socket, your machine automatically goes into Fax mode after a predefined number of rings.
- If your answering machine has a user-selectable ring counter, set the machine to answer incoming calls within 1 ring.
- If you are in Telephone mode when the answering machine is connected to your machine, you must switch off the answering machine. otherwise, the outgoing message from the answering machine will interrupt your phone conversation.

Receiving faxes manually using an extension telephone

This feature works best when you are using an extension telephone connected to the EXT socket on the back of your machine. You can receive a fax from someone you are talking to on the extension telephone, without going to the fax machine.

When you receive a call on the extension phone and hear fax tones, press the keys *9* on the extension phone. The machine receives the fax.

Press the buttons slowly in sequence. If you still hear the fax tone from the remote machine, try pressing *9* once again.

To change the *9* to, for example, *3*, follow the steps below:

1. Press **Machine Setup** on the control panel.
2. Select **Admin Setting**. When the login message pops up, then enter password and press **OK**. (See "Setting the authentication password" on page 33.)
3. Press the **Setup** tab > **Fax Setup** > **Receive Start Code**.
4. Select **On**.
5. Press left/right arrows to display number 3.
6. Press **OK**.

Receiving in secure receiving mode

You may need to prevent your received faxes from being accessed by unauthorized people. You can turn on secure receiving mode to restrict printing of received faxes when the machine is unattended. In secure receiving mode, all incoming faxes go into memory. To print the received fax data, enter passcode you have set for this feature.

1. Press **Machine Setup** on the control panel.
2. Select **Admin Setting**. When the login message pops up, then enter password and press **OK**. (See "Setting the authentication password" on page 33.)
3. Press the **Setup** tab > **Fax Setup** > **Secure Receive**.
4. Select **On**.
5. Enter passcode with 4 digit number using the number keypad on the control panel.

 To deactivate the **Secure Receive** feature, press **Off**. In this case, the received fax will be printed out.

Printing received faxes on both sides of the paper

Set this duplex feature to save paper. When the machine prints the received fax data, it prints them on both sides of the paper.

1. Press **Machine Setup** on the control panel.
2. Select **Admin Setting**. When the login message pops up, then enter password and press **OK**. (See "Setting the authentication password" on page 33.)
3. Press the **Setup** tab > **Fax Setup** > **Received Fax Printing** > **Duplex**. Select appropriate option.
 - **Off**: Prints only one side of the paper.
 - **Long Edge**: Prints both sides of the paper, however the binding will be the long edge.
 - **Short Edge**: Prints both sides of the paper, however the binding will be the short edge.
4. Press **OK**.

Receiving faxes in memory

Since your machine is a multi-tasking device, it can receive faxes while you are making copies or printing. If you receive a fax while you are copying or printing, your machine stores incoming faxes in its memory. Then, as soon as you finish copying or printing, the machine automatically prints the fax.

ADJUSTING THE DOCUMENT SETTINGS

Before sending a fax, you can adjust the document settings, such as resolution, darkness, color, duplex and so forth. Refer to explanation of this section.

 The document setting herein is for only current job. If you want to change the default setting on document settings, refer to **Admin Setting** > the **General** tab > **Default Settings**. (See "General settings" on page 85.)

Duplex

This function is especially intended for two-sided originals. You can select whether the machine sends the fax on one side or both sides of the paper. Load the originals onto the document feeder to use this function.

Press **Fax** > the **Basic** tab > **Duplex**. Use left/right arrows to toggle the value.

- **1 Sided**: Is for the originals that are printed on one side only.
- **2 Sided**: Is for the originals that are printed on both sides.

Resolution

Changing the resolution setting affects the appearance of the received document.

Press **Fax** > the **Basic** tab > **Resolution**. Use left/right arrows to toggle the value.

- **Standard**: Usually recommended for originals with text. This option will reduce the transmission time.
- **Fine**: Recommended for the originals containing with small characters, thin lines, or text that was printed using a dot-matrix machine.
- **Super Fine**: Recommended for originals containing with extremely fine detail, this option is enabled only if the receiving machine also supports a **Super Fine** resolution.

 For memory transmission, **Super Fine** mode is not available. The

resolution setting is automatically changed to **Fine**.

Original Type

You can set the original document type to enhance the quality of a document being scanned.

Press **Fax** > the **Image** tab > **Original Type**. Select the appropriate option on the screen and press **OK**.

- **Text**: For originals with text or line art.
- **Text/Photo**: For originals with both text and photographs together.
- **Photo**: For originals that are continuous tone photographs.

Darkness

You can select the degree of darkness of the original document.

Press **Fax** > the **Image** tab > **Darkness**. Press the right arrow to enhance the darkness degree and press **OK**.

Erase Background

You can lighten, reduce or delete the dark backgrounds from scanned colored paper or newspaper originals.

Press **Fax** > the **Image** tab > **Erase Background**. Press **Erase** to activate this function. Select **Level** and press **OK**.

 **Erase Background** is disabled if the **Original Type** is set to **Photo**.

Color Mode

You can transmit a fax in color using this feature. But this feature only applies when you send a fax using **On Hook Dial** on the control panel.

Press **Fax** > the **Image** tab > **Color Mode**. Select option and **OK**.

- **Mono**: Transmits a fax in black and white.
- **Color**: Transmits a fax in color.

 **Color Mode** faxes are only supported when faxes are sent manually. (See "Sending a fax manually" on page 64.)

SETTING UP A FAX PHONE BOOK

Use this feature to store destination names, fax numbers and transmission settings in your machine. There are two options, **Individual** and **Group**.

- **Individual**: Stores up to 200 fax numbers. And the fax numbers which are stored in Individual work as **Speed Dial No.**
- **Group**: Makes groups when you frequently send the same document to several destinations. You can store up to 100 group dial numbers. Entries stored here will be available for selection within the sending list on the **Basic** tab of **Fax**. Dialing **Group** can be also setup comprising of many Individual entries.

Storing individual fax numbers (Speed Dial No.)

1. Press **Fax** > the **Basic** tab > **Individual**.
 - **Edit**: Changes the **ID**, **Speed Dial No.**, and **Fax No.**
 - **New**: Creates the new **Speed Dial No.**
 - **Delete**: Deletes the selected **Speed Dial No.**
 - **Search**: Searches the fax number which currently stored in Individual phone book. When the keyboard pops up, enter **ID**.
 - **Detail**: Shows **ID**, **Fax No.** and Included group information if it is grouped. (See "Storing individual fax numbers (Speed Dial No.)" on page 66.)
 - **Apply**: Inputs the selected fax number to the sending fax number list in the **Basic** tab.
 - **Cancel**: Cancels the current job and goes to the previous screen.

2. Press **New**.
3. Enter the name of the fax number in the **ID** field with the pop up keyboard, and the fax number in the **Fax No.** area using the number keypad on the control panel.
 - **ID:** Enters the name.
 - **Speed Dial No.:** Is automatically filled with the first free number. If you want to assign to a different number, use left/right arrows.
 - **Fax No.:** Enters a fax numbers, only the numbers, with the area code if necessary.
4. Press **OK**.

Storing Group fax numbers (Group No.)

1. Press **Fax** > the **Basic** tab > **Group**.
2. Press **New**.
3. Press the input area in **Group Dial ID**, then the keyboard pops up, enter the name.

Select **Group Dial No.** with left/right arrows.

 - **Group Dial ID:** Enters the group name.
 - **Group Dial No.:** Is automatically filled with the first free number. If you want to assign to a different number, use left/right arrows.
4. Press **OK**.
5. Select an entry from **Speed Dial List**, and press **Add**. Repeat this step until you added entries you need.

Make sure the selected **Speed Dial List** is copied to the left pane, group list.
6. Press **OK** to save the numbers.

Setting up a fax phone book using SyncThru™ Web Service

You can store fax numbers conveniently from the networked computer using SyncThru™ Web Service.

1. Open the web browser in your computer.
2. Enter IP address of your machine, then SyncThru™ Web Service shows. (Example. <http://123.123.123.123>)
3. Press **Machine Settings** > **Fax Setup** > **Fax Phone Book**.
4. Select **Speed Dial (Individual)**.

 Fax numbers are already stored in **Speed Dial (Individual)** can be used when selecting.
5. Press **Add**.
6. Enter **Index**, **Name** and **Phone Number**. **Index** you enter here will be the **Speed Dial No.** in the display screen of your machine.
7. Press **Apply**.

 **Speed Dial** numbers can be imported from an *.csv file.

USING THE POLLING OPTION

Polling is used when one fax machine requests another to send a document. This is useful when the person with the original document is not in the office. The person who wants to receive the document, calls the machine holding where the original is stored and requests that the document be sent. In other words, it "polls" the machine holding that has the original.

 To use this feature, both the sender and receiver must have the polling feature.

The polling process is as follows:

1. Sender stores the originals in the machine. (See "Storing the originals for polling" on page 67.)
2. Sender gives the **Passcode** to the receiver.
3. Receiver dials the fax number and enters the **Passcode** when requested. (See "Polling a remote fax" on page 67.)
Receiver presses **Start** to receive the stored fax.

Storing the originals for polling

1. Press **Fax** from the main screen.
2. Place the originals face up in the document feeder. Or you can use the scanner glass with a single original document, face down.
3. Adjust the document settings in the **Image** tab and the **Basic** tab.
4. Press the **Advanced** tab > **Polling** > **Store**.
5. Press the input area then the pop up keyboard, enter **Passcode** (The four-digit number which you have to inform the receiver). If you do not want to set **Passcode**, enter number 0000 here. Then you can store, delete, print and receive a fax for polling without any passcode.

 If you want to use the **Mailbox**, Store the originals in the **Mailbox**. (See "Storing the originals for polling" on page 67.)
6. Select the **Delete On Poll** option. If you select **Off**, the sent fax data will be remained in the machine's memory even after the fax transmission. If you select **On**, the fax data will be deleted after completes.
7. Press **OK** to start to store the originals into memory for polling.
8. Give the **Passcode** to the receiver.

Printing (Deleting) the polling document

1. Press **Fax** from the main screen.
2. Press the **Advanced** tab > **Polling** > **Print** (or **Delete**).
3. Enter **Passcode**.
4. Press **OK**.

Polling a remote fax

This option allows you to retrieve (poll) a fax which is stored in the remote machine.

1. Press **Fax** from the main screen.
2. Press the **Advanced** tab > **Polling** > **Poll from Remote**.

 You can use **Delay Poll From Remote** to poll the fax at a specific time within 24 hours.
3. Enter **Passcode** and **Destination Fax No** using the number keypad on the control panel. You have to be informed **Passcode** from sender with the remote fax machine.
4. Press **OK**.

Polling from a remote Mailbox

This option allows you to retrieve (poll) a fax which is stored in the **Mailbox** of on the remote machine. Before you start polling, you must be informed of **Mailbox No.** and **Passcode** from the sender. (See "Using mailbox" on page 68.)

1. Press **Fax** from the main screen.
2. Press the **Advanced** tab > **Mailbox** > **Poll from Remote**.
3. Enter **Remote Fax No**, **Mailbox No.**, and **Passcode**. All these field are filled with information from the sender.

 You can use **Delay Poll From Remote** to poll a fax from the remote machine's **Mailbox** at certain time within 24 hours.
4. Press **OK**

USING MAILBOX

You can store the original data in **Mailbox**, since you are absent and the receiver need to be retrieve a fax from you. This feature allows you to program up to 15 individual **Mailbox**. Before you store the originals, the **Mailbox** must be created.

Creating Mailbox

1. Press **Machine Setup** on the control panel.
2. Select **Admin Setting**. When the login message pops up, then enter the password and press **OK**. (See "Setting the authentication password" on page 33.)
3. Press the **Setup** tab > **Fax Setup**.
4. Press the down arrow to scroll down, if necessary.
5. Press **Mailbox Setup**.
6. Press **Mailbox Configuration**. Then the screen displays **Mailbox List**.
7. Select a **Mailbox** on the **Mailbox List**.
8. Press **Edit Mailbox**.
9. Press **Mailbox ID** and enter ID with number keypad on the control panel. Up to 20 numbers you can enter.
10. Enter **Mailbox Name** with the pop up keyboard. It can be either alphabet or number up to 20 digits.
11. Enter **Mailbox Passcode** with the numeric keypad on the control panel.
 If you set **Mailbox Passcode** to number 0000, then the machine does not ask passcode for using **Mailbox**, such as storing, deleting, printing, receiving.
12. Set **Notification** option to **On**, if you want to be notified when a fax is received into **Mailbox**.
13. Press **OK**.

Storing originals in Mailbox

Since you created the mailbox, you can store originals in it.

1. Press **Fax** from the main screen.
2. Place the originals face up in the document feeder. Or you can use the scanner glass with a single original document faced down.
3. Adjust the document settings in the **Image** tab and the **Basic** tab.
4. Press the **Advanced** tab > **Mailbox** > **Store**.
5. Enter **Mailbox No.** and **Passcode**. (See "Creating Mailbox" on page 68.)
6. Press **OK**.

Deleting the data in a specific **Mailbox**

- a) Press **Fax** > the **Advanced** tab > **Mailbox** > **Delete**.
- b) Enter **Mailbox No.** and **Passcode**, and then press **OK**. When the confirmation window appears, press **Yes** to complete the job.

Printing a **Mailbox**

- a) Press **Fax** > the **Advanced** tab > **Mailbox** > **Print**.
- b) Enter **Mailbox No.** and **Passcode**, and press **OK**.

Faxing to a remote Mailbox

To fax and store the originals in a recipient's **Mailbox** in this machine, you can use the **Send to Remote** feature.

1. Press **Fax** from the main screen.
2. Place the originals face up in the document feeder. Or you can use the scanner glass with a single original document face down.
3. Adjust the document settings in the **Image** tab and the **Basic** tab.

4. Press the **Advanced** tab > **Mailbox** > **Send to Remote**.
5. Enter **Remote Fax No**, **Mailbox No.**, and **Passcode**. All these field are filled with information from the receiver.
6. Press **OK**.

PRINTING A REPORT AFTER SENDING A FAX

You can set the machine to print a report whether a fax transmission is successfully completed or not.

 The detailed information is available in advanced setup part. (See "Printing a report" on page 89.)

1. Press **Machine Setup** on the control panel.
2. Press **Admin Setting**. When the login message pops up, enter password and press **OK**. (See "Setting the authentication password" on page 33.)
3. Press the **Print/Report** tab > **Report** > **Fax Report** > **Fax Send Report**.
4. Press **On**.
5. Press **OK**.

SENDING A FAX IN TOLL SAVE TIME

You can set the machine to send a fax in toll save time to save a telephone fee. If you send a fax after setting this feature, fax data will be stored in machine's memory and the machine will start to send fax in toll save time.

1. Press **Machine Setup** on the control panel.
2. Press **Admin Setting**. When the login message pops up, enter password and press **OK**. (See "Setting the authentication password" on page 33.)
3. Press the **Setup** tab > **Fax Setup**.
4. Press down arrow on the right side.
5. Press **Toll Save**.
6. Press **On**.
7. Press **Start Time** and set the start date and time with left/right arrows.
8. Press **OK**.
9. Press **End Time** and set the end date and time with left/right arrows.
10. Press **OK**.
11. Press **OK**.

FORWARDING A FAX TO OTHER DESTINATION

You can set the machine to forward the received or sent fax to other destination by a fax or an email. If you are out of office but have to receive the fax, this feature may be useful.

-  • When you forward a fax by an email, you firstly set the mail server and IP address in SyncThru™ Web Service. (See "Using SyncThru™ Web Service" on page 93.)
- If this **Fax Forward Settings** feature to **On**, you cannot use a fax with the **On Hook Dial** on the control panel.

Forwarding a sent fax to other destination by a fax

You can set the machine to forward every fax you sent to other destination by faxing.

1. Press **Machine Setup** on the control panel.
2. Press **Admin Setting**. When the login message pops up, enter password and press **OK**. (See "Setting the authentication password" on page 33.)

3. Press the **Setup** tab > **Fax Setup**.
4. Press down arrow on the right side.
5. Press **Fax Forward Settings** > **Forward to Fax Setting** > **Send Forward**.
6. Press **On** and enter a fax number using the keypad on the control panel.
7. Press **OK**.

Forwarding a received fax to other destination by a fax

With this feature, you can forward every fax you received to other destination by faxing. When the machine receives a fax, a fax is stored in the memory then, the machine sends it to the destination you have set.

1. Press **Machine Setup** on the control panel.
2. Press **Admin Setting**. When the login message pops up, enter password and press **OK**. (See "Setting the authentication password" on page 33.)
3. Press the **Setup** tab > **Fax Setup**.
4. Press down arrow on the right side.
5. Press **Fax Forward Settings** > **Forward to Fax Setting** > **Receive Forward**.
6. Press **Forward** and enter a fax number using the keypad on the control panel.
 - If you want to set the start time and end time, select **Start Time** and **End Time**.
 - If you want the machine to print the report after forwarding a fax, set the **Forward & Print**.
7. Press **OK**.

Forwarding a sent fax to other destination by an email

1. Press **Machine Setup** on the control panel.
2. Press **Admin Setting**. When the login message pops up, enter password and press **OK**. (See "Setting the authentication password" on page 33.)
3. Press the **Setup** tab > **Fax Setup**.
4. Press down arrow on the right side.
5. Press **Fax Forward Settings** > **Forward to Email Setting** > **Send Forward**.
6. Press **On**.
7. Enter the **From** and **Destination Email** option using the keyboard on the display.
8. Press **OK**.

Forwarding a received fax to other destination by an email

1. Press **Machine Setup** on the control panel.
2. Press **Admin Setting**. When the login message pops up, enter password and press **OK**. (See "Setting the authentication password" on page 33.)
3. Press the **Setup** tab > **Fax Setup**.
4. Press down arrow on the right side.
5. Press **Fax Forward Settings** > **Forward to Email Setting** > **Receive Forward**.
6. Press **Forward** and enter the **From** and **Destination Email** option using the keyboard on the display.

If you want the machine to print the report after forwarding a fax, set the **Forward & Print**.

7. Press **OK**.

SETTING UP THE FAX ENDING TONE

The end fax tone that sounds to indicate that the fax has been received can be turned on or off.

1. Press **Machine Setup** on the control panel.
2. Press **Admin Setting**. When the login message pops up, enter password and press **OK**. (See "Setting the authentication password" on page 33.)
3. Press the **Setup** tab > **Fax Setup**.
4. Press down arrow on the right side.
5. Press **Fax Ending Sound**.
6. Press **On**.
7. Press **OK**.

scanning

Scanning with your machine lets you turn pictures and text into digital files that can be stored on your computer.

This chapter includes:

- Basic scanning method
- Understanding the Scan screen
- Scanning originals and sending through email (Scan to Email)
- Scanning originals and sending to your computer (Scan to PC)
- Scanning originals and sending via SMB/FTP (Scan to Server)
- Setting authentication for authorized user

 The maximum resolution that can be achieved depends upon various factors, including computer speed, available disk space, memory, the size of the image being scanned, and bit depth settings. Thus, depending on your system and what you are scanning, you may not be able to scan at certain resolutions, especially using enhanced resolution.

BASIC SCANNING METHOD

You can scan the originals with your machine via an USB cable or the network.

- **Scan and Fax Manager 2:** You just walk to the machine with the originals and scan them from the control panel. Then, the scanned data will be stored in the connected computers **My Documents** folder. When you install all the softwares in the supplied CD, the Scan and Fax Manager 2 is also automatically installed on your computer. This feature can be used via the local connection or the network connection. (See "Using Scan and Fax Manager 2" on page 75.)
- **TWAIN:** TWAIN is the one of a preset imaging applications. Scanning an image launches the selected application, enabling you to control the scanning process. This feature can be used via the local connection or the network connection. (See "Scanning with TWAIN-enabled software" on page 78.)
- **SmarThru Office :** This program is the accompanying software for your machine. You can use this program to scan images or documents. This feature can be used via the local connection or the network connection. (See "Smarthru Office" on page 94.)
- **WIA:** WIA stands for Windows Images Acquisition. To use this feature, your computer must be connected directly with the machine via an USB cable. (See "Scanning using the WIA driver" on page 78.)
- **Email:** You can send the scanned image as an email attachment. (See "Scanning originals and sending through email (Scan to Email)" on page 72.)
- **FTP:** You can scan an image and upload it to an FTP server. (See "Scanning originals and sending via SMB/FTP (Scan to Server)" on page 74.)
- **SMB:** You can scan an image and send it to a shared folder on an SMB server. (See "Scanning originals and sending via SMB/FTP (Scan to Server)" on page 74.)

- Using Scan and Fax Manager 2
- Changing the scan feature settings
- Scanning with TWAIN-enabled software
- Scanning using the WIA driver
- Macintosh scanning
- Linux Scanning

UNDERSTANDING THE SCAN SCREEN

To use the scanning feature, press **Scan** on the main screen. If the screen displays another menu, press () to go to the main screen.



 If the message asking **Auth.ID**, **Password**, and **Realm Name**, it means the network administrator has set the authentication in SyncThru™ Web Service. (See "Using SyncThru™ Web Service" on page 93.)

Press **Scan to Email**, **Scan to PC** or **Scan to Server**.

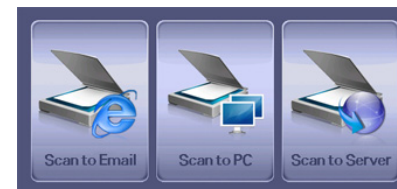

- **Scan to Email:** Scans and sends the scanned output to the destination by email. (See "Scanning originals and sending through email (Scan to Email)" on page 72.)
- **Scan to PC:** Scans and sends the scanned output to your PC. (See "Scanning originals and sending to your computer (Scan to PC)" on page 73.)
- **Scan to Server:** Scans and sends the scanned output to the destination with SMB and FTP. (See "Scanning originals and sending via SMB/FTP (Scan to Server)" on page 74.)

Basic tab

This section explains the **Basic** tab of **Scan to Email**, **Scan to PC** and **Scan to Server's** basic screen.

Scan to Email

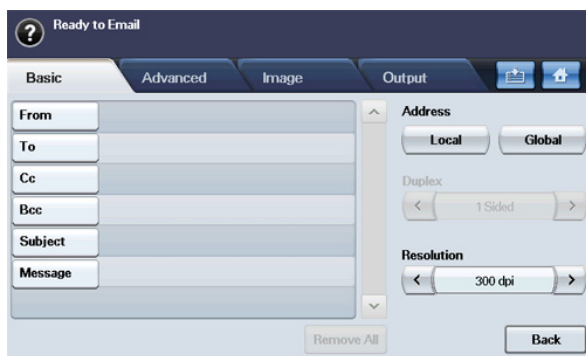

- **From:** Sender's email address.
- **To/Cc/Bcc:** Recipients' addresses. **Cc** (carbon copy) is for copies to an additional recipient and **Bcc** (blind carbon copy) is for the same as **Cc** but the recipient's name is not displayed.
- **Subject/Message:** Subject and message of the email.
- **Remove All:** Erases everything in the input area.
- **Address:** Inputs the recipient's address just by pressing stored addresses. You can store frequently used email addresses from your computer to the machine using the SyncThru™ Web Service. (See "Storing email addresses" on page 73.)
- **Duplex:** Selects whether the machine scans on one side of the paper (**1 Sided**), both sides of the paper (**2 Sided**), or both sides of paper but back is rotated 180 degrees (**2 Sided, Rotate Side 2**).
- **Resolution:** Selects the scanning resolution value.
- **Back:** Returns to the previous screen. If the network authentication is enabled, the log off confirmation message pops up and closes **Scan to Email**.

Scan to PC

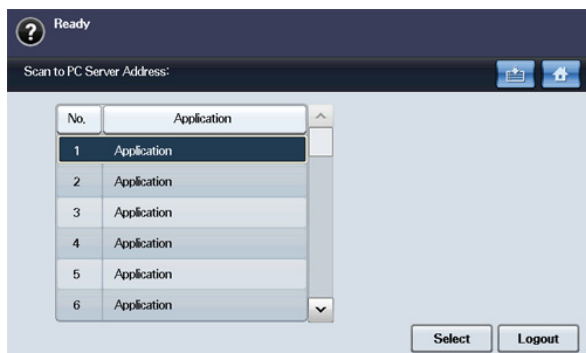

If the authentication for network appears, you have to select **ID** and type in **Password** to enter the **Scan to PC** screen.

- **No.:** Lists the number in order for application programs.
- **Application:** Shows the available application programs from your computer.
- **Select:** Moves to the application program you have selected.
- **Logout:** Logout from the **Scan to PC** screen.

Scan to Server



- **SMB:** Sends the scanned file to SMB.
- **FTP:** Sends the scanned file to FTP.
- **No.:** Index number, which you entered in SyncThru™ Web Service. (See "Scanning originals and sending via SMB/FTP (Scan to Server)" on page 74.)
- **Server:** Alias name, which you entered in "Scanning originals and sending via SMB/FTP (Scan to Server)" on page 74.) SyncThru™ Web Service.
- **Duplex:** Selects whether the machine scans on one side of the paper (**1 Sided**), both sides of the paper (**2 Sided**), or both sides of paper but back is rotated 180 degrees (**2 Sided, Rotate Side 2**).
- **Resolution:** Selects the scanning resolution value.
- **Back:** Returns to the previous screen.

Advanced tab



- **Original Size:** Selects the size of originals.
- **Back:** Returns to the previous screen.

Image tab

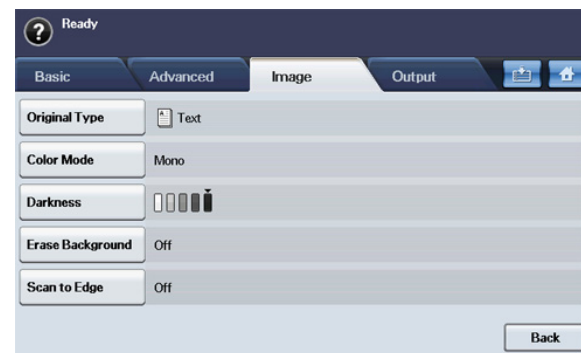

- **Original Type:** Selects whether the original is text or photo. (See "Original Type" on page 77.)
- **Color Mode:** Adjusts the color options of the scan output. If the original is color and you want to scan in color, press **Color Mode**. (See "Color Mode" on page 77.)
- **Darkness:** Adjusts the degree of darkness of the scan output. Use left/right arrow to adjust the values. (See "Darkness" on page 77.)
- **Erase Background:** Erases backgrounds like paper patterns. (See "Erase Background" on page 77.)
- **Scan to Edge:** Scans originals from edge-to-edge. (See "Scan to Edge" on page 77.)
- **Back:** Returns to the previous screen.

Output tab



- **Quality:** Adjusts the display quality of the scan output. (See "Quality" on page 77.)
- **Scan Preset:** Automatically changes some scan options, such as file format, resolution, and more. You can adjust options to fit each specific purpose. (See "Scan Preset" on page 78.)
- **File Format:** Selects the file format of the scan output. (See "File Format" on page 77.)
- **Back:** Returns to the previous screen.

SCANNING ORIGINALS AND SENDING THROUGH EMAIL (SCAN TO EMAIL)

You can scan the originals and email the scanned image to several destinations from the machine by email.

Setting up an email account

To scan and send an image as an email attachment, you need to set up network parameters using SyncThru™ Web Service.

1. Turn your networked computer on and open the web browser.
2. Enter your machine's IP address as the URL in a browser.
3. Click **Machine Settings** and **E-mail Setup**.
4. Select **IP Address** or **Host Name**.
5. Enter the IP address in dotted decimal notation or as a host name.
6. Enter the server port number, from 1 to 65535. The default port number is 25.
7. Check the box next to **SMTP Requires Authentication** to require authentication.
8. Enter the SMTP server login name and password.
9. Click **Apply**.

 If the authentication method of SMTP server is POP3beforeSMTP, put

a check mark of **SMTP Requires POP3 Before SMTP Authentication**.

- a) Enter the IP address in dotted decimal notation or as a host name.
- b) Enter the server port number, from 1 to 65535. The default port number is 25.

Sending a scanned image to several destinations as an email attachment

1. Load originals face up into the document feeder, or place a single original face down on the scanner glass. (See "Loading originals" on page 36.)

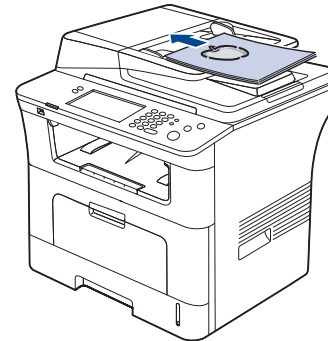

2. Press **Scan** from the main screen.



If the authentication message shows, enter **Auth. ID**, **Password** and **Realm Name**. This message shows only when the network administrator has set the authentication in SyncThru™ Web Service. (See "Setting authentication for authorized user" on page 74.)

3. Press **Scan to Email**.

4. Set the scan features in the **Advanced**, **Image**, or **Output** tabs. (See "Changing the scan feature settings" on page 76.)

5. Press the **Basic** tab to enter the email address.

- **From:** Touch **From**. The keyboard pops up on the screen. Use the pop up keyboard to enter your email addresses. Or you can use **Local** and **Global** to enter the addresses easily. (See "Global" on page 73.)
- **To/Cc/Bcc:** Enter recipient's email address manually with the pop up keyboard, or by pressing **Local** or **Global**. **Local** or **Global** addresses are pre-loaded address lists from your computer or the LDAP server which is configured at Web UI. (See "Global" on page 73.)
- **Subject:** Title of email.
- **Message:** The contents of the email. The maximum size is 1KB.



To delete previously entered contents, press **Remove All**.

6. Set the scan quality by **Duplex** and **Resolution**.

- **Duplex:** Sets this option for originals that are printed either on one side only, or on both sides.
- **Resolution:** Sets the scanning resolution by pressing left/right arrows.

7. Press the **Start** button to scan and send the file.



While the machine is sending an email, you cannot use the machine to copy or to send a fax.

Storing email addresses

There are two kinds of email addresses - **Local** on your machine's memory and **Global** on the LDAP server - which differ depending on where they are stored. **Local** means email addresses are stored in the machine's memory, and **Global** means email addresses are stored in a specified (LDAP) server. Through the SyncThru™ Web Service, you can easily enter and store email addresses from your computer.

Storing on your local machine

This method means that you store email addresses on your machine's memory. You can add addresses, as well as group them in particular categories.

Individual

1. Turn your networked computer on and open the web browser.
2. Enter your machine's IP address as the URL in a browser.
3. Click **Go** to access the SyncThru™ Web Service.
4. Click **Machine Settings > E-mail Setup > Individual Address Book**. The screen shows **Individual Address Book** on the right side of the screen.
5. Click **Add**.
6. When the **Add E-Mail** screen appears, select the **Index** number, enter **User Name** and **E-mail Address**.
7. Click **Apply**.
8. To check if the emails are correctly stored and listed on your machine, press **Local** and select **Individual** using the left/right arrow.
9. Press the first alphabet of the address you are looking for.
Or press **Search** to type in the full email address and press **OK**.
When the search is completed, screen displays the search results.

Group

1. Access to the SyncThru™ Web Service from your computer.
2. Make sure you have configured **Individual Address Book**.
3. Click **Machine Settings > E-mail Setup > Group Address Book**. Then the screen shows **Group Address Book** on the right side.
4. Click **Add**.
5. Select the **Group** number and enter **Group Name**.
6. Select email addresses by clicking the check boxes.
7. Click **Apply**.
8. To check if the emails are correctly stored and listed on your machine, press **Local** and select **Group** using the left/right arrow.
9. Press the first alphabet of the address you are looking for.
Or press **Search** to type in the full email address and press **OK**.
When the search is completed, screen displays the search results.

Global

Email addresses stored in **Global** in your machine are processed by the LDAP server.

1. Turn your networked computer on and open the web browser.
2. Enter your machine's IP address as the URL in a browser.
3. Click **Go** to access the SyncThru™ Web Service.
4. Click **Machine Settings > LDAP Server Setup**. Then the **LDAP Server** screen shows on the right side.
5. Select **IP Address** or **Host Name** and enter **LDAP server and Port**.
6. Enter optional information.
7. Click **Apply**.



The LDAP server administrator must store the email address data.

The method of storing varies depending on the server and the operating systems.

Entering email addresses by the address book

Once you have stored the frequently used addresses into the address book, you can enter email addresses singly, as follows:

1. Press **Local** or **Global** from the **Basic** tab of **Scan to Email**.
2. Press the first alphabet of the address you are looking for.
Or press **Search** to type in the full email address and press **OK**.
When the search is completed, screen displays the search results.
3. Press **From** and select the email address you want from the email list and press **Apply**.
Do the same to enter **To**, **Cc** or **Bcc**.
4. Press **OK**.

Entering email addresses by the keyboard

When you press the input field for **From**, **To**, **Cc**, or **Message**, the keyboard shows on the display screen.

The following procedure is an example of entering "abcdefg@abc.com".

1. Press **From** in the **Basic** tab of the **Scan to Email**.
2. Press a, b, c, d, e, f, g.
3. Press **@**.
4. Press a, b, c.
5. Press. and press c, o, m.



To enter contents in other fields, press left/right arrow on the upper left of the keyboard.

6. Press **OK** after entering all the contents.

SCANNING ORIGINALS AND SENDING TO YOUR COMPUTER (SCAN TO PC)

You can scan an image on the machine via the Scan and Fax Manager 2 program that is installed in your networked computer.

For USB connected machine

This is a basic scanning method for usb connected machine.

1. Make sure that the machine is connected to your computer and powered on.
2. Load originals face up into the document feeder, or place a single original face down on the scanner glass.
(See "Loading originals" on page 36.)
3. Press **Scan** from the main screen.
4. Press **Scan to PC**.
5. Make sure **Local PC** is shown.
If necessary, press the right arrow to toggle from **Network PC** to **Local PC**.
6. Press **Login**.
7. Select an application from the application list and press **Select**.
8. Press the **Start** button on the control panel to start scanning.
9. The original will be scanned and sent to your computer.

For network connected machine

Make sure the printer driver is installed on your computer using the software CD, since the printer driver includes the scan program. (See "Installing network connected machine's driver" on page 31.)

1. Make sure that your machine and the computer are connected to a network and Scan and Fax Manager 2 is installed on the computer.
2. Load originals face up into the document feeder, or place a single original face down on the scanner glass.
3. Press **Scan** from the main screen.



If the authentication message shows, enter **Auth. ID, Password** and **Realm Name**. This message shows only when the network administrator has set the authentication in SyncThru™ Web Service. (See "Setting authentication for authorized user" on page 74.)

4. Press **Scan to PC**.
5. Make sure **Network PC** is shown.
If necessary, press the right arrow to toggle from **Local PC** to **Network PC**.
6. Select **ID** and enter **Password**, which you have set from the Scan and Fax Manager 2.
7. Press **Login**.
8. Select one from the application list and press **Select**.
9. Select the scanning setting, such as the resolution or original size.
10. Press **Start** on the control panel to start scanning.
11. The original will be scanned and sent to your computer.



You can change the scanner properties of your machine and the scan settings from the Scan and Fax Manager 2 window. Click **Properties** and set the options in each tab. (See "Using Scan and Fax Manager 2" on page 75.)

SCANNING ORIGINALS AND SENDING VIA SMB/FTP (SCAN TO SERVER)

You can scan an image and send it to a total of five destinations via the SMB or FTP.

Setting up an FTP server

To use an FTP server, you need to set up parameters to access the FTP servers using SyncThru™ Web Service.



1. Turn your networked computer on and open the web browser.
2. Enter your machine's IP address as the URL in a browser.
3. Click **Go** to access the SyncThru™ Web Service.
4. Click **Machine Settings > FTP Setup > Server List**.
5. Click **Add**.
6. Select the **Index** number, from 1 to 20.
7. Enter a name in **Alias for the Setup**. This name will be displayed on your machine.
8. Select **IP Address** or **Host Name**.
9. Enter the server address in dotted decimal notation or a host name.
10. Enter the server port number, from 1 to 65535.
The default port number is 21.
11. Check the box next to **Anonymous** if you want the FTP server to permit access to unauthorized people.
This box is unchecked by default.
12. Enter the **Login Name** and **Login Password**.
13. Enter the **Scan File Folder** for saving the scanned image.
Example: **C://Documentenets and settings/user/FTP server**
14. Click **Apply**.

Setting up an SMB server

To use an SMB server, you need to set up parameters for access to SMB servers using SyncThru™ Web Service.

1. Turn your networked computer on and open the web browser.
2. Enter your machine's IP address as the URL in a browser.
3. Click **Go** to access the SyncThru™ Web Service.
4. Click **Machine Settings > SMB Setup > Server List**.
5. Click **Add**.
6. Select the **Index** number, from 1 to 20.
7. Enter a name in **Alias for the Setup**. This name will be displayed on your machine.
8. Select **IP Address** or **Host Name**.
9. Enter the server address in dotted decimal notation or a host name.
10. Enter the server port number, from 1 to 65535.
The default port number is 139.
11. Enter the **Share name** of the server.
12. Check the box next to **Anonymous** if you want to permit unauthorized persons to access the SMB server.
This box is unchecked by default.
13. Enter the **User Name** and **User Password**.
14. Enter the **User Domain**.
15. Enter the **Scan File Folder** for storing the scanned image.
Example: **C://Documentenets and settings/user/FTP server**
16. Click **Apply**.

Scanning and sending to SMB/FTP server

1. Press **Scan** from the main screen.
 If the authentication message shows, enter **Auth. ID, Password** and **Realm Name**. This message shows only when the network administrator has set the authentication in SyncThru™ Web Service. (See "Setting authentication for authorized user" on page 74.)
2. Press **Scan to Server**.
3. Load originals face up into the document feeder, or place a single original face down on the scanner glass.
4. Adjust the document settings in the **Image** tab.
5. Select **Duplex** and **Resolution** in the **Basic** tab.
6. Select the destination SMB server from the server list.
 You can select up to five destinations using both of SMB or FTP servers.
7. Press **Start** on the control panel.
The machine begins scanning and then sends the scanned image to the specified server.

SETTING AUTHENTICATION FOR AUTHORIZED USER

If you have connected your machine to a network and set up the network parameters correctly, you can scan and send images over the network.

To send a scanned image through email or via network server safely, you must register account information of authorized users to your local machine or to the network server using SyncThru™ Web Service.

- If user authentication has been activated, only authorized local users or on the server (SMB, LDAP, Kerberos) can send scanned data to the

network (email, FTP, SMB).

- For network scanning using the authentication feature, you must register the network or local authentication configuration using the SyncThru™ Web Service.
- User authentication has 3 options: **No Authentication** (Default), **Require Network Authentication**, and **Require Local Authentication**.

Registering local authorized users

1. Turn your networked computer on and open the web browser.
2. Enter your machine's IP address as the URL in a browser.
3. Click **Go** to access the SyncThru™ Web Service.
4. Click **Machine Settings > User Authentication**.
5. Select **Require Local Authentication** in the **Setup** section.

 If you have not set **Default[From:] Address** in **SMTP Client Setup**, the notifying pop-up window appears. Click **OK** to browse the Web page where you can set the default email address.

6. Click **Apply**.
7. Click **OK** in the modifying confirmation pop-up window.
8. Select **Local Authentication** in the left pane.
9. Click **Add**.
10. Select an index number corresponding to the location for storing the entry, from 1 to 50.
11. Enter your name, auth ID, password, e-mail address and phone number.
You need to enter the registered user ID and password in the machine when you start scanning to email from the control panel.
12. Click **Apply**.

Register network authorized users

1. Turn your networked computer on and open the web browser.
2. Enter your machine's IP address as the URL in a browser.
3. Click **Go** to access the SyncThru™ Web Service.
4. Click **Machine Settings > User Authentication**.
5. Select **Require Network Authentication** in the **Setup** section.

 If you have not set **Default[From:] Address** in **SMTP Client Setup**, the notifying popup window appears. Click **OK** to browse the web page where you can set the default email address.

6. Click **Apply**.
7. Click **OK** in the modifying confirmation popup window.
8. Select the **Authentication Type** that you prefer.
Configure the values for each feature, as follows:

Kerberos

1. Select **Kerberos**.
2. Enter the **Default Realm** used for **Kerberos** login.
3. Select **IP Address** or **Host Name**.
4. Enter the IP address in dotted decimal notation or as a host name.
5. Enter the server port number, from 1 to 65535.
The default port number is 88.
6. You can add a backup domain as a previous step.
7. Click **Apply**.

SMB

1. Select **SMB**.
2. Enter the domain that is used for **SMB** login.
3. Select **IP Address** or **Host Name**.

4. Enter the IP address in dotted decimal notation or as a host name.
5. Enter the server port number, from 1 to 65535.
The default port number is 139.
6. User can add a backup domain as in the previous step.
7. Click **Apply**.

 User can add up to 6 optional domains.

LDAP

1. Select **LDAP**.
2. Click **Apply**.
3. Click **OK** in the modifying confirmation pop-up window.
4. Click **LDAP Server Setup** in the left pane.
5. Select **IP Address** or **Host Name**.
6. Enter the IP address in dotted decimal notation or as a host name.
7. Enter the server port number, from 1 to 65535.
The default port number is 389.
8. Enter **Search Root Directory**, the top search level of the LDAP directory tree.
9. Select **Authentication** method. Two options for LDAP server login.
 - **Anonymous**: This is used to bind with null password and login ID (Password and login ID are grayed out in SWS).
 - **Simple**: This is used to bind with the login ID and password in SWS.
10. Check the box next to **Append Root to Base DN**.
11. Select **Match User's Login ID to the following LDAP attribute** (options are CN, UID, or UserPrincipalName).
12. Enter your login name, password, maximum number of search results and search timeout.

 **LDAP Referral**: LDAP client will search referral server if the LDAP server has no data to reply to query and if the LDAP server has a referral server.

13. Select **Search Name Order** that you desire.
14. Check the box next to **"From:" Field Security Options**.

 This option is only provided if you have selected the Network authentication option in the user authentication setting. You may check this option if you want to search for information in a default email address group.

15. Click **Apply**.

USING SCAN AND FAX MANAGER 2

If you have installed the printer driver, Scan and Fax Manager 2 program has installed too. Start Scan and Fax Manager 2 program to find out about this program information and the installed scan driver's condition. Through this program, you can change scan settings and add or delete the folders where scanned documents are saved in your computer.

 Scan and Fax Manager 2 program can only be used in the Window and Macintosh system. If you use the Macintosh, See "Setting scan information in Scan and Fax Manager" on page 79.

1. From the **Start** menu, click **Samsung Printers > Scan and Fax Manager 2**.

 You can open Scan and Fax Manager 2 by right clicking the Smart Panel icon in the Windows task bar and selecting Scan and Fax Manager 2.

2. Select the appropriate machine from the Scan and Fax Manager 2 window.
3. Press **Properties**.
4. The **Set Scan Button** tab allows you to change the saving destination and scan settings, add or delete application program, and format files.
5. When setting is done, press **OK**.

Set Scan Button tab

Scan Destination

- **Available Destination List:** Shows the list of applications currently linked to scanned images in the PC's registry. Select the program you want to use and click the right arrow and add to **Front Panel Destination List**.
- **Front Panel Destination List:** Shows the list of applications to open scanned image.
- **Add Application:** Allows you to add application you want to use to **Available Destination List**.
- **Remove Application:** Allows you to remove an item added by the user in the **Available Destination List**.
- **File Format:** Allows you to select the form of scanned data to be saved. You can choose among **BMP**, **JPEG**, **PDF**, and **TIFF**.

Scan Property

- **Computer ID:** Shows the ID of your computer.
- **Save Location:** Allows you to choose the location of the default saving folder.
- **Resolution:** Allows you to choose the scan resolution.
- **Scan Color:** Allows you to choose the scan color.
- **Scan Size:** Allows you to choose the scan size.
- **ADF Duplex:** Automatically scans both sides. If your model does not support this option, it will be grayed out.
- **Default:** Allows you to go back to default options.

Scan Assistant

When you press **Quick Scan** in Scan and Fax Manager 2, the **Scan Assistant** window appears. **Scan Assistant** allows you to adjust scan settings and start the scanning process.

In the **Basic** mode, **Scan settings** and **Preferences** are available only. If you want to use more settings, press **Advanced**.

 Click the **Help** button from the lower-left corner of the window and click on any option you want to know about. Then a pop up window appears with information about that option's feature which is provided from the **Scan Assistant**.

- **Favorites:** Allows you to save the current preferences settings for future use. When you save **Favorites**, all current scan settings are saved. To use a saved setting, select it from the **Favorites** drop down list. The machine is now set to scan according to the setting you selected. To delete saved setting, select it from the **Favorites** drop down list and click **Delete**. To set a favorite as startup, select the favorite you want to set as startup, then click the **Set as default** button.
- **Scan settings:** The following scan options are available.
 - **Image Type:** Allows you to choose the proper color settings for image scanning.
 - **Resolution:** Allows you to choose the image resolution.
 - **Document Size:** Allows you to choose the proper size of the scanned image.
 - **Document Source:** Allows you to choose the device you want to

scan with.

- **Prompt for additional pages:** If this check box is checked, you can scan pages continuously. This option is useful when you scan multi-page documents and/or when **Document Source** is set to **Flatbed** (scanner glass). In this case a sequence of scanned images is processed as a single document.
- **Pages to Scan:** Allows you to specify how many pages are to be scanned. This option is available when **Document Source** is set to **ADF Simplex**, **ADF Duplex - Short Edge**, and **ADF Duplex - Long Edge**.
- **Preference:** The following scan options are available.
 - **Auto crop image after preview:** If this option is checked, the scanning area will be automatically adjusted to the image size.
 - **Preview on program start:** If this option is checked, the scanning area will be selected automatically as shown in the preview.
 - **Blank page detection:** This operation automatically detects whether the scanned image is blank or not.
 - **Delete page:** Blank pages will be deleted at the end of the scanning process.
 - **Separate files:** Blank page will work as a scan job separator. That is, when multiple pages are scanned at once a blank page will divide scanned image sequence into parts. Each part will be treated as a separate document (group).
- **Advanced:** In the **Advanced** mode, additional options such as **Image Adjustment**, **Image Enhancement**, and **Additional Settings** are available.
 - **Image Adjustment:** Allows you to perform some transformations of the scanned image. These transformations include automatic adjustment of image size, straightening and rotation.
 - **Image Enhancement:** Allows you to remove various defects of the image and improve its quality.
 - **Additional settings:** Allows special processing of scanned images. These transformations include stitching several partial image scans into a single image, processing of scanned books and watermark stamping.

CHANGING THE SCAN FEATURE SETTINGS

This section explains how to adjust the document settings for each scan job, such as resolution, duplex, original size, type, color mode, darkness, and more. The settings you change will be maintained for a certain time, but after that period, the options will be reset to default values.

Duplex

This feature especially applies when the original documents to be scanned are two sided. You can select whether the machine scans only one side or both sides of the paper.

Press **Scan > Scan to Email** (or **Scan to PC** or **Scan to Server**) > the **Basic** tab > **Duplex**. Use left/right arrows to toggle the values.

- **1 Sided:** For originals that are printed on one side only.
- **2 Sided:** For originals that are printed on both sides.
- **2 Sided, Rotate Side 2:** For originals that are printed on both sides, but the back is rotated 180 degrees.

 To use **2 Sided** and **2 Sided, Rotate Side 2**, load the originals on the document feeder. If the machine cannot detect the original on the document feeder, it automatically changes the option to **1 Sided**.

Resolution

You can adjust document resolution.

Press **Scan > Scan to Email** (or **Scan to PC** or **Scan to Server**) > the **Basic** tab > **Resolution**. Use left/right arrows to toggle the values. The higher value you select, clearer the result. But the scanning time may take longer.

100 dpi, 200 dpi and 300 dpi resolution are available only when **Color Mode** is set to **Color** or **Gray**.

FEATURE	RESOLUTION (DPI)	FILE FORMAT
Scan to Email	100, 200, 300, 400, 600	PDF, Single-Page TIFF, Multi-Page TIFF, JPEG
Scan to PC	100, 200, 300, 400, 600	PDF, TIFF, JPEG
Scan to Server	100, 200, 300, 400, 600	PDF, Single-Page TIFF, Multi-Page TIFF, JPEG

Original Size

You can specify the scanning area on the originals by selecting the pre-defined size, putting in the margin value or **Auto**. If you set this option to **Auto**, the machine senses and determines the size of the original.

From the main screen, press **Scan > Scan to Email** (or **Scan to PC** or **Scan to Server**) > the **Advanced** tab > **Original Size**. Use up/down arrows to go to the next screen. Select the appropriate option and press **OK**.

Original Type

You can set the original document type in order to enhance the quality of a document being scanned.

Press **Scan > Scan to Email** (or **Scan to PC** or **Scan to Server**) > the **Image** tab > **Original Type**. Select the appropriate option and press **OK**.

- **Text**: For originals that have text or line art.
- **Text/Photo**: For originals that have both text and photographs together.
- **Photo**: For originals that are continuous tone photographs.

Color Mode

Use this option to scan the original in **Mono**, **Gray** or **Color Mode**.

Press **Scan > Scan to Email** (or **Scan to PC** or **Scan to Server**) > the **Image** tab > **Color**. Select the appropriate option and press **OK**.

- **Color**: Displays an image in color. 24 bits per pixel.
- **Gray**: Displays an image in gray. 8 bits per pixel.



- **Mono**: Displays an image in black and white. 1 bit per pixel.



-  The file format **JPEG** cannot be selected in the **File Format** option, if **Mono** has been selected for **Color Mode**.

Erase Background

You can lighten, reduce or delete the dark background from scanning colored paper or newspaper originals.

Press **Scan > Scan to Email** (or **Scan to PC** or **Scan to Server**) > the **Image** tab > **Erase Background**. Select **On** and press **OK**.

- **Off**: Sets this option off.
- **Auto**: Automatically adjusts background brightness.
- **Enhance**: Darkens the background. Use left/right arrows to toggle the values.
- **Erase**: Lightens the background. Use left/right arrows to toggle the values.

Darkness

You can select the degree of darkness of the scanned output. If your original document is light or faded, press the right arrow to make the output darker.

Press **Scan > Scan to Email** (or **Scan to PC** or **Scan to Server**) > the **Image** tab > **Darkness**. Press right arrow to enhance the darkness degree, then press **OK**.

Erase Background

You can lighten, reduce or delete the dark background from scanning colored paper or newspaper originals.

Press **Scan > Scan to Email** (or **Scan to PC** or **Scan to Server**) > the **Image** tab > **Erase Background**. Select the appropriate option and press **OK**.

- **Off**: Sets this option off.
- **Auto**: Automatically adjusts background brightness.
- **Enhance**: Darkens the background. Use left/right arrows to toggle the values. The higher the number is, the more vivid the background is.
- **Erase**: Lightens the background. Use left/right arrows to toggle the values. The higher the number is, the lighter the background is.

Scan to Edge

You can set the machine to scan full size of a page as it is. Usually, the machine scans a page except edges, which means the margin, especially when you do the copy job with certain sized paper in the tray. But if you scan and sent it right away via the network, as the file, the machine does not need to exclude the edges from the originals.

Press **Scan > Scan to Email** (or **Scan to PC** or **Scan to Server**) > the **Image** tab > **Scan to Edge**. Select **On** and press **OK**.

Quality

You can use this option to produce a high quality document. The higher the quality you select, the larger the file size.

Press **Scan > Scan to Email** (or **Scan to PC** or **Scan to Server**) > the **Output** tab > **Quality**.

-  When you set **Color Mode** to **Mono**, the **Quality** option is grayed out.

File Format

You can select the file format before you proceed with the scanning job.

Press **Scan > Scan to Email** (or **Scan to PC** or **Scan to Server**) > the **Output** tab > **File Format**.

- **PDF**: Scans originals in PDF format.
- **Single-Page TIFF**: Scans originals in TIFF (Tagged Image File Format), but several originals are scanned as one file.
- **Multi-Page TIFF**: Scans the originals in TIFF (Tagged Image File Format), and several originals are scanned as several file.

- **JPEG:** Scans original in JPEG format.
- **BMP:** Scans original in BMP format.

 The file format **JPEG** cannot be selected in the **File Format** option, if **Mono** has been selected for **Color Mode**.

Scan Preset

This feature allows you to use optimized settings for your specific scan job. Press **Scan > Scan to Email** (or **Scan to PC** or **Scan to Server**) > the **Output** tab > **Scan Preset**.

- **Sharing and Printing:** Produces a small-sized file for normal quality documents.
- **High Quality Printing:** Produces a high quality output with the largest file size.
- **Archival Record:** For the electronic file which is of the smallest file size of the output.
- **OCR:** Produces scanned output for OCR software. You can expect the highest quality images.
- **Simple Scan:** Used for a simple document with text only. The file size of output is small.
- **Custom:** Applies the current scan settings that you have chosen.

SCANNING WITH TWAIN-ENABLED SOFTWARE

If you want to scan documents using other softwares, you will need to use TWAIN-compliant software, such as Adobe Photoshop.

Follow the steps below to scan with TWAIN-compliant software:

1. Make sure that the machine is connected to your computer and powered on.
2. Load originals face up into the document feeder, or place a single original face down on the scanner glass.
(See "Loading originals" on page 36.)
3. Open an application, such as Adobe Photoshop.
4. Open the TWAIN window and set the scan options.
5. Scan and save your scanned image.

SCANNING USING THE WIA DRIVER

Your machine also supports the Windows Image Acquisition (WIA) driver for scanning images. WIA is one of the standard components provided by Microsoft Windows XP and works with digital cameras and scanners. Unlike the TWAIN driver, the WIA driver allows you to scan and easily adjust images without using additional software.

 The WIA driver works only on Windows XP/Vista with a USB port.

Windows XP

1. Make sure that the machine is connected to your computer and powered on.
2. Load originals face up into the document feeder, or place a single original face down on the scanner glass.
(See "Loading originals" on page 36.)
3. From the **Start** menu, select **Control Panel**, > **Scanners and Cameras**.
4. Double click your scanner driver icon. The **Scanner and Camera** Wizard appears.
5. Click **Next**.
6. Set the option in **Choose scanning preferences** window and click **Preview** to see how your options affect the picture.

7. Click **Next**.
8. Enter a picture name, and select a file format and destination to save the picture.
9. Your picture has been successfully copied to your computer. Choose one of the options on screen.
10. Click **Next**.
11. Click **Finish**.

Windows Vista

1. Make sure that the machine is connected to your computer and powered on.
2. Load originals face up into the document feeder, or place a single original face down on the scanner glass.
(See "Loading originals" on page 36.)
3. From the **Start** menu select **Control Panel > Hardware and Sound > Scanners and Cameras**.
4. Double click **Scan a document or picture**. **Windows Fax and Scan** application appears.
 -  You can click on **View scanners and cameras** to view scanners,
 - If there is no **Scan a document or picture**, open the MS paint program and from the **File** click **From Scanner or Camera...**
5. Click **New Scan**. Scan driver appears.
6. Choose your scanning preferences and click **Preview** to see your preferences affect the picture.
7. Click **Scan**.

 If you want to cancel the scan job, press the **Cancel** button on the **Scanner and Camera Wizard**.

Windows 7

1. Make sure that the machine is connected to your computer and powered on.
2. Load originals face up into the document feeder, or place a single original face down on the scanner glass
(See "Loading originals" on page 36).
3. From the **Start** menu select **Control Panel > Hardware and Sound > Devices and Printers**.
4. Click right button of mouse on device driver icon in **Printers and Faxes > Start Scan**. **New Scan** application appears.
5. Choose your scanning preferences and click **Preview** to see your preferences affect the picture.
6. Click **Scan**.

MACINTOSH SCANNING

You can scan documents using **Image Capture** program. Macintosh OS offers **Image Capture** program.

Scanning with USB

1. Make sure that the machine is connected to your computer and powered on.
2. Load originals face up into the document feeder, or place a single original face down on the scanner glass.
(See "Loading originals" on page 36.)
3. Start **Applications** and click **Image Capture**.
 -  If **No Image Capture device connected** message appears,

disconnect the USB cable and reconnect it. If the problem continues, refer to the **Image Capture's** help.

4. Set the scan options on this program.
5. Scan and save your scanned image.

- For more information about using **Image Capture**, refer to the **Image Capture's** help.
- Use TWAIN-compliant softwares to apply more scan options.
- You can also scan using TWAIN-compliant software, such as Adobe Photoshop.
- If scanning does not operate in **Image Capture**, update Mac OS to the latest version. **Image Capture** operates properly in Mac OS X 10.3.9 or higher and Mac OS X 10.4.7 or higher.

Scanning with network

1. Make sure that the machine is connected to your computer and powered on.
2. Load originals face up into the document feeder , or place a single original face down on the scanner glass.
(See "Loading originals" on page 36.)
3. Start **Applications** and click **Image Capture**.
4. For Mac OS X 10.4 ~ 10.5
Click **Devices** and click **Browse Devices**.
For Mac OS X 10.6
Select your device below **SHARED**. Skip to step 7.
5. For Mac OS X 10.4:
Select your machine in Twain devices option. Make sure that **Use TWAIN software** checkbox is checked, and click **Connect**.
 - If a warning message appears, click **Change Port..** to select port.
 - If TWAIN UI appears, from the **Preference** tab, click **Change Port..** to select port.
 - Refer to Scan and Fax Manager for Change Port.. use. (See "Setting scan information in Scan and Fax Manager" on page 79.)

For Mac OS X 10.5:

Make sure that **Connected** checkbox is checked beside your machine in **Bonjour Devices**.

If you want to scan using TWAIN, refer to the Mac OS X10.4 steps above.

6. Set the scan options on this program.
7. Scan and save your scanned image.

- For more information about using **Image Capture**, refer to the **Image Capture's** help.
- Use TWAIN-compliant softwares to apply more scan options.
- You can also scan using TWAIN-compliant softwares, such as Adobe Photoshop.
- If scanning does not operate in **Image Capture**, update Mac OS to the latest version. **Image Capture** operates properly in Mac OS X 10.3.9 or higher and Mac OS X 10.4.7 or higher.

Setting scan information in Scan and Fax Manager

To find out about Scan and Fax Manager program information, to check the installed scan driver's condition, to change scan settings. and to add or delete the folders where scanned documents to computer are saved in Scan and Fax Manager program, follow these instructions:

1. From the Smart Panel menu on Status bar, click Scan and Fax Manager.
2. Select the appropriate machine from the Scan and Fax Manager .
3. Press **Properties**.
4. Use **Set Scan Button** to change the file destination or scan settings, to add or delete application programs, and to format files. You can change the scanning machine by using **Change port**. (Local or Network)
5. When done, press **OK**.

LINUX SCANNING

You can scan a document using the Unified Driver Configurator window.

Scanning

1. Double-click the **Unified Driver Configurator** on your desktop.
2. Click the  button to switch to Scanners Configuration.
3. Select the scanner on the list.

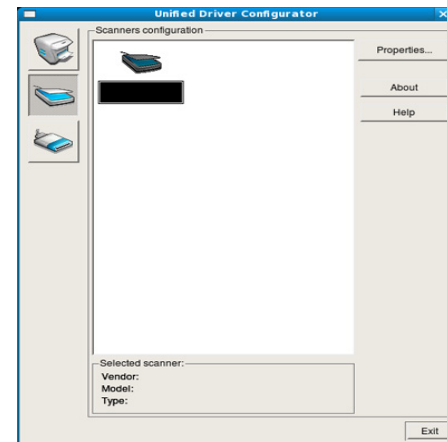

If you use only one machine device and it is connected to the computer and turned on, your scanner appears on the list and is automatically selected.

If you have two or more scanners connected to your computer, you can select any scanner to work at any time. For example, while acquisition is in progress on the first scanner, you may select the second scanner, set the device options and start the image acquisition simultaneously.

4. Click **Properties**.
5. Load originals face up into the document feeder, or place a single original face down on the scanner glass.
(See "Loading originals" on page 36.)
6. From the **Scanner Properties** window, click **Preview**.
The document is scanned and the image preview appears in the

Preview Pane.

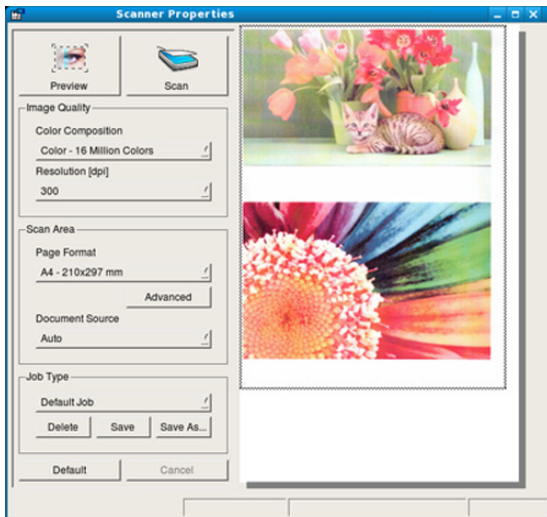

7. Drag the pointer to set the image area to be scanned in the **Preview Pane**.
8. Change the scan options in the **Image Quality** and **Scan Area** sections.
 - **Image Quality:** This option allows you to select the color composition and the scan resolution for the image.
 - **Scan Area:** This option allows you to select the page size. The **Advanced** button enables you to set the page size manually.If you want to use one of the preset scan option settings, select the option from the **Job Type** drop-down list. (See "Adding Job Type Settings" on page 80.)

Click **Default** to restore the default setting for the scan options.
9. When you have finished, click **Scan** to start scanning.

The status bar appears on the bottom left of the window to show you the progress of the scan. To cancel scanning, click **Cancel**.
10. The scanned image appears.

If you want to edit the scanned image, use the toolbar. (See "Using the Image Manager" on page 80.)
11. When you are finished, click **Save** on the toolbar.
12. Select the file directory where you want to save the image and enter the file name.
13. Click **Save**.

Adding Job Type Settings

You can save your scan option settings for later use.

To save a new Job Type setting:

1. Change the options from the Scanner Properties window.
2. Click **Save As**.
3. Enter the name for your setting.
4. Click **OK**.

Your setting is added to the **Saved Settings** drop-down list.

To save a Job Type setting for the next scan job:

1. Select the setting you want to use from the **Job Type** drop-down list.
2. The next time you open the **Scanner Properties** window, the saved setting is automatically selected for the scan job.

To delete a Job Type setting

1. Select the setting you want to delete from the **Job Type** drop-down list.
2. Click **Delete**.







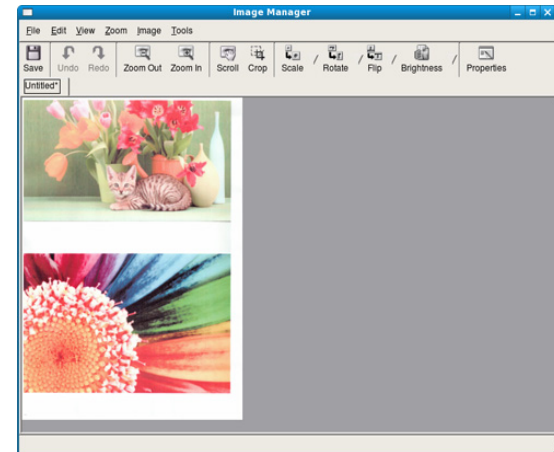





The setting is deleted from the list

Using the Image Manager

The Image Manager application provides you with menu commands and tools to edit your scanned image.



Use the following tools to edit the image:

TOOLS	NAME	FUNCTION
	Save	Saves the image.
	Undo	Cancels your last action.
	Redo	Restores the action you canceled.
	Scroll	Allows you to scroll through the image.
	Crop	Crops the selected image area.
	Zoom Out	Zooms the image out.
	Zoom In	Zooms the image in.
	Scale	Allows you to scale the image size; you can enter the size manually, or set the rate to scale proportionally, vertically, or horizontally.
	Rotate	Allows you to rotate the image; you can select the number of degrees from the drop-down list.
	Flip	Allows you to flip the image vertically or horizontally.
	Brightness	Allows you to adjust the brightness or contrast of the image, or to invert the image.
	Properties	Shows the properties of the image.

For further details about the Image Manager application, refer to the on screen help.

using usb memory device

This chapter explains how to use a USB memory device with your machine.

This chapter includes:

- About USB memory device
- Understanding the USB screen
- Scanning to an USB memory device

ABOUT USB MEMORY DEVICE

USB memory devices are available with a variety of memory capacities to give you more room for storing documents, presentations, music and videos, high resolution photographs, or whatever other files you want to store or move.

You can do the following on your machine using an USB memory device:

- Scan documents and save them on an USB memory device.
- Print data stored on an USB memory device.
- Format the USB memory device.

Your machine supports USB memory devices with FAT16/FAT32 and sector size of 512 bytes.

Check your USB memory device's file system from your dealer.

You must use only an authorized USB memory device with an A plug type connector.

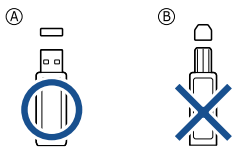

Use only an USB memory device with metal-shielded connector.

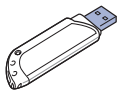

- Changing the scan feature settings
- Printing from a USB memory device

Insert a USB memory device into the USB memory port on your machine.

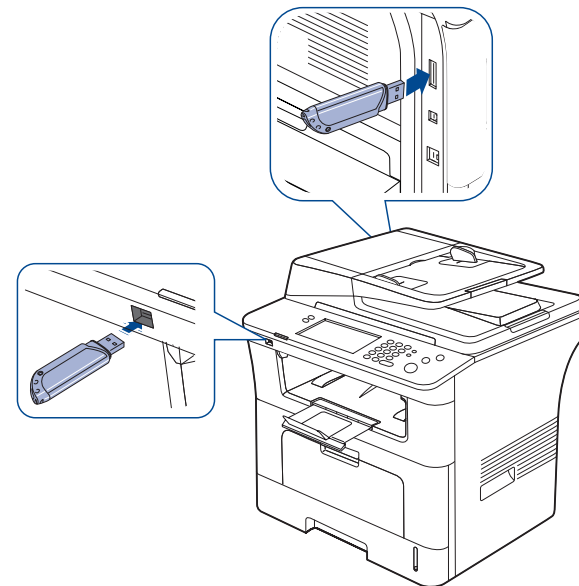

- Do not remove the USB memory device while it is in use. The machine warranty does not cover damage caused by user's misuse.
- If your USB memory device has certain features, such as security settings and password settings, your machine may not automatically detect it. For details about these features, see USB memory device's User's Guide.

UNDERSTANDING THE USB SCREEN

To use the USB feature, press **USB** on the main screen. If the screen displays another menu, press () to go to the main screen.



 When an USB memory is inserted into the USB memory port on your machine, **USB** icon shows on the screen.

From the USB screen, press **USB Format** or, **USB Print** or, **Scan to USB**.

- **USB Format:** You can delete files stored on an USB memory device one by one or all at once by reformatting the device.
- **USB Print:** You can directly print files stored on an USB memory device. You can print TIFF, BMP, JPEG, PDF, and PRN files. (See "Printing from a USB memory device" on page 84.)
- **Scan to USB:** You can scan a data and send directly to USB memory device. You can specify image size, file format, or color mode for each scanning to USB job. (See "Scanning to an USB memory device" on page 83.)

SCANNING TO AN USB MEMORY DEVICE

You can scan a document and save the scanned image onto an USB memory device. When you scan a document, the machine uses the default settings such as the resolution. You can also customize your own scan setting. (See "Changing the scan feature settings" on page 83.)

1. Insert a USB memory device into the USB memory port on your machine.
2. Place the originals face up in the document feeder. Or place a single original face down on the scanner glass.
3. Press **USB** from the main screen.
4. Press **Scan to USB**.
5. Set the scan features in the **Advanced**, **Image**, or **Output** tabs. (See "Changing the scan feature settings" on page 83.)
6. Press **Start** on the control panel to begin scanning.
7. After scanning is complete, you can remove the USB memory device from the machine.

CHANGING THE SCAN FEATURE SETTINGS

This part explains how to adjust the document settings for each scan job, such as resolution, duplex, original size, original type, color mode, darkness, and more. The options you change will be maintained for a certain time, but after a period, the options will be reset to default values.

Duplex

This feature especially applies when the original documents to be scanned are two-sided. You can select whether to scan only one side of the paper or both sides of the paper.

Press **USB > Scan to USB > the Basic tab > Duplex**. Use left/right arrows to toggle the values.

- **1 Sided:** For originals that are printed on one side only.
- **2 Sided:** For originals that are printed on both sides.
- **2 Sided, Rotate Side 2:** For originals that are printed on both sides. But the back is rotated 180 degrees.

 To use **2 Sided** and **2 Sided, Rotate Side 2**, you have to load the originals on the document feeder. Because, if the machine can not detect the original on document feeder, it automatically changes the option to **1 Sided**.

Resolution

You can adjust document resolution.

Press **USB > Scan to USB > the Basic tab > Resolution**. Use left/right arrows to toggle the values. The higher value you select the clear result you get. But the scanning time may take longer.

Original Size

You can adjust document size.

Press **USB > Scan to USB > the Advanced tab > Original Size**. Select the appropriate option and press **OK**.

Original Type

You can set the original document type in order to enhance the quality of a document being scanned.

Press **USB > Scan to USB > the Image tab > Original Type**. Select the appropriate option and press **OK**.

- **Text:** Use for originals containing mostly text.
- **Text/Photo:** Use for originals with mixed text and photographs.
- **Photo:** Use when originals are photographs.

Color Mode

Use this option to scan the original in **Mono**, **Gray** or **Color Mode**.

Press **USB > Scan to USB > the Image tab > Color Mode**. Select the appropriate option and press **OK**.

- **Color:** Displays an image in color. 24 bits per pixel.
- **Gray:** Displays an image in gray. 8 bits per pixel.



- **Mono:** Displays an image in black and white. 1 bit per pixel.



 The file format **JPEG** cannot be selected in the **File Format** option, if **Mono** has been selected for **Color Mode**.

Darkness

You can select the degree of darkness of the scanned output. If your original document is light or faded, press the right arrow to make the output darker.

Press **USB > Scan to USB > the Image tab > Darkness**. Press right arrow to enhance the darkness degree then, press **OK**.

Erase Background

You can lighten, reduce or delete the dark background from scanning colored paper or newspaper originals.

Press **USB > Scan to USB > the Image tab > Erase Background**. Select the appropriate option and press **OK**.

- **Off:** Sets this option off.
- **Auto:** Automatically adjusts background brightness.
- **Enhance:** Darkens the background. Use left/right arrows to toggle the values. The higher the number is, the more vivid the background is.
- **Erase:** Lightens the background. Use left/right arrows to toggle the values. The higher the number is, the lighter the background is.

Scan to Edge

You can set the machine to scan full size of a page as it is. Usually, the machine scans a page except edges, which means the margin, especially when you do the copy job with certain sized paper in the tray. But if you scan and sent it right away via the network, as the file, the machine does not need to exclude the edges from the originals.

Press **USB > Scan to USB > the Image tab > Scan to Edge**. Select **On** and press **OK**.

Quality

You can use this option to produce a high quality document. Higher quality you select a larger file size you get.

Press **USB > Scan to USB > the Output tab > Quality**. Select the appropriate option and press **OK**.



When you set **Color Mode** to **Mono**, the **Quality** option is grayed out.

Scan Preset

This feature allows you to use optimized settings for your specific scan job.

Press **USB > Scan to USB > the Output tab > Scan Preset**. Select the appropriate option and press **OK**.

- **Sharing and Printing:** Produces a small-sized file for normal quality documents.
- **High Quality Printing:** Produces a high quality output with the largest file size.
- **Archival Record:** For the electronic file which is of the smallest file size of the output.
- **OCR:** Produces scanned output for OCR software. You can expect the highest quality images.
- **Simple Scan:** Used for a simple document with text only. The file size of output is small.
- **Custom:** Applies the current scan settings that you have chosen.

File Format

You can select the file format before you proceed with the scanning job.

Press **USB > Scan to USB > the Output tab > File Format**. Select the appropriate option and press **OK**.

- **PDF:** Scans originals in PDF format.
- **Single-Page TIFF:** Scans originals in TIFF (Tagged Image File Format), but several originals are scanned as one file.
- **Multi-Page TIFF:** Scans the originals in TIFF (Tagged Image File Format), and several originals are scanned as several file.
- **JPEG:** Scans original in JPEG format.
- **BMP:** Scans original in BMP format.



The file format **JPEG** cannot be selected in the **File Format** option, if **Mono** has been selected for **Color Mode**.

File Policy

You can choose the policy for generating file name before you proceed with the scan job through USB. If the USB memory already has the same name when you entered a new file name, you can rename or overwrite it.

Press **USB > Scan to USB > the Output tab > File Policy**. Select the appropriate option and press **OK**.

- **Rename:** If the USB memory already has the same name when you enter a new file name, the file will be saved as a different name which is automatically programmed.
- **Overwrite:** You can set the machine to delete previous job information on USB as you store new job information.

PRINTING FROM A USB MEMORY DEVICE

You can directly print files stored on a USB memory device. You can print TIFF, BMP, JPEG, and PRN files.

Direct Print option supported file types:

- **PRN:** Only files created by provided driver with your machine are compatible. PRN files can be created by selecting the **Print to file** check box when you print a document. The document will be saved as a PRN file, rather than printed on paper. Only PRN files created in this fashion can be printed directly from USB memory device. (See "Printing to a file (PRN)" on page 51.)
- **BMP:** BMP Uncompressed
- **TIFF:** TIFF 6.0 Baseline
- **JPEG:** JPEG Baseline
- **PDF:** PDF 1.4 and below

To print a document from a USB memory device:

1. Insert a USB memory device into the USB memory port on your machine.
Your machine automatically detects the device and reads data stored on it. (See "About USB memory device" on page 82.)
2. Press **USB** from the main screen.
3. Use up/down arrows until the file you want appears.
Select the file name.
If the file is in a folder, select the folder name.
Press **Select**.
4. Press **USB Print**.
5. Press the **Start** button on the control panel.

machine status and advanced feature

This chapter explains how to browse the current status of your machine, and the method of setting for the advanced machine setup. Read this chapter carefully in order to use your machine's diverse features.

This chapter includes:

- Machine Setup
- Browsing the machine's status
- General settings
- Copy Setup
- Fax Setup

MACHINE SETUP

1. Press **Machine Setup** on the control panel.
2. Select the appropriate item you want to use.

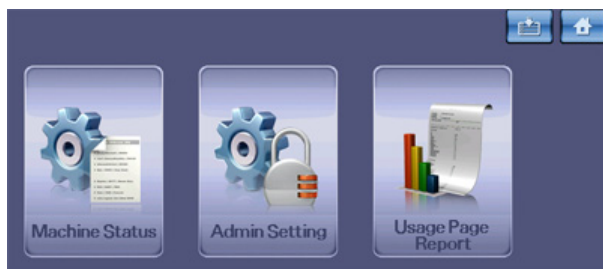

- **Machine Status:** Shows the current machine status.
- **Admin Setting:** Allows administrator to set up the machine. When you press **Admin Setting**, a login message pops up. Enter password and press **OK**. (Factory setting is 1111.)
- **Usage Page Report:** You can print the report on the amount of printouts depending on the paper size and type.

Machine Status screen

Press **Machine Setup** on the control panel, then press **Machine Status**.

- **Supplies Life tab:** Displays both the amount of machine supplies used and remaining. Use up/down arrows to switch screens.
- **Machine Info tab:** Displays detailed information about the machine, as well as some options to allow validating your machine.
- **Back:** Returns to the previous screen.

Admin Setting screen

Gives you access to detailed machine settings.

 When you press **Admin Setting**, a login message appears. If the administrator set the password, you have to enter the password every time you want to use **Admin Setting**. (See "Setting the authentication password" on page 33.)

- **General tab:** Sets the basic parameters of the machine, such as location, date, time, and more. (See "General settings" on page 85.)
- **Setup tab:** Sets the values for fax, network, and login. You can also enable the features listed on the screen.
- **Print/Report tab:** Prints configuration or font list and displays a report of machine features. (See "Printing a report" on page 89.)

- Network Setup
- Authentication
- Optional Service
- Printing a report
- Menu overview

- **Back:** Returns to the previous screen.

BROWSING THE MACHINE'S STATUS

You can browse the machine information and validate some features of the machine.

1. Press **Machine Setup** on the control panel.
2. Press **Machine Status** > the **Machine Info** tab.

OPTION	DESCRIPTION
Machine Details	This option shows the customer support information on the email address and the phone number you stored from Admin Setting . Also, you can check the machine's serial number, or the hardware and software information specification.
Print/Report	You can print various helpful and informative reports, such as System Report , Fax Report and Scan Report . (See "Printing a machine report" on page 98.)
Tray Status	The screen shows the trays installed on your machine and their current configurations.
Usage Counters	You can view the amount of each category that your machine has printed so far. Print this report. (See "Printing a report" on page 89.)

GENERAL SETTINGS

Before using the machine, set up the machine parameter, as follows:

1. Press **Machine Setup** on the control panel.
2. Press **Admin Setting**. When the login message pops up, enter password and press **OK**. (Factory setting is 1111.)
3. Press the **General** tab.

OPTION	DESCRIPTION
Device Info	The sub-options available are Service Center Registration and Contact Info . You may enter information on service center and purchasing point.
Date & Time	You can set the date and time. (See "Setting the date and time" on page 33.)
Default Settings	<ul style="list-style-type: none"> • Default Window: Set the first window that appears on the display screen after the machine wakes up from the Power Save mode. For example, if you select Fax as a default window, the first window will be the Basic tab of the Fax feature. If you want to show ID Copy as a default window, you need to enable this feature in Default Option. • Default Option: Changes all the default values for copying, faxing, emailing, scanning and paper at once. (See "Changing the default settings" on page 34.) • Home: Allows user to arrange each function in the display screen. <p> Depending on the optional kit installed or the category selected, the selectable options on the display screen may differ.</p>
Measurements	This option lets you change the unit of (mm or inch) and set the numeric separation (comma or period).
Timers	The machine cancels a printing job if data is not received in specific time. <ul style="list-style-type: none"> • System Timeout: The machine returns to the default value after waiting a certain length of time. You can set a time for maximum 10 minutes. • Held Job Timeout: The machine holds a job for a specific time period.
Language	Allows you to change the language that appears on the touch screen.
Power Saver	Reduce energy consumption by setting power saving features. (See "Using power saving feature" on page 34.)

OPTION	DESCRIPTION
Tray Management	Allows you to select the tray and paper for a printing job. Tray Confirmation Message activates the window asking whether you set the paper size and type for the tray that was just opened. <ul style="list-style-type: none"> • Auto Tray Switch: With this option On and both tray1 and tray2 are filled with letter size paper, the machine automatically prints from tray2 after tray1 is empty. • Auto Continue: When the paper is mismatched, meaning that tray1 has filled with the letter size paper, but the printing job needs A4 size paper, the machine will wait for 30 seconds for paper in tray1 with proper sized paper. After 30 seconds, the machine automatically starts printing with letter-sized paper.
Altitude Adjustment	Print quality is affected by atmospheric pressure. The atmospheric pressure is determined by the height of the machine above sea level. This feature lets you adjust the altitude in a height district. The higher the altitude, the higher the adjustment, the highest being High 1 . (See "Altitude adjustment" on page 33.)
Contention Management	This feature lets you to select the priority between copy jobs and print jobs. <ul style="list-style-type: none"> • Priority: Set the priority by numbering the job. The machine starts from the least to the highest number in order. • First In, First Out: The machine does an asked job in order.
Sound	You can adjust the noise level of the machine sound. Press Fault to adjust the machine's error sound. Select Conflict if you pressed the wrong option. Press Selection to have the machine make a sound whenever you press the selection from your touch screen.
Supplies Management	The machine notifies you when to reorder toner cartridge and resets the used fuser counter, bias transfer roller, feed roller and document feeder friction pad counter.
Machine Test	You can test the machine by using the Image Quality Test Patterns and Loopback Test .
On Demand Overwrite	You can set the machine to delete previous job information on HDD when you store new job information. To activate this feature, go to Admin Setting > the Setup tab > Optional Service . Set the On Demand Image Overwrite option to Enable . After activating this feature, you can overwrite an HDD by pressing Start in the display.

OPTION	DESCRIPTION
HDD Spooling	To spool documents in HDD for the network printing, select On .
Stored Job File Policy	You can choose the file policy for generating file name before proceeding with the job through the HDD. If the HDD memory already has the same name when you entered a new file name, you can either rename or overwrite it. <ul style="list-style-type: none"> • Rename: If your HDD memory already has the same name when you enter a new file name, the file will be saved as a different name that is automatically programmed. • Overwrite: You can set the machine to delete previous job information on HDD as you store new job information
Country	When you change the country, some of the values for fax and paper size will be changed automatically for the country specified.

COPY SETUP

For copy output, you can set up several options in advance.

1. Press **Machine Setup** on the control panel.
2. Press **Admin Setting**. When the login message pops up, enter password and press **OK**.
3. Press the **Setup** tab > **Copy Setup**.

OPTION	DESCRIPTION
Page Number	If you select option On , each copy will include the page number on the bottom of each page.
Time & Date	Set from the General tab, select this option On to print the date and time on each copy,
ID Stamp	This option is used to set words or a message to be printed on your copies. Set this option On ; an input screen will be displayed. Write your message using the pop up keyboard.

FAX SETUP

This machine offers you various options for setting up the fax system. You can change the default settings for your preferences and needs, as follows:

1. Press **Machine Setup** on the control panel.
2. Press **Admin Setting**. When the login message pops up, enter password and press **OK**.
3. Press the **Setup** tab > **Fax Setup**.

 The fax options are different from country to country depending on the International Communications Regulatory. If some of the fax options explained in the instructions have been grayed out, it means that the grayed-out function is not supported in your communication environment.

OPTION	DESCRIPTION
Machine ID & Fax No.	Enter the machine ID and fax number which will be printed at the top of each page. This option is usually pre-set for user.
Receive Start Code	This feature works best when you are using an extension telephone connected to the EXT socket at the back of your machine. You can receive a fax from with whom you are talking on the extension telephone, without going to the fax machine. (See "Receiving faxes manually using an extension telephone" on page 65.)
Error Correction Mode	It helps with poor line quality and ensures any faxes you send are properly transmitted to any other ECM-equipped fax machines. Sending a fax using ECM may take more time.
Fax Initial Setup	You can set Receive Mode for Telephone , Fax or Answering Machine/Fax , and Dial Mode at either Tone or Pulse . When you select Answering Machine/Fax , you can receive a fax while the line is being used by the answering machine. (See "Changing the receive modes" on page 65.) Contact your local telephone company for Dial Mode setting information.
Ring to Answer	You can specify the number of times the machine rings before answering an incoming call.
Receive Header	Use this option to automatically print the page number, date, and time of fax reception at the bottom of each page.
Secure Receive	You may need to prevent your received faxes from being accessed by unauthorized people. This feature restricts printing of received faxes when the machine is unattended. If you select this option to On , all incoming faxes go into memory. A four-digit Passcode is used when you want to print out received faxes in memory. (See "Receiving in secure receiving mode" on page 65.)
Received Fax Printing	Sets the printing method for the received fax. <ul style="list-style-type: none"> • Auto Reduction: When receiving a fax containing pages longer than the paper loaded in the tray, the machine can reduce the size of the original to fit the size of the paper. If this feature is set to Off, the machine cannot reduce the original to fit onto one page. The original will be divided and printed in actual size on two or more pages. For example, this option is set to Off and Discard Size to 10 mm, but the received data is longer than the currently set paper in the tray, the machine omits printing the data that would have been on the specified discard segment. • Duplex: Print the received fax on both sides of papers. • Stapled: If a machine is equipped with a staper feature, you can use this option a set of received fax to be stapled.

OPTION	DESCRIPTION
Redial	If recipient's fax machine is busy or not answering, the machine can automatically redial a remote fax machine. You can set the number of redial attempts and the interval between attempts. Selecting 0 for Redial Times means that the machine will not redial.
Speaker Volume	This controls the sound when a fax actually starts to transfer data. If this option is On , the machine emits sound from the beginning to the completion of a fax. With Comm , the machine emits sound only until the communication has succeeded. There is no sound with Off option.
Prefix Dial	This feature allows you to set a prefix of up to five digits. User may set this to access a PABX(example *9) or area code number (example 02).
Junk Fax Setup	The machine does not accept faxes sent from remote stations if their numbers are stored in the memory as junk fax numbers. You can enter a maximum of 10 junk fax numbers. Press Junk Fax Setup , select number and Edit . then, enter the last numbers (1~7 digit) of the fax number.
Ring Volume	This feature adjusts the ring volume. When you select Off , the machine does not ring.
Dial Tone Volume	When you press On Hook Dial to send a fax, you can hear a specific tone. To adjust the tone volume, use this feature. Value 1 is the lowest volume. Use left/right arrows to adjust the value.
Mailbox Setup	<ul style="list-style-type: none"> • Document Policy: You can set the document stored in Mailbox to delete or retain documents after completion. Select On for each option to delete, Off to retain the data. • Mail Configuration: You can create, edit, or delete Mailbox. Enter Mailbox ID, Mailbox Name, Mailbox Passcode by pressing options. (See "Using mailbox" on page 68.) <p> If you set the Notification option to On, you are notified when a fax is received in Mailbox. (See "Creating Mailbox" on page 68.)</p>
Output Tray	This feature lets you select the paper tray to use for receiving a fax.
Toll Save	Set the machine to send a fax in the toll save time for saving. (See "Sending a fax in toll save time" on page 68.)

OPTION	DESCRIPTION
Send Batch	If the fax number you have dialed is the same as the delay fax number, the machine asks whether you want to add the documents to the reserved delay fax. (See "Adding documents to a reserved delay fax job" on page 64.)
Fax Forward Settings	You can forward a sent or received fax to other destinations via fax or email. (See "Forwarding a fax to other destination" on page 68.)
Fax Ending Sound	This setting determines whether the end fax tone is on or off. When the fax receiving job is finished, machine will give an signal sound. (See "Setting up the fax ending tone" on page 69.)

NETWORK SETUP

You may set up the network with the machine's touch screen. Before doing that, you must have the relevant information concerning the type of network protocols and computer system you use. If you are not sure which setting to use, contact your network administrator to configure this machine to the network.

1. Press **Machine Setup** on the control panel.
2. Press **Admin Setting**. When the login message pops up, enter password and press **OK**.
3. Press the **Setup** tab > **Network Setup**.

OPTION	DESCRIPTION
TCP/IP Protocol	Select appropriate protocol and configure parameters to use the network environment.  There are lots of parameters to be set. Therefore, if you are not sure, leave as is, or consult the network administrator.
Ethernet Speed	Configure the network transmission speed.
Clear Setting	Reverts the network settings to the default values.

AUTHENTICATION

This feature lets you control and lock all outgoing data, or change the password.

1. Press **Machine Setup** on the control panel.
2. Press **Admin Setting**. When the login message pops up, then enter password and press **OK**.
3. Press the **Setup** tab > **Authentication**.

OPTION	SUB-OPTION	DESCRIPTION
Authentication Mode	Network Accounting	Enables authentication mode which can be used for job accounting plug-in in the SyncThru™ Web Admin Service .
	No Authentication Mode	It disables Authentication Mode .
Change Admin. Password		You can change the password for the Admin Setting authentication.

OPTIONAL SERVICE

When you want to add the optional features for this machine, you have to install the optional kit, and then, set the machine to enable, and activate those features. To enable those features, follow the steps below:

1. Press **Machine Setup** on the control panel.
2. Press **Admin Setting**. When the login message pops up, then enter password and press **OK**.
3. Press the **Setup** tab > **Optional Service**.

OPTION	DESCRIPTION
N/W Scan	If you are not using the network scan feature, select Disable , then the Scan icon on the display will be grayed out.
Analog Fax	If you are not using the fax feature, select Disable , then the fax icon on the display will be grayed out.
On Demand Image Overwrite	This feature is deleting all the information on HDD for security reasons. You cannot recover the information once it's been deleted. System administrator deletes all the information on HDD. From the General tab, select On Demand Overwrite > Enable .
Immediate Image Overwrite	This feature is deleting a specific job information on HDD for security reasons. After a job stored on the HDD is completed, it's information is automatically deleted. You cannot recover the information once it's been deleted. From the General tab select Immediate Image Overwrite > Enable .

PRINTING A REPORT

You can print a report on the machine's configuration or font list, etc.

1. Press **Machine Setup** on the control panel.
2. Press **Admin Setting**. When the login message pops up, then enter password and press **OK**.
3. Press the **Print/Report** tab.

OPTION	SUB-OPTION	DESCRIPTION	
Print		You can print Network Configuration, PS3 Font List, PCL Font List and Schedule Jobs Report. Schedule Jobs Report shows the job list in pending, in delayed faxing or the Mailbox list as well.	
	Accounting Reports	Supplies Information	You can print the amount of each category that your machine has printed so far.
		Network Auth. Log Report	It displays user login IDs and email.
		Usage Page Report	You can print a report on the number of printouts based on paper size and type.
		Accounting Report	You can print a report on the number of printouts for each login user.
Report	Configuration Report	You can print a report on the machine's overall configuration.	

OPTION	SUB-OPTION	DESCRIPTION
	Fax Report	<p>You can set to print the information of a fax reports.</p> <ul style="list-style-type: none"> • Multi Send Report: When you fax to several destinations, set this option to print a transmission report. Select On to print out a confirmation report every time you send a fax. Select On-Error to print out a report only when a transmission error occurs. • Fax Send Report Appearance: You can select whether the image on the confirmation report shows or not. • Fax Sent/Received Report: Select On to have the machine store all transmission logs and print out after every 50 logs. Select Off to have the machine store the log but not print out. • Fax Send Report: The machine prints the confirmation report after each fax job, only when you send a fax to one destination.
	E-mail Confirmation Report	<p>The report shows the job of scanning and sending it via Scan to Email.</p> <ul style="list-style-type: none"> • On: A report is printed whether a job is successfully completed or not. • Off: No report is printed. • On-Error: A report is printed only when an error occurs.
	Scan to Server Confirmation	<p>The report shows the job of scanning and sending it via SMB and FTP.</p> <ul style="list-style-type: none"> • On: A report is printed whether a job is successfully completed or not. • Off: No report is printed. • On-Error: A report is printed only when an error occurs.

 You can also print the machine's status information and browse status with SyncThru™ Web Service. Open the Web browser on your networked computer and type the IP address of your machine. When SyncThru™ Web Service opens, click **Information > Print information**.

MENU OVERVIEW

The control panel provides access to various menus to set up the machine or use the machine's functions. These menus can be accessed by pressing **Machine Setup**, **Job Status**, or touching menus on the display screen. Refer to the following table.

 Some menus may not appear in the display depending on options or models. If so, it is not applicable to your machine.

Main screen

The main screen is shown on the display screen on the control panel. Some menus are grayed out depending on your model.

ITEMS	OPTION
Copy	Basic Original Size Reduce/Enlarge Duplex Output Original Type Darkness Paper Supply Advanced ID Copy N-Up Poster Copy Clone Copy Book Copy Booklet Covers Transparencies Image Erase Edge Erase Background Margin Shift
Fax	Basic Address Duplex Resolution Advanced Original Size Delay Send Priority Send Polling Mailbox Image Original Type Darkness Erase Background Color Mode

ITEMS	OPTION
Scan	Scan to Email Basic Advanced Image Output Scan to PC Basic Advanced Image Output Scan to Server Basic Advanced Image Output
Stored Documents	Public Detail Edit Delete Delete All Print Secured Detail Edit Delete Print
USB	USB Format USB Print Scan to USB Basic Advanced Image Output

Machine Setup button

When you press the **Machine Setup** button on the control panel, the screen displays three menus. **Machine Status** shows the supplies life, counters and reports. **Admin Setting** lets you set the advanced setup to use your machine in depth and conveniently. **Usage Page Report** prints a report on the number of printouts based on the paper size and type.

Machine Status

ITEMS	OPTION
Supplies Life	Toner Cartridge Fuser Kit Feed Roller Kit-Tray 1 Feed Roller Kit-Tray 2 Feed Roller Kit-Bypass Tray BTR Kit
Machine Info	Machine Details Tray Status Print/Report Usage Counters

Admin Setting

ITEMS	OPTION
General	Device Info Date&Time Default Settings Measurements Timers Language Power Saver Tray Management Altitude Adjustment Contention Management Sound Supplies Management Machine Test On Demand Overwrite HDD Spooling Stored Job File Policy Country
Setup	Copy Setup Fax Setup Network Setup Authentication Optional Service
Print/Report	Print Accounting Reports Report

Usage Page Report

When the display "Are you sure you want to print it" appears, press Yes.

Job Status button

This menu shows the job in process, jobs waiting and, in completed, and error messages. (See "Job Status button" on page 23.)

ITEMS	OPTION
Current Job	Detail Delete Delete All Close
Completed Job	Detail Close
Active Notice	Detail Close

management tools

This chapter introduces management tools provided to help you make full use of your machine.

This chapter includes:

- Introducing useful management tools
- Using SyncThru™ Web Service
- Using the Smart Panel program

INTRODUCING USEFUL MANAGEMENT TOOLS

The programs below help you to use your machine conveniently.

- "Using SyncThru™ Web Service" on page 93.
- "Using the Smart Panel program" on page 93.
- "Smarthru Office" on page 94.
- "Using SetIP Program" on page 95.
- "Using the Linux Unified Driver Configurator" on page 96.

USING SYNCTHRU™ WEB SERVICE

If you have connected your machine to a network and set up TCP/IP network parameters correctly, you can manage the machine via SyncThru™ Web Service, an embedded web server. Use SyncThru™ Web Service to:

- View the machine's device information and check its current status.
- Change TCP/IP parameters and set up other network parameters.
- Change printer preference.
- Set the email notifications advising of the machine's status.
- Get support for using the machine.

To access SyncThru™ Web Service:

1. Start a web browser, such as Internet Explorer, from Windows.
2. Enter the machine IP address (<http://xxx.xxx.xxx.xxx>) in the address field and press the Enter key or click **Go**.
Your machine's embedded website opens.
3. Click **Login**.
The log-in window appears.
4. Enter the administrator's ID and password then click **Login**.
 • Enter the same administrator's ID and password to the touch screen.
 - If you do not login with administrator's ID and password, you can see the machine's information only.
5. Change the settings as you want such as the machine settings, network parameters, etc.

SyncThru™ Web Service overview

- **Information:** This tab gives you general information about your machine. You can check things, such as the machine's IP address, remaining amount of toner, ethernet information, firmware version, and so on. You can also print reports such as an error report and so on.
- **Machine Settings:** This tab allows you to set options provided by your machine.

- Smarthru Office
- Using SetIP Program
- Using the Linux Unified Driver Configurator

- **Network Settings:** This tab allows you to view and change the network environment. You can set things, such as TCP/IP and so on.
- **Maintenance:** This tab allows you to maintain your machine by upgrading firmware and setting security information.
- **Support:** This tab allows you to set contact information for sending email. You can also connect to SEC website or download drivers by selecting Link.

E-mail Notification Setup

You can receive emails about your machine's status by setting this option.

1. Start a web browser, such as Internet Explorer, from Windows.
Enter the machine IP address (<http://xxx.xxx.xxx.xxx>) in the address field and press the Enter key or click Go.
2. Your machine's embedded website opens.
3. From the **Machine Settings**, select **E-mail Notification Setup**.
4. Set required settings.
5. Click **Apply**.

USING THE SMART PANEL PROGRAM

Smart Panel is a program that monitors and informs you of the machine status, and allows you to customize the machine's settings. For Windows and Macintosh, Smart Panel is installed automatically when you install the machine software. For Linux, you can download Smart Panel from Samsung website and install (See "Installing the SmartPanel" on page 28).





- To use this program, you need the following system requirements:
- Windows. Check for windows operating system(s) compatible with your machine. (See "System requirements" on page 25.)
 - Mac OS X 10.3 or higher
 - Linux. Check for Linux systems that are compatible with your machine. (See "System requirements" on page 25.)
 - Internet Explorer version 5.0 or higher for flash animation in HTML Help.

If you need to know the exact model name of your machine, you can check the supplied software CD.

Understanding Smart Panel

If an error occurs while printing, you can check the error from the Smart Panel.

You can also launch Smart Panel manually. Double-click the Smart Panel icon on the Windows task bar (in Windows), or Notification Area (in Linux). You can also click it on the status bar (in Mac OS X).



Windows		Double-click this icon in Windows.
Macintosh		Click this icon in Mac OS X.
Linux		Click this icon in Linux.

Or, if you are a Windows user, you can launch it from the **Start** menu, select **Programs** or **All Programs** > your printer driver name > Smart Panel.

- If you have already installed more than one Samsung machine, first select the correct machine model you want in order to access the corresponding Smart Panel.
Right-click (in Windows or Linux) or click (in Mac OS X) the Smart Panel icon and select your machine.
- The Smart Panel window and its contents shown in this user's guide may differ depending on the machine or operating system in use.

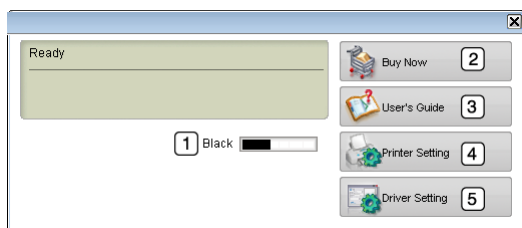
The Smart Panel program displays the current status of the machine, the level of toner remaining in the toner cartridge(s), and various other types of information. You can also change settings.



1	Toner Level	View the level of toner remaining in the toner cartridge(s). The machine and the number of toner cartridge(s) shown in the above window may differ depending on the machine in use. Some machines do not have this feature.
2	Buy Now	Order replacement toner cartridge(s) online.
3	User's Guide	View User's Guide.  This button changes to Troubleshooting Guide when error occurs. You can directly open troubleshooting section in the user's guide.
4	Printer Setting	Configure various machine settings in the Printer Settings Utility window. Some machines do not have this feature.  If you connect your machine to a network, the SyncThru™ Web Service window appears instead of the Printer Settings Utility window.
5	Driver Setting	Set all of the machine options you need in the Printer Preferences window. This feature is available only for Windows. (See "Understanding Printing Preferences" on page 47.)

Opening the Troubleshooting Guide

Find solutions for problems by using the **Troubleshooting Guide**.

Right-click (in Windows or Linux) or click (in Mac OS X) the Smart Panel icon and select **Troubleshooting Guide**.

Changing the Smart Panel Program Settings

Right-click (in Windows or Linux) or click (in Mac OS X) the Smart Panel icon and select **Options**. Select the settings you want from the **Options** window.

SMARTHRU OFFICE

The supplied software CD provides you with SmarThru Office. SmarThru Office offers you convenient features to use with your machine.

Starting SmarThru Office

Follow the steps below to start SmarThru Office:

1. Make sure that your machine and computer are turned on and properly connected to each other.
2. Once you have installed SmarThru Office, you will see the SmarThru Office icon on your desktop.
3. Double-click the SmarThru Office icon.



4. The SmarThru Office appears.

For more information, click **Help** > **SmarThru Office help**.

Quick Start Guide

This menu displays direct buttons for some features. The direct buttons include: **Categories**, **Binder**, **Life Cycle**, **Scan and OCR**, **Fix and Enhance**, and **Samsung Website**. You can disable this menu by checking "Do not show this dialog again".



Using SmarThru Office

Scanning

1. Click scan icon.

- In Windows XP operating system, you can use SmarThru Office launcher, which is on the right end of taskbar, to easily open the **Scan Setting** window.



- In other operating systems beside Windows XP, click the SmarThru icon  in the tray area of the windows taskbar to activate the SmarThru Office launcher.



2. Scan Setting window opens.

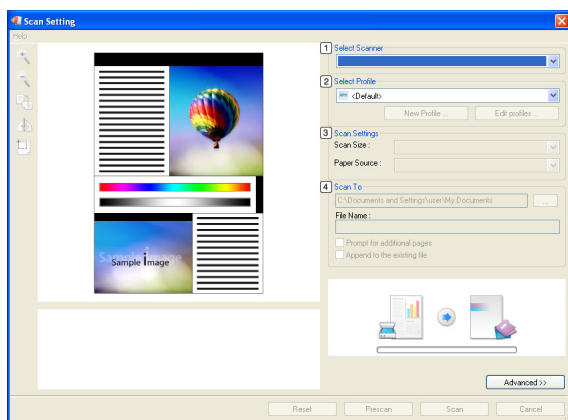

1	Select Scanner	Allows you to select between the Local or Network scanner.
2	Select Profile	Allows you to save settings frequently used for future use. Click New Profile to save the setting.
3	Scan Settings	Allows you to customize settings for Scan Size and Paper Source .
4	Scan To	Allows you to customize settings for File Name and location to send scanned data.

 Click **Advanced** button to set more scan options.

3. Set scan settings and click **Scan**.
For more information, click **Help > SmarThru Office help**.

Send to

FTP

You can upload files to an FTP server while working on SmarThru Office.

1. Select **File > Send to > Send By FTP**.
2. **Send By FTP** window opens.
3. Add your file and click **Upload**.

Email

You can send email while working on SmarThru Office.

 You need an email client program, such as Outlook Express, to send email in SmarThru Office. Procedure for sending email may differ depending on email client program you are using.

1. Select **File > Send to > Send By E-mail**.
2. An email client opens.
3. Type in necessary information and send your email.

Fax

You can send emails while working on SmarThru Office.

1. Select **File > Send to > Send By Fax**.
2. **Send Fax** window opens.
3. Type in necessary information and click **Send Fax**.

 For more information about SmarThru Office, click **Help > SmarThru Office help**. The **SmarThru Office Help** window appears; you can view on screen help supplied on the SmarThru program.

Follow the steps below to uninstall SmarThru Office. Before you begin the uninstall, ensure that all applications are closed on your computer.

- a) From the **Start** menu, select **Programs** or **All Programs**.
- b) Select SmarThru Office, and then select **Uninstall SmarThru Office**.
- c) When your computer asks you to confirm your selection, read the statement and click **OK**.
- d) Click **Finish**.

USING SETIP PROGRAM

 Macintosh and Linux do not support this program.

This program is for the network IP setting using the MAC address which is the hardware serial number of the network printer card or interface.

It is especially for the network administrator to set several network IPs at the same time.

 You can only use the SetIP program when your machine is connected to a network.

Installing the program

1. Insert the software CD provided with your machine. When the software CD runs automatically, close the window.
2. From the **Start** menu select **My Computer** and open the X drive. (X represents your CD-ROM drive.)
3. Double click **Application > SetIP**.
4. Double-click **Setup.exe** to install this program.
5. Click **OK**.
6. If necessary, select a language from the drop-down list..
7. Follow the instructions in the window to complete the installation.

Printing out the machine's MAC address

1. Press **Machine Setup** on the control panel.
2. Press **Machine Status > the Machine Info tab > Print/Report**.
3. Press **System Report**.
4. Scroll down the list on the right and select **Network Configuration Report**.
5. Press **Print**

Setting network values

1. Print the machine's **Network Configuration Report** to find your machine's MAC address.
2. From the Windows **Start** menu, select **Programs** or **All Programs > Samsung Network Printer Utilities > SetIP > SetIP**.
3. Click to open the TCP/IP configuration window.
4. Enter the network card's MAC address, IP address, subnet mask, default gateway, and then click **Apply**.
 When you enter the MAC address, enter it without a colon(:).
5. Click **OK**. The machine prints the network information. Confirm the settings are correct.
6. Click **Exit**.

USING THE LINUX UNIFIED DRIVER CONFIGURATOR

Unified Driver Configurator is a tool primarily intended for configuring machine devices. You need to install Unified Linux Driver to use Unified Driver Configurator (See "Installing the Linux Unified Driver" on page 27).

After the driver is installed on your Linux system, the Unified Driver Configurator icon will automatically be created on your desktop.

Opening the Unified Driver Configurator

1. Double-click the **Unified Driver Configurator** on the desktop.
You can also click the **Startup** Menu icon and select **Samsung Unified Driver > Unified Driver Configurator**.
2. Click each button on the left to switch to the corresponding configuration window.

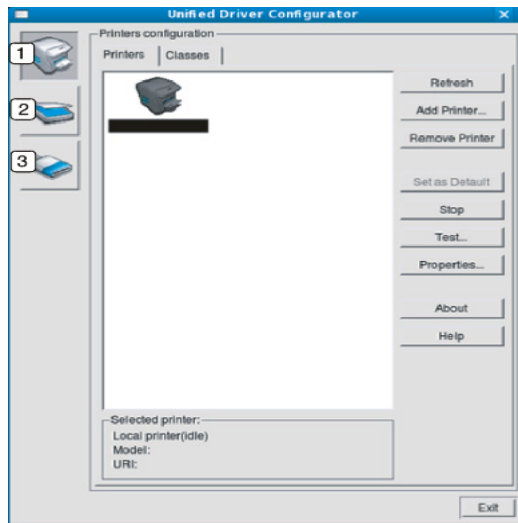

- 1 **Printers Configuration**
- 2 **Scanners Configuration**
- 3 **Ports Configuration**

 To use the on screen help, click **Help**.

3. After changing the configurations, click **Exit** to close the Unified Driver Configurator.

Printers configuration

Printers configuration has the two tabs: **Printers** and **Classes**.

Printers tab

View the current system's printer configuration by clicking on the machine icon button on the left side of the Unified Driver Configurator window.

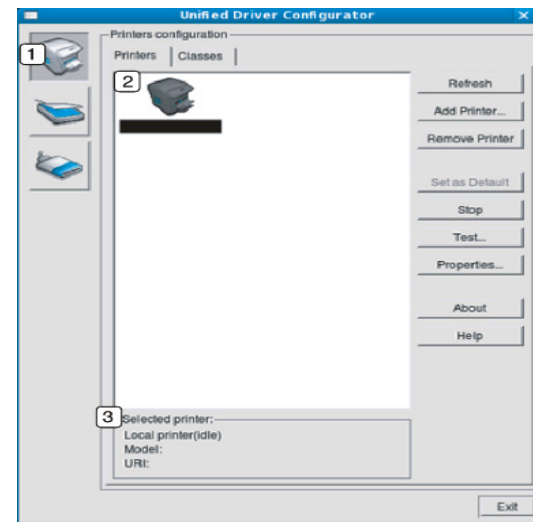

- 1 Switches to **Printers configuration**.
- 2 Shows all of the installed machine.
- 3 Shows the status, model name and URI of your machine.

The printer control buttons are, as follows:

- **Refresh:** Renews the available machines list.
- **Add Printer:** Allows you to add a new machines.
- **Remove Printer:** Removes the selected machine.
- **Set as Default:** Sets the current selected machine as a default machine.
- **Stop/Start:** Stops/starts the machine.
- **Test:** Allows you to print a test page to ensure the machine is working properly.
- **Properties:** Allows you to view and change the printer properties.

Classes tab

The Classes tab shows a list of available machine classes.

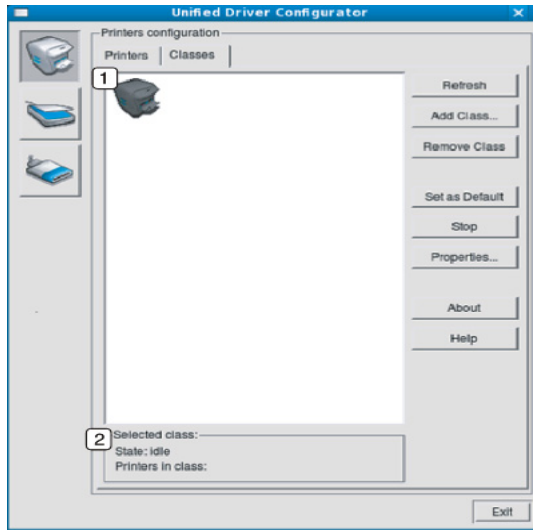

- | | |
|---|--|
| 1 | Shows all of the machine classes. |
| 2 | Shows the status of the class and the number of machines in the class. |
- **Refresh:** Renews the classes list.
 - **Add Class:** Allows you to add a new machine class.
 - **Remove Class:** Removes the selected machine class.

Scanners configuration

In this window, you can monitor the activity of scanner devices, view a list of installed Samsung machine devices, change device properties, and scan images.

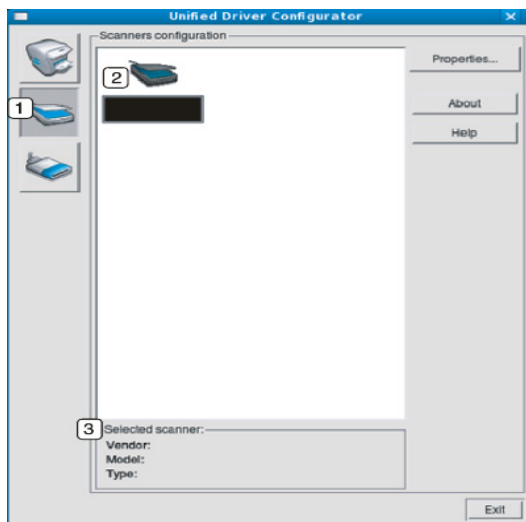

- | | |
|---|--|
| 1 | Switches to Scanners configuration . |
| 2 | Shows all of the installed scanners. |
| 3 | Shows the vendor, model name and type of your scanner. |

- **Properties:** Allows you to change the scan properties and scan a document.

Ports configuration

In this window, you can view the list of available ports, check the status of each port and release a port that is stalled in a busy state when its owner has terminated the job for any reason.

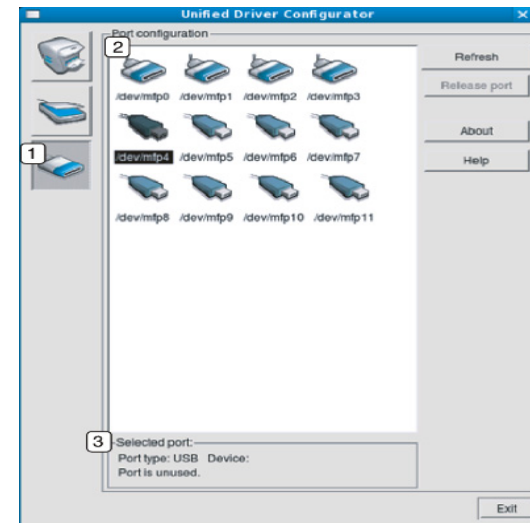

- | | |
|---|---|
| 1 | Switches to Ports configuration . |
| 2 | Shows all of the available ports. |
| 3 | Shows the port type, device connected to the port, and status |

- **Refresh:** Renews the available ports list.
- **Release port:** Releases the selected port.

Sharing Ports Between Printers and Scanners

Your machine may be connected to a host computer via a parallel port or USB port. Since the machine device contains more than one device (printer and scanner), it is necessary to organize proper access of "consumer" applications to these devices via the single I/O port.

The Unified Linux Driver package provides an appropriate port sharing mechanism that is used by Samsung printer and scanner drivers. The drivers talk to their devices via so-called machine ports. The current status of any machine port can be viewed via the **Ports configuration**. The port sharing prevents you from accessing one functional block of the machine device, while another block is in use.

When you install a new machine device onto your system, it is strongly recommended you do this with the assistance of an Unified Driver Configurator. In this case you will be asked to choose I/O port for the new device. This choice will provide the most suitable configuration for machine's functionality. For machine scanners, I/O ports are being chosen by scanner drivers automatically, so proper settings are applied by default.

This chapter provides information for maintaining your machine and the toner cartridge.

This chapter includes:

- Printing a machine report
- Monitoring the supplies life
- Finding the serial number
- Clearing fax memory
- Sending the toner reorder notification
- Checking Stored Documents
- Cleaning a machine
- Storing the toner cartridge
- Tips for moving & storing your machine

PRINTING A MACHINE REPORT

You can print the machine's information and job report.

1. Press **Machine Setup** on the control panel.
2. Press **Machine Status** > the **Machine Info** tab > **Print/Report**.
3. Select the report type, then the right side of the screen shows the list to print.
4. Select the list to print.
5. Press **Print**.



- If you want to print the machine's network information or font list, press **Machine Setup** > **Admin Setting** > the **Print/Report** tab > **Report**. If you select the **Configuration Report**, press **Print** to print the report. The **Fax Report**, **E-mail Confirmation Report**, and **Scan to Server Confirmation** options do not provide the print, these are only for report setup.
- You can use SyncThru™ Web Service to print the machine's configuration or browse the status. Open the web browser in the networked computer and type the machine's IP address. When SyncThru™ Web Service opens, click **Information** > **Print Information**.

MONITORING THE SUPPLIES LIFE

To view the supply life indicators, follow the steps below:

1. Press **Machine Setup** on the control panel.
2. Press **Machine Status**.
3. Check the used count of each supply item.

FINDING THE SERIAL NUMBER

To check your serial number from the screen, follow the steps below:

1. Press **Machine Setup** on the control panel.
2. Press **Machine Status** > the **Machine Info** tab > **Machine Details**.

CLEARING FAX MEMORY

You can erase fax memory. There are two ways to erasing fax memory, follow the steps below:



- If you are clearing fax memory without printing a fax job, you are erasing it without checking the content. Be careful not to an erase important document.

Clearing fax memory by printing a fax job

Print received fax job. Fax memory will automatically be erased.

Clearing fax memory without printing a fax job

From the **Job Status** > **Current Job** tab in the fax's main LCD.

- To erase all the jobs on the list, click **Delete All**.
This option erases all the jobs in the memory, be careful not to erase jobs other than a fax job.
- To erase only fax jobs on the list, select fax jobs with in the **Job Type** list and click **Delete**.

SENDING THE TONER REORDER NOTIFICATION

To set the machine to alert when the toner level is low and needs to be reordered, do the following:

1. Press **Machine Setup** on the control panel.
2. Press **Admin Setting**. When the login message pops up, enter the password and press **OK**.
3. Press the **General** tab > **Supplies Management** > **Toner Cartridge Reorder Notification**.
4. Press **Toner Reorder at Life Remaining** and select a percentage.
5. Press **OK**.

CHECKING STORED DOCUMENTS

The machine shows the document list of the print or fax job.

Press **Stored Documents** on the main screen. If the screen displays another menu, press () to go to the main screen.

- **Public tab:** Shows the job list of delay print and store print job.
- **Secured tab:** Shows the job list of secure print, secure receive, and secure store print job.
- **User Name:** Shows the user name who registered the job.
- **File Name:** Shows the job name, which is registered as the job information. For computer printing, the file name shows.
- **Date:** Shows the date the job was registered.
- **Page:** Shows the total page number of the job.
- **Detail:** A separate message appears showing the basic job information with file size, paper size and paper type.
- **Edit:** Lets you modify the file name.
- **Delete:** Deletes the selected list.

- **Delete All:** Deletes the whole list.
- **Print:** Prints the selected list.

CLEANING A MACHINE

If printing quality problems occur or if you use your machine in a dusty environment, you need to clean your machine regularly to keep the best printing condition and use your machine longer.

- ⚠ • Cleaning the cabinet of the machine with cleaning materials containing large amounts of alcohol, solvent, or other strong substances can discolor or distort the cabinet.
- If your machine or the surrounding area is contaminated with toner, we recommend you use cloth or tissue dampened with water to clean it. If you use a vacuum cleaner, toner blows in the air and might be harmful to you.

Cleaning the outside

Clean the machine cabinet with a soft, lint-free cloth. Dampen the cloth slightly with water, but be careful not to let any water drip onto or into the machine.

Cleaning the inside

During the printing process, paper, toner, and dust particles can accumulate inside the machine. This buildup can cause print quality problems, such as toner specks or smearing. Cleaning the inside of the machine clears and reduces these problems.

1. Turn the machine off and unplug the power cord. Wait for the machine to cool down.
2. Open the front cover and pull the toner cartridge out. Set it on a clean flat surface

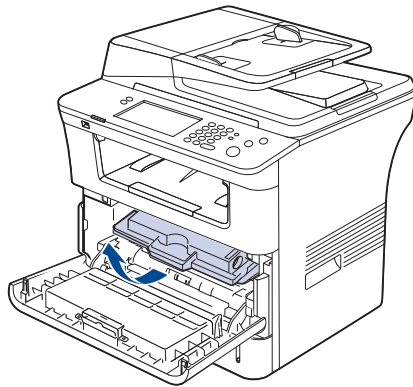

- ⚠ • To prevent damage to the toner cartridge, do not expose it to light for more than a few minutes. Cover it with a piece of paper, if necessary.
- Do not touch the green surface underside of the toner cartridge. Use the handle on the cartridge to avoid touching this area.

3. With a dry, lint-free cloth, wipe away any dust and spilled toner from the toner cartridge area.

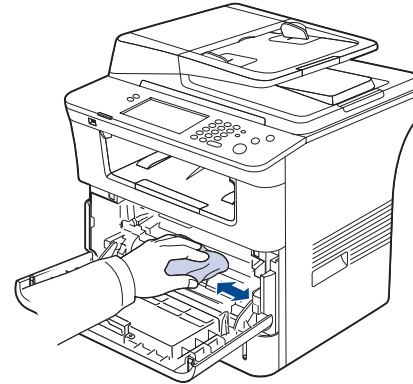

- ⚠ While cleaning the inside of the machine, be careful not to damage the transfer roller or any other inside parts. Do not use solvents such as benzene or thinner to clean. Printing quality problems can occur and cause damage to the machine.

4. Locate the long strip of glass (LSU) inside the top of the cartridge compartment and gently clean the glass with a swab.

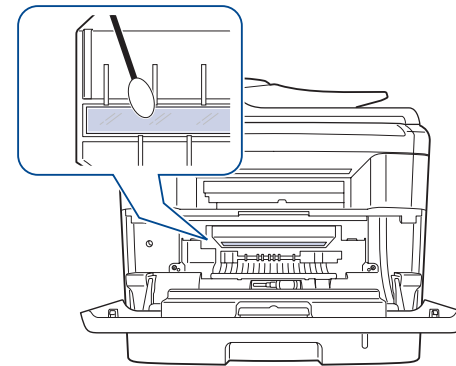

5. Reinsert the toner cartridge and close the front cover.
6. Plug in the power cord and turn the machine on.

Cleaning the scan unit

Keeping the scan unit clean helps ensure the best possible copies. We suggest that you clean the scan unit at the start of each day and during the day, as needed.

1. Slightly dampen a soft, lint-free cloth or paper towel with water.
2. Open the scanner lid.
3. Wipe the surface of the scanner glass and the document feeder glass until it is clean and dry.

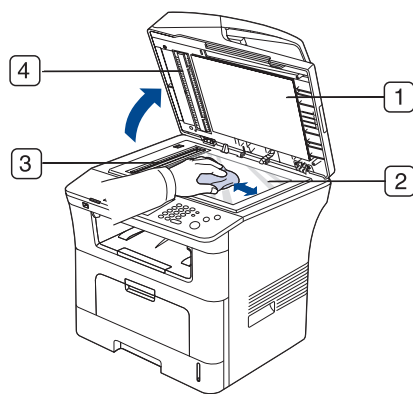

- | | |
|---|-----------------------|
| 1 | Scanner lid |
| 2 | Scanner glass |
| 3 | Document feeder glass |
| 4 | White sheet |

4. Wipe the underside of the scanner lid and white sheet until it is clean and dry.
5. Close the scanner lid.

STORING THE TONER CARTRIDGE

To get the best, print quality from the toner cartridge, keep the following guidelines in mind:

- Do not remove the toner cartridge from its package until ready to use.
- Do not refill the toner cartridge. The machine warranty does not cover damage caused by using a refilled cartridge.
- Store toner cartridges in the same environment as your machine.

Expected cartridge life

The life of the toner cartridge yield depends on the amount of toner that print jobs require. The actual number may also be different depending on the print density of the pages you print on, and the number of pages may be affected by the operating environment, printing interval, media type, and media size. If you print a lot of graphics, you may need to change the cartridge more often.

TIPS FOR MOVING & STORING YOUR MACHINE

- When moving the machine, do not tilt or turn it upside down. Otherwise, the inside of the machine may be contaminated by toner, which can cause damage to the machine or bad print quality.
- When moving the machine, make sure at least two people are holding the machine securely.
- When moving the machine or when machine is not in use for a long time, lock the scanner lock. (See "Front view" on page 19.)

troubleshooting

This chapter gives helpful information for what to do if you encounter an error.

This chapter includes:

- Redistributing toner
- Clearing original document jams
- Tips for avoiding paper jams
- Clearing paper jams
- Understanding display messages
- Solving other problems

REDISTRIBUTING TONER

When the toner cartridge is near the end of its life:

- White streaks or light printing occurs.
- **Toner is low. Order new toner cartridge** appears on the display.
- The **Status** LED blinks red.

If this happens, you can temporarily improve print quality by redistributing the remaining toner in the cartridge. In some cases, white streaks or light printing will still occur even after you have redistributed the toner.

1. Open the front cover.
2. Pull the toner cartridge out.

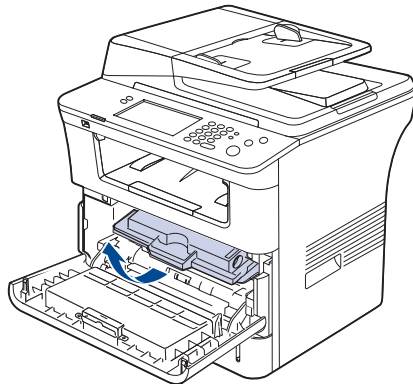

3. Thoroughly roll the cartridge five or six times to distribute the toner evenly inside the cartridge.

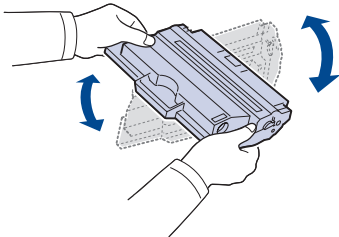

 If toner gets on your clothing, wipe it off with a dry cloth and wash clothing in cold water. Hot water sets toner into fabric.

 Do not touch the green underside of the toner cartridge. Use the handle on the cartridge to avoid touching this area.

4. Hold the toner cartridge by the handle and slowly insert the cartridge into the opening in the machine.

Tabs on the sides of the cartridge and corresponding grooves within the machine will guide the cartridge into the correct position until it locks into

place completely.

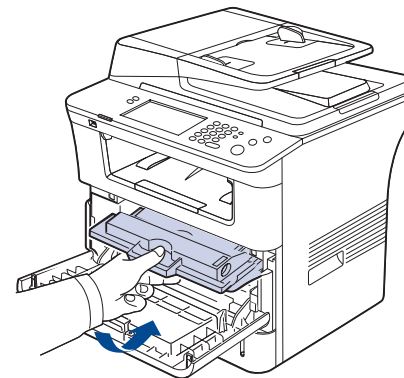

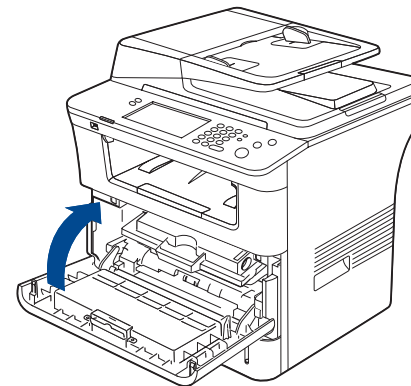

5. Close the front cover. Ensure that the cover is securely closed.



CLEARING ORIGINAL DOCUMENT JAMS

When an original jams while passing through the document feeder, a warning message appears on the display screen.

 To avoid tearing the document, remove the jammed document slowly and gently.

 To prevent document jams, use the scanner glass for thick, thin, or mixed paper-type originals.

1. Remove any remaining pages from the document feeder.
2. Seize the misfeed paper, and remove the paper from the document output tray by carefully pulling it to the right using both hands.

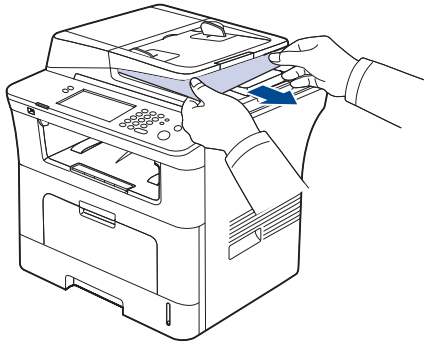

If you see no paper in this area, go to the next step

3. Open the document feeder cover.

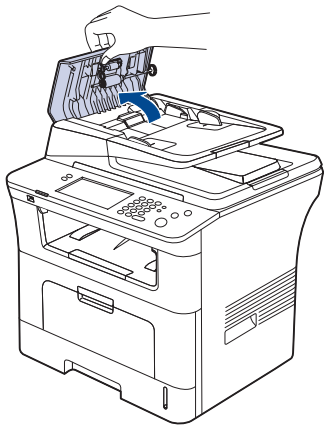

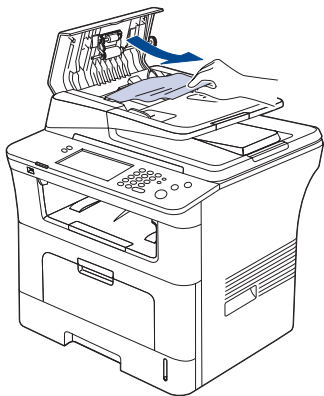

4. Gently remove the jammed paper from the document feeder.

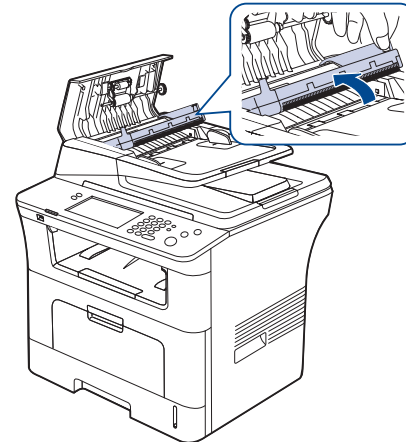

If you see no paper in this area, go to the next step

5. Open the document feeder inner cover. Gently remove the jammed paper.



 If you see no paper in this area, go to step 7.

6. Close the document feeder inner cover and the document feeder cover. Reload the pages you removed, if any, in the document feeder.
7. Open the scanner lid.
8. Grasp the misfeed paper and, using both hands, remove the paper from the feed area by carefully pulling it to the right.

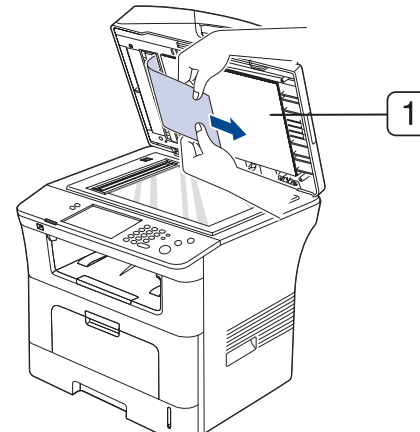

1 scanner lid

9. Close the scanner lid. Load the removed pages back into the document feeder.

TIPS FOR AVOIDING PAPER JAMS

By selecting the correct media types, most paper jams can be avoided. When a paper jam occurs, refer to the next guidelines.

- Ensure that the adjustable guides are positioned correctly. (See "Loading paper in the tray" on page 38.)
Do not overload the tray. Ensure that the paper level is below the paper capacity mark on the inside of the tray.
- Do not remove paper from the tray while your machine is printing.
- Flex, fan, and straighten paper before loading.
- Do not use creased, damp, or highly curled paper.
- Do not mix paper types in a tray.
- Use only recommended print media. (See "Setting the paper size and type" on page 42.)

- Ensure that the recommended side of the print media is facing down in the tray, or facing up in the multi-purpose tray.
- If paper jams occur frequently when you print on A5/B5-sized paper: Load the paper into the tray with the long edge facing the front of the tray.

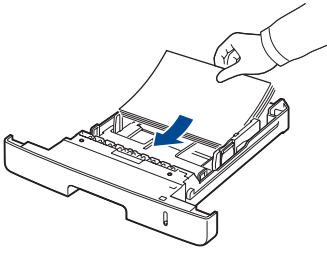

If load the paper this way, printing both sides of the paper (Duplex) is not supported.

In the **Printing Preferences** window, set the page orientation to be rotated 90 degrees. (See "Paper tab" on page 48.)

CLEARING PAPER JAMS

When a paper jam occurs, a warning message appears on the display screen.

-  To avoid tearing the paper, pull the jammed paper out slowly and gently. Follow the instructions in the following sections to clear the jam.

In tray 1

 Click this link to open an animation about clearing a jam.

1. Open and close the front cover. The jammed paper is automatically ejected from the machine.
If the paper does not exit, go to the next step.
2. Pull out tray 1 .

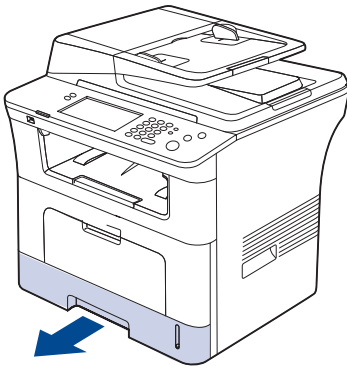

3. Remove the jammed paper by gently pulling it straight out.

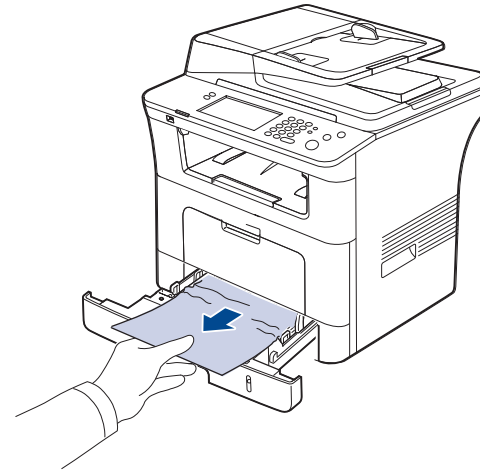

If the paper does not move when you pull, or if you do not see the paper in this area, check the fuser area around the toner cartridge. (See "Inside the machine" on page 104.)

4. Insert tray 1 back into the machine until it snaps into place. Printing automatically resumes.

In optional tray 2

 Click this link to open an animation about clearing a jam.

1. Pull out optional tray 2.
2. Remove the jammed paper from the machine.

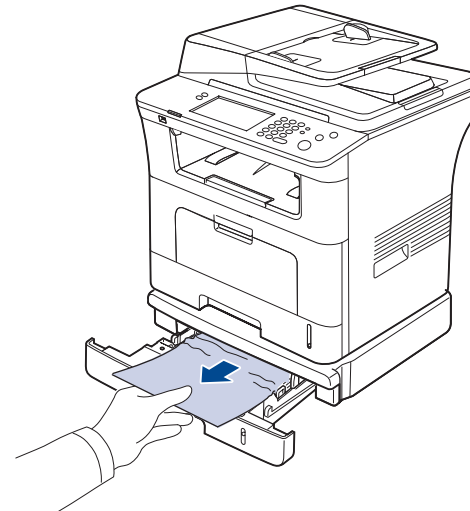

If the paper does not move when you pull or if you do not see the paper in this area, stop and go to the next step.

3. Pull tray 1 half-way out.

4. Pull the paper straight up and out.

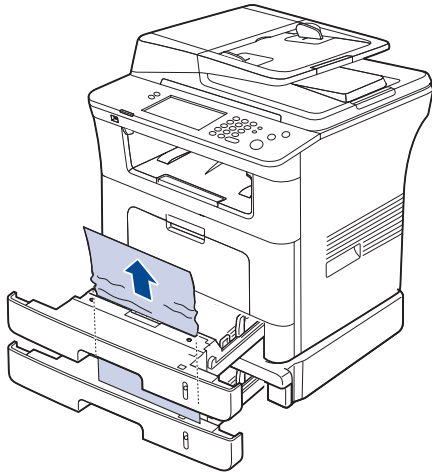

5. Insert the trays back into the machine. Printing automatically resumes.

In the multi-purpose tray

 Click this link to open an animation about clearing a jam.

1. If the paper is not feeding properly, pull the paper out of the machine.

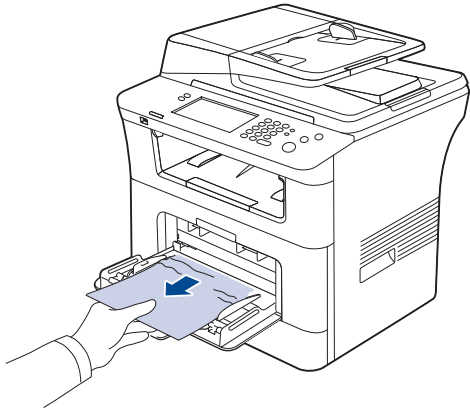

2. Open and close the front cover to resume printing.

Inside the machine

 Click this link to open an animation about clearing a jam.

 The fuser area is hot. Take care when removing paper from the machine.

1. Open the front cover and pull the toner cartridge out, lightly pushing it down.

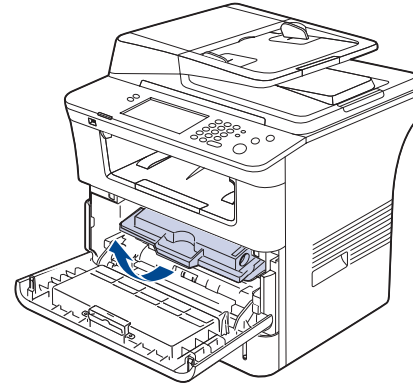

2. Remove the jammed paper by gently pulling it straight out.

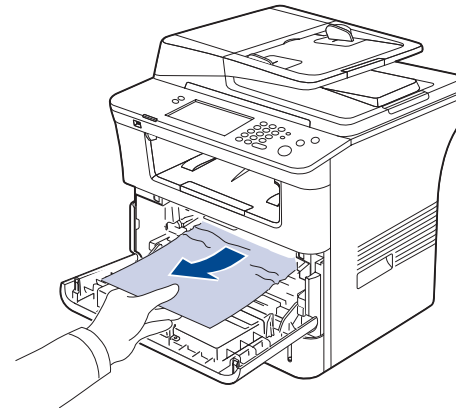

3. Replace the toner cartridge and close the front cover. Printing automatically resumes.

In exit area

 Click this link to open an animation about clearing a jam.

1. Open and close the front cover. The jammed paper is automatically ejected from the machine.
If you do not see the jammed paper, go to next step.
2. Gently pull the paper out of the output tray.

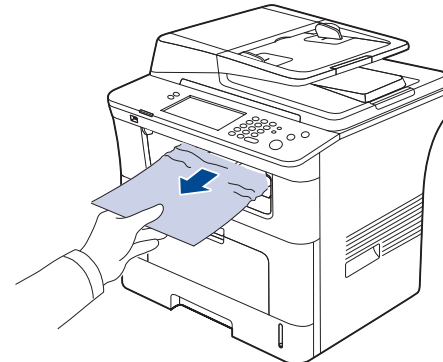

If you do not see the jammed paper or if there is any resistance when you pull, stop and go to the next step.

3. Open the rear cover.

4. If you see the jammed paper, push the pressure lever on each side up and remove the paper. Skip to step 9.

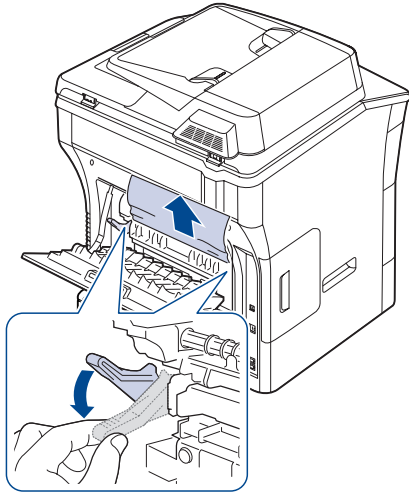

If you still do not see the paper, go to the next step.

5. Release the strip, the rear cover stopper, and fully open the rear cover, as shown.

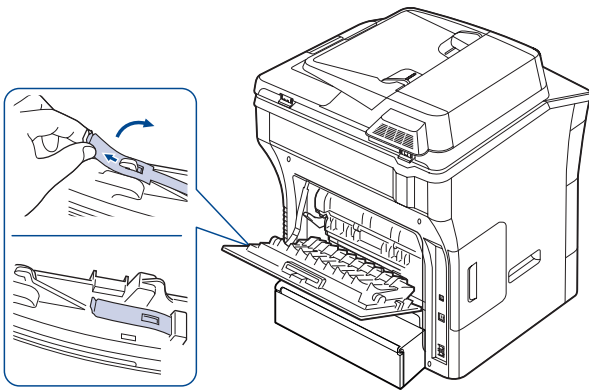

6. Unfold the duplex guide fully.

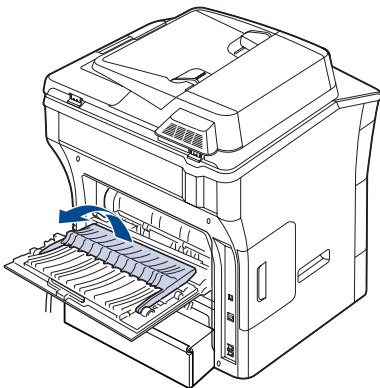

7. While pushing the fuser lever to the right, open the fuser door.

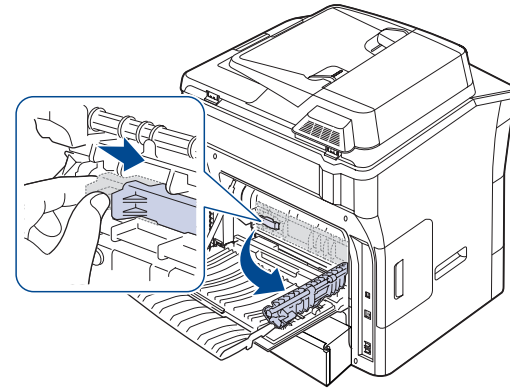

8. Pull the jammed paper out.
If the jammed paper does not move when you pull, push the pressure lever on each side up to loosen the paper, and then remove it.

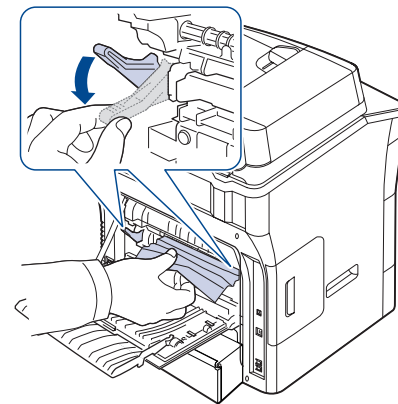

9. Return the lever, door, stopper, and guide to their original position.
10. Close the rear cover. Printing automatically resumes.

In the duplex unit area

-  Click this link to open an animation about clearing a jam.

If the duplex unit is not inserted correctly, a paper jam may occur. Make sure that the duplex unit is inserted correctly.

1. Pull the duplex unit out of the machine.

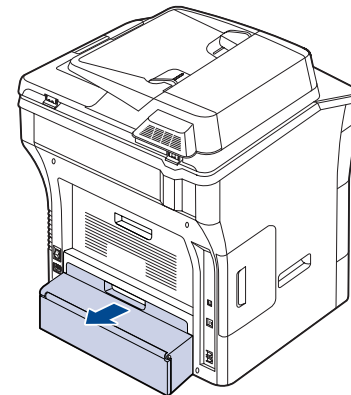

2. Remove the jammed paper from the duplex unit.

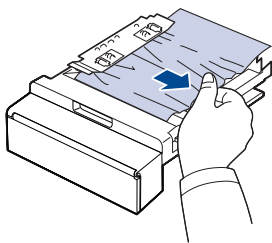

If the paper does not come out with the duplex unit, remove the paper from the bottom of the machine.
Insert the duplex unit into the machine.

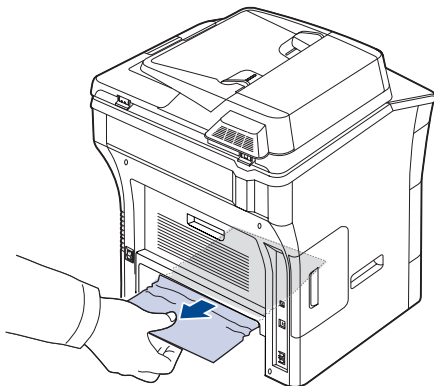

If you still do not see the paper, go to the next step.

3. Open the rear cover.
4. Unfold the duplex guide fully.

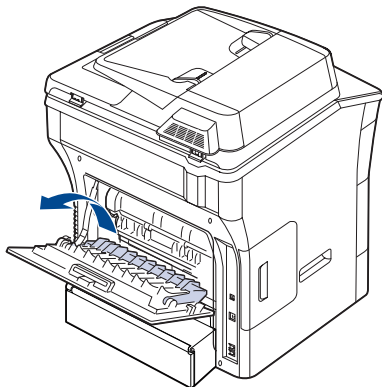

5. Pull the jammed paper out.

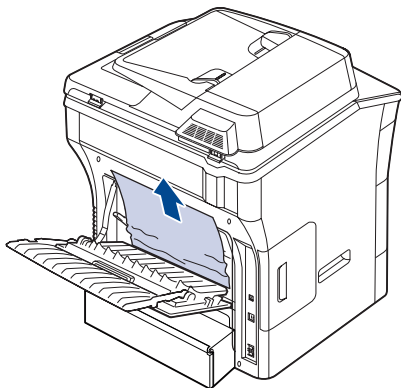

6. Fold the duplex guide and close the rear cover.

UNDERSTANDING DISPLAY MESSAGES

Messages appear on the control panel display to indicate the machine's status or errors. Refer to the tables below to understand the messages' and their meaning, and correct the problem, if necessary.

- If a message is not in the table, reboot the power and try the printing job again. If the problem persists, call for service.
- When you call for service, provide the service representative with the contents of display message.
- Some messages may not appear in the display depending on options or models.
- [zzz] indicates the error code. When you contact the service center, this error code help to handle the problem.
- You may see an exclamation mark (⚠) or a cross mark (✖) on the upper left of the display, in that case, press the question mark to browse detailed information on the supplies.



MESSAGE	MEANING	SUGGESTED SOLUTIONS
Fax memory is almost full. Print or remove received fax Job	There is no more available fax memory. No more fax data can be received.	Print the received fax or delete them from the fax memory. Call for service to delete fax memory.
Fax memory is full. Print or remove received fax Job	Available fax memory is now 1MB.	Delete the received fax data in the memory to secure memory. Call for service.
Fuser error: [zzz]. Please turn off then on	There is a problem in the fuser unit working.	Turn the machine off and back on again. If the problem persists, call for service.
LSU error: [zzz]. Please turn off then on	There is a problem in the control of LSU unit.	Turn the machine off and back on again. If the problem persists, call for service.
Original paper jam in front of scanner	The originals are jammed in document feeder.	Open the document feeder cover and remove the jammed original.
Original paper jam in front of scanner duplex path	The originals are jammed during duplex printing in the document feeder.	Clear the jam.
Original paper jam inside of scanner	The failed to activate the gate sensor within the correct time after activating the scan sensor. When the machine is on, jammed paper is detected in the document feeder.	Open the document feeder cover and remove the jammed original.

MESSAGE	MEANING	SUGGESTED SOLUTIONS
Original paper jam while reversing paper in scanner	The document failed to activate the duplex sensor within the correct time while reversing the document.	Lift up the document input tray and remove the jammed original. (See "Clearing original document jams" on page 101.)
Paper Jam at the bottom of duplex path	Paper has jammed during duplex printing.	Clear the jam. (See "In the duplex unit area" on page 105.)
Paper Jam at the top of duplex path	Paper has jammed during duplex printing.	Clear the jam. (See "In the duplex unit area" on page 105.)
Paper Jam in exit area	Paper has jammed in the fuser area.	Clear the jam. (See "In exit area" on page 104.)
Paper Jam in MP tray	Paper misfed from multi-purpose tray	Clear the jam. (See "In the multi-purpose tray" on page 104.)
Paper Jam in tray 1	Paper has jammed in the feeding area of the tray.	Clear the jam. (See "In tray 1" on page 103.)
Paper Jam in tray 2	Paper has jammed in the feeding area of the tray.	Clear the jam. (See "In optional tray 2" on page 103.)
Paper Jam inside of duplex path	Paper has jammed during duplex printing.	Clear the jam. (See "In the duplex unit area" on page 105.)
Paper Jam inside of machine	Paper has jammed in the registration area.	Clear the jam. (See "Inside the machine" on page 104.)
Scanner locking switch is locked or another problem occurred	The CCD (Charged Couple Device) lock has been locked.	Unlock the CCD lock. (See "Front view" on page 19.) Or turn off the machine and on again. If the problem persists, call for service.
Sensor failure: [zzz]. Call for service	There is a problem in the sensor signal.	Turn the machine off and back on again. If the problem persists, call for service.
Shake toner cartridge	The toner supply is low.	Thoroughly roll the new cartridge five or six times to distribute the toner evenly inside the cartridge. (See "Redistributing toner" on page 101.)
System error: [zzz]. Please turn off then on	There is a problem in the system operation.	Turn the machine off and back on again. If the problem persists, call for service.

MESSAGE	MEANING	SUGGESTED SOLUTIONS
This IP address conflicts with an IP address already in use. Check it	The IP address is used elsewhere.	Check the IP address or obtain a new IP address.
Toner cartridge is not compatible. Check user's guide	The toner cartridge you have installed is not for your machine.	Install a Samsung-genuine toner cartridge, designed for your machine. (See "Available supplies" on page 118.)
Toner cartridge is not installed. Install it	The toner cartridge is not installed or the CRUM (Consumer Replaceable Unit Monitor) in the cartridge is not properly connected.	Try to install or reinstall the toner cartridge.
Toner cartridge is worn. Replace with new one	The toner cartridge has run out. The machine stops printing.	You can select the option among Stop , Continue . If you select Stop , the machine stops printing. If you select Continue , the machine keeps printing, but the quality cannot be guaranteed. (See "Replacing the toner cartridge" on page 119.)
Toner is empty. Replace toner cartridge	The toner cartridge has reached the end of its lifespan.	This message appears when the toner is completely empty, and your machine stops printing. Replace the toner cartridge with a Samsung-genuine toner cartridge. (See "Replacing the toner cartridge" on page 119.)
Toner is low. Order new toner cartridge	The toner cartridge is almost empty.	Ensure a replacement cartridge is in stock. (See "Redistributing toner" on page 101.)

SOLVING OTHER PROBLEMS

The following chart lists some conditions that may occur and the recommended solutions. Follow the suggested solutions until the problem is corrected. If the problem persists, call for service.

Touch screen problem

CONDITION	SUGGESTED SOLUTIONS
The touch screen does not show anything.	Turn the machine off and back on again. If the problem persists, call for service.

Paper feeding problems

CONDITION	SUGGESTED SOLUTIONS
Paper jams during printing.	Clear the paper jam. (See "Clearing paper jams" on page 103.)
Paper sticks together.	<ul style="list-style-type: none"> Check the maximum paper capacity of the tray. (See "Print media specifications" on page 126.) Make sure that you are using the correct type of paper. (See "Print media specifications" on page 126.) Remove paper from the tray and flex or fan the paper. Humid conditions may cause some paper to stick together.
Multiple sheets of paper do not feed.	Different types of paper may be stacked in the tray. Load paper of only one type, size, and weight.
Paper does not feed into the machine.	<ul style="list-style-type: none"> Remove any obstructions from inside the machine. Paper has not been loaded correctly. Remove paper from the tray and reload it correctly. There is too much paper in the tray. Remove excess paper from the tray. The paper is too thick. Use only paper that meets the specifications required by the machine. (See "Print media specifications" on page 126.) If an original does not feed into the machine, the document feeder rubber pad may require to be replaced. Contact a service representative.

CONDITION	SUGGESTED SOLUTIONS
The paper keeps jamming.	<ul style="list-style-type: none"> • There is too much paper in the tray. Remove excess paper from the tray. If you are printing on special materials, use the multi-purpose tray. • An incorrect type of paper is being used. Use only paper that meets the specifications required by the machine. (See "Print media specifications" on page 126.) • There may be debris inside the machine. Open the front cover and remove any debris. • If an original does not feed into the machine, the document feeder rubber pad may need to be replaced. Contact a service representative.
Transparencies stick together in the paper exit.	Use only transparencies specifically designed for laser printers. Remove each transparency as it exits from the machine.
Envelopes skew or fail to feed correctly.	Ensure that the paper guides are against both sides of the envelopes.

Printing problems

CONDITION	POSSIBLE CAUSE	SUGGESTED SOLUTIONS
The machine does not print.	The machine is not receiving power.	Check the power cord connections. Check the power switch and the power source.
	The machine is not selected as the default machine.	Select your machine as your default machine in your Windows.
	Check the machine for the following: <ul style="list-style-type: none"> • The front cover is not closed. Close the front cover. • Paper is jammed. Clear the paper jam. (See "Clearing paper jams" on page 103.) • No paper is loaded. Load paper. (See "Loading paper in the tray" on page 38.) • The toner cartridge is not installed. Install the toner cartridge. If a system error occurs, contact your service representative.	
	The connection cable between the computer and the machine is not connected properly.	Disconnect the machine cable and reconnect it.
	The connection cable between the computer and the machine is defective.	If possible, attach the cable to another computer that is working properly and print a job. You can also try using a different machine cable.
	The port setting is incorrect.	Check the Windows printer setting to make sure that the print job is sent to the correct port. If the computer has more than one port, make sure that the machine is attached to the correct one.
	The machine may be configured incorrectly.	Check the Printing Preferences to ensure that all of the print settings are correct. (See "Opening Printing Preferences" on page 47.)
	The printer driver may be incorrectly installed.	Repair the machine software. (See "Installing USB connected machine's driver" on page 26, "Installing network connected machine's driver" on page 31.)
	The machine is malfunctioning.	Check the display message on the control panel to see if the machine is indicating a system error. Contact a service representative.

CONDITION	POSSIBLE CAUSE	SUGGESTED SOLUTIONS
(Continued) The machine does not print.	The document size is so big that the hard disk space of the computer is insufficient to access the print job.	Get more hard disk space and print the document again.
The machine selects print materials from the wrong paper source.	The paper option that was selected in the Printing Preferences may be incorrect.	For many software applications, the paper source selection is found under the Paper tab within the Printing Preferences . Select the correct paper source. See the printer driver help screen. (See "Opening Printing Preferences" on page 47.)
A print job is extremely slow.	The job may be very complex.	Reduce the complexity of the page or try adjusting the print quality settings.
Half the page is blank.	The page orientation setting may be incorrect.	Change the page orientation in your application. See the printer driver help screen.
	The paper size and the paper size settings do not match.	Ensure that the paper size in the printer driver settings matches the paper in the tray. Or, ensure that the paper size in the printer driver settings matches the paper selection in the software application settings you use.





CONDITION	POSSIBLE CAUSE	SUGGESTED SOLUTIONS
The machine prints, but the text is wrong, garbled, or incomplete.	The machine cable is loose or defective.	Disconnect the machine cable and reconnect. Try a print job that you have already printed successfully. If possible, attach the cable and the machine to another computer that you know works and try a print job. Finally, try a new machine cable.
	The wrong printer driver was selected.	Check the application's printer selection menu to ensure that your machine is selected.
	The software application is malfunctioning.	Try printing a job from another application.
	The operating system is malfunctioning.	Exit Windows and reboot the computer. Turn the machine off and back on again.
	If you are in a DOS environment, the font setting for your machine may be set incorrectly.	Change the language setting. (See "Changing the font setting" on page 35.)
Pages print, but they are blank.	The toner cartridge is defective or out of toner.	Redistribute the toner, if necessary. If necessary, replace the toner cartridge.
	The file may have blank pages.	Check the file to ensure that it does not contain blank pages.
	Some parts, such as the controller or the board, may be defective.	Contact a service representative.
The machine does not print PDF file correctly. Some parts of graphics, text, or illustrations are missing.	Incompatibility between the PDF file and the Acrobat products.	Printing the PDF file as an image may enable the file to print. Turn on Print As Image from the Acrobat printing options.  It will take longer to print when you print a PDF file as an image.

CONDITION	POSSIBLE CAUSE	SUGGESTED SOLUTIONS
The print quality of photos is not good. Images are not clear.	The resolution of the photo is very low.	Reduce the photo size. If you increase the photo size in the software application, the resolution will be reduced.
Before printing, the machine emits vapor near the output tray.	Using damp paper can cause vapor during printing.	This is not a problem. Just keep printing.
The machine does not print special- sized paper, such as billing paper.	Paper size and paper size setting do not match.	Set the correct paper size in the Custom in the Paper tab in the Printing Preferences . (See "Paper tab" on page 48.)

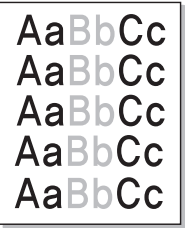
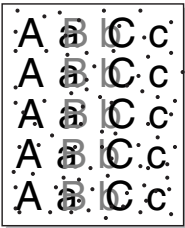

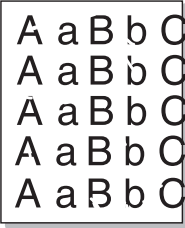
Printing quality problems

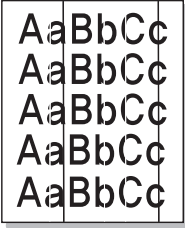
If the inside of the machine is dirty or paper has been loaded improperly, there might be a reduction in print quality. See the table below to clear the problem.

CONDITION	SUGGESTED SOLUTIONS
Light or faded print 	<ul style="list-style-type: none"> If a vertical white streak or faded area appears on the page, the toner supply is low. You may be able to temporarily extend the toner cartridge life. (See "Redistributing toner" on page 101.) If this does not improve the print quality, install a new toner cartridge. The paper may not meet paper specifications; for example, the paper may be too moist or rough. (See "Print media specifications" on page 126.) If the entire page is light, the print resolution setting is too low or the toner save mode is on. Adjust the print resolution and turn the toner save mode off. See the help screen of the printer driver. A combination of faded or smeared defects may indicate that the toner cartridge needs cleaning. (See "Cleaning the inside" on page 99.) The surface of the LSU part inside the machine may be dirty. (See "Cleaning the inside" on page 99.)
Toner specks 	<ul style="list-style-type: none"> The paper may not meet specifications; for example, the paper may be too moist or rough. (See "Print media specifications" on page 126.) The transfer roller may be dirty. Clean the inside of your machine. Contact a service representative. The paper path may need cleaning. Contact a service representative.

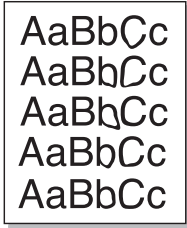
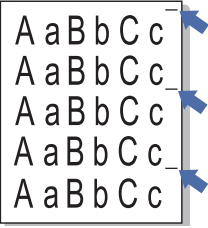
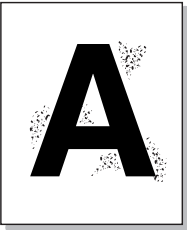
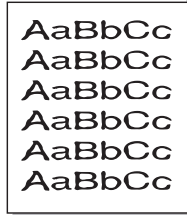
CONDITION	SUGGESTED SOLUTIONS
Dropouts 	<p>If faded areas, generally rounded, occur randomly on the page:</p> <ul style="list-style-type: none"> A single sheet of paper may be defective. Try reprinting the job. The moisture content of the paper is uneven or the paper has moist spots on its surface. Try a different brand of paper. (See "Print media specifications" on page 126.) The paper lot is bad. The manufacturing processes can cause some areas to reject toner. Try a different kind or brand of paper. Change the printer option and try again. Go to Printing Preferences, click Paper tab, and set type to Thick. (See "Opening Printing Preferences" on page 47.) If these steps do not correct the problem, contact a service representative.
White Spots 	<p>If white spots appear on the page:</p> <ul style="list-style-type: none"> The paper is too rough and a lot of dirt from a paper falls to the inner devices within the machine, so the transfer roller may be dirty. Clean the inside of your machine. (See "Cleaning the inside" on page 99.) The paper path may need cleaning. (See "Cleaning the inside" on page 99.)
Vertical lines 	<p>If black vertical streaks appear on the page:</p> <ul style="list-style-type: none"> The surface (drum part) of the toner cartridge inside the machine has probably been scratched. Remove the toner cartridge and install a new one. (See "Replacing the toner cartridge" on page 119.) <p>If white vertical streaks appear on the page:</p> <ul style="list-style-type: none"> The surface of the LSU part inside the machine may be dirty. (See "Cleaning the inside" on page 99.)
Color or Black background 	<p>If the amount of background shading becomes unacceptable:</p> <ul style="list-style-type: none"> Change to a lighter weight paper. (See "Print media specifications" on page 126.) Check the environmental conditions: very dry conditions or a high level of humidity (higher than 80% RH) can increase the amount of background shading. Remove the old toner cartridge and, install a new one. (See "Replacing the toner cartridge" on page 119.)

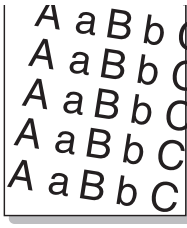
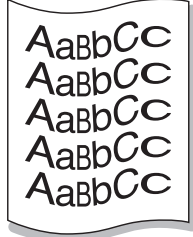
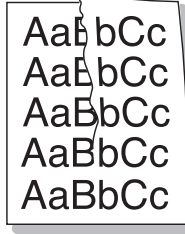
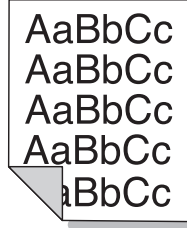
CONDITION	SUGGESTED SOLUTIONS
<p>Toner smear</p> 	<p>If toner smears on the page:</p> <ul style="list-style-type: none"> • Clean the inside of the machine. (See "Cleaning the inside" on page 99.) • Check the paper type and quality. (See "Print media specifications" on page 126.) • Remove the toner cartridge and then, install a new one. (See "Replacing the toner cartridge" on page 119.)
<p>Vertical repetitive defects</p> 	<p>If marks repeatedly appear on the printed side of the page at even intervals:</p> <ul style="list-style-type: none"> • The toner cartridge may be damaged. If you still have the same problem, remove the toner cartridge and, install a new one. (See "Replacing the toner cartridge" on page 119.) • Parts of the machine may have toner on them. If the defects occur on the back of the page, the problem will likely correct itself after a few more pages. • The fusing assembly may be damaged. Contact a service representative.
<p>Background scatter</p> 	<p>Background scatter results from bits of toner randomly distributed on the printed page.</p> <ul style="list-style-type: none"> • The paper may be too damp. Try printing with a different batch of paper. Do not open packages of paper until necessary so that the paper does not absorb too much moisture. • If background scatter occurs on an envelope, change the printing layout to avoid printing over areas that have overlapping seams on the reverse side. Printing on seams can cause problems. • If background scatter covers the entire surface area of a printed page, adjust the print resolution through your software application or in Printing Preferences. (See "Opening Printing Preferences" on page 47.)
<p>Misformed characters</p> 	<ul style="list-style-type: none"> • If characters are improperly formed and producing hollow images, the paper stock may be too slick. Try different paper. (See "Print media specifications" on page 126.) • If characters are improperly formed and producing a wavy effect, the scanner unit may need service. (See "Cleaning the scan unit" on page 99.)

CONDITION	SUGGESTED SOLUTIONS
<p>Page skew</p> 	<ul style="list-style-type: none"> • Ensure that the paper is loaded properly. • Check the paper type and quality. (See "Print media specifications" on page 126.) • Ensure that the guides are not too tight or too loose against the paper stack.
<p>Curl or wave</p> 	<ul style="list-style-type: none"> • Ensure that the paper is loaded properly. • Check the paper type and quality. Both high temperature and humidity can cause paper curl. (See "Print media specifications" on page 126.) • Turn the stack of paper over in the tray. Also try rotating the paper 180° in the tray.
<p>Wrinkles or creases</p> 	<ul style="list-style-type: none"> • Ensure that the paper is loaded properly. • Check the paper type and quality. (See "Print media specifications" on page 126.) • Turn the stack of paper over in the tray. Also try rotating the paper 180° in the tray.
<p>Back of printouts are dirty</p> 	<p>Check for leaking toner. Clean the inside of the machine. (See "Cleaning the inside" on page 99.)</p>
<p>Solid Color or Black pages</p> 	<ul style="list-style-type: none"> • The toner cartridge may not be installed properly. Remove the cartridge and reinsert it. • The toner cartridge may be defective. Remove the toner cartridge and install a new one. (See "Replacing the toner cartridge" on page 119.) • The machine may require repair. Contact a service representative.

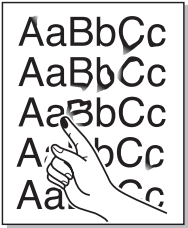
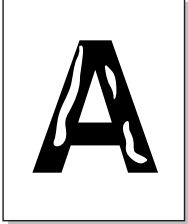
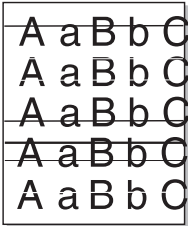
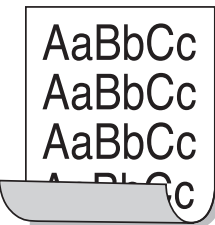
CONDITION	SUGGESTED SOLUTIONS
<p>Loose toner</p> 	<ul style="list-style-type: none"> • Clean the inside of the machine. (See "Cleaning the inside" on page 99.) • Check the paper type and quality. (See "Print media specifications" on page 126.) • Remove the toner cartridge and then, install a new one. (See "Replacing the toner cartridge" on page 119.) • If the problem persists, the machine may require repair. Contact a service representative.
<p>Character Voids</p> 	<p>Character voids are white areas within parts of characters that should be solid black:</p> <ul style="list-style-type: none"> • If you are using transparencies, try another type of transparency. Because of the composition of transparencies, some character voids are normal. • You may be printing on the wrong surface of the paper. Remove the paper and turn it around. • The paper may not meet paper specifications. (See "Print media specifications" on page 126.)
<p>Horizontal stripes</p> 	<p>If horizontally aligned black streaks or smears appear:</p> <ul style="list-style-type: none"> • The toner cartridge may be installed improperly. Remove the cartridge and reinsert it. • The toner cartridge may be defective. Remove the toner cartridge and install a new one. (See "Replacing the toner cartridge" on page 119.) • If the problem persists, the machine may require repair. Contact a service representative.
<p>Curl</p> 	<p>If the printed paper is curled or paper does not feed into the machine:</p> <ul style="list-style-type: none"> • Turn the stack of paper over in the tray. Also try rotating the paper 180° in the tray. • Change the printer option and try again. Go to Printing Preferences, click Paper tab, and set type to Thin. (See "Opening Printing Preferences" on page 47.)
<p>An unknown image repeatedly appears on a few sheets or loose toner, light print, or contamination occurs.</p>	<p>Your machine is probably being used at an altitude of 1,500 m (4,921 ft) or above. The high altitude may affect the print quality, such as loose toner or light imaging. Change the correct altitude setting to your machine. (See "Altitude adjustment" on page 33.)</p>

Copying problems

CONDITION	SUGGESTED SOLUTION
<p>Copies are too light or too dark</p>	<p>Use Light and Dark arrows to lighten or darken the backgrounds of copies in the Basic tab of the Copy menu.</p>
<p>Smears, lines, marks, or spots appear on copies.</p>	<ul style="list-style-type: none"> • If the defects are on the original, press Light and Dark arrows to lighten the background of your copies in the Basic tab of the Copy menu. • If there are no defects on the original, clean the scan unit. (See "Cleaning the scan unit" on page 99.)
<p>Copy image is skewed.</p>	<ul style="list-style-type: none"> • Ensure that the original is face down on the scanner glass or face up in the document feeder. • Check that the copy paper is loaded correctly.
<p>Blank copies print out.</p>	<p>Ensure that the original is face down on the scanner glass or face up in the document feeder.</p>
<p>Image rubs off the copy easily.</p>	<ul style="list-style-type: none"> • Replace the paper in the tray with paper from a new package. • In high humidity areas, do not leave paper in the machine for extended periods of time.
<p>Frequent copy paper jams occur.</p>	<ul style="list-style-type: none"> • Fan the stack of paper, then turn it over in the tray. Replace the paper in the tray with a fresh supply. Check/adjust the paper guides, if necessary. • Ensure that the paper is the proper paper weight. • Check for copy paper or pieces of copy paper remaining in the machine after a paper jam has been cleared.
<p>Toner cartridge produces fewer copies than expected before running out of toner.</p>	<ul style="list-style-type: none"> • Your originals may contain pictures, solids, or heavy lines. For example, your originals may be forms, newsletters, books, or other documents that use more toner. • The scanner lid may be left open while copies are being made. • Turn the machine off and back on.

Scanning problems

CONDITON	SUGGESTED SOLUTIONS
The scanner does not work.	<ul style="list-style-type: none"> • Make sure that you place the original to be scanned face down on the scanner glass, or face up in the document feeder. • There may not be enough available memory to hold the document you want to scan. Try the Prescan function to see if that works. Try lowering the scan resolution rate. • Check that the machine cable is connected properly. • Make sure that the machine cable is not defective. Switch the cable with a known good cable. If necessary, replace the cable. • Check that the scanner is configured correctly. Check scan setting in the SmarThru Office or the application you want to use to make certain that the scanner job is being sent to the correct port (for example, USB001).
The unit scans very slowly.	<ul style="list-style-type: none"> • Check if the machine is printing received data. If so, scan the document after the received data has been printed. • Graphics are scanned more slowly than text. • Communication speed slows in scan mode because of the large amount of memory required to analyze and reproduce the scanned image. Set your computer to the ECP printer mode through BIOS setting. It will help to increase the speed. For details about how to set BIOS, refer to your computer user's guide.
Message appears on your computer screen: <ul style="list-style-type: none"> • Device can't be set to the H/W mode you want. • Port is being used by another program. • Port is Disabled. • Scanner is busy receiving or printing data. When the current job is completed., try again. • Invalid handle. • Scanning has failed. 	<ul style="list-style-type: none"> • There may be a copying or printing job in progress. Try your job again when that job is finished. • The selected port is currently being used. Restart your computer and try again. • The machine cable may be improperly connected or the power may be off. • The scanner driver is not installed or the operating environment is not set up properly. • Ensure that the machine is properly connected and the power is on, then restart your computer. • The USB cable may be improperly connected or the power may be off.

Fax problems

CONDITION	SUGGESTED SOLUTIONS
The machine is not working, there is no display, or the buttons are not working.	<ul style="list-style-type: none"> • Unplug the power cord and plug it in again. • Ensure that there is power being supplied to the electrical outlet.
No dial tone.	<ul style="list-style-type: none"> • Check that the phone line is properly connected. • Check that the phone socket on the wall is working by plugging in another phone.
The numbers stored in memory do not dial correctly.	Make sure that the numbers are stored in memory correctly. Print a Fax Phone Book list. (See "Setting up a fax phone book" on page 66.)
The original does not feed into the machine.	<ul style="list-style-type: none"> • Make sure that the paper is not wrinkled and you are inserting it in correctly. Check that the original is the right size, not too thick or thin. • Make sure that the document feeder is firmly closed. • The document feeder rubber pad may need to be replaced. Contact a service representative.
Faxes are not received automatically.	<ul style="list-style-type: none"> • The receiving mode should be set to fax. • Make sure that there is paper in the tray. • Check to see if the display shows any error message. If it does, clear the problem
The machine does not send.	<ul style="list-style-type: none"> • Make sure that the original is loaded in the document feeder or on the scanner glass. • Check the fax machine you are sending to, to see if it can receive your fax.
The incoming fax has blank spaces or is of poor-quality.	<ul style="list-style-type: none"> • The fax machine sending you the fax may be faulty. • A noisy phone line can cause line errors. • Check your machine by making a copy. • The toner cartridge may be empty. Replace the toner cartridge. (See "Replacing the toner cartridge" on page 119.)
Some of the words on an incoming fax are stretched.	The fax machine sending the fax had a temporary document jam.
There are lines on the originals you sent.	Check your scan unit for marks and clean it. (See "Cleaning the scan unit" on page 99.)

CONDITION	SUGGESTED SOLUTIONS
The machine dials a number, but the connection with the other fax machine fails.	The other fax machine may be turned off, out of paper, or cannot answer incoming calls. Speak with the other machine operator and ask her/him to solve out the problem.
Faxes do not store in memory.	There may not be enough memory space to store the fax. If the display indicating the memory status shows, delete any faxes you no longer need from the memory, and then try to store the fax again. Call for service.
Blank areas appear at the bottom of each page or on other pages, with a small strip of text at the top	You may have chosen the wrong paper settings in the user option setting. For details about paper settings. (See "Setting the paper size and type" on page 42.)

Common PostScript problems

The following situations are PS language specific and may occur when several printer languages are used.

PROBLEM	POSSIBLE CAUSE	SOLUTION
PostScript file cannot be printed.	The PostScript driver may not be installed correctly.	<ul style="list-style-type: none"> • Install the PostScript driver. (See "Installing USB connected machine's driver" on page 26, "Installing network connected machine's driver" on page 31.) • Print a configuration page and verify that the PS version is available for printing. • If the problem persists, contact a service representative.
"Limit Check Error" report prints.	The print job was too complex.	You might need to reduce the complexity of the page or install more memory. (See "Installing a memory module" on page 120.)

PROBLEM	POSSIBLE CAUSE	SOLUTION
A PostScript error page prints.	The print job may not be PostScript.	Make sure that the print job is a PostScript job. Check to see whether the software application expected a setup or PostScript header file to be sent to the machine.
The optional tray is not selected in the driver.	The printer driver has not been configured to recognize the optional tray.	Open the PostScript driver properties, select the Device Settings tab, and set the tray option of the Installable Options section to Installed .
When printing a document in Macintosh with Acrobat Reader 6.0 or higher, colors print incorrectly.	The resolution setting in the printer driver may not be matched with the one in Acrobat Reader.	Make sure that the resolution setting in your printer driver matches the one in Acrobat Reader.

Common Windows problems

CONDITION	SUGGESTED SOLUTIONS
"File in Use" message appears during installation.	Exit all software applications. Remove all software from the printer's startup group, then restart Windows. Reinstall the printer driver.
"General Protection Fault", "Exception OE", "Spool 32", or "Illegal Operation" messages appear.	Close all other applications, reboot Windows and try printing again.
"Fail To Print", "A printer timeout error occurred" messages appear.	These messages may appear during printing. Just keep waiting until the machine finishes printing. If the message appears in standby mode or after printing has been completed, check the connection and/or whether an error has occurred.



Refer to Microsoft Windows User's Guide that came with your computer for further information on Windows error messages.

Common Linux problems

CONDITION	SUGGESTED SOLUTIONS
The machine does not print.	<ul style="list-style-type: none"> • Check if the printer driver is installed in your system. Open Unified Driver Configurator and switch to the Printers tab in Printers configuration window to look at the list of available machines. Make sure that your machine is displayed on the list. If not, open Add new printer wizard to set up your device. • Check if the machine is started. Open Printers configuration and select your machine on the printers list. Look at the description in the Selected printer pane. If its status contains Stopped string, press the Start button. After that normal operation of the machine should be restored. The “stopped” status might be activated when some problems in printing occurred. For instance, this could be an attempt to print a document when the port is claimed by a scanning application. • Ensure the port is not busy. Since functional components of machine (printer and scanner) share the same I/O interface (port), the situation of simultaneous access of different “consumer” applications to the same port is possible. To avoid possible conflicts, only one of them at a time is allowed to gain control over the device. The other “consumer” will encounter “device busy” response. You should open ports configuration and select the port assigned to your machine. In the Selected port pane you can see if the port is occupied by some other application. If this is the case, you should either wait for completion of the current job or press the Release port button, if you are sure that the present application is not functioning properly. • Check if your application has special print option such as “-oraw”. If “-oraw” is specified in the command line parameter, then remove it to print properly. For Gimp front-end, select “print” -> “Setup printer” and edit command line parameter in the command item. • The CUPS (Common Unix Printing System) version distributed with SuSE Linux 9.2 (cups-1.1.21) has a problem with ipp (Internet Printing Protocol) printing. Use the socket printing instead of ipp or install a later version of CUPS (cups-1.1.22 or higher).

CONDITION	SUGGESTED SOLUTIONS
Some color images come out all black.	This is a known bug in Ghostscript (until GNU Ghostscript version 7.05) when the base color space of the document is indexed color space and is converted through CIE color space. Because Postscript uses CIE color space for Color Matching System, you should upgrade Ghostscript on your system to at least GNU Ghostscript version 7.06 or later. You can find recent Ghostscript versions at www.ghostscript.com .
Some color images come out in unexpected colors.	This is a known bug in Ghostscript (until GNU Ghostscript version 7.xx) when the base color space of the document is indexed RGB color space and it is converted through CIE color space. Because Postscript uses CIE color space for Color Matching System, you should upgrade Ghostscript on your system to at least GNU Ghostscript version 8.xx or later. You can find recent Ghostscript versions at www.ghostscript.com .
The machine does not print whole pages, and output is printed on half the page.	It is a known problem that occurs when a color machine is used on version 8.51 or earlier of Ghostscript, 64-bit Linux OS, and has been reported to bugs.ghostscript.com as Ghostscript Bug 688252. The problem is solved in AFPL Ghostscript v. 8.52 or above. Download the latest version of AFPL Ghostscript from http://sourceforge.net/projects/ghostscript/ and install it to solve this problem.
I cannot scan via Gimp Front-end.	Check if Gimp Front-end has Xsane: Device dialog . on the Acquire menu. If not, you should install Xsane plug-in for Gimp on the your computer. You can find Xsane plug-in package for Gimp on Linux distribution CD or Gimp home page. For the detailed information, refer to the Help for Linux distribution CD or Gimp Front-end application. If you wish to use another kind of scan application, refer to application’s Help.
I encounter error “Cannot open port device file” when printing a document.	Avoid changing print job parameters (via LPR GUI, for example) while a print job is in progress. Known versions of CUPS server break the print job whenever print options are changed and then try to restart the job from the beginning. Since Unified Linux Driver locks the port while printing, the abrupt termination of the driver keeps the port locked and unavailable for subsequent print jobs. If this situation occurs, try to release the port by selecting Release port in Port configuration window.

CONDITION	SUGGESTED SOLUTIONS
The machine does not appear on the scanners list.	<ul style="list-style-type: none"> • Ensure your machine is attached to your computer, connected properly via the USB port, and is turned on. • Ensure the scanner driver for your machine is installed in your system. Open Unified Linux Driver configurator, switch to Scanners configuration, then press Drivers. Make sure that driver with a name corresponding to your machine's name is listed in the window. • Ensure the port is not busy. Since functional components of machine (printer and scanner) share the same I/O interface (port), the situation of simultaneous access of different “consumer” applications to the same port is possible. To avoid possible conflicts, only one of them at a time is allowed to gain control over the device. The other “consumer” will encounter “device busy” response. This usually happens when starting a scan procedure. An appropriate message box appears. To identify the source of the problem, open the Ports configuration and select the port assigned to your scanner, port's symbol /dev/mfp0 corresponds to LP:0 designation displayed in the scanners' options, /dev/mfp1 relates to LP:1, and so on. USB ports start at /dev/mfp4, so scanner on USB:0 relates to /dev/mfp4 respectively and so forth sequentially. In the Selected port pane, you can see if the port is occupied by another application. If this is the case, you should either wait for completion of the current job or press the Release port button, if you are sure that the present port applicaton is not functioning properly.
The machine does not scan.	<ul style="list-style-type: none"> • Ensure a document is loaded into the machine, ensure your machine is connected to the computer. • If there is an I/O error while scanning.

 Refer to Linux User's Guide that came with your computer for further information on Linux error messages.

Common Macintosh problems

CONDITION	SUGGESTED SOLUTIONS
The machine does not print PDF files correctly. Some parts of graphics, text, or illustrations are missing.	<p>Printing the PDF file as an image may enable the file to print. Turn on Print As Image from the Acrobat printing options.</p> <p> It will take longer to print when you print a PDF file as an image.</p>
The document has printed, but the print job has not disappeared from the spooler in Mac OS X10.3.2.	Update your MAC OS to OS MAC OS X 10.3.3. or higher.
Some letters are not displayed normally during the cover page printing.	Mac OS cannot create the font during the cover page printing. The English alphabet and numbers are displayed normally on the cover page.
When printing a document in Macintosh with Acrobat Reader 6.0 or higher, colors print incorrectly.	Make sure that the resolution setting in your machine driver matches the one in Acrobat Reader.

 Refer to Macintosh User's Guide that came with your computer for further information on Macintosh error messages.

supplies and accessories

This chapter provides information on purchasing supplies, accessories and maintenance parts available for your machine.

This chapter includes:

- How to purchase
- Available supplies
- Available accessories
- Available maintenance parts
- Replacing the toner cartridge

 Available accessories may differ from country to country. Contact your sales representatives to obtain the list of available accessories.

HOW TO PURCHASE

To order Samsung-authorized supplies, accessories and, maintenance parts, contact your local Samsung dealer or the retailer where you purchased your machine. You can also visit www.samsung.com/supplies, select your country/region, and obtain information on calling for service.

AVAILABLE SUPPLIES

When supplies reach their lifespan, you can order the following types of supplies for your machine:

TYPE	AVERAGE YIELD ^A	PART NAME
Standard yield	Approx. 4,000 pages	<ul style="list-style-type: none">• MLT-D208S• Region A^b: MLT-D2082S• Region B^c: MLT-D206S
High yield	Approx. 10,000 pages	<ul style="list-style-type: none">• MLT-D208L• Region A^b: MLT-D2082L• Region B^c: MLT-D206L

a. Declared yield value in accordance with ISO/IEC 19752.

b. Region A: Albania, Austria, Belgium, Bosnia, Bulgaria, Croatia, Cyprus, Czech Republic, Denmark, Finland, France, Germany, Greece, Hungary, Italy, Macedonia, Netherlands, Norway, Poland, Portugal, Romania, Serbia, Slovakia, Slovenia, Spain, Sweden, Switzerland, UK.

c. Region B (only SCX-5935NX): U.S.A., Canada

To replace a toner cartridge: (See "Replacing the toner cartridge" on page 119.)

 Depending on the options and job mode used, the toner cartridge's lifespan may differ.

 You must purchase supplies, including toner cartridges, in the same country where you purchased your machine. Otherwise, supplies will be incompatible with your machine since the system configuration of these vary from country to country.

- Necessary precautions to take when installing accessories
- Upgrading a memory module
- Checking replaceable's lifespan
- Replacing the document feeder rubber pad

AVAILABLE ACCESSORIES

You can purchase and install accessories to enhance your machine's performance and capacity.

ACCESSORY	FUNCTION	PART NAME
Memory module	Extend your machine's memory capacity.	CLP-MEM202: 256 MB
Optional tray 2	If you are experiencing frequent paper supply problems, you can attach an additional 500 sheet tray. You can print documents in various sizes and types of print materials.	SCX-S5835A
SmarThru Workflow	Windows 2000/XP/2003. This feature lets you send additional information along with the scanned document to a specified network location.	SOL-STWFV2

AVAILABLE MAINTENANCE PARTS

To avoid print quality and paper feed problems resulting from worn parts and to maintain your machine in top working condition, the following parts will need to be replaced after printing the specified number of pages or when the life span of each item has expired.

PARTS	AVERAGE YIELD ^A	PART NAME
Document feeder rubber pad	Approx. 50,000 pages	RMO ADF RUBBER
Transfer roller	Approx. 100,000 pages	ROLLER-TRANSFER
Fuser unit	Approx. 100,000 pages	ELA UNIT-FUSER
Tray rubber pad	Approx. 100,000 pages	RPR-PAD CASSETTE
Pickup roller	Approx. 150,000 pages	ROLLER-PICK UP

a. It will be affected by operating system used, computing performance, application software, connecting method, media type, media size and job complexity.

To purchase maintenance parts, contact the source where you bought the machine.

Replacing maintenance parts can be performed only by an authorized service provider, dealer, or the retailer where you bought the machine. The warranty does not cover the replacement of any maintenance parts after their lifespan.

REPLACING THE TONER CARTRIDGE

 Click this link to open an animation about replacing a toner cartridge.

When the toner cartridge is completely empty:

- **End of life, Replace with new toner cartridge** appears on the display.
- The machine stops printing. Incoming faxes are saved in memory.

At this stage, the toner cartridge needs to be replaced. Check the type of the toner cartridge for your machine. (See "Available supplies" on page 118.)

1. Open the front cover.
2. Pull the toner cartridge out.

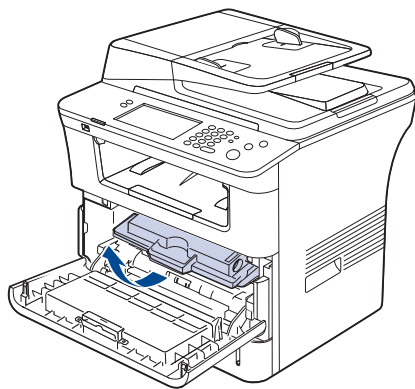

3. Remove the new toner cartridge from its bag.

4. Slowly shake the cartridge five or six times to distribute the toner evenly inside the cartridge. It will assure maximum copies per cartridge.

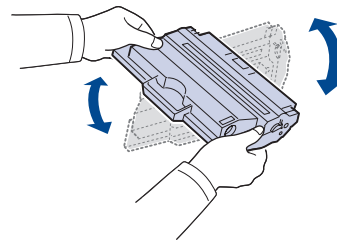

 If toner gets on your clothing, wipe it off with a dry cloth and wash clothing in cold water. Hot water sets toner into fabric.

 Do not touch the green underside of the toner cartridge. Use the handle on the cartridge to avoid touching this area.

5. Hold the toner cartridge by the handle and slowly insert the cartridge into the opening in the machine.

Tabs on the sides of the cartridge and corresponding grooves within the machine will guide the cartridge into the correct position until it locks into place completely.

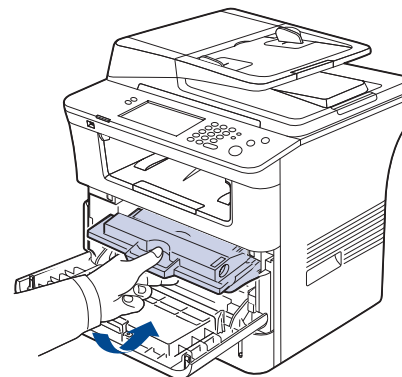

6. Close the front cover. Make sure that the cover is securely closed.

NECESSARY PRECAUTIONS TO TAKE WHEN INSTALLING ACCESSORIES

- Disconnect the power cord.
Never remove the control board cover while the power is turned on. To avoid the possibility of an electrical shock, always disconnect the power cord when installing or removing ANY internal or external accessories.
- Discharge static electricity.
The control board and internal accessories (network interface card or memory module) are sensitive to static electricity. Before installing or removing any internal accessories, discharge static electricity from your body by touching something metal, such as the metal back plate on any device plugged into a grounded power source. If you walk around before finishing the installation, repeat this procedure to discharge any static electricity again.
- Activating the added accessories in the PS driver properties.
After installing an accessory such as an optional tray, PS driver users must do the additional setting. Go to the PS printer properties and set the added accessory activated.

-  When installing accessories, the battery inside the machine is a service component. Do not change it by yourself. There is a risk of an explosion if battery is replaced by an incorrect type. Dispose used batteries according to the instructions.

UPGRADING A MEMORY MODULE

Your machine has a dual in-line memory module (DIMM). Use this memory module slot to install additional memory.

The machine has two memory slots with a factory pre-installed memory module in one slot. When you are expanding the memory capacity, you can add a memory module to the vacant memory slot. It is strongly recommended that you expand a memory module in the vacant memory slot, and not by removing a pre-installed memory module. If your machine has 256 MB memory capacity and you want to add 256 MB, the memory capacity expands up to 512 MB. Order information is provided for additional memory module. (See "Available accessories" on page 118.)

Installing a memory module

1. Turn the machine off and unplug all cables from the machine.
2. Grasp the control board cover and remove it.

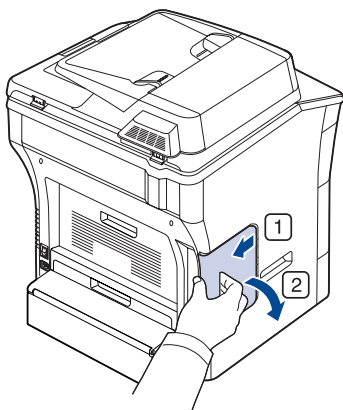

3. Remove the new memory module from its bag.
4. Holding the memory module by the edges, align the memory module on the slot at about a 30-degree tilt. Make sure that the notches of the module and the grooves on the slot fit each other.

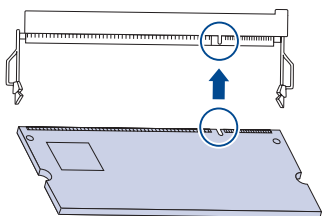

 The notches and grooves illustrated above may not match those on an actual memory module and its slot.

5. Press the memory module into the slot with care until you hear a 'click'.
-  Do not press the memory module strongly or the module may be damaged. If the module does not seem to fit into the slot properly, carefully try the previous procedure again.

6. Close the control board cover by aligning the groove on it with the notch on the machine and sliding it.

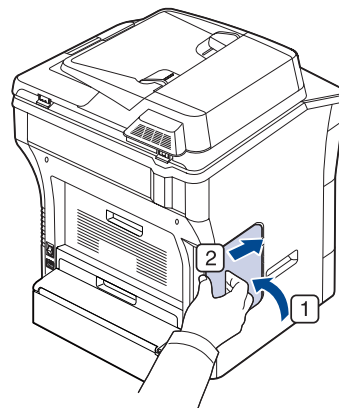

7. Reconnect the power cord and machine cable. Turn on the machine.

 If you use the PS driver, you must activate the added memory in the PS driver properties.

Activating the added accessories in PS printer properties

After installing the memory module, you need to select it in the printer properties of the PostScript printer driver in order to use it.

1. Install the PS Driver. (See "Installing USB connected machine's driver" on page 26, "Installing network connected machine's driver" on page 31.)
2. Click the Windows **Start** menu.
 - For Windows 2000, select **Settings > Printers**.
 - For Windows XP/2003, select **Printers and Faxes**.
 - For Windows Vista, select **Control Panel > Hardware and Sound > Printers**.
3. Select the your machine's PS driver and right-click to open **Properties**.
4. Select **Device Settings**.
5. Select the **Installable Options** section and set the necessary options.
6. Click **OK**.

CHECKING REPLACEABLE'S LIFESPAN

If you experience frequent paper jams or printing problems, check the number of pages the machine has printed. Replace the corresponding parts, if necessary.

1. Press **Machine Setup** on the control panel.
2. Press **Machine Status > the Supplies Life** tab.

REPLACING THE DOCUMENT FEEDER RUBBER PAD

You will need to replace the document feeder rubber pad when there seems to be a consistent problem with paper pickup or when its specified yield is reached.

1. Open the document feeder cover.
2. Remove the document feeder rubber pad from the document feeder, as shown below.

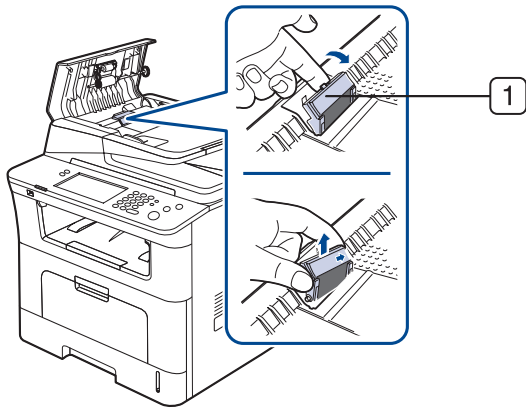

**1 Document
feeder rubber
pad**

3. Insert a new document feeder rubber pad into place.
4. Close the document feeder cover.

specifications

This chapter guides you about this machine's specifications such as various features.

This chapter include:

- General specifications
- Printer specifications
- Scanner specifications
- Copier specifications
- Facsimile specifications
- Print media specifications

GENERAL SPECIFICATIONS

 The symbol * optional feature depending on machines.

ITEM	DESCRIPTION	
Document feeder^a Capacity	Up to 50 sheets 80 g/m ² (20 lb bond)	
Document feeder document size	Width: 142 to 216 mm (5.6 x 8.5 inches)/ Length: 148 to 356 mm (5.8 x 14 inches)	
Paper input capacity	<ul style="list-style-type: none">• Tray: 500 sheets for plain paper, 80 g/m² (20 lb bond)• Multi-purpose tray: 50 sheets for plain paper, 80 g/m² (20 lb bond)• Optional tray: 500 sheets for plain paper, 80 g/m² (20 lb bond) (See "Print media specifications" on page 126.)	
Paper output capacity	Face down: 250 sheets 80 g/m ² (20 lb bond)	
Power rating	AC 110 - 127 V or AC 220 - 240 V See the Rating label on the machine for the correct voltage, frequency (hertz) and type of current for your machine.	
Power consumption	<ul style="list-style-type: none">• Average operating mode: Less than 750 W• Ready mode: Less than 100 W• Power Save mode: Less than 25 W• Power off mode: 0 W	
Noise Level^b	<ul style="list-style-type: none">• Ready mode: 39 dB(A)• Printing mode: 52 dB(A)• Copying mode: 54 dB(A)	
Default time to power save mode from ready mode	30 Minutes	
Boot-up time^c	Less than 50 seconds The boot-up time will be longer, if data volume is a lot in the HDD	
Operating environment	Temperature: 10 to 32 °C (50 to 89.6 °F) Humidity: 20 to 80% RH	
Display	WVGA (800 x 480 x RGV) color	
Toner cartridge life^d	Standard yield	Average Cartridge Yield 4,000 standard pages. Declared yield value in accordance with ISO/IEC (Shipped with 4,000 pages Starter toner cartridge.) ^e
	High yield	Average Cartridge Yield 10,000 standard pages. Declared yield value in accordance with ISO/IEC
Memory (Expandable)*	256 MB (Max. 512 MB)	

ITEM	DESCRIPTION
External dimension (W x D x H)	500 x 465 x 547 mm (19.7 x 18.3 x 21.5 inches) without optional tray
Weight (Including consumables)	23.1 Kg (50.88 lbs)
Package weight	Paper: 2.9 Kg (6.29 lbs) Plastic: 1.9 Kg (4.17 lbs)
Duty cycle	Up to 80,000 pages (Monthly)
Fusing temperature	180 °C (356 °F)

a. Document feeder is synonymous with DADF.

b. Sound Pressure Level, ISO 7779. Configuration tested: machine basic installation, A4 paper, simplex printing.

c. Boot-up time is the time that takes from the power switch on to the ready mode.

d. Declared yield value in accordance with ISO/IEC 19752. The number of pages may be affected by operating environment, printing interval, media type, and media size.

e. It varies depending on the product configuration.

PRINTER SPECIFICATIONS

ITEM	DESCRIPTION
Printing method	Laser beam printing
Printing speed^a	Up to 33 ppm (A4), 35 ppm (Letter)
Duplex printing speed	Up to 17 ipm (A4), 18 ipm (Letter)
First print out time	8.5 seconds (from ready)
Print resolution	Up to 1,200 x 1,200 dpi effective output
Printer language	PCL5e, PCL6, PostScript 3, PDF1.4, TIFF, Epson/ IBM Pro (Israel only)
OS compatibility^b	<ul style="list-style-type: none"> Windows: 2000/XP/2003/Vista/2008 Various Linux OS (See "Linux" on page 26.) Macintosh: Mac OS X 10.3~10.5
Interface	<ul style="list-style-type: none"> High speed USB 2.0 Ethernet 10/100 Base TX (Embedded type)

a. It will be affected by operating system used, computing performance, application software, connecting method, media type, media size and job complexity.

b. Visit www.samsungprinter.com to download the latest software version.

SCANNER SPECIFICATIONS

ITEM	DESCRIPTION	
Compatibility	TWAIN standard/WIA standard	
Scanning method	Color CCD	
Resolution^a	TWAIN standard	Up to 600 x 600 dpi (Up to 4,800 x 4,800 dpi by software enhancement)
	WIA standard	Up to 600 x 600 dpi
	Scan to USB	100, 200, 300 dpi
	Scan to Email Scan to Server	100, 200, 300, 400, 600 dpi
Network Scan File format	PDF, TIFF, JPEG ^b	
Effective scanning length	Scanner glass: 289 mm (11.38 inches) Document feeder: 348 mm (13.7 inches)	
Effective scanning width	Max. 208 mm (8.2 inches)	
Color bit depth	Internal: 36 bit External: 24 bit	
Mono bit depth	1 bit for lineart & halftone 8 bit for gray scale	

a. Due to the applications for scanning, the maximum resolution might differ.

b. JPEG is not available when you select the mono mode in scan color.

COPIER SPECIFICATIONS

ITEM	DESCRIPTION	
Copy Speed^a	Up to 33 cpm (A4), 35 cpm (Letter)	
Duplex copy speed	Simplex to Duplex (1-2): Up to 17 ipm in A4 (18 ipm in Letter) Duplex to Duplex (2-2): Up to 13 ipm in A4 (14 ipm in Letter)	
First copy out time	Scanner glass: 9.5 seconds (from ready) Document feeder: 11.5 seconds (from ready)	
Copy resolution	Text	Scanner glass: Up to 600 x 600 dpi Document feeder: Up to 300 x 300 dpi
	Text/photo	Scanner glass: Up to 600 x 600 dpi Document feeder: Up to 300 x 300 dpi
	Photo	Scanner glass: Up to 600 x 600 dpi Document feeder: Up to 300 x 300 dpi
Zoom range	Scanner glass: 25% to 400% Document feeder: 25% to 200%	

a. Copy speed is based on Single Document Multiple Copy.

FACSIMILE SPECIFICATIONS

 The fax feature may not be supported depending on machines.

ITEM	DESCRIPTION
Compatibility	ITU-T G3
Applicable line	Public Switched Telephone Network (PSTN) or behind PABX
Data coding	MH/MR/MMR/JBIG/JPEG (Tx only)
Modem speed	33.6 Kbps
Transmission speed	Up to 3 seconds/page ^a
Maximum document length	356 mm (14 inches)
Resolution	<ul style="list-style-type: none">• Standard: 203 x 98 dpi• Fine: 203 x 196 dpi• Super Fine: 300 x 300 dpi (Rx^b only)
Memory	HDD Backup (Receive: 2,000 pages, Send: 500 pages)
Halftone	256 levels
Auto dialer	up to 200 numbers

a. Standard resolution, MMR(JBIG), Maximum modem speed, Phase "C" by ITU-T No. 1 chart, Memory Tx, ECM.

b. Rx stands for receiving a fax.

PRINT MEDIA SPECIFICATIONS

TYPE	SIZE	DIMENSIONS	PRINT MEDIA WEIGHT ^A /CAPACITY ^B	
			TRAY1 / OPTIONAL TRAY	MULTIPURPOSE TRAY
Plain paper	Letter	216 x 279 mm (8.5 x 11 inches)	75 to 90 g/m ² (20 to 24 lb bond) • 500 sheets of 80g/m ² (20 lb bond)	60 to 163 g/m ² (16 to 43 lb bond) • 50 sheets of 80 g/m ² (20 lb bond)
	Legal	216 x 356 mm (8.5 x 14 inches)		
	US Folio	216 x 330 mm (8.5 x 13 inches)		
	A4	210 x 297 mm (8.26 x 11.69 inches)		
	Oficio	216 x 343 mm (8.5 x 13.5 inches)		
	JIS B5	182 x 257 mm (7.16 x 10.11 inches)	75 to 90 g/m ² (20 to 24 lb bond) • 250 sheets of 80 g/m ² (20 lb bond)	
	ISO B5	176 x 250 mm (6.93 x 9.84 inches)		
	Executive	184 x 267 mm (7.25 x 10.5 inches)		
	A5	148 x 210 mm (5.82 x 8.26 inches)		
	Statement	140 x 216 mm (5.5 x 8.5 inches)	Not available in tray1 / optional trays.	
	A6	105 x 148 mm (4.13 x 5.82 inches)		
Envelope	Envelope Monarch	98 x 191 mm (3.87 x 7.5 inches)	Not available in tray1 / optional trays.	75 to 90 g/m ² (20 to 24 lb bond) • 5 sheets stacking
	Envelope No. 10	105 x 241 mm (4.12 x 9.5 inches)		
	Envelope DL	110 x 220 mm (4.33 x 8.66 inches)		
	Envelope C5	162 x 229 mm (6.37 x 9.01 inches)		
	Envelope C6	114 x 162 mm (4.48 x 6.38 inches)		
Thick paper	Refer to the Plain paper section	Refer to the Plain paper section	90 to 105 g/m ² (24 to 28 lb bond) • 350 sheets stacking	90 to 105 g/m ² (24 to 28 lb bond) • 20 sheets stacking
Thin paper	Refer to the Plain paper section	Refer to the Plain paper section	60 to 70 g/m ² (16 to 19 lb bond) • 500 sheets stacking	60 to 70 g/m ² (16 to 19 lb bond) • 50 sheets stacking
Transparency	Refer to the Plain paper section	Refer to the Plain paper section	Not available in tray1 / optional trays.	138 to 146 g/m ² (36.81 to 38.91 lb bond) • 5 sheets stacking
Labels ^c	Letter, Legal, US Folio, A4, JIS B5, ISO B5, Executive, A5, Statement	Refer to the Plain paper section	Not available in tray1 / optional trays.	120 to 150 g/m ² (32 to 40 lb bond) • 5 sheets stacking
Card stock	Letter, Legal, US Folio, A4, JIS B5, ISO B5, Executive, A5, Statement, PostCard 4 x 6	Refer to the Plain paper section	Not available in tray1 / optional trays.	105 to 163 g/m ² (28 to 43lb bond) • 5 sheets stacking
Minimum size (custom)		76.2 x 127 mm (3 x 5 inches)	60 to 163 g/m ² (16 to 43 lb bond)	
Maximum size (custom)		216 x 356 mm (8.5 x 14 inches)		

a. If media weight is over 105 g/m² (28 lb bond), load a paper into the tray one by one.

b. Maximum capacity may differ depending on media weight, thickness, and environmental conditions.

c. Smoothness: 100 to 250 (sheffield)

contact samsung worldwide

If you have any comments or questions regarding Samsung products, contact the Samsung customer care center.

COUNTRY/REGION	CUSTOMER CARE CENTER	WEB SITE
ARGENTINE	0800-333-3733	www.samsung.com
ARMENIA	0-800-05-555	
AUSTRALIA	1300 362 603	www.samsung.com
AUSTRIA	0810-SAMSUNG (7267864, € 0.07/min)	www.samsung.com
AZERBAIJAN	088-55-55-555	
BAHRAIN	8000-4726	
BELARUS	810-800-500-55-500	www.samsung.ua www.samsung.com/ua_ru
BELGIUM	02-201-24-18	www.samsung.com/be (Dutch) www.samsung.com/be_fr (French)
BRAZIL	0800-124-421 4004-0000	www.samsung.com
CANADA	1-800-SAMSUNG (726-7864)	www.samsung.com
CHILE	800-SAMSUNG (726-7864)	www.samsung.com
CHINA	400-810-5858 010-6475 1880	www.samsung.com
COLOMBIA	01-8000112112	www.samsung.com
COSTA RICA	0-800-507-7267	www.samsung.com
CZECH REPUBLIC	800-SAMSUNG (800-726786) Samsung Zrt., česká organizační složka, Oasis Florenc, Sokolovská394/17, 180 00, Praha 8	www.samsung.com
DENMARK	70 70 19 70	www.samsung.com
ECUADOR	1-800-10-7267	www.samsung.com
EGYPT	0800-726786	
EIRE	0818 717100	www.samsung.com
EL SALVADOR	800-6225	www.samsung.com
ESTONIA	800-7267	www.samsung.com
KAZAKHSTAN	8-10-800-500-55-500	www.samsung.com/kz_ru
KYRGYZSTAN	00-800-500-55-500	
FINLAND	030-6227 515	www.samsung.com
FRANCE	01 48 63 00 00	www.samsung.com

COUNTRY/REGION	CUSTOMER CARE CENTER	WEB SITE
GERMANY	01805 - SAMSUNG (726-7864 € 0,14/min)	www.samsung.com
GEORGIA	8-800-555-555	
GUATEMALA	1-800-299-0013	www.samsung.com
HONDURAS	800-7919267	www.samsung.com
HONG KONG	(852) 3698-4698	www.samsung.com/hk www.samsung.com/hk_en/
HUNGARY	06-80-SAMSUNG (726-7864)	www.samsung.com
INDIA	3030 8282 1800 110011 1800 3000 8282 1800 266 8282	www.samsung.com
INDONESIA	0800-112-8888 021-5699-7777	www.samsung.com
ITALIA	800-SAMSUNG (726-7864)	www.samsung.com
JAMAICA	1-800-234-7267	www.samsung.com
JAPAN	0120-327-527	www.samsung.com
JORDAN	800-22273	
KSA	9200-21230	www.samsung.com
BAHRAIN	8000-4726	
LATVIA	8000-7267	www.samsung.com
LITHUANIA	8-800-77777	www.samsung.com
LUXEMBURG	261 03 710	www.samsung.com
MALAYSIA	1800-88-9999	www.samsung.com
MEXICO	01-800-SAMSUNG (726-7864)	www.samsung.com
MOLDOVA	00-800-500-55-500	www.samsung.ua www.samsung.com/ua_ru
NETHERLANDS	0900-SAMSUNG (0900-7267864) (€ 0,10/min)	www.samsung.com
NEW ZEALAND	0800 SAMSUNG (0800 726 786)	www.samsung.com
NICARAGUA	00-1800-5077267	www.samsung.com
NORWAY	815-56 480	www.samsung.com
PANAMA	800-7267	www.samsung.com

COUNTRY/REGION	CUSTOMER CARE CENTER	WEB SITE
PHILIPPINES	1800-10-SAMSUNG (726-7864) 1-800-3-SAMSUNG (726-7864) 1-800-8-SAMSUNG (726-7864) 02-5805777	www.samsung.com
POLAND	0 801 1SAMSUNG (172678) 022-607-93-33	www.samsung.com
PORTUGAL	80820-SAMSUNG (726-7864)	www.samsung.com
PUERTO RICO	1-800-682-3180	www.samsung.com
QATAR	800-2255	
REP. DOMINICA	1-800-751-2676	www.samsung.com
RUSSIA	8-800-555-55-55	www.samsung.ru
SINGAPORE	1800-SAMSUNG (726-7864)	www.samsung.com
SLOVAKIA	0800-SAMSUNG (726-7864)	www.samsung.com
SOUTH AFRICA	0860 SAMSUNG (726-7864)	www.samsung.com
SPAIN	902-1-SAMSUNG(902 172 678)	www.samsung.com
SWEDEN	0771 726 7864 (SAMSUNG)	www.samsung.com
SWITZERLAND	0848-SAMSUNG (7267864, CHF 0.08/min)	www.samsung.com
SYRIA	1825-22-73	
TADJIKISTAN	8-10-800-500-55-500	
TAIWAN	0800-329-999	www.samsung.com
THAILAND	1800-29-3232 02-689-3232	www.samsung.com
TRINIDAD & TOBAGO	1-800-SAMSUNG (726-7864)	www.samsung.com
TURKEY	444 77 11	www.samsung.com
U.A.E	800-SAMSUNG (726-7864)	www.samsung.com
U.K	0845 SAMSUNG (726-7864)	www.samsung.com
U.S.A	1-800-SAMSUNG (726-7864)	www.samsung.com
UKRAINE	8-800-502-000	www.samsung.ua www.samsung.com/ua_ru

COUNTRY/REGION	CUSTOMER CARE CENTER	WEB SITE
UZBEKISTAN	8-10-800-500-55-500	www.samsung.com/kz_ru
VENEZUELA	0-800-100-5303	www.samsung.com
VIETNAM	1 800 588 889	www.samsung.com

glossary

 The following glossary helps you get familiar with the product by understanding the terminologies commonly used with printing as well as mentioned in this user's guide.

802.11

802.11 is a set of standards for wireless local area network (WLAN) communication, developed by the IEEE LAN/MAN Standards Committee (IEEE 802).

802.11b/g

802.11b/g can share same hardware and use the 2.4 GHz band. 802.11b supports bandwidth up to 11 Mbps; 802.11g up to 54 Mbps. 802.11b/g devices may occasionally suffer interference from microwave ovens, cordless telephones, and Bluetooth devices.

Access point

Access Point or Wireless Access Point (AP or WAP) is a device that connects wireless communication devices together on wireless local area networks (WLAN), and acts as a central transmitter and receiver of WLAN radio signals.

ADF

An Automatic Document Feeder (ADF) is a mechanism that will automatically feed an original sheet of paper so that the machine can scan some amount of the paper at once.

AppleTalk

AppleTalk is a proprietary suite of protocols developed by Apple, Inc for computer networking. It was included in the original Macintosh (1984) and is now deprecated by Apple in favor of TCP/IP networking.

BIT Depth

A computer graphics term describing the number of bits used to represent the color of a single pixel in a bitmapped image. Higher color depth gives a broader range of distinct colors. As the number of bits increases, the number of possible colors becomes impractically large for a color map. 1-bit color is commonly called as monochrome or black and white.

BMP

A bitmapped graphics format used internally by the Microsoft Windows graphics subsystem (GDI), and used commonly as a simple graphics file format on that platform.

BOOTP

Bootstrap Protocol. A network protocol used by a network client to obtain its IP address automatically. This is usually done in the bootstrap process of computers or operating systems running on them. The BOOTP servers assign the IP address from a pool of addresses to each client. BOOTP enables 'diskless workstation' computers to obtain an IP address prior to loading any advanced operating system.

CCD

Charge Coupled Device (CCD) is a hardware which enables the scan job. CCD Locking mechanism is also used to hold the CCD module to prevent any damage when you move the machine.

Collation

Collation is a process of printing a multiple-copy job in sets. When collation is selected, the device prints an entire set before printing additional copies.

Control Panel

A control panel is a flat, typically vertical, area where control or monitoring instruments are displayed. They are typically found in front of the machine.

Coverage

It is the printing term used for a toner usage measurement on printing. For example, 5% coverage means that an A4 sided paper has about 5% image or text on it. So, if the paper or original has complicated images or lots of text on it, the coverage will be higher and at the same time, a toner usage will be as much as the coverage.

CSV

Comma Separated Values (CSV). A type of file format, CSV is used to exchange data between disparate applications. The file format, as it is used in Microsoft Excel, has become a pseudo standard throughout the industry, even among non-Microsoft platforms.

DADF

A Duplex Automatic Document Feeder (DADF) is a mechanism that will automatically feed and flip over an original sheet of paper so that the machine can scan on both sides of the paper.

Default

The value or setting that is in effect when taking a printer out of its box state, reset, or initialized.

DHCP

A Dynamic Host Configuration Protocol (DHCP) is a client-server networking protocol. A DHCP server provides configuration parameters specific to the DHCP client host requesting, generally, information required by the client host to participate on an IP network. DHCP also provides a mechanism for allocation of IP addresses to client hosts.

DIMM

Dual Inline Memory Module (DIMM), a small circuit board that holds memory. DIMM stores all the data within the machine like printing data, received fax data.

DNS

The Domain Name Server (DNS) is a system that stores information associated with domain names in a distributed database on networks, such as the Internet.

Dot Matrix Printer

A dot matrix printer refers to a type of computer printer with a print head that runs back and forth on the page and prints by impact, striking an ink-soaked cloth ribbon against the paper, much like a typewriter.

DPI

Dots Per Inch (DPI) is a measurement of resolution that is used for scanning and printing. Generally, higher DPI results in a higher resolution, more visible detail in the image, and a larger file size.

DRPD

Distinctive Ring Pattern Detection. Distinctive Ring is a telephone company service which enables a user to use a single telephone line to answer several different telephone numbers.

Duplex

A mechanism that will automatically flip over a sheet of paper so that the machine can print (or scan) on both sides of the paper. A printer equipped with a Duplex can print double-sided of paper.

Duty Cycle

Duty cycle is the page quantity which does not affect printer performance for a month. Generally the printer has the lifespan limitation such as pages per year. The lifespan means the average capacity of print-outs, usually within the warranty period. For example, if the duty cycle is 48,000 pages per month assuming 20 working days, a printer limits 2,400 pages a day.

ECM

Error Correction Mode (ECM) is an optional transmission mode built into Class 1 fax machines or fax modems. It automatically detects and corrects errors in the fax transmission process that are sometimes caused by telephone line noise.

Emulation

Emulation is a technique of one machine obtaining the same results as another.

An emulator duplicates the functions of one system with a different system, so that the second system behaves like the first system. Emulation focuses on exact reproduction of external behavior, which is in contrast to simulation, which concerns an abstract model of the system being simulated, often considering its internal state.

Ethernet

Ethernet is a frame-based computer networking technology for local area networks (LANs). It defines wiring and signaling for the physical layer, and frame formats and protocols for the media access control (MAC)/data link layer of the OSI model. Ethernet is mostly standardized as IEEE 802.3. It has become the most widespread LAN technology in use during the 1990s to the present.

EtherTalk

A suite of protocols developed by Apple Computer for computer networking. It was included in the original Macintosh (1984) and is now deprecated by Apple in favor of TCP/IP networking.

FDI

Foreign Device Interface (FDI) is a card installed inside the machine to allow a third party device such as a coin operated device or a card reader. Those devices allow the pay-for-print service on your machine.

FTP

A File Transfer Protocol (FTP) is a commonly used protocol for exchanging files over any network that supports the TCP/IP protocol (such as the Internet or an intranet).

Fuser Unit

The part of a laser printer that melts the toner onto the print media. It consists of a hot roller and a back-up roller. After toner is transferred onto the paper, the fuser unit applies heat and pressure to ensure that the toner stays on the paper permanently, which is why paper is warm when it comes out of a laser printer.

Gateway

A connection between computer networks, or between a computer network and a telephone line. It is very popular, as it is a computer or a network that allows access to another computer or network.

Grayscale

A shades of gray that represent light and dark portions of an image when color images are converted to grayscale; colors are represented by various shades of gray.

Halftone

An image type that simulates grayscale by varying the number of dots. Highly colored areas consist of a large number of dots, while lighter areas consist of a smaller number of dots.

HDD

Hard Disk Drive (HDD), commonly referred to as a hard drive or hard disk, is a non-volatile storage device which stores digitally-encoded data on rapidly rotating platters with magnetic surfaces.

IEEE

The Institute of Electrical and Electronics Engineers (IEEE) is an international non-profit, professional organization for the advancement of technology related to electricity.

IEEE 1284

The 1284 parallel port standard was developed by the Institute of Electrical and Electronics Engineers (IEEE). The term "1284-B" refers to a specific connector type on the end of the parallel cable that attaches to the peripheral (for example, a printer).

Intranet

A private network that uses Internet Protocols, network connectivity, and possibly the public telecommunication system to securely share part of an organization's information or operations with its employees. Sometimes the term refers only to the most visible service, the internal website.

IP address

An Internet Protocol (IP) address is a unique number that devices use in order to identify and communicate with each other on a network utilizing the Internet Protocol standard.

IPM

The Images Per Minute (IPM) is a way of measuring the speed of a printer. An IPM rate indicates the number of single-sided sheets a printer can complete within one minute.

IPP

The Internet Printing Protocol (IPP) defines a standard protocol for printing as well as managing print jobs, media size, resolution, and so forth. IPP can be used locally or over the Internet to hundreds of printers, and also supports access control, authentication, and encryption, making it a much more capable and secure printing solution than older ones.

IPX/SPX

IPX/SPX stands for Internet Packet Exchange/Sequenced Packet Exchange. It is a networking protocol used by the Novell NetWare operating systems. IPX and SPX both provide connection services similar to TCP/IP, with the IPX protocol having similarities to IP, and SPX having similarities to TCP. IPX/SPX was primarily designed for local area networks (LANs), and is a very efficient protocol for this purpose (typically its performance exceeds that of TCP/IP on a LAN).

ISO

The International Organization for Standardization (ISO) is an international standard-setting body composed of representatives from national standards bodies. It produces world-wide industrial and commercial standards.

ITU-T

The International Telecommunication Union is an international organization established to standardize and regulate international radio and telecommunications. Its main tasks include standardization, allocation of the radio spectrum, and organizing interconnection arrangements between different countries to allow international phone calls. A -T out of ITU-T indicates telecommunication.

ITU-T No. 1 chart

Standardized test chart published by ITU-T for document facsimile transmissions.

JBIG

Joint Bi-level Image Experts Group (JBIG) is an image compression standard with no loss of accuracy or quality, which was designed for

compression of binary images, particularly for faxes, but can also be used on other images.

JPEG

Joint Photographic Experts Group (JPEG) is a most commonly used standard method of lossy compression for photographic images. It is the format used for storing and transmitting photographs on the World Wide Web.

LDAP

The Lightweight Directory Access Protocol (LDAP) is a networking protocol for querying and modifying directory services running over TCP/IP.

LED

A Light-Emitting Diode (LED) is a semiconductor device that indicates the status of a machine.

MAC address

Media Access Control (MAC) address is a unique identifier associated with a network adapter. MAC address is a unique 48-bit identifier usually written as 12 hexadecimal characters grouped in pairs (e. g., 00-00-0c-34-11-4e). This address is usually hard-coded into a Network Interface Card (NIC) by its manufacturer, and used as an aid for routers trying to locate machines on large networks.

MFP

Multi Function Peripheral (MFP) is an office machine that includes the following functionality in one physical body, so as to have a printer, a copier, a fax, a scanner and etc.

MH

Modified Huffman (MH) is a compression method for decreasing the amount of data that needs to be transmitted between the fax machines to transfer the image recommended by ITU-T T.4. MH is a codebook-based run-length encoding scheme optimized to efficiently compress white space. As most faxes consist mostly of white space, this minimizes the transmission time of most faxes.

MMR

Modified Modified READ (MMR) is a compression method recommended by ITU-T T.6.

Modem

A device that modulates a carrier signal to encode digital information, and also demodulates such a carrier signal to decode transmitted information.

MR

Modified Read (MR) is a compression method recommended by ITU-T T.4. MR encodes the first scanned line using MH. The next line is compared to the first, the differences determined, and then the differences are encoded and transmitted.

NetWare

A network operating system developed by Novell, Inc. It initially used cooperative multitasking to run various services on a PC, and the network protocols were based on the archetypal Xerox XNS stack. Today NetWare supports TCP/IP as well as IPX/SPX.

OPC

Organic Photo Conductor (OPC) is a mechanism that makes a virtual image for print using a laser beam emitted from a laser printer, and it is usually green or gray colored and a cylinder shaped.

An exposing unit of a drum is slowly worn away by its usage of the printer, and it should be replaced appropriately since it gets scratches from grits of a paper.

Originals

The first example of something, such as a document, photograph or text, etc, which is copied, reproduced or translated to produce others, but which is not itself copied or derived from something else.

OSI

Open Systems Interconnection (OSI) is a model developed by the International Organization for Standardization (ISO) for communications. OSI offers a standard, modular approach to network design that divides the required set of complex functions into manageable, self-contained, functional layers. The layers are, from top to bottom, Application, Presentation, Session, Transport, Network, Data Link and Physical.

PABX

A private automatic branch exchange (PABX) is an automatic telephone switching system within a private enterprise.

PCL

Printer Command Language (PCL) is a Page Description Language (PDL) developed by HP as a printer protocol and has become an industry standard. Originally developed for early inkjet printers, PCL has been released in varying levels for thermal, matrix printer, and page printers.

PDF

Portable Document Format (PDF) is a proprietary file format developed by Adobe Systems for representing two dimensional documents in a device independent and resolution independent format.

PostScript

PostScript (PS) is a page description language and programming language used primarily in the electronic and desktop publishing areas. - that is run in an interpreter to generate an image.

Printer Driver

A program used to send commands and transfer data from the computer to the printer.

Print Media

The media like paper, envelopes, labels, and transparencies which can be used on a printer, a scanner, a fax or, a copier.

PPM

Pages Per Minute (PPM) is a method of measurement for determining how fast a printer works, meaning the number of pages a printer can produce in one minute.

PRN file

An interface for a device driver, this allows software to interact with the device driver using standard input/output system calls, which simplifies many tasks.

Protocol

A convention or standard that controls or enables the connection, communication, and data transfer between two computing endpoints.

PS

See PostScript.

PSTN

The Public-Switched Telephone Network (PSTN) is the network of the world's public circuit-switched telephone networks which, on industrial premises, is usually routed through the switchboard.

RADIUS

Remote Authentication Dial In User Service (RADIUS) is a protocol for remote user authentication and accounting. RADIUS enables centralized management of authentication data such as usernames and passwords using an AAA (authentication, authorization, and accounting) concept to manage network access.

Resolution

The sharpness of an image, measured in Dots Per Inch (DPI). The higher the dpi, the greater the resolution.

SMB

Server Message Block (SMB) is a network protocol mainly applied to share files, printers, serial ports, and miscellaneous communications between nodes on a network. It also provides an authenticated Inter-process communication mechanism.

SMTP

Simple Mail Transfer Protocol (SMTP) is the standard for e-mail transmissions across the Internet. SMTP is a relatively simple, text-based protocol, where one or more recipients of a message are specified, and then the message text is transferred. It is a client-server protocol, where the client transmits an email message to the server.

SSID

Service Set Identifier (SSID) is a name of a wireless local area network (WLAN). All wireless devices in a WLAN use the same SSID in order to communicate with each other. The SSIDs are case-sensitive and have a maximum length of 32 characters.

Subnet Mask

The subnet mask is used in conjunction with the network address to determine which part of the address is the network address and which part is the host address.

TCP/IP

The Transmission Control Protocol (TCP) and the Internet Protocol (IP); the set of communications protocols that implement the protocol stack on which the Internet and most commercial networks run.

TCR

Transmission Confirmation Report (TCR) provides details of each transmission such as job status, transmission result and number of pages sent. This report can be set to print after each job or only after failed transmissions.

TIFF

Tagged Image File Format (TIFF) is a variable-resolution bitmapped image format. TIFF describes image data that typically come from scanners. TIFF images make use of tags, keywords defining the characteristics of the image that is included in the file. This flexible and platform-independent format can be used for pictures that have been made by various image processing applications.

Toner Cartridge

A kind of bottle within a machine like printer which contains toner. Toner is a powder used in laser printers and photocopiers, which forms the text and images on the printed paper. Toner can be melted by the heat of the fuser, causing it to bind to the fibers in the paper.

TWAIN

An industry standard for scanners and software. By using a TWAIN-compliant scanner with a TWAIN-compliant program, a scan can be initiated from within the program.; an image capture API for Microsoft Windows and Apple Macintosh operating systems.

UNC Path

Uniform Naming Convention (UNC) is a standard way to access network shares in Window NT and other Microsoft products. The format of a UNC path is: \\<servername>\<sharename>\<Additional directory>

URL

Uniform Resource Locator (URL) is the global address of documents and resources on the Internet. The first part of the address indicates what protocol to use, the second part specifies the IP address or the domain name where the resource is located.

USB

Universal Serial Bus (USB) is a standard that was developed by the USB Implementers Forum, Inc., to connect computers and peripherals. Unlike the parallel port, USB is designed to concurrently connect a single computer USB port to multiple peripherals.

Watermark

A watermark is a recognizable image or pattern in paper that appears lighter when viewed by transmitted light. Watermarks were first introduced in Bologna, Italy in 1282; they have been used by papermakers to identify their product, and also on postage stamps, currency, and other government documents to discourage counterfeiting.

WEP

Wired Equivalent Privacy (WEP) is a security protocol specified in IEEE 802.11 to provide the same level of security as that of a wired LAN. WEP provides security by encrypting data over radio so that it is protected as it is transmitted from one end point to another.

WIA

Windows Imaging Architecture (WIA) is an imaging architecture that is originally introduced in Windows Me and Windows XP. A scan can be initiated from within these operating systems by using a WIA-compliant scanner.

WPA

Wi-Fi Protected Access (WPA) is a class of systems to secure wireless (Wi-Fi) computer networks, which was created to improve upon the security features of WEP.

WPA-PSK

WPA-PSK (WPA Pre-Shared Key) is special mode of WPA for small business or home users. A shared key, or password, is configured in the wireless access point (WAP) and any wireless laptop or desktop devices. WPA-PSK generates a unique key for each session between a wireless client and the associated WAP for more advanced security.