



HP Spectre x360 15 Convertible PC (model numbers 15-ch000 through 15-ch099)

Maintenance and Service Guide
IMPORTANT! This document is intended for HP authorized service providers only.

© Copyright 2018 HP Development Company, L.P.

Bluetooth is a trademark owned by its proprietor and used by HP Inc. under license. NVIDIA are trademarks and/or registered trademarks of NVIDIA Corporation in the U.S. and other countries. Bluetooth is a trademark owned by its proprietor and used by HP Inc. under license. Intel and Core are trademarks of Intel Corporation in the U.S. and other countries. Windows is either a registered trademark or trademark of Microsoft Corporation in the United States and/or other countries.

The information contained herein is subject to change without notice. The only warranties for HP products and services are set forth in the express warranty statements accompanying such products and services. Nothing herein should be construed as constituting an additional warranty. HP shall not be liable for technical or editorial errors or omissions contained herein.

First Edition: February 2018

Document Part Number: L11173-001

Product notice

This user guide describes features that are common to most models. Some features may not be available on your computer.

Not all features are available in all editions of Windows. This computer may require upgraded and/or separately purchased hardware, drivers and/or software to take full advantage of Windows functionality. Go to <http://www.microsoft.com> for details.

In accordance with Microsoft's support policy, HP does not support the Windows 8 or Windows 7 operating system on this product or provide any Windows 8 or Windows 7 drivers on <http://support.hp.com>.

Software terms

By installing, copying, downloading, or otherwise using any software product preinstalled on this computer, you agree to be bound by the terms of the HP End User License Agreement (EULA). If you do not accept these license terms, your sole remedy is to return the entire unused product (hardware and software) within 14 days for a full refund subject to the refund policy of your seller.

For any further information or to request a full refund of the price of the computer, please contact your seller.

Safety warning notice

 **WARNING!** To reduce the possibility of heat-related injuries or of overheating the device, do not place the device directly on your lap or obstruct the device air vents. Use the device only on a hard, flat surface. Do not allow another hard surface, such as an adjoining optional printer, or a soft surface, such as pillows or rugs or clothing, to block airflow. Also, do not allow the AC adapter to contact the skin or a soft surface, such as pillows or rugs or clothing, during operation. The device and the AC adapter comply with the user-accessible surface temperature limits defined by the International Standard for Safety of Information Technology Equipment (IEC 60950-1).

Table of contents

1 Product description	1
2 External component identification	3
Right side	4
Left side	6
Display	8
Keyboard area	9
TouchPad	9
Lights	10
Speaker	11
Special keys	12
Action keys	14
Bottom	16
Locating system information	17
3 Illustrated parts catalog	18
Computer major components	18
Miscellaneous parts	22
4 Removal and replacement procedures preliminary requirements	23
Tools required	23
Service considerations	23
Plastic parts	23
Cables and connectors	24
Drive handling	24
Grounding guidelines	25
Electrostatic discharge damage	25
Packaging and transporting guidelines	26
Workstation guidelines	26
Equipment guidelines	27
5 Removal and replacement procedures for authorized service provider parts	28
Component replacement procedures	28
Bottom cover	29
Battery	31
Front speakers	32

Volume button board	33
Fingerprint reader module	35
Fingerprint reader board	36
WLAN module	37
USB daughter board	39
Audio board	40
Memory card reader board	42
TouchPad assembly	43
Left fan	45
Right fan	47
Solid state drive	49
Memory module	51
System board	52
Rear speakers	55
Power connector cable	57
Display panel assembly	59

6 Using Setup Utility (BIOS) 61

Starting Setup Utility (BIOS)	61
Updating Setup Utility (BIOS)	61
Determining the BIOS version	61
Downloading a BIOS update	62

7 Backing up, restoring, and recovering 63

Using Windows tools	63
Creating HP Recovery media (select products only)	63
Using HP Recovery Manager to create recovery media	64
Before you begin	64
Creating the recovery media	64
Using the HP Cloud Recovery Download Tool to create recovery media	65
Restoring and recovery	65
Restoring, resetting, and refreshing using Windows tools	65
Restoring using HP Recovery Manager and the HP Recovery partition	65
Recovering using HP Recovery Manager	65
Recovering using the HP Recovery partition (select products only)	66
Recovering using HP Recovery media	66
Changing the computer boot order	67
Removing the HP Recovery partition (select products only)	67

8 Using HP PC Hardware Diagnostics	68
Using HP PC Hardware Diagnostics Windows	68
Downloading HP PC Hardware Diagnostics Windows	68
Downloading the latest HP PC Hardware Diagnostics Windows version	69
Downloading HP Hardware Diagnostics Windows by product name or number (select products only)	69
Installing HP PC Hardware Diagnostics Windows	69
Using HP PC Hardware Diagnostics UEFI	69
Starting HP PC Hardware Diagnostics UEFI	70
Downloading HP PC Hardware Diagnostics UEFI to a USB flash drive	70
Downloading the latest HP PC Hardware Diagnostics UEFI version	70
Downloading HP PC Hardware Diagnostics UEFI by product name or number (select products only)	70
Using Remote HP PC Hardware Diagnostics UEFI settings (select products only)	71
Downloading Remote HP PC Hardware Diagnostics UEFI	71
Downloading the latest Remote HP PC Hardware Diagnostics UEFI version	71
Downloading Remote HP PC Hardware Diagnostics UEFI by product name or number	71
Customizing Remote HP PC Hardware Diagnostics UEFI settings	71
 9 Specifications	 73
Computer specifications	73
39.6 cm (15.6-in) display specifications	74
 10 Power cord set requirements	 75
Requirements for all countries	75
Requirements for specific countries and regions	76
 11 Recycling	 78
 Index	 79

1 Product description

Category	Description
Product Name	HP Spectre x360 15 Convertible PC
Processors	Intel Core i7-8705G (Up to 3.1 GHz, turbo up to 4.1 GHz, 2400 MHz, 8MB cache, quad core) Intel Core i7-8550U (Up to 1.8GHz, turbo up to 4.0 GHz, 2400 MHz, 8MB cache, quad core)
Graphics	Internal graphics: Intel® HD Graphics 620 Discrete graphics: Radeon® RX VEGA M 870 graphics, up to 4096 MB dedicating HBM memory NVIDIA® N175–G1 (GeForce MX150), 2048 MB GDDR5 memory
Panel	15.6" UHD WLED BrightView (3840×2160) uslim-flat (2.6mm) UWVA, eDP+PSR, Narrow Bezel
Memory module	Support for 16384 MB of DDR4 2400 MHz system memory in the following configurations: 16384 MB (8192MB × 2) 12288 MB (8192MB + 4096MB) 8192 MB (4096MB × 2)
Solid state drive	Support for the following single solid state drive configurations: 2 TB PCIe NVMe TLC M.2 solid state drive 1 TB PCIe NVMe TLC M.2 solid state drive 512 GB PCIe NVMe TLC M.2 solid state drive 360 GB PCIe NVMe TLC M.2 solid state drive 256 GB PCIe NVMe TLC M.2 solid state drive
Optical drive	Support for external 9.5 mm tray load, SATA, DVD+/-RW DL SuperMulti drive
Audio and video	Support for the following integrated cameras: HP Wide Vision camera: high definition (FHD 1080 by 30 frames/sec), infrared (IR), fixed (no tilt), with activity light Support for Windows Hello Support for voice recognition Dual digital microphones with appropriate software - echo cancellation, noise suppression, beam forming Quad speakers Bang & Olufsen Audio
Wireless	Intel Dual band wireless-AC 9260 802.11AC 2x2 WiFi + BT 5.0 Combo Adaptor (non-vPro) Intel Dual band wireless-AC 8265 802.11AC 2x2 WiFi + BT 4.2 Combo Adaptor (non-vPro) Compatible with Miracast-certified devices
External media cards	HP Multi-Format Digital Media Card Reader with push-push technology. Supports SD/SDHC/SDXC



Category	Description
Ports	<p>AC adapter: HP Smart pin plug (4.5-mm barrel)</p> <p>Audio: one combo audio-out (headphone)/audio-in (microphone) jack</p> <p>HDMI: v2.0 supporting: up to 4096×2160 at 60 Hz</p> <p>USB 3.1 (1 on left side, supports HP Sleep and Charge)</p> <p>(2) USB Type-C (1 Generation 1, 1 Generation 2 with Thunderbolt™) on right side</p> <p>(2) USB Type-C (2 Gen 2 with Thunderbolt technology) on right side (select models only)</p> <p>All ports support data transfer, power delivery and Display Port 1.2 out up to 3840×2160 (60Hz)</p>
Keyboard/pointing devices	<p>Full Size Painted Backlight island-style Keyboard in Dark Ash Silver color</p> <p>Clickpad with image sensor</p> <p>Multitouch gestures enabled by default</p> <p>Support for Modern Trackpad gestures</p> <p>Taps enabled by default</p>
Power requirements	<p>150-W Smart AC barrel adapter with localized cable plug support</p> <p>90-W Smart AC barrel adapter with localized cable plug support</p> <p>1 meter power cord</p> <p>6-cell, 84-Whr polymer battery</p>
Security	<p>TPM 2.0</p> <p>Fingerprint reader</p>
Operating system	<p>Preinstalled:</p> <p>Windows 10 Pro</p> <p>Windows 10 Home Plus ML</p> <p>Windows 10 Home Plus EM/SL</p> <p>Windows 10</p> <p>CPPP Windows 10 Home High End China Language Edition</p>
Serviceability	<p>End user replaceable parts:</p> <p>AC adapter</p>

2 External component identification



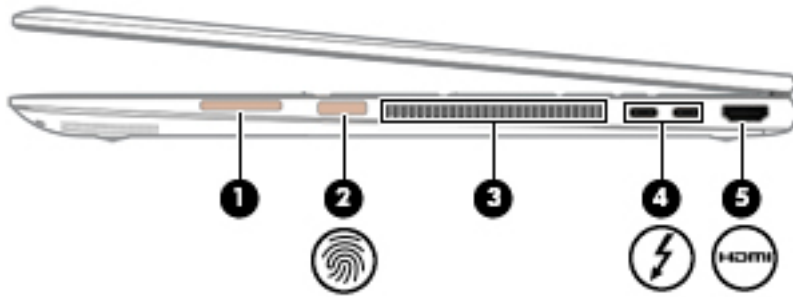

Right side

 **NOTE:** Refer to the illustration that most closely matches your product.

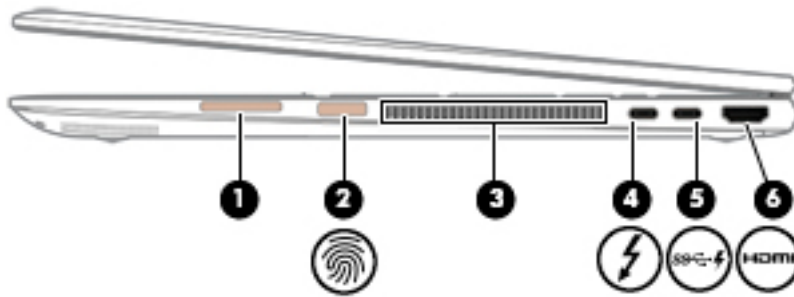





Component	Description
(1) Volume button	Controls speaker volume on the computer.
(2)  Fingerprint reader	Allows a fingerprint logon to Windows, instead of a password logon. ▲ To use the fingerprint reader, swipe your finger on the fingerprint reader.
(3) Vent	Enables airflow to cool internal components. NOTE: The computer fan starts up automatically to cool internal components and prevent overheating. It is normal for the internal fan to cycle on and off during routine operation.
(4)  USB Type-C power connector and Thunderbolt™ ports with HP Sleep and Charge (2)	Connect AC adapters that have a USB Type-C connector, supplying power to the computer and, if needed, charging the computer battery while the computer is off or in the Sleep state. – and – Connect and charge most USB devices that have a Type-C connector, such as a cell phone, camera, activity tracker, or smartwatch, and provides high-speed data transfer. – and – Connect display devices that have a USB Type-C connector, providing DisplayPort output. NOTE: Your computer may also support a Thunderbolt docking station. NOTE: Cables and/or adapters (purchased separately) may be required.
(5)  HDMI port	Connects an optional video or audio device, such as a high-definition television, any compatible digital or audio component, or a high-speed High-Definition Multimedia Interface (HDMI) device.

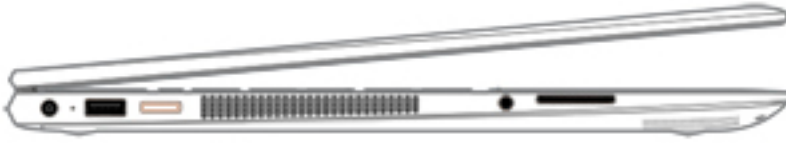

Component	Description
(1) Volume button	Controls speaker volume on the computer.
(2)  Fingerprint reader	Allows a fingerprint logon to Windows, instead of a password logon. ▲ To use the fingerprint reader, swipe your finger on the fingerprint reader.
(3) Vent	Enables airflow to cool internal components. NOTE: The computer fan starts up automatically to cool internal components and prevent overheating. It is normal for the internal fan to cycle on and off during routine operation.
(4)  USB Type-C power connector and Thunderbolt port with HP Sleep and Charge	Connects an AC adapter that has a USB Type-C connector, supplying power to the computer and, if needed, charging the computer battery while the computer is off or in the Sleep state. – and – Connects and charges most USB devices that have a Type-C connector, such as a cell phone, camera, activity tracker, or smartwatch, and provides high-speed data transfer. – and – Connects a display device that has a USB Type-C connector, providing DisplayPort output. NOTE: Your computer may also support a Thunderbolt docking station. NOTE: Cables and/or adapters (purchased separately) may be required.
(5)  USB Type-C SuperSpeed port with HP Sleep and Charge	Connects a USB device that has a Type-C connector, provides high-speed data transfer, and even when the computer is off, charges most products such as a cell phone, camera, activity tracker, or smartwatch. – and – Connects a display device that has a USB Type-C connector, providing DisplayPort output. NOTE: Cables and/or adapters (purchased separately) may be required.
(6)  HDMI port	Connects an optional video or audio device, such as a high-definition television, any compatible digital or audio component, or a high-speed High-Definition Multimedia Interface (HDMI) device.

Left side



Component	Description
(1)  Power connector	Connects an AC adapter.
(2) AC adapter and battery light	<ul style="list-style-type: none"> • White: The AC adapter is connected and the battery is fully charged. • Blinking white: The AC adapter is disconnected and the battery has reached a low battery level. • Amber: The AC adapter is connected and the battery is charging. • Off: The battery is not charging.
(3)  USB 3.x SuperSpeed port with HP Sleep and Charge	Connects a USB device, provides high-speed data transfer, and even when the computer is off, charges most products such as a cell phone, camera, activity tracker, or smartwatch.
(4) Power button	<ul style="list-style-type: none"> • When the computer is off, press the button to turn on the computer. • When the computer is on, press the button briefly to initiate Sleep. • When the computer is in the Sleep state, press the button briefly to exit Sleep. • When the computer is in Hibernation, press the button briefly to exit Hibernation. <p>CAUTION: Pressing and holding down the power button results in the loss of unsaved information.</p> <p>If the computer has stopped responding and shutdown procedures are ineffective, press and hold the power button down for at least 5 seconds to turn off the computer.</p> <p>To learn more about your power settings, see your power options:</p> <ul style="list-style-type: none"> ▲ Right-click the Power icon , and then select Power Options.
(5)  Power light	<ul style="list-style-type: none"> • On: The computer is on. • Blinking: The computer is in the Sleep state, a power-saving state. The computer shuts off power to the display and other unneeded components.

Component	Description
(6) Vent	<ul style="list-style-type: none"> Off: The computer is off or in Hibernation. Hibernation is a power-saving state that uses the least amount of power. <p>Enables airflow to cool internal components.</p> <p>NOTE: The computer fan starts up automatically to cool internal components and prevent overheating. It is normal for the internal fan to cycle on and off during routine operation.</p>
(7)  Audio-out (headphone)/Audio-in (microphone) combo jack	<p>Connects optional powered stereo speakers, headphones, earbuds, a headset, or a television audio cable. Also connects an optional headset microphone. This jack does not support optional standalone microphones.</p> <p>WARNING! To reduce the risk of personal injury, adjust the volume before putting on headphones, earbuds, or a headset. For additional safety information, refer to the <i>Regulatory, Safety, and Environmental Notices</i>.</p> <p>To access this guide:</p> <ul style="list-style-type: none"> ▲ Select the Start button, select HP Help and Support, and then select HP Documentation. <p>–or–</p> <ul style="list-style-type: none"> ▲ Select the Start button, select HP, and then select HP Documentation. <p>NOTE: When a device is connected to the jack, the computer speakers are disabled.</p>
(8) Memory card reader	<p>Reads optional memory cards that enable you to store, manage, share, or access information.</p> <p>To insert a card:</p> <ol style="list-style-type: none"> Hold the card label-side up, with connectors facing the computer. Insert the card into the memory card reader, and then press in on the card until it is firmly seated. <p>To remove a card:</p> <ul style="list-style-type: none"> ▲ Press in on the card, and then remove it from the memory card reader.

Display



Component	Description
(1) WLAN antennas*	Send and receive wireless signals to communicate with wireless local area networks (WLANs).
(2) Internal microphones	Record sound.
(3) Camera lights	On: One or more cameras are in use.
(4) Camera	Allows you to video chat, record video, and record still images. Some cameras also allow a facial recognition logon to Windows, instead of a password logon. NOTE: Camera functions vary depending on the camera hardware and software installed on your product.

*The antennas are not visible from the outside of the computer. For optimal transmission, keep the areas immediately around the antennas free from obstructions.

For wireless regulatory notices, see the section of the *Regulatory, Safety, and Environmental Notices* that applies to your country or region.

To access this guide:

▲ Select the **Start** button, select **HP Help and Support**, and then select **HP Documentation**.

–or–

▲ Select the **Start** button, select **HP**, and then select **HP Documentation**.

Keyboard area

TouchPad



Component		Description
(1)	TouchPad zone	Reads your finger gestures to move the pointer or activate items on the screen.
(2)	Left TouchPad button	Functions like the left button on an external mouse.
(3)	Right TouchPad button	Functions like the right button on an external mouse.

Lights

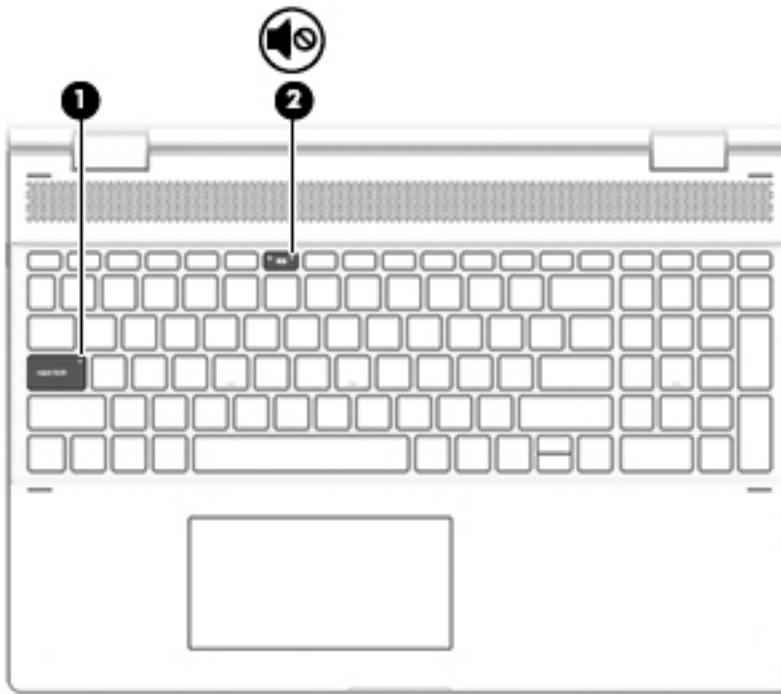

Component	Description
(1) Caps lock light	On: Caps lock is on, which switches the key input to all capital letters.
(2)  Mute light	<ul style="list-style-type: none">• On: Computer sound is off.• Off: Computer sound is on.

Speaker

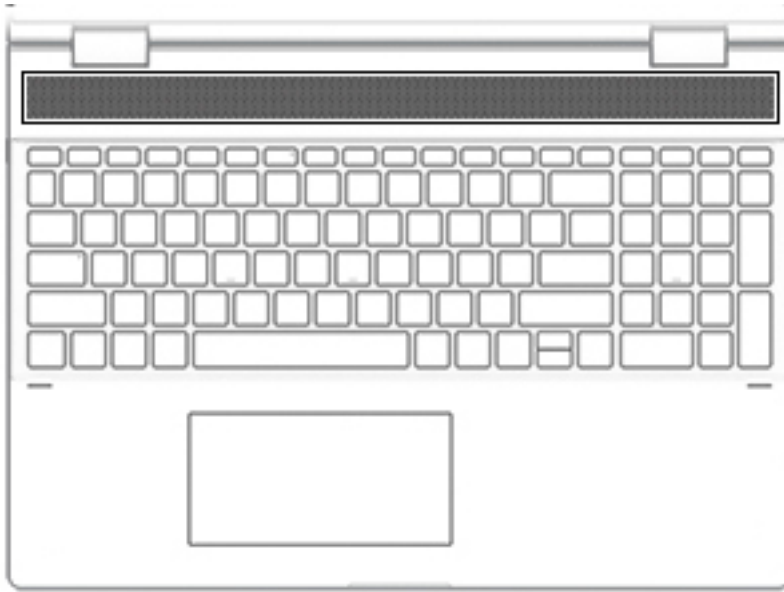

Component	Description
Speaker	Produces sound.

Special keys

 **NOTE:** Refer to the illustration that most closely matches your product.

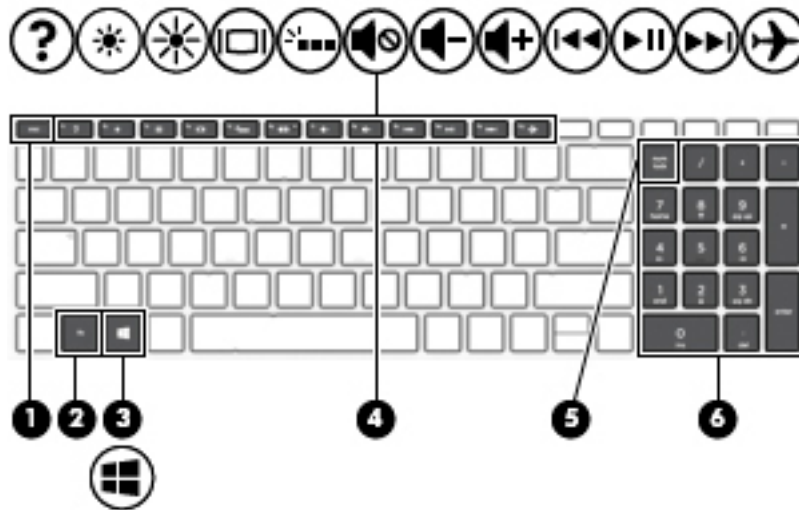

Component	Description
(1) esc key	Displays system information when pressed in combination with the fn key.
(2) fn key	Executes specific functions when pressed in combination with another key.
(3)  Windows key	Opens the Start menu. NOTE: Pressing the Windows key again will close the Start menu.
(4) Action keys	Execute frequently used system functions. NOTE: On select products, the f5 action key turns the keyboard backlight feature off or on.
(5) num lock key	Alternates between the navigational and numeric functions on the integrated numeric keypad.
(6) Integrated numeric keypad	A separate keypad to the right of the alphabet keyboard. When num lock is pressed, the keypad can be used like an external numeric keypad. NOTE: If the keypad function is active when the computer is turned off, that function is reinstated when the computer is turned back on.

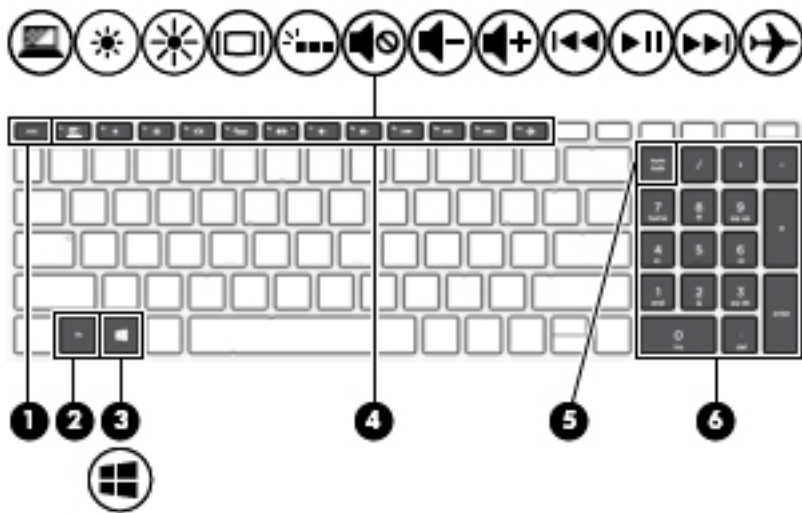









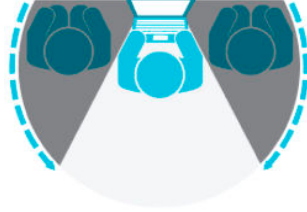



Component	Description
(1) esc key	Displays system information when pressed in combination with the fn key.
(2) fn key	Executes specific functions when pressed in combination with another key.
(3)  Windows key	Opens the Start menu. NOTE: Pressing the Windows key again will close the Start menu.
(4) Action keys	Execute frequently used system functions. NOTE: On select products, the f5 action key turns the keyboard backlight feature off or on.
(5) num lock key	Alternates between the navigational and numeric functions on the integrated numeric keypad.
(6) Integrated numeric keypad	A separate keypad to the right of the alphabet keyboard. When num lock is pressed, the keypad can be used like an external numeric keypad. NOTE: If the keypad function is active when the computer is turned off, that function is reinstated when the computer is turned back on.

Action keys

An action key performs the function indicated by the icon on the key. To determine which keys are on your product, see [Special keys on page 12](#).

▲ To use an action key, press and hold the key.

Icon	Description
	On select products, helps prevent side-angle viewing from onlookers. If needed, decrease or increase brightness for well-lit or darker environments. Press the key again to turn off the privacy screen.
	
	Decreases the screen brightness incrementally as long as you hold down the key.
	Increases the screen brightness incrementally as long as you hold down the key.
	On select products, opens the “How to get help in Windows 10” webpage.
	Switches the screen image between display devices connected to the system. For example, if a monitor is connected to the computer, repeatedly pressing this key alternates the screen image from the computer display to the monitor display to a simultaneous display on both the computer and the monitor.
	Turns the keyboard backlight off or on. NOTE: To conserve battery power, turn off this feature.
	Plays the previous track of an audio CD or the previous section of a DVD or a Blu-ray Disc (BD).
	Starts, pauses, or resumes playback of an audio CD, a DVD, or a BD.
	Plays the next track of an audio CD or the next section of a DVD or a BD.
	Decreases speaker volume incrementally while you hold down the key.
	Increases speaker volume incrementally while you hold down the key.
	Mutes or restores speaker sound.
	Turns the airplane mode and wireless feature on or off. NOTE: The airplane mode key is also referred to as the wireless button.

Icon	Description
	NOTE: A wireless network must be set up before a wireless connection is possible.

Bottom

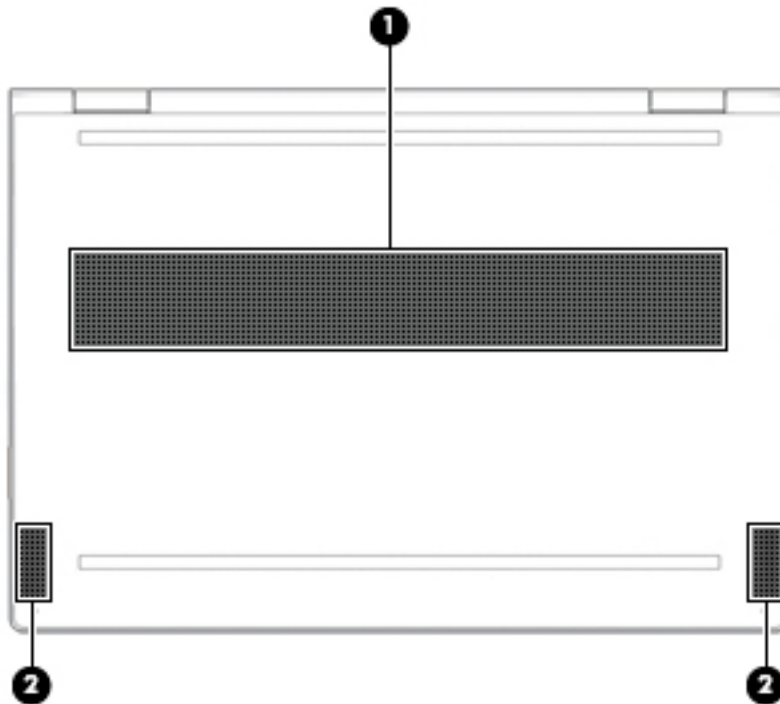

Component		Description
(1)	Vent	Enables airflow to cool internal components. NOTE: The computer fan starts up automatically to cool internal components and prevent overheating. It is normal for the internal fan to cycle on and off during routine operation.
(2)	Speakers (2)	Produce sound.

Locating system information

Important system information is located on the bottom edge of the tablet or on the keyboard base. You may need the information when travelling internationally or when you contact support:

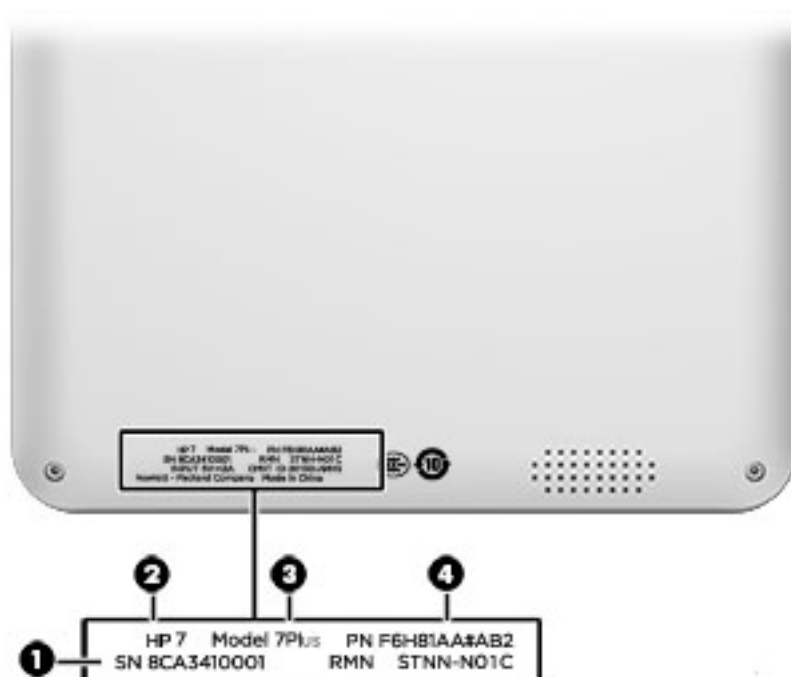

- (1):** Serial number
- (2):** Product number
- (3):** Model number
- (4):** Warranty period



Using Windows, briefly press the **fn+esc** key combination to display the System Information screen, which provides the product name and serial number of your computer, as well as information about the memory, processor, BIOS, and keyboard.

3 Illustrated parts catalog

Computer major components

-
-  **NOTE:** HP continually improves and changes product parts. For complete and current information on supported parts for your computer, go to <http://partsurfer.hp.com>, select your country or region, and then follow the on-screen instructions.
 -  **NOTE:** Details about your computer, including model, serial number, product key, and length of warranty, are on the service tag at the bottom of your computer. See [Locating system information on page 17](#) for details.
-

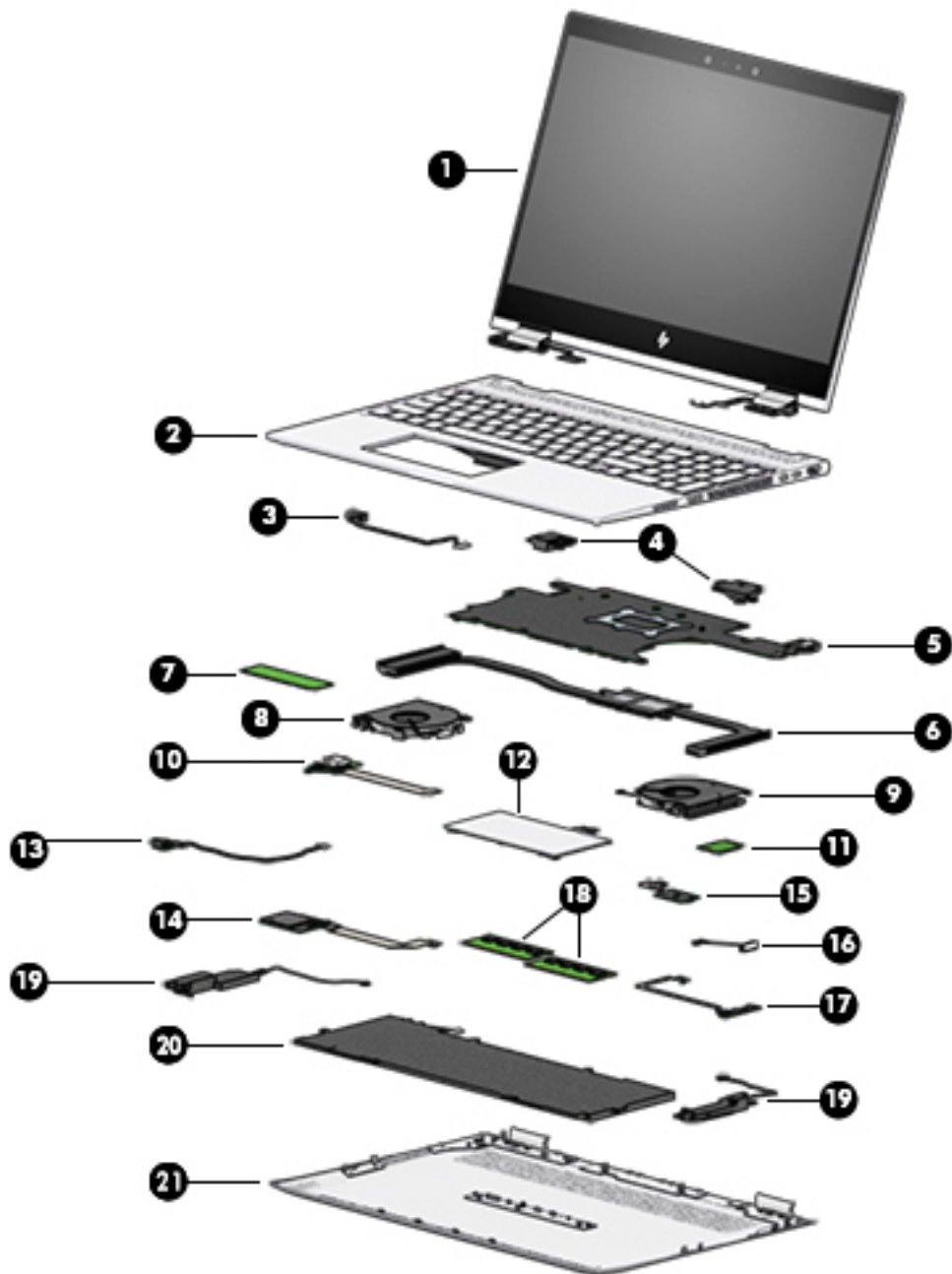

Item	Component	Spare part number
(1)	Display panel	L15596-001
(2)	Keyboard/top cover (for use with models equipped with an Intel Core i7-8705G processor)	
	For use internationally	L15587-B31
	For use in Belgium	L15587-A41
	For use in France	L15587-051
	For use in France (English)	L15587-DB1
	For use in Germany	L15587-041

Item	Component	Spare part number
	For use in Greece	L15587-151
	For use in Italy	L15587-061
	For use in Japan	L15587-291
	For use in Norway	L15587-DH1
	For use in Russia	L15587-251
	For use in Saudi Arabia (English)	L15587-171
	For use in Switzerland	L15587-BG1
	For use in the United Kingdom	L15587-031
	For use in the United States	L15587-001
	Keyboard/top cover (for use with models equipped with an Intel Core i7-8550U processor)	
	For use internationally	L15588-B31
	For use in Belgium	L15588-A41
	For use in France	L15588-051
	For use in France (English)	L15588-DB1
	For use in Germany	L15588-041
	For use in Greece	L15588-151
	For use in Italy	L15588-061
	For use in Japan	L15588-291
	For use in Norway	L15588-DH1
	For use in Russia	L15588-251
	For use in Saudi Arabia (English)	L15588-171
	For use in Switzerland	L15588-BG1
	For use in the United Kingdom	L15588-031
	For use in the United States	L15588-001
(3)	Power connector cable	L15586-001
(4)	Rear speakers (left/right, part number is for speaker kit which includes all four speakers)	L15590-001
(5)	System board	
	Equipped with an Intel Core i7-8705G (Up to 3.1 GHz, turbo up to 4.1 GHz, 2400 MHz, 8MB L2 cache, quad core, 150W) processor, a graphic subsystem with a Radeon RX VEGA M 4GB GPU, and the Windows 10 Pro operating system	L15574-601
	Equipped with an Intel Core i7-8705G (Up to 3.1 GHz, turbo up to 4.1 GHz, 2400 MHz, 8MB L2 cache, quad core, 150W) processor, a graphic subsystem with a Radeon RX VEGA M 4GB GPU, and a non-Windows 10 Pro operating system	L15574-001
	Equipped with an Intel Core i7-8550U (Up to 1.8GHz, turbo up to 4.0 GHz, 2400 MHz, 8MB L2 cache, quad core 90W) processor, a graphic subsystem with a NVIDIA N175-G1 (GeForce MX150) 2GB GPU, and the Windows 10 operating system	L155573-601

Item	Component	Spare part number
	Equipped with an Intel Core i7-8550U (Up to 1.8GHz, turbo up to 4.0 GHz, 2400 MHz, 8MB L2 cache, quad core 90W) processor, a graphic subsystem with a NVIDIA N175-G1 (GeForce MX150) 2GB GPU, and a non-Windows 10 operating system	L155573-001
(6)	Heatsink	
	For use in models equipped with the Intel Core i7-8705G processor	L15595-001
	For use in models equipped with the Intel Core i7-8550U processor	L15594-001
(7)	Solid state drive	
	2 TB PCIe NVMe TLC M.2 solid state drive	L16589-001
	1 TB PCIe NVMe TLC M.2 solid state drive	L16588-001
	512 GB PCIe NVMe TLC M.2 solid state drive	L16587-001
	360 GB PCIe NVMe TLC M.2 solid state drive	L16586-001
	256 GB PCIe NVMe TLC M.2 solid state drive	L16585-001
(8)	Fan (left, part of the fan kit)	
	For use with models equipped with the Intel Core i7-8750G processor	L15605-001
	For use with models equipped with the Intel Core i7-8550U processor	L15604-001
(9)	Fan (right, part of the fan kit)	
	For use with models equipped with the Intel Core i7-8750G processor	L15605-001
	For use with models equipped with the Intel Core i7-8550U processor	L15604-001
(10)	USB daughter board (does not include the USB daughter board connector cable, spare part number L15578-001)	L15577-001
(11)	WLAN module	
	Intel Dual band wireless-AC 9260 802.11AC 2x2 WiFi + BT 5.0 Combo Adaptor (non-vPro)	L16647-006
	Intel Dual band wireless-AC 8265 802.11AC 2x2 WiFi + BT 4.2 Combo Adaptor (non-vPro)	921061-856
(12)	TouchPad assembly (in Dark Ash Silver color; does not include the TouchPad assembly connector cable, spare part number L15678-001)	L15589-001
(13)	Audio board (does not include the audio connector cable, spare part number L15576-001)	L15575-001
(14)	Memory card reader (does not include the memory card reader connector cable, spare part number L15580-001)	L15579-001
(15)	Fingerprint reader board (does not include the fingerprint reader board connector cable, spare part number L15584-001)	L15583-001
(16)	Volume button board (does not include the volume button board connector cable, spare part number L15582-001)	L15581-001
(17)	Fingerprint reader module (in Dark Ash Silver color)	L15602-001
(18)	Memory module	
	8GB 2400 MHz DDR 4	862398-855
	4GB 2400 MHz DDR 4	862397-855
(19)	Front speakers (left/right, part number is for speaker kit which includes all four speakers)	L15590-001

Item	Component	Spare part number
(20)	Battery (6-cell, 84-WHr, 3.64Ah, Li-ion)	928372-855
(21)	Bottom cover (in Dark Ash Silver color)	L15591-001

Miscellaneous parts

Component	Spare part number
AC adapter	
For use with models equipped with Intel Core i7-8750G processor	917649-850
For use with models equipped with Intel Core i7-8550U processor	937532-850
Input/Output Adapters	
USB Type-C to VGA	831751-001
USB Type-C to USB Type-A (dongle)	833960-001
USB Type-C to RJ-45 (Ethernet)	901156-001
USB Type-C to Multi-Port Hub	919666-001
Pen	
Sunwoda Active Pen with NSV	910942-001
Sunwoda Active Pen with DAS	920241-001
Impreza Pen, in Dark Ash Silver	929863-001
Sunwoda Active Pen with Cadillac Pen Tip	L04536-001
Sunwoda Active Pen with Impreza Pen Tip	L04536-002
Power cord	
For use in Australia	920689-011
For use in Denmark	920689-007
For use in the European Union	920689-005
For use in Japan	920689-017
For use in North America	920689-001
For use in the People's Republic of China	920689-014
For use in Switzerland	920689-009
For use in the United Kingdom	920689-006
Rubber kit	L15592-001
Screw kit	L15597-001
Computer sleeve	938246-001

4 Removal and replacement procedures preliminary requirements

Tools required

You will need the following tools to complete the removal and replacement procedures:

- Flat-bladed screwdriver
- Magnetic screwdriver
- Phillips P0 and P1 screwdrivers

Service considerations

The following sections include some of the considerations that you must keep in mind during disassembly and assembly procedures.

 **NOTE:** As you remove each subassembly from the computer, place the subassembly (and all accompanying screws) away from the work area to prevent damage.

Plastic parts

 **CAUTION:** Using excessive force during disassembly and reassembly can damage plastic parts. Use care when handling the plastic

Cables and connectors

⚠ CAUTION: When servicing the computer, be sure that cables are placed in their proper locations during the reassembly process. Improper cable placement can damage the computer.

Cables must be handled with extreme care to avoid damage. Apply only the tension required to unseat or seat the cables during removal and insertion. Handle cables by the connector whenever possible. In all cases, avoid bending, twisting, or tearing cables. Be sure that cables are routed in such a way that they cannot be caught or snagged by parts being removed or replaced. Handle flex cables with extreme care; these cables tear easily.

Drive handling

⚠ CAUTION: Drives are fragile components that must be handled with care. To prevent damage to the computer, damage to a drive, or loss of information, observe these precautions:

Before removing or inserting a hard drive, shut down the computer. If you are unsure whether the computer is off or in Hibernation, turn the computer on, and then shut it down through the operating system.

Before handling a drive, be sure that you are discharged of static electricity. While handling a drive, avoid touching the connector.

Before removing an optical drive, be sure that a disc is not in the drive and be sure that the optical drive tray is closed.

Handle drives on surfaces covered with at least one inch of shock-proof foam.

Avoid dropping drives from any height onto any surface.

After removing a hard drive or an optical drive, place it in a static-proof bag.

Avoid exposing an internal hard drive to products that have magnetic fields, such as monitors or speakers.

Avoid exposing a drive to temperature extremes or liquids.

If a drive must be mailed, place the drive in a bubble pack mailer or other suitable form of protective packaging and label the package “FRAGILE.”

Grounding guidelines

Electrostatic discharge damage

Electronic components are sensitive to electrostatic discharge (ESD). Circuitry design and structure determine the degree of sensitivity. Networks built into many integrated circuits provide some protection, but in many cases, ESD contains enough power to alter device parameters or melt silicon junctions.

A discharge of static electricity from a finger or other conductor can destroy static-sensitive devices or microcircuitry. Even if the spark is neither felt nor heard, damage may have occurred.

An electronic device exposed to ESD may not be affected at all and can work perfectly throughout a normal cycle. Or the device may function normally for a while, then degrade in the internal layers, reducing its life expectancy.

CAUTION: To prevent damage to the computer when you are removing or installing internal components, observe these precautions:

Keep components in their electrostatic-safe containers until you are ready to install them.

Before touching an electronic component, discharge static electricity by using the guidelines described in this section.

Avoid touching pins, leads, and circuitry. Handle electronic components as little as possible.

If you remove a component, place it in an electrostatic-safe container.

The following table shows how humidity affects the electrostatic voltage levels generated by different activities.

CAUTION: A product can be degraded by as little as 700 V.

Typical electrostatic voltage levels			
Event	Relative humidity		
	10%	40%	55%
Walking across carpet	35,000 V	15,000 V	7,500 V
Walking across vinyl floor	12,000 V	5,000 V	3,000 V
Motions of bench worker	6,000 V	800 V	400 V
Removing DIPS from plastic tube	2,000 V	700 V	400 V
Removing DIPS from vinyl tray	11,500 V	4,000 V	2,000 V
Removing DIPS from plastic foam	14,500 V	5,000 V	3,500 V
Removing bubble pack from PCB	26,500 V	20,000 V	7,000 V
Packing PCBs in foam-lined box	21,000 V	11,000 V	5,000 V

Packaging and transporting guidelines

Follow these grounding guidelines when packaging and transporting equipment:

- To avoid hand contact, transport products in static-safe tubes, bags, or boxes.
- Protect ESD-sensitive parts and assemblies with conductive or approved containers or packaging.
- Keep ESD-sensitive parts in their containers until the parts arrive at static-free workstations.
- Place items on a grounded surface before removing items from their containers.
- Always be properly grounded when touching a component or assembly.
- Store reusable ESD-sensitive parts from assemblies in protective packaging or nonconductive foam.
- Use transporters and conveyors made of antistatic belts and roller bushings. Be sure that mechanized equipment used for moving materials is wired to ground and that proper materials are selected to avoid static charging. When grounding is not possible, use an ionizer to dissipate electric charges.

Workstation guidelines

Follow these grounding workstation guidelines:

- Cover the workstation with approved static-shielding material.
- Use a wrist strap connected to a properly grounded work surface and use properly grounded tools and equipment.
- Use conductive field service tools, such as cutters, screwdrivers, and vacuums.
- When fixtures must directly contact dissipative surfaces, use fixtures made only of static safe materials.
- Keep the work area free of nonconductive materials, such as ordinary plastic assembly aids and plastic foam.
- Handle ESD-sensitive components, parts, and assemblies by the case or PCM laminate. Handle these items only at static-free workstations.
- Avoid contact with pins, leads, or circuitry.
- Turn off power and input signals before inserting or removing connectors or test equipment.

Equipment guidelines

Grounding equipment must include either a wrist strap or a foot strap at a grounded workstation.

- When seated, wear a wrist strap connected to a grounded system. Wrist straps are flexible straps with a minimum of one megohm $\pm 10\%$ resistance in the ground cords. To provide proper ground, wear a strap snugly against the skin at all times. On grounded mats with banana-plug connectors, use alligator clips to connect a wrist strap.
- When standing, use foot straps and a grounded floor mat. Foot straps (heel, toe, or boot straps) can be used at standing workstations and are compatible with most types of shoes or boots. On conductive floors or dissipative floor mats, use foot straps on both feet with a minimum of one megohm resistance between the operator and ground. To be effective, the conductive equipment must be worn in contact with the skin.

The following grounding equipment is recommended to prevent electrostatic damage:

- Antistatic tape
- Antistatic smocks, aprons, and sleeve protectors
- Conductive bins and other assembly or soldering aids
- Nonconductive foam
- Conductive tabletop workstations with ground cords of one megohm resistance
- Static-dissipative tables or floor mats with hard ties to the ground
- Field service kits
- Static awareness labels
- Material-handling packages
- Nonconductive plastic bags, tubes, or boxes
- Metal tote boxes
- Electrostatic voltage levels and protective materials

The following table lists the shielding protection provided by antistatic bags and floor mats.

Material	Use	Voltage protection level
Antistatic plastics	Bags	1,500 V
Carbon-loaded plastic	Floor mats	7,500 V
Metallized laminate	Floor mats	5,000 V

5 Removal and replacement procedures for authorized service provider parts

 **CAUTION:** Components described in this chapter should be accessed only by an authorized service provider. Accessing these parts can damage the computer or void the warranty.

CAUTION: This computer does not have user-replaceable parts. Only HP authorized service providers should perform the removal and replacement procedures described here. Accessing the internal part could damage the computer or void the warranty.

Component replacement procedures

 **NOTE:** Details about your computer, including model, serial number, product key, and length of warranty, are on the service tag at the bottom of your computer. See [Locating system information on page 17](#) for details.

 **NOTE:** HP continually improves and changes product parts. For complete and current information on supported parts for your computer, go to <http://partsurfer.hp.com>, select your country or region, and then follow the on-screen instructions.

There are as many as xx screws that must be removed, replaced, and/or loosened when servicing the parts described in this chapter. Make special note of each screw size and location during removal and replacement.

Bottom cover

 **NOTE:** The bottom cover spare part does not include the rubber foot. The rubber kit spare part number is L15592-001.

Description	Spare part number
Bottom cover in Dark Ash Silver	L15591-001

 **IMPORTANT:** Make special note of each screw and screw lock size and location during removal and replacement

Before removing the bottom cover, follow these steps:

1. Shut down the computer.
2. Disconnect all external devices connected to the computer.
3. Disconnect the power from the computer by first unplugging the power cord from the AC outlet and then unplugging the AC adapter from the computer.

Remove the bottom cover:

1. Remove the rubber foot covering four of the screws that secure the bottom cover to the computer **(1)**.
2. Remove the four Phillips PM2.0×10.0 screws **(2)**.
3. Remove the two Phillips PM2.0×3.5 screws **(3)**.

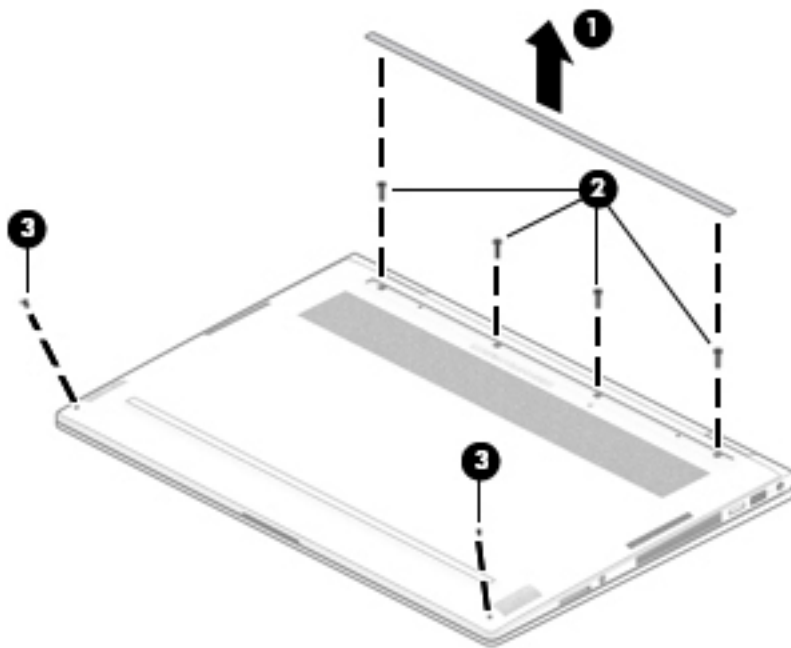

4. Lift the bottom cover off of the computer.

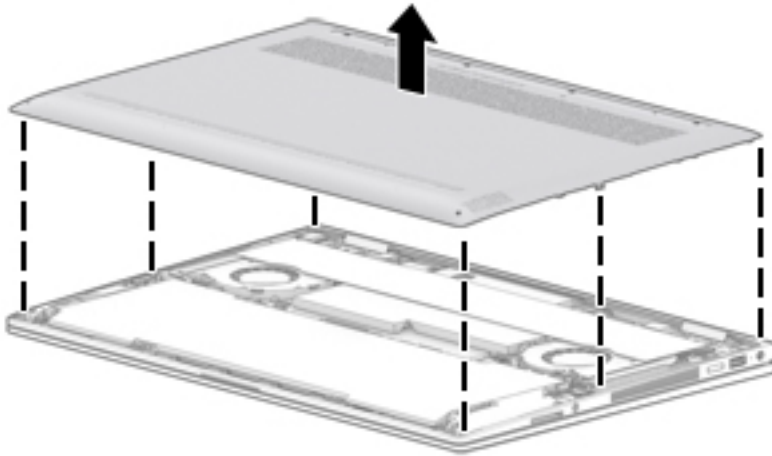

Reverse this procedure to install the bottom cover.

Battery

Description	Spare part number
6-cell, 84-WHr, 3.7-Ahr, Li-ion battery	928372-855

 **IMPORTANT:** Make special note of each screw and screw lock size and location during removal and replacement

Before removing the battery, follow these steps:

1. Shut down the computer.
2. Disconnect all external devices connected to the computer.
3. Disconnect the power from the computer by first unplugging the power cord from the AC outlet and then unplugging the AC adapter from the computer.
4. Remove the bottom cover (see [Bottom cover on page 29](#)).

Remove the battery:

1. Disconnect the battery cable from the system board **(1)**.
2. Remove the five Phillips PM2.0×3.5 screws **(2)** that secure the battery to the computer.
3. Lift the battery out of the computer **(3)**.

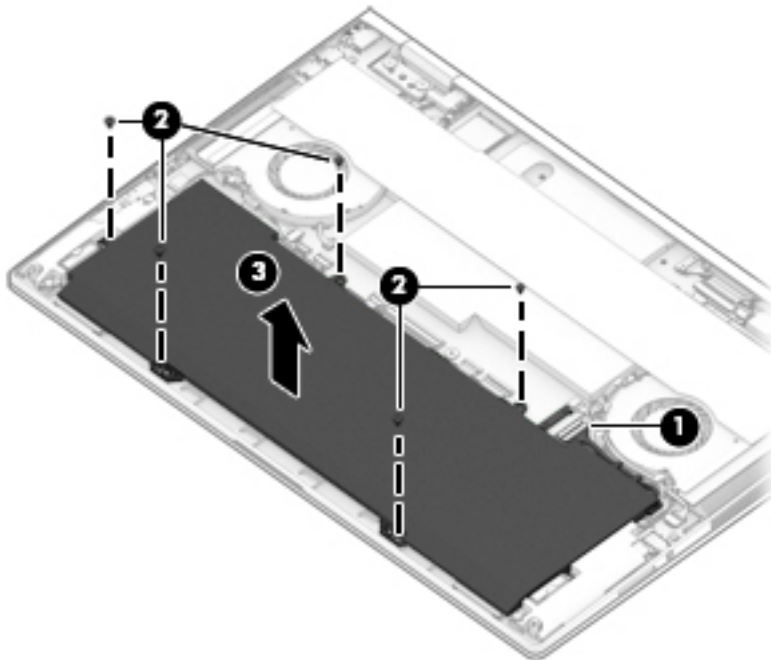

Reverse this procedure to install the battery.

Front speakers

 **NOTE:** The speaker spare part kit includes all four speakers.

Description	Spare part number
Speaker kit	L15590-001

 **IMPORTANT:** Make special note of each screw and screw lock size and location during removal and replacement

Before removing the front speakers, follow these steps:

1. Shut down the computer.
2. Disconnect all external devices connected to the computer.
3. Disconnect the power from the computer by first unplugging the power cord from the AC outlet and then unplugging the AC adapter from the computer.
4. Remove the bottom cover (see [Bottom cover on page 29](#)), and then remove the following components:
 - ▲ Battery (see [Battery on page 31](#)).

Remove the front speakers:

1. Disconnect the front speaker cables from the system board **(1)**.
2. Remove the front speaker cables from the retaining clips that secure them to the computer **(2)**.
3. Remove the four Phillips PM2.0×4.5 screws **(3)**.
4. Lift the front speakers out of the computer **(4)**.

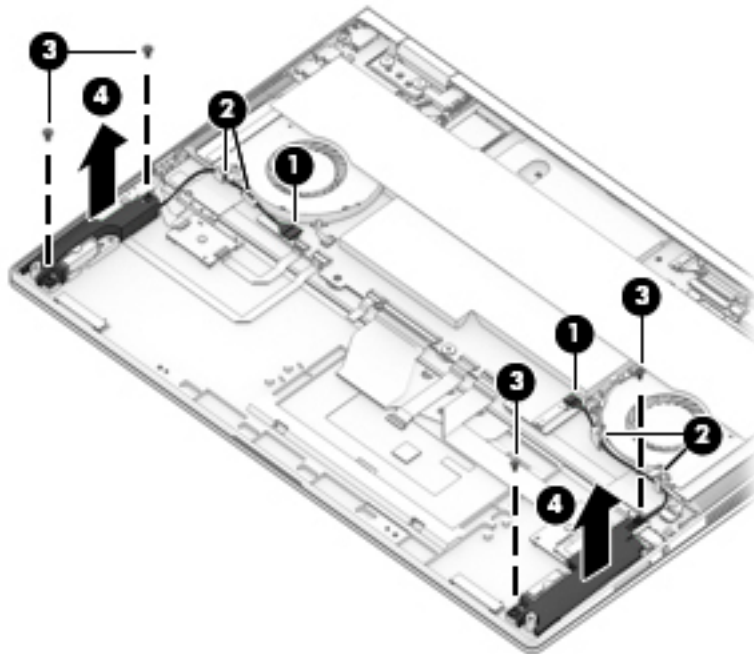

Reverse this procedure to install the front speakers.

Volume button board

 **NOTE:** The volume button board spare part kit does not include the volume button board cable (spare part number L15582-001).

Description	Spare part number
Volume button board	L15581-001

 **IMPORTANT:** Make special note of each screw and screw lock size and location during removal and replacement

Before removing the volume button board, follow these steps:

1. Shut down the computer.
2. Disconnect all external devices connected to the computer.
3. Disconnect the power from the computer by first unplugging the power cord from the AC outlet and then unplugging the AC adapter from the computer.
4. Remove the bottom cover (see [Bottom cover on page 29](#)), and then remove the following components:
 - a. Battery (see [Battery on page 31](#)).
 - b. Front speakers (see [Front speakers on page 32](#)).

Remove the volume button board:

1. Release the volume button board cable from the zero insertion force (ZIF) connector on the system board **(1)**.
2. Remove the volume button board cable from the keyboard/top cover **(2)**.

 **NOTE:** Due to the adhesive located between the volume button board cable and the keyboard/top cover, it may be necessary to move the cable from side to side to detach it.

3. Remove the Phillips PM2.0×3.5 screw **(3)** that secures the board to the computer.

4. Lift the volume button board out of the computer **(4)**.

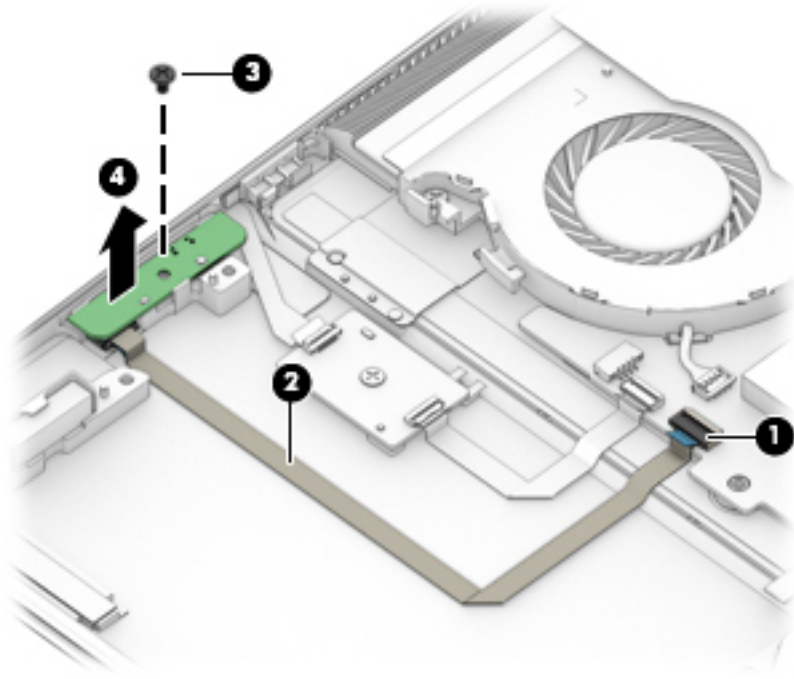

Reverse this procedure to install the volume button board.

Fingerprint reader module

Description	Spare part number
Fingerprint reader module	L15602-001

 **IMPORTANT:** Make special note of each screw and screw lock size and location during removal and replacement

Before removing the fingerprint reader module, follow these steps:

1. Shut down the computer.
2. Disconnect all external devices connected to the computer.
3. Disconnect the power from the computer by first unplugging the power cord from the AC outlet and then unplugging the AC adapter from the computer.
4. Remove the bottom cover (see [Bottom cover on page 29](#)), and then remove the following components:
 - ▲ Battery (see [Battery on page 31](#)).

Remove the fingerprint reader module:

1. Release the fingerprint reader module cable from the ZIF connector on the fingerprint reader board (1).
2. Remove the fingerprint reader module bracket (2).
3. Remove the fingerprint reader module and cable (3).

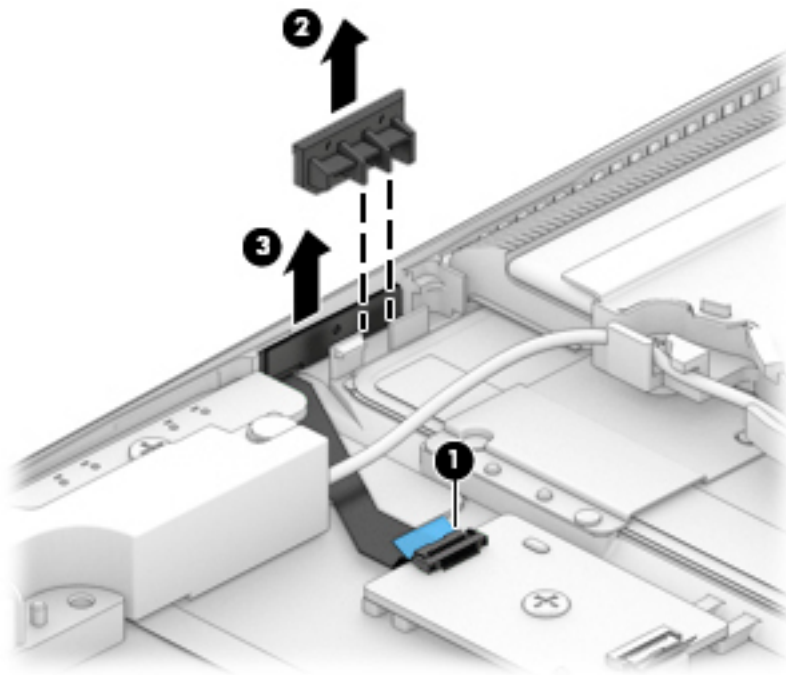

Reverse this procedure to install the fingerprint reader module.

Fingerprint reader board

 **NOTE:** The fingerprint reader board spare part kit does not include the fingerprint reader board cable (spare part number L15584-001).

Description	Spare part number
Fingerprint reader board	L15583-001

 **IMPORTANT:** Make special note of each screw and screw lock size and location during removal and replacement

Before removing the fingerprint reader board, follow these steps:

1. Shut down the computer.
2. Disconnect all external devices connected to the computer.
3. Disconnect the power from the computer by first unplugging the power cord from the AC outlet and then unplugging the AC adapter from the computer.
4. Remove the bottom cover (see [Bottom cover on page 29](#)), and then remove the following components:
 - ▲ Battery (see [Battery on page 31](#)).

Remove the fingerprint reader board:

1. Release the fingerprint reader board cable from the ZIF connector on the system board **(1)**.
2. Release the fingerprint reader module cable from the ZIF connector on the fingerprint reader board **(2)**.
3. Remove the Phillips PM2.0×3.5 screw **(3)**.
4. Remove the fingerprint reader board and cable from the computer **(3)**.

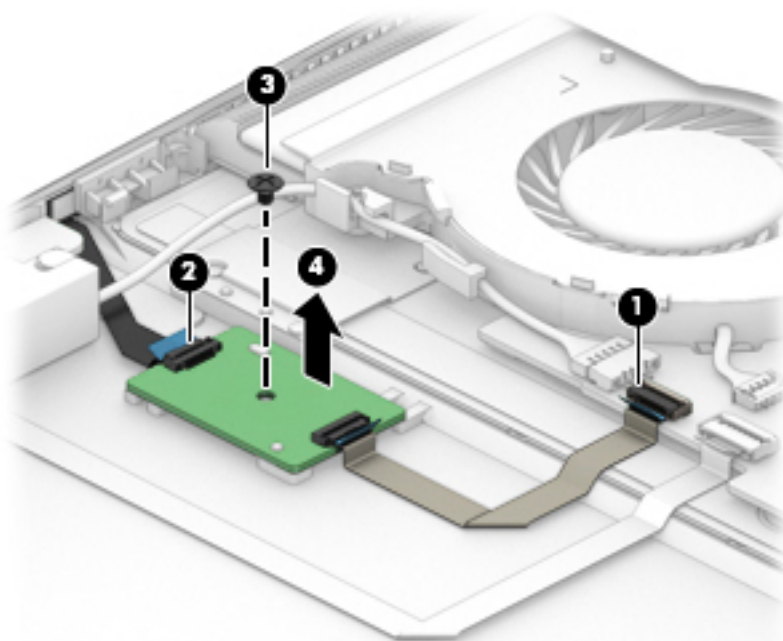

Reverse this procedure to install the fingerprint reader board.

WLAN module

Description	Spare part number
Intel Dual band wireless-AC 9260 802.11AC 2x2 WiFi + BT 5.0 Combo Adaptor (non-vPro)	L16647-006
Intel Dual band wireless-AC 8265 802.11AC 2x2 WiFi + BT 4.2 Combo Adaptor (non-vPro)	921061-856

 **IMPORTANT:** Make special note of each screw and screw lock size and location during removal and replacement

Before removing the WLAN module, follow these steps:

1. Shut down the computer.
2. Disconnect all external devices connected to the computer.
3. Disconnect the power from the computer by first unplugging the power cord from the AC outlet and then unplugging the AC adapter from the computer.
4. Remove the bottom cover (see [Bottom cover on page 29](#)), and then remove the following components:
 - ▲ Battery (see [Battery on page 31](#)).

Remove the WLAN module:

1. Disconnect the WLAN antenna cables (**1**) from the terminals on the WLAN module.

 **NOTE:** The WLAN antenna cable labeled "1" connects to the WLAN module "Main" terminal labeled "1." The WLAN antenna cable labeled "2" connects to the WLAN module "Aux" terminal labeled "2."

2. Remove the Phillips PM2.0×2.5 screw (**2**) that secures the WLAN module to the system board (the WLAN module tilts up).

3. Remove the WLAN module (3) by pulling the module away from the slot at an angle.

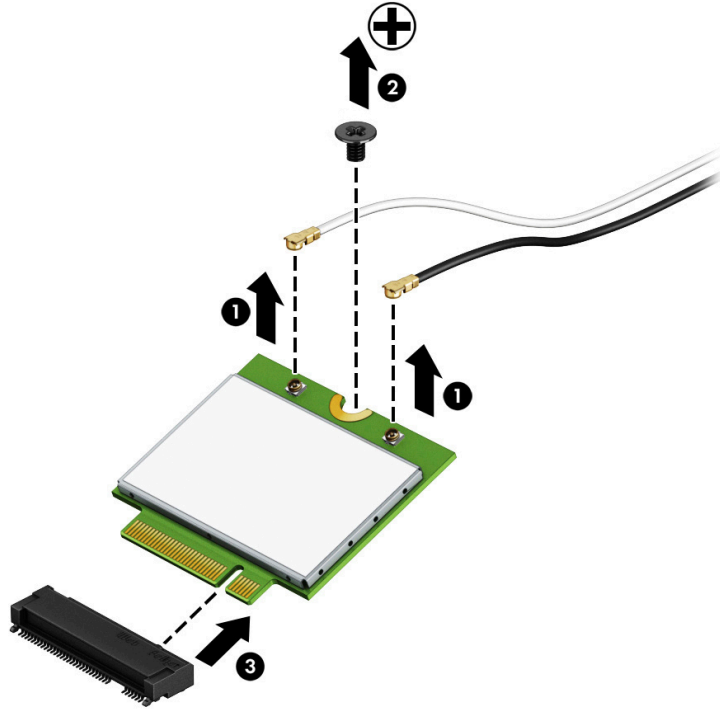

 **NOTE:** The WLAN module configuration in the computer may not match the illustration exactly.

Reverse this procedure to install the WLAN module.

USB daughter board

 **NOTE:** The USB daughter board spare part kit does not include the USB daughter board cable (spare part number L15578-001).

Description	Spare part number
USB daughter board	L15577-001

 **IMPORTANT:** Make special note of each screw and screw lock size and location during removal and replacement

Before removing the USB daughter board, follow these steps:

1. Shut down the computer.
2. Disconnect all external devices connected to the computer.
3. Disconnect the power from the computer by first unplugging the power cord from the AC outlet and then unplugging the AC adapter from the computer.
4. Remove the bottom cover (see [Bottom cover on page 29](#)), and then remove the following components:
 - ▲ Battery (see [Battery on page 31](#)).

Remove the USB daughter board:

1. Release the USB daughter board cable from the ZIF connector on the system board **(1)**.
2. Remove the Phillips PM2.0×3.5 screw **(2)** that secures the USB daughter board to the computer.
3. Remove the USB daughter board from the computer **(3)**.
4. Remove the two adhesive tapes from the board before replacing the board **(4)**.

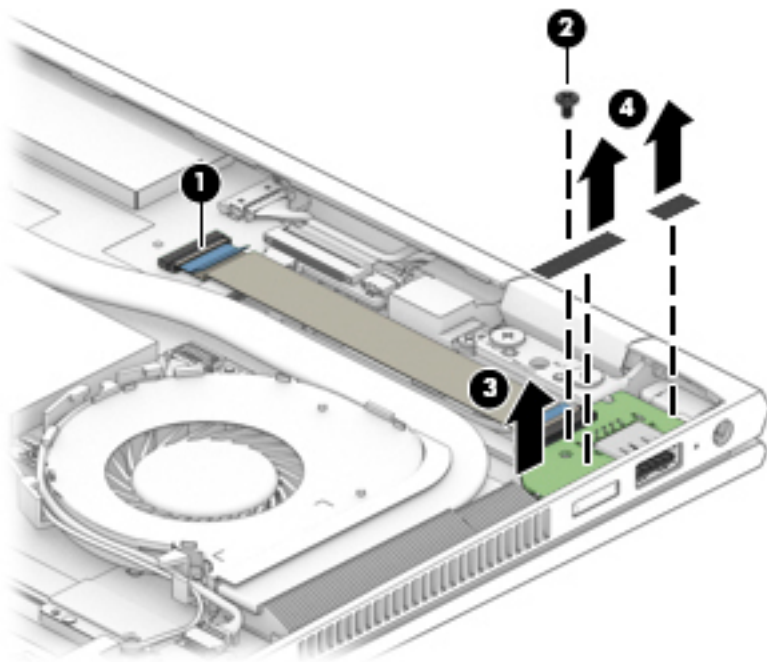

Reverse this procedure to install the USB daughter board.

Audio board

 **NOTE:** The audio board spare part kit does not include the audio board cable (spare part number L15576-001).

Description	Spare part number
Audio board	L15575-001

 **IMPORTANT:** Make special note of each screw and screw lock size and location during removal and replacement

Before removing the audio board, follow these steps:

1. Shut down the computer.
2. Disconnect all external devices connected to the computer.
3. Disconnect the power from the computer by first unplugging the power cord from the AC outlet and then unplugging the AC adapter from the computer.
4. Remove the bottom cover (see [Bottom cover on page 29](#)), and then remove the following components:
 - a. Battery (see [Battery on page 31](#)).
 - b. Front speakers (see [Front speakers on page 32](#)).

Remove the audio board:

1. Disconnect the audio board cable from the system board **(1)**.
2. Release the audio board cable from the retaining clips securing the cable to the computer **(2)**.
3. Remove the Phillips PM2.0×3.5 screw **(3)** securing the audio board to the computer.
4. Remove the audio board from the computer **(4)**.

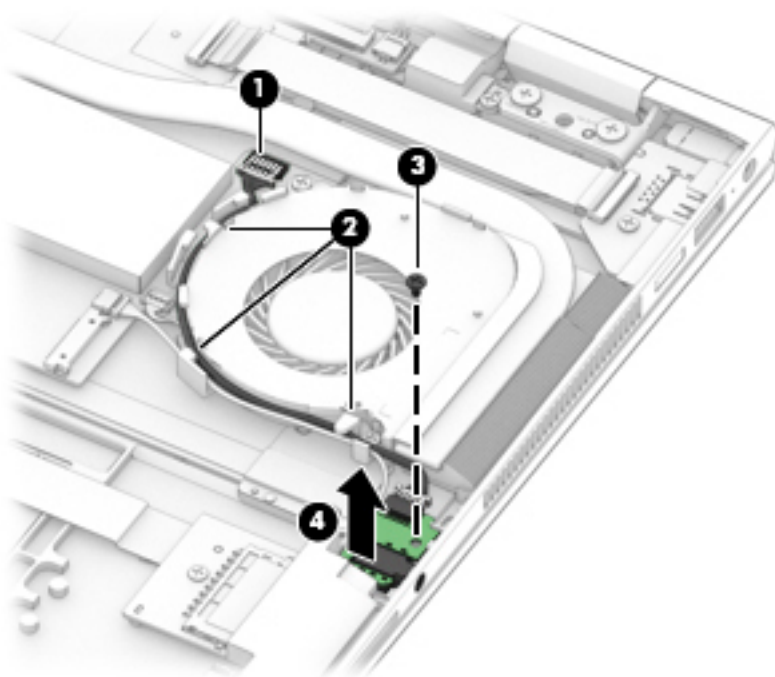

Reverse this procedure to install the audio board.

Memory card reader board

 **NOTE:** The memory card reader board spare part kit does not include the memory card reader cable (spare part number L15580-001).

Description	Spare part number
Memory card reader board	L15579-001

 **IMPORTANT:** Make special note of each screw and screw lock size and location during removal and replacement

Before removing the memory card reader board, follow these steps:

1. Shut down the computer.
2. Disconnect all external devices connected to the computer.
3. Disconnect the power from the computer by first unplugging the power cord from the AC outlet and then unplugging the AC adapter from the computer.
4. Remove the bottom cover (see [Bottom cover on page 29](#)), and then remove the following components:
 - a. Battery (see [Battery on page 31](#)).
 - b. Front speakers (see [Front speakers on page 32](#)).

Remove the memory card reader board:

1. Release the memory card reader board cable from the ZIF connector on the system board **(1)**.
2. Remove the Phillips PM2.0×2.5 screw **(2)**.
3. Remove the memory card reader board from the computer **(3)**.

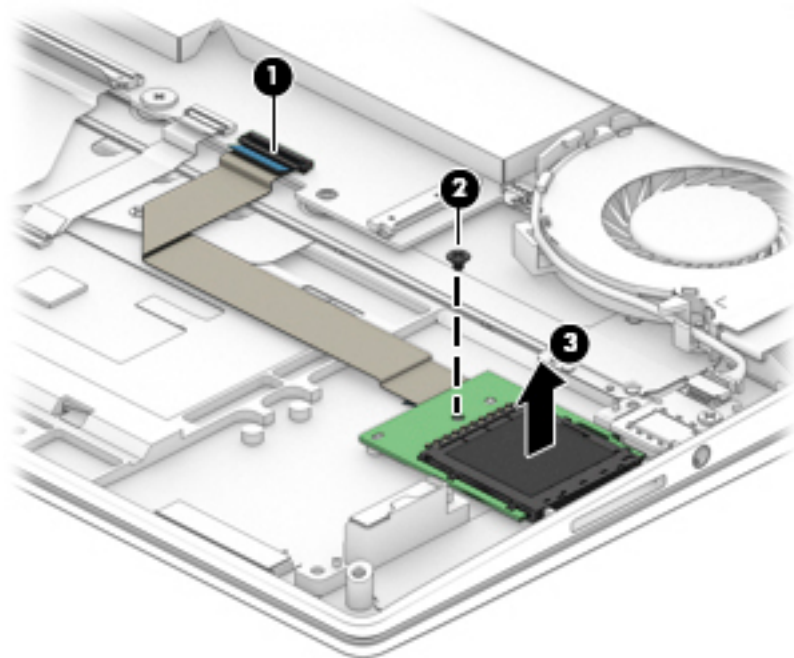

Reverse this procedure to install the memory card reader board.

TouchPad assembly

 **NOTE:** The TouchPad assembly spare part kit does not include the TouchPad cable (spare part number L15678-001).

Description	Spare part number
TouchPad assembly	L15589-001

 **IMPORTANT:** Make special note of each screw and screw lock size and location during removal and replacement

Before removing the TouchPad assembly, follow these steps:

1. Shut down the computer.
2. Disconnect all external devices connected to the computer.
3. Disconnect the power from the computer by first unplugging the power cord from the AC outlet and then unplugging the AC adapter from the computer.
4. Remove the bottom cover (see [Bottom cover on page 29](#)), and then remove the following components:
 - a. Battery (see [Battery on page 31](#)).
 - b. Front speakers (see [Front speakers on page 32](#)).
 - c. Memory card reader board (see [Memory card reader board on page 42](#)).

Remove the TouchPad assembly:

1. Release the TouchPad cable from the ZIF connector on the system board **(1)**.
2. Release the TouchPad cable from the ZIF connector on the TouchPad assembly **(2)**.
3. Remove the TouchPad cable **(3)**.

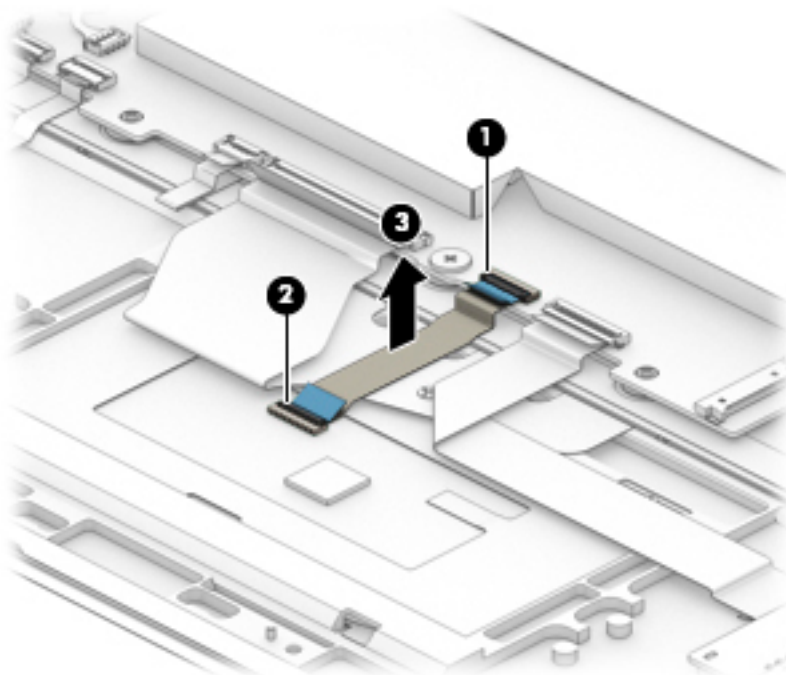

4. Remove the TouchPad cable (see above) **(1)**.
5. Remove the three Phillips PM2.0×2.0 screws **(2)**.
6. Lift the TouchPad at an angle toward the front of the computer **(3)**.
7. Slide the TouchPad assembly out of the retaining bracket and remove it from the computer **(4)**.

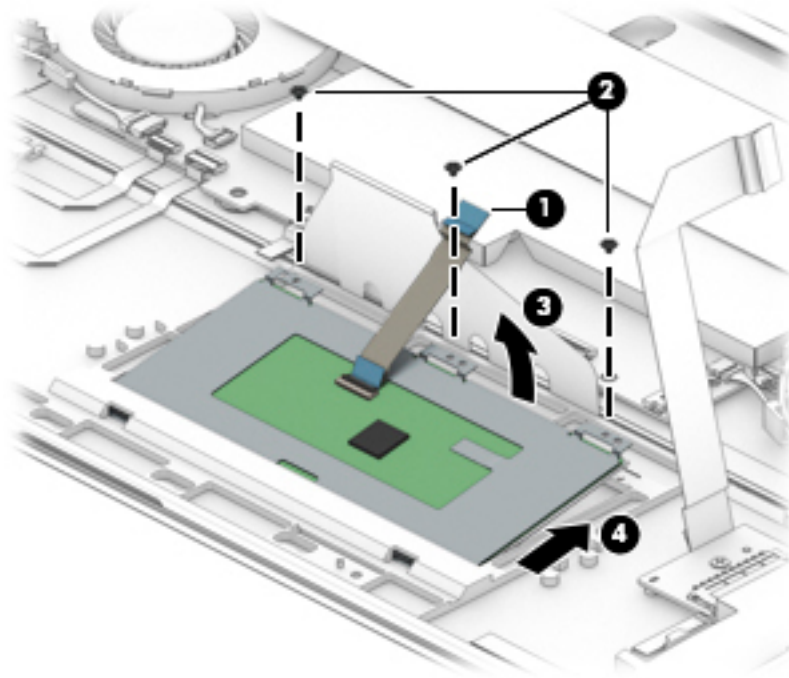

Reverse this procedure to install the TouchPad assembly.

Left fan

 **NOTE:** The fan spare part kit includes both fans.

Description	Spare part number
Fan kit for use with models equipped with the Intel Core i7-8750G processor	L15605-001
Fan kit for use with models equipped with the Intel Core i5-8550U processor	L15604-001

 **IMPORTANT:** Make special note of each screw and screw lock size and location during removal and replacement

Before removing the left fan, follow these steps:

1. Shut down the computer.
2. Disconnect all external devices connected to the computer.
3. Disconnect the power from the computer by first unplugging the power cord from the AC outlet and then unplugging the AC adapter from the computer.
4. Remove the bottom cover (see [Bottom cover on page 29](#)), and then remove the following components:
 - a. Battery (see [Battery on page 31](#)).
 - b. Front speakers (see [Front speakers on page 32](#)).

Remove the left fan:

1. Remove the mylar covering the system board and other components.

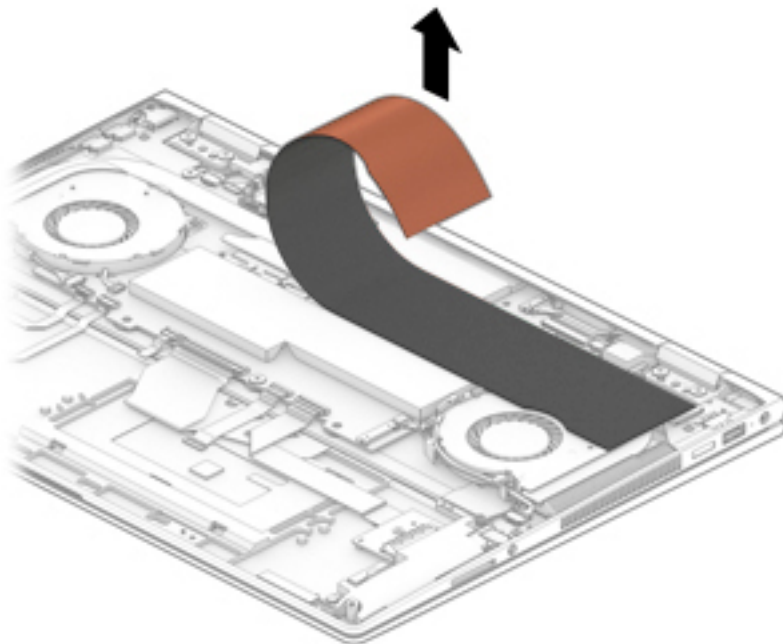

2. Disconnect the left fan cable **(1)**.
3. Remove the left fan cable from the retaining clips that secure it to the computer **(2)**.

4. Remove the two Phillips PM2.0×3.5 screws **(3)** that secure the left fan to the computer.
5. Remove the left fan from the computer **(4)**.

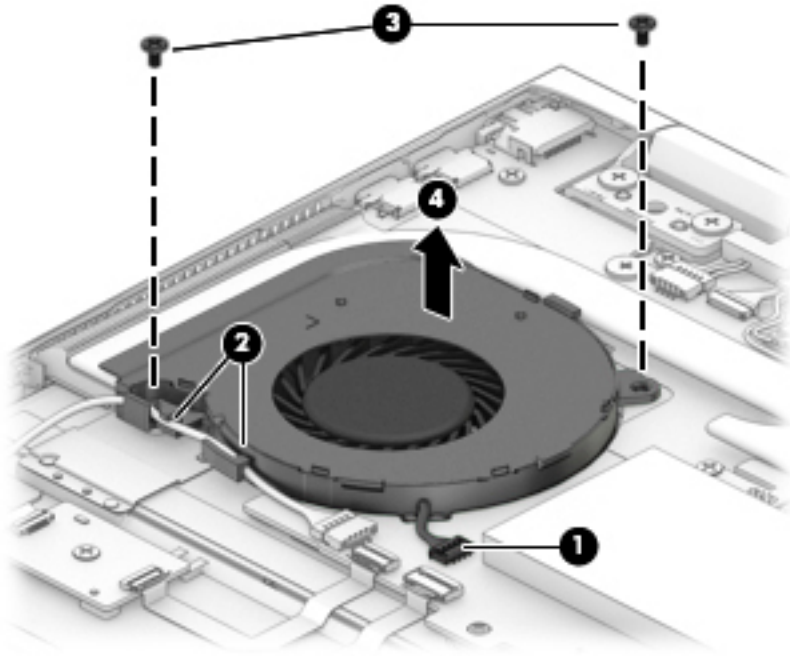

Reverse this procedure to install the left fan.

Right fan

 **NOTE:** The fan spare part kit includes both fans.

Description	Spare part number
Fan kit for use with models equipped with the Intel Core i7-8750G processor	L15605-001
Fan kit for use with models equipped with the Intel Core i5-8550U processor	L15604-001

 **IMPORTANT:** Make special note of each screw and screw lock size and location during removal and replacement

Before removing the left fan, follow these steps:

1. Shut down the computer.
2. Disconnect all external devices connected to the computer.
3. Disconnect the power from the computer by first unplugging the power cord from the AC outlet and then unplugging the AC adapter from the computer.
4. Remove the bottom cover (see [Bottom cover on page 29](#)), and then remove the following components:
 - a. Battery (see [Battery on page 31](#)).
 - b. Front speakers (see [Front speakers on page 32](#)).
 - c. System board mylar (see [Left fan on page 45](#)).

Remove the right fan:

1. Disconnect the right fan cable **(1)**.
2. Remove the right fan cable from the retaining clips that secure it to the computer **(2)**.
3. Remove the two Phillips PM2.0×3.5 screws **(3)** that secure the right fan to the computer.

4. Remove the right fan from the computer (4).

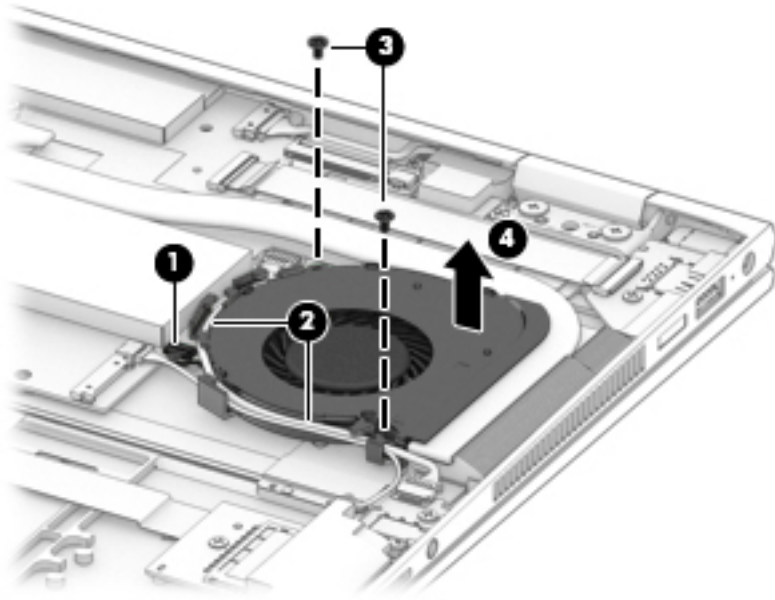

Reverse this procedure to install the right fan.

Solid state drive

Description	Spare part number
2 TB PCIe NVMe TLC M.2 solid state drive	L16589-001
1 TB PCIe NVMe TLC M.2 solid state drive	L16588-001
512 GB PCIe NVMe TLC M.2 solid state drive	L16587-001
360 GB PCIe NVMe TLC M.2 solid state drive	L16586-001
256 GB PCIe NVMe TLC M.2 solid state drive	L16585-001

 **IMPORTANT:** Make special note of each screw and screw lock size and location during removal and replacement

Before removing the solid state drive, follow these steps:

1. Shut down the computer.
2. Disconnect all external devices connected to the computer.
3. Disconnect the power from the computer by first unplugging the power cord from the AC outlet and then unplugging the AC adapter from the computer.
4. Remove the bottom cover (see [Bottom cover on page 29](#)), and then remove the following components:
 - a. Battery (see [Battery on page 31](#)).
 - b. Front speakers (see [Front speakers on page 32](#)).
 - c. System board mylar (see [Left fan on page 45](#)).
 - d. USB daughter board cable (see [USB daughter board on page 39](#)).

 **NOTE:** Removal of the USB daughter board is not required for this procedure. Only the cable must be removed (and can then be reused).

Remove the solid state drive:

1. Remove the Phillips PM2.0×2.5 screw **(1)**.

2. Remove the solid state drive at an angle (2).

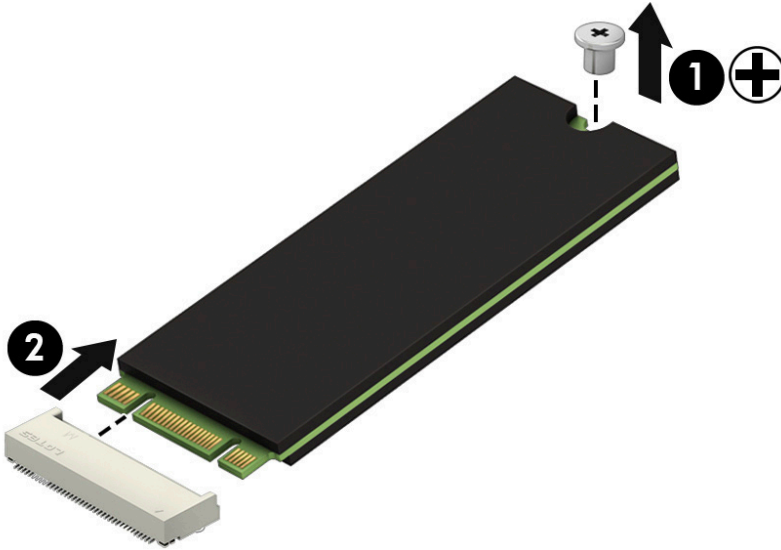

Reverse this procedure to install the solid state drive.

Memory module

Description	Spare part number
8192 MB 2400 MHz DDR4	862398-855
4096MB 2400 MHz DDR4	862397-855

Before removing the memory module, follow these steps:

1. Shut down the computer.
2. Disconnect all external devices connected to the computer.
3. Disconnect the power from the computer by first unplugging the power cord from the AC outlet and then unplugging the AC adapter from the computer.
4. Remove the bottom cover (see [Bottom cover on page 29](#)), and then remove the following components:
 - a. Battery (see [Battery on page 31](#)).
 - b. Front speakers (see [Front speakers on page 32](#)).
 - c. System board mylar (see [Left fan on page 45](#)).

Remove the memory module:

1. Release the retention clips holding the memory module in place **(1)**.
2. Slide the memory module out of the connector **(2)**.

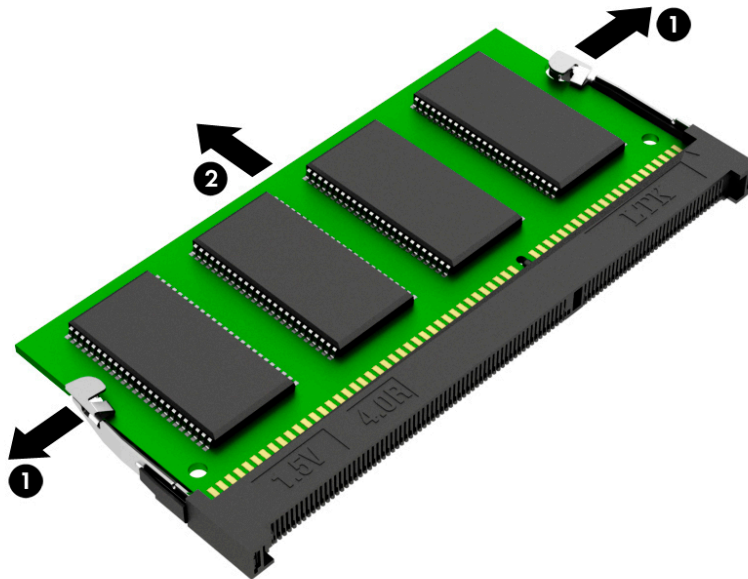

Reverse this procedure to install the memory module.

System board



NOTE: The system board spare part kit includes the heatsink, attached to the system board.

Description	Spare part number
Equipped with an Intel Core i7-8705G (Up to 3.1 GHz, turbo up to 4.1 GHz, 2400 MHz, 8MB L2 cache, quad core, 150W) processor, a graphic subsystem with a Radeon RX VEGA M 4GB GPU, and the Windows 10 Pro operating system	L15574-601
Equipped with an Intel Core i7-8705G (Up to 3.1 GHz, turbo up to 4.1 GHz, 2400 MHz, 8MB L2 cache, quad core, 150W) processor, a graphic subsystem with a Radeon RX VEGA M 4GB GPU, and a non-Windows 10 Pro operating system	L15574-001
Equipped with an Intel Core i7-8550U (Up to 1.8GHz, turbo up to 4.0 GHz, 2400 MHz, 8MB L2 cache, quad core 90W) processor, a graphic subsystem with a NVIDIA N175-G1 (GeForce MX150) 2GB GPU, and the Windows 10 operating system	L155573-601
Equipped with an Intel Core i7-8550U (Up to 1.8GHz, turbo up to 4.0 GHz, 2400 MHz, 8MB L2 cache, quad core 90W) processor, a graphic subsystem with a NVIDIA N175-G1 (GeForce MX150) 2GB GPU, and a non-Windows 10 operating system	L155573-001



IMPORTANT: Make special note of each screw and screw lock size and location during removal and replacement

Before removing the system board, follow these steps:

1. Shut down the computer.
2. Disconnect all external devices connected to the computer.
3. Disconnect the power from the computer by first unplugging the power cord from the AC outlet and then unplugging the AC adapter from the computer.
4. Remove the bottom cover (see [Bottom cover on page 29](#)), and then remove the following components:
 - a. Battery (see [Battery on page 31](#)).
 - b. System board mylar (see [Left fan on page 45](#)).
 - c. Left fan (see [Left fan on page 45](#)).
 - d. Right fan (see [Right fan on page 47](#)).

Remove the system board:

1. Disconnect the left rear speaker cable from the system board **(1)**.
2. Disconnect the webcam cable from the system board **(2)**.
3. Disconnect the WLAN module cables from the WLAN module **(3)**.
4. Disconnect the left front speaker cable from the system board **(4)**.
5. Disconnect the fingerprint reader board cable from the system board **(5)**.
6. Disconnect the volume button board cable from the system board **(6)**.
7. Disconnect the keyboard backlight cable from the system board **(7)**.

8. Disconnect the keyboard cable from the system board **(8)**.

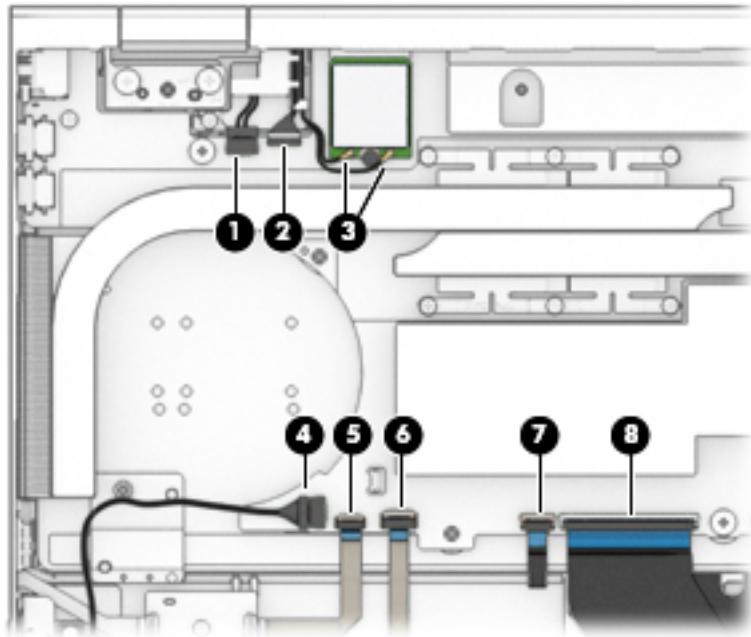

9. Disconnect the power connector cable from the system board **(9)**.
10. Disconnect the display panel cable from the system board **(10)**.
11. Disconnect the right rear speaker cable from the system board **(11)**.
12. Disconnect the USB daughter board cable from the system board **(12)**.
13. Disconnect the right front speaker cable from the system board **(13)**.
14. Disconnect the TouchPad assembly cable from the system board **(14)**.
15. Disconnect the memory card reader board cable from the system board **(15)**.

16. Disconnect the audio board cable from the system board (16).

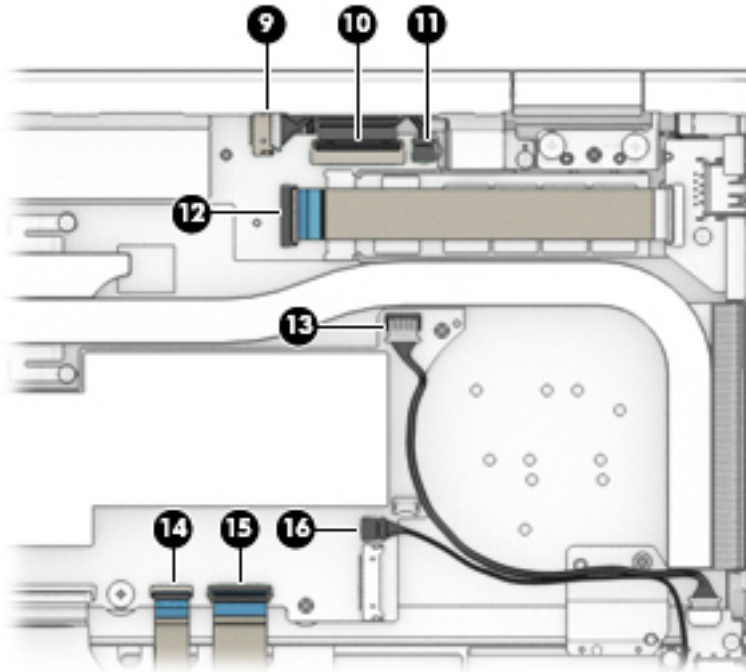

17. Remove the Phillips PM2.0×3.5 screw (1) that secures the system board to the computer.
18. Remove the two Phillips PM2.0×3.5 screws (2) that secures the system board to the computer.
19. Remove the system board from the computer (3).

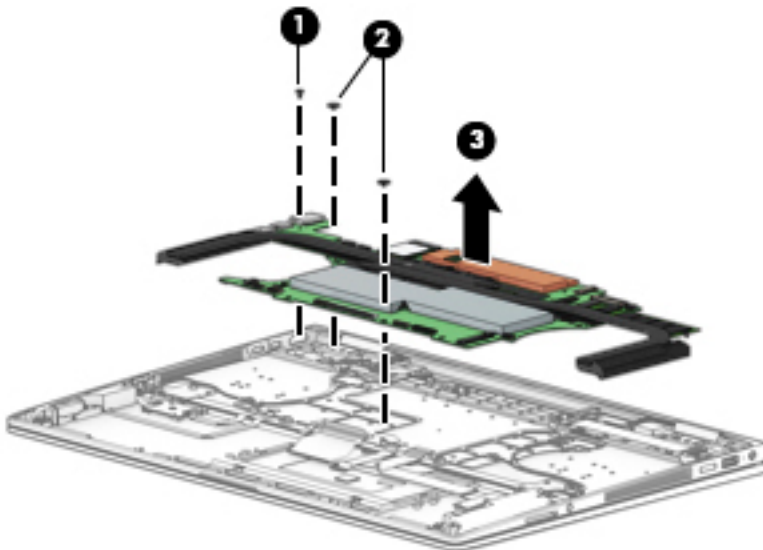

CAUTION: Take care when removing the system board to avoid damaging critical computer parts.

Reverse this procedure to install the system board.

Rear speakers



NOTE: The speaker spare part kit includes all four speakers.

Description	Spare part number
Speaker kit	L15590-001



IMPORTANT: Make special note of each screw and screw lock size and location during removal and replacement

Before removing the Rear speakers, follow these steps:

1. Shut down the computer.
2. Disconnect all external devices connected to the computer.
3. Disconnect the power from the computer by first unplugging the power cord from the AC outlet and then unplugging the AC adapter from the computer.
4. Remove the bottom cover (see [Bottom cover on page 29](#)), and then remove the following components:
 - a. Battery (see [Battery on page 31](#)).
 - b. System board mylar (see [Left fan on page 45](#)).
 - c. Left fan (see [Left fan on page 45](#)).
 - d. Right fan(see [Right fan on page 47](#)).
 - e. System board (see [System board on page 52](#)).

Remove the rear speakers:

1. Remove the two Phillips PM2.0×3.5 screws **(1)** that secure the speakers to the keyboard/top cover.
2. Remove the two Phillips PM2.0×2.0 screws **(2)** that secure the speakers to the keyboard/top cover.
3. Release the left rear speaker cable from the retaining clips **(3)**.

4. Remove the speakers from the keyboard/top cover (4).

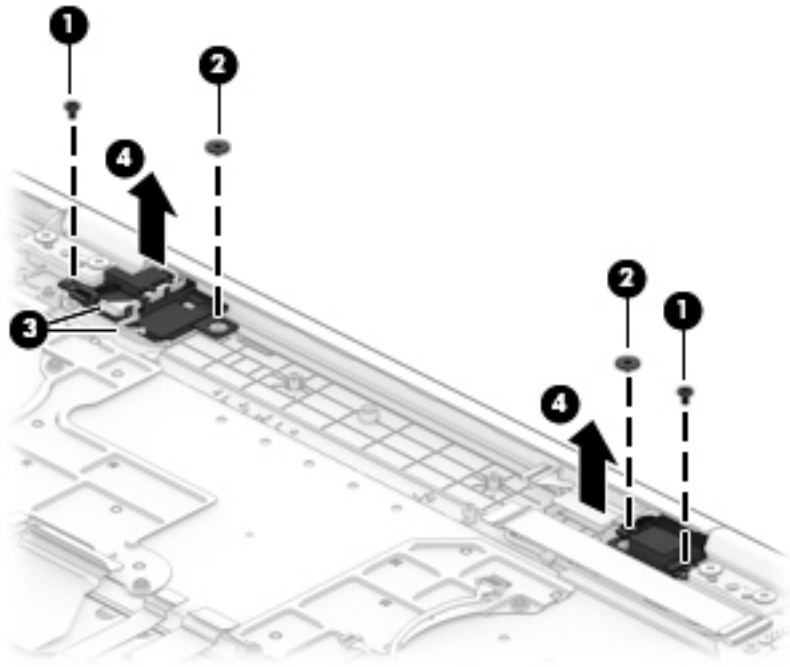

Reverse this procedure to install the rear speakers.

Power connector cable

Description	Spare part number
Power connector cable	L15586-001

 **IMPORTANT:** Make special note of each screw and screw lock size and location during removal and replacement

Before removing the power connector cable, follow these steps:

1. Shut down the computer.
2. Disconnect all external devices connected to the computer.
3. Disconnect the power from the computer by first unplugging the power cord from the AC outlet and then unplugging the AC adapter from the computer.
4. Remove the bottom cover (see [Bottom cover on page 29](#)), and then remove the following components:
 - a. Battery (see [Battery on page 31](#)).
 - b. Rear speakers (see [Rear speakers on page 55](#)).
 - c. USB daughter board (see [USB daughter board on page 39](#)).
 - d. Solid state drive (see [Solid state drive on page 49](#)).
 - e. System board (see [System board on page 52](#)).

Remove the power connector cable:

1. Release the power connector cable from the routing path clips **(1)**.
2. Remove the Phillips PM2.0×3.5 screw **(2)**.

3. Remove the power connector cable from the computer (3).

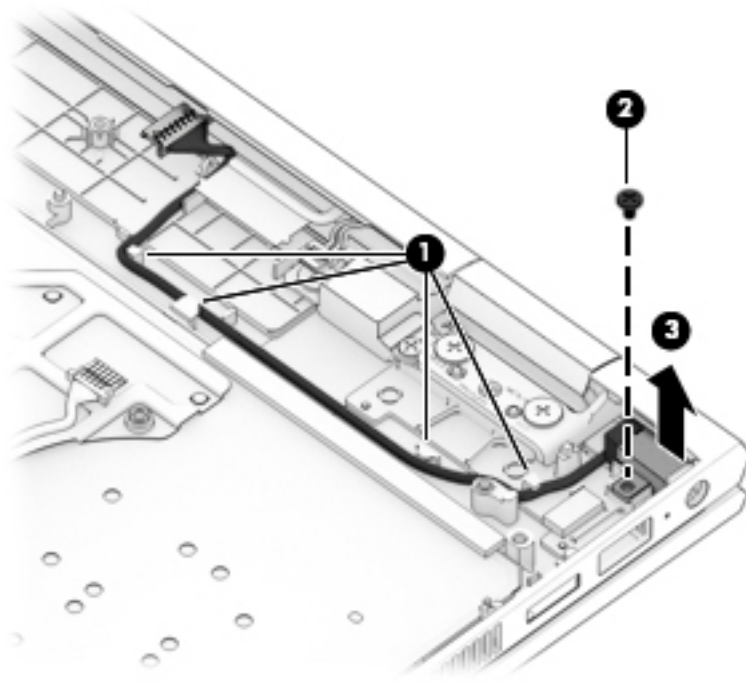

Reverse this procedure to install the power connector cable.

Display panel assembly

 **NOTE:** The display panel assembly spare part kit includes the entire display panel assembly from the hinge-up.

Description	Spare part number
15.6" UHD WLED BrightView (3840x2160) uslim-flat (2.6mm) UWVA, eDP+PSR, Narrow Bezel	L15596-001

 **IMPORTANT:** Make special note of each screw and screw lock size and location during removal and replacement

Before removing the display panel assembly, follow these steps:

1. Shut down the computer.
2. Disconnect all external devices connected to the computer.
3. Disconnect the power from the computer by first unplugging the power cord from the AC outlet and then unplugging the AC adapter from the computer.
4. Remove the bottom cover (see [Bottom cover on page 29](#)), and then remove the following components:
 - ▲ Battery (see [Battery on page 31](#)).

Remove the display panel assembly:

1. Disconnect the webcam, WLAN module, and display panel cables **(1)**.
2. Remove the four Phillips PM2.0×5.0 screws **(2)** that secure the display assembly to the keyboard/top cover.
3. Rotate the hinges **(3)** up and toward the back of the computer to prepare for display assembly removal.

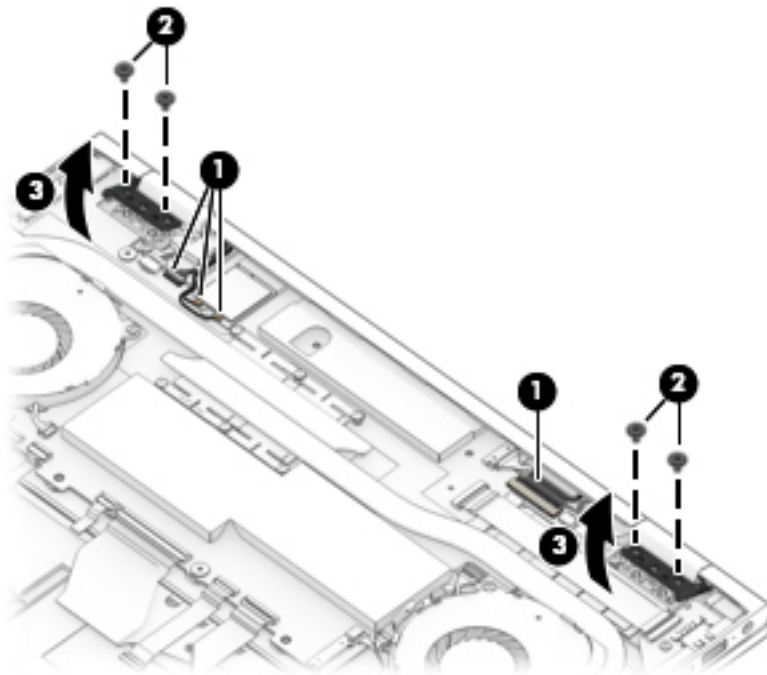

4. Rotate the display panel back toward the open computer, and then lift up to remove the display panel assembly.

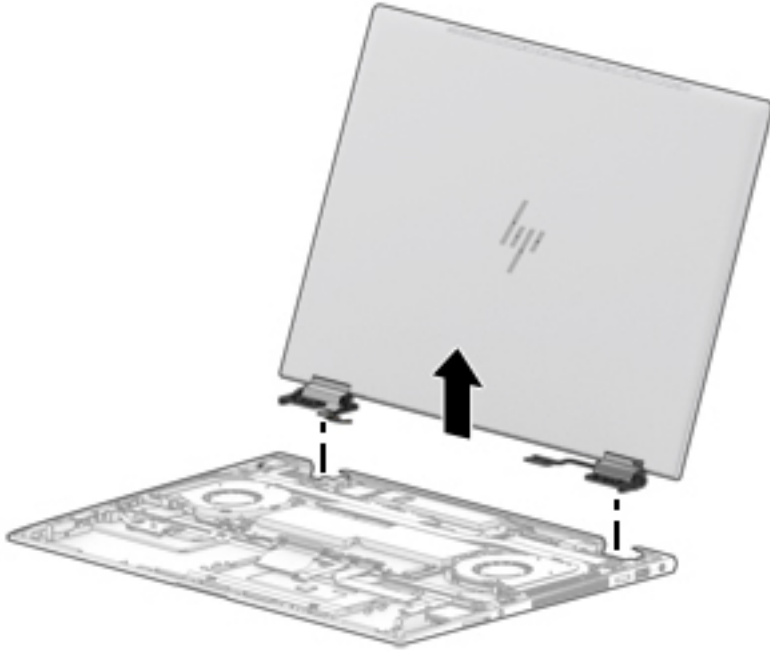

Reverse this procedure to install the display panel assembly.

6 Using Setup Utility (BIOS)

Setup Utility, or Basic Input/Output System (BIOS), controls communication between all the input and output devices on the system (such as disk drives, display, keyboard, mouse, and printer). Setup Utility (BIOS) includes settings for the types of devices installed, the startup sequence of the computer, and the amount of system and extended memory.

 **NOTE:** To start Setup Utility on convertible computers, your computer must be in notebook mode and you must use the keyboard attached to your notebook.

Starting Setup Utility (BIOS)

 **CAUTION:** Use extreme care when making changes in Setup Utility (BIOS). Errors can prevent the computer from operating properly.

- ▲ Turn on or restart the computer, quickly press **esc**, and then press **f10**.

Updating Setup Utility (BIOS)

Updated versions of Setup Utility (BIOS) may be available on the HP website.

Most BIOS updates on the HP website are packaged in compressed files called *SoftPaqs*.

Some download packages contain a file named *Readme.txt*, which contains information regarding installing and troubleshooting the file.

Determining the BIOS version

To decide whether you need to update Setup Utility (BIOS), first determine the BIOS version on your computer.

To reveal the BIOS version information (also known as *ROM date* and *System BIOS*), use one of these options.

- HP Support Assistant
 1. Type `support` in the taskbar search box, and then select the **HP Support Assistant** app.
– or –
Click the question mark icon in the taskbar.
 2. Select **My PC**, and then select **Specifications**.
- Setup Utility (BIOS)
 1. Start Setup Utility (BIOS) (see [Starting Setup Utility \(BIOS\) on page 61](#)).
 2. Select **Main**, select **System Information**, and then make note of the BIOS version.
 3. Select **Exit**, select **No**, and then follow the on-screen instructions.

To check for later BIOS versions, see [Downloading a BIOS update on page 62](#).

Downloading a BIOS update

 **CAUTION:** To reduce the risk of damage to the computer or an unsuccessful installation, download and install a BIOS update only when the computer is connected to reliable external power using the AC adapter. Do not download or install a BIOS update while the computer is running on battery power, docked in an optional docking device, or connected to an optional power source. During the download and installation, follow these instructions:

- Do not disconnect power from the computer by unplugging the power cord from the AC outlet.
- Do not shut down the computer or initiate Sleep.
- Do not insert, remove, connect, or disconnect any device, cable, or cord.

 **NOTE:** If your computer is connected to a network, consult the network administrator before installing any software updates, especially system BIOS updates.

1. Type `support` in the taskbar search box, and then select the **HP Support Assistant** app.
– or –
Click the question mark icon in the taskbar.
2. Click **Updates**, and then click **Check for updates and messages**.
3. Follow the on-screen instructions.
4. At the download area, follow these steps:
 - a. Identify the most recent BIOS update and compare it to the BIOS version currently installed on your computer. If the update is more recent than your BIOS version, make a note of the date, name, or other identifier. You may need this information to locate the update later, after it has been downloaded to your hard drive.
 - b. Follow the on-screen instructions to download your selection to the hard drive.

Make a note of the path to the location on your hard drive where the BIOS update is downloaded. You will need to access this path when you are ready to install the update.

BIOS installation procedures vary. Follow any instructions that appear on the screen after the download is complete. If no instructions appear, follow these steps:

1. Type `file` in the taskbar search box, and then select **File Explorer**.
2. Click your hard drive designation. The hard drive designation is typically Local Disk (C:).
3. Using the hard drive path you recorded earlier, open the folder that contains the update.
4. Double-click the file that has an `.exe` extension (for example, `filename.exe`).

The BIOS installation begins.
5. Complete the installation by following the on-screen instructions.

 **NOTE:** After a message on the screen reports a successful installation, you can delete the downloaded file from your hard drive.

7 Backing up, restoring, and recovering

This chapter provides information about the following processes, which are standard procedure for most products:

- **Backing up your personal information**—You can use Windows tools to back up your personal information (see [Using Windows tools on page 63](#)).
- **Creating a restore point**—You can use Windows tools to create a restore point (see [Using Windows tools on page 63](#)).
- **Creating recovery media** (select products only)—You can use HP Recovery Manager or HP Cloud Recovery Download Tool (select products only) to create recovery media (see [Creating HP Recovery media \(select products only\) on page 63](#)).
- **Restoring and recovery**—Windows offers several options for restoring from backup, refreshing the computer, and resetting the computer to its original state (see [Using Windows tools on page 63](#)).
- **Removing the Recovery Partition**—To remove the Recovery partition to reclaim hard drive space (select products only), select the **Remove Recovery Partition** option of HP Recovery Manager. For more information, see [Removing the HP Recovery partition \(select products only\) on page 67](#).

Using Windows tools

 **IMPORTANT:** Windows is the only option that allows you to back up your personal information. Schedule regular backups to avoid information loss.

You can use Windows tools to back up personal information and create system restore points and recovery media, allowing you to restore from backup, refresh the computer, and reset the computer to its original state.

 **NOTE:** If computer storage is 32 GB or less, Microsoft System Restore is disabled by default.

For more information and steps, see the Get Help app.

- ▲ Select the **Start** button, and then select the **Get Help** app.

 **NOTE:** You must be connected to the Internet to access the Get Help app.

Creating HP Recovery media (select products only)

After you have successfully set up the computer, use HP Recovery Manager to create a backup of the HP Recovery partition on the computer. This backup is called HP Recovery media. In cases where the hard drive is corrupted or has been replaced, the HP Recovery media can be used to reinstall the original operating system.

To check for the presence of the Recovery partition in addition to the Windows partition, right-click the **Start** button, select **File Explorer**, and then select **This PC**.

 **NOTE:** If your computer does not list the Recovery partition in addition to the Windows partition, contact support to obtain recovery discs. Go to <http://www.hp.com/support>, select your country or region, and then follow the on-screen instructions.

On select products, you can use the HP Cloud Recovery Download Tool to create HP Recovery media on a bootable USB flash drive. For more information, see [Using the HP Cloud Recovery Download Tool to create recovery media on page 65](#).

Using HP Recovery Manager to create recovery media

 **NOTE:** If you cannot create recovery media yourself, contact support to obtain recovery discs. Go to <http://www.hp.com/support>, select your country or region, and then follow the on-screen instructions.

Before you begin

Before you begin, note the following:

- Only one set of recovery media can be created. Handle these recovery tools carefully, and keep them in a safe place.
- HP Recovery Manager examines the computer and determines the required media storage capacity.
- To create recovery media, use one of the following options:

 **NOTE:** If the computer does not have a recovery partition, HP Recovery Manager displays the Windows Create a Recovery Drive feature. Follow the on-screen instructions to create a recovery image on a blank USB flash drive or hard drive.

- If your computer has an optical drive with DVD writer capability, be sure to use only high-quality blank DVD-R, DVD+R, DVD-R DL, or DVD+R DL discs. Do not use rewritable discs such as CD±RW, DVD±RW, double-layer DVD±RW, or BD-RE (rewritable Blu-ray) discs, which are not compatible with HP Recovery Manager software.
- If your computer does not include an integrated optical drive with DVD writer capability, you can use an external optical drive (purchased separately) to create recovery discs, as described above. If an external optical drive is used, you must connect it directly to a USB port on the computer. It cannot be connected to a USB port on an external device, such as a USB hub.
- To create a recovery flash drive, use a high-quality blank USB flash drive.
- Be sure that the computer is connected to AC power before you begin creating the recovery media.
- The creation process can take an hour or more. Do not interrupt this process.
- If necessary, you can exit the program before you have finished creating all of the recovery media. HP Recovery Manager will finish the current DVD or flash drive. The next time you start HP Recovery Manager, you will be prompted to continue.

Creating the recovery media

To create HP Recovery media using HP Recovery Manager:

 **IMPORTANT:** For a tablet with a detachable keyboard, connect the tablet to the keyboard base before beginning these steps.

1. Type `recovery` in the taskbar search box, and then select **HP Recovery Manager**.
2. Select **Create recovery media**, and then follow the on-screen instructions.

If you need to recover the system, see [Recovering using HP Recovery Manager on page 65](#).

Using the HP Cloud Recovery Download Tool to create recovery media

To create HP Recovery media using the HP Cloud Recovery Download Tool:

1. Go to <http://www.hp.com/support>.
2. Select **Software and Drivers**, and then follow the on-screen instructions.

Restoring and recovery

Restoring and recovery can be performed using one or more of the following options: Windows tools, HP Recovery Manager, or the HP Recovery partition.

 **IMPORTANT:** Not all methods are available on all products.

Restoring, resetting, and refreshing using Windows tools

Windows offers several options for restoring, resetting, and refreshing the computer. For details, see [Using Windows tools on page 63](#).

Restoring using HP Recovery Manager and the HP Recovery partition

You can use HP Recovery Manager and the HP Recovery partition (select products only) to restore the computer to the original factory state:

- **Resolving problems with preinstalled applications or drivers**—To correct a problem with a preinstalled application or driver:
 1. Type `recovery` in the taskbar search box, and then select **HP Recovery Manager**.
 2. Select **Reinstall drivers and/or applications**, and then follow the on-screen instructions.
- **Using System Recovery**—To recover the Windows partition to original factory content, select the **System Recovery** option from the HP Recovery partition (select products only) or use the HP Recovery media. For more information, see [Recovering using HP Recovery Manager on page 65](#). If you have not already created recovery media, see [Creating HP Recovery media \(select products only\) on page 63](#).
- **Using Factory Reset** (select products only)—Restores the computer to its original factory state by deleting all information from the hard drive and recreating the partitions and then reinstalling the operating system and the software that was installed at the factory (select products only). To use the **Factory Reset** option, you must use HP Recovery media. If you have not already created recovery media, see [Creating HP Recovery media \(select products only\) on page 63](#).

 **NOTE:** If you have replaced the hard drive in the computer, you can use the Factory Reset option to install the operating system and the software that was installed at the factory.

Recovering using HP Recovery Manager

You can use HP Recovery Manager software to recover the computer to its original factory state by using the HP Recovery media that you either created or that you obtained from HP, or by using the HP Recovery partition (select products only).

If you have not already created HP Recovery media, see [Creating HP Recovery media \(select products only\) on page 63](#).

 **IMPORTANT:** HP Recovery Manager does not automatically provide backups of your personal data. Before beginning recovery, back up any personal data that you want to retain. See [Using Windows tools on page 63](#).

IMPORTANT: Recovery through HP Recovery Manager should be used as a final attempt to correct computer issues.

 **NOTE:** When you start the recovery process, only the options available for your computer are displayed.

Before you begin, note the following:

- HP Recovery Manager recovers only software that was installed at the factory. For software not provided with this computer, you must either download the software from the manufacturer's website or reinstall the software from the media provided by the manufacturer.
- If the computer hard drive fails, HP Recovery media must be used. This media is created using HP Recovery Manager. See [Creating HP Recovery media \(select products only\) on page 63](#).
- If your computer does not allow the creation of HP Recovery media or if the HP Recovery media does not work, contact support to obtain recovery media. Go to <http://www.hp.com/support>, select your country or region, and then follow the on-screen instructions.

Recovering using the HP Recovery partition (select products only)

The HP Recovery partition allows you to perform a system recovery without recovery discs or a recovery USB flash drive. This type of recovery can be used only if the hard drive is still working.

The HP Recovery partition (select products only) allows System Recovery only.

To start HP Recovery Manager from the HP Recovery partition:

 **IMPORTANT:** For a tablet with a detachable keyboard, connect the tablet to the keyboard base before beginning these steps (select products only).

1. Type `recovery` in the taskbar search box, select **HP Recovery Manager**, and then select **Windows Recovery Environment**.

– or –

For computers or tablets with keyboards attached:

- ▲ Press **f11** while the computer boots, or press and hold **f11** as you press the power button.

For tablets without keyboards:

- ▲ Turn on or restart the tablet, quickly hold down the volume up button, and then select **f11**.

2. Select **Troubleshoot** from the boot options menu.
3. Select **Recovery Manager**, and then follow the on-screen instructions.

 **NOTE:** If your computer does not automatically restart in HP Recovery Manager, change the computer boot order, and then follow the on-screen instructions. See [Changing the computer boot order on page 67](#).

Recovering using HP Recovery media

If your computer does not have an HP Recovery partition or if the hard drive is not working properly, you can use HP Recovery media to recover the original operating system and software programs that were installed at the factory.

- ▲ Insert the HP Recovery media, and then restart the computer.

 **NOTE:** If your computer does not automatically restart in HP Recovery Manager, change the computer boot order, and then follow the on-screen instructions. See [Changing the computer boot order on page 67](#).

Changing the computer boot order

If your computer does not restart in HP Recovery Manager, you can change the computer boot order. This is the order of devices listed in BIOS where the computer looks for startup information. You can change the selection to an optical drive or a USB flash drive, depending on the location of your HP Recovery media.

To change the boot order:

 **IMPORTANT:** For a tablet with a detachable keyboard, connect the tablet to the keyboard base before beginning these steps.

1. Insert the HP Recovery media.
2. Access the system **Startup** menu.

For computers or tablets with keyboards attached:

- ▲ Turn on or restart the computer or tablet, quickly press **esc**, and then press **f9** for boot options.

For tablets without keyboards:

- ▲ Turn on or restart the tablet, quickly hold down the volume up button, and then select **f9**.

– or –

Turn on or restart the tablet, quickly hold down the volume down button, and then select **f9**.

3. Select the optical drive or USB flash drive from which you want to boot, and then follow the on-screen instructions.

Removing the HP Recovery partition (select products only)

HP Recovery Manager software allows you to remove the HP Recovery partition (select products only) to free up hard drive space.

 **IMPORTANT:** After you remove the HP Recovery partition, you will not be able to perform System Recovery or create HP Recovery media. Before removing the Recovery partition, create HP Recovery media. See [Creating HP Recovery media \(select products only\) on page 63](#).

Follow these steps to remove the HP Recovery partition:

1. Type `recovery` in the taskbar search box, and then select **HP Recovery Manager**.
2. Select **Remove Recovery Partition**, and then follow the on-screen instructions.

8 Using HP PC Hardware Diagnostics

Using HP PC Hardware Diagnostics Windows

HP PC Hardware Diagnostics Windows is a Windows-based utility that allows you to run diagnostic tests to determine whether the computer hardware is functioning properly. The tool runs within the Windows operating system in order to diagnose hardware failures.

If HP PC Hardware Diagnostics Windows is not installed on your computer, first you must download and install it. To download HP PC Hardware Diagnostics Windows, see [Downloading HP PC Hardware Diagnostics Windows on page 68](#).

After HP PC Hardware Diagnostics Windows is installed, follow these steps to access it from HP Help and Support or HP Support Assistant.

1. To access HP PC Hardware Diagnostics Windows from HP Help and Support:
 - a. Select the **Start** button, and then select **HP Help and Support**.
 - b. Right-click **HP PC Hardware Diagnostics Windows**, select **More**, and then select **Run as administrator**.

– or –

To access HP PC Hardware Diagnostics Windows from HP Support Assistant:

 - a. Type `support` in the taskbar search box, and then select the **HP Support Assistant** app.

– or –

Select the question mark icon in the taskbar.

 - b. Select **Troubleshooting and fixes**.
 - c. Select **Diagnostics**, and then select **HP PC Hardware Diagnostics Windows**.
 2. When the tool opens, select the type of diagnostic test you want to run, and then follow the on-screen instructions.
-
-  **NOTE:** If you need to stop a diagnostic test at any time, select **Cancel**.
3. When HP PC Hardware Diagnostics Windows detects a failure that requires hardware replacement, a 24-digit Failure ID code is generated. For assistance in correcting the problem, contact support, and then provide the Failure ID code.

Downloading HP PC Hardware Diagnostics Windows

- The HP PC Hardware Diagnostics Windows download instructions are provided in English only.
- You must use a Windows computer to download this tool because only .exe files are provided.

Downloading the latest HP PC Hardware Diagnostics Windows version

To download HP PC Hardware Diagnostics Windows, follow these steps:

1. Go to <http://www.hp.com/go/techcenter/pcdiags>. The HP PC Diagnostics home page is displayed.
2. In the **HP PC Hardware Diagnostics** section, select **Download**, and then select the installation location:
To run the tool on your computer, download it to the computer desktop.
– or –
To run the tool from a USB flash drive, download it to a USB flash drive.
3. Select **Run**.

Downloading HP Hardware Diagnostics Windows by product name or number (select products only)



NOTE: For some products, it may be necessary to download the software to a USB flash drive by using the product name or number.

To download HP PC Hardware Diagnostics Windows by product name or number (select products only), follow these steps:

1. Go to <http://www.hp.com/support>.
2. Select **Get software and drivers**, and then enter the product name or number.
3. In the **HP PC Hardware Diagnostics** section, select **Download**, and then select the installation location:
To run the tool on your computer, download it to the computer desktop.
– or –
To run the tool from a USB flash drive, download it to a USB flash drive.
4. Select **Run**.

Installing HP PC Hardware Diagnostics Windows

To install HP PC Hardware Diagnostics Windows, follow these steps:

- ▲ Navigate to the folder on your computer or the flash drive where the .exe file was downloaded, double-click the .exe file, and then follow the on-screen instructions.

Using HP PC Hardware Diagnostics UEFI

HP PC Hardware Diagnostics UEFI (Unified Extensible Firmware Interface) allows you to run diagnostic tests to determine whether the computer hardware is functioning properly. The tool runs outside the operating system so that it can isolate hardware failures from issues that are caused by the operating system or other software components.

If your PC will not boot into Windows, you can use HP PC Hardware Diagnostics UEFI to diagnose hardware issues.

When HP PC Hardware Diagnostics UEFI detects a failure that requires hardware replacement, a 24-digit Failure ID code is generated. For assistance in correcting the problem, contact support, and provide the Failure ID code.



NOTE: To start diagnostics on a convertible computer, your computer must be in notebook mode, and you must use the attached keyboard.

 **NOTE:** If you need to stop a diagnostic test, press `esc`.

Starting HP PC Hardware Diagnostics UEFI

To start HP PC Hardware Diagnostics UEFI, follow these steps:

1. Turn on or restart the computer, and quickly press `esc`.
2. Press `f2`.

The BIOS searches three places for the diagnostic tools, in the following order:

- a. Connected USB flash drive

 **NOTE:** To download the HP PC Hardware Diagnostics UEFI tool to a USB flash drive, see [Downloading the latest HP PC Hardware Diagnostics UEFI version on page 70](#).

- b. Hard drive

- c. BIOS

3. When the diagnostic tool opens, select the type of diagnostic test you want to run, and then follow the on-screen instructions.

Downloading HP PC Hardware Diagnostics UEFI to a USB flash drive

Downloading HP PC Hardware Diagnostics UEFI to a USB flash drive can be useful in the following situations:

- HP PC Hardware Diagnostics UEFI is not included in the preinstall image.
- HP PC Hardware Diagnostics UEFI is not included in the HP Tool partition.
- The hard drive is damaged.

 **NOTE:** The HP PC Hardware Diagnostics UEFI download instructions are provided in English only, and you must use a Windows computer to download and create the HP UEFI support environment because only `.exe` files are provided.

Downloading the latest HP PC Hardware Diagnostics UEFI version

To download the latest HP PC Hardware Diagnostics UEFI version to a USB flash drive:

1. Go to <http://www.hp.com/go/techcenter/pcdiags>. The HP PC Diagnostics home page is displayed.
2. In the **HP PC Hardware Diagnostics UEFI** section, select **Download UEFI Diagnostics**, and then select **Run**.

Downloading HP PC Hardware Diagnostics UEFI by product name or number (select products only)

 **NOTE:** For some products, it may be necessary to download the software to a USB flash drive by using the product name or number.

To download HP PC Hardware Diagnostics UEFI by product name or number (select products only) to a USB flash drive:

1. Go to <http://www.hp.com/support>.
2. Enter the product name or number, select your computer, and then select your operating system.
3. In the **Diagnostics** section, follow the on-screen instructions to select and download the specific UEFI Diagnostics version for your computer.

Using Remote HP PC Hardware Diagnostics UEFI settings (select products only)

Remote HP PC Hardware Diagnostics UEFI is a firmware (BIOS) feature that downloads HP PC Hardware Diagnostics UEFI to your computer. It can then execute the diagnostics on your computer, and it may upload results to a preconfigured server. For more information on Remote HP PC Hardware Diagnostics UEFI, go to <http://www.hp.com/go/techcenter/pcdiags>, and then select **Find out more**.

Downloading Remote HP PC Hardware Diagnostics UEFI

 **NOTE:** HP Remote PC Hardware Diagnostics UEFI is also available as a Softpaq that can be downloaded to a server.

Downloading the latest Remote HP PC Hardware Diagnostics UEFI version

To download the latest Remote HP PC Hardware Diagnostics UEFI version, follow these steps:

1. Go to <http://www.hp.com/go/techcenter/pcdiags>. The HP PC Diagnostics home page is displayed.
2. In the **HP PC Hardware Diagnostics UEFI** section, select **Download Remote Diagnostics**, and then select **Run**.

Downloading Remote HP PC Hardware Diagnostics UEFI by product name or number

 **NOTE:** For some products, it may be necessary to download the software by using the product name or number.

To download HP Remote PC Hardware Diagnostics UEFI by product name or number, follow these steps:

1. Go to <http://www.hp.com/support>.
2. Select **Get software and drivers**, enter the product name or number, select your computer, and then select your operating system.
3. In the **Diagnostics** section, follow the on-screen instructions to select and download the **Remote UEFI** version for the product.

Customizing Remote HP PC Hardware Diagnostics UEFI settings

Using the Remote HP PC Hardware Diagnostics setting in Computer Setup (BIOS), you can perform the following customizations:

- Set a schedule for running diagnostics unattended. You can also start diagnostics immediately in interactive mode by selecting **Execute Remote HP PC Hardware Diagnostics**.
- Set the location for downloading the diagnostic tools. This feature provides access to the tools from the HP website or from a server that has been preconfigured for use. Your computer does not require the traditional local storage (such as a disk drive or USB flash drive) to run remote diagnostics.
- Set a location for storing the test results. You can also set the user name and password settings used for uploads.
- Display status information about the diagnostics run previously.

To customize Remote HP PC Hardware Diagnostics UEFI settings, follow these steps:

1. Turn on or restart the computer, and when the HP logo appears, press **f10** to enter Computer Setup.
2. Select **Advanced**, and then select **Settings**.

3. Make your customization selections.
4. Select **Main**, and then **Save Changes and Exit** to save your settings.

Your changes take effect when the computer restarts.

9 Specifications

Computer specifications

	Metric	U.S.
Dimensions		
Width	35.9 cm	14.1 in
Depth	25 cm	9.84 in
Height (front to back)	1.95 cm	.77 in
Weight	2.14 or 2.10 kg (depending on configuration)	4.71 lb or 4.63 (depending on configuration)
Input power		
Operating voltage and current	19 V dc @ 4.62 A – 150 W 19.5 V dc @ 2.31 – 90 W	
Temperature		
Operating	5°C to 35°C	41°F to 95°F
Nonoperating	-20°C to 60°C	-4°F to 140°F
Relative humidity (noncondensing)		
Operating	10% to 90%	
Nonoperating	5% to 95%	
Maximum altitude (unpressurized)		
Operating	-15 m to 3,048 m	-50 ft to 10,000 ft
Nonoperating	-15 m to 12,192 m	-50 ft to 40,000 ft
NOTE: Applicable product safety standards specify thermal limits for plastic surfaces. The device operates well within this range of temperatures.		

39.6 cm (15.6-in) display specifications

	Metric	U.S.
Dimensions		
Height	20.77 cm	8.175 in
Width	37.78 cm	14.875 in
Diagonal	39.62 cm	15.6 in
Number of colors	Up to 16.8 million	
Contrast ratio	500:1 (typical)	
Brightness	340 nits	
Pixel resolution		
Pitch	0.252mm x 0.252mm	
Format	3840×2160	
Configuration	RGB vertical stripe	
Backlight	WLED	
Character display	80 × 25	
Total power consumption	2.0 W	
Viewing angle	±65° horizontal, ±50° vertical (typical)	

10 Power cord set requirements

The wide-range input feature of the computer permits it to operate from any line voltage from 100 to 120 V ac, or from 220 to 240 V ac.

The 3-conductor power cord set included with the computer meets the requirements for use in the country or region where the equipment is purchased.

Power cord sets for use in other countries or regions must meet the requirements of the country and region where the computer is used.

Requirements for all countries

The following requirements are applicable to all countries and regions:

- The length of the power cord set must be at least **1.0 m** (3.3 ft) and no more than **2.0 m** (6.5 ft).
- All power cord sets must be approved by an acceptable accredited agency responsible for evaluation in the country or region where the power cord set will be used.
- The power cord sets must have a minimum current capacity of 10 A and a nominal voltage rating of 125 or 250 V ac, as required by the power system of each country or region.
- The appliance coupler must meet the mechanical configuration of an EN 60 320/IEC 320 Standard Sheet C13 connector for mating with the appliance inlet on the back of the computer.

Requirements for specific countries and regions

Country/region	Accredited agency	Applicable note number
Argentina	IRAM	1
Australia	SAA	1
Austria	OVE	1
Belgium	CEBEC	1
Brazil	ABNT	1
Canada	CSA	2
Chile	IMQ	1
Denmark	DEMKO	1
Finland	FIMKO	1
France	UTE	1
Germany	VDE	1
India	BIS	1
Israel	SII	1
Italy	IMQ	1
Japan	JIS	3
The Netherlands	KEMA	1
New Zealand	SANZ	1
Norway	NEMKO	1
The People's Republic of China	CCC	4
Saudi Arabia	SASO	7
Singapore	PSB	1
South Africa	SABS	1
South Korea	KTL	5
Sweden	SEMKO	1
Switzerland	SEV	1
Taiwan	BSMI	6
Thailand	TISI	1
The United Kingdom	ASTA	1
The United States	UL	2

1. The flexible cord must be Type H05VV-F, 3-conductor, 0.75 mm² conductor size. Power cord set fittings (appliance coupler and wall plug) must bear the certification mark of the agency responsible for evaluation in the country or region where it will be used.
2. The flexible cord must be Type SVT/SJT or equivalent, No. 18 AWG, 3-conductor. The wall plug must be a two-pole grounding type with a NEMA 5-15P (15 A, 125 V ac) or NEMA 6-15P (15 A, 250 V ac) configuration. CSA or C-UL mark. UL file number must be on each element.

Country/region	Accredited agency	Applicable note number
3.	The appliance coupler, flexible cord, and wall plug must bear a “T” mark and registration number in accordance with the Japanese Dentori Law. The flexible cord must be Type VCTF, 3-conductor, 0.75 mm ² or 1.25 mm ² conductor size. The wall plug must be a two-pole grounding type with a Japanese Industrial Standard C8303 (7 A, 125 V ac) configuration.	
4.	The flexible cord must be Type RVV, 3-conductor, 0.75 mm ² conductor size. Power cord set fittings (appliance coupler and wall plug) must bear the CCC certification mark.	
5.	The flexible cord must be Type H05VV-F 3-conductor, 0.75 mm ² conductor size. KTL logo and individual approval number must be on each element. Corset approval number and logo must be printed on a flag label.	
6.	The flexible cord must be Type HVCTF 3-conductor, 1.25 mm ² conductor size. Power cord set fittings (appliance coupler, cable, and wall plug) must bear the BSMI certification mark.	
7.	For 127 V ac, the flexible cord must be Type SVT or SJT 3-conductor, 18 AWG, with plug NEMA 5-15P (15 A, 125 V ac), with UL and CSA or C-UL marks. For 240 V ac, the flexible cord must be Type H05VV-F 3-conductor, 0.75 mm ² or 1.00 mm ² conductor size, with plug BS 1363/A with BSI or ASTA marks.	

11 Recycling

When a non-rechargeable or rechargeable battery has reached the end of its useful life, do not dispose of the battery in general household waste. Follow the local laws and regulations in your area for battery disposal.

HP encourages customers to recycle used electronic hardware, HP original print cartridges, and rechargeable batteries. For more information about recycling programs, see the HP Web site at <http://www.hp.com/recycle>.

Index

A

- AC adapter
 - spare part numbers 22
 - AC adapter and battery light, identifying 6
 - action keys
 - airplane mode 14
 - help 14
 - identifying 12, 13
 - keyboard backlight 14
 - mute 14
 - next track 14
 - pause 14
 - play 14
 - privacy screen 14
 - screen brightness 14
 - speaker volume 14
 - switch screen image 14
 - using 14
 - Adapter
 - spare part numbers 22
 - airplane mode key 14
 - audio
 - adjusting volume 14
 - speakers 11, 16
 - Audio board
 - removal 40
 - spare part numbers 21, 40
 - Audio connector cable
 - spare part numbers 21
 - audio, product description 1
 - audio-out (headphone)/audio-in (microphone) combo jack, identifying 7
- ## B
- backup, creating 63
 - backups 63
 - Battery
 - removal 31
 - spare part number 22
 - spare part numbers 31
 - BIOS
 - determining version 61
 - downloading an update 62

- starting the Setup Utility 61
- updating 61
- boot order, changing 67
- bottom components 16
- Bottom cover
 - removal 29
 - spare part number 22
 - spare part numbers 29
- buttons
 - left TouchPad 9
 - power 6
 - right TouchPad 9

C

- camera
 - identifying 8
 - camera light, identifying 8
 - caps lock light, identifying 10
 - components
 - bottom 16
 - display 8
 - keyboard area 9
 - left side 6
 - right side 4
 - computer major components 18
 - Computer sleeve 22
 - computer specifications 73
 - connector, power 4, 5, 6
- ## D
- display
 - specifications 74
 - display components 8
 - display panel
 - product description 1
 - Display panel assembly
 - removal 59
 - spare part numbers 59

E

- esc key, identifying 12, 13

F

- Fan
 - spare part number 21
 - spare part numbers 21
- Fingerprint reader board
 - spare part number 21
- fingerprint reader board
 - removal 36
 - spare part numbers 36
- Fingerprint reader module
 - removal 35
 - spare part number 21
 - spare part numbers 35
- fingerprint reader, identifying 4, 5
- fn key, identifying 12, 13
- Front speakers
 - removal 32
 - spare part numbers 32

G

- graphics, product description 1

H

- hard drive
 - product description 1
- HDMI port
 - identifying 4, 5
- Heatsink
 - spare part number 21
- help action key 14
- HP PC Hardware Diagnostics UEFI
 - downloading 70
 - starting 70
 - using 69
- HP PC Hardware Diagnostics Windows
 - downloading 68
 - installing 69
 - using 68
- HP Recovery Manager
 - correcting boot problems 67
 - starting 66
- HP Recovery media
 - recovery 66
 - using 64

- HP Recovery partition
 - recovery 66
 - removing 67
- I**
- integrated numeric keypad, identifying 12, 13
- internal microphones, identifying 8
- J**
- jacks
 - audio-out (headphone)/audio-in (microphone) 7
- K**
- keyboard
 - product description 2
- keyboard area components 9
- keyboard backlight action key 14
- keyboard/top cover
 - spare part numbers 19, 20
- keypad, integrated numeric 12
- keys
 - action 12, 13
 - airplane mode 14
 - esc 12, 13
 - fn 12, 13
 - num lock 12, 13
 - Windows 12, 13
- L**
- labels
 - serial number 17
- Left fan
 - removal 45
 - spare part numbers 45
- left side components 6
- lights
 - AC adapter and battery light 6
 - camera 8
 - caps lock 10
 - mute 10
 - power 6
- M**
- Memory card reader
 - spare part number 21
- Memory card reader board
 - removal 42
 - spare part numbers 42
- memory card reader, identifying 7
- Memory module
 - removal 51
 - spare part number 21
 - spare part numbers 51
- memory module
 - product description 1
- microphone
 - product description 1
- minimized image recovery 66
- minimized image, creating 65
- model name 1
- mute action key 14
- mute light, identifying 10
- N**
- next track action key 14
- num lock key, identifying 12, 13
- O**
- operating system, product description 2
- optical drive
 - product description 1
- original system recovery 65
- P**
- pause action key 14
- Pen
 - spare part numbers 22
- play action key 14
- pointing device, product description 2
- ports
 - HDMI 4, 5
 - product description 2
 - USB 3.x SuperSpeed port with HP Sleep and Charge 6
 - USB Type-C power connector and Thunderbolt port with HP Sleep and Charge 4, 5
 - USB Type-C SuperSpeed with HP Sleep and Charge 5
- power button, identifying 6
- Power connector cable
 - removal 57
 - spare part numbers 20, 57
- power connector, identifying 4, 5, 6
- Power cord
 - spare part numbers 22
- power cord
 - requirements for all countries 75
 - requirements for specific countries and regions 76
 - set requirements 75
- power lights, identifying 6
- power requirements, product description 2
- privacy screen key, identifying 14
- processor
 - product description 1
- product description
 - audio 1
 - display panel 1
 - external media cards 1
 - graphics 1
 - hard drive 1
 - keyboard 2
 - memory module 1
 - microphone 1
 - operating system 2
 - optical drive 1
 - pointing device 2
 - ports 2
 - power requirements 2
 - processors module 1
 - product name 1
 - security 2
 - serviceability 2
 - video 1
 - wireless 1
- product name 1
- product name and number, computer 17
- R**
- Rear speakers
 - removal 55
 - spare part numbers 55
- recovery 63
 - discs 64, 66
 - HP Recovery Manager 65
 - HP Recovery partition 65
 - media 66
 - starting 66
 - supported discs 64
 - system 65
 - USB flash drive 66
 - using HP Recovery media 64

- recovery media
 - creating using HP Cloud Recovery Download Tool 65
 - creating using HP Recovery Manager 64
 - creating using Windows tools 63
 - discs 64
 - HP Recovery partition 63
 - USB flash drive 64
 - using 64
- recovery partition, removing 67
- regulatory information 17
- Remote HP PC Hardware Diagnostics UEFI settings
 - customizing 71
 - using 71
- removal/replacement procedures 28
- restoring 63
- Right fan
 - removal 47
 - spare part numbers 47
- right side components 4
- Rubber kit 22
- S**
- screen brightness action key 14
- Screw kit 22
- security, product description 2
- serial number 17
- serial number, computer 17
- serviceability, product description 2
- slots, memory card reader 7
- Solid state drive
 - removal 49
 - spare part number 21
 - spare part numbers 49
- speaker volume action keys 14
- Speakers
 - spare part number 20, 21
- speakers
 - identifying 11, 16
- special keys, using 12
- specifications
 - computer 73
 - display 74
- supported discs, recovery 64
- switch screen image action key 14
- System board
 - removal 52
 - spare part number 20
 - spare part numbers 52
- system information
 - locating 17
- system recovery 65
- system restore point, creating 63
- T**
- Thunderbolt port with HP Sleep and Charge, identifying USB Type-C 4, 5
- TouchPad
 - buttons 9
- TouchPad assembly
 - removal 43
 - spare part number 21
 - spare part numbers 43
- TouchPad zone, identifying 9
- U**
- USB 3.x SuperSpeed port with HP Sleep and Charge, identifying 6
- USB daughter board
 - removal 39
 - spare part numbers 21, 39
- USB Type-C power connector and Thunderbolt port with HP Sleep and Charge, identifying 4, 5
- USB Type-C SuperSpeed port with HP Sleep and Charge, identifying 5
- V**
- vents, identifying 4, 5, 7, 16
- video, product description 1
- volume
 - adjusting 14
 - mute 14
- Volume button board
 - removal 33
 - spare part number 21
 - spare part numbers 33
- W**
- warranty period 17
- Windows
 - backup 63
 - recovery media 63
 - system restore point 63
- Windows key, identifying 12, 13
- Windows tools, using 63
- wireless, product description 1
- WLAN antennas, identifying 8
- WLAN module
 - removal 37
 - spare part number 21
 - spare part numbers 37