



User Guide

© Copyright 2018 HP Development Company, L.P.

HDMI, the HDMI Logo and High-Definition Multimedia Interface are trademarks or registered trademarks of HDMI Licensing LLC. Windows is either a registered trademark or trademark of Microsoft Corporation in the United States and/or other countries.

The information contained herein is subject to change without notice. The only warranties for HP products and services are set forth in the express warranty statements accompanying such products and services. Nothing herein should be construed as constituting an additional warranty. HP shall not be liable for technical or editorial errors or omissions contained herein.

Product notice





This guide describes features that are common to most models. Some features may not be available on your product. To access the latest user guide, go to <http://www.hp.com/support>, and follow the instructions to find your product. Then select **User Guides**.

First Edition: January 2018

Document part number: L12827-001

About This Guide

This guide provides information on monitor features, setting up the monitor, using the software and technical specifications.

-
-  **WARNING!** Indicates a hazardous situation that, if not avoided, **could** result in bodily harm or loss of life.
 -  **CAUTION:** Indicates a hazardous situation that, if not avoided, **could** result in damage to equipment or loss of information.
 -  **IMPORTANT:** Indicates information considered important but not hazard-related (for example, messages related to property damage). A notice alerts the user that failure to follow a procedure exactly as described could result in loss of data or in damage to hardware or software. Also contains essential information to explain a concept or to complete a task.
 -  **NOTE:** Contains additional information to emphasize or supplement important points of the main text.
 -  **TIP:** Provides helpful hints for completing a task.
-



This product incorporates HDMI technology.

Table of contents

1 Getting Started	1
Important safety information	1
Product features and components	2
Features	2
Front panel controls	3
Reassigning the function buttons	3
Rear and side components	4
Setting up the monitor	5
Use caution when setting up the monitor	5
Attaching the monitor stand	5
Connecting the cables	6
Connecting USB devices	9
Adjusting the monitor	10
Turning on the monitor	12
Mounting the monitor	13
Removing the monitor stand	13
Attaching the monitor to a mounting device	14
HP watermark and image retention policy	14
2 Using the monitor	15
Software and utilities	15
The Information file	15
The Image Color Matching file	15
Using the on-screen display (OSD) menu	15
Using Picture-in-Picture (PIP) and Picture-beside-Picture (PBP)	16
Adjusting Low Blue Light Mode	16
Using Auto-Sleep Mode	17
3 Support and troubleshooting	18
Solving common problems	18
Button lockouts	18
Contacting support	19
Preparing to call technical support	19
Locating the serial number and product number	19

4 Maintaining the monitor	20
Maintenance guidelines	20
Cleaning the monitor	20
Shipping the monitor	20
Appendix A Technical specifications	21
Preset display resolutions	22
Energy saver feature	23
Appendix B Accessibility	24
Supported assistive technologies	24
Contacting support	24

1 Getting Started

Important safety information

A power cord is included with the monitor. If another cord is used, use only a power source and connection appropriate for this monitor. For information on the correct power cord set to use with the monitor, refer to the *Product Notices* provided in your documentation kit.

 **WARNING!** To reduce the risk of electric shock or damage to the equipment:

- Plug the power cord into an AC outlet that is easily accessible at all times.
- Disconnect power from the computer by unplugging the power cord from the AC outlet.
- If provided with a 3-pin attachment plug on the power cord, plug the cord into a grounded (earthed) 3-pin outlet. Do not disable the power cord grounding pin, for example, by attaching a 2-pin adapter. The grounding pin is an important safety feature.

For your safety, do not place anything on power cords or cables. Arrange them so that no one may accidentally step on or trip over them. Do not pull on a cord or cable. When unplugging from the AC outlet, grasp the cord by the plug.

To reduce the risk of serious injury, read the *Safety & Comfort Guide*. It describes proper workstation setup and proper posture, and health and work habits for computer users. The *Safety & Comfort Guide* also provides important electrical and mechanical safety information. The *Safety & Comfort Guide* is available on the web at <http://www.hp.com/ergo>.

 **IMPORTANT:** For the protection of the monitor, as well as the computer, connect all power cords for the computer and its peripheral devices (such as a monitor, printer, scanner) to some form of surge protection device such as a power strip or uninterruptible power supply (UPS). Not all power strips provide surge protection; the power strips must be specifically labeled as having this capability. Use a power strip whose manufacturer offers a damage replacement policy so you can replace the equipment if surge protection fails.

Use the appropriate and correctly sized furniture designed to properly support your HP LCD monitor.

 **WARNING!** LCD monitors that are inappropriately situated on dressers, bookcases, shelves, desks, speakers, chests, or carts may fall over and cause personal injury.

Care should be taken to route all cords and cables connected to the LCD monitor so that they cannot be pulled, grabbed, or tripped over.

 **NOTE:** This product is suitable for entertainment purposes. Consider placing the monitor in a controlled luminous environment to avoid interference from surrounding light and bright surfaces that may cause disturbing reflections from the screen.

Product features and components

Features

The monitor features include the following:

- 68.6 cm (27.0-inch) diagonal viewable area with 3840 × 2160 UHD resolution, plus full-screen support for lower resolutions
- Wide color gamut to provide coverage of sRGB color spaces
- Nonglare panel with an LED backlight
- Wide viewing angle to allow viewing from a sitting or standing position, or moving from side to side
- Tilt and pivot capabilities
- Swivel and height adjustment capabilities
- Removable stand for flexible monitor head mounting solutions
- HP Quick Release 2 device to quickly attach the monitor head to the stand with a simple click, and then remove it with the convenient sliding tab release
- DisplayPort 1.2 video input
- Mini DisplayPort 1.2 video input
- One HDMI (High-Definition Multimedia Interface) 2.0 video input
- Dual-PIP functionality to enable the DisplayPort and HDMI inputs to be viewed in each half of the screen
- Audio-out jack
- USB Type-C port
- USB hub with three USB 3.0 ports and one USB Type-C downstream port (connect to USB devices)
- USB 3.0 Type-C to Type-A cable and DisplayPort to DisplayPort cable provided
- Four Function buttons on the rear panel, three that can be reconfigured to quickly allow selection of the most commonly used operations
- Plug and Play capability if supported by your operating system
- 100 mm integrated VESA mounting
- Support for the HP B300 PC mounting bracket to attach to the monitor to mount a workstation
- Security cable slot on the rear of the monitor for an optional cable lock
- Cable management feature for placement of cables and cords
- On-screen display (OSD) adjustments in several languages for easy setup and screen optimization
- HP Display Assistant software for adjusting monitor settings and enabling theft deterrence features
- Color space presets for sRGB and BT.709
- Energy saver feature to meet requirements for reduced power consumption



NOTE: For safety and regulatory information, refer to the *Product Notices* provided in your documentation kit. To access the latest user guides or manuals for your product, go to <http://www.hp.com/support> and follow the instructions to find your product. Then select **User Guides**.

Front panel controls

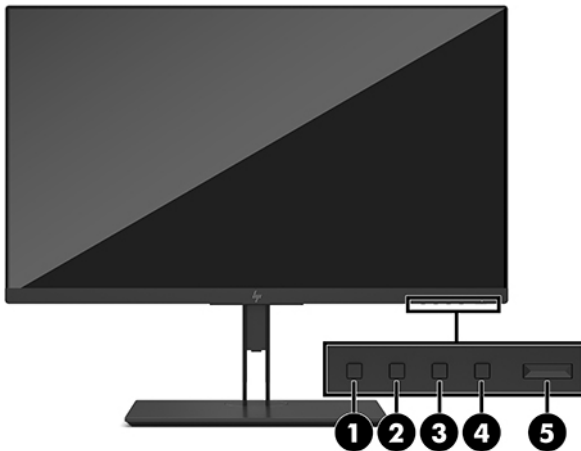

Control	Function
Function buttons (1–4)	Use these buttons to navigate through the OSD based on the indicators next to the buttons that are activated while the OSD is open. NOTE: To activate the Function buttons, press any of the buttons so that the button labels appear on the right side of the screen and the button LEDs are lit.
1 Menu button	Opens the OSD menu, selects a menu item from the OSD, or closes the OSD menu.
2 Viewing Modes button Assignable Function button 1	Navigates through the Viewing Modes menu and selects a preset view mode.
3 Information button Assignable Function button 2	Opens the Information menu.
4 Next Active Input button Assignable Function button 3	Navigates through the OSD menu and selects a video input source.
5 Power button	Turns the monitor on or off. NOTE: Be sure the master power switch on the rear of the monitor is in the ON position to turn on the display.

Reassigning the function buttons

You can change the three assignable Function buttons from their default values so that when the buttons are activated you can quickly access commonly used menu items. You can not reassign the Menu button.

To reconfigure Function buttons:

1. Press one of the four rear panel Function buttons to activate the buttons, and then press the Menu button to open the OSD.
2. In the OSD menu, select **Menu Control**, select **Assign Buttons**, and then select one of the available options for the button you want to reassign.

 **NOTE:** To view an OSD menu simulator, visit the HP Customer Self Repair Services Media Library at <http://www.hp.com/go/sml>.

Rear and side components

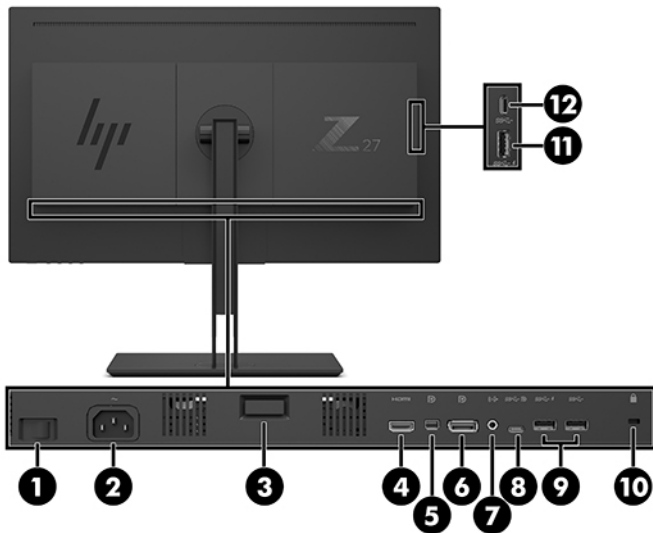

Component	Function
1 Master power switch	Turns on or off all power to the monitor. NOTE: Putting the switch in the Off position will yield the lowest power state for the monitor when not in use.
2 Power connector	Connects a power cord.
3 VESA release button	Releases the stand from the monitor.
4 HDMI port	Connects an HDMI cable to the source device.
5 Mini DisplayPort port	Connects a Mini DisplayPort cable to the source device.
6 DisplayPort port	Connects a DisplayPort cable to the source device.
7 Audio-out jack	Connects optional powered stereo speakers or a television audio cable.
8 USB Type-C port (upstream)*	Connects a USB Type-C cable to a source device.
9 USB Type-A ports (2) (downstream)	Connect the USB hub cable from the source device to the monitor.
10 Security cable slot	Connects a security cable to a stationary object. NOTE: The security cable is designed to act as a deterrent, but it may not prevent the monitor from being mishandled or stolen.
11 USB Type-A port (downstream)	Connects an optional USB device to the monitor.
12 USB Type-C port (downstream)	Connects a USB Type-C cable to a source device.

* The USB Type-C upstream port can function as a DisplayPort audio/video input or as a USB 3.0 upstream connection. It can also be used to deliver up to 65 watts of power to a device. Power outputs are 5 V/9 V/10 V/12 V/15 V/20 V to achieve 65 W output.

Setting up the monitor

Use caution when setting up the monitor

To prevent damage to the monitor, do not touch the surface of the LCD panel. Pressure on the panel may cause nonuniformity of color or disorientation of the liquid crystals. If this occurs, the screen will not recover to its normal condition.

If installing a stand, position the monitor facedown on a flat surface covered with protective sheet foam or a nonabrasive cloth. This prevents the screen from getting scratched, defaced, or broken and prevents damage to the control buttons.

Attaching the monitor stand

CAUTION: The screen is fragile. Avoid touching or applying pressure to the screen; doing so can cause damage.

TIP: Consider the placement of the monitor, because the bezel might cause interfering reflections from surrounding light and bright surfaces.

1. Lift the monitor from its box and place it facedown on a flat surface covered by protective sheet foam or a nonabrasive cloth.
2. Slide the top of the stand's mounting plate (1) under the upper lip of the recess in the back of the monitor.
3. Lower the bottom of the stand's mounting plate (2) into the recess until it snaps into place.

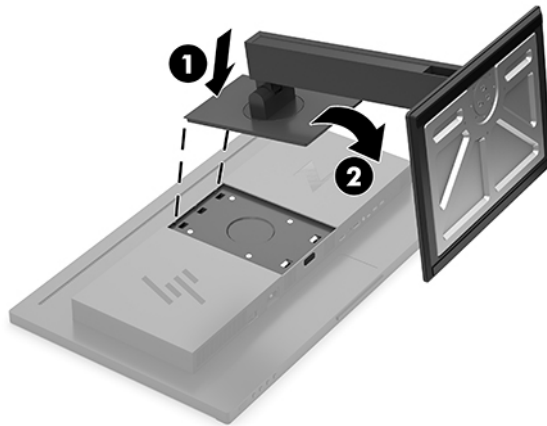

Connecting the cables

 **NOTE:** The monitor ships with select cables. Not all cables shown in this section are included with the monitor.

1. Place the monitor in a convenient, well-ventilated location near the computer.
2. Connect a video cable.

 **NOTE:** The monitor will automatically determine which inputs have valid video signals. The inputs can be selected through the OSD by pressing the **Menu** button and selecting **Input Control**.

- Connect one end of a DisplayPort cable to the DisplayPort port on the rear of the monitor and the other end to the DisplayPort port on the source device.

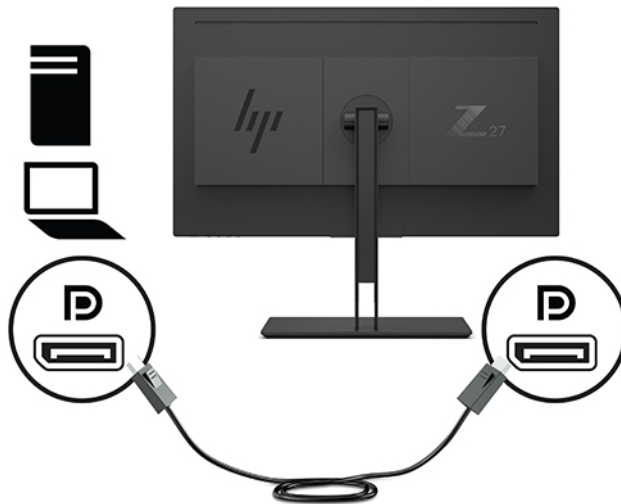

- Connect one end of a Mini DisplayPort cable to the Mini DisplayPort port on the rear of the monitor and the other end to the DisplayPort port on the source device.

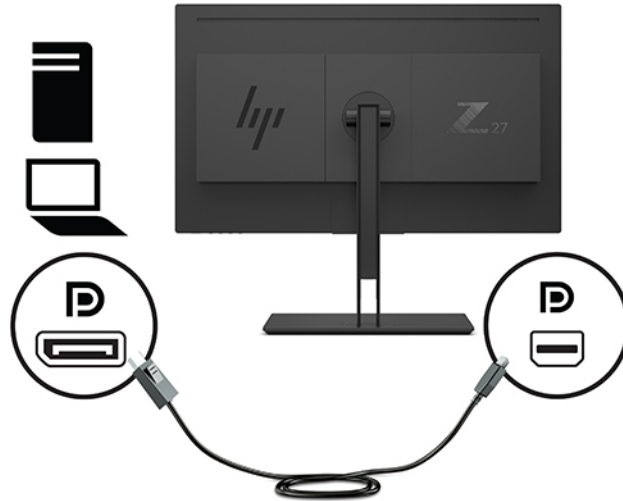

NOTE: Depending on your DisplayPort cable connection, either the DisplayPort or Mini DisplayPort input video connection is disabled between the monitor and connected host device after the system exits from the Sleep state or if the input signal is lost. When the system wakes from the Sleep state, the monitor automatically scans to an active input video signal.

If your last video input connection was to DisplayPort, the monitor automatically scans and switches to USB-C video, DisplayPort, or HDMI video input source, but not to Mini DisplayPort. If your last video input connection was to the Mini DisplayPort, the monitor automatically scans and switches to USB-C video, Mini DisplayPort, or HDMI, but not to DisplayPort.

You will need to reconnect to the desired DisplayPort (DisplayPort 1) or Mini DisplayPort (DisplayPort 2) input using the OSD menu. To reconnect, press the OSD button on the monitor, select **Menu > Input Control**, and then the desired DisplayPort setting.

- Connect one end of an HDMI cable to the HDMI port on the back of the monitor and the other end to the source device.

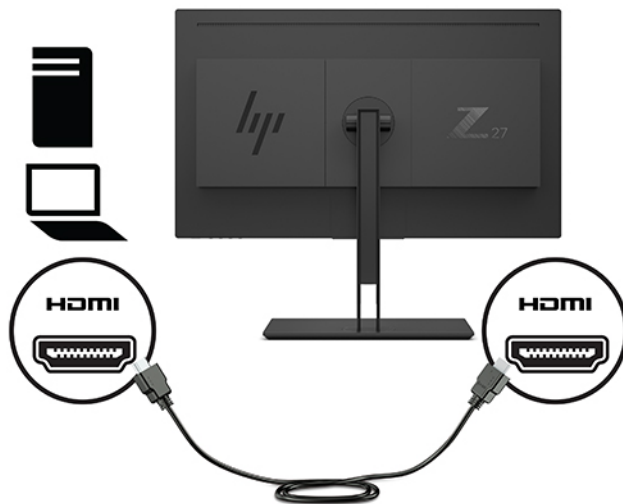

3. You must connect the USB upstream cable from the source computer to the monitor to enable the USB ports on the monitor.

- For a USB Hub:

Connect the Type-C end of a USB cable to a USB Type-C port on the monitor and the other end to a USB Type-A port on the source device.

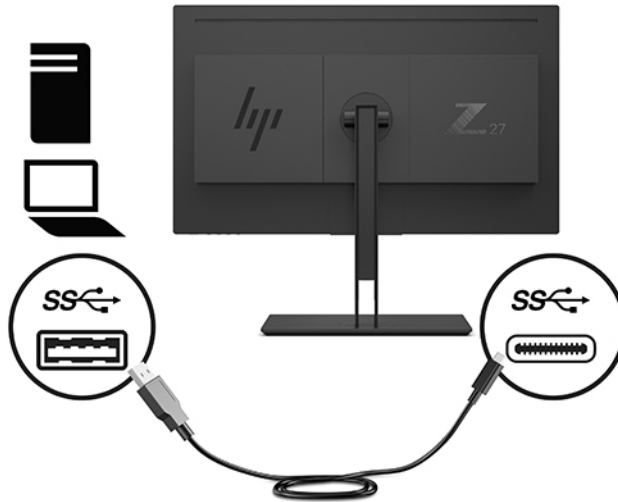

- For DisplayPort Alt-mode:

Connect the Type-C end of a USB cable to a USB Type-C port on the monitor and the other end to a USB Type-C port on the source device.

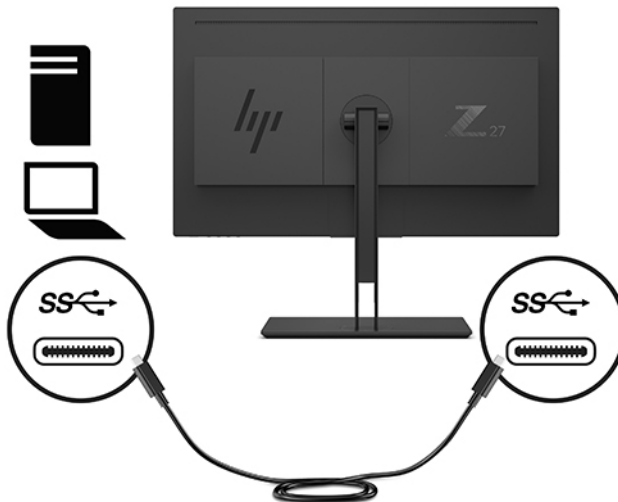

 **NOTE:** To set the video input source to USB-C, press the **Menu** button on the monitor's rear panel, select **Input Control**, and then select **USB-C Configuration**.

- Select **3840 × 2160 @ 60 Hz + USB 2.0** for a higher vertical refresh rate and a lower USB speed.
–or–
 - Select **3840 × 2160 @ 30 Hz + USB 3.0** for a lower vertical refresh rate and a higher USB speed.
-

4. Connect one end of the power cord to a grounded AC outlet, and then connect the other end to the monitor.

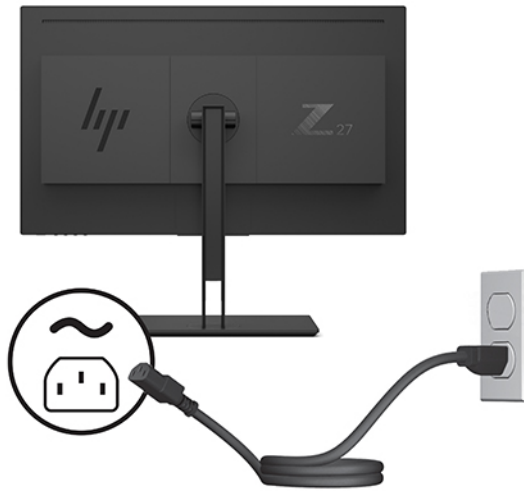

⚠ WARNING! To reduce the risk of electric shock or damage to the equipment:

Do not disable the power cord grounding plug. The grounding plug is an important safety feature.

Plug the power cord into a grounded (earthed) AC outlet that is easily accessible at all times.

Disconnect power from the equipment by unplugging the power cord from the AC outlet.

For your safety, do not place anything on power cords or cables. Arrange them so that no one may accidentally step on or trip over them. Do not pull on a cord or cable. When unplugging the power cord from the AC outlet, grasp the cord by the plug.

Connecting USB devices

USB ports are used to connect devices such as a digital camera, USB keyboard, or USB mouse. There are four downstream USB ports on the monitor: two USB-A downstream on the rear and one USB-C/one USB-A downstream on the side.

📝 NOTE: You must connect the USB upstream cable from the computer to the monitor to enable the USB downstream ports on the monitor. See step 4 in [Connecting the cables on page 6](#).

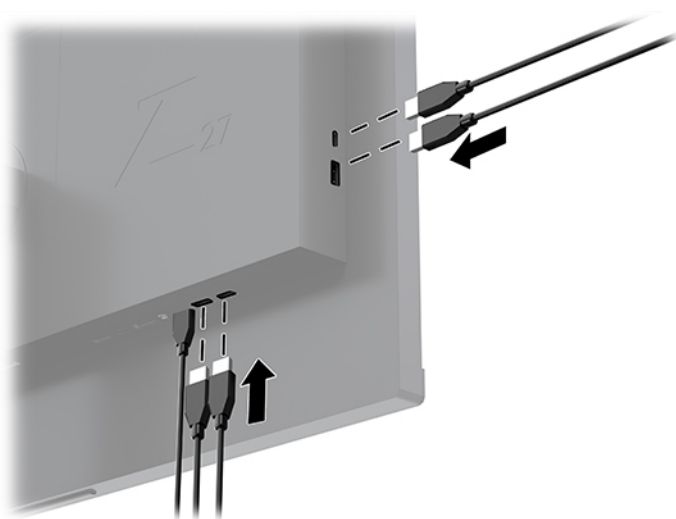

Adjusting the monitor

1. Tilt the monitor head forward or backward to set it to a comfortable eye level.



2. Adjust the monitor's height to a comfortable position for your individual workstation. The monitor's top bezel edge should not exceed a height that is parallel to your eye height. A monitor that is positioned low and reclined may be more comfortable for users with corrective lenses. The monitor should be repositioned as you adjust your working posture throughout the work day.

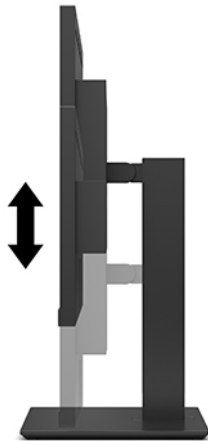

3. Swivel the monitor head to the left or right for the best viewing angle.

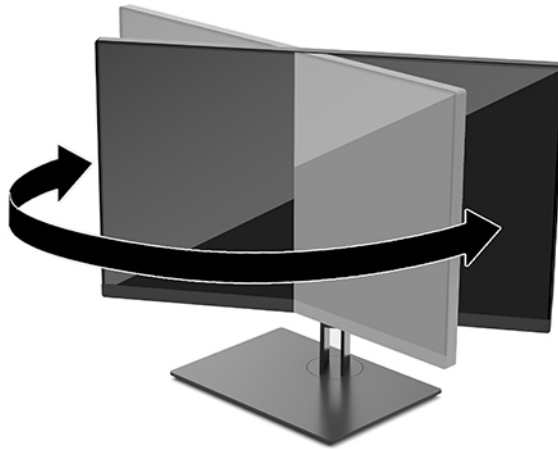

4. You can pivot the monitor from landscape to portrait orientation viewing to adapt to your application.
 - a. Adjust the monitor to full height position and tilt the monitor back to full tilt position (1).
 - b. Pivot the monitor clockwise or counterclockwise 90° from landscape to portrait orientation (2).

CAUTION: If the monitor is not in full height and full tilt position when pivoting, the bottom right corner of the monitor panel will come in contact with the base and potentially cause damage to the monitor.

If you are adding an optional speaker bar to the monitor, install it after pivoting the monitor. The speaker bar will come in contact with the base when pivoting and potentially cause damage to the monitor or speaker bar.

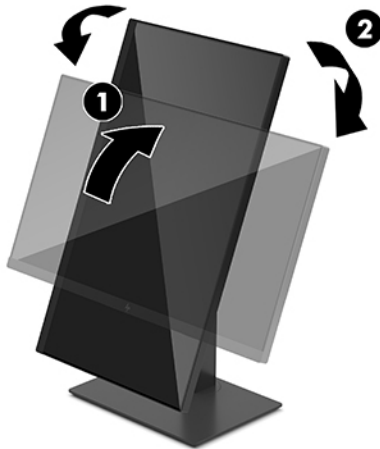



NOTE: Use the operating system's display settings to rotate the image on the screen from portrait to landscape. To rotate the OSD from portrait to landscape, open the OSD and select **Image Adjustment > On-Screen Menu Rotation > Portrait**.

Turning on the monitor

1. Set the master power switch on the rear of the monitor to the On position (for more information, see [Rear and side components on page 4](#)).
2. Press the power button to turn it on.



 **IMPORTANT:** Burn-in image damage may occur on monitors that display the same static image on screen for two or more hours. To avoid burn-in image damage on the monitor screen, you should always activate a screen saver application or turn off the monitor when it is not in use for a prolonged period of time. Image retention is a condition that may occur on all LCD screens. A burned-in image on the monitor is not covered under the HP warranty.

 **NOTE:** If pressing the power button has no effect, the Power Button Lockout feature may be enabled. To disable this feature, press and hold the monitor power button for 10 seconds.

 **NOTE:** You can disable the power LED in the OSD menu. Press the **Menu** button on the monitor's rear panel, and then select **Power Control > Power LED > Off**.

When the monitor is first turned on, a Monitor Status message is displayed for five seconds. The message shows which input is the current active signal, the current preset display resolution, and the recommended preset display resolution.

The monitor automatically scans the signal inputs for an active input and uses that input for the display.

Mounting the monitor

The monitor panel can be attached to a wall, swing arm, or other mounting fixture.

 **NOTE:** This apparatus is intended to be supported by UL- or CSA-Listed wall-mount bracket.

 **CAUTION:** This monitor supports the VESA industry-standard 100 mm mounting holes. To attach a third-party mounting solution to the monitor, four 4 mm, 0.7 pitch, and 10 mm-long screws are required. Longer screws may damage the monitor. It is important to verify that the manufacturer's mounting solution is compliant with the VESA standard and is rated to support the weight of the monitor head. For best performance, use the power and video cables provided with the monitor.

Removing the monitor stand

 **CAUTION:** Before beginning to disassemble the monitor, be sure the monitor is turned off and all cables are disconnected.

1. Disconnect and remove all cables from the monitor.
2. Position the monitor face down on a flat surface covered by protective sheet foam or a nonabrasive cloth.
3. Press the VESA release button (1) to release the stand.
4. Swing the bottom of the stand up until the mounting plate clears the recess in the panel (2).
5. Slide the stand out of the recess (3).

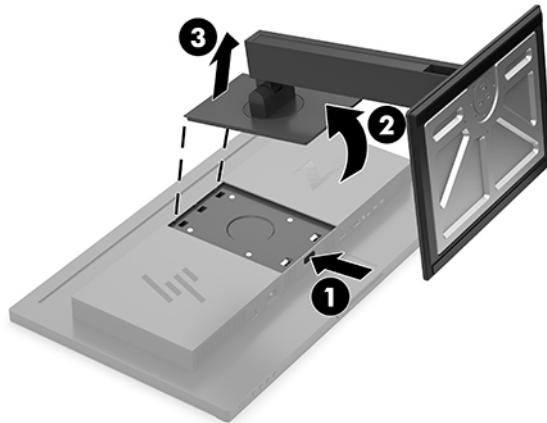

Attaching the monitor to a mounting device

1. Remove the monitor stand. Refer to [Removing the monitor stand on page 13](#).
2. Remove the four screws from the VESA holes located on the rear of the monitor head.
3. Use the four screws removed from the VESA holes on rear of the monitor head to attach the mounting device to the monitor.

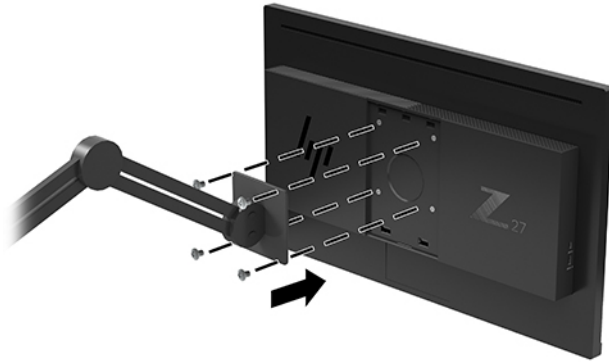

 **IMPORTANT:** Follow the mounting device manufacturer's instructions when mounting the monitor to a wall or swing arm.

IMPORTANT: For optimal monitor performance and screen clarity, do not rotate the monitor 90 degrees to portrait orientation.

HP watermark and image retention policy

The IPS display models are designed with IPS (In-Plane Switching) display technology which provides ultra-wide viewing angles and advanced image quality. IPS displays are suitable for a wide variety of advanced image quality applications. This panel technology, however, is not suitable for applications that exhibit static, stationary or fixed images for long periods of time without the use of screen savers. These types of applications may include camera surveillance, video games, marketing logos, and templates that are displayed on the screen for a prolonged period of time. Static images may cause image retention damage that could look like stains or watermarks on the display's screen.

Displays in use for 24 hours per day that result in image retention damage are not covered under the HP warranty. To avoid image retention damage, always turn off the display when it is not in use or use the power management setting, if supported on your system, to turn off the display when the system is idle.

2 Using the monitor

Software and utilities

You can download and install the following files from <http://www.hp.com/support>.

- INF (Information) file
- ICM (Image Color Matching) files (one for each calibrated color space)
- HP Display Assistant—adjusts the monitor settings and enables theft deterrence features

The Information file

The INF file defines monitor resources used by Windows® operating systems to ensure monitor compatibility with the computer's graphics adapter.

This monitor is Windows Plug and Play-compatible and the monitor will work correctly without installing the INF file. Monitor Plug and Play-compatibility requires that the computer's graphic card is VESA DDC2-compliant and that the monitor connects directly to the graphics card. Plug and Play does not work through separate BNC-type connectors or through distribution buffers/boxes.

The Image Color Matching file

The ICM files are data files that are used in conjunction with graphics programs to provide consistent color matching from monitor screen to printer, or from scanner to monitor screen. This file is activated from within graphics programs that support this feature.



NOTE: The ICM color profile is written in accordance with the International Color Consortium (ICC) Profile Format specification.

Using the on-screen display (OSD) menu

Use the OSD menu to adjust the monitor screen image based on your preferences. You can access and make adjustments in the OSD menu using the Function buttons on the monitor's rear panel.

To access the OSD menu and make adjustments, do the following:

1. If the monitor is not already on, press the power button on the monitor's rear panel to turn on the monitor.
2. To access the OSD menu, press one of the four Function buttons on the monitor's rear panel to activate the buttons. Then press the **Menu** button to open the OSD.
3. Use the Function buttons to navigate, select, and adjust the menu choices. The on-screen button labels vary depending on which menu or submenu is active.

The following table lists the menu selections in the OSD main menu.

Main Menu	Description
Brightness or Luminance	Adjusts the brightness or luminance level of the screen.
Contrast	Adjusts the contrast level of the screen. The factory default is 80.

Main Menu	Description
Color Control	Selects and adjusts the screen color.
Input Control	Selects the video input signal.
Image Control	Adjusts the screen image.
PIP Control	Selects and adjusts the PIP image.
Power Control	Adjusts the power settings.
Menu Control	Adjusts the OSD controls.
Management	Adjusts the DDC/CI settings and returns all OSD menu settings to the factory default settings.
Information	Selects and displays important information about the monitor.
Exit	Exits the OSD menu screen.

Using Picture-in-Picture (PIP) and Picture-beside-Picture (PBP)

The monitor supports both PIP, where one source is overlaid on another, and PBP, where one source is positioned adjacent to another either horizontally (for landscape orientation) or vertically (for portrait orientation). Two full high definition (FHD) images can be displayed in the PIP mode.

To use PIP or PBP:

1. Connect a secondary input source to the monitor.
2. Press one of the four Function buttons on the rear panel to activate the buttons, and then press the **Menu** button to open the OSD.
3. In the OSD, select **PIP Control** and then select **Enable PIP**.
4. The monitor will scan the secondary inputs for a valid signal input and use that input for the PIP/PBP picture. If you want to change the PIP/PBP input, select **PIP Control** in the OSD, and then select **Assign Inputs**.
5. If you want to change the size of the PIP, select **PIP Size** in the OSD, and then select the desired size.
6. If you want to adjust the position of the PIP, select **PIP Position** in the OSD, and then select the desired position.

Adjusting Low Blue Light Mode

Decreasing the blue light emitted by the monitor reduces the blue light exposure to your eyes. This monitor allows you to select a setting to reduce blue light output and create a more relaxing and less stimulating image while reading content on the screen.

To adjust the blue light output from the monitor:

1. Press one of the four rear panel Function buttons to activate the buttons, and then press the **Menu** button to open the OSD. Select **Color Control** and **Viewing Mode**.
2. Select your desired setting:

- **Low Blue Light:** TUV certified. Reduces blue light for improved eye comfort
 - **Reading:** Optimizes blue light and brightness for indoor viewing
 - **Night:** Adjusts to the lowest blue light and reduces the impact on sleep
3. Select **Save and Return** to save your setting and close the menu. Select **Cancel** if you don't want to save the setting.
 4. Select **Exit** from the Main menu.

 **WARNING!** To reduce the risk of serious injury, read the *Safety & Comfort Guide*. It describes proper workstation setup and proper posture, and health and work habits for computer users. The *Safety & Comfort Guide* also provides important electrical and mechanical safety information. The *Safety & Comfort Guide* is available on the web at <http://www.hp.com/ergo>.

Using Auto-Sleep Mode

The monitor supports an OSD option called Auto-Sleep Mode that allows you to enable or disable a reduced power state for the monitor. When Auto-Sleep Mode is enabled (enabled by default), the monitor will enter a reduced power state when the computer signals low power mode (absence of either horizontal or vertical sync signal).

Upon entering this reduced power state (sleep mode), the monitor screen is blanked, the backlight is turned off, and the power LED indicator turns amber. The monitor draws less than 0.5 W of power when in this reduced power state. The monitor will wake from sleep mode when the computer sends an active signal to the monitor (for example, if you activate the mouse or keyboard).

You can disable Auto-Sleep Mode in the OSD. Press the **Menu** button on the monitor's rear panel to open the OSD. In the OSD select **Power Control**, select **Auto-Sleep Mode**, and then select **Off**.

3 Support and troubleshooting

Solving common problems

The following table lists possible problems, the possible cause of each problem, and the recommended solutions.

Problem	Possible Cause	Solution
Screen is blank or video is flashing.	Power cord is disconnected.	Connect the power cord.
	Monitor is turned off.	Press the rear panel power button. NOTE: If pressing the power button has no effect, press and hold the power button for 10 seconds to disable the Power Button Lockout feature.
	Master power switch is set to off.	Set the master power switch on the rear of the monitor to the On position.
	Video cable is improperly connected.	Connect the video cable properly. Refer to Connecting the cables on page 6 for more information.
	System is in sleep mode.	Press any key on the keyboard or move the mouse to inactivate the screen blanking utility.
	Video card is incompatible.	Open the OSD menu and select the Input Control menu. Set Auto-Switch Input to Off and manually select the input.
Image appears blurred, indistinct, or too dark.	Brightness setting is too low.	Open the OSD menu and select Brightness to adjust the brightness scale as needed.
Check Video Cable is displayed on the screen.	Monitor video cable is disconnected.	Connect the appropriate video signal cable between the computer and monitor. Be sure that the computer power is off while connecting the video cable.
Input Signal Out of Range is displayed on screen.	Video resolution and/or refresh rate are set higher than the monitor supports.	Change the settings to a supported setting (see Preset display resolutions on page 22).
The monitor is off but it did not seem to enter into a low-power sleep mode.	The monitor's power saving control is disabled.	Open the OSD menu and select Power Control , select Auto-Sleep Mode , and then set auto-sleep to On .
OSD Lockout is displayed.	The monitor's OSD Lockout function is enabled.	Press and hold the Menu button on the rear panel for 10 seconds to disable the OSD Lockout function.
Power Button Lockout is displayed.	The monitor's Power Button Lockout feature is enabled.	Press and hold the power button on the rear panel for 10 seconds to unlock the power button function.

Button lockouts

Holding down the power button or **Menu** button on the rear panel for ten seconds will lock out the functionality of the buttons. You can restore the functionality by holding the buttons down again for ten seconds. This functionality is only available when the monitor is turned on and displaying an active signal, and the OSD is closed.

Contacting support

To resolve a hardware or software problem, go to <http://www.hp.com/support>. Use this site to get more information about your product, including links to discussion forums and instructions on troubleshooting. You can also find information on how to contact HP and open a support case.

Preparing to call technical support

If you cannot solve a problem using the troubleshooting tips in this section, you may need to call technical support. Have the following information available when you call:

- Monitor model number
- Monitor serial number
- Purchase date on invoice
- Conditions under which the problem occurred
- Error messages received
- Hardware configuration
- Name and version of the hardware and software you are using

Locating the serial number and product number

The serial number and product number are located on a label on the rear of the monitor head. You may need these numbers when contacting HP about the monitor model.

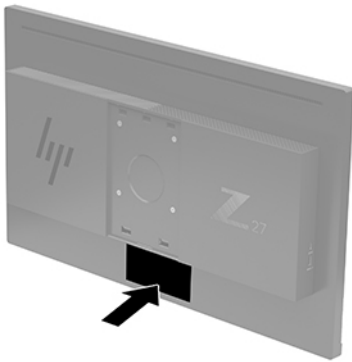

4 Maintaining the monitor

Maintenance guidelines

To enhance the performance and extend the life of the monitor:

- Do not open the monitor cabinet or attempt to service this product yourself. Adjust only those controls that are covered in the operating instructions. If the monitor is not operating properly or has been dropped or damaged, contact an authorized HP dealer, reseller, or service provider.
- Use only a power source and connection appropriate for this monitor, as indicated on the label/back plate of the monitor.
- Be sure the total ampere rating of the products connected to the outlet does not exceed the current rating of the AC outlet, and the total ampere rating of the products connected to the cord does not exceed the rating of the cord. Look on the power label to determine the ampere rating (AMPS or A) for each device.
- Install the monitor near an outlet that you can easily reach. Disconnect the monitor by grasping the plug firmly and pulling it from the outlet. Never disconnect the monitor by pulling the cord.
- Turn the monitor off when not in use. You can substantially increase the life expectancy of the monitor by using a screen saver program and turning off the monitor when not in use.



NOTE: A burned-in image on the monitor is not covered under the HP warranty.

- Slots and openings in the cabinet are provided for ventilation. These openings must not be blocked or covered. Never push objects of any kind into cabinet slots or other openings.
- Do not drop the monitor or place it on an unstable surface.
- Do not allow anything to rest on the power cord. Do not walk on the cord.
- Keep the monitor in a well-ventilated area, away from excessive light, heat, or moisture.
- When removing the monitor stand, you must position the monitor facedown on a soft area to prevent it from getting scratched, defaced, or broken.

Cleaning the monitor

1. Turn off the monitor and unplug the power cord from the back of the unit.
2. Dust the monitor by wiping the screen and the cabinet with a soft, clean antistatic cloth.
3. For more difficult cleaning situations, use a 50/50 mix of water and isopropyl alcohol.



IMPORTANT: Spray the cleaner onto a cloth and use the damp cloth to gently wipe the screen surface. Never spray the cleaner directly on the screen surface. It may run behind the bezel and damage the electronics.

IMPORTANT: Do not use cleaners that contain any petroleum based materials such as benzene, thinner, or any volatile substance to clean the monitor screen or cabinet. These chemicals may damage the monitor.

Shipping the monitor

Keep the original packing box in a storage area. You may need it later if you move or ship the monitor.

A Technical specifications



NOTE: All specifications represent the typical specifications provided by HP's component manufacturers; actual performance may vary either higher or lower.

For the latest specifications or additional specifications on this product, go to <http://www.hp.com/go/quickspecs/> and search for your specific monitor model to find the model-specific QuickSpecs.

Display	68.6 cm wide screen	27.0 in wide screen
Type	IPS	
Viewable image size	68.6 cm diagonal	27.0 in diagonal
Tilt	-5° to 20°	
Weight		
Without stand	6.21 kg	13.69 lbs
With stand	9.38 kg	20.68 lbs
Dimensions (including stand)		
Height (highest position)	50.98 cm	20.07 in
Height (lowest position)	37.81 cm	14.89 in
Depth	23.0 cm	9.06 in
Width	61.41 cm	24.18 in
Maximum graphic resolution	3840 x 2160 (60 Hz)	
Optimum graphic resolution	3840 x 2160 (60 Hz)	
Dot pitch	0.06053 (H) x 0.18159 (V) mm	
Pixels per inch	140 PPI	
Horizontal frequency	28 kHz to 135 kHz	
Vertical refresh rate	29 Hz to 60 Hz	
Environmental requirements temperature		
Operating temperature	5°C to 35°C	41°F to 95°F
Storage temperature	-34°C to 60°C	-29°F to 140°F
Relative humidity	20% to 80%	
Power source	100 V ac to 240 V ac 50/60 Hz	
Altitude:		
Operating	0 m to 5,000 m	0 to 16,400 ft
Storage	0 m to 12,192 m	0 to 40,000 ft
Measured power consumption:		
Full power	200 W	

Typical settings	70 W
Sleep	<0.5 W
Off	<0.3 W
Input terminal	One DisplayPort port, one Mini DisplayPort port, one HDMI port, one analog audio-out jack, three USB 3.0 Type-A ports, one USB Type-C port (downstream)

Preset display resolutions

The display resolutions listed below are the most commonly used modes and are set as factory defaults. This monitor automatically recognizes these preset modes and they will appear properly sized and centered on the screen.

Preset	Pixel format	Horz freq (kHz)	Vert freq (Hz)
1	640 × 480	31.469	59.940
2	720 × 400	31.469	70.087
3	800 × 600	37.879	60.317
4	720 × 480	31.469	59.940
5	1024 × 768	48.363	60.004
6	1280 × 720	45.000	60.000
7	1280 × 768	47.396	59.995
8	1280 × 800	49.702	59.810
9	1280 × 1024	63.981	60.020
10	1440 × 900	55.935	59.887
11	1440 × 900	55.469	59.901
12	1600 × 900	60.000	60.000
13	1600 × 1200	75.000	60.000
14	1680 × 1050	65.290	59.954
15	1920 × 1080	67.500	60.000
16	1920 × 1200	74.038	59.950
17	1920 × 1200	74.556	59.885
18	2560 × 1440	88.787	59.951
19	2560 × 1600	98.713	59.972
20	3840 × 2160	65.688	29.981
21	3840 × 2160	133.313	59.997

Preset	Timing name	Pixel format	Horz freq (kHz)	Vert freq (Hz)
1	480i	720 × 480	15.734	59.94
2	480p	720 × 480	31.469	59.94
3	720p60	1280 × 720	45.000	60.00
4	1080i60	1920 × 1080	33.750	60.00
5	576i	720 × 576	15.625	50.00
6	576p	720 × 576	31.250	50.00
7	720p50	1280 × 720	37.500	50.00
8	1080i50	1920 × 1080	28.125	50.00
9	1080p60	1920 × 1080	67.500	60.00
10	1080p50	1920 × 1080	56.250	50.00

Energy saver feature

The monitor supports a reduced power state. The reduced power state will be entered into if the monitor detects the absence of either the horizontal sync signal or the vertical sync signal. Upon detecting the absence of these signals, the monitor screen is blanked, the backlight is turned off, and the power light turns amber. When the monitor is in the reduced power state, the monitor will utilize <0.5 watts of power. There is a brief warm-up period before the monitor will return to its normal operating state.

Refer to the computer manual for instructions on setting the energy saver mode (sometimes called power management feature).



NOTE: The above power saver feature works only when the monitor is connected to a computer that has energy saver features.

By selecting the settings in the monitor's Sleep Timer utility, you can also program the monitor to enter into the reduced power state at a predetermined time. When the monitor's Sleep Timer utility causes the monitor to enter the reduced power state, the power light blinks amber.

B Accessibility

HP designs, produces, and markets products and services that can be used by everyone, including people with disabilities, either on a stand-alone basis or with appropriate assistive devices.

Supported assistive technologies

HP products support a wide variety of operating system assistive technologies and can be configured to work with additional assistive technologies. Use the Search feature on your source device that is connected to the monitor to locate more information about assistive features.



NOTE: For additional information about a particular assistive technology product, contact customer support for that product.

Contacting support

We are constantly refining the accessibility of our products and services and welcome feedback from users. If you have an issue with a product or would like to tell us about accessibility features that have helped you, please contact us at (888) 259-5707, Monday through Friday, 6 a.m. to 9 p.m. Mountain Time. If you are deaf or hard-of-hearing and use TRS/VRS/WebCapTel, contact us if you require technical support or have accessibility questions by calling (877) 656-7058, Monday through Friday, 6 a.m. to 9 p.m. Mountain Time.