



# Hardware Reference Guide

HP EliteDesk 800 G3 SFF Business PC

© Copyright 2016, 2018 HP Development Company, L.P.

Windows is either a registered trademark or trademark of Microsoft Corporation in the United States and/or other countries.

The information contained herein is subject to change without notice. The only warranties for HP products and services are set forth in the express warranty statements accompanying such products and services. Nothing herein should be construed as constituting an additional warranty. HP shall not be liable for technical or editorial errors or omissions contained herein.

Second Edition: February 2018

First Edition: November 2016

Document Part Number: 913350-002

### **Product notice**

This guide describes features that are common to most models. Some features may not be available on your computer.

### **Software terms**





By installing, copying, downloading, or otherwise using any software product preinstalled on this computer, you agree to be bound by the terms of the HP End User License Agreement (EULA). If you do not accept these license terms, your sole remedy is to return the entire unused product (hardware and software) within 14 days for a full refund subject to the refund policy of your seller.

For any further information or to request a full refund of the price of the computer, please contact your seller.

## About This Book

This guide provides basic information for upgrading the HP EliteDesk Business PC.

---

-  **WARNING!** Indicates a hazardous situation that, if not avoided, **could** result in death or serious injury.
  -  **CAUTION:** Indicates a hazardous situation that, if not avoided, **could** result in minor or moderate injury.
  -  **IMPORTANT:** Indicates information considered important but not hazard-related (for example, messages related to property damage). A notice alerts the user that failure to follow a procedure exactly as described could result in loss of data or in damage to hardware or software. Also contains essential information to explain a concept or to complete a task.
  -  **NOTE:** Contains additional information to emphasize or supplement important points of the main text.
  -  **TIP:** Provides helpful hints for completing a task.
-



---

# Table of contents

<b>1 Product features</b>	<b>1</b>
Standard configuration features	1
Front panel components	2
Rear panel components	3
Serial number location	4
<b>2 Hardware upgrades</b>	<b>5</b>
Serviceability features	5
Warnings and cautions	5
Removing the computer access panel	6
Replacing the computer access panel	7
Removing the front bezel	8
Removing a slim optical drive bezel blank	9
Replacing the front bezel	9
Removing and installing the optional front bezel dust filter	10
Changing from desktop to tower orientation	12
System board connections	13
Upgrading system memory	14
Installing a memory module	14
Removing or installing an expansion card	17
Drive positions	21
Removing and installing drives	21
Removing a 9.5 mm slim optical drive	22
Installing a 9.5 mm slim optical drive	24
Removing a 3.5-inch hard drive	26
Installing a 3.5-inch hard drive	28
Removing a 2.5-inch hard drive	32
Installing a 2.5-inch hard drive	34
Removing and installing an M.2 SSD storage card	37
Installing a security lock	40
Cable lock	40
Padlock	40
HP Business PC Security Lock V2	41
<b>Appendix A Battery replacement</b>	<b>46</b>

<b>Appendix B Electrostatic discharge .....</b>	<b>49</b>
Preventing electrostatic damage .....	49
Grounding methods .....	49
<b>Appendix C Computer operating guidelines, routine care and shipping preparation .....</b>	<b>50</b>
Computer operating guidelines and routine care .....	50
Optical drive precautions .....	51
Operation .....	51
Cleaning .....	51
Safety .....	51
Shipping preparation .....	51
<b>Appendix D Accessibility .....</b>	<b>52</b>
Supported assistive technologies .....	52
Contacting support .....	52
<b>Index .....</b>	<b>53</b>

---

# 1 Product features

## Standard configuration features

Features may vary depending on the model. For support assistance and to learn more about the hardware and software installed on your computer model, run the HP Support Assistant utility.



---

**NOTE:** This computer model can be used in a tower orientation or a desktop orientation.

---



## Front panel components

Drive configuration may vary by model. Some models have a bezel blank covering the slim optical drive bay.

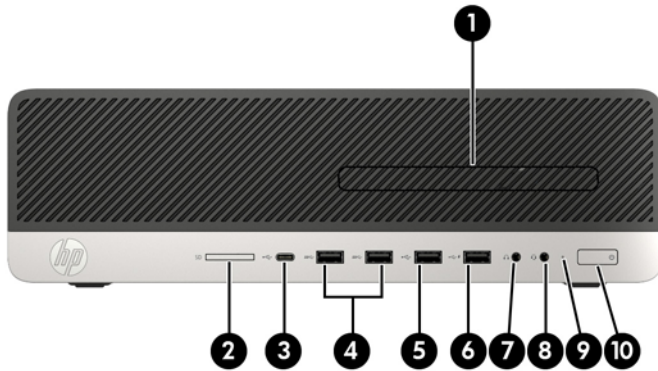

### Front panel components

1	Slim optical drive (optional)	6	USB 2.0 port with HP Sleep and Charge
2	SD card reader (optional)	7	Audio-out (headphone) jack
3	USB Type-C charging port	8	Audio-out (headphone)/Audio-in (microphone) combo jack
4	USB 3.x ports (2)	9	Hard drive activity light
5	USB 2.0 port	10	Power button





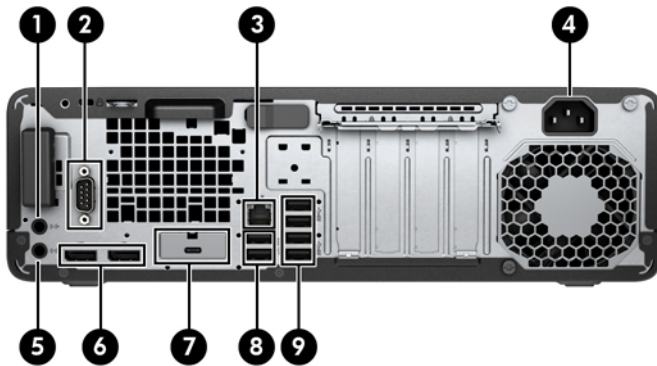

**NOTE:** The light on the power button is normally white when the power is on. If it is flashing red, there is a problem with the computer and it is displaying a diagnostic code. Refer to the *Maintenance and Service Guide* to interpret the code.



## Rear panel components



### Rear panel components

1		Audio-in jack	6		DisplayPort monitor connectors (2)
2		Serial port (optional)	7		Optional port
3		RJ-45 (network) jack	8		USB 2.0 ports (2)
4		Power cord connector	9		USB 3.x ports (4)
5		Audio-out jack for powered audio devices			

**NOTE:** Your model may have additional optional ports available from HP.

When a device is plugged into either audio jack, a dialog box will appear on the monitor screen asking if you want to use the jack for a microphone or a headphone. You can also reconfigure the jacks at any time by double-clicking the Audio Manager icon in the Windows taskbar.

When a graphics card is installed in one of the system board slots, the video connectors on the graphics card and/or the integrated graphics on the system board may be used. The specific graphics card installed and software configuration will determine the behavior.

The system board graphics can be disabled by changing settings in BIOS F10 Setup.

## Serial number location

Each computer has a unique serial number and a product ID number that are located on the exterior of the computer. Keep these numbers available for use when contacting customer service for assistance.



---

## 2 Hardware upgrades

### Serviceability features

The computer includes features that make it easy to upgrade and service. A Torx T15 or flat-bladed screwdriver is needed for some of the installation procedures described in this chapter.

### Warnings and cautions

Before performing upgrades be sure to carefully read all of the applicable instructions, cautions, and warnings in this guide.

---

 **WARNING!** To reduce the risk of personal injury from electrical shock, hot surfaces, or fire:

Disconnect the power cord from the AC outlet and allow the internal system components to cool before you touch them.

Do not plug telecommunications or telephone connectors into the network interface controller (NIC) receptacles.

Do not disable the power cord grounding plug. The grounding plug is an important safety feature.

Plug the power cord into a grounded (earthed) outlet that is easily accessible at all times.

To reduce the risk of serious injury, read the *Safety & Comfort Guide*. It describes proper workstation setup, and proper posture, health, and work habits for computer users. The *Safety & Comfort Guide* also provides important electrical and mechanical safety information. The *Safety & Comfort Guide* is available on the Web at <http://www.hp.com/ergo>.

 **WARNING!** Energized and moving parts inside.

Disconnect power to the equipment before removing the enclosure.

Replace and secure the enclosure before re-energizing the equipment.

 **IMPORTANT:** Static electricity can damage the electrical components of the computer or optional equipment. Before beginning these procedures, ensure that you are discharged of static electricity by briefly touching a grounded metal object. See [Electrostatic discharge on page 49](#) for more information.

When the computer is plugged into an AC power source, voltage is always applied to the system board. To prevent damage to internal components, you must disconnect the power cord from the power source before opening the computer.

---

## Removing the computer access panel

To access internal components, you must remove the access panel.

1. Remove/disengage any security devices that prohibit opening the computer.
2. Remove all removable media, such as compact discs or USB flash drives, from the computer.
3. Turn off the computer properly through the operating system, and turn off any external devices.
4. Disconnect the power cord from the AC outlet and disconnect any external devices.

 **IMPORTANT:** Regardless of the power-on state, voltage is always present on the system board as long as the system is plugged into an active AC outlet. To prevent damage to internal components, you must disconnect the power cord from the power source before opening the computer.

5. If the computer is on a stand, remove the computer from the stand and lay the computer down.
6. Slide the access panel release lever to the left (1) so that it locks into place. Then slide the access panel back (2) and lift it off the computer (3).



## Replacing the computer access panel

Be sure that the access panel release lever is locked into place, and then place the access panel on the computer (1) and slide the panel forward (2). The release lever will automatically move back to the right and lock the access panel.

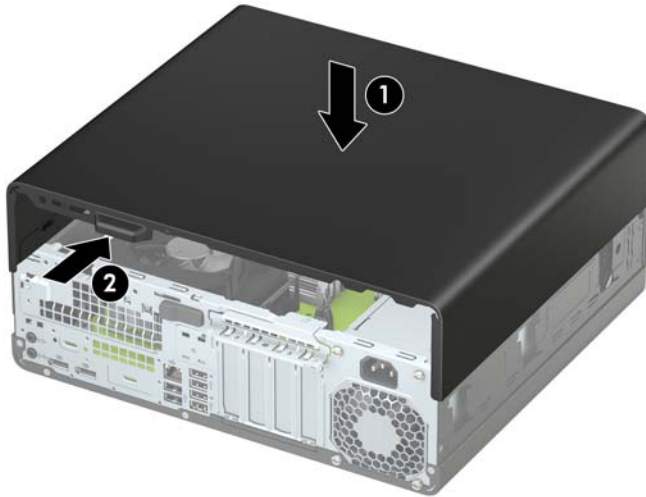

## Removing the front bezel

1. Remove/disengage any security devices that prohibit opening the computer.
2. Remove all removable media, such as compact discs or USB flash drives, from the computer.
3. Turn off the computer properly through the operating system, and turn off any external devices.
4. Disconnect the power cord from the AC outlet and disconnect any external devices.

---

 **IMPORTANT:** Regardless of the power-on state, voltage is always present on the system board as long as the system is plugged into an active AC outlet. To prevent damage to internal components, you must disconnect the power cord from the power source before opening the computer.

---

5. If the computer is on a stand, remove the computer from the stand and lay the computer down.
6. Remove the computer access panel. See [Removing the computer access panel on page 6](#).
7. Lift up the three tabs on the top of the bezel (1), and then rotate the bezel off the chassis (2).

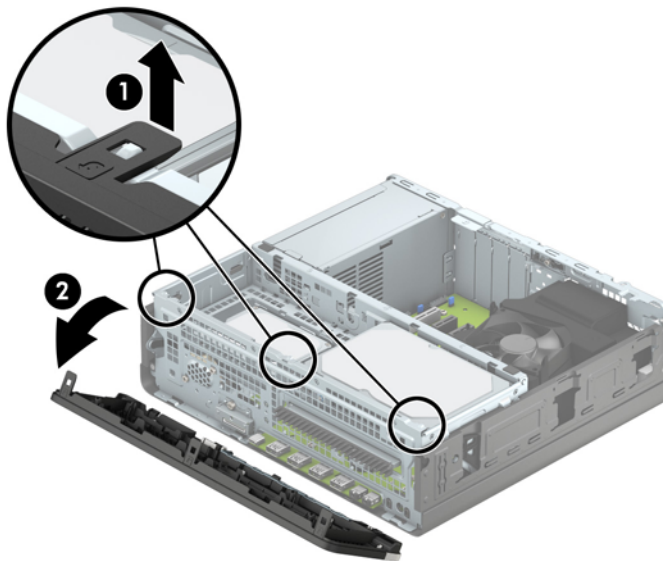

## Removing a slim optical drive bezel blank

On some models, a bezel blank covers the slim optical drive bay. Remove the bezel blank before installing an optical drive. To remove the bezel blank:

1. Remove the computer access panel and front bezel.
2. Then press inward on the tab on the left side of the blank (1), and then rotate the blank off the front bezel (2).

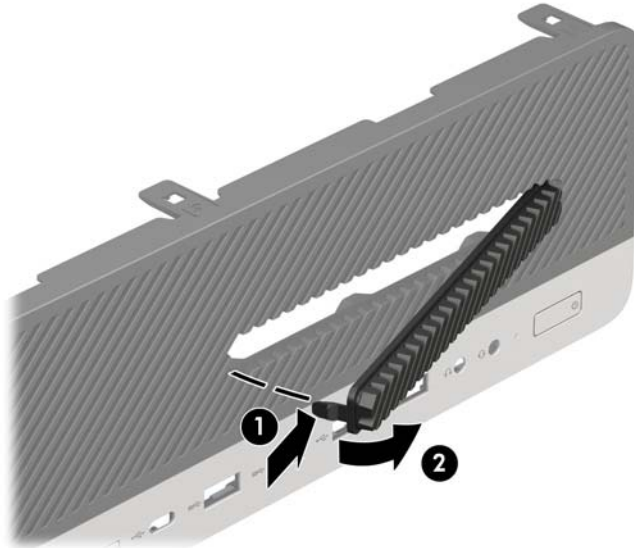

## Replacing the front bezel

Insert the three hooks on the bottom of the bezel into the rectangular holes on the chassis (1), and then rotate the top of the bezel onto the chassis (2) and snap it into place.

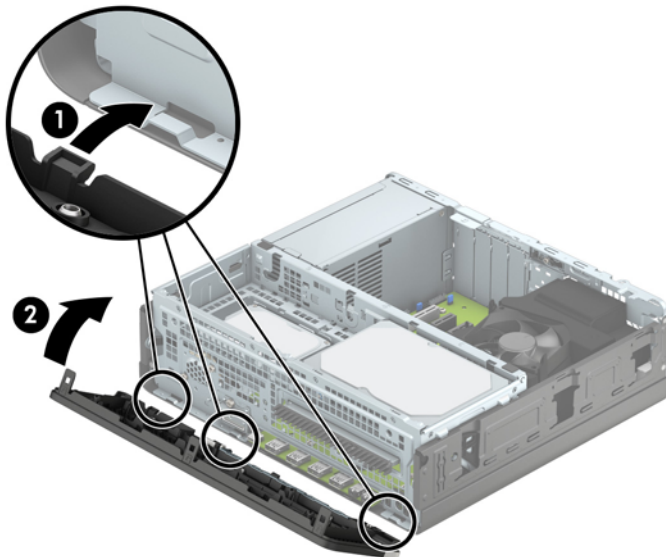

## Removing and installing the optional front bezel dust filter

Some models are equipped with an optional front bezel dust filter. You must periodically clean the dust filter so that the dust collected on the filter does not impede air flow through the computer.

 **NOTE:** The optional front bezel dust filter is available from HP.

To remove, clean, and replace the dust filter:

1. Turn off the computer properly through the operating system, and turn off any external devices.
2. Disconnect the power cord from the AC outlet and disconnect any external devices.

 **NOTE:** Regardless of the power-on state, voltage is always present on the system board as long as the system is plugged into an active AC outlet. To prevent damage to internal components, you must disconnect the power cord from the power source before opening the computer.

3. To remove the dust filter, use your fingers to separate the filter from the front bezel at the tab locations shown below.

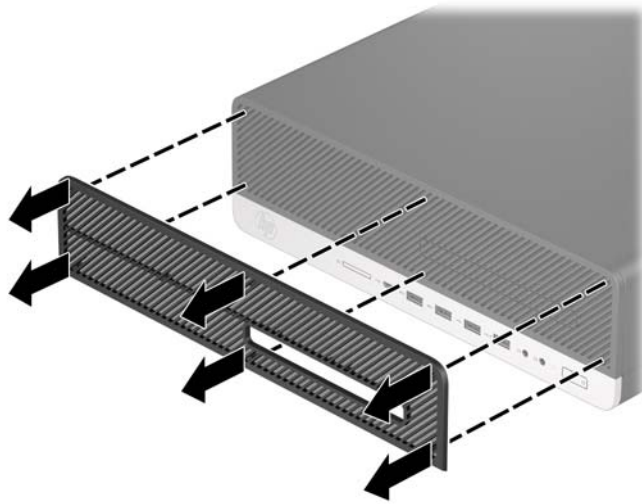

4. Use a soft brush or cloth to clean dust from the filter. If heavily soiled, rinse the filter clean with water.



5. To replace the dust filter, press the filter firmly onto the front bezel at the tab locations shown below.

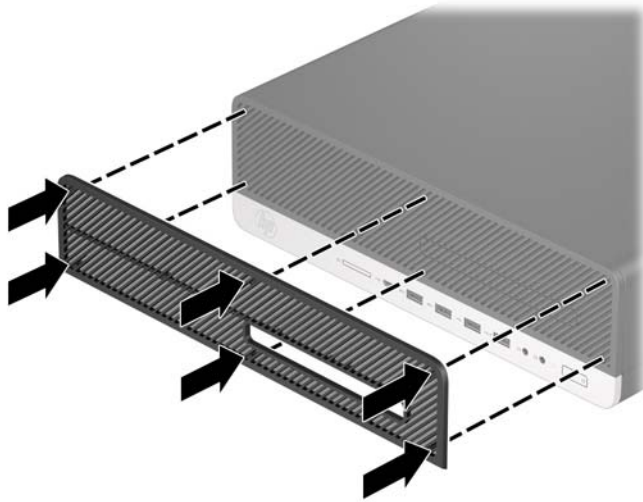

6. Reconnect the power cord and any external devices, and then turn on the computer.

## Changing from desktop to tower orientation

The Small Form Factor computer can be used in a tower orientation with an optional tower stand that can be purchased from HP.

 **NOTE:** To stabilize the computer in a tower orientation, HP recommends the use of the optional tower stand.

1. Remove/disengage any security devices that prohibit moving the computer.
2. Remove all removable media, such as compact discs or USB flash drives, from the computer.
3. Turn off the computer properly through the operating system, and turn off any external devices.
4. Disconnect the power cord from the AC outlet and disconnect any external devices.

 **IMPORTANT:** Regardless of the power-on state, voltage is always present on the system board as long as the system is plugged into an active AC outlet. To prevent damage to internal components, you must disconnect the power cord from the power source before opening the computer.

5. Orient the computer so that its right side is facing down and place the computer in the optional stand.

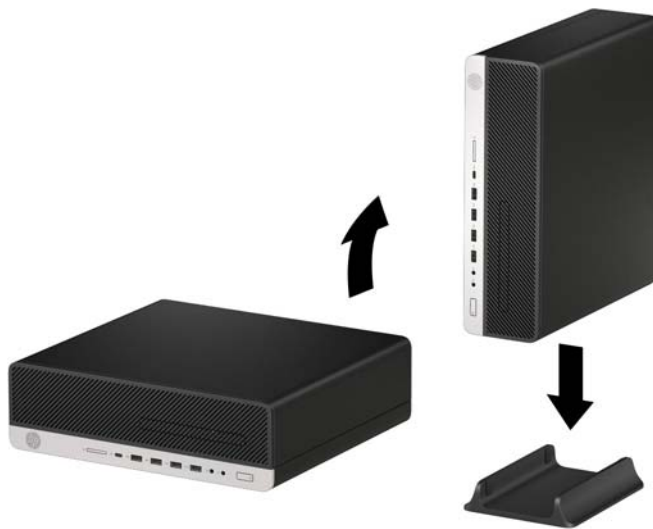

6. Reconnect the power cord and any external devices, and then turn on the computer.

 **NOTE:** Be sure that at least 10.2 centimeters (4 inches) of space on all sides of the computer remains clear and free of obstructions.

7. Lock any security devices that were disengaged before the computer was moved.

# System board connections

Refer to the following illustration and table to identify the system board connectors for your model.

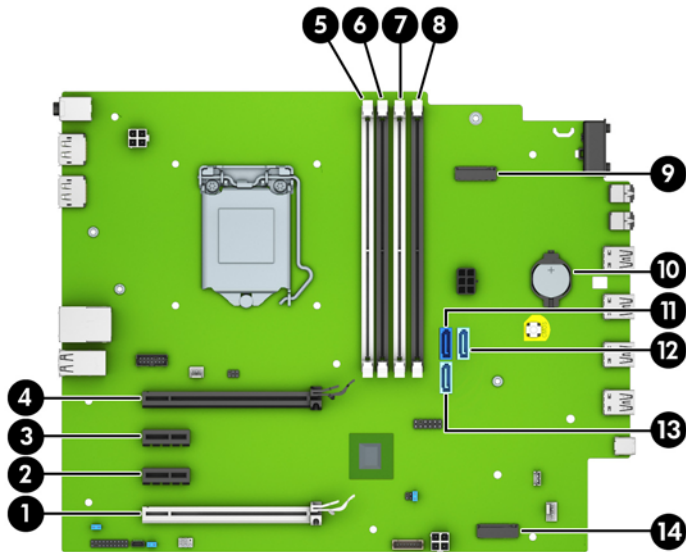

Item	System board connector	System board label	Color	Component
1	PCI Express x16 downshifted to a x4	X4PCIEXP	White	Expansion card
2	PCI Express x1	X1PCIEXP2	Black	Expansion card
3	PCI Express x1	X1PCIEXP1	Black	Expansion card
4	PCI Express x16	X16PCIEXP	Black	Expansion card
5	DIMM4 (Channel A)	DIMM4	White	Memory module
6	DIMM3 (Channel A)	DIMM3	Black	Memory module
7	DIMM2 (Channel B)	DIMM2	White	Memory module
8	DIMM1 (Channel B)	DIMM1	Black	Memory module
9	M.2 WLAN	WLAN	Black	M.2 WLAN card
10	Battery	BAT	Black	Battery
11	SATA 3.0	SATA0	Dark blue	Primary hard drive
12	SATA 3.0	SATA3	Light blue	Any SATA device other than the primary hard drive
13	SATA 3.0	SATA1	Light blue	Any SATA device other than the primary hard drive
14	M.2 SSD	SSD	Black	M.2 SSD storage card

## Upgrading system memory

The computer comes with double data rate 4 synchronous dynamic random access memory (DDR4-SDRAM) dual inline memory modules (DIMMs).

The memory sockets on the system board are populated with at least one preinstalled memory module. To achieve the maximum memory support, you can populate the system board with up to 64 GB of memory configured in a high-performing dual-channel mode.

For proper system operation, the DIMMs must adhere to the following specifications:

- Industry-standard 288-pin
- Unbuffered non-ECC PC4-19200 DDR4-2400 MHz-compliant
- 1.2 volt DDR4-SDRAM memory modules
- CAS latency 17 DDR4 2400 MHz (17-17-17 timing)
- Mandatory JEDEC SPD information

The computer supports the following:

- 512 Mb, 1 Gb, 2 Gb, and 4 Gb non-ECC memory technologies
- Single-sided and double-sided memory modules
- Memory modules constructed with x8 and x16 DDR devices; memory modules constructed with x4 SDRAM are not supported



---

**NOTE:** The system does not operate properly if you install unsupported memory modules.

---

## Installing a memory module

There are four memory sockets on the system board, with two sockets per channel. The sockets are labeled DIMM1, DIMM2, DIMM3, and DIMM4. Sockets DIMM1 and DIMM2 operate in memory channel B. Sockets DIMM3 and DIMM4 operate in memory channel A.

The system will automatically operate in single-channel mode, dual-channel mode, or flex mode, depending on how the DIMMs are installed.



---

**NOTE:** Single-channel and unbalanced dual-channel memory configurations will result in inferior graphics performance.

---

- The system will operate in single-channel mode if the DIMM sockets are populated in one channel only.
- The system will operate in a higher-performing dual-channel mode if the total memory capacity of the DIMMs in Channel A is equal to the total memory capacity of the DIMMs in Channel B. The technology and device width can vary between the channels. For example, if Channel A is populated with two 1 GB DIMMs and Channel B is populated with one 2 GB DIMM, the system will operate in dual-channel mode.
- The system will operate in flex mode if the total memory capacity of the DIMMs in Channel A is not equal to the total memory capacity of the DIMMs in Channel B. In flex mode, the channel populated with the least amount of memory describes the total amount of memory assigned to dual channel and the remainder is assigned to single channel. For optimal speed, the channels should be balanced so that the largest amount of memory is spread between the two channels. If one channel will have more memory than the other, the larger amount should be assigned to Channel A. For example, if you are populating the sockets with one 2 GB DIMM, and three 1 GB DIMMs, Channel A should be populated with the 2 GB

DIMM and one 1 GB DIMM, and Channel B should be populated with the other two 1 GB DIMMs. With this configuration, 4 GB will run as dual-channel and 1 GB will run as single-channel.

- In any mode, the maximum operational speed is determined by the slowest DIMM in the system.

---

 **IMPORTANT:** You must disconnect the power cord and wait approximately 30 seconds for the power to drain before adding or removing memory modules. Regardless of the power-on state, voltage is always supplied to the memory modules as long as the computer is plugged into an active AC outlet. Adding or removing memory modules while voltage is present may cause irreparable damage to the memory modules or system board.

The memory module sockets have gold-plated metal contacts. When upgrading the memory, it is important to use memory modules with gold-plated metal contacts to prevent corrosion and/or oxidation resulting from having incompatible metals in contact with each other.

Static electricity can damage the electronic components of the computer or optional cards. Before beginning these procedures, ensure that you are discharged of static electricity by briefly touching a grounded metal object. For more information, refer to [Electrostatic discharge on page 49](#).

When handling a memory module, be careful not to touch any of the contacts. Doing so may damage the module.

- 
1. Remove/disengage any security devices that prohibit opening the computer.
  2. Remove all removable media, such as compact discs or USB flash drives, from the computer.
  3. Turn off the computer properly through the operating system, and turn off any external devices.
  4. Disconnect the power cord from the AC outlet and disconnect any external devices.

---

 **IMPORTANT:** You must disconnect the power cord and wait approximately 30 seconds for the power to drain before adding or removing memory modules. Regardless of the power-on state, voltage is always supplied to the memory modules as long as the computer is plugged into an active AC outlet. Adding or removing memory modules while voltage is present may cause irreparable damage to the memory modules or system board.

- 
5. If the computer is on a stand, remove the computer from the stand.
  6. Remove the computer access panel.

---

 **WARNING!** To reduce risk of personal injury from hot surfaces, allow the internal system components to cool before you touch them.

---

7. Open both latches of the memory module socket (1), and insert the memory module into the socket (2). Press the module down into the socket, ensuring that the module is fully inserted and properly seated. Make sure the latches are in the closed position (3).

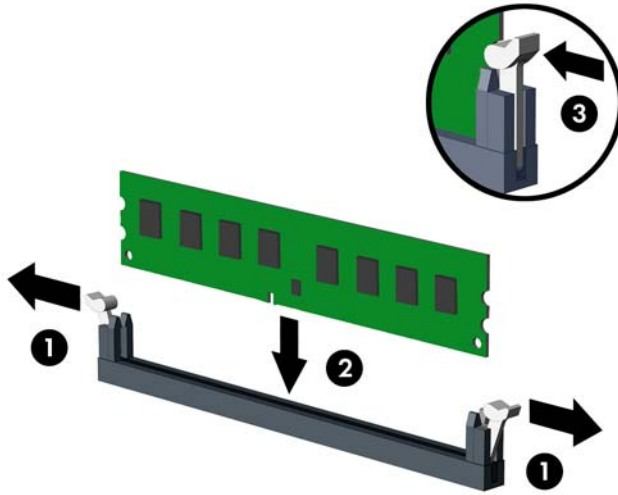

---

 **NOTE:** A memory module can be installed in only one way. Match the notch on the module with the tab on the memory socket.

Populate the black DIMM sockets before the white DIMM sockets.

For maximum performance, populate the sockets so that the memory capacity is spread as equally as possible between Channel A and Channel B.

---

8. Repeat step 7 to install any additional modules.
9. Replace the computer access panel.
10. If the computer was on a stand, replace the stand.
11. Reconnect the power cord and any external devices, and then turn on the computer. The computer should automatically recognize the additional memory.
12. Lock any security devices that were disengaged when the access panel was removed.

## Removing or installing an expansion card

The computer has two PCI Express x1 expansion sockets, one PCI Express x16 expansion socket, and one PCI Express x16 expansion socket that is downshifted to a x4 socket.

 **NOTE:** The PCI Express sockets support only low profile cards.

You can install a PCI Express x1, x4, x8, or x16 expansion card in the PCI Express x16 socket.

For dual graphics card configurations, the first (primary) card must be installed in the PCI Express x16 socket that is NOT downshifted to a x4.

To remove, replace, or add an expansion card:

1. Remove/disengage any security devices that prohibit opening the computer.
2. Remove all removable media, such as compact discs or USB flash drives, from the computer.
3. Turn off the computer properly through the operating system, and turn off any external devices.
4. Disconnect the power cord from the AC outlet and disconnect any external devices.

 **IMPORTANT:** Regardless of the power-on state, voltage is always present on the system board as long as the system is plugged into an active AC outlet. To prevent damage to internal components, you must disconnect the power cord from the power source before opening the computer.

5. If the computer is on a stand, remove the computer from the stand.
6. Remove the computer access panel.
7. Locate the correct vacant expansion socket on the system board and the corresponding expansion slot on the back of the computer chassis.
8. Release the slot cover retention latch that secures the slot covers by lifting the tab on the latch and rotating the latch to the open position.

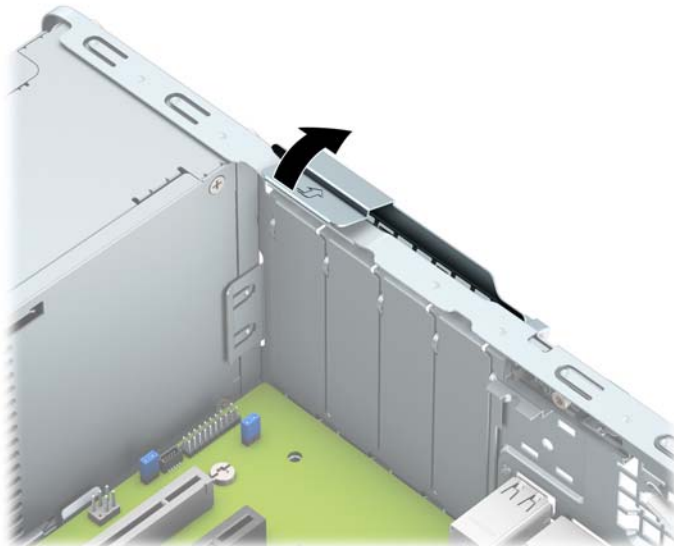

9. Before installing an expansion card, remove the expansion slot cover or the existing expansion card.

 **NOTE:** Before removing an installed expansion card, disconnect any cables that may be attached to the expansion card.

- a.** If you are installing an expansion card in a vacant socket, remove the appropriate expansion slot cover on the back of the chassis. Pull the slot cover straight up then away from the inside of the chassis.

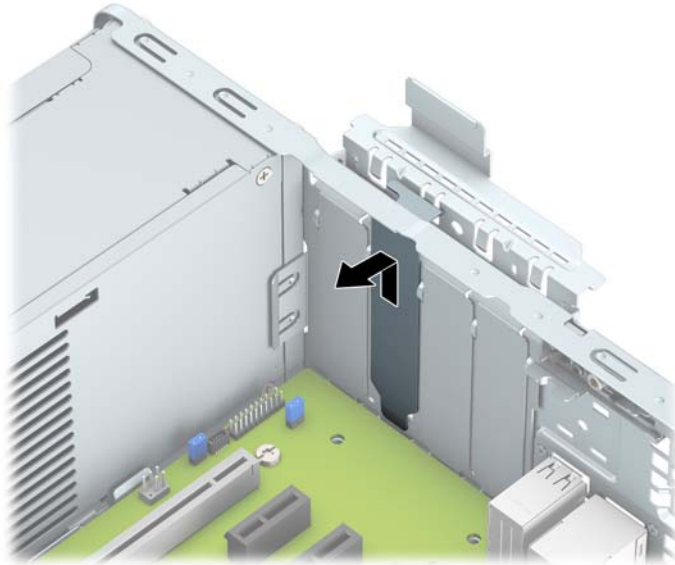

- b.** If you are removing a PCI Express x1 card, hold the card at each end and carefully rock it back and forth until the connectors pull free from the socket. Lift the card straight up (1) then away from the inside of the chassis (2) to remove it. Be sure not to scrape the card against other components.

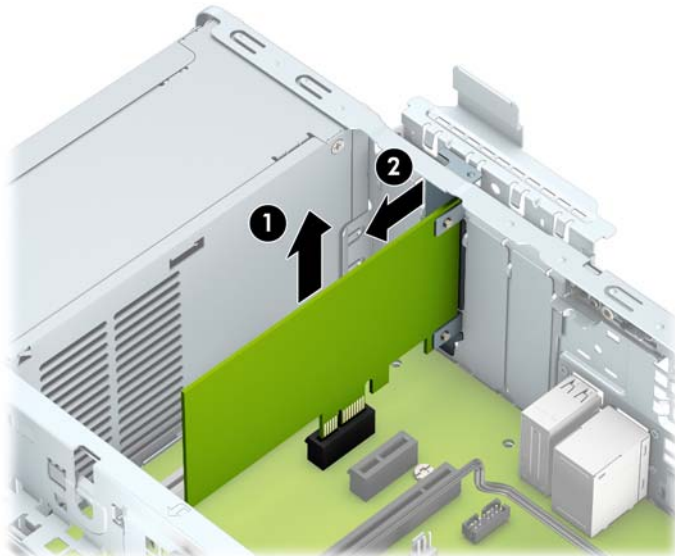



- c. If you are removing a PCI Express x16 card, pull the retention arm on the back of the expansion socket away from the card (1) and carefully rock the card back and forth until the connectors pull free from the socket. Lift the card straight up (2) then away from the inside of the chassis (3) to remove it. Be sure not to scrape the card against other components.

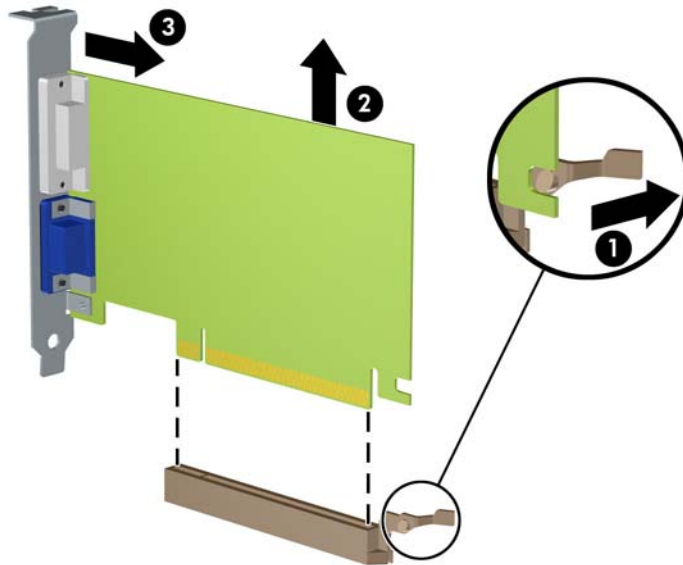



10. Store the removed card in anti-static packaging.

11. If you are not installing a new expansion card, install an expansion slot cover to close the open slot.

 **IMPORTANT:** After removing an expansion card, you must replace it with a new card or expansion slot cover for proper cooling of internal components during operation.

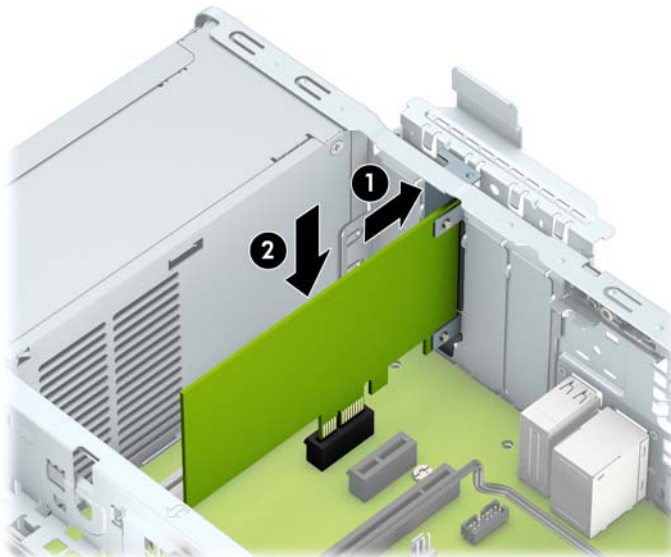
12. To install a new expansion card, hold the card just above the expansion socket on the system board then move the card toward the rear of the chassis (1) so that the bottom of the bracket on the card slides into the small slot on the chassis. Press the card straight down into the expansion socket on the system board (2).



 **NOTE:** When installing an expansion card, press firmly on the card so that the whole connector is seated properly in the expansion card socket.

13. Rotate the slot cover retention latch back in place to secure the expansion card.

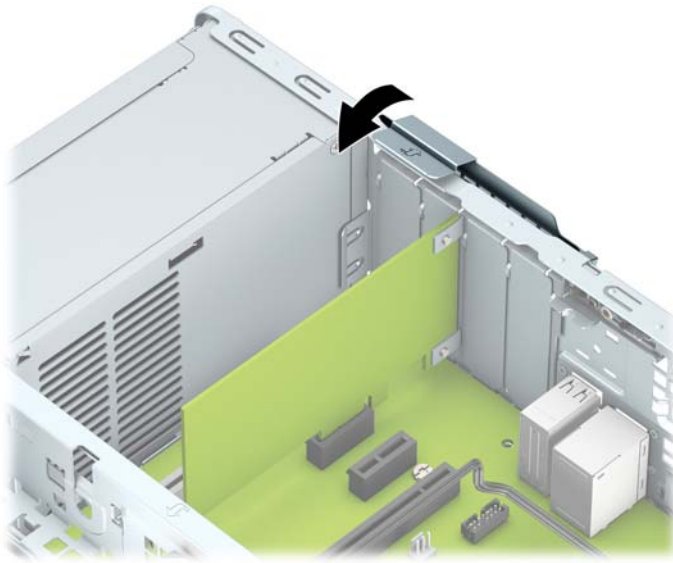

14. Connect external cables to the installed card, if needed. Connect internal cables to the system board, if needed.
15. Replace the computer access panel.
16. If the computer was on a stand, replace the stand.
17. Reconnect the power cord and any external devices, and then turn on the computer.
18. Lock any security devices that were disengaged when the access panel was removed.
19. Reconfigure the computer, if necessary.

## Drive positions

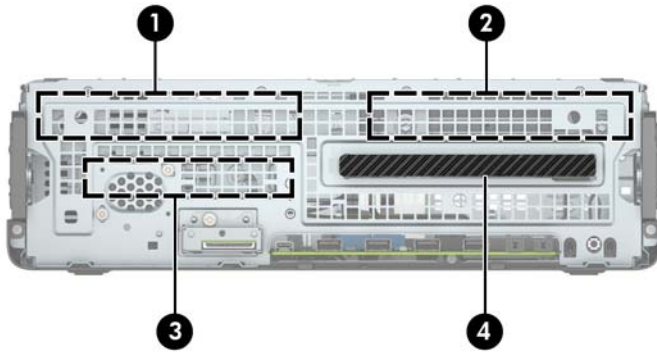

---

### Drive positions

---

1	3.5-inch secondary hard drive bay
2	3.5-inch primary hard drive bay
3	2.5-inch hard drive bay
4	9.5 mm slim optical drive bay

---

**NOTE:** The drive configuration on your computer may be different than the drive configuration shown above.

---

## Removing and installing drives

When installing drives, follow these guidelines:

- The primary Serial ATA (SATA) hard drive must be connected to the dark blue primary SATA connector on the system board labeled SATA0.
- Connect secondary hard drives and optical drives to one of the light blue SATA connectors on the system board (labeled SATA1, and SATA3).



**IMPORTANT:** To prevent loss of work and damage to the computer or drive:

If you are inserting or removing a drive, shut down the operating system properly, turn off the computer, and unplug the power cord. Do not remove a drive while the computer is on or in standby mode.

Before handling a drive, be sure that you are discharged of static electricity. While handling a drive, avoid touching the connector. For more information about preventing electrostatic damage, refer to [Electrostatic discharge on page 49](#).

Handle a drive carefully; do not drop it.

Do not use excessive force when inserting a drive.

Avoid exposing a hard drive to liquids, temperature extremes, or products that have magnetic fields such as monitors or speakers.

If a drive must be mailed, place the drive in a bubble-pack mailer or other protective packaging and label the package “Fragile: Handle With Care.”

---

## Removing a 9.5 mm slim optical drive

1. Remove/disengage any security devices that prohibit opening the computer.
2. Remove all removable media, such as compact discs or USB flash drives, from the computer.
3. Turn off the computer properly through the operating system, and turn off any external devices.
4. Disconnect the power cord from the AC outlet and disconnect any external devices.

 **IMPORTANT:** Regardless of the power-on state, voltage is always present on the system board as long as the system is plugged into an active AC outlet. To prevent damage to internal components, you must disconnect the power cord from the power source before opening the computer.

5. If the computer is on a stand, remove the computer from the stand.
6. Remove the computer access panel.
7. Disconnect the power cable (1) and data cable (2) from the rear of the optical drive.

 **IMPORTANT:** When removing the cables, pull the tab or connector instead of the cable itself to avoid damaging the cable.

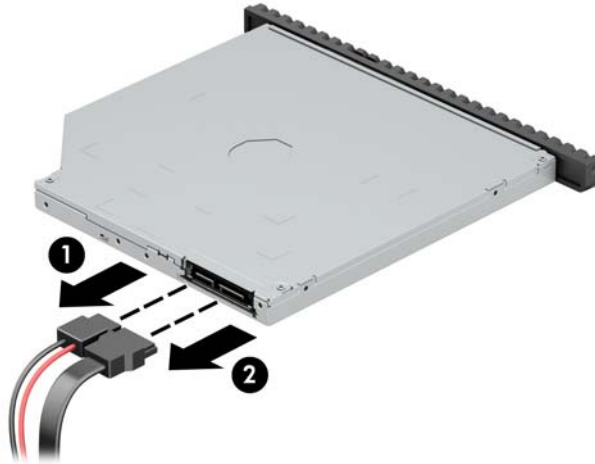

8. Push the green release latch on the right rear side of the drive toward the center of the drive (1), and then slide the drive forward and out of the bay (2).

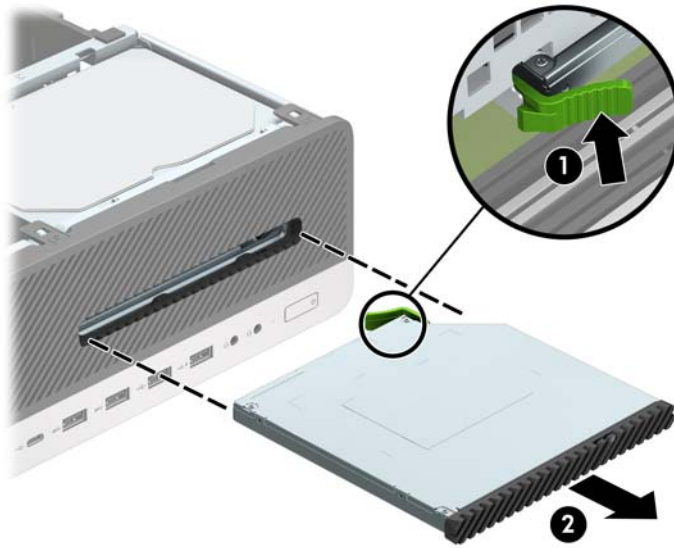

## Installing a 9.5 mm slim optical drive

1. Remove/disengage any security devices that prohibit opening the computer.
2. Remove all removable media, such as compact discs or USB flash drives, from the computer.
3. Turn off the computer properly through the operating system, and turn off any external devices.
4. Disconnect the power cord from the AC outlet and disconnect any external devices.

 **IMPORTANT:** Regardless of the power-on state, voltage is always present on the system board as long as the system is plugged into an active AC outlet. To prevent damage to internal components, you must disconnect the power cord from the power source before opening the computer.

5. If the computer is on a stand, remove the computer from the stand.
6. Remove the computer access panel.
7. If you are installing a slim optical drive in a bay covered by a bezel blank, remove the front bezel and then remove the bezel blank. See [Removing a slim optical drive bezel blank on page 9](#) for more information.
8. Align the small pin on the release latch with the small hole on the side of the drive and press the latch firmly onto the drive.



- Slide the optical drive through the front bezel all the way into the bay (1) so that the latch on the rear of the drive locks into place (2).

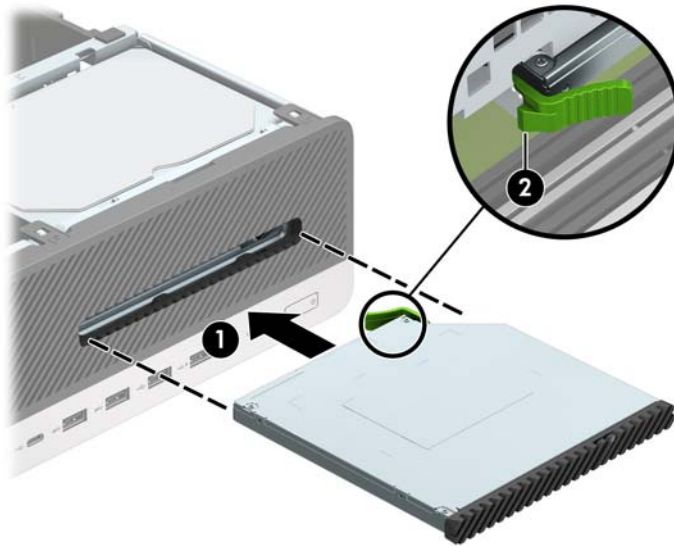

- Connect the power cable (1) and data cable (2) to the rear of the drive.



- Connect the opposite end of the data cable to one of the light blue SATA connectors on the system board labeled SATA1 or SATA3.



**NOTE:** Refer to [System board connections on page 13](#) for an illustration of the system board drive connectors.

- Replace the front bezel if it was removed.
- Replace the computer access panel.
- If the computer was on a stand, replace the stand.
- Reconnect the power cord and any external devices, and then turn on the computer.
- Lock any security devices that were disengaged when the access panel was removed.

## Removing a 3.5-inch hard drive

 **NOTE:** Before you remove the old hard drive, be sure to back up the data from the old hard drive so that you can transfer the data to the new hard drive.

There are two 3.5-inch hard drive bays. The procedure for removing a 3.5-inch hard drive is the same for each drive bay.

1. Remove/disengage any security devices that prohibit opening the computer.
2. Remove all removable media, such as compact discs or USB flash drives, from the computer.
3. Turn off the computer properly through the operating system, and turn off any external devices.
4. Disconnect the power cord from the AC outlet and disconnect any external devices.

 **IMPORTANT:** Regardless of the power-on state, voltage is always present on the system board as long as the system is plugged into an active AC outlet. To prevent damage to internal components, you must disconnect the power cord from the power source before opening the computer.

5. If the computer is on a stand, remove the computer from the stand.
6. Remove the computer access panel.
7. Disconnect the power cable (1) and data cable (2) from the rear of the hard drive.

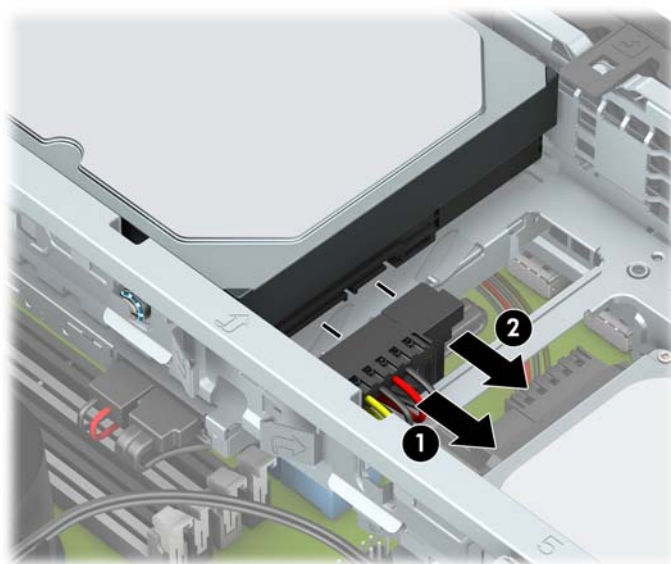



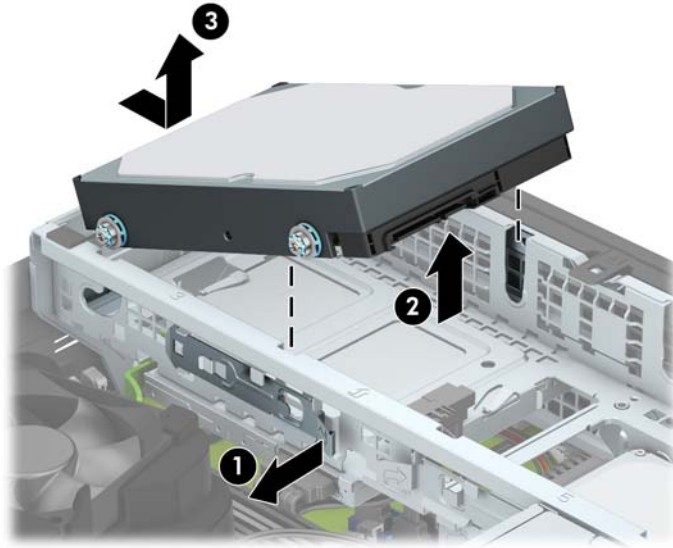

8. Pull the release lever next to the rear of the hard drive outward (1). While pulling the release lever out, lift the rear of the drive up (2), and then slide the front of the drive back and lift it out of the bay (3).

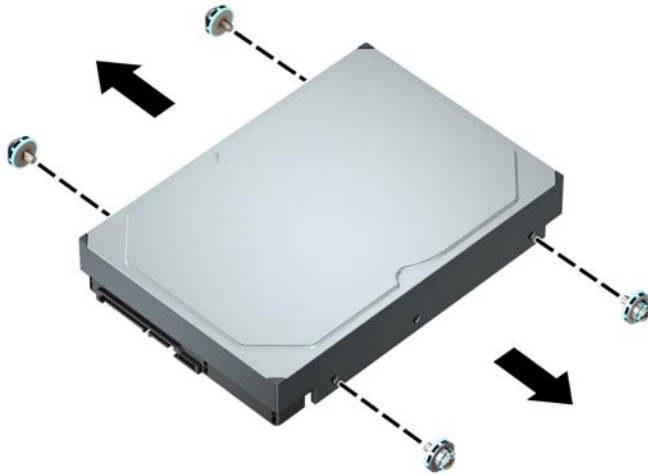

9. Remove the four mounting screws (two on each side) from the old drive. You will need these screws if you install a new drive.



## Installing a 3.5-inch hard drive

 **NOTE:** There are two 3.5-inch hard drive bays. The procedure for installing a 3.5-inch hard drive is the same for each drive bay.

1. Remove/disengage any security devices that prohibit opening the computer.
2. Remove all removable media, such as compact discs or USB flash drives, from the computer.
3. Turn off the computer properly through the operating system, and turn off any external devices.
4. Disconnect the power cord from the AC outlet and disconnect any external devices.

 **IMPORTANT:** Regardless of the power-on state, voltage is always present on the system board as long as the system is plugged into an active AC outlet. To prevent damage to internal components, you must disconnect the power cord from the power source before opening the computer.

5. If the computer is on a stand, remove the computer from the stand.
6. Remove the computer access panel.
7. Install mounting screws on the sides of the hard drive using standard 6-32 silver-and-blue mounting screws.

 **NOTE:** If replacing a 3.5-inch hard drive, transfer the mounting screws from the old hard drive to the new hard drive.

If you are adding a second 3.5-inch hard drive, you can purchase extra mounting screws from HP.

- Install four silver-and-blue 6-32 mounting screws (two on each side of the drive).

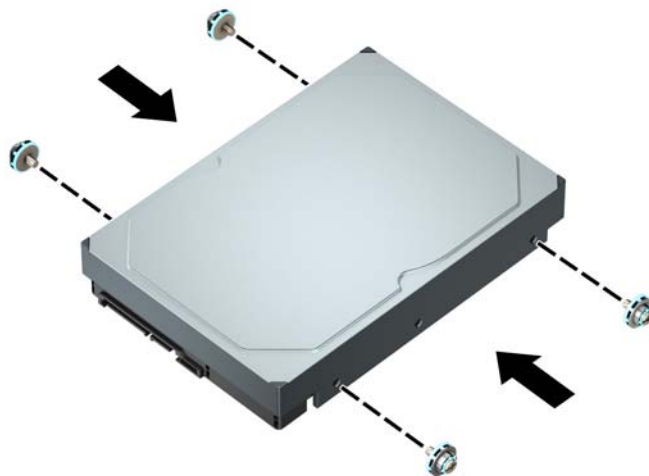

- You can also install a 2.5-inch hard drive into a 3.5-inch drive bay using an adapter bracket similar to the example shown below.
  - Slide the 2.5-inch drive into the 3.5-inch adapter bracket.

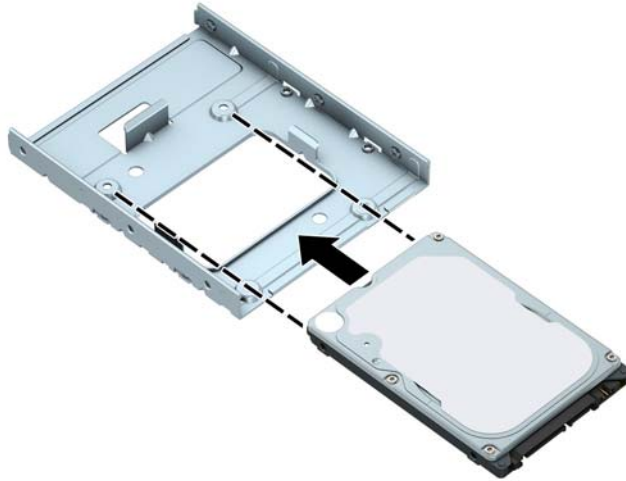

- Secure the drive to the bay adapter bracket by installing four black M3 adapter bracket screws through the underside of the bracket and into the drive.

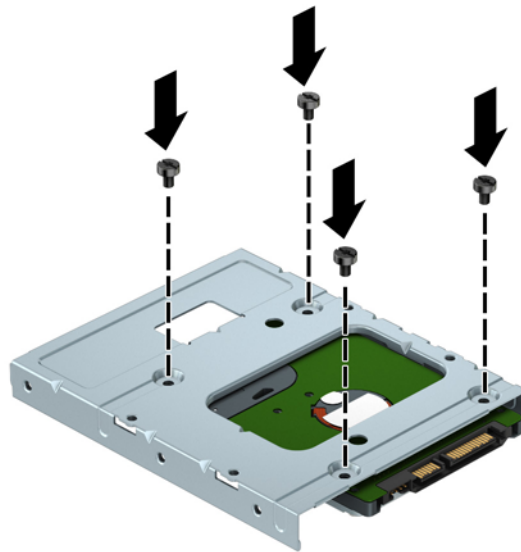

- Install four 6-32 silver-and-blue mounting screws in the adapter bracket (two on each side of the bracket).

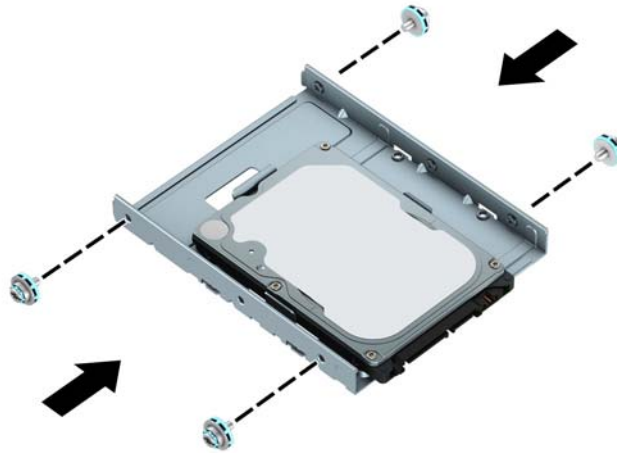

8. Align the mounting screws on the front of the hard drive with the slots on the drive cage and press the front of the drive down and forward into the bay (1). Then press the rear of the drive down into the drive bay (2) to lock it in place.

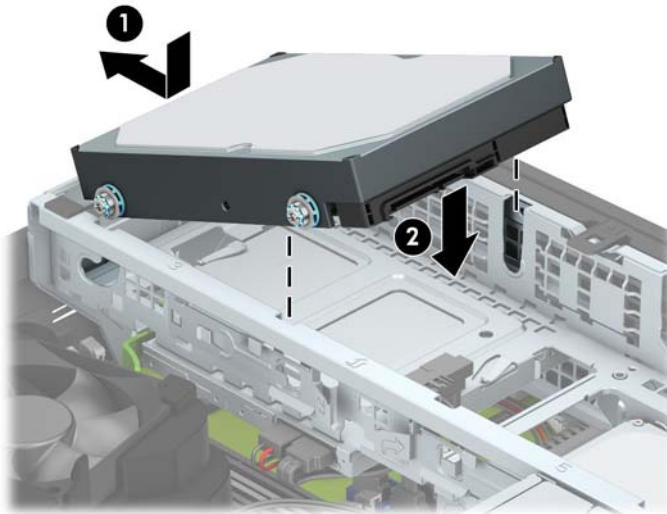

9. Connect the power cable (1) and data cable (2) to the rear of the hard drive.

 **NOTE:** If the 3.5-inch hard drive is the primary drive, connect the other end of the data cable to the dark blue SATA connector on the system board labeled SATA0. If it is a secondary hard drive, connect the other end of the data cable to one of the light blue SATA connectors on the system board.

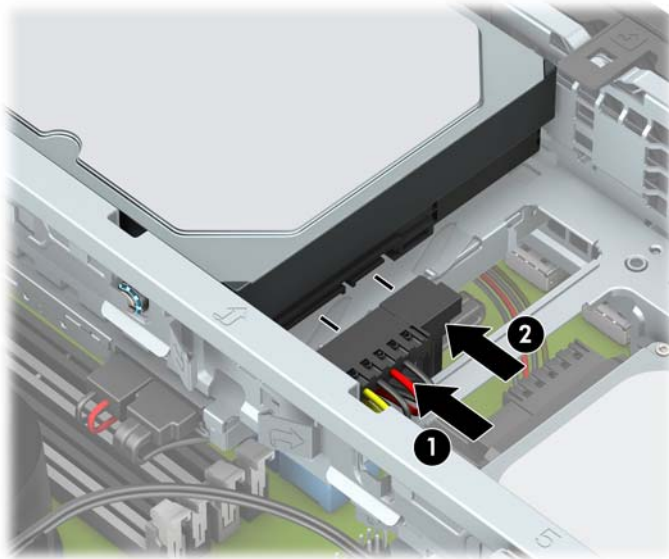

10. Replace the computer access panel.
11. If the computer was on a stand, replace the stand.
12. Reconnect the power cord and any external devices, and then turn on the computer.
13. Lock any security devices that were disengaged when the access panel was removed.

## Removing a 2.5-inch hard drive

1. Remove/disengage any security devices that prohibit opening the computer.
2. Remove all removable media, such as compact discs or USB flash drives, from the computer.
3. Turn off the computer properly through the operating system, and turn off any external devices.
4. Disconnect the power cord from the AC outlet and disconnect any external devices.

 **IMPORTANT:** Regardless of the power-on state, voltage is always present on the system board as long as the system is plugged into an active AC outlet. To prevent damage to internal components, you must disconnect the power cord from the power source before opening the computer.

5. If the computer is on a stand, remove the computer from the stand.
6. Remove the computer access panel.
7. Remove the front bezel.
8. Rotate the drive cage to its upright position.

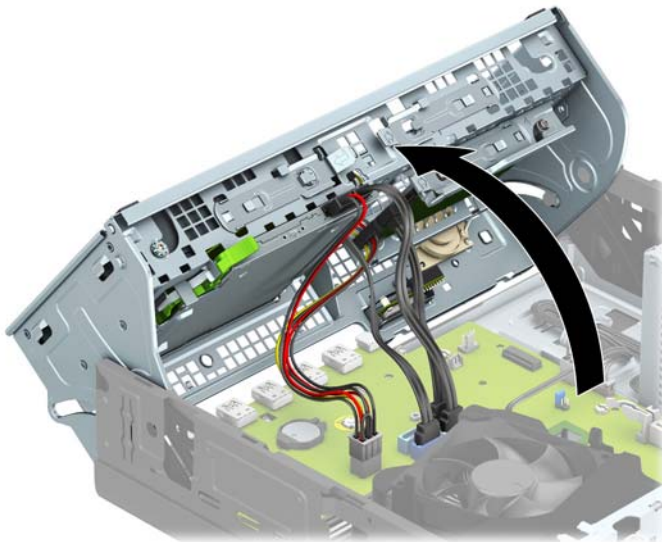

9. Disconnect the power cable (1) and data cable (2) from the rear of the hard drive.

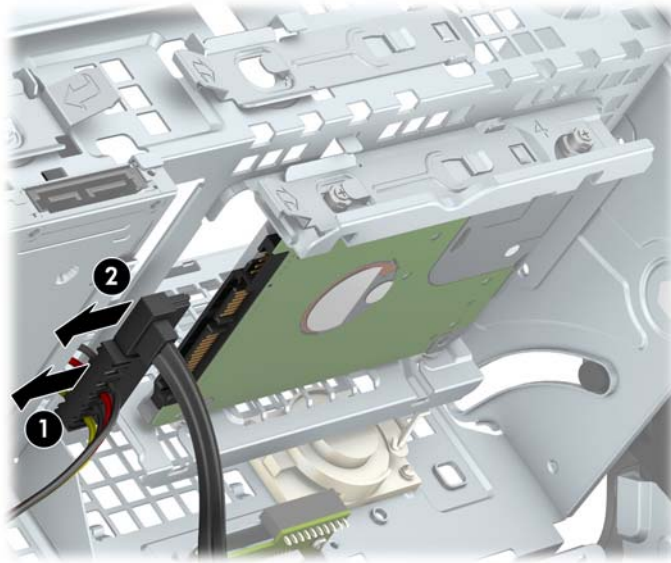

10. Pull the release lever at the rear of the drive outward (1). Then slide the drive back until it stops and pull it down and out of the drive bay (2).

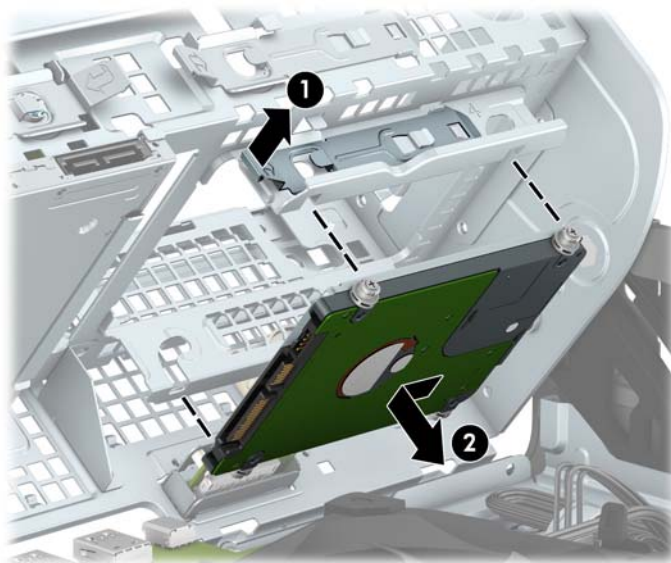

11. If you are installing a new drive, refer to [Installing a 2.5-inch hard drive on page 34](#). If you are not installing a new drive, rotate the drive cage down and replace the front bezel and access panel.

## Installing a 2.5-inch hard drive

1. Remove/disengage any security devices that prohibit opening the computer.
2. Remove all removable media, such as compact discs or USB flash drives, from the computer.
3. Turn off the computer properly through the operating system, and turn off any external devices.
4. Disconnect the power cord from the AC outlet and disconnect any external devices.

---

 **IMPORTANT:** Regardless of the power-on state, voltage is always present on the system board as long as the system is plugged into an active AC outlet. To prevent damage to internal components, you must disconnect the power cord from the power source before opening the computer.

---

5. If the computer is on a stand, remove the computer from the stand.
6. Remove the computer access panel.
7. Remove the front bezel.
8. Install four black-and-blue M3 mounting screws (two on each side of the drive).

---

 **NOTE:** M3 metric mounting screws can be purchased from HP.

When replacing a drive, transfer the four mounting screws from the old drive to the new drive.

---

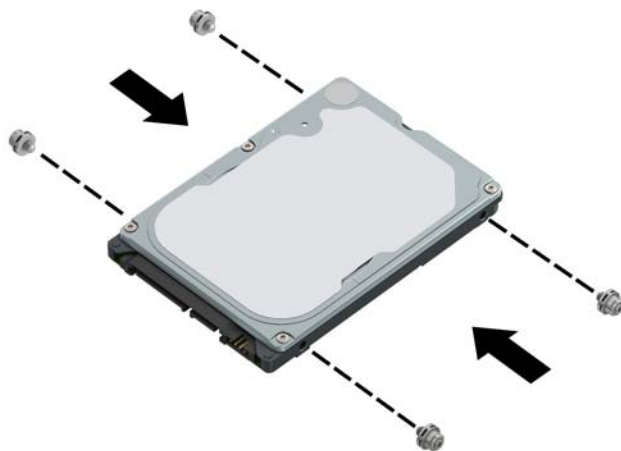



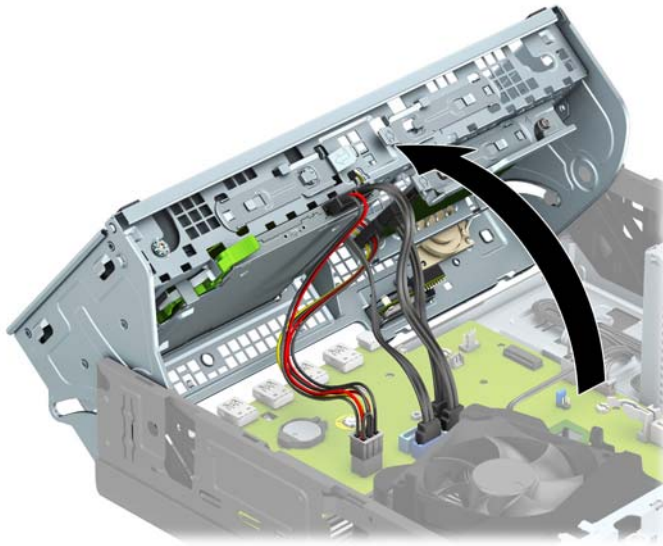

9. Rotate the drive cage to its upright position.

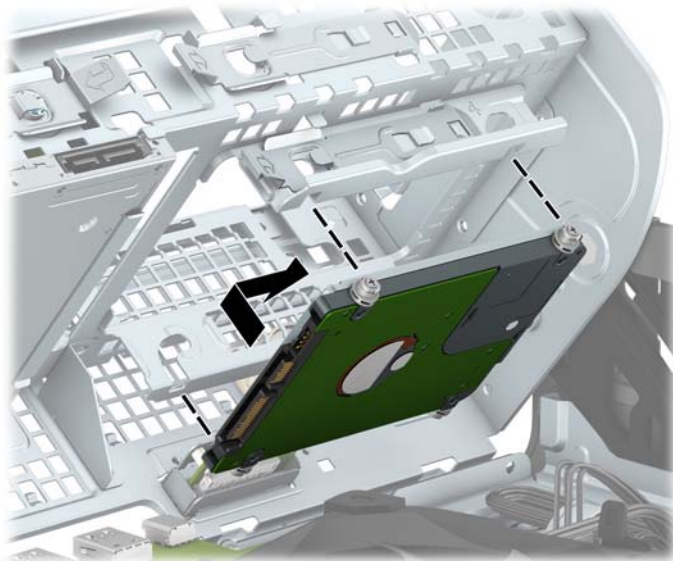

10. Align the mounting screws on the drive with the J-slots on the sides of the drive bay. Press the drive into the drive bay, and then slide the drive forward until it locks in place.



11. Connect the power cable (1) and data cable (2) to the rear of the hard drive.

 **NOTE:** If the 2.5-inch hard drive is the primary drive, connect the other end of the data cable to the dark blue SATA connector on the system board labeled SATA0. If it is a secondary hard drive, connect the other end of the data cable to one of the light blue SATA connectors on the system board.

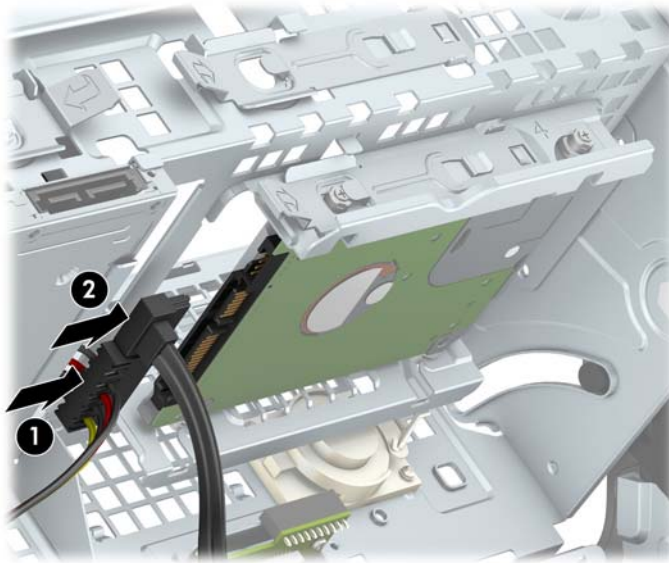

12. Rotate the drive cage back down to its normal position.

 **IMPORTANT:** Be careful not to pinch any cables or wires when rotating the drive cage down.

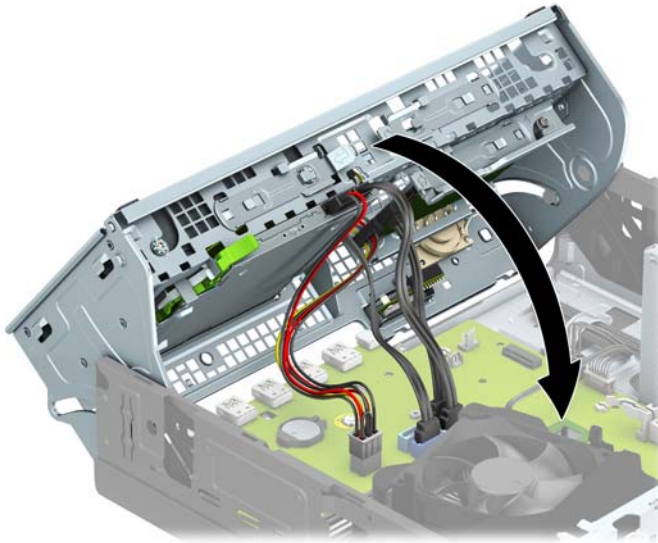

13. Replace the front bezel.
14. Replace the computer access panel.
15. If the computer was on a stand, replace the stand.
16. Reconnect the power cord and any external devices, and then turn on the computer.
17. Lock any security devices that were disengaged when the access panel was removed.

## Removing and installing an M.2 SSD storage card

 **NOTE:** The computer supports 2230 and 2280 M.2 SSD cards.

1. Remove/disengage any security devices that prohibit opening the computer.
2. Remove all removable media, such as compact discs or USB flash drives, from the computer.
3. Turn off the computer properly through the operating system, and turn off any external devices.
4. Disconnect the power cord from the AC outlet and disconnect any external devices.

 **IMPORTANT:** Regardless of the power-on state, voltage is always present on the system board as long as the system is plugged into an active AC outlet. To prevent damage to internal components, you must disconnect the power cord from the power source before opening the computer.

5. If the computer is on a stand, remove the computer from the stand.
6. Remove the computer access panel.
7. Remove the front bezel.
8. Rotate the drive cage to its upright position.

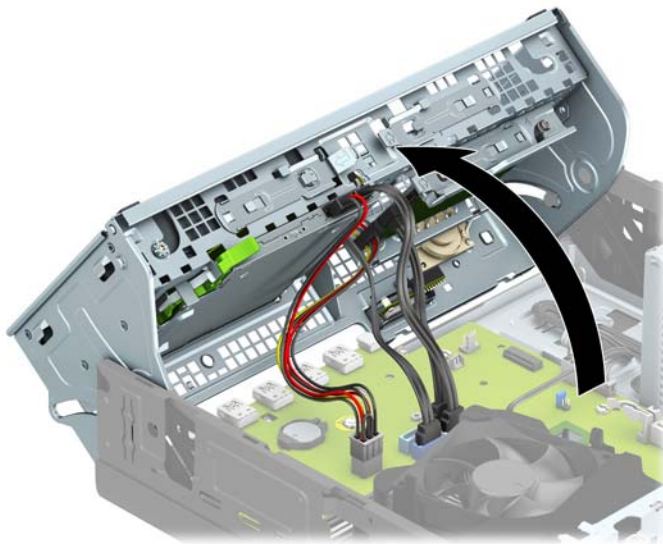

9. To remove an M.2 SSD card, remove the screw that secures the card (1), lift the end of the card up (2), and then slide the card out of the system board connector (3).

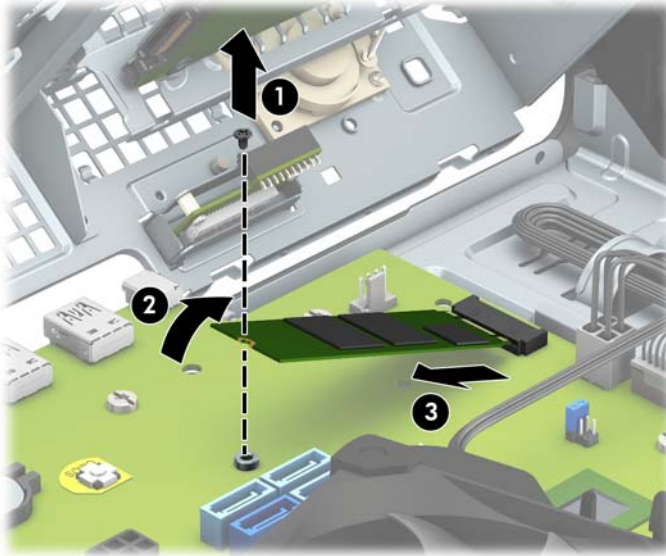

10. To install an M.2 SSD card, slide the pins on the card into the system board connector while holding the card at approximately a 30° angle (1). Press the other end of the card down (2), and then secure the card with the screw (3).

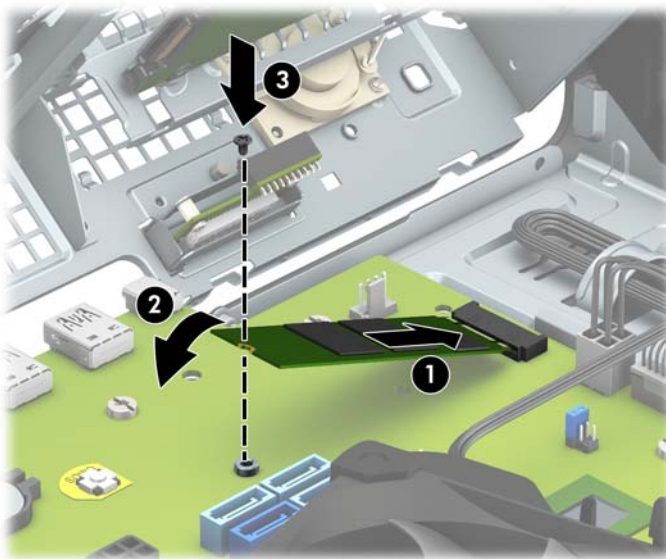

11. Rotate the drive cage back down to its normal position.



**IMPORTANT:** Be careful not to pinch any cables or wires when rotating the drive cage down.

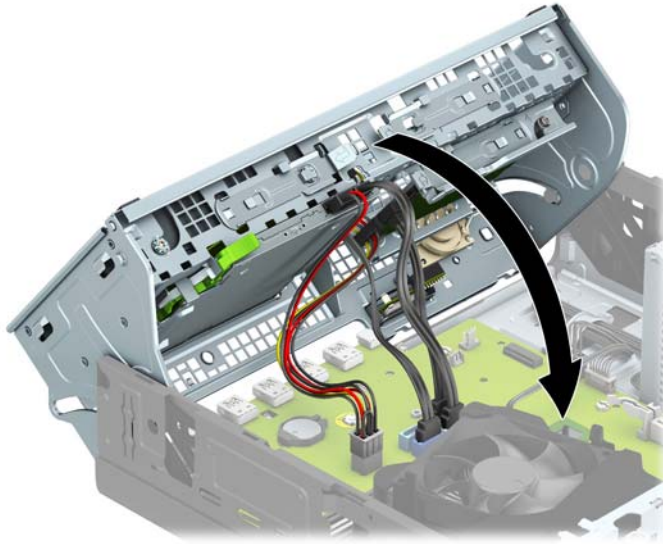

12. Replace the front bezel.
13. Replace the computer access panel.
14. If the computer was on a stand, replace the stand.
15. Reconnect the power cord and any external devices, and then turn on the computer.
16. Lock any security devices that were disengaged when the access panel was removed.



## Installing a security lock

The security locks displayed below and on the following pages can be used to secure the computer.

### Cable lock



### Padlock



## HP Business PC Security Lock V2

The HP PC Security Lock V2 is designed to secure all of the devices at your workstation.

1. Attach the security cable fastener to a desktop using the appropriate screws for your environment (screws not provided) (1), and then snap the cover onto the base of the cable fastener (2).

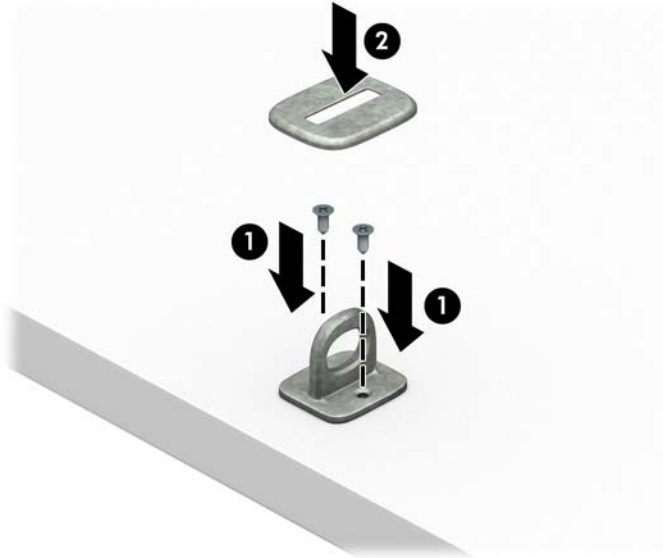

2. Loop the security cable around a stationary object.



3. Slide the security cable through the security cable fastener.

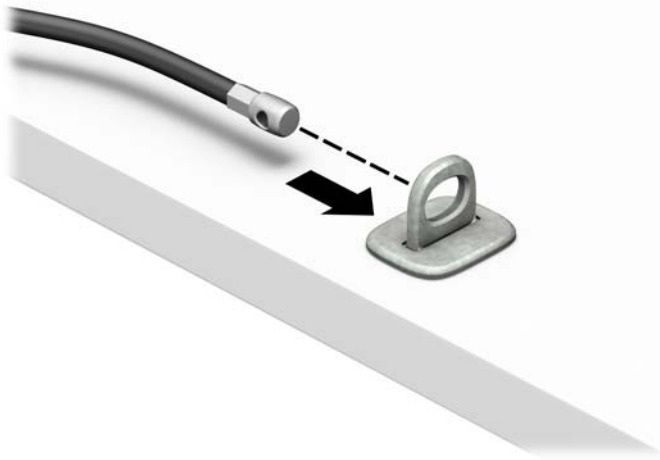

4. Pull the two scissor hands of the monitor lock apart and insert the lock into the security slot on the rear of the monitor (1), close the scissor hands together to secure the lock in place (2), and then slide the cable guide through the center of the monitor lock (3).

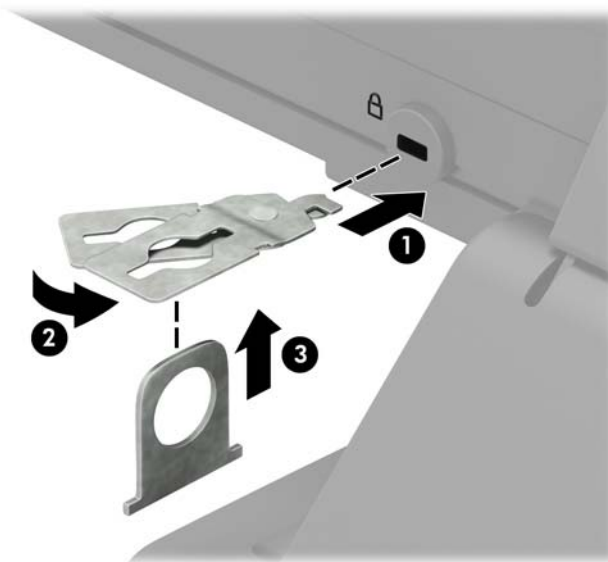



5. Slide the security cable through the security guide installed on the monitor.

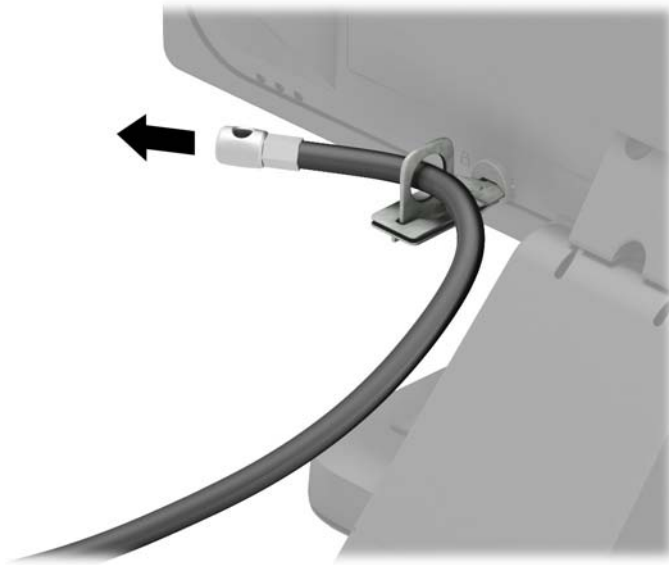

6. Attach the accessory cable fastener to a desktop using the appropriate screw for your environment (screw not provided) (1), and then place the accessory cables into the base of the fastener (2).

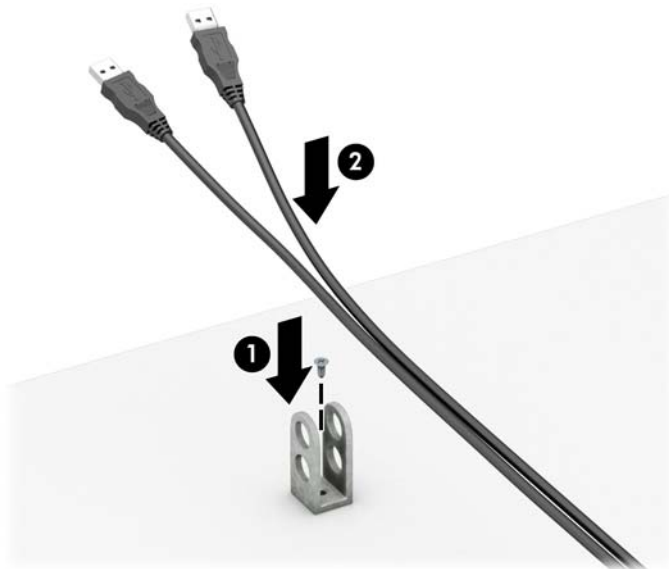

7. Slide the security cable through the holes in the accessory cable fastener.

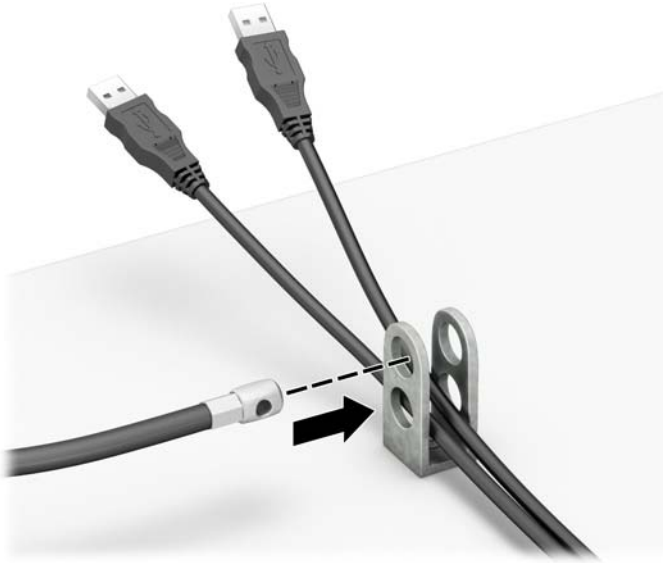

8. Screw the lock to the chassis using the screw provided.

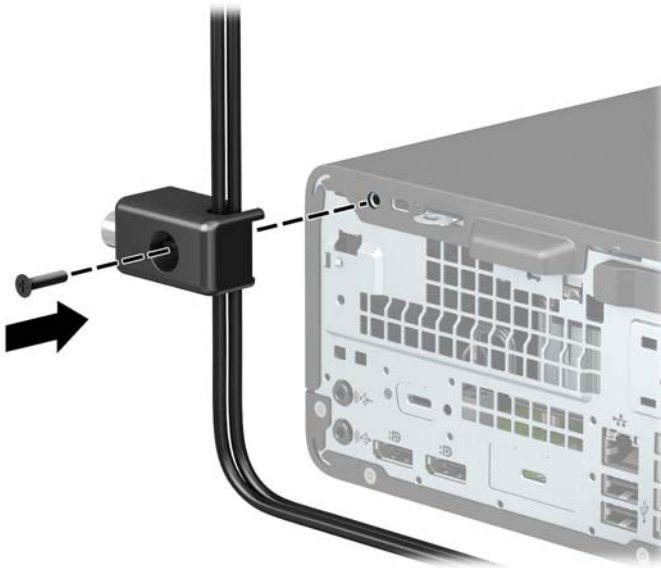

9. Insert the plug end of the security cable into the lock (1) and push the button in (2) to engage the lock. Use the key provided to disengage the lock.

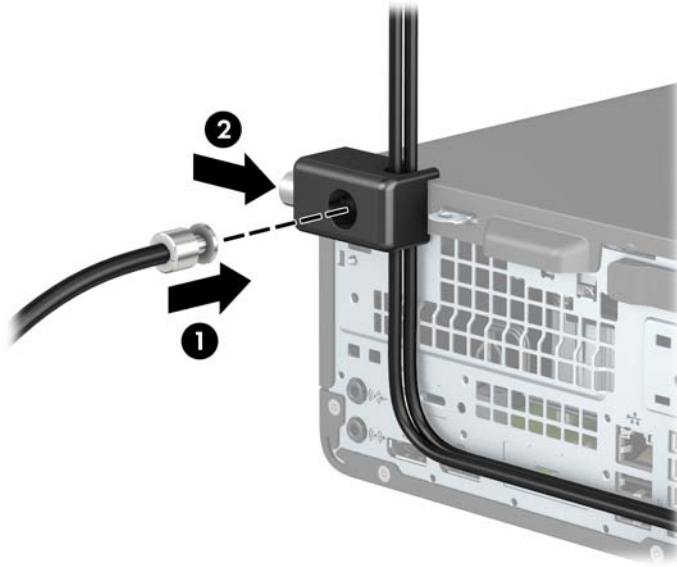

10. When you have completed all steps, all of the devices at your workstation will be secured.

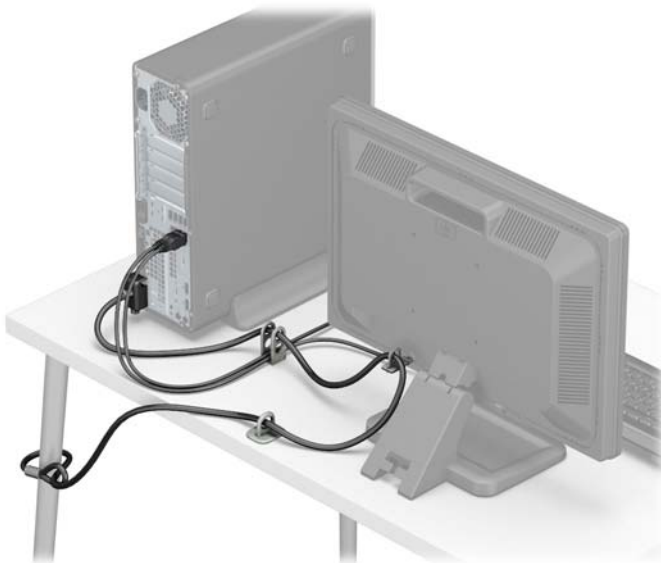

---

# A Battery replacement

The battery that comes with the computer provides power to the real-time clock. When replacing the battery, use a battery equivalent to the battery originally installed in the computer. The computer comes with a 3-volt lithium coin cell battery.

---

 **WARNING!** The computer contains an internal lithium manganese dioxide battery. There is a risk of fire and burns if the battery is not handled properly. To reduce the risk of personal injury:

Do not attempt to recharge the battery.

Do not expose to temperatures higher than 60°C (140°F).

Do not disassemble, crush, puncture, short external contacts, or dispose of in fire or water.

Replace the battery only with the HP spare designated for this product.

 **IMPORTANT:** Before replacing the battery, it is important to back up the computer CMOS settings. When the battery is removed or replaced, the CMOS settings will be cleared.

Static electricity can damage the electronic components of the computer or optional equipment. Before beginning these procedures, ensure that you are discharged of static electricity by briefly touching a grounded metal object.

 **NOTE:** The lifetime of the lithium battery can be extended by plugging the computer into a live AC outlet. The lithium battery is only used when the computer is NOT connected to AC power.

HP encourages customers to recycle used electronic hardware, HP original print cartridges, and rechargeable batteries. For more information about recycling programs, go to <http://www.hp.com/recycle>.

1. Remove/disengage any security devices that prohibit opening the computer.
2. Remove all removable media, such as compact discs or USB flash drives, from the computer.
3. Turn off the computer properly through the operating system, and turn off any external devices.
4. Disconnect the power cord from the AC outlet and disconnect any external devices.

---

 **IMPORTANT:** Regardless of the power-on state, voltage is always present on the system board as long as the system is plugged into an active AC outlet. To prevent damage to internal components, you must disconnect the power cord from the power source before opening the computer.

5. If the computer is on a stand, remove the computer from the stand.
6. Remove the computer access panel.
7. Locate the battery and battery holder on the system board.

---

 **NOTE:** On some computer models, it may be necessary to remove an internal component to gain access to the battery.

8. Depending on the type of battery holder on the system board, complete the following instructions to replace the battery.

## Type 1

- a. Lift the battery out of its holder.

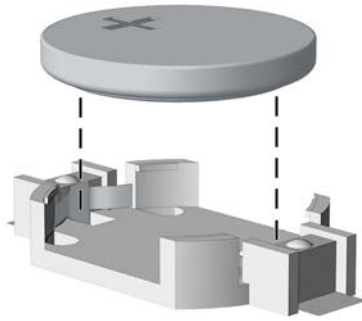

- b. Slide the replacement battery into position, positive side up. The battery holder automatically secures the battery in the proper position.

**Type 2**

- a. To release the battery from its holder, squeeze the metal clamp that extends above one edge of the battery. When the battery pops up, lift it out (1).
- b. To insert the new battery, slide one edge of the replacement battery under the holder's lip with the positive side up. Push the other edge down until the clamp snaps over the other edge of the battery (2).

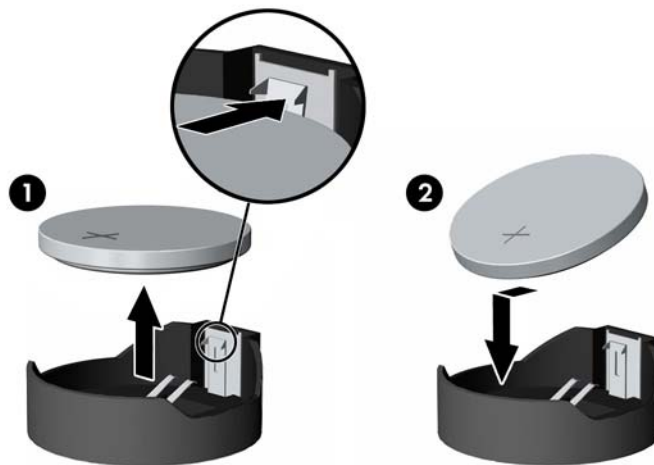

**Type 3**

- a. Pull back the clip (1) that is holding the battery in place, and remove the battery (2).

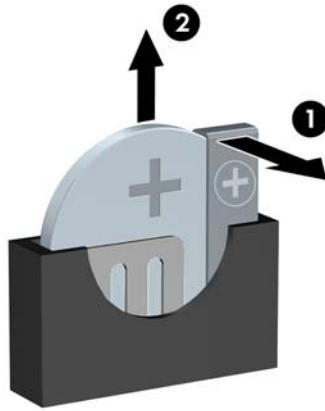

- b.** Insert the new battery and position the clip back into place.



**NOTE:** After the battery has been replaced, use the following steps to complete this procedure.

- 9.** Replace the computer access panel.
- 10.** If the computer was on a stand, replace the stand.
- 11.** Reconnect the power cord and any external devices, and then turn on the computer.
- 12.** Reset the date and time, your passwords, and any special system setups using Computer Setup.
- 13.** Lock any security devices that were disengaged when the computer access panel was removed.

---

## B Electrostatic discharge

A discharge of static electricity from a finger or other conductor may damage system boards or other static-sensitive devices. This type of damage may reduce the life expectancy of the device.

### Preventing electrostatic damage

To prevent electrostatic damage, observe the following precautions:

- Avoid hand contact by transporting and storing products in static-safe containers.
- Keep electrostatic-sensitive parts in their containers until they arrive at static-free workstations.
- Place parts on a grounded surface before removing them from their containers.
- Avoid touching pins, leads, or circuitry.
- Always be properly grounded when touching a static-sensitive component or assembly.

### Grounding methods

There are several methods for grounding. Use one or more of the following methods when handling or installing electrostatic-sensitive parts:

- Use a wrist strap connected by a ground cord to a grounded workstation or computer chassis. Wrist straps are flexible straps with a minimum of 1 megohm +/- 10 percent resistance in the ground cords. To provide proper ground, wear the strap snug against the skin.
- Use heelstraps, toestraps, or bootstraps at standing workstations. Wear the straps on both feet when standing on conductive floors or dissipating floor mats.
- Use conductive field service tools.
- Use a portable field service kit with a folding static-dissipating work mat.

If you do not have any of the suggested equipment for proper grounding, contact an HP authorized dealer, reseller, or service provider.



**NOTE:** For more information on static electricity, contact an HP authorized dealer, reseller, or service provider.

---

---

# C Computer operating guidelines, routine care and shipping preparation

## Computer operating guidelines and routine care

Follow these guidelines to properly set up and care for the computer and monitor:

- Keep the computer away from excessive moisture, direct sunlight, and extremes of heat and cold.
- Operate the computer on a sturdy, level surface. Leave a 10.2-cm (4-inch) clearance on all vented sides of the computer and above the monitor to permit the required airflow.
- Never restrict the airflow into the computer by blocking any vents or air intakes. Do not place the keyboard, with the keyboard feet down, directly against the front of the desktop unit as this also restricts airflow.
- Never operate the computer with the access panel or any of the expansion card slot covers removed.
- Do not stack computers on top of each other or place computers so near each other that they are subject to each other's re-circulated or preheated air.
- If the computer is to be operated within a separate enclosure, intake and exhaust ventilation must be provided on the enclosure, and the same operating guidelines listed above will still apply.
- Keep liquids away from the computer and keyboard.
- Never cover the ventilation slots on the monitor with any type of material.
- Install or enable power management functions of the operating system or other software, including sleep states.
- Turn off the computer before you do either of the following:
  - Wipe the exterior of the computer with a soft, damp cloth as needed. Using cleaning products may discolor or damage the finish.
  - Occasionally clean the air vents on all vented sides of the computer. Lint, dust, and other foreign matter can block the vents and limit the airflow.



# Optical drive precautions

Be sure to observe the following guidelines while operating or cleaning the optical drive.

## Operation

- Do not move the drive during operation. This may cause it to malfunction during reading.
- Avoid exposing the drive to sudden changes in temperature, as condensation may form inside the unit. If the temperature suddenly changes while the drive is on, wait at least one hour before you turn off the power. If you operate the unit immediately, it may malfunction while reading.
- Avoid placing the drive in a location that is subject to high humidity, extreme temperatures, mechanical vibration, or direct sunlight.

## Cleaning

- Clean the panel and controls with a soft, dry cloth or a soft cloth lightly moistened with a mild detergent solution. Never spray cleaning fluids directly on the unit.
- Avoid using any type of solvent, such as alcohol or benzene, which may damage the finish.

## Safety

If any object or liquid falls into the drive, immediately unplug the computer and have it checked by an authorized HP service provider.

## Shipping preparation

Follow these suggestions when preparing to ship the computer:

1. Back up the hard drive files to an external storage device. Be sure that the backup media is not exposed to electrical or magnetic impulses while stored or in transit.



---

**NOTE:** The hard drive locks automatically when the system power is turned off.

---

2. Remove and store all removable media.
3. Turn off the computer and external devices.
4. Disconnect the power cord from the AC outlet, then from the computer.
5. Disconnect the system components and external devices from their power sources, then from the computer.



---

**NOTE:** Be sure that all boards are seated properly and secured in the board slots before shipping the computer.

---

6. Pack the system components and external devices in their original packing boxes or similar packaging with sufficient packing material to protect them.

---

## D Accessibility

HP designs, produces, and markets products and services that can be used by everyone, including people with disabilities, either on a stand-alone basis or with appropriate assistive devices.

### Supported assistive technologies

HP products support a wide variety of operating system assistive technologies and can be configured to work with additional assistive technologies. Use the Search feature on your device to locate more information about assistive features.



**NOTE:** For additional information about a particular assistive technology product, contact customer support for that product.

---

### Contacting support

We are constantly refining the accessibility of our products and services and welcome feedback from users. If you have an issue with a product or would like to tell us about accessibility features that have helped you, please contact us at (888) 259-5707, Monday through Friday, 6 a.m. to 9 p.m. Mountain Time. If you are deaf or hard-of-hearing and use TRS/VRS/WebCapTel, contact us if you require technical support or have accessibility questions by calling (877) 656-7058, Monday through Friday, 6 a.m. to 9 p.m. North American Mountain Time.



**NOTE:** Support is in English only.

---

---

# Index

## A

- access panel
  - removal 6
  - replacement 7
- accessibility 52

## B

- battery replacement 46

## C

- computer operating guidelines 50

## D

- drives
  - cable connections 21
  - installation 21
  - locations 21
- dust filter 10

## E

- electrostatic discharge, preventing damage 49
- expansion card
  - installation 17
  - removal 17

## F

- front bezel
  - blank removal 9
  - removal 8
  - replacement 9
- front panel components 2

## H

- hard drive (2.5-inch)
  - installation 34
  - removal 32
- hard drive (3.5-inch)
  - installation 28
  - removal 26

## I

- installation guidelines 5
- installing
  - 2.5-inch hard drive 34

- 3.5-inch hard drive 28
- battery 46
- computer access panel 7
- drive cables 21
- dust filter 10
- expansion card 17
- front bezel 9
- M.2 SSD card 37
- memory 14
- slim optical drive 24

## L

- locks
  - cable lock 40
  - HP Business PC Security Lock 41
  - padlock 40

## M

- M.2 SSD card
  - installation 37
  - removal 37
- memory
  - installation 14
  - socket population 14

## O

- optical drive
  - cleaning 51
  - installation 24
  - precautions 51
  - removal 22

## P

- product ID location 4

## R

- rear panel components 3
- removing
  - 2.5-inch hard drive 32
  - 3.5-inch hard drive 26
  - battery 46
  - bezel blank 9
  - computer access panel 6
  - dust filter 10
  - expansion card 17

- front bezel 8
- M.2 SSD card 37
- slim optical drive 22

## S

- security
  - cable lock 40
  - HP Business PC Security Lock 41
  - padlock 40
- serial number location 4
- shipping preparation 51
- system board connections 13

## T

- tower conversion 12

## V

- ventilation guidelines 50