



HP ENVY 17 Laptop PC

Maintenance and Service Guide
IMPORTANT! This document is intended for
HP authorized service providers only.

© Copyright 2018 Hewlett-Packard
Development Company, L.P.

Bluetooth is a trademark owned by its proprietor
and used by Hewlett-Packard Company under
license. Intel and Core are trademarks of Intel
Corporation in the U.S. and other countries.
SD Logo is a trademark of its proprietor.

The information contained herein is subject to
change without notice. The only warranties for
HP products and services are set forth in
the express warranty statements accompanying
such products and services. Nothing herein
should be construed as constituting an
additional warranty. HP shall not be liable for
technical or editorial errors or omissions
contained herein.

First Edition: April 2018

Document Part Number: L18711-001

Product notice

This guide describes features that are common
to most models. Some features may not be
available on your computer.

Not all features are available in all editions of
Windows 10. This computer may require
upgraded and/or separately purchased
hardware, drivers and/or software to take full
advantage of Windows 10 functionality. See for
<http://www.microsoft.com> details.

Safety warning notice

 **WARNING!** To reduce the possibility of heat-related injuries or of overheating the device, do not place the device directly on your lap or obstruct the device air vents. Use the device only on a hard, flat surface. Do not allow another hard surface, such as an adjoining optional printer, or a soft surface, such as pillows or rugs or clothing, to block airflow. Also, do not allow the AC adapter to contact the skin or a soft surface, such as pillows or rugs or clothing, during operation. The device and the AC adapter comply with the user-accessible surface temperature limits defined by the International Standard for Safety of Information Technology Equipment (IEC 60950).

Table of contents

1 Product description	1
2 External component identification	3
Locating hardware	3
Locating software	3
Right side	4
Left side	5
Display	6
TouchPad	7
Lights	8
Buttons and speakers	9
Bottom	10
3 Illustrated parts catalog	11
Labels	11
Computer components	13
Miscellaneous parts	16
4 Removal and replacement preliminary requirements	18
Tools required	18
Service considerations	18
Plastic parts	18
Cables and connectors	19
Drive handling	19
Grounding guidelines	20
Electrostatic discharge damage	20
Packaging and transporting guidelines	21
Workstation guidelines	21
5 Removal and replacement procedures	23
Component replacement procedures	23
Bottom cover	24
Battery	26
Hard drive	27
Solid-state drive	29
Memory module	30

WLAN module	32
TouchPad cable	34
TouchPad	35
Fingerprint reader cable	37
Fingerprint reader	38
SD card board cable	39
SD card board	40
Optical drive	41
USB port board cable	42
USB port board	43
Fan	44
Power connector cable	45
System board	46
Heat sink	49
Speakers	51
Display assembly	52

6 Using Setup Utility (BIOS) 55

Starting Setup Utility (BIOS)	55
Updating Setup Utility (BIOS)	55
Determining the BIOS version	55
Downloading a BIOS update	56

7 Using HP PC Hardware Diagnostics 57

Downloading HP PC Hardware Diagnostics Windows	58
Downloading the latest HP PC Hardware Diagnostics Windows version	58
Downloading HP Hardware Diagnostics Windows by product name or number (products only)	58
Installing HP PC Hardware Diagnostics Windows	58
Using HP PC Hardware Diagnostics UEFI	59
Starting HP PC Hardware Diagnostics UEFI	59
Downloading HP PC Hardware Diagnostics UEFI to a USB flash drive	60
Downloading the latest HP PC Hardware Diagnostics UEFI version	60
Downloading HP PC Hardware Diagnostics UEFI by product name (products only)	60
Using Remote HP PC Hardware Diagnostics UEFI settings (products only)	61
Downloading Remote HP PC Hardware Diagnostics UEFI	61
Downloading the latest Remote HP PC Hardware Diagnostics UEFI version	61
Downloading Remote HP PC Hardware Diagnostics UEFI by product name	61
Customizing Remote HP PC Hardware Diagnostics UEFI settings	62

8 Specifications 63

9 Backing up, restoring, and recovering	64
Using Windows tools	55
Creating HP Recovery media (select products only)	64
Using HP Recovery Manager to create recovery media	65
Before you begin	65
Creating the recovery media	65
Using the HP Cloud Recovery Download Tool to create recovery media	66
Restoring and recovery	66
Restoring, resetting, and refreshing using Windows tools	66
Restoring using HP Recovery Manager and the HP Recovery partition	66
Recovering using HP Recovery Manager	67
Recovering using the HP Recovery partition (select products only)	67
Recovering using HP Recovery media	68
Changing the computer boot order	68
Removing the HP Recovery partition (select products only)	68
10 Power cord set requirements	69
Requirements for all countries	69
Requirements for specific countries and regions	69
11 Recycling	71
Index	72

1 Product description

Category	Description
Product Name	HP ENVY 17 Laptop PC (model number 17m-bw0xxx)
Processor	Intel® Core™ i7-8550U 1.80-GHz quad core processor (2400-MHz FSB, 8.0-MB L3 cache, 15.0-W) Intel Core i5-8250U 1.60-GHz quad core processor (2400-MHz FSB, 6.0-MB L3 cache, 15.0-W)
Chipset	Intel integrated soldered-on-circuit (SoC)
Graphics	Graphics controller: NVIDIA® N17S-G1 with 4096-MB GeForce MX150 (512-MB×16 4 pieces) GDDR5 Graphics Controller NVIDIA MX150 with 2048-MB video memory graphics controller Graphics card: Intel ultrahigh-definition (UHD) Graphics 620
Panel	<ul style="list-style-type: none">• 17.3-in., liquid crystal display (LCD), full high-definition (FHD), AntiGlare (1920×1080), white light-emitting diode (WLED), UWVA, 72 300, eDP, flat, 4.0t TouchScreen display assembly• 17.3-in, LCD, UHD, AntiGlare (3840×2160), WLED, UWVA 95 300, eDP 1.3+PSR, flat, non-TouchScreen display assembly• 17.3-in, LCD, FHD (1920×1080), AntiGlare, WLED, UWVA 72 300, eDP 1.2, flat, non-TouchScreen display assembly
Memory	Supports DDR4 1.2-V 2666 and 2400 memory in the following configurations: <ul style="list-style-type: none">• 16-GB (8-GB × 2)• 12-GB (8-GB + 4-GB)• 8-GB (4-GB × 2)
Storage	Support for a 1-TB, 7200-rpm, SATA 7.0-mm hard drive Support for the following solid-state drives: <ul style="list-style-type: none">• 512-GB, M.2 2280, peripheral component interconnect express (PCIe) 3×4, non-volatile memory express (NVMe) solid-state drive with triple-level cell (TLC)• 512-GB, 2280, PCIe, NVMe solid-state drive Supports the following hard drive and solid-state drive combinations: <ul style="list-style-type: none">• 1-TB, 7200-rpm, SATA 7.0-mm hard drive + 256-GB, 2280, PCIe, NVMe solid-state drive• 1-TB, 7200-rpm, SATA 7.0-mm hard drive + 128-GB, M.2 2280-SATA3 solid-state drive with TLC• 1-TB, 7200-rpm, SATA 7.0-mm hard drive + 16-GB, 2280, PCIe3×2, NVMe, 3D XP solid-state drive
Optical drive	DVD/RW Drive (9.0-mm)
Audio and video	<ul style="list-style-type: none">• Fixed (no tilt) integrated webcam, with LED
Audio and video (continued)	<ul style="list-style-type: none">• Dual array microphones• Dual Band&Olufsen speakers• Support for HP Audio Boost 2.0

Category	Description
Security	<ul style="list-style-type: none"> • Fingerprint reader • Security cable lock • Trusted platform module (TPM) 2.0 firmware • Universal 2nd Factor Authentication
Sensor	Accelerometer
Ethernet	10/100/1000 network interface card (NIC)
Wireless	<p>Integrated wireless local area network (WLAN) options by way of on-board wireless module</p> <p>Two built-in WLAN antennas</p> <p>Supports the following WLAN modules:</p> <p>Intel 9260 ac 2×2 + Bluetooth 5 M.2 2230 non-vPro PCI-e+USB world-wide</p> <p>Intel D1 7265 ac 2×2 + Bluetooth 4.2 M.2 non-vPro PCI-e+USB world-wide</p>
Ports	<ul style="list-style-type: none"> • Headphone/microphone combo jack • HP Smart AC adapter • RJ45 network • USB 3.1 Gen1 Type A (3) • USB 3.1 Gen1 Type C
Power requirements	<p>Supports a 3-cell, 52.5-WHr, Li-ion battery</p> <p>Supports the 90-W HP Smart AC adapter PFC, RA, 4.5-mm and 65-W HP Smart AC adapter non-PFC, 4.5-mm (with mount) AC adapters</p>

2 External component identification

The computer features top-rated components. This chapter provides details about these components, where they are located, and how they work.

Locating hardware

To find out what hardware is installed on the computer:

- ▲ Type `device manager` in the taskbar search box, and then select the **Device Manager** app.

For information about system hardware components and the system BIOS version number, press `fn+esc` (select products only).

A list displays all the devices installed on your computer.

Locating software

To find out what software is installed on the computer:



- ▲ Select the **Start** button.

– or –

- ▲ Right-click the **Start** button, and then select **Apps and Features**.

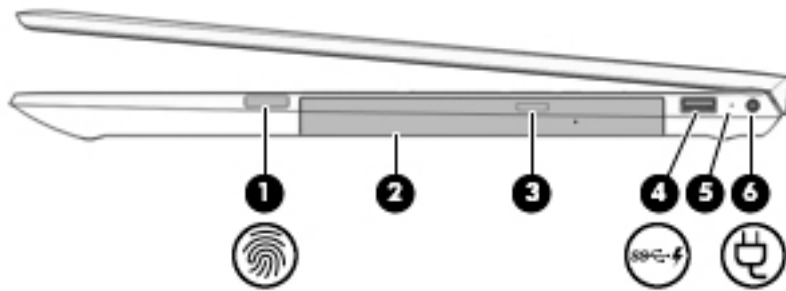





Right side

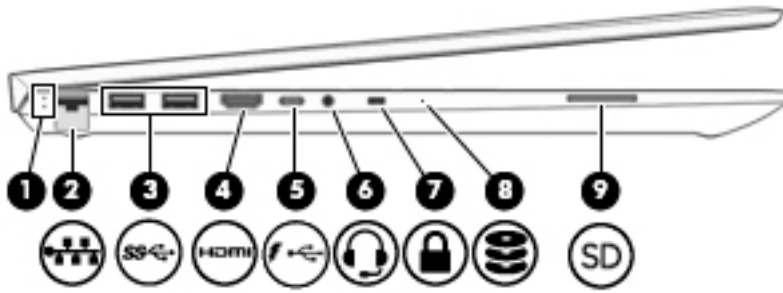

Item	Component	Description
(1)	 Fingerprint reader	Allows a fingerprint logon to Windows, instead of a password logon. ▲ To use the fingerprint reader, place your finger on the fingerprint reader for a few seconds until it reads your fingerprint.
(2)	Optical drive	Releases the optical drive disc tray.
(3)	Optical drive eject button	Depending on your computer model, reads an optical disc or reads and writes to an optical disc.
(4)	 USB SuperSpeed port with HP Sleep and Charge	Connects a USB device, provides high-speed data transfer, and even when the computer is off, charges most products such as a cell phone, camera, activity tracker, or smartwatch.
(5)	AC adapter and battery light	<ul style="list-style-type: none"> • White: The AC adapter is connected and the battery is fully charged. • Blinking white: The AC adapter is disconnected and the battery has reached a low battery level. • Amber: The AC adapter is connected and the battery is charging. • Off: The battery is not charging.
(6)	 Power connector	Connects an AC adapter.

Left side



Item	Component	Description
(1)	 RJ-45 (network) jack/status lights	Connects a network cable. <ul style="list-style-type: none"> White: The network is connected. Amber: Activity is occurring on the network.
(2)	 USB SuperSpeed port	Connects a USB device, such as a cell phone, camera, activity tracker, or smartwatch, and provides high-speed data transfer.
(3)	 HDMI port	Connects an optional video or audio device, such as a high-definition television, any compatible digital or audio component, or a high-speed HDMI device.
(4)	 USB Type-C port with HP Sleep and Charge	Connects a USB device, provides data transfer, and even when the computer is off, charges most products such as a cell phone, camera, activity tracker, or smartwatch.
(5)	 Audio-out (headphone)/Audio-in (microphone) jack	Connects optional powered stereo speakers, headphones, earbuds, a headset, or a television audio cable. Also connects an optional headset microphone. This jack does not support optional standalone microphones. <p>WARNING! To reduce the risk of personal injury, adjust the volume before putting on headphones, earbuds, or a headset. For additional safety information, refer to the <i>Regulatory, Safety, and Environmental Notices</i>.</p> <p>To access this guide:</p> <ul style="list-style-type: none"> ▲ Select the Start button, select HP Help and Support, and then select HP Documentation. <p>NOTE: When a device is connected to the jack, the computer speakers are disabled.</p>
(6)	Security cable slot	Attaches an optional security cable to the computer. <p>NOTE: The security cable is designed to act as a deterrent, but it may not prevent the computer from being mishandled or stolen.</p>
(7)	 Drive light	Blinking white: The hard drive is being accessed Amber: HP 3D DriveGuard has temporarily parked the hard drive.
(8)	 SD Memory card reader	Reads optional memory cards that enable you to store, manage, share, or access information. <p>To insert a card:</p>

Item	Component	Description
		<ol style="list-style-type: none"> 1. Hold the card label-side up, with connectors facing the computer. 2. Insert the card into the memory card reader, and then press in on the card until it is firmly seated. <p>To remove a card:</p> <ul style="list-style-type: none"> ▲ Press in on the card, and then remove it from the memory card reader.

Display

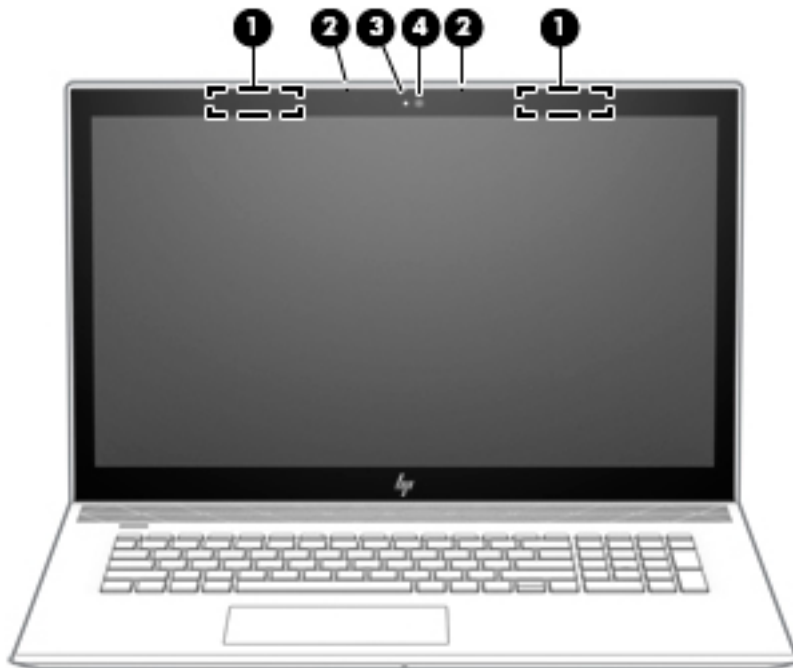

Item	Component	Description
(1)	WLAN antennas*	Send and receive wireless signals to communicate with WLANs.
(2)	Internal microphones	Record sound.
(3)	Camera light	On: The camera is in use.
(4)	Camera	Allows you to video chat, record video, and record still images. Some cameras also allow a facial recognition logon to Windows, instead of a password logon.

NOTE: Camera functions vary depending on the camera hardware and software installed on your product.

*The antennas are not visible from the outside of the computer. For optimal transmission, keep the areas immediately around the antennas free from obstructions.

For wireless regulatory notices, see the section of the *Regulatory, Safety, and Environmental Notices* that applies to your country or region.

To access this guide:

1. Type `support` in the taskbar search box, and then select the **HP Support Assistant** app.

Item	Component	Description
	– or –	
		Click the question mark icon in the taskbar.
2.	Select My PC , select the Specifications tab, and then select User Guides .	

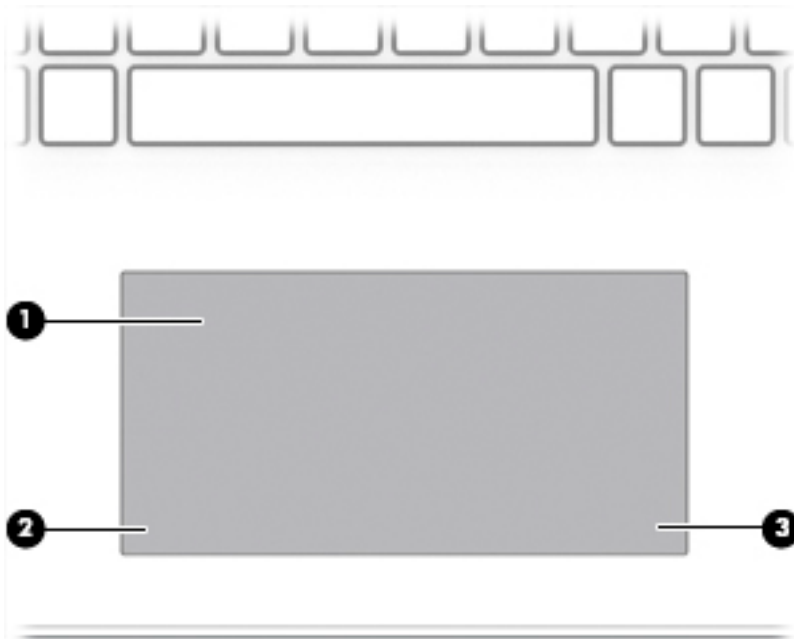

TouchPad



Item	Component	Description
(1)	TouchPad zone	Reads finger gestures to move the pointer or activate items on the screen.
(2)	Left TouchPad button	Functions like the left button on an external mouse.
(3)	Right TouchPad button	Functions like the right button on an external mouse.

Lights



Item	Component	Description
(1)	 Power light	<ul style="list-style-type: none">• On: The computer is on.• Blinking: The computer is in the Sleep state, a power-saving state. The computer shuts off power to the display and other unneeded components.• Off: The computer is off or in Hibernation. Hibernation is a power-saving state that uses the least amount of power.
(2)	Caps lock light	On: Caps lock is on, which switches the key input to all capital letters.
(3)	 Mute light	<ul style="list-style-type: none">• On: Computer sound is off.• Off: Computer sound is on.

Buttons and speakers

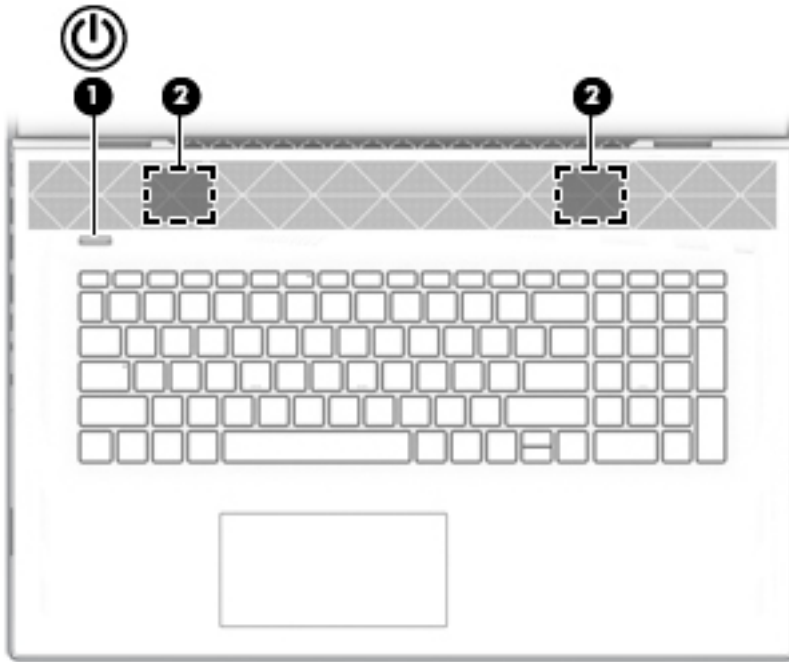

Item	Components	Description
(1)	 Power button	<ul style="list-style-type: none">• When the computer is off, press the button to turn on the computer• When the computer is on, press the button briefly to initiate Sleep.• When the computer is in the Sleep state, press the button briefly to exit Sleep.• When the computer is in Hibernation, press the button briefly to exit Hibernation. <p>CAUTION: Pressing and holding down the power button results in the loss of unsaved information.</p> <p>If the computer has stopped responding and shutdown procedures are ineffective, press and hold the power button down for at least 5 seconds to turn off the computer.</p> <p>To learn more about your power settings, see your power options:</p> <ul style="list-style-type: none">▲ Right-click the Power icon , and then select Power Options.
(2)	Speakers (2)	Produce sound.

Bottom

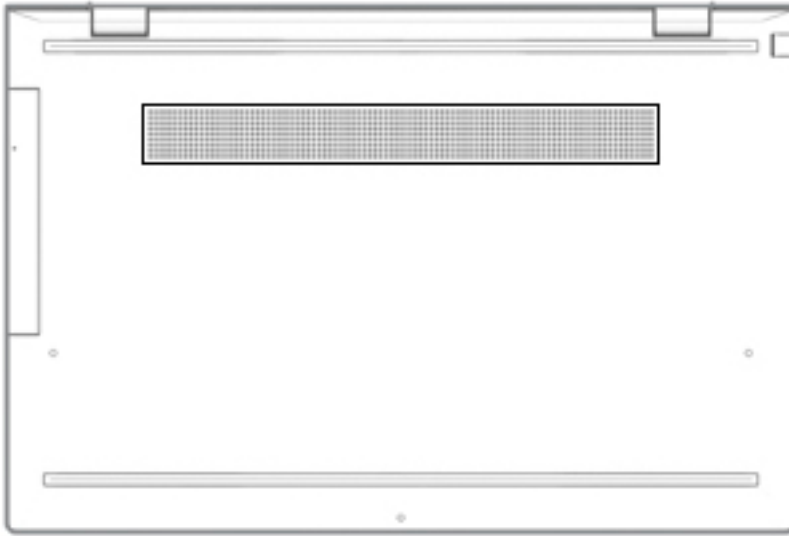

Component	Description
-----------	-------------

Vent

Enables airflow to cool internal components.

NOTE: The computer fan starts up automatically to cool internal components and prevent overheating. It is normal for the internal fan to cycle on and off during routine operation.

3 Illustrated parts catalog

NOTE: HP continually improves and changes product parts. For complete and current information on supported parts for your computer, go to <http://partsurfer.hp.com>, select your country or region, and then follow the on-screen instructions.

Labels

The labels affixed to the computer provide information that may be needed when troubleshooting system problems or travelling internationally with the computer.

IMPORTANT: Check the following locations for the labels described in this section: the bottom of the computer, inside the battery bay, under the service door, on the back of the display, or on the bottom of a tablet kickstand.

- Service label—Provides important information to identify your computer. When contacting support, you may be asked for the serial number, the product number, or the model number. Locate this information before you contact support.

Your service label will resemble one of the examples shown below. Refer to the illustration that most closely matches the service label on your computer.

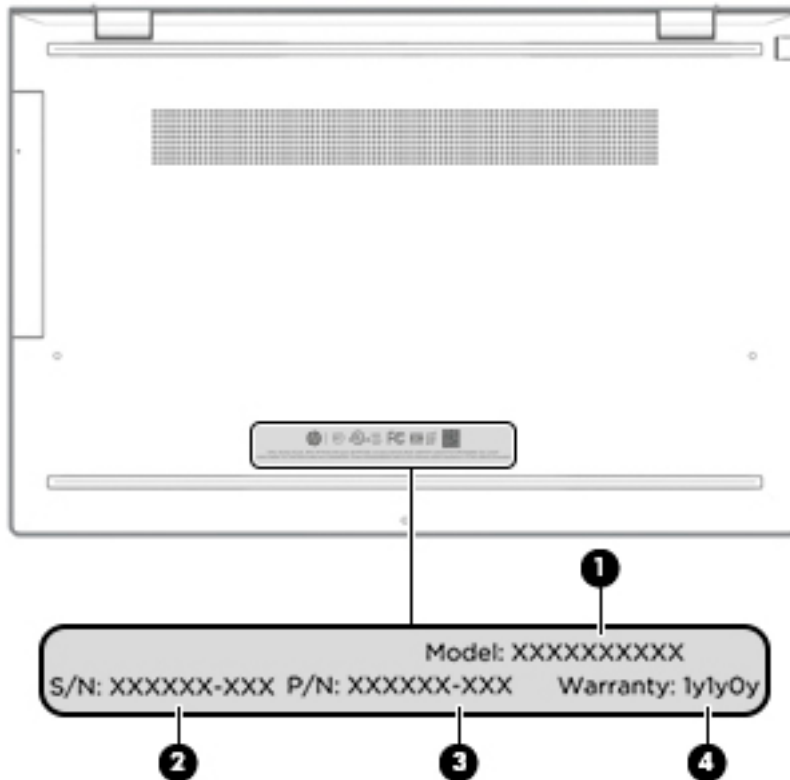

Component	
(1)	Model number
(2)	Serial number

Component

(3) Product number

(4) Warranty period

Computer components

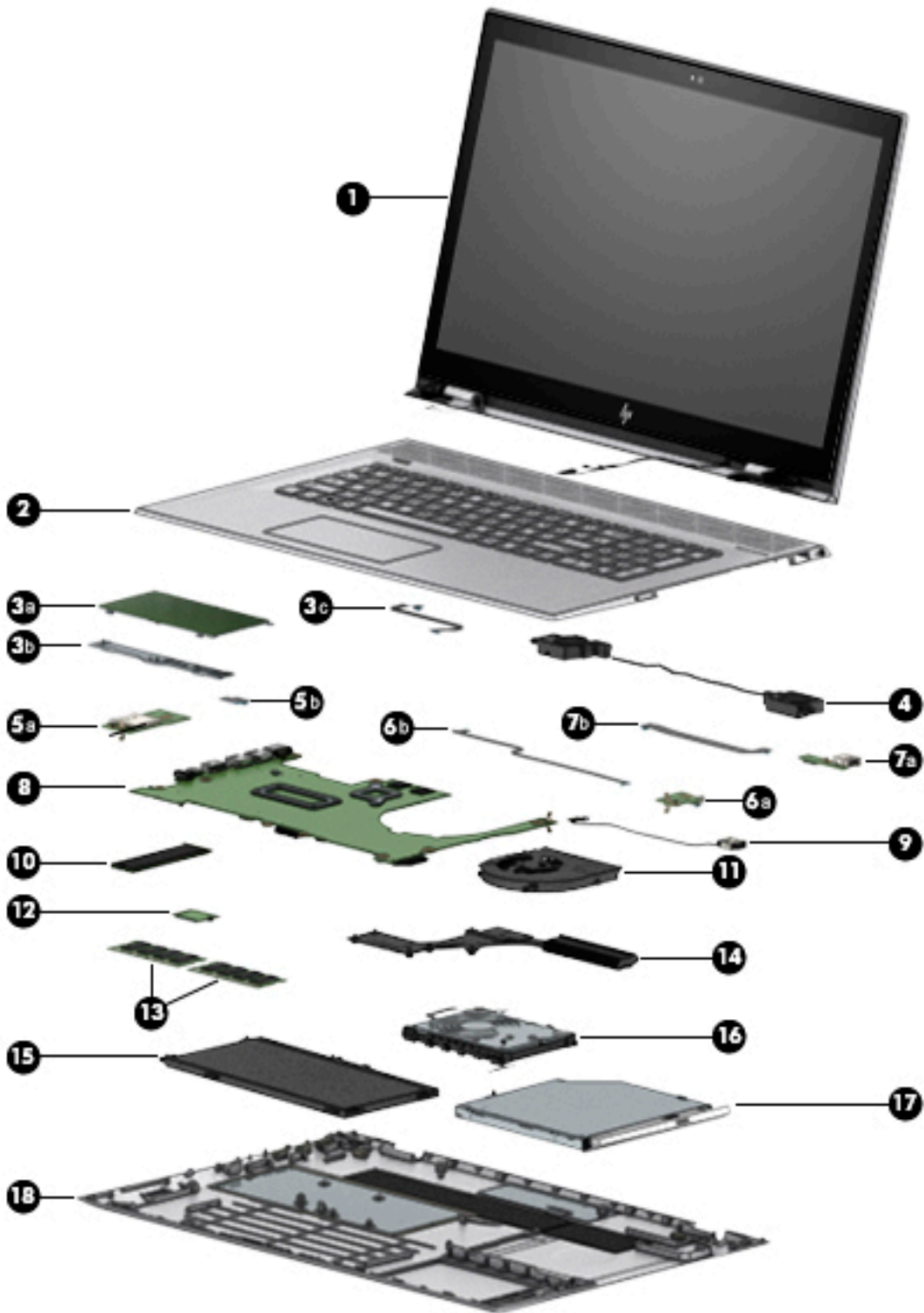

Item	Component	Spare part number
(1)	17.3-in. display assembly:	

Item	Component	Spare part number
	17.3-in., FHD, AntiGlare (1920×1080), LCD, WLED, UWVA, 72 300, eDP, flat, 4.0t TouchScreen display assembly	L20694-001
	17.3-in., UHD, AntiGlare (3840×2160), LCD, WLED, UWVA 72 300, eDP 1.2, flat, non-TouchScreen display assembly	L20696-001
	FHD, AntiGlare, non-TouchScreen display assembly	L20695-001
(2)	Keyboard/top cover with backlight (includes backlight cable and keyboard cable):	
	For use in Belgium	L20714-A41
	For use in Canada	L20714-DB1
	For use in the Czech Republic and Slovakia	L20714-FL1
	For use in Denmark, Finland, and Norway	L20714-DH1
	For use in France	L20714-051
	For use in Germany	L20714-041
	For use in Greece	L20714-151
	For use in Hungary	L20714-211
	For use in Israel	L20714-BB1
	For use in Italy	L20714-061
	For use in the Netherlands	L20714-B31
	For use in Portugal	L20714-131
	For use in Romania	L20714-271
	For use in Russia	L20714-251
	For use in Saudi Arabia	L20714-171
	For use in Slovenia	L20714-BA1
	For use in Spain	L20714-071
	For use in Switzerland	L20714-BG1
	For use in Turkey	L20714-141
	For use in the United Kingdom	L20714-031
	For use in the United States	L20714-001
(3a)	TouchPad (does not include bracket or cable)	L20701-001
(3b)	TouchPad bracket	L20096-001
(3c)	TouchPad cable	L20681-001
(4)	Speakers (include left and right speakers, cables, and four rubber isolators)	L20705-001
(5a)	SD card board (does not include cable)	L20699-001
(5b)	SD card board cable	L20683-001
(6a)	USB port board (does not include cable)	L20698-001
(6b)	USB port board cable	L20685-001

Item	Component	Spare part number
(7a)	Fingerprint reader (not illustrated, does not include bezel, bracket, or cable):	L20700-001
	Fingerprint reader bezel (not illustrated)	L20689-001
	Fingerprint reader bracket (not illustrated)	L20691-001
(7b)	Fingerprint reader cable	L20684-001
(8)	System board (includes processor and replacement thermal material):	
	Equipped with an Intel Core i7-8550U 1.80-GHz quad core processor (2400-MHz FSB, 8.0-MB L3 cache, 15.0-W), an NVIDIA N17S-LG GeForce MX150 (256-MB×32, 2 pieces) GDDR5 graphics subsystem with 4096-MB video memory, and the Windows 10 operating system	L20713-601
	Equipped with an Intel Core i7-8550U 1.80-GHz quad core processor (2400-MHz FSB, 8.0-MB L3 cache, 15.0-W), an NVIDIA N17S-LG GeForce MX150 (256-MB×32, 2 pieces) GDDR5 graphics subsystem with 4096-MB video memory, and a non-Windows operating system	L20713-001
	Equipped with an Intel Core i7-8550U 1.80-GHz quad core processor (2400-MHz FSB, 8.0-MB L3 cache, 15.0-W), an NVIDIA N17S-LG GeForce MX150 (256-MB×32, 2 pieces) GDDR5 graphics subsystem with 2048-MB video memory, and the Windows 10 operating system	L20712-601
	Equipped with an Intel Core i7-8550U 1.80-GHz quad core processor (2400-MHz FSB, 8.0-MB L3 cache, 15.0-W), an NVIDIA N17S-LG GeForce MX150 (256-MB×32, 2 pieces) GDDR5 graphics subsystem with 2048-MB video memory, and a non-Windows operating system	L20712-001
	Equipped with an Intel Core i5-8250U 1.60-GHz quad core processor (2400-MHz FSB, 6.0-MB L3 cache, 15.0-W), an NVIDIA N17S-LG GeForce MX150 (256-MB×32, 2 pieces) GDDR5 graphics subsystem with 2048-MB video memory, and the Windows 10 operating system	L20711-601
	Equipped with an Intel Core i5-8250U 1.60-GHz quad core processor (2400-MHz FSB, 6.0-MB L3 cache, 15.0-W), an NVIDIA N17S-LG GeForce MX150 (256-MB×32, 2 pieces) GDDR5 graphics subsystem with 2048-MB video memory, and a non-Windows operating system	L20711-001
(9)	Power connector cable	L20686-001
(10)	Solid-state drive:	
	512-GB, M.2 2280, PCIe3×4, NVMe solid-state drive with TLC	L20709-001
	512-GB, 2280, PCIe, NVMe solid-state drive	L20710-001
	256-GB, 2280, PCIe, NVMe solid-state drive	L20708-001
	128-GB, M.2 2280-SATA3 solid-state drive with TLC	L20707-001
	16-GB, 2280, PCIe3×2, NVMe, 3D XP solid-state drive	L20706-001
(11)	Fan (includes cable)	926724-001
(12)	WLAN module:	
	Intel 9260 ac 2×2 + Bluetooth 5 M.2 2230 non-vPro PCI-e+USB world-wide with 2 antennas	L16647-005
	Intel D1 7265 ac 2×2 + Bluetooth 4.2 M.2 non-vPro PCI-e+USB world-wide with 2 antennas	901229-855
(13)	Memory modules (2, 2400, 1.2-V, DDR4):	
	8-MB	862398-855
	4-MB	862397-855
(14)	Heat sink (includes replacement thermal material)	L20687-001
(15)	Battery (3-cell, 52-WHr, 4.55-AHr, Li-ion, includes cable)	L09281-855
(16)	1-TB, 7200-rpm, 7.0-mm hard drive (does not include cable or rubber sleeve):	L06427-855

Item	Component	Spare part number
	Hard drive cable	L20682-001
	Hard drive rubber sleeve	L20702-001
(17)	DVD/RW Drive (9-mm)	L20697-001
	Optical drive bezel	L20680-001
	Optical drive bracket	L20692-001
(18)	Bottom cover	L20679-001
	Security lock bracket (not illustrated)	L20693-001
	Rubber Kit (not illustrated, includes bottom cover rubber foot strip)	L20703-001

Miscellaneous parts

Component	Spare part number
AC adapter:	
90-W HP Smart AC adapter PFC, RA, 4.5-mm	937532-850
65-W HP Smart AC adapter non-PFC, 4.5-mm, with mount	854117-850
Adapter:	
HP HDMI-to-VGA adapter	701943-001
HP USB-C-to-HDMI 2.0 adapter	935325-001
HP USB-C-to-MultiPort hub	919666-001
HP USB-C-to-USB-A dongle	833960-001
HP USB-C-to-USB-A hub	916838-001
Power cord (C5 connector, FX, DH, STK, PRM, 1.00-m):	
For use in Denmark	L19342-001
For use in Europe	L19343-001
For use in Israel	L19344-001
For use in North America	L19348-001
For use in South Africa	L19350-001
For use in Switzerland	L19351-001
For use in the United Kingdom	L19354-001
Power cord (C5 connector, STR, PRM, 1.00-m):	
For use in Denmark	L22322-001
For use in Europe	L22321-001
For use in Israel	L22323-001
For use in North America	L22319-001

Component	Spare part number
For use in South Africa	L22325-001
For use in Switzerland	L22324-001
For use in the United Kingdom	L22320-001
Rubber Kit (includes bottom cover rear foot strip)	L20703-001
Screw Kit	L20704-001

4 Removal and replacement preliminary requirements

Tools required

You will need the following tools to complete the removal and replacement procedures:

- Flat-bladed screw driver
- Magnetic screw driver
- Phillips P0 screw driver
- Torx5 screw driver

Service considerations

The following sections include some of the considerations that you must keep in mind during disassembly and assembly procedures.



NOTE: As you remove each subassembly from the computer, place the subassembly (and all accompanying screws) away from the work area to prevent damage.

Plastic parts



CAUTION: Using excessive force during disassembly and reassembly can damage plastic parts. Use care when handling the plastic parts. Apply pressure only at the points designated in the maintenance instructions.

Cables and connectors

⚠ CAUTION: When servicing the computer, be sure that cables are placed in their proper locations during the reassembly process. Improper cable placement can damage the computer.

Cables must be handled with extreme care to avoid damage. Apply only the tension required to unseat or seat the cables during removal and insertion. Handle cables by the connector whenever possible. In all cases, avoid bending, twisting, or tearing cables. Be sure that cables are routed in such a way that they cannot be caught or snagged by parts being removed or replaced. Handle flex cables with extreme care; these cables tear easily.

Drive handling

⚠ CAUTION: Drives are fragile components that must be handled with care. To prevent damage to the computer, damage to a drive, or loss of information, observe these precautions:

Before removing or inserting a drive, shut down the computer. If you are unsure whether the computer is off or in Hibernation, turn the computer on, and then shut it down through the operating system.

Before handling a drive, be sure that you are discharged of static electricity. While handling a drive, avoid touching the connector.

Before removing a diskette drive or optical drive, be sure that a diskette or disc is not in the drive and be sure that the optical drive tray is closed.

Handle drives on surfaces covered with at least one inch of shock-proof foam.

Avoid dropping drives from any height onto any surface.

After removing drive, place it in a static-proof bag.

Avoid exposing a drive to products that have magnetic fields, such as monitors or speakers.

Avoid exposing a drive to temperature extremes or liquids.

If a drive must be mailed, place the drive in a bubble pack mailer or other suitable form of protective packaging and label the package "FRAGILE."

Grounding guidelines

Electrostatic discharge damage

Electronic components are sensitive to electrostatic discharge (ESD). Circuitry design and structure determine the degree of sensitivity. Networks built into many integrated circuits provide some protection, but in many cases, ESD contains enough power to alter device parameters or melt silicon junctions.

A discharge of static electricity from a finger or other conductor can destroy static-sensitive devices or microcircuitry. Even if the spark is neither felt nor heard, damage may have occurred.

An electronic device exposed to ESD may not be affected at all and can work perfectly throughout a normal cycle. Or the device may function normally for a while, then degrade in the internal layers, reducing its life expectancy.

⚠ CAUTION: To prevent damage to the computer when you are removing or installing internal components, observe these precautions:

Keep components in their electrostatic-safe containers until you are ready to install them.

Before touching an electronic component, discharge static electricity by using the guidelines described in this section.

Avoid touching pins, leads, and circuitry. Handle electronic components as little as possible.

If you remove a component, place it in an electrostatic-safe container.

The following table shows how humidity affects the electrostatic voltage levels generated by different activities.

⚠ CAUTION: A product can be degraded by as little as 700 V.

Typical electrostatic voltage levels			
Event	Relative humidity		
	10%	40%	55%
Walking across carpet	35,000 V	15,000 V	7,500 V
Walking across vinyl floor	12,000 V	5,000 V	3,000 V
Motions of bench worker	6,000 V	800 V	400 V
Removing DIPS from plastic tube	2,000 V	700 V	400 V
Removing DIPS from vinyl tray	11,500 V	4,000 V	2,000 V
Removing DIPS from Styrofoam	14,500 V	5,000 V	3,500 V
Removing bubble pack from PCB	26,500 V	20,000 V	7,000 V
Packing PCBs in foam-lined box	21,000 V	11,000 V	5,000 V

Packaging and transporting guidelines

Follow these grounding guidelines when packaging and transporting equipment:

- To avoid hand contact, transport products in static-safe tubes, bags, or boxes.
- Protect ESD-sensitive parts and assemblies with conductive or approved containers or packaging.
- Keep ESD-sensitive parts in their containers until the parts arrive at static-free workstations.
- Place items on a grounded surface before removing items from their containers.
- Always be properly grounded when touching a component or assembly.
- Store reusable ESD-sensitive parts from assemblies in protective packaging or nonconductive foam.
- Use transporters and conveyors made of antistatic belts and roller bushings. Be sure that mechanized equipment used for moving materials is wired to ground and that proper materials are selected to avoid static charging. When grounding is not possible, use an ionizer to dissipate electric charges.

Workstation guidelines

Follow these grounding workstation guidelines:

- Cover the workstation with approved static-shielding material.
- Use a wrist strap connected to a properly grounded work surface and use properly grounded tools and equipment.
- Use conductive field service tools, such as cutters, screw drivers, and vacuums.
- When fixtures must directly contact dissipative surfaces, use fixtures made only of static-safe materials.
- Keep the work area free of nonconductive materials, such as ordinary plastic assembly aids and Styrofoam.
- Handle ESD-sensitive components, parts, and assemblies by the case or PCM laminate. Handle these items only at static-free workstations.
- Avoid contact with pins, leads, or circuitry.
- Turn off power and input signals before inserting or removing connectors or test equipment.

Equipment guidelines

Grounding equipment must include either a wrist strap or a foot strap at a grounded workstation.

- When seated, wear a wrist strap connected to a grounded system. Wrist straps are flexible straps with a minimum of one megohm $\pm 10\%$ resistance in the ground cords. To provide proper ground, wear a strap snugly against the skin at all times. On grounded mats with banana-plug connectors, use alligator clips to connect a wrist strap.
- When standing, use foot straps and a grounded floor mat. Foot straps (heel, toe, or boot straps) can be used at standing workstations and are compatible with most types of shoes or boots. On conductive floors or dissipative floor mats, use foot straps on both feet with a minimum of one megohm resistance between the operator and ground. To be effective, the conductive must be worn in contact with the skin.

The following grounding equipment is recommended to prevent electrostatic damage:

- Antistatic tape
- Antistatic smocks, aprons, and sleeve protectors
- Conductive bins and other assembly or soldering aids
- Nonconductive foam
- Conductive computerop workstations with ground cords of one megohm resistance
- Static-dissipative tables or floor mats with hard ties to the ground
- Field service kits
- Static awareness labels
- Material-handling packages
- Nonconductive plastic bags, tubes, or boxes
- Metal tote boxes
- Electrostatic voltage levels and protective materials

The following table lists the shielding protection provided by antistatic bags and floor mats.

Material	Use	Voltage protection level
Antistatic plastics	Bags	1,500 V
Carbon-loaded plastic	Floor mats	7,500 V
Metallized laminate	Floor mats	5,000 V

5 Removal and replacement procedures

This chapter provides removal and replacement procedures for Authorized Service Provider only parts.

 **CAUTION:** Components described in this chapter should only be accessed by an authorized service provider. Accessing these parts can damage the computer or void the warranty.

CAUTION: This computer does not have user-replaceable parts. Only HP authorized service providers should perform the removal and replacement procedures described here. Accessing the internal part could damage the computer or void the warranty.

Component replacement procedures

 **NOTE:** Details about your computer, including model, serial number, product key, and length of warranty, are on the service tag at the bottom of your computer. See [Labels on page 11](#) for details.

 **NOTE:** HP continually improves and changes product parts. For complete and current information on supported parts for your computer, go to <http://partsurfer.hp.com>, select your country or region, and then follow the on-screen instructions.

There are as many as 49 screws that must be removed, replaced, and/or loosened when servicing Authorized Service Provider only parts. Make special note of each screw size and location during removal and replacement.

Bottom cover

Description	Spare part number
Bottom cover	L20679-001

Before disassembling the computer, follow these steps:

1. Shut down the computer. If you are unsure whether the computer is off or in Hibernation, turn the computer on, and then shut it down through the operating system.
2. Disconnect all external devices connected to the computer.
3. Disconnect the power from the computer by first unplugging the power cord from the AC outlet, and then unplugging the AC adapter from the computer.

Remove the keyboard/top cover:

1. Remove the rear **(1)** and front rubber foot strips **(2)**.
The front and rear rubber foot strips are included in the Rubber Kit, spare part number L20703-001.
2. Remove the following screws that secure the bottom cover to the computer:
 - (3)** Eight Phillips M2.5×7.6 screws (under the rubber foot strips)
 - (4)** Two Torx5 M2.0×13.8 screws (in the middle of the bottom cover)
 - (5)** One Torx5 M2.0×4.3 screws (on the front edge of the computer)

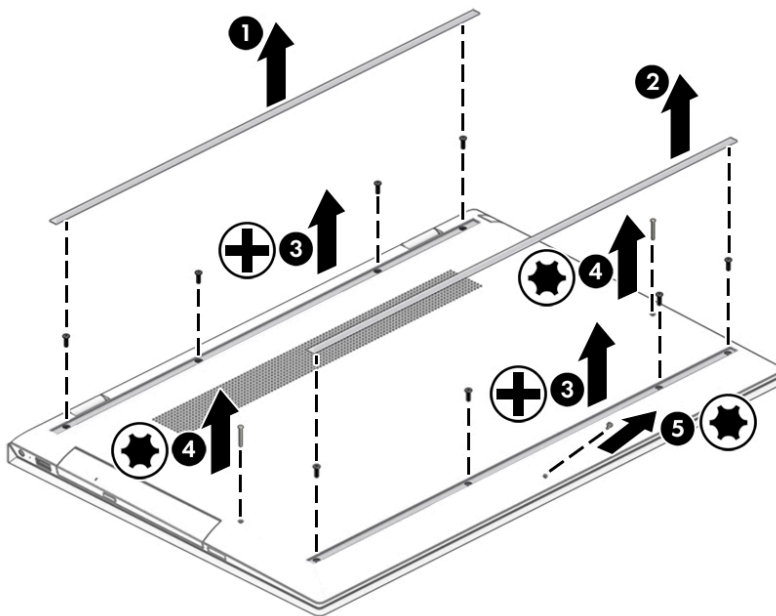

3. Use an unbent paper clip **(1)** or similar thin plastic tool to release the optical drive tray **(2)**.

4. Remove the Phillips M2.0×2.2 broad head screw (3) that secures the bottom cover to the keyboard/top cover in the optical drive bay.

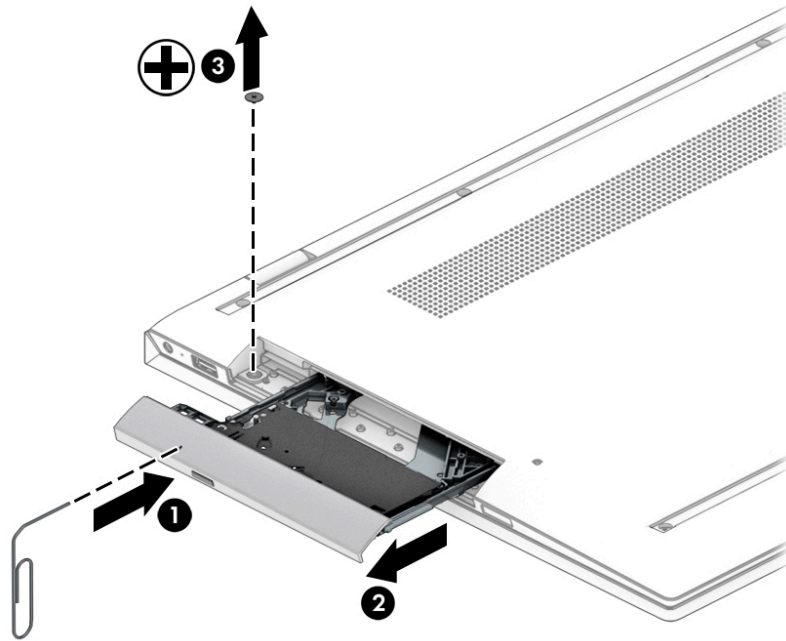

5. Use a case utility tool (1) or similar thin plastic tool to separate the rear edge of the bottom cover (2) from the computer.
6. Remove the bottom cover (3).

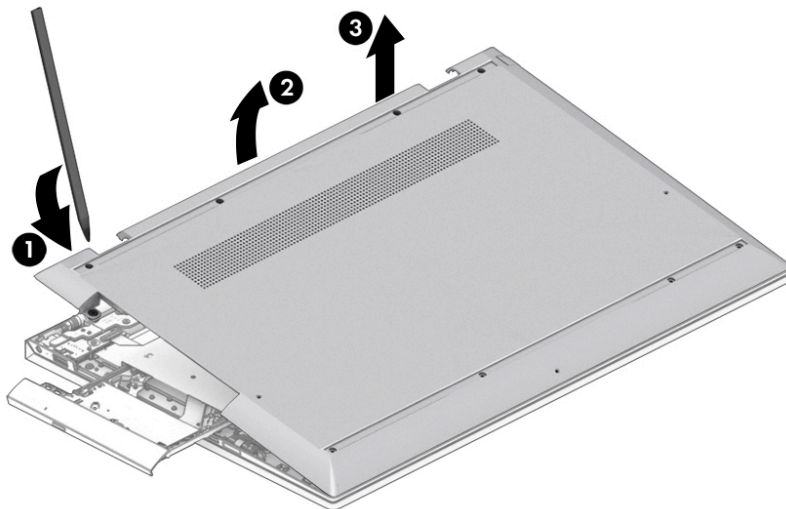

Reverse this procedure to install the bottom cover.

Battery

Description	Spare part number
3-cell, 52-WHr, 4.55-AHr, Li-ion battery	L09281-855

Before removing the battery, follow these steps:

1. Shut down the computer. If you are unsure whether the computer is off or in Hibernation, turn the computer on, and then shut it down through the operating system.
2. Disconnect all external devices connected to the computer.
3. Disconnect the power from the computer by first unplugging the power cord from the AC outlet, and then unplugging the AC adapter from the computer.
4. Remove the bottom cover (see [Bottom cover on page 24](#)).

Remove the battery:

1. Remove the six Phillips M2.0×4.1 screws (1) that secure the battery to the keyboard/top cover.
2. Release the battery (2) by lifting the rear edge until the battery rests at an angle.
3. Remove the battery (3).

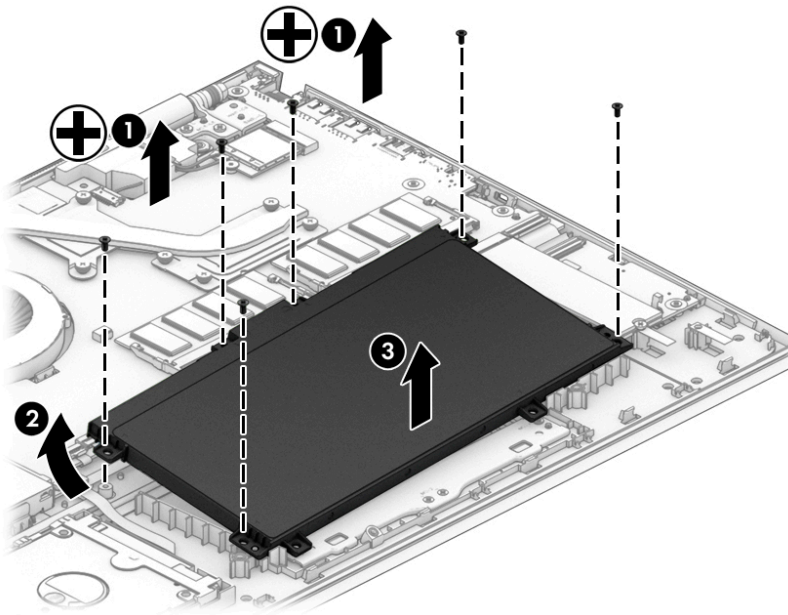

Reverse this procedure to install the battery.

Hard drive

Description	Spare part number
1-TB, 7200-rpm, 7.0-mm hard drive (does not include cable or rubber sleeve)	L06427-855

Before removing the hard drive, follow these steps:

1. Shut down the computer. If you are unsure whether the computer is off or in Hibernation, turn the computer on, and then shut it down through the operating system.
2. Disconnect all external devices connected to the computer.
3. Disconnect the power from the computer by first unplugging the power cord from the AC outlet, and then unplugging the AC adapter from the computer.
4. Remove the bottom cover (see [Bottom cover on page 24](#)).
5. Remove the battery (see [Battery on page 26](#)).

Remove the hard drive:

1. Release the zero insertion force (ZIF) connector (1) to which hard drive cable is connected, and then disconnect the hard drive cable from the system board.
2. Remove the hard drive (2).

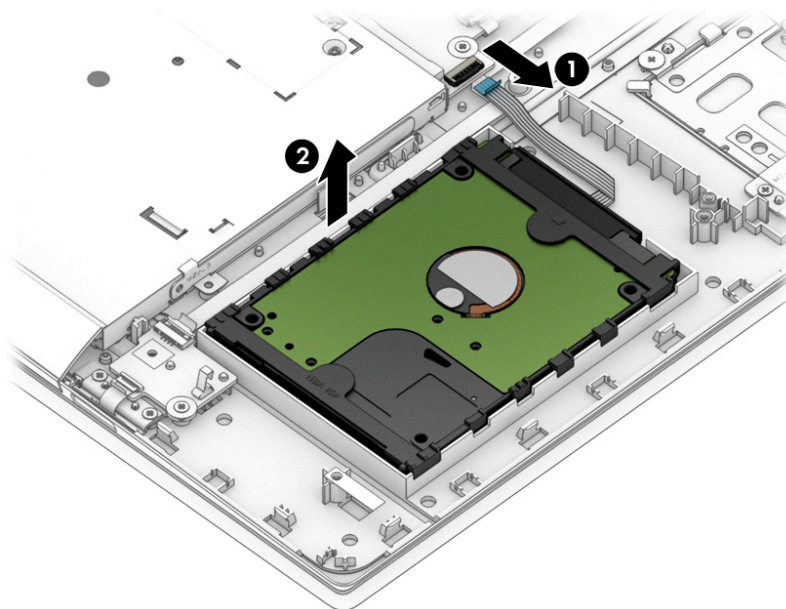

3. If it is necessary to remove the hard drive cable and/or hard drive rubber sleeve:
 - a. Disconnect the hard drive cable (1) from the front of the hard drive, and if necessary, save it for use on the replacement hard drive.
The hard drive cable is available using spare part number L20682-001.
 - b. Remove the hard drive rubber sleeve (2) from the hard drive, and if necessary, save it for use on the replacement hard drive.
The hard drive rubber sleeve is available using spare part number L20702-001.

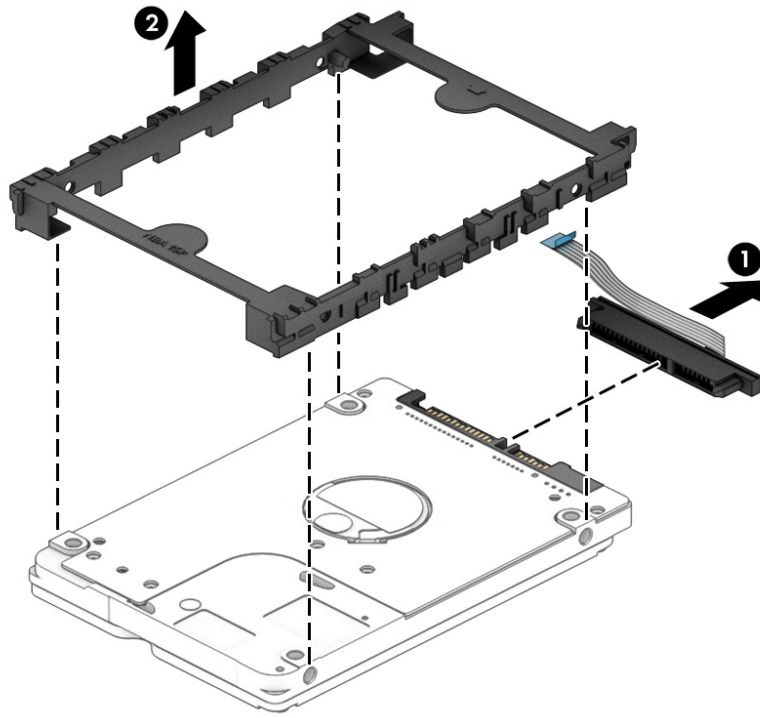

Reverse this procedure to install the hard drive.

Solid-state drive

Description	Spare part number
512-GB, M.2 2280, PCIe3×4, NVMe solid-state drive with TLC	L20709-001
512-GB, 2280, PCIe, NVMe solid-state drive	L20710-001
256-GB, 2280, PCIe, NVMe solid-state drive	L20708-001
128-GB, M.2 2280-SATA3 solid-state drive with TLC	L20707-001
16-GB, 2280, PCIe3×2, NVMe, 3D XP solid-state drive	L20706-001

Before removing the solid-state drive, follow these steps:

1. Shut down the computer. If you are unsure whether the computer is off or in Hibernation, turn the computer on, and then shut it down through the operating system.
2. Disconnect all external devices connected to the computer.
3. Disconnect the power from the computer by first unplugging the power cord from the AC outlet, and then unplugging the AC adapter from the computer.
4. Remove the bottom cover (see [Bottom cover on page 24](#)).
5. Remove the battery (see [Battery on page 26](#)).

Remove the solid-state drive:

1. Remove the Phillips M2.0×4.1 screw **(1)** that secures the solid-state drive to the system board.
2. Remove the solid-state drive **(2)** by pulling it away from the connector.

 **NOTE:** Solid-state drives are designed with notches to prevent incorrect insertion.

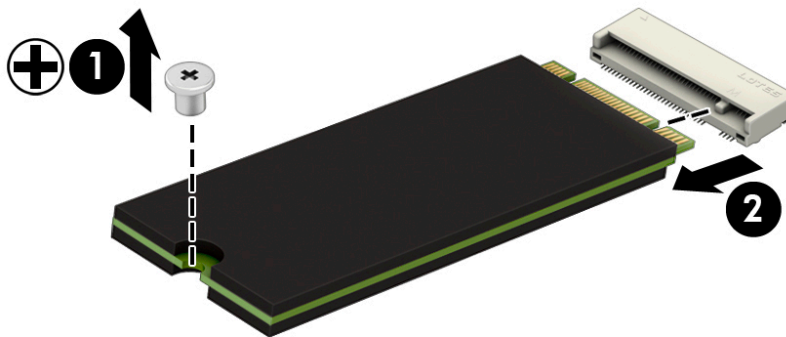

Reverse this procedure to install the solid-state drive.

Memory module

Description	Spare part number
8-MB (2400, 1.2-V, DDR4)	862398-855
4-MB (2400, 1.2-V, DDR4)	862397-855

Update BIOS before adding memory modules

Before adding new memory, make sure you update the computer to the latest BIOS.

 **CAUTION:** Failure to update the computer to the latest BIOS prior to installing new memory may result in various system problems.

Before removing the memory module, follow these steps:

1. Shut down the computer. If you are unsure whether the computer is off or in Hibernation, turn the computer on, and then shut it down through the operating system.
2. Disconnect all external devices connected to the computer.
3. Disconnect the power from the computer by first unplugging the power cord from the AC outlet, and then unplugging the AC adapter from the computer.
4. Remove the bottom cover (see [Bottom cover on page 24](#)).
5. Remove the battery (see [Battery on page 26](#)).

Remove the memory module:

1. Spread the retaining tabs **(1)** on each side of the memory module slot to release the memory module. (The edge of the module opposite the slot rises away from the computer.).

2. Remove the memory module (2) by pulling the module away from the slot at an angle.

 **NOTE:** Memory modules are designed with a notch to prevent incorrect insertion into the memory module slot.

 **NOTE:** The computer uses two memory slots. The top slot houses the expansion memory module. The bottom slot houses the primary memory module.

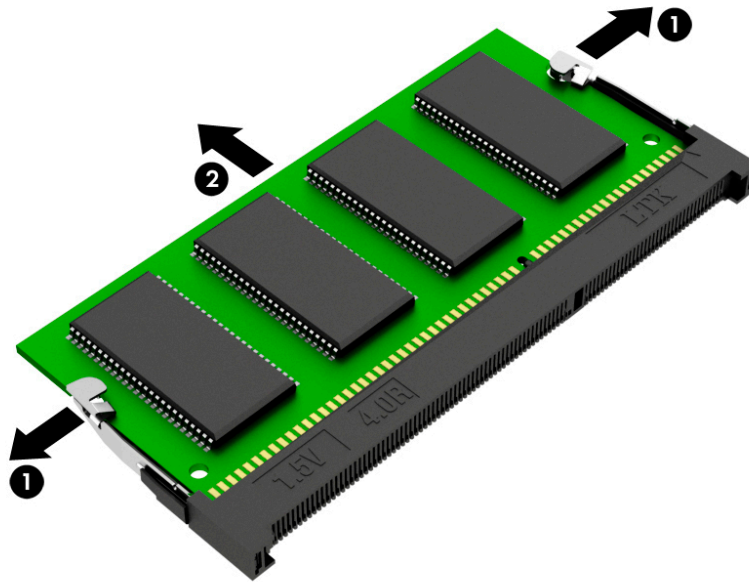

Reverse this procedure to install a memory module.

WLAN module

Description	Spare part number
Intel 9260 ac 2×2 + Bluetooth 5 M.2 2230 non-vPro PCI-e+USB world-wide with 2 antennas	L16647-005
Intel D1 7265 ac 2×2 + Bluetooth 4.2 M.2 non-vPro PCI-e+USB world-wide with 2 antennas	901229-855

 **CAUTION:** To prevent an unresponsive system, replace the wireless module only with a wireless module authorized for use in the computer by the governmental agency that regulates wireless devices in your country or region. If you replace the module and then receive a warning message, remove the module to restore device functionality, and then contact technical support.

Before removing the WLAN module, follow these steps:

1. Shut down the computer. If you are unsure whether the computer is off or in Hibernation, turn the computer on, and then shut it down through the operating system.
2. Disconnect all external devices connected to the computer.
3. Disconnect the power from the computer by first unplugging the power cord from the AC outlet, and then unplugging the AC adapter from the computer.
4. Remove the bottom cover (see [Bottom cover on page 24](#)).
5. Remove the battery (see [Battery on page 26](#)).

Remove the WLAN module:

1. Disconnect the WLAN antenna cables **(1)** from the terminals on the WLAN module.



NOTE: The WLAN antenna cable labeled "1/MAIN" connects to the WLAN module "Main" terminal. The WLAN antenna cable labeled "2/AUX" connects to the WLAN module "Aux" terminal.

2. Remove the Phillips M2.0×4.1 screw **(2)** that secures the solid-state drive to the system board. (The WLAN module tilts up.)

3. Remove the WLAN module (3) by pulling the module away from the slot at an angle.

 **NOTE:** WLAN modules are designed with notches to prevent incorrect insertion.

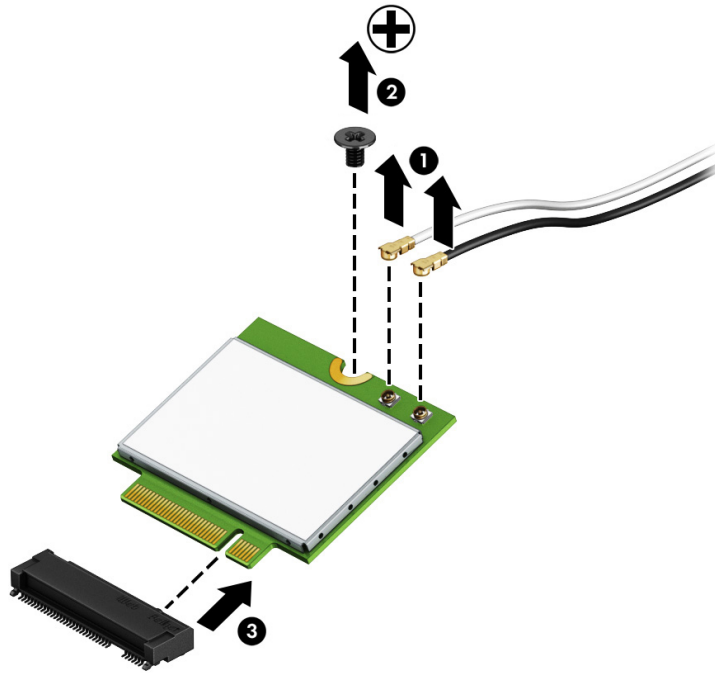

Reverse this procedure to install the WLAN module.

TouchPad cable

 **NOTE:** The TouchPad spare part kit does not include the TouchPad cable. The TouchPad cable is available using spare part number L20681-001.

Before removing the TouchPad cable, follow these steps:

1. Shut down the computer. If you are unsure whether the computer is off or in Hibernation, turn the computer on, and then shut it down through the operating system.
2. Disconnect all external devices connected to the computer.
3. Disconnect the power from the computer by first unplugging the power cord from the AC outlet, and then unplugging the AC adapter from the computer.
4. Remove the bottom cover (see [Bottom cover on page 24](#)).
5. Remove the battery (see [Battery on page 26](#)).

Remove the TouchPad cable:

1. Release the ZIF connector **(1)** to which TouchPad cable is connected, and then disconnect the TouchPad cable from the system board.
2. Release the ZIF connector **(2)** to which TouchPad cable is connected, and then disconnect the TouchPad cable from the TouchPad.
3. Detach the TouchPad cable **(3)** from the keyboard/top cover. (The TouchPad cable is attached to the keyboard/top cover with double-sided adhesive.)
4. Remove the TouchPad cable **(4)**.

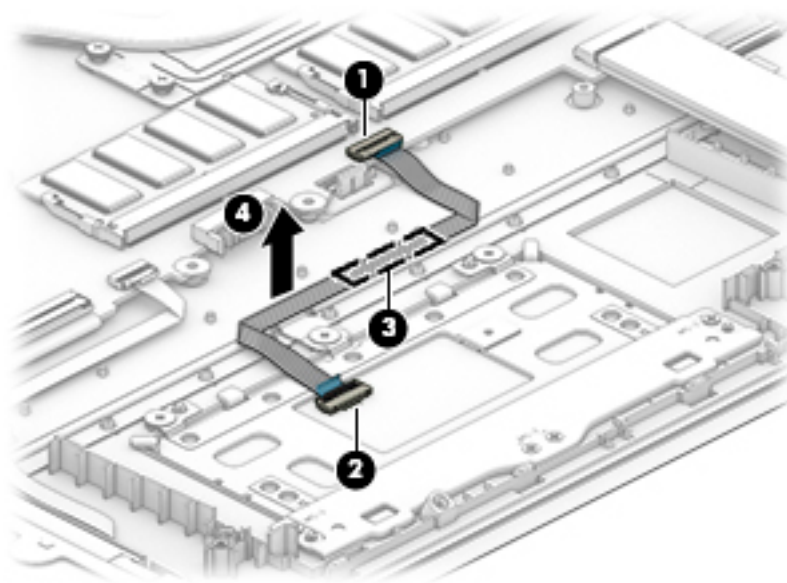

Reverse this procedure to install the TouchPad cable.

TouchPad



NOTE: The TouchPad spare part kit does not include the TouchPad bracket or TouchPad cable. The TouchPad bracket is available using spare part number L20096-001. The TouchPad cable is available using spare part number L20681-001.

Description	Spare part number
For use only on computer models in natural silver finish	L20701-001

Before removing the TouchPad, follow these steps:

1. Shut down the computer. If you are unsure whether the computer is off or in Hibernation, turn the computer on, and then shut it down through the operating system.
2. Disconnect all external devices connected to the computer.
3. Disconnect the power from the computer by first unplugging the power cord from the AC outlet, and then unplugging the AC adapter from the computer.
4. Remove the bottom cover (see [Bottom cover on page 24](#)).
5. Remove the battery (see [Battery on page 26](#)).

Remove the TouchPad:

1. Release the ZIF connector **(1)** to which TouchPad cable is connected, and then disconnect the TouchPad cable from the system board.
2. Detach the TouchPad cable **(2)** from the keyboard/top cover. (The TouchPad cable is attached to the keyboard/top cover with double-sided adhesive.)
3. Remove the three Phillips M2.0×2.3 broad head screws **(3)** that secure the TouchPad to the keyboard/top cover.
4. Remove the four Phillips M2.0×3.3 screws **(4)** that secure the TouchPad and TouchPad bracket to the keyboard/top cover.
5. Remove the TouchPad bracket **(5)**.

6. Remove the TouchPad (6).

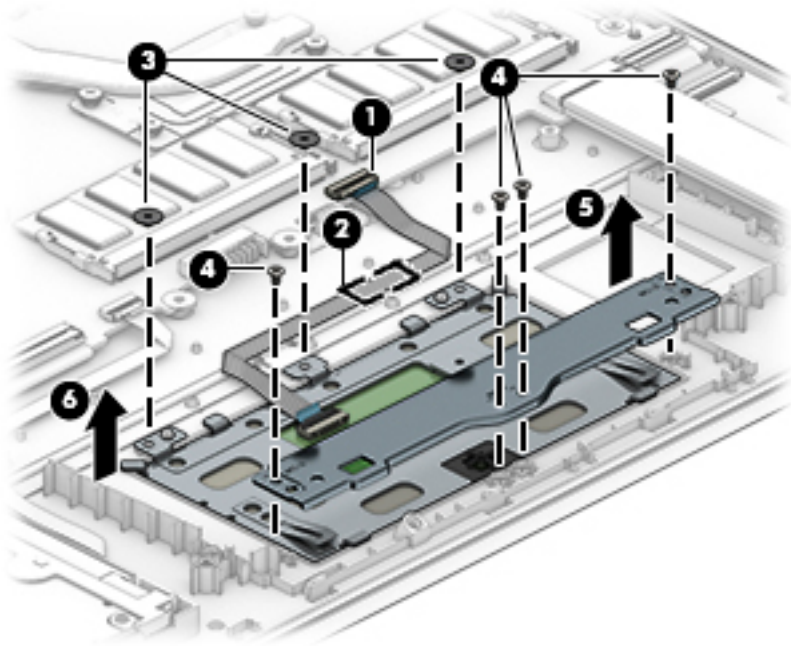

Reverse this procedure to install the TouchPad and bracket.

Fingerprint reader cable

 **NOTE:** The fingerprint reader spare part kit does not include the fingerprint reader cable. The fingerprint reader cable is available using spare part number L20684-001.

Before removing the fingerprint reader cable, follow these steps:

1. Shut down the computer. If you are unsure whether the computer is off or in Hibernation, turn the computer on, and then shut it down through the operating system.
2. Disconnect all external devices connected to the computer.
3. Disconnect the power from the computer by first unplugging the power cord from the AC outlet, and then unplugging the AC adapter from the computer.
4. Remove the bottom cover (see [Bottom cover on page 24](#)).
5. Remove the battery (see [Battery on page 26](#)).

Remove the fingerprint reader cable:

1. Release the ZIF connector **(1)** to which fingerprint reader cable is connected, and then disconnect the fingerprint reader cable from the system board.
2. Release the ZIF connector **(2)** to which fingerprint reader cable is connected, and then disconnect the fingerprint reader cable from the fingerprint reader.
3. Detach the fingerprint reader cable **(3)** from the keyboard/top cover. (The fingerprint reader cable is attached to the keyboard/top cover with double-sided adhesive at two locations.)
4. Remove the fingerprint reader cable **(4)**.

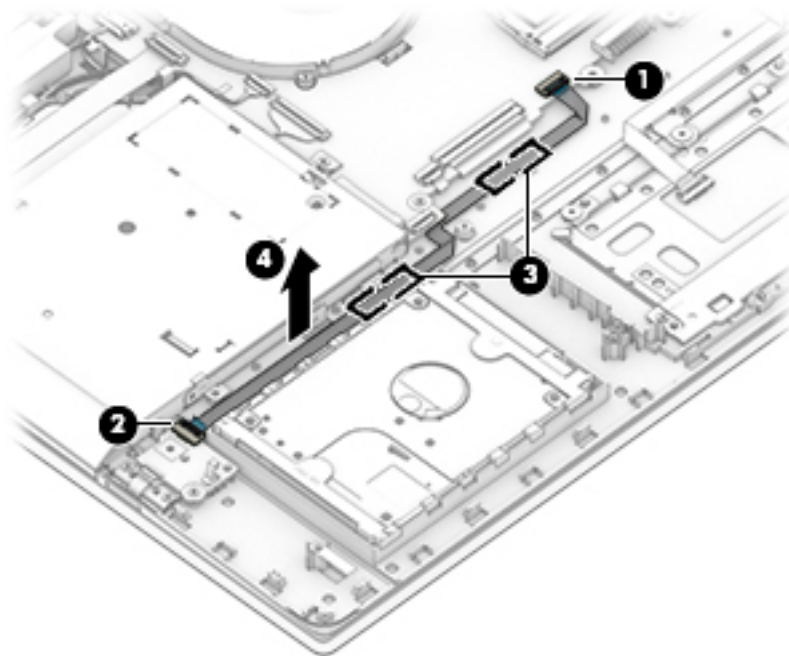

Reverse this procedure to install the fingerprint reader cable.

Fingerprint reader

 **NOTE:** The fingerprint reader spare part kit does not include the fingerprint reader bracket or fingerprint reader cable. The fingerprint reader bracket is available using spare part number L20691-001. The fingerprint reader cable is available using spare part number L20684-001.

Description	Spare part number
For use only on computer models in natural silver finish	L20700-001

Before removing the fingerprint reader, follow these steps:

1. Shut down the computer. If you are unsure whether the computer is off or in Hibernation, turn the computer on, and then shut it down through the operating system.
2. Disconnect all external devices connected to the computer.
3. Disconnect the power from the computer by first unplugging the power cord from the AC outlet, and then unplugging the AC adapter from the computer.
4. Remove the bottom cover (see [Bottom cover on page 24](#)).
5. Remove the battery (see [Battery on page 26](#)).

Remove the fingerprint reader:

1. Release the ZIF connector (1) to which fingerprint reader cable is connected, and then disconnect the fingerprint reader cable from the fingerprint reader.
2. Release the ZIF connector (2) to which fingerprint reader cable is connected, and then disconnect the fingerprint reader cable from the fingerprint reader.
3. Remove the Phillips M2.0×4.1 screw (3) that secure the fingerprint reader to the keyboard/top cover.
4. Remove the fingerprint reader (4).

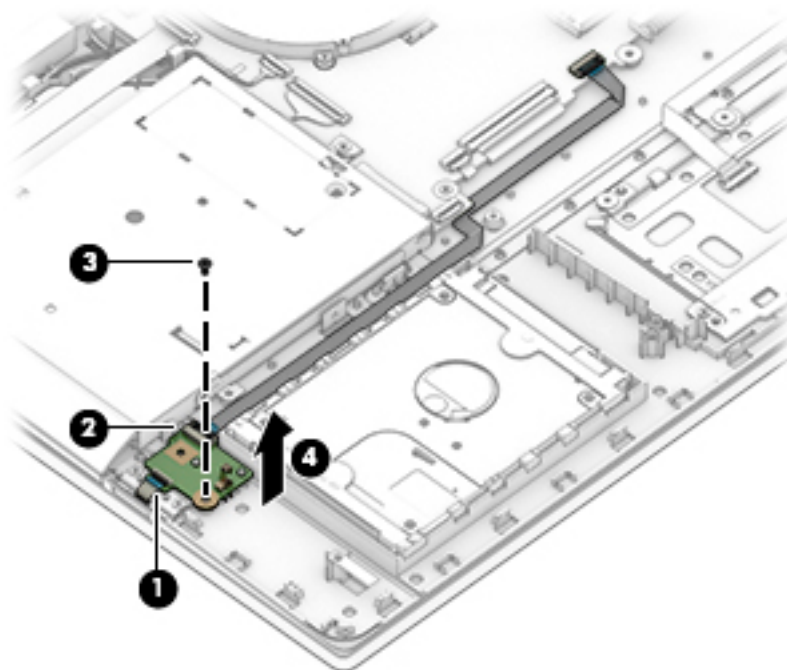

Reverse this procedure to install the fingerprint reader.

SD card board cable

 **NOTE:** The SD card board spare part kit does not include the SD card board cable. The SD card board cable is available using spare part number L20683-001.

Before removing the SD card board cable, follow these steps:

1. Shut down the computer. If you are unsure whether the computer is off or in Hibernation, turn the computer on, and then shut it down through the operating system.
2. Disconnect all external devices connected to the computer.
3. Disconnect the power from the computer by first unplugging the power cord from the AC outlet, and then unplugging the AC adapter from the computer.
4. Remove the bottom cover (see [Bottom cover on page 24](#)).
5. Remove the battery (see [Battery on page 26](#)).

Remove the SD card board cable:

1. Release the ZIF connector (1) to which SD card board cable is connected, and then disconnect the SD card board cable from the system board.
2. Release the ZIF connector (2) to which SD card board cable is connected, and then disconnect the SD card board cable from the SD card board.
3. Remove the SD card board cable (3).

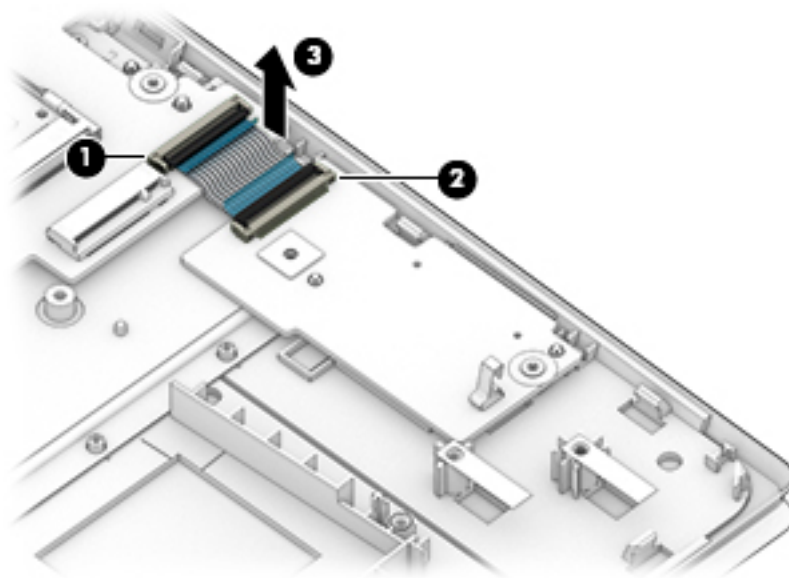

Reverse this procedure to install the SD card board cable.

SD card board

 **NOTE:** The SD card board spare part kit does not include the SD card board bracket or SD card board cable. The SD card board cable is available using spare part number L20683-001.

Description	Spare part number
For use only on computer models in natural silver finish	L20699-001

Before removing the SD card board, follow these steps:

1. Shut down the computer. If you are unsure whether the computer is off or in Hibernation, turn the computer on, and then shut it down through the operating system.
2. Disconnect all external devices connected to the computer.
3. Disconnect the power from the computer by first unplugging the power cord from the AC outlet, and then unplugging the AC adapter from the computer.
4. Remove the bottom cover (see [Bottom cover on page 24](#)).
5. Remove the battery (see [Battery on page 26](#)).

Remove the SD card board:

1. Release the ZIF connector (1) to which SD card board cable is connected, and then disconnect the SD card board cable from the SD card board.
2. Remove the Phillips M2.0×4.1 screw (2) that secure the SD card board to the keyboard/top cover.
3. Remove the SD card board (3).

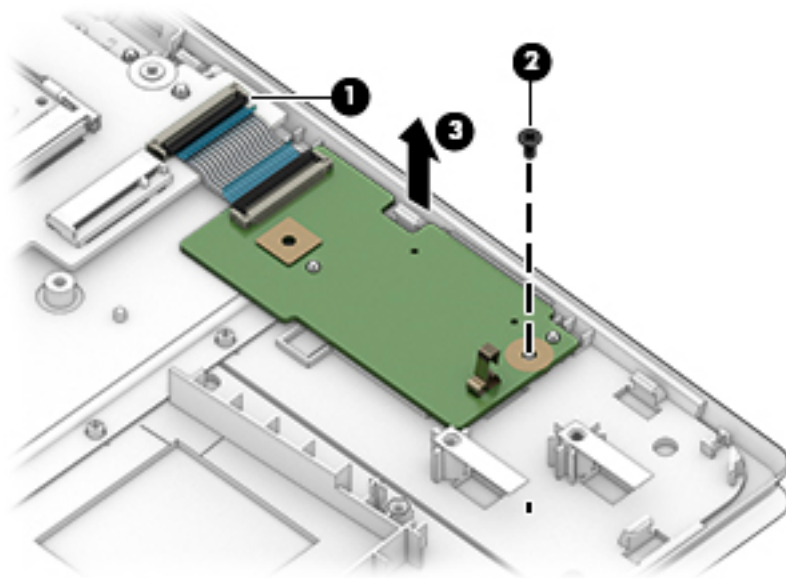

Reverse this procedure to install the SD card board.

Optical drive

Description	Spare part number
DVD/RW Drive (includes bezel and bracket)	L20697-001

Before removing the optical drive, follow these steps:

1. Shut down the computer. If you are unsure whether the computer is off or in Hibernation, turn the computer on, and then shut it down through the operating system.
2. Disconnect all external devices connected to the computer.
3. Disconnect the power from the computer by first unplugging the power cord from the AC outlet, and then unplugging the AC adapter from the computer.
4. Remove the bottom cover (see [Bottom cover on page 24](#)).
5. Remove the battery (see [Battery on page 26](#)).

Remove the optical drive:

1. Remove the Phillips M2.0×4.1 screw **(1)** that secures the optical drive to the keyboard/top cover.
2. Slide the optical drive **(2)** away from the optical drive connector and remove it.

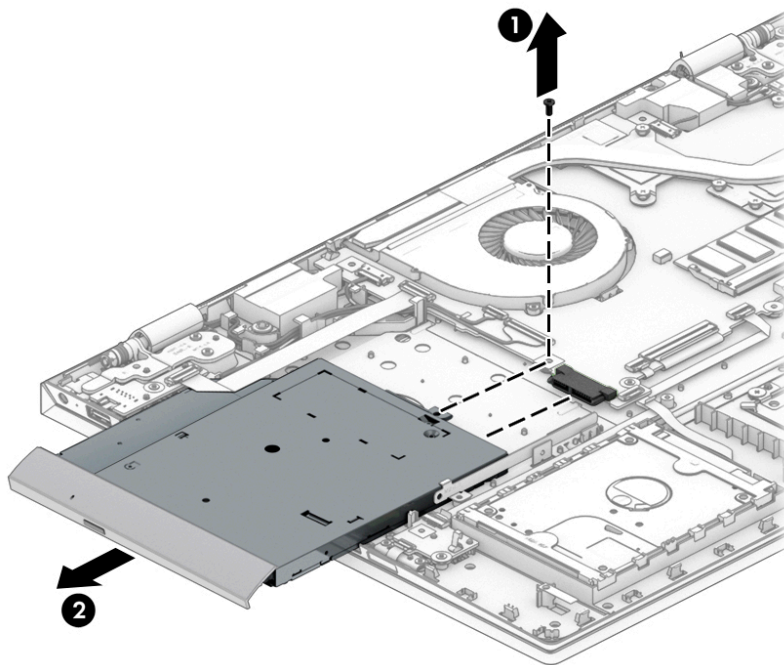

Reverse this procedure to install the optical drive.

USB port board cable

 **NOTE:** The USB port board spare part kit does not include the USB port board cable. The USB port board cable is available using spare part number L20685-001.

Before removing the USB port board cable, follow these steps:

1. Shut down the computer. If you are unsure whether the computer is off or in Hibernation, turn the computer on, and then shut it down through the operating system.
2. Disconnect all external devices connected to the computer.
3. Disconnect the power from the computer by first unplugging the power cord from the AC outlet, and then unplugging the AC adapter from the computer.
4. Remove the bottom cover (see [Bottom cover on page 24](#)).
5. Remove the battery (see [Battery on page 26](#)).

Remove the USB port board cable:

1. Release the ZIF connector **(1)** to which USB port board cable is connected, and then disconnect the USB port board cable from the system board.
2. Release the ZIF connector **(2)** to which USB port board cable is connected, and then disconnect the USB port board cable from the USB port board.
3. Remove the USB port board cable **(3)**.

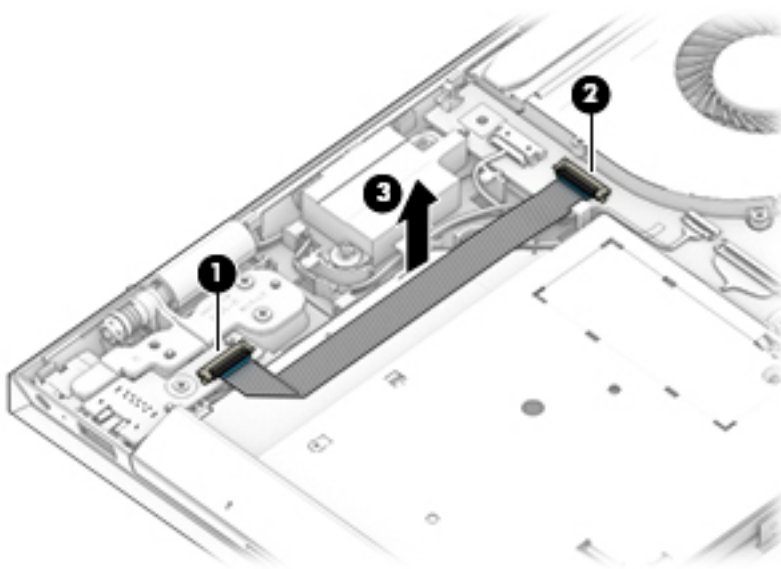

Reverse this procedure to install the USB port board cable.

USB port board

 **NOTE:** The USB port board spare part kit does not include the USB port board bracket or USB port board cable. The USB port board cable is available using spare part number L20685-001.

Description	Spare part number
USB port board	L20698-001

Before removing the USB port board, follow these steps:

1. Shut down the computer. If you are unsure whether the computer is off or in Hibernation, turn the computer on, and then shut it down through the operating system.
2. Disconnect all external devices connected to the computer.
3. Disconnect the power from the computer by first unplugging the power cord from the AC outlet, and then unplugging the AC adapter from the computer.
4. Remove the bottom cover (see [Bottom cover on page 24](#)).
5. Remove the battery (see [Battery on page 26](#)).

Remove the USB port board:

1. Release the ZIF connector (1) to which USB port board cable is connected, and then disconnect the USB port board cable from the USB port board.
2. Remove the Phillips M2.0×4.1 screw (2) that secure the USB port board to the keyboard/top cover.
3. Remove the USB port board (3).

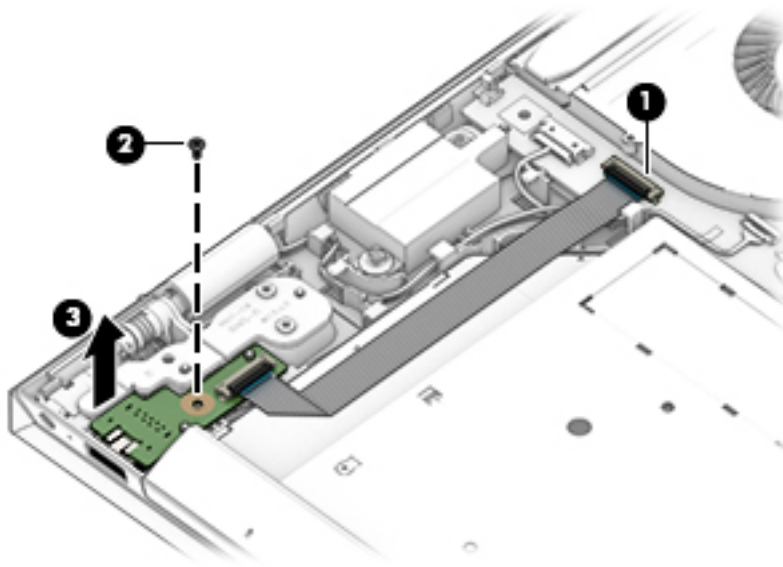

Reverse this procedure to install the USB port board.

Fan

Description	Spare part number
Fan (includes cable)	926724-001

Before removing the fan, follow these steps:

1. Shut down the computer. If you are unsure whether the computer is off or in Hibernation, turn the computer on, and then shut it down through the operating system.
2. Disconnect all external devices connected to the computer.
3. Disconnect the power from the computer by first unplugging the power cord from the AC outlet, and then unplugging the AC adapter from the computer.
4. Remove the bottom cover (see [Bottom cover on page 24](#)).
5. Remove the battery (see [Battery on page 26](#)).

Remove the fan:

1. Disconnect the fan cable (1) from the system board.
2. Remove the two Phillips M2.0×4.1 screws (2) that secure the fan to the keyboard/top cover.
3. Remove the fan (3).

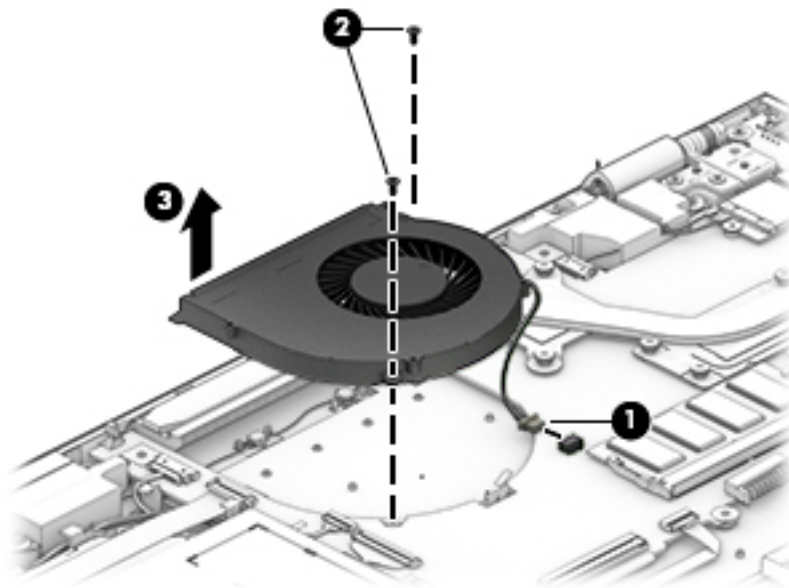

Reverse this procedure to install the fan.

Power connector cable

Description	Spare part number
Power connector cable	L20686-001

Before removing the fan, follow these steps:

1. Shut down the computer. If you are unsure whether the computer is off or in Hibernation, turn the computer on, and then shut it down through the operating system.
2. Disconnect all external devices connected to the computer.
3. Disconnect the power from the computer by first unplugging the power cord from the AC outlet, and then unplugging the AC adapter from the computer.
4. Remove the bottom cover (see [Bottom cover on page 24](#)).
5. Remove the battery (see [Battery on page 26](#)).
6. Remove the USB port board cable (see [USB port board cable on page 42](#)).

Remove the power connector cable:

1. Remove the two Phillips M2.5×5.7 screws (1) that secure the display right hinge to the keyboard/top cover.
2. Swing the display right hinge (2) up and back until the power connector cable is accessible.
3. Disconnect the power connector cable (3) from the system board.
4. Release the power connector from the retention clips (4) and routing channel built into the keyboard/top cover.
5. Remove the power connector cable (5).

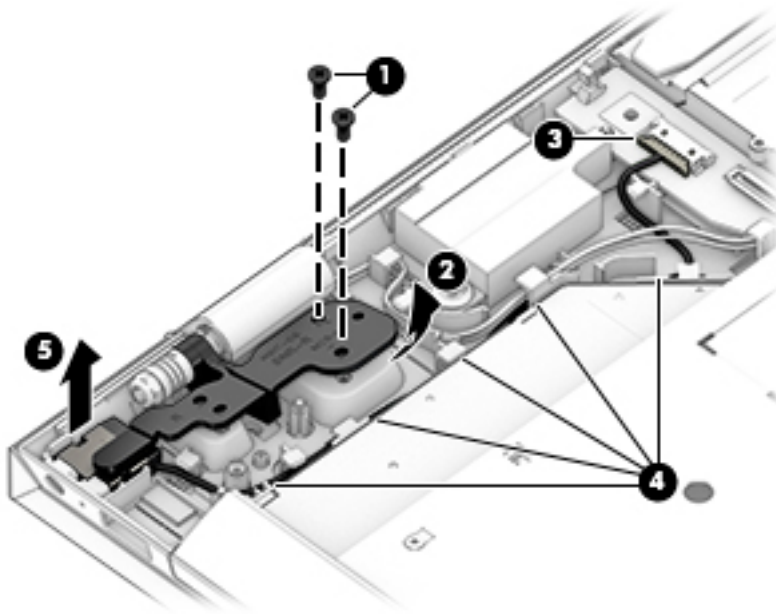

Reverse this procedure to install the power connector cable.

System board



NOTE: All system board spare part kits include a processor and replacement thermal material.

Description	Spare part number
Equipped with an Intel Core i7-8550U 1.80-GHz quad core processor (2400-MHz FSB, 8.0-MB L3 cache, 15.0-W), an NVIDIA N175-LG GeForce MX150 (256-MB×32, 2 pieces) GDDR5 graphics subsystem with 4096-MB video memory, and the Windows 10 operating system	L20713-601
Equipped with an Intel Core i7-8550U 1.80-GHz quad core processor (2400-MHz FSB, 8.0-MB L3 cache, 15.0-W), an NVIDIA N175-LG GeForce MX150 (256-MB×32, 2 pieces) GDDR5 graphics subsystem with 4096-MB video memory, and a non-Windows operating system	L20713-001
Equipped with an Intel Core i7-8550U 1.80-GHz quad core processor (2400-MHz FSB, 8.0-MB L3 cache, 15.0-W), an NVIDIA N175-LG GeForce MX150 (256-MB×32, 2 pieces) GDDR5 graphics subsystem with 2048-MB video memory, and the Windows 10 operating system	L20712-601
Equipped with an Intel Core i7-8550U 1.80-GHz quad core processor (2400-MHz FSB, 8.0-MB L3 cache, 15.0-W), an NVIDIA N175-LG GeForce MX150 (256-MB×32, 2 pieces) GDDR5 graphics subsystem with 2048-MB video memory, and a non-Windows operating system	L20712-001
Equipped with an Intel Core i5-8250U 1.60-GHz quad core processor (2400-MHz FSB, 6.0-MB L3 cache, 15.0-W), an NVIDIA N175-LG GeForce MX150 (256-MB×32, 2 pieces) GDDR5 graphics subsystem with 2048-MB video memory, and the Windows 10 operating system	L20711-601
Equipped with an Intel Core i5-8250U 1.60-GHz quad core processor (2400-MHz FSB, 6.0-MB L3 cache, 15.0-W), an NVIDIA N175-LG GeForce MX150 (256-MB×32, 2 pieces) GDDR5 graphics subsystem with 2048-MB video memory, and a non-Windows operating system	L20711-001

Before removing the system board, follow these steps:

1. Shut down the computer. If you are unsure whether the computer is off or in Hibernation, turn the computer on, and then shut it down through the operating system.
2. Disconnect all external devices connected to the computer.
3. Disconnect the power from the computer by first unplugging the power cord from the AC outlet, and then unplugging the AC adapter from the computer.
4. Remove the bottom cover (see [Bottom cover on page 24](#)), and then remove the following components:
 - a. Battery (see [Battery on page 26](#))
 - b. Optical drive (see [Optical drive on page 41](#))
 - c. Fan (see [Fan on page 44](#))

When replacing the system board, be sure to remove the following components from the defective system board and install them on the replacement system board:

- Solid-state drive (see [Solid-state drive on page 29](#))
- Memory module (see [Memory module on page 30](#))
- WLAN module (see [WLAN module on page 32](#))
- Heat sink (see [Heat sink on page 49](#))

Remove the system board:

1. Disconnect the following:
 - (1) Power connector cable

- (2) USB port board ZIF connector cable
- (3) Adhesive tape securing the Webcam cable to the system board
- (4) Webcam ZIF connector cable
- (5) Display panel ZIF connector cable
- (6) Hard drive ZIF connector cable
- (7) Backlight ZIF connector cable
- (8) Keyboard ZIF connector cable
- (9) Fingerprint reader ZIF connector cable
- (10) TouchPad ZIF connector cable
- (11) SD card board ZIF connector cable
- (12) WLAN antenna cables

 **NOTE:** The #1/white WLAN antenna cable connects to the WLAN module "#1/Main" terminal. The #2/black WLAN antenna cable connects to the WLAN module "#2/Aux" terminal.

- (13) Speaker cable

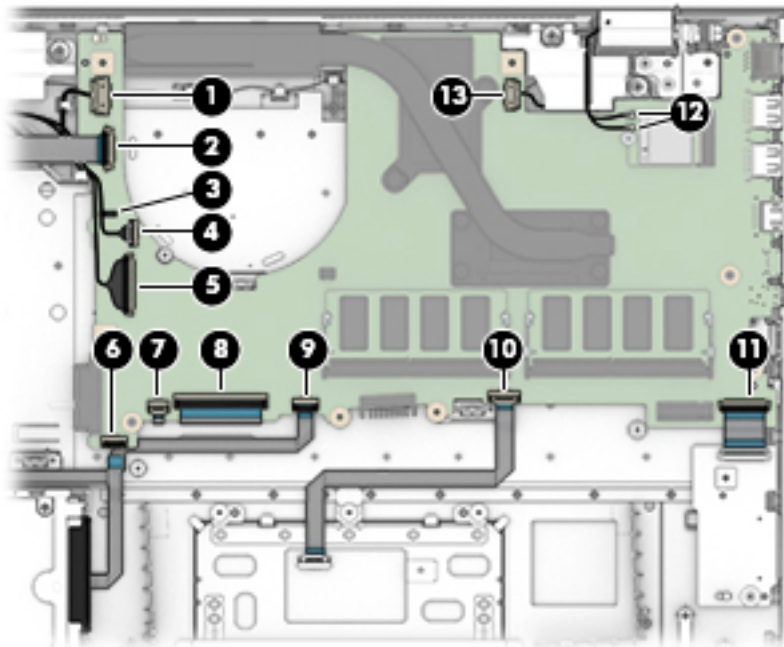

2. Remove the four Phillips M2.0×4.1 screws that secure the system board to the keyboard/top cover.

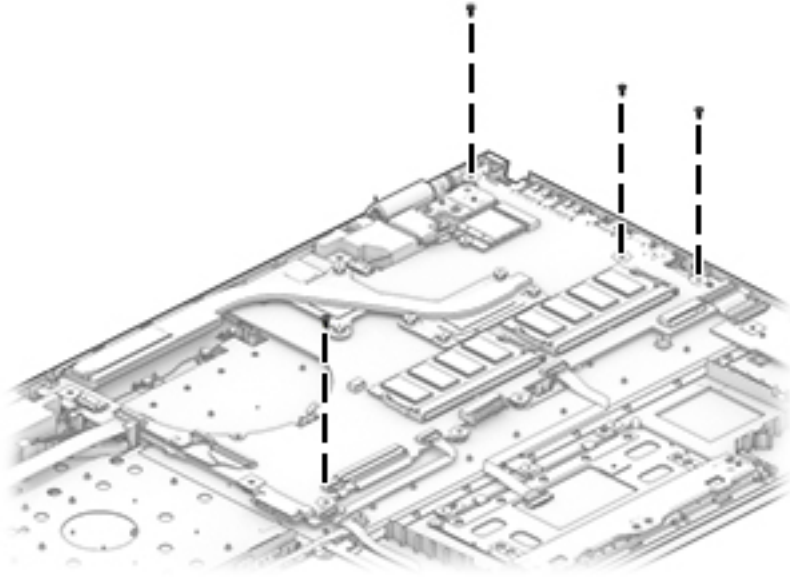

3. Release the system board (1) by lifting the left side until it rests at an angle.
4. Remove the system board (2) by sliding it up and to the left at an angle.

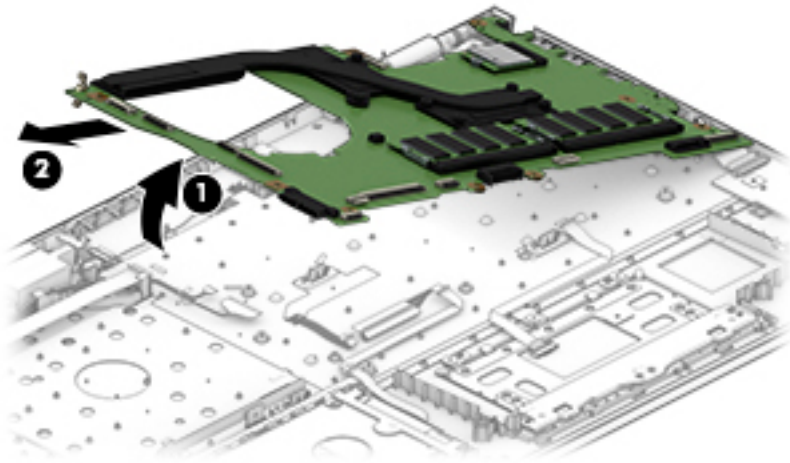

5. Remove the system board.

Reverse this procedure to install the system board.

Heat sink

Description	Spare part number
Heat sink (includes replacement thermal material)	L20687-001

Before removing the heat sink, follow these steps:

1. Turn off the computer. If you are unsure whether the computer is off or in Hibernation, turn the computer on, and then shut it down through the operating system.
2. Disconnect the power from the computer by first unplugging the power cord from the AC outlet, and then unplugging the AC adapter from the computer.
3. Disconnect all external devices from the computer.
4. Remove the bottom cover (see [Bottom cover on page 24](#)), and then remove the following components:
 - a. Battery (see [Battery on page 26](#))
 - b. Optical drive (see [Optical drive on page 41](#))
 - c. Fan (see [Fan on page 44](#))
 - d. System board (see [System board on page 46](#))

Remove the heat sink:

1. Loosen the six Phillips M2.0×6.3 captive screws (1) that secure the heat sink to the system board.
2. Remove the heat sink (2).

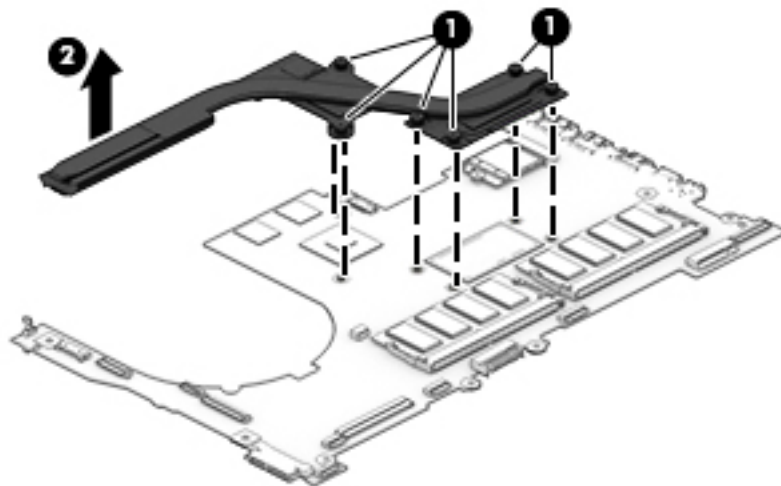

 **NOTE:** The thermal material must be thoroughly cleaned from the surfaces of the heat sink and the system board components each time the heat sink is removed. Replacement thermal material is included with the heat sink and system board spare part kits.

Thermal paste is used on the processor (1) and the heat sink section (2) that services it. Thermal paste is also used on the graphics subsystem component (3) and the heat sink section (4) that services it.

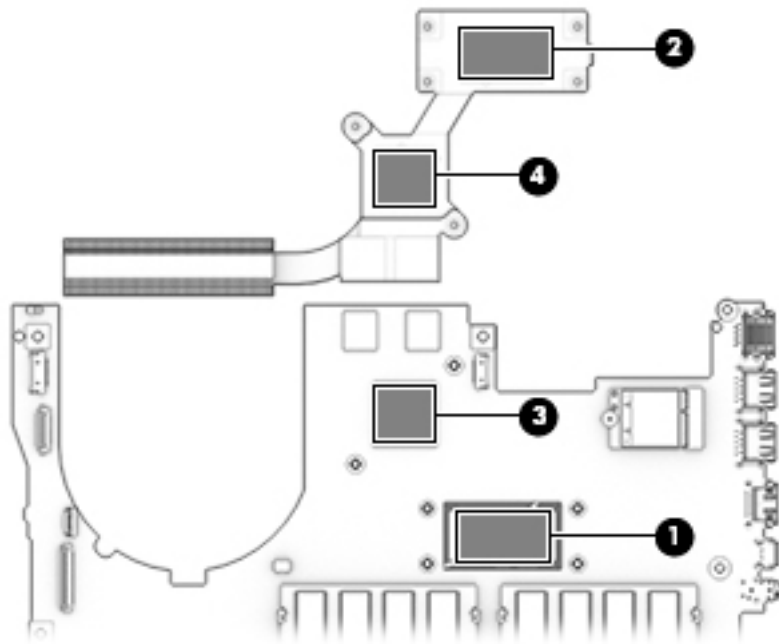

Reverse this procedure to install the heat sink.

Speakers

Description	Spare part number
Speakers (include left and right speakers, cables, and four rubber isolators)	L20705-001

Before removing the speakers, follow these steps:

1. Turn off the computer. If you are unsure whether the computer is off or in Hibernation, turn the computer on, and then shut it down through the operating system.
2. Disconnect the power from the computer by first unplugging the power cord from the AC outlet, and then unplugging the AC adapter from the computer.
3. Disconnect all external devices from the computer.
4. Remove the bottom cover (see [Bottom cover on page 24](#)), and then remove the following components:
 - a. Battery (see [Battery on page 26](#))
 - b. Optical drive (see [Optical drive on page 41](#))
 - c. Fan (see [Fan on page 44](#))
 - d. System board (see [System board on page 46](#))

Remove the speakers:

1. Release the speaker cable (1) from the retention clips built into the keyboard/top cover.
2. Remove the speakers (2).

 **NOTE:** When removing the speakers, make note of the location and condition of the four rubber isolators (3). These isolators are critical to the performance of the speakers. The absence of these isolators or damage to them can degrade the speaker performance.

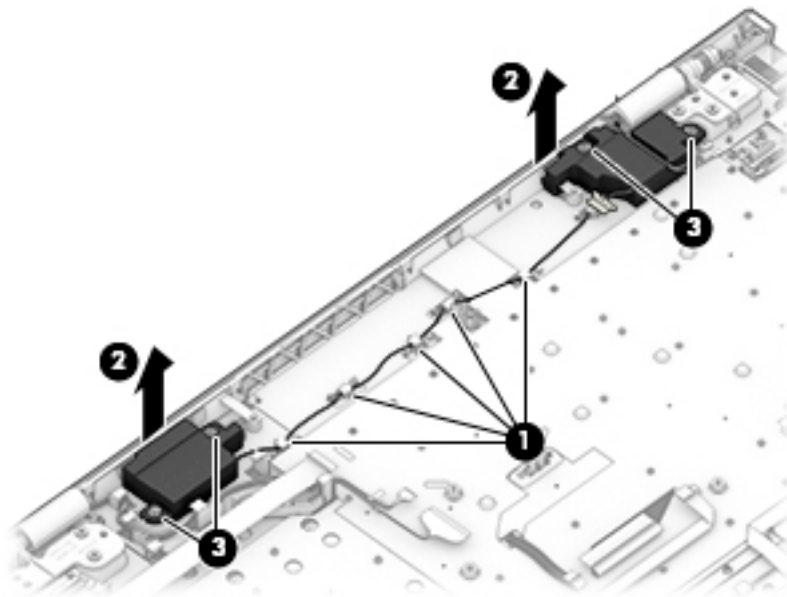

Reverse this procedure to install the speakers.

Display assembly

Description	Spare part number
17.3-in., FHD, AntiGlare (1920×1080), LCD, WLED, UWVA, 72 300, eDP, flat, 4.0t TouchScreen display assembly	L20694-001
17.3-in., UHD, AntiGlare (3840×2160), LCD, WLED, UWVA 72 300, eDP 1.2, flat, non-TouchScreen display assembly	L20696-001
17.3-in., FHD, AntiGlare, DBCG non-TouchScreen display assembly	L20695-001

Before removing the display assembly, follow these steps:

1. Shut down the computer. If you are unsure whether the computer is off or in Hibernation, turn the computer on, and then shut it down through the operating system.
2. Disconnect all external devices connected to the computer.
3. Disconnect the power from the computer by first unplugging the power cord from the AC outlet, and then unplugging the AC adapter from the computer.
4. Remove the bottom cover (see [Bottom cover on page 24](#)).
5. Disconnect the battery cable from the system board (see [Battery on page 26](#)).

Remove the display assembly:

1. Release the adhesive strip **(1)** that secures the webcam/microphone cable to the system board.
2. Release the ZIF connector **(2)** to which webcam/microphone cable is connected, and then disconnect the webcam/microphone cable from the system board.
3. Release the ZIF connector **(3)** to which display panel cable is connected, and then disconnect the display panel cable from the system board.
4. Release the webcam/microphone cable and the display panel cable from the retention clips **(4)** and routing channel built into the keyboard/top cover.
5. Disconnect the WLAN antenna cables **(5)** from the terminals on the WLAN module.



NOTE: The WLAN antenna cable labeled "1/MAIN" connects to the WLAN module "Main" terminal. The WLAN antenna cable labeled "2/AUX" connects to the WLAN module "Aux" terminal.

6. Release the WLAN antenna cables from the retention clips **(6)** and routing channel built into the keyboard/top cover.

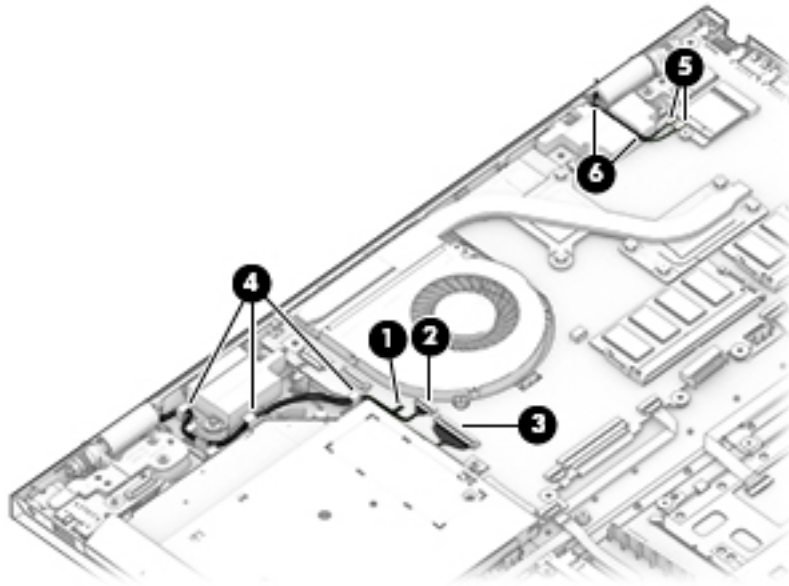

7. Remove the four Phillips M2.5×5.7 screws that secure the display hinges to the keyboard/top cover.

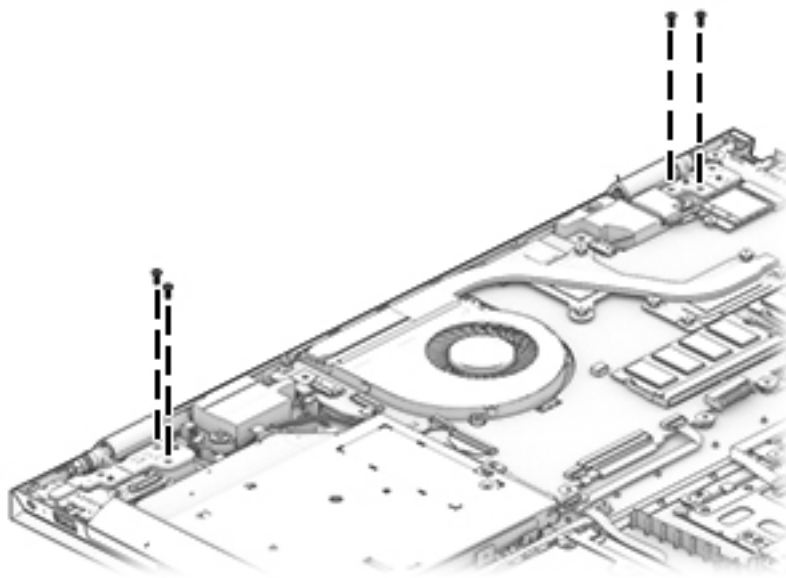

8. Lift the front edge of the keyboard/top cover **(1)** until it rests at an angle.

9. Slide the keyboard/top cover (2) up and away at an angle and separate it from the display assembly.



Reverse this procedure to install the display assembly.

6 Using Setup Utility (BIOS)

Setup Utility, or Basic Input/Output System (BIOS), controls communication between all the input and output devices on the system (such as disk drives, display, keyboard, mouse, and printer). Setup Utility (BIOS) includes settings for the types of devices installed, the startup sequence of the computer, and the amount of system and extended memory.

 **NOTE:** To start Setup Utility on convertible computers, the computer must be in notebook mode and the keyboard must be attached to the notebook.

Starting Setup Utility (BIOS)

 **CAUTION:** Use extreme care when making changes in Setup Utility (BIOS). Errors can prevent the computer from operating properly.

- ▲ Turn on or restart the computer, quickly press `esc`, and then press `f10`.

Updating Setup Utility (BIOS)

Updated versions of Setup Utility (BIOS) may be available on the HP website.

Most BIOS updates on the HP website are packaged in compressed files called SoftPaqs.

Some download packages contain a file named `Readme.txt`, which contains information regarding installing and troubleshooting the file.

Determining the BIOS version

To decide whether Setup Utility (BIOS) needs to be updated, first determine the BIOS version on the computer.

To reveal the BIOS version information (also known as ROM date and System BIOS), use one of these options.

- HP Support Assistant
 1. Type `support` in the taskbar search box, and then select the **HP Support Assistant** app.
– or –
Click the question mark icon in the taskbar.
 2. Select **My PC**, and then select **Specifications**.
- Setup Utility (BIOS)
 1. Start Setup Utility (BIOS) (see [Starting Setup Utility \(BIOS\) on page 55](#)).
 2. Select **Main**, select **System Information**, and then make note of the BIOS version.
 3. Select **Exit**, select **No**, and then follow the on-screen instructions.

To check for later BIOS versions, see [Downloading a BIOS update on page 56](#).

Downloading a BIOS update

 **CAUTION:** To reduce the risk of damage to the computer or an unsuccessful installation, download and install a BIOS update only when the computer is connected to reliable external power using the AC adapter. Do not download or install a BIOS update while the computer is running on battery power, docked in an optional docking device, or connected to an optional power source. During the download and installation, follow these instructions:

- Do not disconnect power from the computer by unplugging the power cord from the AC outlet.
- Do not shut down the computer or initiate Sleep.
- Do not insert, remove, connect, or disconnect any device, cable, or cord.

 **NOTE:** If the computer is connected to a network, consult the network administrator before installing any software updates, especially system BIOS updates.

1. Type `support` in the taskbar search box, and then select the **HP Support Assistant** app.
– or –
Click the question mark icon in the taskbar.
2. Click **Updates**, and then click **Check for updates and messages**.
3. Follow the on-screen instructions.
4. At the download area, follow these steps:
 - a. Identify the most recent BIOS update and compare it to the BIOS version currently installed on the computer. If the update is more recent than the BIOS version, make a note of the date, name, or other identifier. You may need this information to locate the update later, after it has been downloaded to the hard drive.
 - b. Follow the on-screen instructions to download the selection to the hard drive. Make a note of the path to the location on the hard drive where the BIOS update is downloaded. This path will be needed when it is time to install the update.

BIOS installation procedures vary. Follow any instructions that appear on the screen after the download is complete. If no instructions appear, follow these steps:

1. Type `file` in the taskbar search box, and then select **File Explorer**.
2. Click the hard drive designation. The hard drive designation is typically Local Disk (C:).
3. Using the hard drive path recorded earlier, open the folder that contains the update.
4. Double-click the file that has an `.exe` extension (for example, `filename.exe`).
The BIOS installation begins.
5. Complete the installation by following the on-screen instructions.

 **NOTE:** After a message on the screen reports a successful installation, the downloaded file can be deleted from the hard drive.

7 Using HP PC Hardware Diagnostics

HP PC Hardware Diagnostics Windows is a Windows-based utility that allows diagnostic tests to be run to determine whether the computer hardware is functioning properly. The tool runs within the Windows operating system in order to diagnose hardware failures.

If HP PC Hardware Diagnostics Windows is not installed on the computer, it must first be downloaded and installed. To download HP PC Hardware Diagnostics Windows, see [Downloading HP PC Hardware Diagnostics Windows on page 58](#).

After HP PC Hardware Diagnostics Windows is installed, follow these steps to access it from HP Help and Support or HP Support Assistant.

1. To access HP PC Hardware Diagnostics Windows from HP Help and Support:
 - a. Select the **Start** button, and then select **HP Help and Support**.
 - b. Right-click **HP PC Hardware Diagnostics Windows**, select **More**, and then select **Run as administrator**.
– or –
To access HP PC Hardware Diagnostics Windows from HP Support Assistant:
 - a. Type `support` in the taskbar search box, and then select the **HP Support Assistant** app.
– or –
Select the question mark icon in the taskbar.
 - b. Select **Troubleshooting and fixes**.
 - c. Select **Diagnostics**, and then select **HP PC Hardware Diagnostics Windows**.
2. When the tool opens, select the type of diagnostic test to be run, and then follow the on-screen instructions.

 **NOTE:** If a diagnostic test needs to be stopped at any time, select **Cancel**.

3. When HP PC Hardware Diagnostics Windows detects a failure that requires hardware replacement, a 24-digit Failure ID code is generated. For assistance in correcting the problem, contact support, and then provide the Failure ID code.

Downloading HP PC Hardware Diagnostics Windows

- The HP PC Hardware Diagnostics Windows download instructions are provided in English only.
- A Windows computer must be used to download this tool because only .exe files are provided.

Downloading the latest HP PC Hardware Diagnostics Windows version

To download HP PC Hardware Diagnostics Windows, follow these steps:

1. Go to <http://www.hp.com/go/techcenter/pcdiags>.
The HP PC Diagnostics home page is displayed.
2. In the HP PC Hardware Diagnostics section, select **Download**, and then select the installation location:
To run the tool on the computer, download it to the computer desktop.
– or –
To run the tool from a USB flash drive, download it to a USB flash drive.
3. Select **Run**.

Downloading HP Hardware Diagnostics Windows by product name or number (products only)



NOTE: For some products, it may be necessary to download the software to a USB flash drive by using the product name or number.

To download HP PC Hardware Diagnostics Windows by product name or number (select products only), follow these steps:

1. Go to <http://www.hp.com/support>.
2. Select **Get software and drivers**, and then enter the product name or number.
3. In the HP PC Hardware Diagnostics section, select **Download**, and then select the installation location:
To run the tool on the computer, download it to the computer desktop.
– or –
To run the tool from a USB flash drive, download it to a USB flash drive.
4. Select **Run**.

Installing HP PC Hardware Diagnostics Windows

To install HP PC Hardware Diagnostics Windows, follow these steps:

- ▲ Navigate to the folder on the computer or the flash drive where the .exe file was downloaded, doubleclick the .exe file, and then follow the on-screen instructions.

Using HP PC Hardware Diagnostics UEFI

HP PC Hardware Diagnostics UEFI (Unified Extensible Firmware Interface) allows diagnostic tests to be run to determine whether the computer hardware is functioning properly. The tool runs outside the operating system so that it can isolate hardware failures from issues that are caused by the operating system or other software components.

If the PC will not boot into Windows, use HP PC Hardware Diagnostics UEFI to diagnose hardware issues.

When HP PC Hardware Diagnostics UEFI detects a failure that requires hardware replacement, a 24-digit Failure ID code is generated. For assistance in correcting the problem, contact support, and provide the Failure ID code.

 **NOTE:** To start diagnostics on a convertible computer, the computer must be in notebook mode, and the attached keyboard must be used.

 **NOTE:** If a diagnostic test needs to be stopped, press [esc](#).

Starting HP PC Hardware Diagnostics UEFI

To start HP PC Hardware Diagnostics UEFI, follow these steps:

1. Turn on or restart the computer, and quickly press [esc](#).
2. Press [f2](#).

The BIOS searches three places for the diagnostic tools, in the following order:

- a. Connected USB flash drive

 **NOTE:** To download the HP PC Hardware Diagnostics UEFI tool to a USB flash drive, see [Downloading the latest HP PC Hardware Diagnostics UEFI version on page 60](#).

- b. Hard drive
- c. BIOS

3. When the diagnostic tool opens, select the type of diagnostic test to be run, and then follow the on-screen instructions.

Downloading HP PC Hardware Diagnostics UEFI to a USB flash drive

Downloading HP PC Hardware Diagnostics UEFI to a USB flash drive can be useful in the following situations:

- HP PC Hardware Diagnostics UEFI is not included in the preinstall image.
- HP PC Hardware Diagnostics UEFI is not included in the HP Tool partition.
- The hard drive is damaged.



NOTE: The HP PC Hardware Diagnostics UEFI download instructions are provided in English only, and a Windows computer must be used to download and create the HP UEFI support environment because only .exe files are provided.

Downloading the latest HP PC Hardware Diagnostics UEFI version

To download the latest HP PC Hardware Diagnostics UEFI version to a USB flash drive:

1. Go to <http://www.hp.com/go/techcenter/pcdiags>.
The HP PC Diagnostics home page is displayed.
2. In the HP PC Hardware Diagnostics UEFI section, select **Download UEFI Diagnostics**, and then select **Run**.

Downloading HP PC Hardware Diagnostics UEFI by product name (products only)



NOTE: For some products, it may be necessary to download the software to a USB flash drive by using the product name.

To download HP PC Hardware Diagnostics UEFI by product name (products only) to a USB flash drive:

1. Go to <http://www.hp.com/support>.
2. Select **Software and drivers**, enter the product name, select the computer, and then select the operating system.
3. Under **Diagnostics**, follow the on-screen instructions to select and download the **HP PC Hardware Diagnostics UEFI** version for the product.



NOTE: If a diagnostic test needs to be stopped, press **esc**.

Using Remote HP PC Hardware Diagnostics UEFI settings (products only)

Remote HP PC Hardware Diagnostics UEFI is a firmware (BIOS) feature that downloads HP PC Hardware Diagnostics UEFI to the computer. It can then execute the diagnostics on the computer, and it may upload results to a preconfigured server. For more information on Remote HP PC Hardware Diagnostics UEFI, go to <http://www.hp.com/go/techcenter/pcdiags>, and then select **Find out more**.

Downloading Remote HP PC Hardware Diagnostics UEFI

 **NOTE:** HP Remote PC Hardware Diagnostics UEFI is also available as a Softpaq that can be downloaded to a server.

Downloading the latest Remote HP PC Hardware Diagnostics UEFI version

To download the latest Remote HP PC Hardware Diagnostics UEFI version, follow these steps:

1. Go to <http://www.hp.com/go/techcenter/pcdiags>.
The HP PC Diagnostics home page is displayed.
2. In the **HP PC Hardware Diagnostics UEFI** section, select **Download Remote Diagnostics**, and then select **Run**.

Downloading Remote HP PC Hardware Diagnostics UEFI by product name

 **NOTE:** For some products, it may be necessary to download the software by using the product name.

To download HP Remote PC Hardware Diagnostics UEFI by product name or number, follow these steps:

1. Go to <http://www.hp.com/support>.
2. Select **Get software and drivers**, enter the product name or number, select the computer, and then select the operating system.

Select **Software and drivers**, enter the product name, select the computer, and then select the operating system.
3. In the **Diagnostics** section, follow the on-screen instructions to select and download the **Remote UEFI** version for the product.

Customizing Remote HP PC Hardware Diagnostics UEFI settings

Using the Remote HP PC Hardware Diagnostics setting in Computer Setup (BIOS), the following customizations can be performed:

- Set a schedule for running diagnostics unattended. Diagnostics can also be started immediately in interactive mode by selecting **Execute Remote HP PC Hardware Diagnostics**.
- Set the location for downloading the diagnostic tools. This feature provides access to the tools from the HP website or from a server that has been preconfigured for use. The computer does not require the traditional local storage (such as a disk drive or USB flash drive) to run remote diagnostics.
- Set a location for storing the test results. The user name and password settings to be used for uploads can also be set.
- Display status information about the diagnostics run previously.

To customize Remote HP PC Hardware Diagnostics UEFI settings, follow these steps:

1. Turn on or restart the computer, and when the HP logo appears, press **f10** to enter Computer Setup.
2. Select **Advanced**, and then select **Settings**.
3. Make customization selections.
4. Select **Main**, and then **Save Changes and Exit** to save settings.

System changes take effect when the computer restarts.

8 Specifications

	Metric	U.S.
Dimensions		
Width	41.6 cm	16.4 in.
Depth	27.8 cm	10.9 in.
Height (front to back)	2.3 cm	0.9 in.
Weight:		
Equipped with a hard drive and an optical drive	3.0 g	6.6 lbs.
Equipped with a hard drive	2.9 g	6.4 lbs.
Temperature		
Operating	5°C to 35°C	41°F to 95°F
Nonoperating	-20°C to 60°C	-4°F to 140°F
Relative humidity (noncondensing)		
Operating	10% to 90%	
Nonoperating	5% to 95%	
Maximum altitude (unpressurized)		
Operating	-15 m to 3,048 m	-50 ft to 10,000 ft
Nonoperating	-15 m to 12,192 m	-50 ft to 40,000 ft
NOTE: Applicable product safety standards specify thermal limits for plastic surfaces. The device operates well within this range of temperatures.		

9 Backing up, restoring, and recovering

This chapter provides information about the following processes, which are standard procedure for most products:

- **Backing up your personal information**—You can use Windows tools to back up your personal information (see Using Windows tools on page 51).
- **Creating a restore point**—You can use Windows tools to create a restore point (see Using Windows tools on page 51).
- **Creating recovery media** (select products only)—You can use HP Recovery Manager or HP Cloud Recovery Download Tool (select products only) to create recovery media (see Creating HP Recovery media (select products only) on page 51).
- **Restoring and recovery**—Windows offers several options for restoring from backup, refreshing the computer, and resetting the computer to its original state (see Using Windows tools on page 51).
- **Removing the Recovery Partition**—To remove the Recovery partition to reclaim hard drive space (select products only), select the Remove Recovery Partition option of HP Recovery Manager. For more information, see Removing the HP Recovery partition (select products only) on page 55.

Using Windows tools

 **IMPORTANT:** Windows is the only option that allows you to back up your personal information. Schedule regular backups to avoid information loss.

You can use Windows tools to back up personal information and create system restore points and recovery media, allowing you to restore from backup, refresh the computer, and reset the computer to its original state.

 **NOTE:** If computer storage is 32 GB or less, Microsoft System Restore is disabled by default.

For more information and steps, see the Get Help app.

- ▲ Select the **Start** button, and then select the **Get Help** app.

 **NOTE:** An Internet connection is required to access the Get Help app.

Creating HP Recovery media (select products only)

After you have successfully set up the computer, use HP Recovery Manager to create a backup of the HP Recovery partition on the computer. This backup is called HP Recovery media. In cases where the hard drive is corrupted or has been replaced, the HP Recovery media can be used to reinstall the original operating system.

To check for the presence of the Recovery partition in addition to the Windows partition, right-click the **Start** button, select **File Explorer**, and then select **This PC**.

 **NOTE:** If your computer does not list the Recovery partition in addition to the Windows partition, contact support to obtain recovery discs. Go to <http://www.hp.com/support>, select your country or region, and then follow the on-screen instructions.

On select products, you can use the HP Cloud Recovery Download Tool to create HP Recovery media on a bootable USB flash drive. For more information, see Using the HP Cloud Recovery Download Tool to create recovery media on page 53.

Using HP Recovery Manager to create recovery media

 **NOTE:** If you cannot create recovery media yourself, contact support to obtain recovery discs. Go to <http://www.hp.com/support>, select your country or region, and then follow the on-screen instructions.

Before you begin

Before you begin, note the following:

- Only one set of recovery media can be created. Handle these recovery tools carefully, and keep them in a safe place.
- HP Recovery Manager examines the computer and determines the required media storage capacity.
- To create recovery media, use one of the following options:

 **NOTE:** If the computer does not have a recovery partition, HP Recovery Manager displays the Windows Create a Recovery Drive feature. Follow the on-screen instructions to create a recovery image on a blank USB flash drive or hard drive.

- If your computer has an optical drive with DVD writer capability, be sure to use only high-quality blank DVD-R, DVD+R, DVD-R DL, or DVD+R DL discs. Do not use rewritable discs such as CD±RW, DVD±RW, double-layer DVD±RW, or BD-RE (rewritable Blu-ray) discs, which are not compatible with HP Recovery Manager software.
- If your computer does not include an integrated optical drive with DVD writer capability, you can use an external optical drive (purchased separately) to create recovery discs, as described above. If an external optical drive is used, you must connect it directly to a USB port on the computer. It cannot be connected to a USB port on an external device, such as a USB hub.
- To create a recovery flash drive, use a high-quality blank USB flash drive.
- Be sure that the computer is connected to AC power before you begin creating the recovery media.
- The creation process can take an hour or more. Do not interrupt this process.
- If necessary, you can exit the program before you have finished creating all of the recovery media. HP Recovery Manager will finish the current DVD or flash drive. The next time you start HP Recovery Manager, you will be prompted to continue.

Creating the recovery media

To create HP Recovery media using HP Recovery Manager:

 **IMPORTANT:** For a tablet with a detachable keyboard, connect the tablet to the keyboard base before beginning these steps.

1. Type `recovery` in the taskbar search box, and then select **HP Recovery Manager**.
2. Select **Create recovery media**, and then follow the on-screen instructions.

If you need to recover the system, see Recovering using HP Recovery Manager on page 53.

Using the HP Cloud Recovery Download Tool to create recovery media

To create HP Recovery media using the HP Cloud Recovery Download Tool:

1. Go to <http://www.hp.com/support>.
2. Select **Software and Drivers**, and then follow the on-screen instructions.

Restoring and recovery

Restoring and recovery can be performed using one or more of the following options: Windows tools, HP Recovery Manager, or the HP Recovery partition.

 **IMPORTANT:** Not all methods are available on all products.

Restoring, resetting, and refreshing using Windows tools

Windows offers several options for restoring, resetting, and refreshing the computer. For details, see Using Windows tools on page 51.

Restoring using HP Recovery Manager and the HP Recovery partition

You can use HP Recovery Manager and the HP Recovery partition (select products only) to restore the computer to the original factory state:

- **Resolving problems with preinstalled applications or drivers**—To correct a problem with a preinstalled application or driver:
 1. Type `recovery` in the taskbar search box, and then select **HP Recovery Manager**.
 2. Select **Reinstall drivers and/or applications**, and then follow the on-screen instructions.
- **Using System Recovery**—To recover the Windows partition to original factory content, select the **System Recovery** option from the HP Recovery partition (select products only) or use the HP Recovery media. For more information, see Recovering using HP Recovery Manager on page 53. If you have not already created recovery media, see Creating HP Recovery media (select products only) on page 51.
- **Using Factory Reset** (select products only)—Restores the computer to its original factory state by deleting all information from the hard drive and recreating the partitions and then reinstalling the operating system and the software that was installed at the factory (select products only). To use the **Factory Reset** option, you must use HP Recovery media. If you have not already created recovery media, see Creating HP Recovery media (select products only) on page 51.

 **NOTE:** If you have replaced the hard drive in the computer, you can use the Factory Reset option to install the operating system and the software that was installed at the factory.

Recovering using HP Recovery Manager

You can use HP Recovery Manager software to recover the computer to its original factory state by using the HP Recovery media that you either created or that you obtained from HP, or by using the HP Recovery partition (select products only).

If you have not already created HP Recovery media, see [Creating HP Recovery media \(select products only\)](#) on page 51.

 **IMPORTANT:** HP Recovery Manager does not automatically provide backups of your personal data. Before beginning recovery, back up any personal data that you want to retain. See [Using Windows tools](#) on page 51.

IMPORTANT: Recovery through HP Recovery Manager should be used as a final attempt to correct computer issues.

 **NOTE:** Recovery through HP Recovery Manager should be used as a final attempt to correct computer issues.

Before you begin, note the following:

- HP Recovery Manager recovers only software that was installed at the factory. For software not provided with this computer, you must either download the software from the manufacturer's website or reinstall the software from the media provided by the manufacturer.
- If the computer hard drive fails, HP Recovery media must be used. This media is created using HP Recovery Manager. See [Creating HP Recovery media \(select products only\)](#) on page 51.
- If your computer does not allow the creation of HP Recovery media or if the HP Recovery media does not work, contact support to obtain recovery media. Go to <http://www.hp.com/support>, select your country or region, and then follow the on-screen instructions.

Recovering using the HP Recovery partition (select products only)

The HP Recovery partition allows you to perform a system recovery without recovery discs or a recovery USB flash drive. This type of recovery can be used only if the hard drive is still working.

The HP Recovery partition (select products only) allows System Recovery only.

To start HP Recovery Manager from the HP Recovery partition:

 **IMPORTANT:** For a tablet with a detachable keyboard, connect the tablet to the keyboard base before beginning these steps (select products only).

1. Type `recovery` in the taskbar search box, select **HP Recovery Manager**, and then select **Windows Recovery Environment**.

– or –

For computers or tablets with keyboards attached:

- ▲ Press **f11** while the computer boots, or press and hold **f11** as you press the power button.

For tablets without keyboards:

- ▲ Turn on or restart the tablet, quickly hold down the volume up button, and then select **f11**.

2. Select **Troubleshoot** from the boot options menu.
3. Select **Recovery Manager**, and then follow the on-screen instructions.

 **NOTE:** If your computer does not automatically restart in HP Recovery Manager, change the computer boot order, and then follow the on-screen instructions. See [Changing the computer boot order](#) on page 55.

Recovering using HP Recovery media

If your computer does not have an HP Recovery partition or if the hard drive is not working properly, you can use HP Recovery media to recover the original operating system and software programs that were installed at the factory.

- ▲ Insert the HP Recovery media, and then restart the computer.

 **NOTE:** If your computer does not automatically restart in HP Recovery Manager, change the computer boot order, and then follow the on-screen instructions. See [Changing the computer boot order](#) on page 55.

Changing the computer boot order

If your computer does not restart in HP Recovery Manager, you can change the computer boot order. This is the order of devices listed in BIOS where the computer looks for startup information. You can change the selection to an optical drive or a USB flash drive, depending on the location of your HP Recovery media.

To change the boot order:

 **IMPORTANT:** For a tablet with a detachable keyboard, connect the tablet to the keyboard base before beginning these steps.

1. Insert the HP Recovery media.
2. Access the system **Startup** menu.

For computers or tablets with keyboards attached:

- ▲ Turn on or restart the computer or tablet, quickly press **esc**, and then press **f9** for boot options.

For tablets without keyboards:

- ▲ Turn on or restart the tablet, quickly hold down the volume up button, and then select **f9**.

– or –

Turn on or restart the tablet, quickly hold down the volume down button, and then select **f9**.

3. Select the optical drive or USB flash drive from which you want to boot, and then follow the on-screen instructions.

Removing the HP Recovery partition (select products only)

HP Recovery Manager software allows you to remove the HP Recovery partition (select products only) to free up hard drive space.

 **IMPORTANT:** After you remove the HP Recovery partition, you will not be able to perform System Recovery or create HP Recovery media. Before removing the Recovery partition, create HP Recovery media. See [Creating HP Recovery media \(select products only\)](#) on page 51.

Follow these steps to remove the HP Recovery partition:

1. Type `recovery` in the taskbar search box, and then select **HP Recovery Manager**.
2. Select **Remove Recovery Partition**, and then follow the on-screen instructions.

10 Power cord set requirements

The wide-range input feature of the computer permits it to operate from any line voltage from 100 to 120 volts AC, or from 220 to 240 volts AC.

The 3-conductor power cord set included with the computer meets the requirements for use in the country or region where the equipment is purchased.

Power cord sets for use in other countries and regions must meet the requirements of the country or region where the computer is used.

Requirements for all countries

The following requirements are applicable to all countries and regions:

- The length of the power cord set must be at least 1.0 m (3.3 ft) and no more than 2.0 m (6.5 ft).
- All power cord sets must be approved by an acceptable accredited agency responsible for evaluation in the country or region where the power cord set will be used.
- The power cord sets must have a minimum current capacity of 10 amps and a nominal voltage rating of 125 or 250 V AC, as required by the power system of each country or region.
- The appliance coupler must meet the mechanical configuration of an EN 60 320/IEC 320 Standard Sheet C13 connector for mating with the appliance inlet on the back of the computer. Requirements for all countries 113

Requirements for specific countries and regions

Country/region	Accredited agency	Applicable note number
Australia	EANSW	1
Austria	OVE	1
Belgium	CEBC	1
Canada	CSA	2
Denmark	DEMKO	1
Finland	FIMKO	1
France	UTE	1
Germany	VDE	1
Italy	IMQ	1
Japan	METI	3
The Netherlands	KEMA	1
Norway	NEMKO	1
The People's Republic of China	COC	5

Country/region	Accredited agency	Applicable note number
South Korea	EK	4
Sweden	CEMKO	1
Switzerland	SEV	1
Taiwan	BSMI	4
The United Kingdom	BSI	1
The United States	UL	2

1. The flexible cord must be Type H05VV-F, 3-conductor, 1.0-mm² conductor size. Power cord set fittings (appliance coupler and wall plug) must bear the certification mark of the agency responsible for evaluation in the country or region where it will be used.
2. The flexible cord must be Type SPT-3 or equivalent, No. 18 AWG, 3-conductor. The wall plug must be a two-pole grounding type with a NEMA 5-15P (15 A, 125 V) or NEMA 6-15P (15 A, 250 V) configuration.
3. The appliance coupler, flexible cord, and wall plug must bear a “T” mark and registration number in accordance with the Japanese Dentori Law. The flexible cord must be Type VCT or VCTF, 3-conductor, 1.00-mm² conductor size. The wall plug must be a two-pole grounding type with a Japanese Industrial Standard C8303 (7 A, 125 V) configuration.
4. The flexible cord must be Type RVV, 3-conductor, 0.75-mm² conductor size. Power cord set fittings (appliance coupler and wall plug) must bear the certification mark of the agency responsible for evaluation in the country or region where it will be used.
5. The flexible cord must be Type VCTF, 3-conductor, 0.75-mm² conductor size. Power cord set fittings (appliance coupler and wall plug) must bear the certification mark of the agency responsible for evaluation in the country or region where it will be used.

11 Recycling

When a non-rechargeable or rechargeable battery has reached the end of its useful life, do not dispose of the battery in general household waste. Follow the local laws and regulations in your area for battery disposal.

HP encourages customers to recycle used electronic hardware, HP original print cartridges, and rechargeable batteries. For more information about recycling programs, see the HP Web site at <http://www.hp.com/recycle>.

Index

- A**
 - AC adapter light 4
 - AC adapter, spare part numbers 16
 - adapter, spare part numbers 16
 - antenna, location 6
 - audio, product description 1
 - audio-in jack 5
 - audio-out jack 5
- B**
 - battery
 - removal 26
 - spare part number 15, 26
 - battery light 4
 - bottom component 10
 - bottom cover
 - removal 24
 - spare part number 16, 24
 - button components 9
 - buttons
 - optical drive eject 4
 - power 9
 - TouchPad 7
- C**
 - cables, service considerations 19
 - camera light 6
 - camera, location 6
 - caps lock light 8
 - chipset, product description 1
 - components
 - bottom 10
 - buttons 9
 - display 6
 - left side 5
 - lights 8
 - right side 4
 - speakers 9
 - TouchPad 7
 - computer components 13
 - connectors, service considerations 19
- D**
 - display assembly
 - removal 52
 - spare part numbers 13, 52
 - display components 6
 - display panel, product description 1
 - drive light 5
 - drives
 - precautions 19
 - preventing damage 19
 - DVD/RW Drive
 - removal 41
 - spare part number 16, 41
- E**
 - electrostatic discharge 20
 - equipment guidelines 22
 - Ethernet, product description 2
- F**
 - fan
 - removal 44
 - spare part number 15, 44
 - fingerprint reader 4
 - removal 38
 - spare part number 15, 38
 - fingerprint reader bezel, spare part number 15
 - fingerprint reader bracket, spare part number 15
 - fingerprint reader cable
 - removal 37
 - spare part number 15, 37
- G**
 - graphics, product description 1
 - grounding guidelines 20
 - guidelines
 - equipment 22
 - grounding 20
 - packaging 21
 - transporting 21
 - workstation 21
- H**
 - hard drive
 - product description 1
 - removal 27
 - spare part number 15, 27
 - hard drive cable
 - removal 27
 - spare part number 16, 27
 - hard drive rubber sleeve
 - removal 27
 - spare part number 16, 27
 - HDMI port 5
 - HDMI-to-VGA adapter, spare part number 16
 - headphone jack 5
 - heat sink
 - removal 49
 - spare part number 15, 49
- J**
 - jacks
 - audio-in 5
 - audio-out 5
 - headphone 5
 - microphone 5
 - network 5
 - RJ-45 5
- L**
 - left-side component 5
 - light components 8
 - lights
 - AC adapter 4
 - battery 4
 - camera 6
 - caps lock 8
 - components 8
 - drive 5
 - mute 8
 - network status 5
 - power 8
 - RJ-45 status 5
- M**
 - memory card reader 5

- memory module
 - removal 30
 - spare part numbers 15, 30
- memory, product description 1
- microphone
 - location 6
- microphone jack 5
- microphone, product description 1
- model name 1
- mute light 8

N

- network jack 5
- network status lights 5

O

- optical drive
 - location 4
 - product description 1
 - removal 41
 - spare part number 16, 41
- optical drive bezel, spare part number 16
- optical drive bracket, spare part number 16
- optical drive eject button 4

P

- packaging guidelines 21
- plastic parts, service considerations 18
- ports
 - HDMI 5
 - product description 2
 - USB 4, 5
- power button 9
- power connector 4
- power connector cable
 - removal 45
 - spare part number 15, 45
- power cord
 - set requirements 69
 - spare part numbers 16
- power light 8
- power requirements, product description 2
- processor, product description 1
- product description
 - audio 1
 - chipset 1
 - display panel 1

- Ethernet 2
- graphics 1
- hard drive 1
- memory 1
- microphone 1
- optical drive 1
- ports 2
- power requirements 2
- processors 1
- product name 1
- security 2
- sensor 2
- solid-state drive 1
- storage 1
- video 1
- wireless 2
- product name 1

R

- right-side components 4
- RJ-45 jack 5
- RJ-45 status lights 5
- rubber foot strip
 - removal 24
 - spare part number 24
- Rubber Kit, spare part number 16, 17

S

- Screw Kit, spare part number 17
- SD card board
 - removal 40
 - spare part number 14, 40
- SD card board cable
 - removal 39
 - spare part number 14, 39
- security cable slot 5
- security lock bracket, spare part number 16
- security, product description 2
- sensor, product description 2
- service considerations
 - cables 19
 - connectors 19
 - plastic parts 18
- solid-state drive
 - product description 1
 - removal 29
 - spare part numbers 15, 29
- speaker components 9

- speakers
 - location 9
 - removal 51
 - spare part number 14, 51
- storage, product description 1
- system board
 - removal 46
 - spare part numbers 15, 46

T

- tools required 18
- TouchPad
 - removal 35
 - spare part number 14, 35
- TouchPad bracket
 - removal 35
 - spare part number 14
- TouchPad button 7
- TouchPad cable
 - removal 34
 - spare part number 14, 34
- TouchPad component 7
- TouchPad zone 7
- transporting guidelines 21

U

- USB port 4, 5
- USB port board
 - removal 43
 - spare part number 14, 43
- USB port board cable
 - removal 42
 - spare part number 14, 42
- USB-C-to-HDMI 2.0 adapter, spare part number 16
- USB-C-to-MultiPort hub, spare part number 16
- USB-C-to-USB-A dongle, spare part number 16
- USB-C-to-USB-A hub, spare part number 16

V

- vent 10
- video, product description 1

W

- wireless antenna, location 6
- wireless, product description 2
- WLAN antenna, location 6

WLAN module
 removal 32
 spare part numbers 15, 32
workstation guidelines 21