



HP EliteBook 755 G5 Notebook PC

Maintenance and Service Guide

© Copyright 2018 HP Development Company, L.P.

AMD and AMD Radeon are trademarks of Advanced Micro Devices, Inc. Bluetooth is a trademark owned by its proprietor and used by HP Inc. under license. Intel and Core are trademarks of Intel Corporation in the U.S. and other countries. Microsoft and Windows are trademarks of the Microsoft group of companies.

The information contained herein is subject to change without notice. The only warranties for HP products and services are set forth in the express warranty statements accompanying such products and services. Nothing herein should be construed as constituting an additional warranty. HP shall not be liable for technical or editorial errors or omissions contained herein.

First Edition: May 2018

Document Part Number: L12988-001

Product notice

This user guide describes features that are common to most models. Some features may not be available on your computer.

Not all features are available in all editions of Windows. This computer may require upgraded and/or separately purchased hardware, drivers and/or software to take full advantage of Windows functionality. Go to <http://www.microsoft.com> for details.

Software terms

By installing, copying, downloading, or otherwise using any software product preinstalled on this computer, you agree to be bound by the terms of the HP End User License Agreement (EULA). If you do not accept these license terms, your sole remedy is to return the entire unused product (hardware and software) within 14 days for a full refund subject to the refund policy of your seller.

For any further information or to request a full refund of the price of the computer, please contact your seller.

Important Notice about Customer Self-Repair Parts

 **CAUTION:** Your computer includes Customer Self-Repair parts and parts that should only be accessed by an authorized service provider. See Chapter 5, "Removal and replacement procedures for Customer Self-Repair parts," for details. Accessing parts described in Chapter 6, "Removal and replacement procedures for Authorized Service Provider only parts," can damage the computer or void your warranty.

Safety warning notice

 **WARNING!** To reduce the possibility of heat-related injuries or of overheating the device, do not place the device directly on your lap or obstruct the device air vents. Use the device only on a hard, flat surface. Do not allow another hard surface, such as an adjoining optional printer, or a soft surface, such as pillows or rugs or clothing, to block airflow. Also, do not allow the AC adapter to contact the skin or a soft surface, such as pillows or rugs or clothing, during operation. The device and the AC adapter comply with the user-accessible surface temperature limits defined by the International Standard for Safety of Information Technology Equipment (IEC 60950-1).

Table of contents

1 Product description	1
2 Components	6
Right	6
Left	8
Display	9
Keyboard area	11
TouchPad	11
Lights	12
Buttons, speakers, and fingerprint reader	14
Special keys	15
Action keys	16
Hot keys (select products only)	17
Bottom	18
Front	19
Cover	20
Labels	21
3 Illustrated parts catalog	22
Computer major components	22
Display assembly subcomponents	25
Cable Kit	27
Miscellaneous parts	28
4 Removal and replacement procedures preliminary requirements	29
Tools required	29
Service considerations	29
Plastic parts	29
Cables and connectors	30
Drive handling	30
Grounding guidelines	31
Electrostatic discharge damage	31
Packaging and transporting guidelines	32
Workstation guidelines	32
Equipment guidelines	33

5 Removal and replacement procedures for Customer Self-Repair parts	34
Component replacement procedures	34
Bottom cover	34
Solid-state drive (SSD)	36
Memory modules	37
WLAN/Bluetooth combo card	39
WWAN module	41
Keyboard	43
6 Removal and replacement procedures for Authorized Service Provider parts	46
Component replacement procedures	46
Battery	47
Heat sink assembly	49
RTC battery	51
USB board	52
RJ-45 board with bracket	53
Power button board	54
Speaker assembly	55
Fingerprint reader assembly	56
TouchPad	57
TouchPad button board	59
NFC module	60
Smart card reader	61
Fan	62
System board	64
Display assembly	67
Top cover	77
7 Interpreting system validation diagnostic front panel LEDs and audible codes	78
8 Computer Setup (BIOS), TPM, and HP Sure Start	80
Using Computer Setup	80
Starting Computer Setup	80
Using a USB keyboard or USB mouse to start Computer Setup (BIOS)	80
Navigating and selecting in Computer Setup	80
Restoring factory settings in Computer Setup	81
Updating the BIOS	81
Determining the BIOS version	81
Downloading a BIOS update	82
Changing the boot order using the f9 prompt	83

TPM BIOS settings (select products only)	83
Using HP Sure Start (select products only)	83
9 Using HP PC Hardware Diagnostics (UEFI)	84
Downloading HP PC Hardware Diagnostics (UEFI) to a USB device	84
10 Backing up, restoring, and recovering	86
Creating recovery media and backups	86
Using HP Recovery media (select products only)	86
Using Windows tools	87
Using the HP Cloud Recovery Download Tool (select products only)	88
Restore and recovery	88
Recovering using HP Recovery Manager	88
What you need to know before you get started	88
Using the HP Recovery partition (select products only)	89
Using HP Recovery media to recover	90
Changing the computer boot order	90
Removing the HP Recovery partition (select products only)	90
11 Specifications	91
Computer specifications	91
39.6-cm (15.6-in) display specifications	92
M.2 PCIe solid-state drive specifications	93
M.2 SATA solid-state drive specifications	94
12 Power cord set requirements	95
Requirements for all countries	95
Requirements for specific countries and regions	95
13 Statement of memory volatility	97
Nonvolatile memory usage	99
Questions and answers	101
Using HP Sure Start (select models only)	102
14 Recycling	103
Index	104

1 Product description

Category	Description
Product Name	HP EliteBook 755 G5 Notebook PC
Processors	<p>AMD® Ryzen™ mobile processors with Radeon™ Vega Graphics:</p> <p>AMD Ryzen 7 PRO 2700U</p> <p>AMD Ryzen 5 PRO 2500U</p> <p>AMD Ryzen 3 PRO 2300U</p>
Chipset	AMD Ryzen; integrated with processor
Graphics	<p>Support HD decode, DX12, HDMI 2.0</p> <p>AMD Radeon Vega UMA Graphics with shared video memory</p> <p>Supports four independent displays through docking stations as follows:</p> <ul style="list-style-type: none"> • HP Docking Station: Maximum resolution = 2K @ 60Hz (DisplayPort 1) and 2K @ 60Hz (DisplayPort 2) and 1920×1200 @ 60Hz (VGA) • HP Docking Station: Maximum resolution - 2K @ 60Hz (DisplayPort 1) and 2K @ 60Hz (DisplayPort 2) and 1920×1200 @ 60Hz (VGA) • HP Elite USB-C Dock G3 and HP USB-C Dock G4: Maximum resolution - 2K @ 60Hz (DP1) and 2K @60Hz (DisplayPort 2) and 1920×1200 @ 60Hz (HDMI).
Panel	<p>Supports narrow bezel</p> <p>39.6-cm (15.6-in), UWVA, non-touch:</p> <p>Full high-definition (FHD)(1920×1080), anti glare (AG), 220 nits, 45% CG, eDP, slim, without camera</p> <p>FHD (1920×1080), anti glare (AG), 220 nits, 45% CG, eDP ,slim, with HD camera</p> <p>FHD (1920×1080), anti glare (AG), 220 nits, 45% CG, eDP ,slim, with HD+IR camera</p> <p>FHD (1920×1080), anti glare (AG), 220 nits, 45% CG, eDP ,slim, without camera, with WWAN</p> <p>FHD (1920×1080), anti glare (AG), 220 nits, 45% CG, eDP ,slim, with HD camera, with WWAN</p> <p>FHD (1920×1080), anti glare (AG), 220 nits, 45% CG, eDP ,slim, with HD+IR camera, with WWAN</p> <p>FHD (1920×1080), anti glare (AG), 400 nits, 72% CG, eDP 1.3+PSR ,slim, Ambient Light Sensor, with HD+IR camera</p> <p>FHD (1920×1080), anti glare (AG), 400 nits, 72% CG, eDP 1.3+PSR ,slim, Ambient Light Sensor, with HD+IR camera, with WWAN</p> <p>FHD (1920×1080), anti glare (AG), 650 nits, 72% CG, eDP 1.4+PSR ,slim, Ambient Light Sensor, with HD+IR camera, with WWAN, privacy</p> <p>39.6-cm (15.6-in), UWVA, touch screen:</p> <p>FHD (1920×1080), 220 nits, 45% CG, eDP ,slim, with HD+IR camera, with WWAN</p>
Memory	<p>Two memory module slots</p> <p>Memory is customer accessible/upgradeable</p>

Category	Description
	<p>DDR4-2400 dual channel support (8th generation processors)</p> <p>Supports up to 32 GB of system RAM in the following configurations:</p> <ul style="list-style-type: none"> • 32768 MB (16384 MB×2) • 16384 MB (16384 MB×1 or 8192 MB×2) • 8192 MB (8192 MB×1 or 4096 MB×2) • 4096 MB (4096 MB×1)
Primary storage	<p>M.2 solid-state drives (2280):</p> <p>512 GB, PCIe, Gen3×4, SS, NVMe, TLC, Opal 2</p> <p>512 GB, PCIe, Gen3×4, SS, NVMe, TLC</p> <p>512 GB, SATA-3, SS, TLC, FIPS-140-2</p> <p>360 GB, PCIe, Gen3×4, NVMe, SS, TLC</p> <p>256 GB, PCIe, Gen3×4, NVMe, SS, TLC</p> <p>256 GB, PCIe, NVMe, SS, value</p> <p>256 GB, SATA-3, Opal 2, TLC</p> <p>128 GB, SATA-3, SS, TLC</p>
Audio and video	<p>HP Bang & Olufsen Audio</p> <p>Multi-array microphone (including World-Facing 3rd microphone)</p> <p>Stereo speakers (2)(13mm × 38mm × 4mm)</p> <p>Camera HD RGB 720p (select models only)</p> <p>Camera HD+IR RGB 720p (select models only)</p> <p>Camera privacy shutter (only with non-touch camera panels)</p> <p>Supports WDR (Wide Dynamic Range)</p>
Ethernet	<p>Realtek PCIe GbE Family Controller 10/100/1000 with DASH Support</p> <p>RTL8111EPH-CG</p> <p>S3/S4/S5 Wake-on-LAN</p> <p>*The following support S3/S4/S5 wake on LAN/HBMA (via out of band): HP Elite USB-C Dock G3, HP USB-C Dock G4, HP USB-C Universal Dock, HP Thunderbolt Dock 120W, and HP USB-C Mini Dock.</p>
Wireless networking	<p>WPAN Bluetooth:</p> <p>Integrated wireless personal area network (PAN) supported by Bluetooth® 4.2 combo card</p> <p>Wireless local area network (WLAN) (select models only):</p> <p>Integrated WLAN options with dual antennas (M.2 2230 socket PCIe/USB)</p> <p>Supports the following WLAN formats:</p> <ul style="list-style-type: none"> • Intel Dual band wireless-AC 8265 802.11ac 2×2 WiFi + Bluetooth 4.2 Combo Adaptor (non-vPro) • Realtek RTL8822BE 802.11ac 2×2 Wi-Fi + Bluetooth 4.2 Combo Adapter <p>Two WLAN antennas built into bottom of display assembly</p>

Category	Description
	Compatible with Miracast-certified devices
	Bluetooth Disabled IOPT
	Support S3/S4 wake on Wireless LAN
	Supports WLAN/LAN/WWAN switching
	Support for HP Sure Connect with Client Side Load Balancing
	Near-Field Communication (NFC) (select models only):
	NXP NPC300 Near Field Communication Module (NFC Mirage WNC XRAV-1 [NXP NPC300 I2C 10 mm x 17 mm])
	NFC antenna
	Wireless wide area network (WWAN) (select models only):
	Integrated wireless wide area network (WWAN) options by way of wireless module
	Two WWAN antennas (world wide 5 band, configured at top of display panel)
	Supports the following WWAN formats:
	<ul style="list-style-type: none"> Integrated WWAN options with dual antennas (M.2 30x42 socket USB2) LTE CAT4: Huawei HP It4132, LTE/HSPA+ w/GPS M.2 Integrated WWAN options with dual antennas (M.2 30x42 socket PCIe) LTE CAT9: Fibocom Intel XMM 7360 LTE-Advanced
	WWAN modules are compatible with a programmable removable eSIM
	Support for WWAN after market option (AMO)
Ports	USB Type-C (Alt Mode)
	USB 3.1 Gen 1 port
	USB 3.1 Gen 1 charging port
	HDMI 1.4
	RJ-45/Ethernet
	Docking connector
	Audio-out (headphone)/audio-in (microphone) combo jack
	AC port
Docking	HP Thunderbolt Dock 120W G2
	HP Elite USB-C Dock
	HP UltraSlim Docking Station
Keyboard/pointing devices	Keyboard:
	HP Collaboration Keyboard with numeric keypad
	<ul style="list-style-type: none"> Dual point, non-backlit, spill resistant with drain Dual point, backlit, spill resistant with drain, with HP Dura Keys

Category	Description
	<ul style="list-style-type: none"> Dual point, backlit, spill resistant with drain, with HP Dura Keys, privacy
	TouchPad: Support for Microsoft Precision Touchpad Default Gestures Firmware PTP (Point to Point) with Filter Driver Support for 'No Hybrid Mode'
Power requirements	Battery: HP Long Life Lithium Polymer Soft Pack Battery, 3-cell, 56 WHr HP Fast Charge Technology AC adapter: 65 W "Smart" right angle, 4.5 mm 65 W "Smart" right angle, 4.5 mm - Argentina 65 W "Smart" right angle, 4.5 mm - EM 65 W Straight USB Type C 45 W "Smart" right angle, 4.5 mm 45 W "Smart" right angle, 4.5 mm - Argentina 45 W "Smart" right angle, 4.5 mm, 2-prong (Japan only) 45 W Straight USB Type C Power cord: 2 wire plug (C7), 1 m 3 wire plug (C5), 1.8 m 3 wire plug (C5), 1 m Duckhead power cord (C5) 1.0 m Duckhead power cord (C5) 1.8 m
Security	Security lock Trusted Platform Module (TPM) 2.0 (Infineon, soldered down) Touch fingerprint sensor (landed, touch with 8x8 sensor)(select models only) Smart Card reader (active)(select models only) Preboot authentication (password, smart card) Hardware enforced Firmware Protection: HP Hardware Root of Trust + Sure Start Gen4
Operating system	Preinstalled: Windows 10 Home 64 Windows 10 Home 64 Single Language Windows 10 Home 64 Chinese Market CPPP Windows 10 Home 64 High End Chinese Market CPPP





Category	Description
	Windows 10 Home 64 Plus
	Windows 10 Home 64 Plus Single Language
	Windows 10 Professional 64
	Windows 10 Home 64 StF MSNA Standard
	Windows 10 Home 64 StF MSNA Plus
	FreeDOS 2.0
	Restore Media:
	Windows 10 DRDVD
	Windows 10 DRUSB
	Windows 10 Pro 64 OSDVD
	Windows 10 Pro 64 OSUSB
	Certified:
	Microsoft WHQL
	Web-only support:
	Windows 10 Enterprise 64
	Windows 10 Enterprise 64 LTSB 1607
Serviceability	End user replaceable parts:
	AC adapter
	Solid-state drive
	Memory module
	WLAN module
	WWAN module
	Keyboard



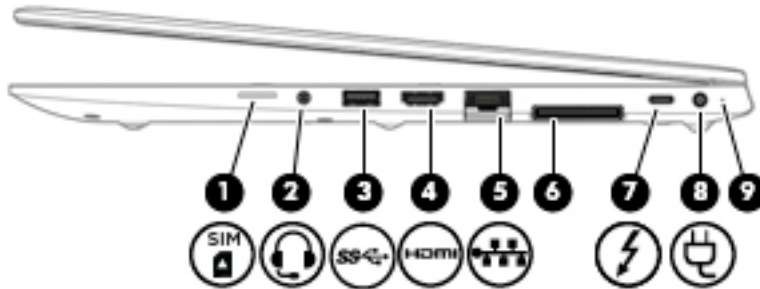

2 Components

Your computer features top-rated components. This chapter provides details about your components, where they're located, and how they work.

Right





Component	Description
(1)  SIM card slot or plug	Supports a wireless subscriber identity module (SIM) card or plug. NOTE: All models have a SIM card slot and icon, but models that do not have the HP Mobile Broadband Module, a wireless wide area network (WWAN) device, installed at the factory are shipped with a non-removable plug inserted into the slot.
(2)  Audio-out (headphone)/Audio-in (microphone) combo jack	Connects optional powered stereo speakers, headphones, earbuds, a headset, or a television audio cable. Also connects an optional headset microphone. This jack does not support optional standalone microphones. WARNING! To reduce the risk of personal injury, adjust the volume before putting on headphones, earbuds, or a headset. For additional safety information, refer to the <i>Regulatory, Safety, and Environmental Notices</i> . To access this guide: <ul style="list-style-type: none">▲ Select the Start button, select HP Help and Support, and then select HP Documentation. – or – <ul style="list-style-type: none">▲ Select the Start button, select HP, and then select HP Documentation. NOTE: When a device is connected to the jack, the computer speakers are disabled.
(3)  USB 3.x SuperSpeed port	Connects a USB device, such as a cell phone, camera, activity tracker, or smartwatch, and provides high-speed data transfer.
(4)  HDMI port	Connects an optional video or audio device, such as a high-definition television, any compatible digital or audio component, or a high-speed High Definition Multimedia Interface (HDMI) device.

Component	Description
(5)  RJ-45 (network) jack/status lights	Connects a network cable. <ul style="list-style-type: none"> • Green (left): The network is connected. • Amber (right): Activity is occurring on the network.
(6) Docking connector	Connects an optional docking device.
(7)   USB Type-C power connector and Thunderbolt™ port with HP Sleep and Charge	Connects an AC adapter that has a USB Type-C connector, supplying power to the computer and, if needed, charging the computer battery. <p>– and –</p> Connects and charges most USB devices that have a Type-C connector, such as a cell phone, camera, activity tracker, or smartwatch, and provides high-speed data transfer. <p>– and –</p> Connects a display device that has a USB Type-C connector, providing DisplayPort output. <p>NOTE: Your computer may also support a Thunderbolt docking station.</p> <p>NOTE: Cables and/or adapters (purchased separately) may be required.</p> <p>NOTE: The icon on the port will indicate its function.</p>
(8)  Power connector	Connects an AC adapter.
(9) Battery light	When AC power is connected: <ul style="list-style-type: none"> • White: The battery charge is greater than 90 percent. • Amber: The battery charge is from 0 to 90 percent. • Off: The battery is not charging. When AC power is disconnected (battery not charging): <ul style="list-style-type: none"> • Blinking amber: The battery has reached a low battery level. When the battery has reached a critical battery level, the battery light begins blinking rapidly. • Off: The battery is not charging.

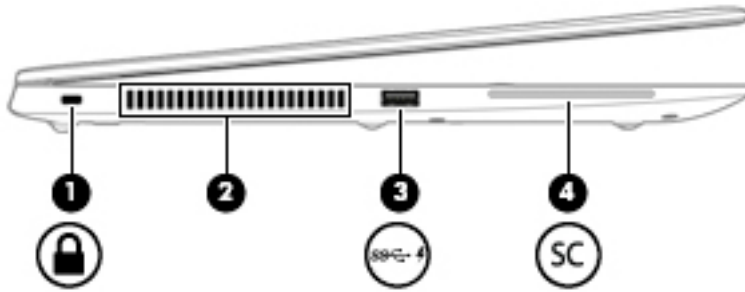
Left



Component	Description
(1)  Security cable slot	Attaches an optional security cable to the computer. NOTE: The security cable is designed to act as a deterrent, but it may not prevent the computer from being mishandled or stolen.
(2) Vent	Enables airflow to cool internal components. NOTE: The computer fan starts up automatically to cool internal components and prevent overheating. It is normal for the internal fan to cycle on and off during routine operation.
(3)  USB 3.x SuperSpeed port with HP Sleep and Charge	Connects a USB device, provides high-speed data transfer, and even when the computer is off, charges most products such as a cell phone, camera, activity tracker, or smartwatch.
(4)  Smart card reader	Supports optional smart cards.

Display

 **NOTE:** Refer to the illustration that most closely matches your computer.

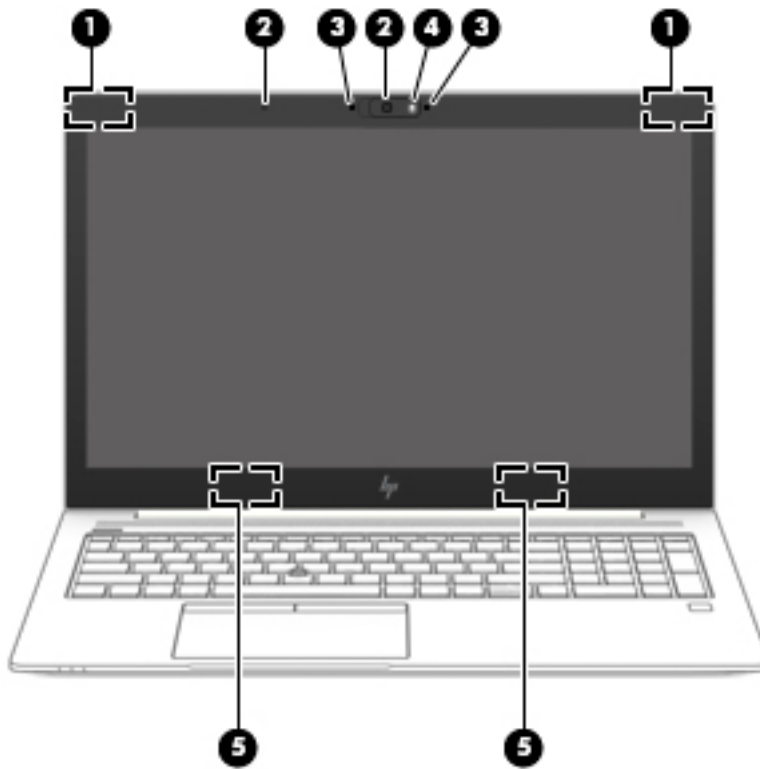

Component	Description
(1) WWAN antennas* (select products only)	Send and receive wireless signals to communicate with wireless wide area networks (WWANs).
(2) Camera(s) (select products only)	Allow(s) you to video chat, record video, and record still images. NOTE: Camera functions vary depending on the camera hardware and software installed on your product.
(3) Internal microphones	Record sound.
(4) Camera light(s) (select products only)	On: One or more cameras are in use.
(5) WLAN antennas* (select products only)	Send and receive wireless signals to communicate with wireless local area networks (WLANs).

*The antennas are not visible from the outside of the computer. For optimal transmission, keep the areas immediately around the antennas free from obstructions.

For wireless regulatory notices, see the section of the *Regulatory, Safety, and Environmental Notices* that applies to your country or region.

To access this guide:

▲ Select the **Start** button, select **HP Help and Support**, and then select **HP Documentation**.

– or –

▲ Select the **Start** button, select **HP**, and then select **HP Documentation**.

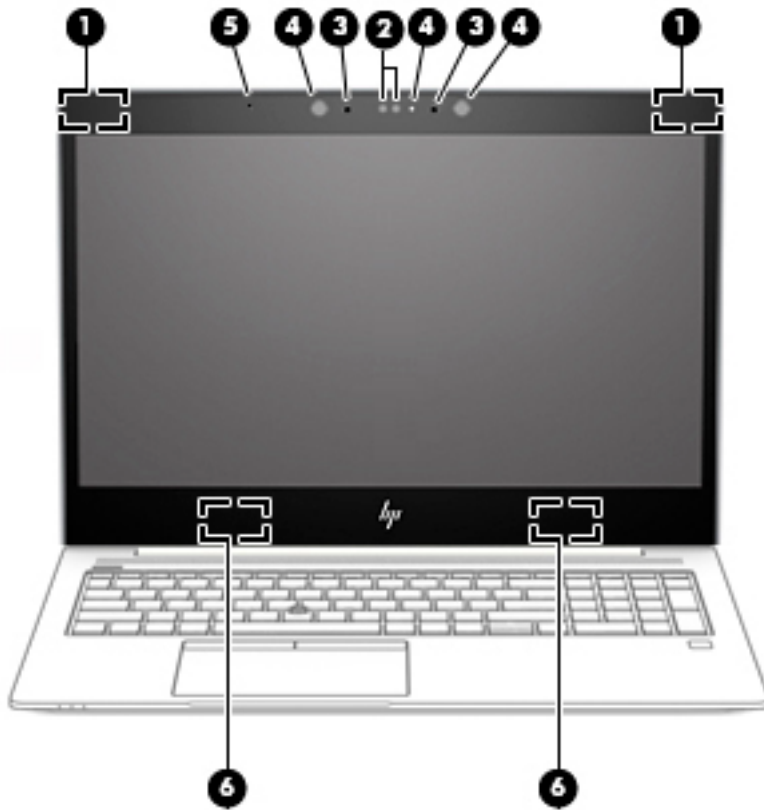

Component	Description
(1) WWAN antennas* (select products only)	Send and receive wireless signals to communicate with wireless wide area networks (WWANs).
(2) Camera(s) (select products only)	Allow(s) you to video chat, record video, and record still images. NOTE: Camera functions vary depending on the camera hardware and software installed on your product.
(3) Internal microphones	Record sound.
(4) Camera light(s) (select products only)	On: One or more cameras are in use.
(5) Ambient light sensor	Detects the amount of surrounding light and adjusts screen brightness.
(6) WLAN antennas* (select products only)	Send and receive wireless signals to communicate with wireless local area networks (WLANs).

*The antennas are not visible from the outside of the computer. For optimal transmission, keep the areas immediately around the antennas free from obstructions.

For wireless regulatory notices, see the section of the *Regulatory, Safety, and Environmental Notices* that applies to your country or region.

To access this guide:

▲ Select the **Start** button, select **HP Help and Support**, and then select **HP Documentation**.

– or –

▲ Select the **Start** button, select **HP**, and then select **HP Documentation**.

Keyboard area

TouchPad

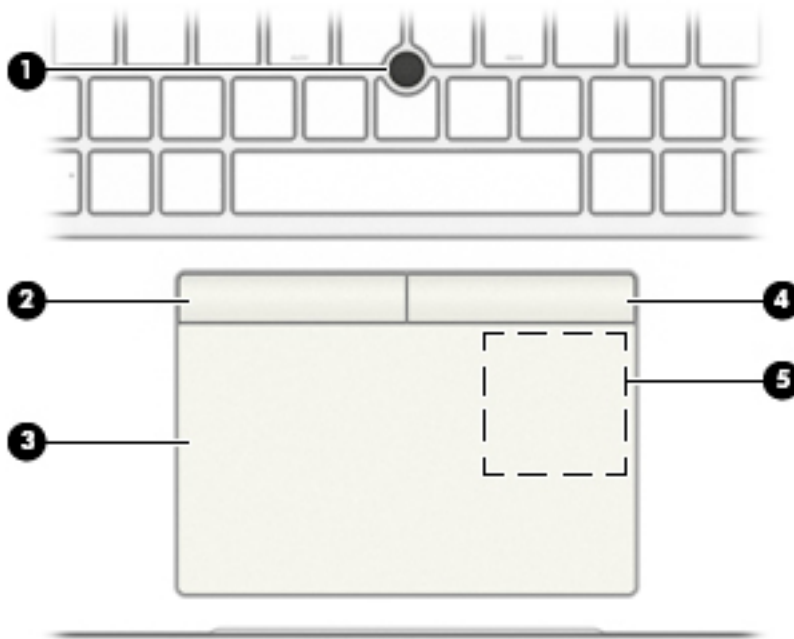

Component		Description
(1)	Pointing stick	Moves the pointer on the screen.
(2)	Left pointing stick button	Functions like the left button on an external mouse.
(3)	TouchPad zone	Reads your finger gestures to move the pointer or activate items on the screen.
(4)	Right pointing stick button	Functions like the right button on an external mouse.
(5)	Near Field Communications (NFC) tapping area and antenna* (select products only)	Allows you to wirelessly share information when you tap it with an NFC-enabled device.

*The antenna is not visible from the outside of the computer. For optimal transmission, keep the area immediately around the antenna free from obstructions.

For wireless regulatory notices, see the section of the *Regulatory, Safety, and Environmental Notices* that applies to your country or region.

To access this guide:





▲ Select the **Start** button, select **HP Help and Support**, and then select **HP Documentation**.

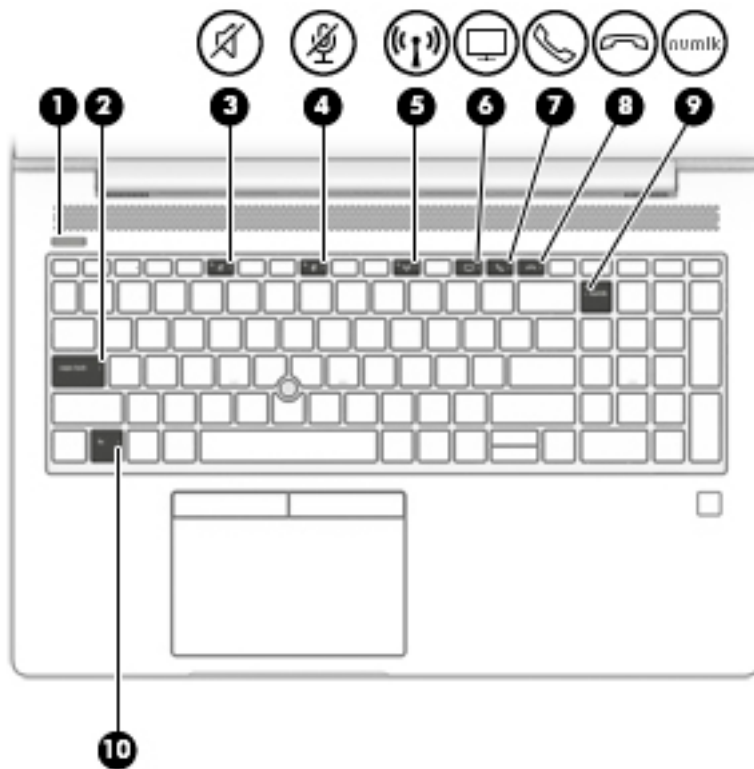

– or –

▲ Select the **Start** button, select **HP**, and then select **HP Documentation**.

Lights





Component	Description
(1) Power light	<ul style="list-style-type: none"> On: The computer is on. Blinking: The computer is in the Sleep state, a power-saving state. The computer shuts off power to the display and other unneeded components. Off: The computer is off or in Hibernation. Hibernation is a power-saving state that uses the least amount of power.
(2) Caps lock light	On: Caps lock is on, which switches the key input to all capital letters.
(3)  Mute light	<ul style="list-style-type: none"> On: Computer sound is off. Off: Computer sound is on.
(4)  Microphone mute light	<ul style="list-style-type: none"> On: Microphone is off. Off: Microphone is on.
(5)  Wireless light	<p>On: An integrated wireless device, such as a wireless local area network (WLAN) device and/or a Bluetooth® device, is on.</p> <p>NOTE: On some models, the wireless light is amber when all wireless devices are off.</p>
(6)  Sharing or presenting light	On: Sharing is on.
(7)  Call answer light	On: Call answer is on.

Component	Description
(8)  Call end light	On: Call end is on.
(9)  Num lk light	On: Num lock is on.
(10) Fn lock light	On: The fn key is locked. For more information, see Hot keys (select products only) on page 17.

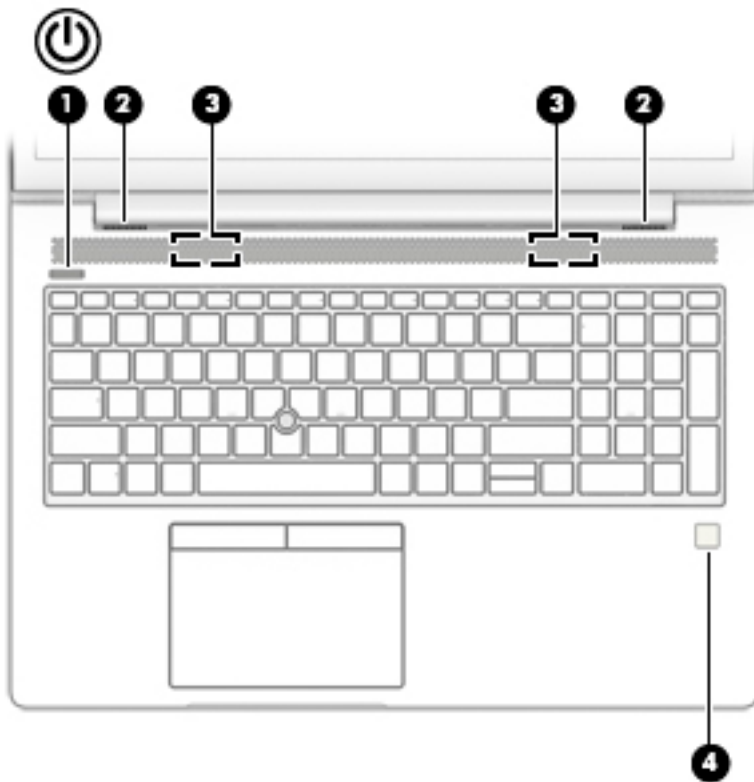
Buttons, speakers, and fingerprint reader



Component	Description
<p>(1)  Power button</p>	<ul style="list-style-type: none"> When the computer is off, press the button to turn on the computer. When the computer is on, press the button briefly to initiate Sleep. When the computer is in the Sleep state, press the button briefly to exit Sleep. When the computer is in Hibernation, press the button briefly to exit Hibernation. <p>CAUTION: Pressing and holding down the power button results in the loss of unsaved information.</p> <p>If the computer has stopped responding and shutdown procedures are ineffective, press and hold the power button for at least 5 seconds to turn off the computer.</p> <p>To learn more about your power settings, see your power options.</p> <p>▲ Right-click the Power meter icon  and then select Power Options.</p>
(2) Vents (2)	<p>Enable airflow to cool internal components.</p> <p>NOTE: The computer fan starts up automatically to cool internal components and prevent overheating. It is normal for the internal fan to cycle on and off during routine operation.</p>
(3) Speakers (2)	Produce sound.
(4) Fingerprint reader or plug	<p>Allows a fingerprint logon to Windows, instead of a password logon.</p> <p>NOTE: The fingerprint reader and plug look similar. To verify you have a fingerprint reader and not a plug, press the Windows key  on your keyboard, select Settings, select Accounts, and then select Sign-in options and follow the on-screen instructions.</p>

Special keys

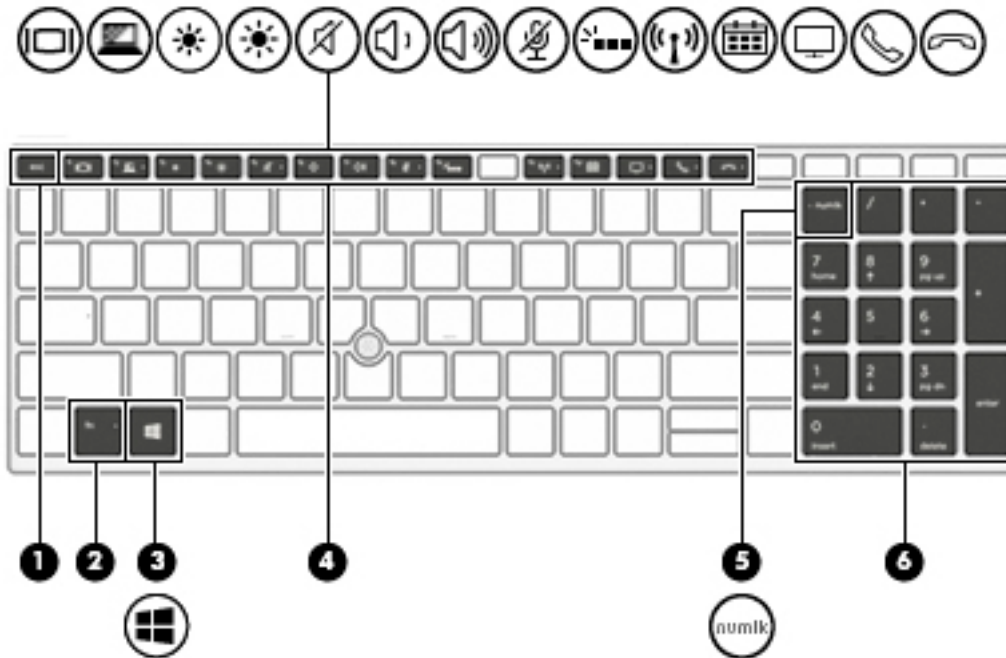











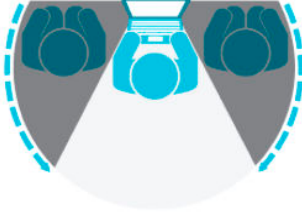



Component	Description
(1) <code>esc</code> key	Displays system information when pressed in combination with the <code>fn</code> key.
(2) <code>fn</code> key	Executes frequently used system functions when pressed in combination with another key. Such key combinations are called <i>hot keys</i> . See Hot keys (select products only) on page 17 .
(3)  Windows key	Opens the Start menu. NOTE: Pressing the Windows key again will close the Start menu.
(4) Action keys	Execute frequently used system functions. See Action keys on page 16 .
(5) <code>num lk</code> key	Turns the embedded numeric keypad on and off. – or – Alternates between the navigational and numeric functions on the integrated numeric keypad.
(6) Integrated numeric keypad	A separate keypad to the right of the alphabet keyboard. When <code>num lk</code> is pressed, the integrated keypad can be used like an external numeric keypad. NOTE: If the keypad function is active when the computer is turned off, that function is reinstated when the computer is turned back on.

Action keys

An action key performs the function indicated by the icon on the key. To determine which keys are on your product, see [Special keys on page 15](#).

- ▲ To use an action key, press and hold the key.

Icon	Description
	Switches the screen image among display devices connected to the system. For example, if a monitor is connected to the computer, repeatedly pressing the key alternates the screen image from computer display to monitor display to simultaneous display on both the computer and monitor.
	Helps prevent side-angle viewing from onlookers. If needed, decrease or increase brightness for well-lit or darker environments. Press the key again to turn off the privacy screen. NOTE: To quickly turn on the highest privacy setting, press fn+p .
	
	Decreases the screen brightness incrementally as long as you hold down the key.
	Increases the screen brightness incrementally as long as you hold down the key.
	Mutes or restores speaker sound.
	Decreases speaker volume incrementally while you hold down the key.
	Increases speaker volume incrementally while you hold down the key.
	Mutes the microphone.
	Turns the keyboard backlight off or on. NOTE: To conserve battery power, turn off this feature.
	Turns the wireless feature on or off. NOTE: A wireless network must be set up before a wireless connection is possible.
	Provides quick access to your Skype for Business calendar. NOTE: This feature requires Skype® for Business or Lync® 2013 running on Microsoft Exchange or Office 365® servers.
	Turns the screen sharing function on or off. NOTE: This feature requires Skype for Business or Lync 2013 running on Microsoft Exchange or Office 365 servers.

Icon	Description
	<ul style="list-style-type: none"> Answers a call. Starts a call during a 1-on-1 chat. Places a call on hold. <p>NOTE: This feature requires Skype for Business or Lync 2013 running on Microsoft Exchange or Office 365 servers.</p>
	<ul style="list-style-type: none"> Ends a call. Declines incoming calls. Ends screen sharing. <p>NOTE: This feature requires Skype for Business or Lync 2013 running on Microsoft Exchange or Office 365 servers.</p>

 **NOTE:** The action key feature is enabled at the factory. You can disable this feature by pressing and holding the **fn** key and the left **shift** key. The fn lock light will turn on. After you have disabled the action key feature, you can still perform each function by pressing the **fn** key in combination with the appropriate action key.

Hot keys (select products only)

A hot key is the combination of the **fn** key and another key.

To use a hot key:

- ▲ Press the **fn** key, and then press one of the keys listed in the following table.

Key	Description
C	Turns on scroll lock.
R	Breaks the operation.
S	Sends a programming query.

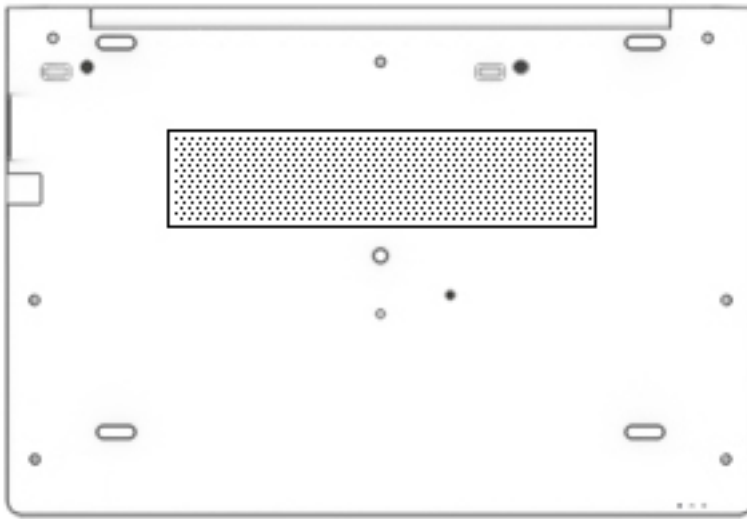

Bottom



Component	Description
Vent	Enables airflow to cool internal components. NOTE: The computer fan starts up automatically to cool internal components and prevent overheating. It is normal for the internal fan to cycle on and off during routine operation.

Front



Component	Description
(1)  Power light	<ul style="list-style-type: none">• On: The computer is on.• Blinking: The computer is in the Sleep state, a power-saving state. The computer shuts off power to the display and other unneeded components.• Off: The computer is off or in Hibernation. Hibernation is a power-saving state that uses the least amount of power.
(2)  Wireless light	<p>On: An integrated wireless device, such as a wireless local area network (WLAN) device and/or a Bluetooth® device, is on.</p> <p>NOTE: On some models, the wireless light is amber when all wireless devices are off.</p>
(3)  Drive light	<ul style="list-style-type: none">• Blinking white: The hard drive is being accessed.• Amber: HP 3D DriveGuard has temporarily parked the hard drive.

Cover



Component	Description
Internal microphone(s)	Record(s) sound.

Labels

The labels affixed to the computer provide information you may need when you troubleshoot system problems or travel internationally with the computer. Labels may be in paper form or imprinted on the product.

 **IMPORTANT:** Check the following locations for the labels described in this section: the bottom of the computer, inside the battery bay, under the service door, on the back of the display, or on the bottom of a tablet kickstand.

- Service label—Provides important information to identify your computer. When contacting support, you may be asked for the serial number, the product number, or the model number. Locate this information before you contact support.

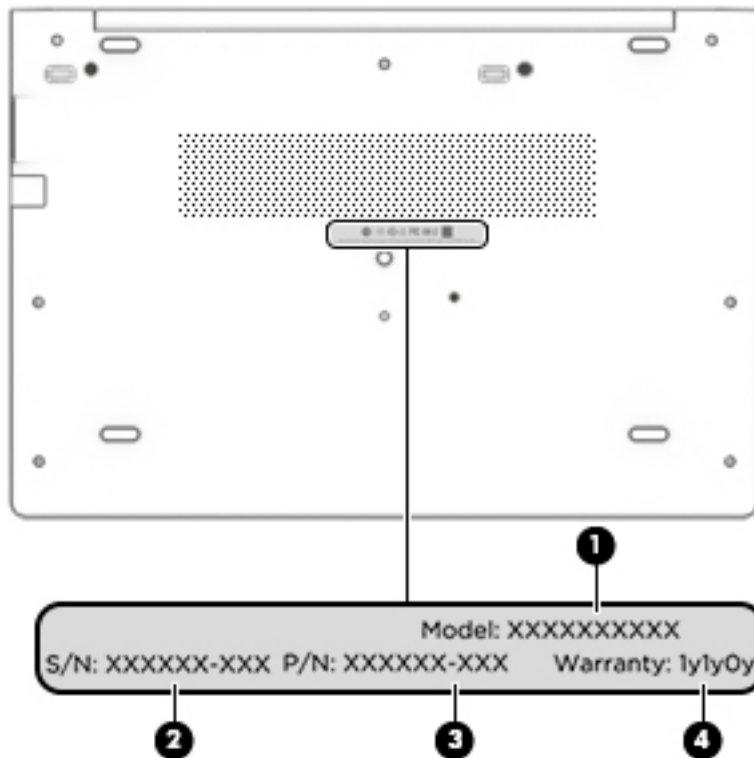

Component

- (1) Model name
 - (2) Serial number
 - (3) Part number
 - (4) Warranty period
-

- Regulatory label(s)—Provide(s) regulatory information about the computer.
- Wireless certification label(s)—Provide(s) information about optional wireless devices and the approval markings for the countries or regions in which the devices have been approved for use.

3 Illustrated parts catalog

Computer major components

 **NOTE:** HP continually improves and changes product parts. For complete and current information on supported parts for your computer, go to <http://partsurfer.hp.com>, select your country or region, and then follow the on-screen instructions.

 **NOTE:** Details about your computer, including model, serial number, product key, and length of warranty, are on the service tag at the bottom of your computer. See [Labels on page 21](#) for details.

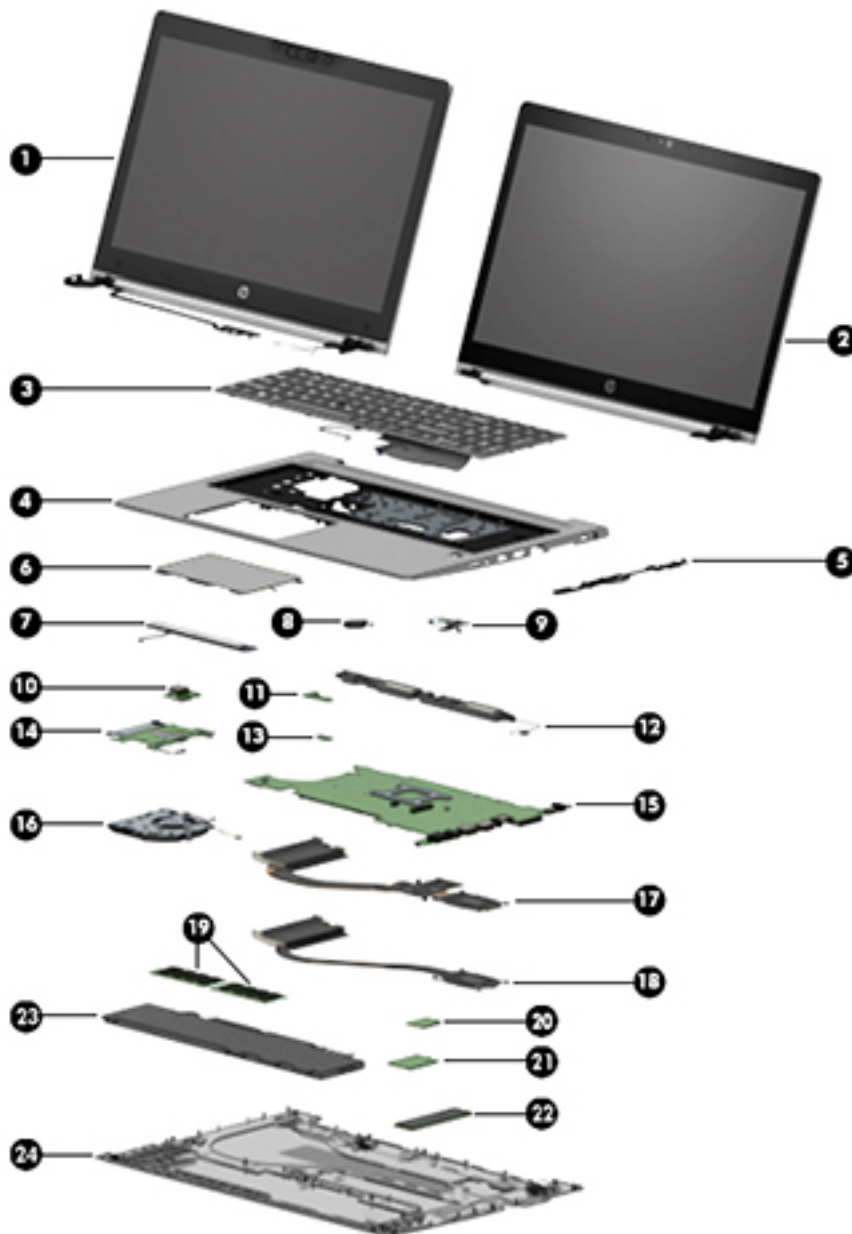

Item	Component	Spare part number
	Display assembly	
	Display assemblies are spared at the subcomponent level only. For more display assembly spare part information, see Display assembly subcomponents on page 25 .	
(1)	Non-touch	not spared as whole hinge-up
(2)	Touch	not spared as whole hinge-up
(3)	Keyboard (see Keyboard on page 43)	
	For a list of keyboard country codes, see Keyboard on page 43 .	
	Without a backlight	L14367-xx1
	With a backlight	L14366-xx1
	With a backlight, privacy	L29477-001
(4)	Top cover	L22091-001
(5)	RJ-45 board with bracket	L14386-001
(6)	TouchPad	
	For use in models without an NFC module	L14369-001
	For use in models with an NFC module	L19416-001
(7)	TouchPad button board	L18311-001
(8)	RTC battery	L17255-001
(9)	Power button board	L14374-001
(10)	USB board (includes bracket)	L14380-001
(11)	Fingerprint reader assembly	L13681-001
(12)	Speakers (includes cable)	L14368-001
(13)	NFC module (includes antenna and TouchPad foam)	L14385-001
(14)	Smart card reader board	L18312-001
(15)	System board (includes processor and replacement thermal material, see System board on page 64)	
	All system boards use the following part numbers:	
	xxxxxx-001: Non-Windows operating systems	
	xxxxxx-601: Windows operating system	
	AMD Ryzen 7 PRO 2700U processor	L21938-xx1
	AMD Ryzen 5 PRO 2500U processor	L21937-xx1
	AMD Ryzen 3 PRO 2300U processor	L21936-xx1
(16)	Fan	L22307-001
(17)	Heat sink	L14362-001
(19)	Memory module	
	4-GB (DDR-2400)	862397-850
	8-GB (DDR-2133)	835887-001

Item	Component	Spare part number
	16-GB (DDR-2133)	820571-001
(20)	WLAN/Bluetooth combo card	
	Realtek RTL8822BE 802.11ac 2x2 Wi-Fi + Bluetooth 4.2 Combo Adapter	915623-001
	Intel Dual band wireless-AC 8265 802.11AC 2x2 WiFi + Bluetooth 4.2 Combo Adaptor (non-vPro)	851594-001
(21)	WWAN module	
	LTE CAT4: Huawei HP Lt4132, LTE/HSPA+ w/GPS M.2	845710-003
	LTE CAT9: Fibocom Intel XMM 7360 LTE-Advanced	L15398-001
(22)	Solid-state drive (SSD)	
	512 GB, PCIe, Gen3x4, SS, NVMe, TLC	L22089-001
	512 GB, PCIe, Gen3x4, Self-encrypting drive (SED), Opal 2, TLC	L22088-001
	512 GB, SATA-3, FIPS-140-2, TLC	L22087-001
	360 GB, PCIe Gen3x4, NVMe, TLC	L22090-001
	256 GB, PCIe, Gen3x4, SS, NVMe, TLC	L22085-001
	256 GB, SATA-3, self-encrypting drive (SED), Opal2	L22083-001
	256 GB, SATA-3, Opal 2, TLC	L22086-001
	128 GB, SATA-3, TLC	L22084-001
(23)	Battery (3 cell, 56 WHr, 4.85 Ah)	933322-855
(24)	Bottom cover	L14360-001

Display assembly subcomponents

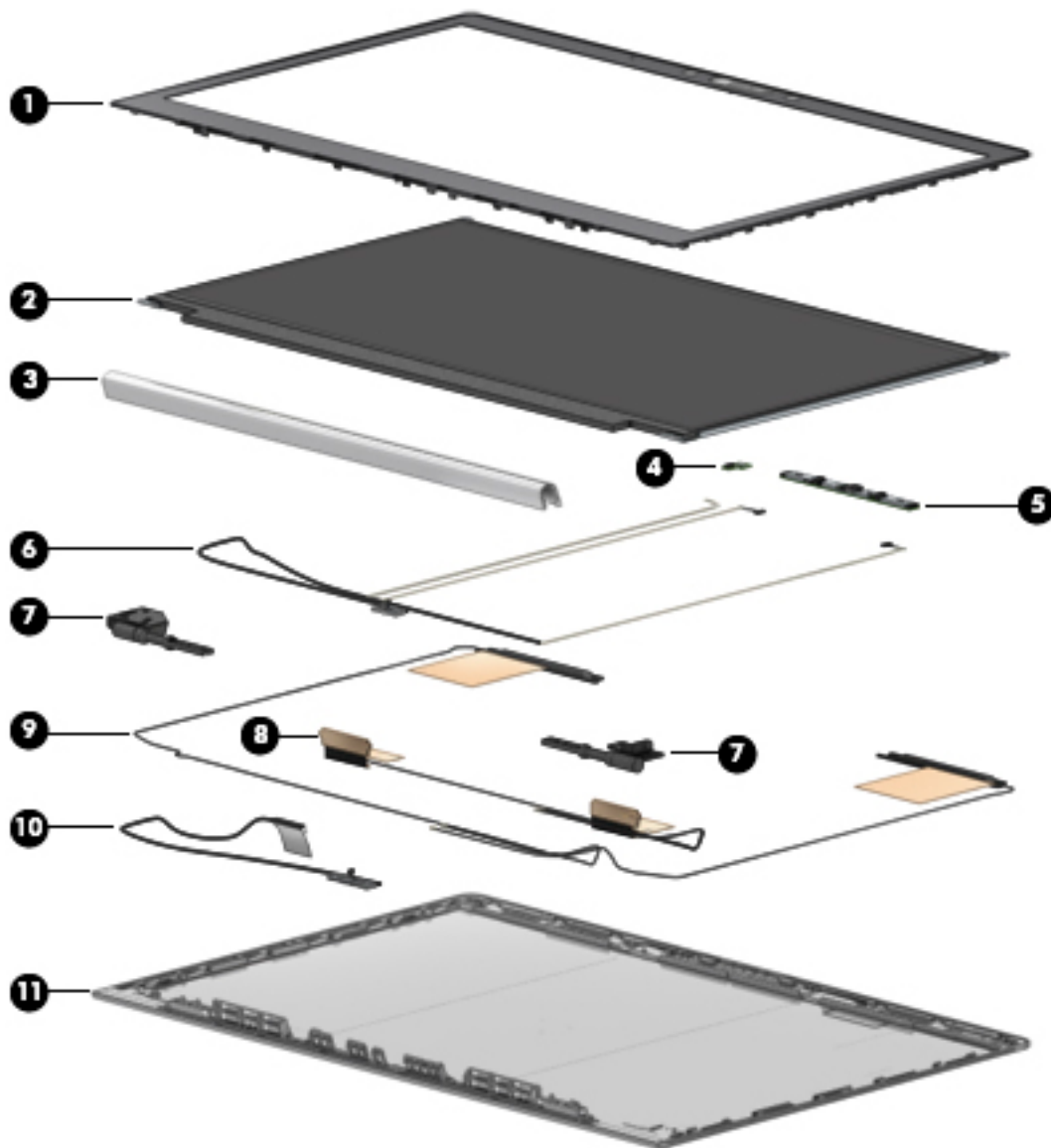

Item	Component	Spare part number
(1)	Bezel	
	For use in models with microphone modules	L15526-001
	For use in models with an HD camera (includes camera shutter)	L15527-001
	For use in models with an IR camera (includes camera shutter)	L15528-001
	For use in models with an IR camera and an ambient light sensor (includes camera shutter)	L15529-001
	Camera shutters (for IR and HD cameras; not illustrated)	L22111-001 (Plastics Kit)
(2)	Raw display panel (includes panel, touch module (as applicable), display cable, and interior panel bezel)	
	Non-touch, FHD, models with an HD camera	L22092-001

Item	Component	Spare part number
	Non-touch, FHD, models with an IR camera and ambient light sensor	L22093-001
	Touch models, non-privacy	L22094-001
	NOTE: Touch panels include the touch controller board precalibrated and attached onto the bottom of the panel.	
	Touch models, privacy	L30679-001
	NOTE: Touch panels include the touch controller board precalibrated and attached onto the bottom of the panel.	
(3)	Hinge cover	
	For use in models with touch displays	L14364-001 (Hinge Kit)
	For use in models with non-touch displays	L14365-001 (Hinge Kit)
(4)	Ambient light sensor board (includes double-sided tape)	L15511-001
(5)	Camera module	
	HD camera	L28405-001
	IR camera	L28404-001
	Microphone module (not shown; includes double-sided tape)	L15512-001
(6)	Camera cable (HD and IR models)	L14361-001 (Cable Kit)
(7)	Hinges (left and right) (for use in models with touch displays)	L14364-001 (Hinge Kit)
	Hinges (left and right) (for use in models with non-touch displays)	L14365-001 (Hinge Kit)
(8)	WLAN antenna (spared with display enclosure)	
(9)	WWAN antenna (spared with display enclosure)	
(10)	Display cable	L14361-001 (Cable Kit)
	Privacy panel display cable	L31996-001
(11)	Display enclosure (includes tape, gasket, and foam)	
	For use in models without a WLAN module	L15525-001
	For use in models with a WWAN module	L15524-001

Cable Kit

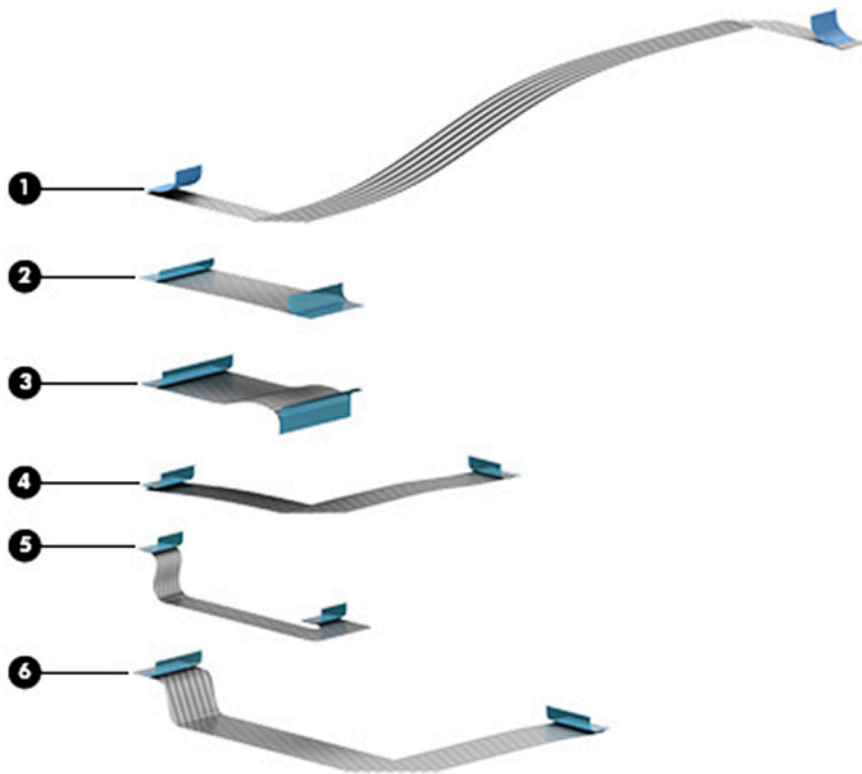

Item	Description	Spare part number
	Cable Kit	L14361-001
(1)	Power button board cable	
(2)	USB board cable	
(3)	Card reader cable	
(4)	TouchPad cable	
(5)	Fingerprint reader cable	
(6)	NFC cable	
	Pointing stick cable (not illustrated)	
	Camera cable (HD and IR models; not illustrated)	
	Display (FHD) cable (not illustrated)	
	Display (UHD) cable (not illustrated)	
	Display (FHD), UWVA, touch (not illustrated)	
	Privacy panel cable (not included in Cable Kit; not illustrated)	L31996-001

Miscellaneous parts

Component	Spare part number
AC adapter, non-PFC, 4.5 mm	
65 W HP Smart AC adapter, 3 prong	710412-001
65 W HP Smart AC adapter, EM	913691-850
65 W, wall mount, 3 pin, USB-C	860209-850
45 W HP Smart AC adapter, 2 prong	742436-001
45 W HP Smart AC Adapter	741553-850
45 W HP Smart AC Adapter for use in Argentina	741553-852
45 W, wall mount, 3 pin, USB-C	860210-850
Plastics Kit (includes SIM card insert, fingerprint reader insert, smart card reader insert, smart card insert, IR camera shutter, HD camera shutter)	L22111-001
Screw Kit	L18441-001
HP Elite USB-C Dock G3	920131-001
HP USB-C Universal Dock	L16130-001
HP USB-C Dock G4	L16133-001
Pointing stick covers, quantity of 20	L15396-001

4 Removal and replacement procedures preliminary requirements

Tools required

You will need the following tools to complete the removal and replacement procedures:

- Phillips P0 screwdriver

Service considerations

The following sections include some of the considerations that you must keep in mind during disassembly and assembly procedures.



NOTE: As you remove each subassembly from the computer, place the subassembly (and all accompanying screws) away from the work area to prevent damage.

Plastic parts



CAUTION: Using excessive force during disassembly and reassembly can damage plastic parts. Use care when handling the plastic

Cables and connectors

⚠ CAUTION: When servicing the computer, be sure that cables are placed in their proper locations during the reassembly process. Improper cable placement can damage the computer.

Cables must be handled with extreme care to avoid damage. Apply only the tension required to unseat or seat the cables during removal and insertion. Handle cables by the connector whenever possible. In all cases, avoid bending, twisting, or tearing cables. Be sure that cables are routed in such a way that they cannot be caught or snagged by parts being removed or replaced. Handle flex cables with extreme care; these cables tear easily.

Drive handling

⚠ CAUTION: Drives are fragile components that must be handled with care. To prevent damage to the computer, damage to a drive, or loss of information, observe these precautions:

Before removing or inserting a hard drive, shut down the computer. If you are unsure whether the computer is off or in Hibernation, turn the computer on, and then shut it down through the operating system.

Before handling a drive, be sure that you are discharged of static electricity. While handling a drive, avoid touching the connector.

Before removing a diskette drive or optical drive, be sure that a diskette or disc is not in the drive and be sure that the optical drive tray is closed.

Handle drives on surfaces covered with at least one inch of shock-proof foam.

Avoid dropping drives from any height onto any surface.

Avoid exposing an internal hard drive to products that have magnetic fields, such as monitors or speakers.

Avoid exposing an internal hard drive to products that have magnetic fields, such as monitors or speakers.

Avoid exposing a drive to temperature extremes or liquids.

If a drive must be mailed, place the drive in a bubble pack mailer or other suitable form of protective packaging and label the package "FRAGILE."

Grounding guidelines

Electrostatic discharge damage

Electronic components are sensitive to electrostatic discharge (ESD). Circuitry design and structure determine the degree of sensitivity. Networks built into many integrated circuits provide some protection, but in many cases, ESD contains enough power to alter device parameters or melt silicon junctions.

A discharge of static electricity from a finger or other conductor can destroy static-sensitive devices or microcircuitry. Even if the spark is neither felt nor heard, damage may have occurred.

An electronic device exposed to ESD may not be affected at all and can work perfectly throughout a normal cycle. Or the device may function normally for a while, then degrade in the internal layers, reducing its life expectancy.

CAUTION: To prevent damage to the computer when you are removing or installing internal components, observe these precautions:

Keep components in their electrostatic-safe containers until you are ready to install them.

Before touching an electronic component, discharge static electricity by using the guidelines described in this section.

Avoid touching pins, leads, and circuitry. Handle electronic components as little as possible.

If you remove a component, place it in an electrostatic-safe container.

The following table shows how humidity affects the electrostatic voltage levels generated by different activities.

CAUTION: A product can be degraded by as little as 700 V.

Typical electrostatic voltage levels			
Event	Relative humidity		
	10%	40%	55%
Walking across carpet	35,000 V	15,000 V	7,500 V
Walking across vinyl floor	12,000 V	5,000 V	3,000 V
Motions of bench worker	6,000 V	800 V	400 V
Removing DIPS from plastic tube	2,000 V	700 V	400 V
Removing DIPS from vinyl tray	11,500 V	4,000 V	2,000 V
Removing DIPS from Styrofoam	14,500 V	5,000 V	3,500 V
Removing bubble pack from PCB	26,500 V	20,000 V	7,000 V
Packing PCBs in foam-lined box	21,000 V	11,000 V	5,000 V

Packaging and transporting guidelines

Follow these grounding guidelines when packaging and transporting equipment:

- To avoid hand contact, transport products in static-safe tubes, bags, or boxes.
- Protect ESD-sensitive parts and assemblies with conductive or approved containers or packaging.
- Keep ESD-sensitive parts in their containers until the parts arrive at static-free workstations.
- Place items on a grounded surface before removing items from their containers.
- Always be properly grounded when touching a component or assembly.
- Store reusable ESD-sensitive parts from assemblies in protective packaging or nonconductive foam.
- Use transporters and conveyors made of antistatic belts and roller bushings. Be sure that mechanized equipment used for moving materials is wired to ground and that proper materials are selected to avoid static charging. When grounding is not possible, use an ionizer to dissipate electric charges.

Workstation guidelines

Follow these grounding workstation guidelines:

- Cover the workstation with approved static-shielding material.
- Use a wrist strap connected to a properly grounded work surface and use properly grounded tools and equipment.
- Use conductive field service tools, such as cutters, screwdrivers, and vacuums.
- When fixtures must directly contact dissipative surfaces, use fixtures made only of static safe materials.
- Keep the work area free of nonconductive materials, such as ordinary plastic assembly aids and Styrofoam.
- Handle ESD-sensitive components, parts, and assemblies by the case or PCM laminate. Handle these items only at static-free workstations.
- Avoid contact with pins, leads, or circuitry.
- Turn off power and input signals before inserting or removing connectors or test equipment.

Equipment guidelines

Grounding equipment must include either a wrist strap or a foot strap at a grounded workstation.

- When seated, wear a wrist strap connected to a grounded system. Wrist straps are flexible straps with a minimum of one megohm $\pm 10\%$ resistance in the ground cords. To provide proper ground, wear a strap snugly against the skin at all times. On grounded mats with banana-plug connectors, use alligator clips to connect a wrist strap.
- When standing, use foot straps and a grounded floor mat. Foot straps (heel, toe, or boot straps) can be used at standing workstations and are compatible with most types of shoes or boots. On conductive floors or dissipative floor mats, use foot straps on both feet with a minimum of one megohm resistance between the operator and ground. To be effective, the conductive must be worn in contact with the skin.

The following grounding equipment is recommended to prevent electrostatic damage:

- Antistatic tape
- Antistatic smocks, aprons, and sleeve protectors
- Conductive bins and other assembly or soldering aids
- Nonconductive foam
- Conductive tabletop workstations with ground cords of one megohm resistance
- Static-dissipative tables or floor mats with hard ties to the ground
- Field service kits
- Static awareness labels
- Material-handling packages
- Nonconductive plastic bags, tubes, or boxes
- Metal tote boxes
- Electrostatic voltage levels and protective materials

The following table lists the shielding protection provided by antistatic bags and floor mats.

Material	Use	Voltage protection level
Antistatic plastics	Bags	1,500 V
Carbon-loaded plastic	Floor mats	7,500 V
Metallized laminate	Floor mats	5,000 V

5 Removal and replacement procedures for Customer Self-Repair parts

This chapter provides removal and replacement procedures for Customer Self-Repair parts.

 **NOTE:** The Customer Self-Repair program is not available in all locations. Installing a part not supported by the Customer Self-Repair program may void your warranty. Check your warranty to determine if Customer Self-Repair is supported in your location.

Component replacement procedures

 **NOTE:** Details about your computer, including model, serial number, product key, and length of warranty, are on the service tag at the bottom of your computer. See [Labels on page 21](#) for details.

 **NOTE:** HP continually improves and changes product parts. For complete and current information on supported parts for your computer, go to <http://partsurfer.hp.com>, select your country or region, and then follow the on-screen instructions.

There are as many as 16 screws that must be removed, replaced, and/or loosened when servicing Customer Self-Repair parts. Make special note of each screw size and location during removal and replacement.

Bottom cover

Description	Spare part number
Bottom cover	L14360-001

Before removing the bottom cover, follow these steps:

1. Turn off the computer. If you are unsure whether the computer is off or in Hibernation, turn the computer on, and then shut it down through the operating system.
2. Disconnect the power from the computer by unplugging the power cord from the computer.
3. Disconnect all external devices from the computer.

Remove the bottom cover:

1. Turn the computer upside down on a flat surface.

2. Loosen the eight captive screws **(1)** and the two inset captive screws **(2)** that secure the bottom cover.

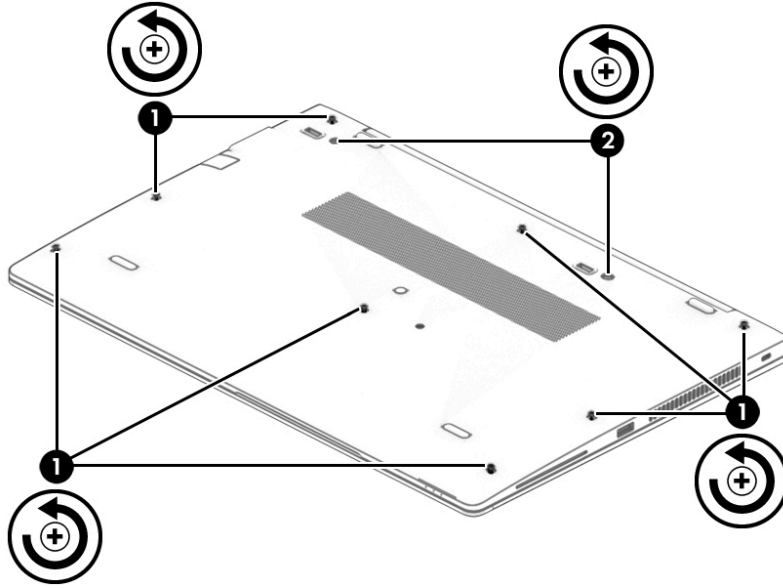

3. Starting under the middle of the display, pry **(1)** and lift the bottom cover off the computer **(2)**.

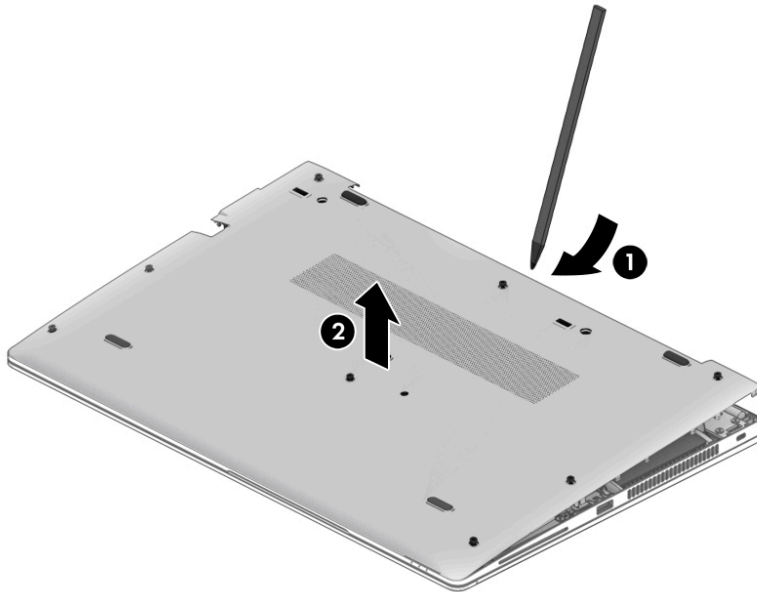

Reverse the removal procedures to install the bottom cover.

Solid-state drive (SSD)

Description	Spare part number
512 GB, PCIe, Gen3×4, Self-encrypting drive (SED), Opal 2, TLC	L22088-001
512 GB, SATA-3, FIPS-140-2, TLC	L22087-001
360 GB, PCIe Gen3×4, NVMe,TLC	L22090-001
256 GB, PCIe, Gen3x4, SS, NVMe, TLC	L22085-001
256 GB, SATA-3, self-encrypting drive (SED), Opal2	L22083-001
256 GB, SATA-3, Opal 2, TLC	L22086-001
128 GB, SATA-3, TLC	L22084-001

Before removing the solid-state drive, follow these steps:

1. Turn off the computer. If you are unsure whether the computer is off or in Hibernation, turn the computer on, and then shut it down through the operating system.
2. Disconnect the power from the computer by unplugging the power cord from the computer.
3. Disconnect all external devices from the computer.
4. Remove the bottom cover (see [Bottom cover on page 34](#)).
5. Disconnect the battery cable from the system board (see [Battery on page 47](#)).

Remove the solid-state drive:

1. Remove the Phillips M2.0×2.0 screw **(1)** that secures the drive to the system board.
2. Remove the drive by pulling it away from the connector **(2)**.

 **NOTE:** M.2 solid-state drives are designed with notches to prevent incorrect insertion.

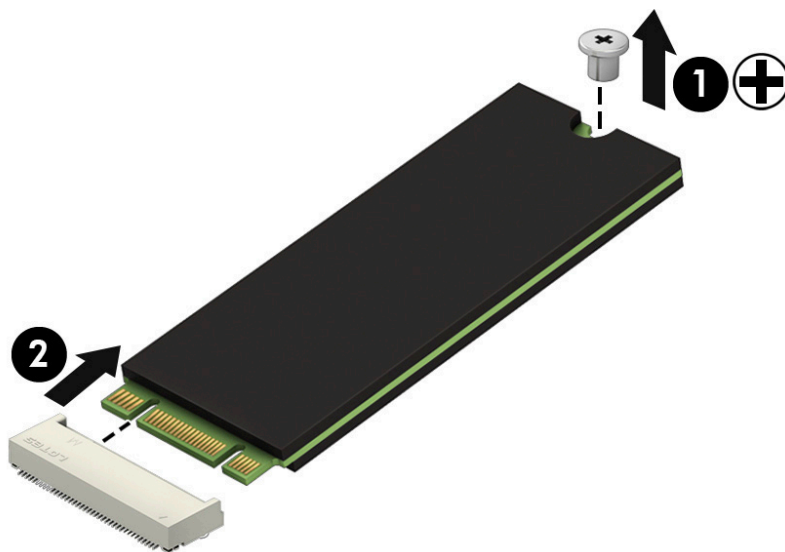

Reverse this procedure to install the solid-state drive.

Memory modules



NOTE: Primary and expansion memory is installed in a side-by-side configuration in the bottom of the computer.

If only one memory module is installed, it must be installed in the socket labeled '1'.

Description	Spare part number
4-GB (DDR-2400)	862397-850
8-GB (DDR-2133)	835887-001
16-GB (DDR-2133)	820571-001

Update BIOS before adding memory modules

Before adding new memory, make sure you update the computer to the latest BIOS.



CAUTION: Failure to update the computer to the latest BIOS prior to installing new memory may result in various system problems.

To update BIOS:

1. Navigate to www.hp.com.
2. Click **Support & Drivers** > click **Drivers & Software**.
3. In the **Enter a product name/number** box, type the computer model information, and then click **Search**.
4. Click the link for the computer model.
5. Select the operating system, and then click **Next**.
6. Under **Step 2: Select a Download**, click the **BIOS** link.
7. Click the link for the most recent BIOS.
8. Click the **Download** button, and then follow the on-screen instructions.

Before removing the memory module, follow these steps:

1. Shut down the computer. If you are unsure whether the computer is off or in Hibernation, turn the computer on, and then shut it down through the operating system.
2. Disconnect all external devices connected to the computer.
3. Disconnect the power from the computer by first unplugging the power cord from the AC outlet, and then unplugging the AC adapter from the computer.
4. Remove the bottom cover (see [Bottom cover on page 34](#)).
5. Disconnect the battery cable from the system board (see [Battery on page 47](#)).

Remove the memory module:

1. Spread the retaining tabs **(1)** on each side of the memory module slot to release the memory module. (The edge of the module opposite the slot rises away from the computer.)

2. Remove the memory module **(2)** by pulling the module away from the slot at an angle.

 **NOTE:** Memory modules are designed with a notch to prevent incorrect insertion into the memory module slot.

 **NOTE:** The computer uses two memory sockets. The socket labeled '2' houses the expansion memory module and the socket labeled '1' houses the primary memory module. The removal procedure is the same for both memory sockets.

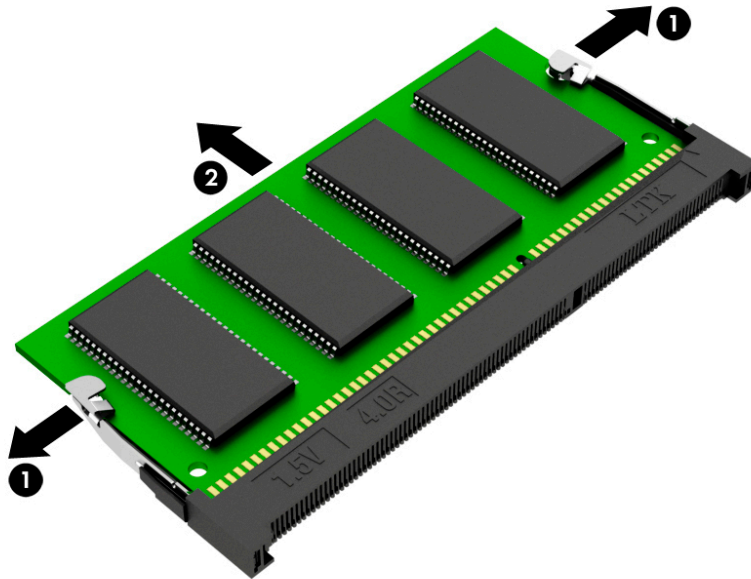

Reverse this procedure to install a memory module.

WLAN/Bluetooth combo card

The computer uses a card that provides both WLAN and Bluetooth functionality.

The WLAN module and WWAN module are not interchangeable.

Description	Spare part number
Realtek RTL8822BE 802.11ac 2x2 Wi-Fi + Bluetooth 4.2 Combo Adapter	915623-001
Intel Dual Band Wireless-AC 8260NGW 802.11a/g/g/n+ac 2x2 WiFi + BT 4.2 combo adapter	851594-001

Before removing the WLAN module, follow these steps:

1. Shut down the computer. If you are unsure whether the computer is off or in Hibernation, turn the computer on, and then shut it down through the operating system.
2. Disconnect all external devices connected to the computer.
3. Disconnect the power from the computer by first unplugging the power cord from the AC outlet, and then unplugging the AC adapter from the computer.
4. Remove the bottom cover (see [Bottom cover on page 34](#)).
5. Disconnect the battery cable from the system board (see [Battery on page 47](#)).

Remove the WLAN module:

1. Disconnect the WLAN antenna cables (**1**) from the terminals on the WLAN module.





NOTE: The WLAN antenna cable labeled '1' connects to the WLAN module "Main" terminal labeled '1'. The WLAN antenna cable labeled '2' connects to the WLAN module 'Aux' terminal labeled '2'. If the computer is equipped with an 802.11a/b/g/n WLAN module, the yellow WLAN antenna cable connects to the middle terminal on the WLAN module.

2. Remove the Phillips M2.0×2.0 screw (**2**) that secures the WLAN module to the computer. (The edge of the module opposite the slot rises away from the computer.)

3. Remove the WLAN module by pulling the module away from the slot at an angle **(3)**.

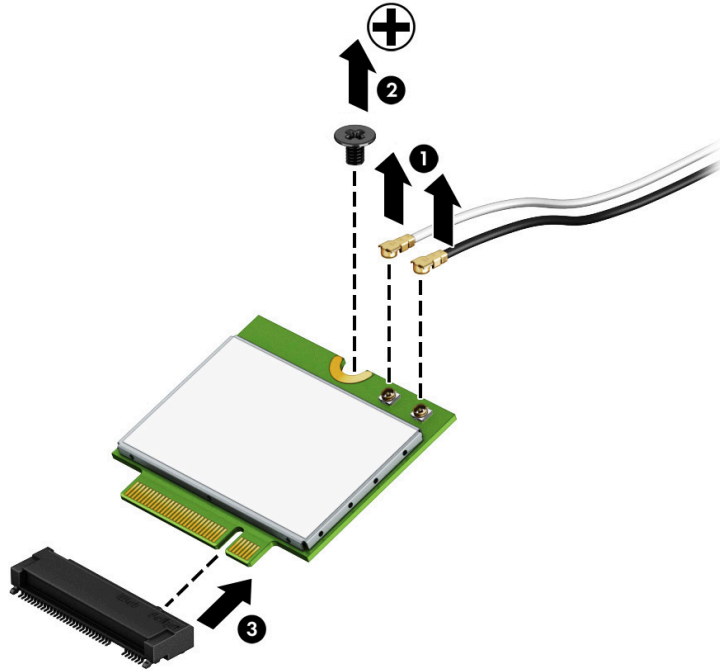
 **NOTE:** WLAN modules are designed with a notch to prevent incorrect insertion.



 **NOTE:** If the WLAN antennas are not connected to the terminals on the WLAN module, the protective sleeves must be installed on the antenna connectors, as shown in the following illustration.

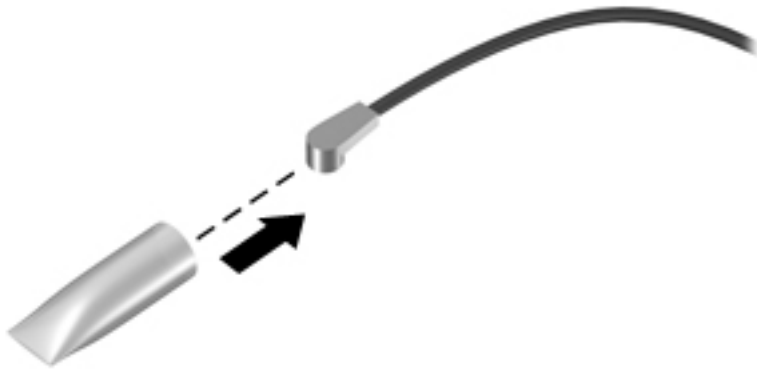

Reverse this procedure to install the WLAN module.

WWAN module

The WLAN module and WWAN module are not interchangeable.

The WWAN module is available on select models only.

Description	Spare part number
LTE CAT4: Huawei HP Lt4132, LTE/HSPA+ w/GPS	845710-003
LTE CAT9: Fibocom Intel XMM 7360 LTE-Advanced	L15398-001

Before removing the WWAN module, follow these steps:

1. Shut down the computer. If you are unsure whether the computer is off or in Hibernation, turn the computer on, and then shut it down through the operating system.
2. Disconnect all external devices connected to the computer.
3. Disconnect the power from the computer by first unplugging the power cord from the AC outlet, and then unplugging the AC adapter from the computer.
4. Remove the bottom cover (see [Bottom cover on page 34](#)).
5. Disconnect the battery cable from the system board (see [Battery on page 47](#)).

Remove the WWAN module:

1. Position the computer upside-down.
2. Disconnect the WWAN antenna cables **(1)** from the terminals on the WWAN module.





NOTE: The red WWAN antenna cable is connected to the WWAN module 'Main' terminal. The blue WWAN antenna cable is connected to the WWAN module 'Aux' terminal.

3. Remove the Phillips M2.0×2.0 screw **(2)** that secures the WWAN module to the computer. (The edge of the module opposite the slot rises away from the computer.)

4. Remove the WWAN module (3) by pulling the module away from the slot at an angle.

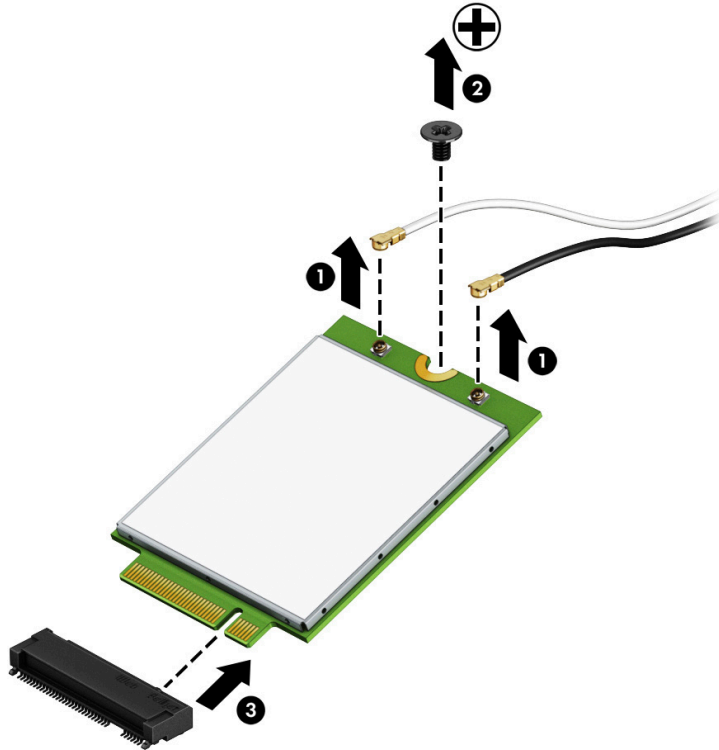
 **NOTE:** WWAN modules are designed with a notch to prevent incorrect insertion.



 **NOTE:** If the WWAN antennas are not connected to the terminals on the WWAN module, the protective sleeves must be installed on the antenna connectors, as shown in the following illustration.

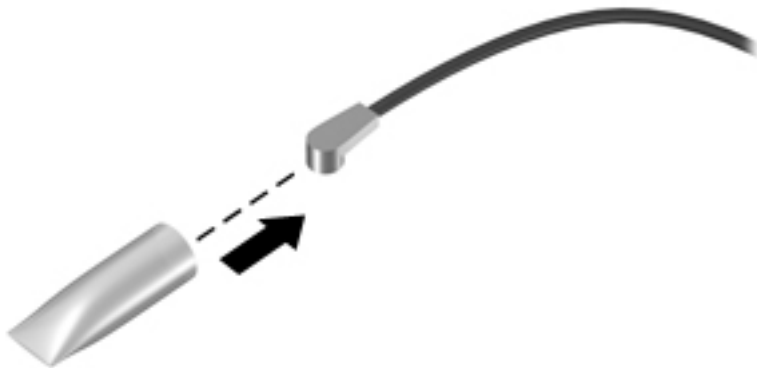

Reverse this procedure to install the WWAN module.

Keyboard

In this section, the first table provides the main spare part number for the keyboards. The second table provides the country codes.

Description	Spare part number
Keyboard, no backlight	L14367-xx1
Keyboard, backlit	L14366-xx1
Keyboard, backlit, privacy	L29477-001
Pointing stick covers, quantity of 20	L15396-001

For use in country or region	Spare part number	For use in country or region	Spare part number	For use in country or region	Spare part number
Belgium	-A41	India	-D61	Slovenia	-BA1
Brazil	-201	Israel	-BB1	South Korea	-AD1
Bulgaria	-261	Italy	-061	Spain	-071
Canada	-DB1	Japan	-291	Sweden and Finland	-B71
Czech Republic and Slovakia	-FL1	Latin America	-161	Switzerland	-BG1
Denmark	-081	The Netherlands	-B31	Taiwan	-AB1
Denmark, Finland, and Norway	-DH1	Northern Africa	-FP1	Thailand	-281
France	-051	Norway	-091	Turkey	-141
Germany	-041	Portugal	-131	Turkey F	-541
Greece	-151	Romania	-271	United Kingdom	-031
Hungary	-211	Russia	-251	United States	-001
Iceland	-DD1	Saudi Arabia	-171		

Before removing the keyboard, follow these steps:

1. Shut down the computer. If you are unsure whether the computer is off or in Hibernation, turn the computer on, and then shut it down through the operating system.
2. Disconnect all external devices connected to the computer.
3. Disconnect the power from the computer by first unplugging the power cord from the AC outlet, and then unplugging the AC adapter from the computer.
4. Remove the bottom cover (see [Bottom cover on page 34](#)).
5. Disconnect the battery cable from the system board (see [Battery on page 47](#)).

Remove the keyboard:

1. Remove the three Phillips M2.0×3.0 screws that secure the keyboard to the computer **(1)**.

 **NOTE:** The screws are labeled with a keyboard symbol.

2. Insert a screwdriver or similar thin tool into the release hole near the fan, and then press on the back of the keyboard until it disengages from the computer **(2)**.

 **NOTE:** Cables connect the bottom of the keyboard to the system board. Make sure not to prematurely pull the keyboard cables out of the system board connectors.

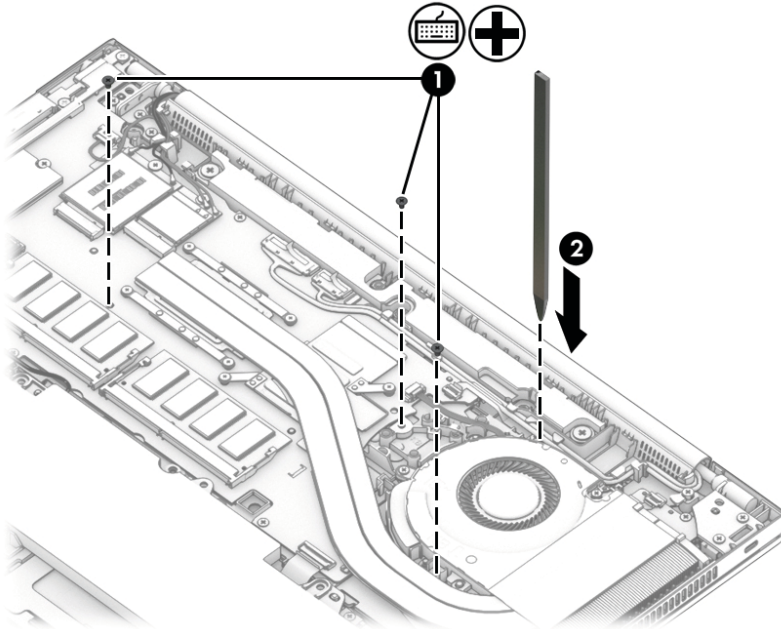

3. Position the computer upright with the front toward you, and then open the computer as far as possible.
4. Lift to disengage the top of the keyboard **(1)**, and then rotate the keyboard over onto the palm rest **(2)**.

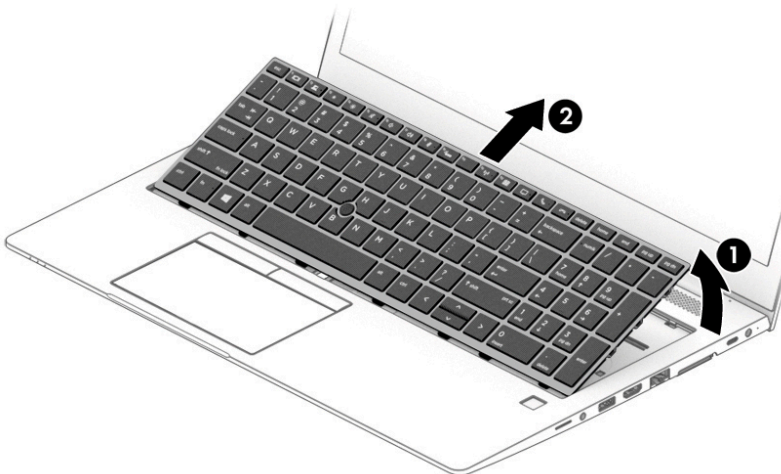

5. With the keyboard resting on the palm rest **(1)**, disconnect the keyboard backlight cable from the system board ZIF connector **(2)** (select models only).
6. Disconnect the pointing stick cable from the system board ZIF connector **(3)**.
7. Disconnect the main keyboard cable from the system board ZIF connector **(4)**.

8. Remove the keyboard (5).

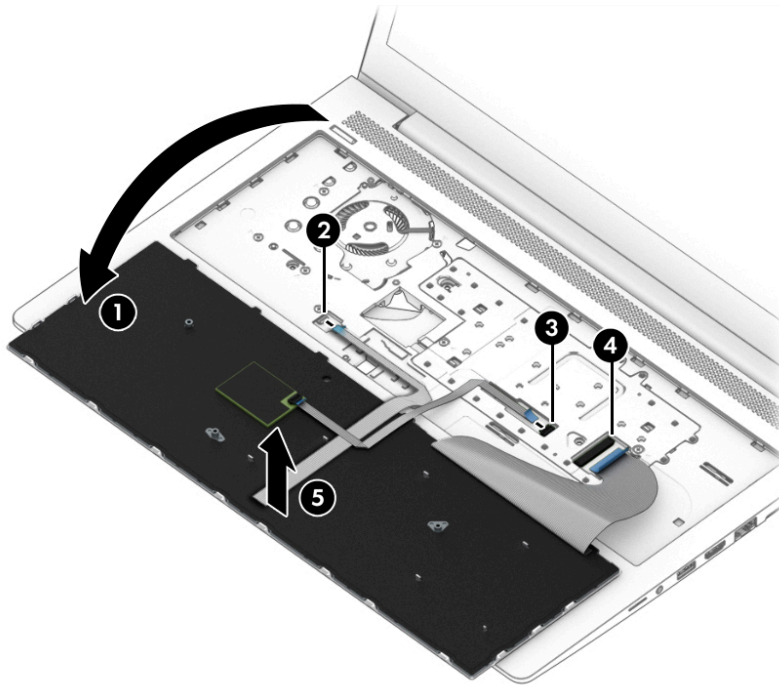

Reverse this procedure to install the keyboard.

6 Removal and replacement procedures for Authorized Service Provider parts

This chapter provides removal and replacement procedures for Authorized Service Provider only parts.

 **CAUTION:** Components described in this chapter should only be accessed by an authorized service provider. Accessing these parts can damage the computer or void the warranty.

CAUTION: Only HP authorized service providers should perform the removal and replacement procedures described here. Accessing the internal part could damage the computer or void the warranty.

Component replacement procedures

 **NOTE:** Details about your computer, including model, serial number, product key, and length of warranty, are on the service tag at the bottom of your computer. See [Labels on page 21](#) for details.

 **NOTE:** HP continually improves and changes product parts. For complete and current information on supported parts for your computer, go to <http://partsurfer.hp.com>, select your country or region, and then follow the on-screen instructions.

There are as many as 63 screws that must be removed, replaced, and/or loosened when servicing Authorized Service Provider only parts. Make special note of each screw size and location during removal and replacement.

Battery

Description	Spare part number
Battery, 3 cell, 56 WHr, 4.85 Ah	933322-855

 **NOTE:** It is recommended that the battery power cable be disconnected from the system board before removing any part. You can disconnect the cable without removing the battery.

Before removing the battery, follow these steps:

1. Shut down the computer. If you are unsure whether the computer is off or in Hibernation, turn the computer on, and then shut it down through the operating system.
2. Disconnect all external devices connected to the computer.
3. Disconnect the power from the computer by first unplugging the power cord from the AC outlet, and then unplugging the AC adapter from the computer.
4. Remove the bottom cover (see [Bottom cover on page 34](#)).

To remove the battery:

 **CAUTION:** Removing a battery that is the sole power source for the computer can cause loss of information. To prevent loss of information, save your work and shut down the computer through Windows before removing the battery.

1. Disconnect the battery cable from the system board **(1)**.
2. Remove the four Torx T8 2.0×4.0 screws **(2)**.

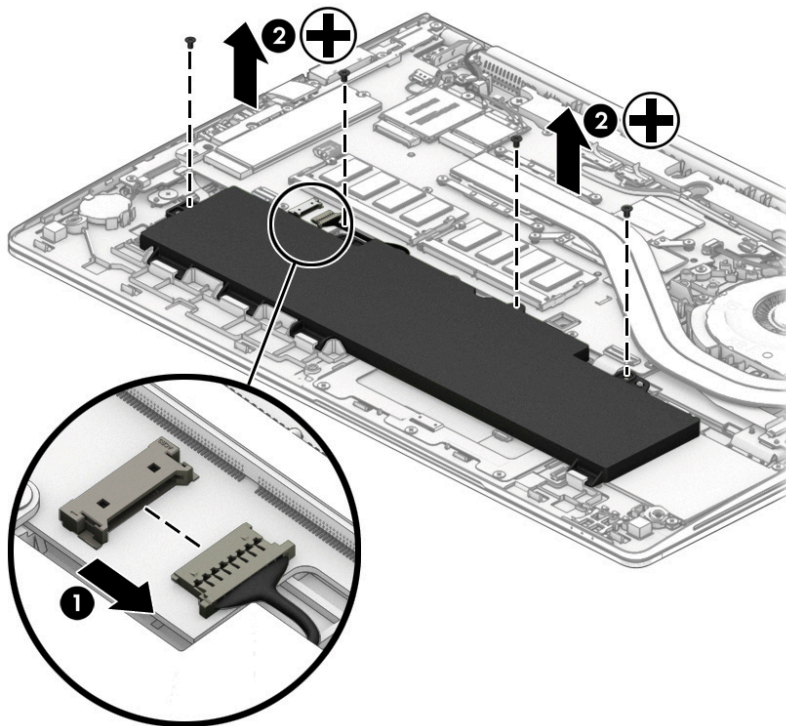

3. Rotate the top of the battery upward **(1)**, and then lift the battery out of the computer **(2)**.

 **IMPORTANT:** When installing the battery, insert the tabs on the bottom of battery into the clips built into the computer **(3)**, and then rotate the battery into place

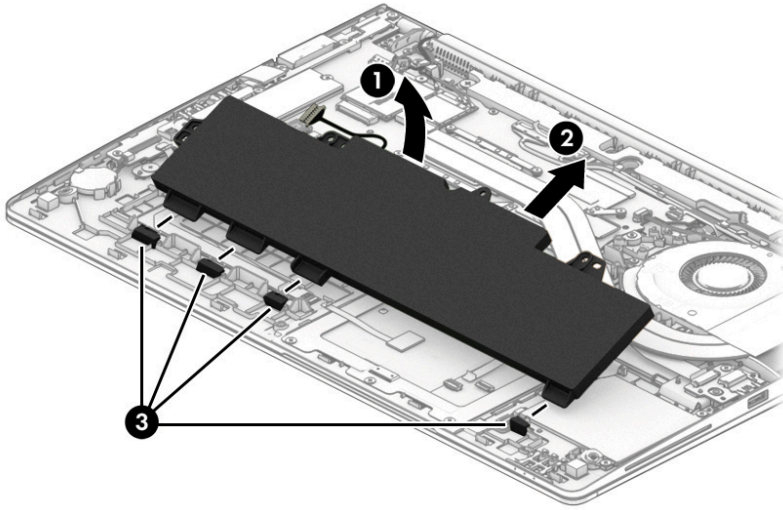

Reverse the removal procedures to install the battery.

Heat sink assembly



NOTE: The heat sink assembly spare part kit includes replacement thermal material.

Description	Spare part number
Heat sink	L14362-001

Before removing the heat sink assembly, follow these steps:

1. Turn off the computer. If you are unsure whether the computer is off or in Hibernation, turn the computer on, and then shut it down through the operating system.
2. Disconnect the power from the computer by unplugging the power cord from the computer.
3. Disconnect all external devices from the computer.
4. Remove the bottom cover (see [Bottom cover on page 34](#)).
5. Disconnect the battery cable from the system board (see [Battery on page 47](#)).

Remove the heat sink assembly:

1. Loosen the four captive screws on the heat sink following the sequence stamped on the heat sink **(1)**, and then remove the heat sink from the system board **(2)**.

CAUTION: Take extreme care when removing the heat sink and fan assembly. The heatpipe is very fragile and can be easily damaged and bent during removal.

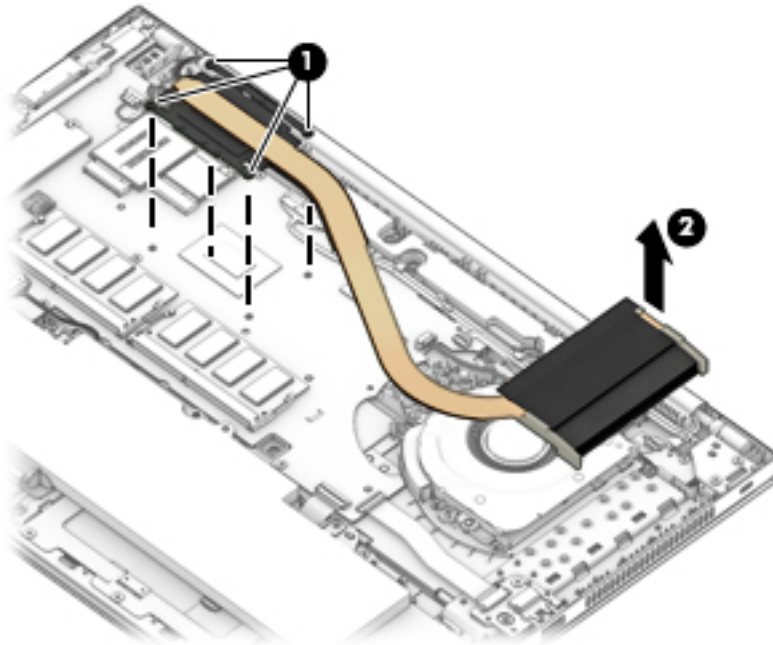

2. Thoroughly clean the thermal material from the surfaces of the system board component **(1)** and the heat sink **(2)** each time the heat sink is removed. Replacement thermal material is included with the heat sink and system board spare part kits.

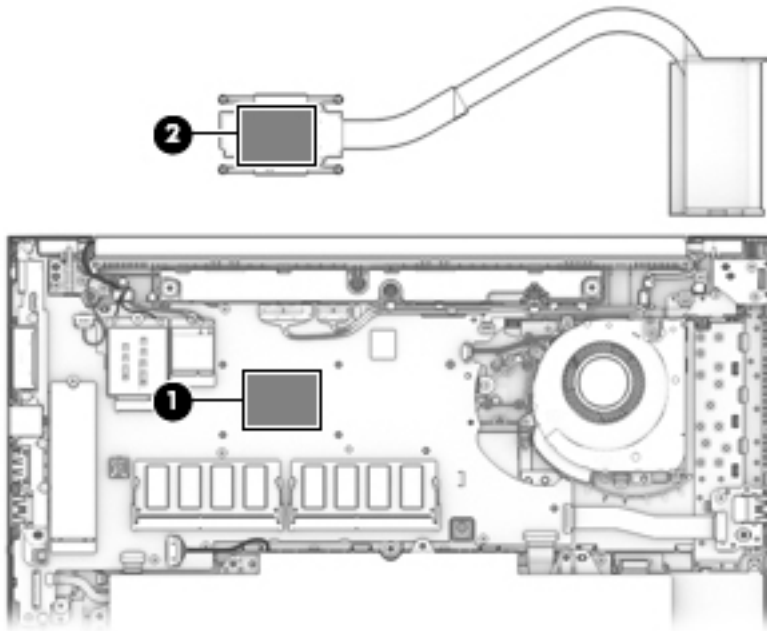

Reverse this procedure to install the heat sink.

RTC battery

Description	Spare part number
RTC battery	L17255-001

Before removing the RTC battery, follow these steps:

1. Shut down the computer. If you are unsure whether the computer is off or in Hibernation, turn the computer on, and then shut it down through the operating system.
2. Disconnect all external devices connected to the computer.
3. Disconnect the power from the computer by first unplugging the power cord from the AC outlet, and then unplugging the AC adapter from the computer.
4. Remove the bottom cover (see [Bottom cover on page 34](#)).
5. Disconnect the battery cable from the system board (see [Battery on page 47](#)).

Remove the RTC battery:

1. Disconnect the RTC battery cable from the system board **(1)**.
2. Using a flat tool, pry the battery from the holder **(2)**, and then remove the battery from the computer **(3)**.

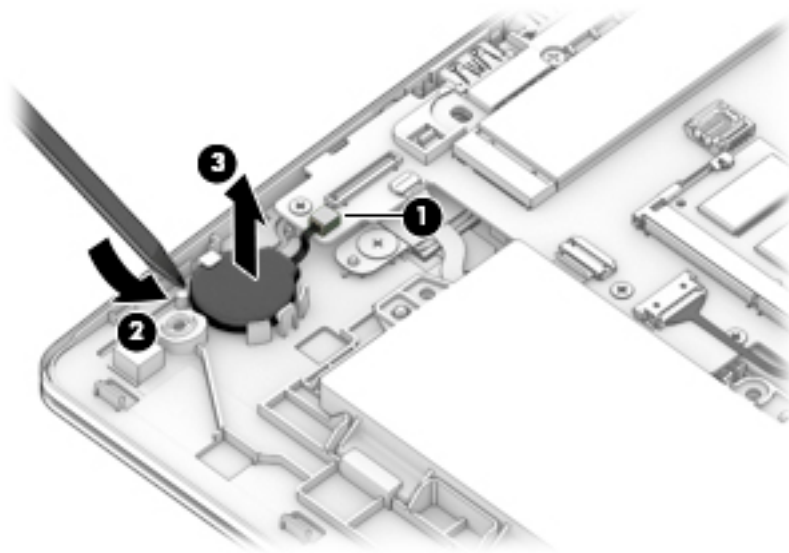

Reverse this procedure to install the RTC battery.

USB board

Description	Spare part number
USB board (includes bracket)	L14380-001

Before removing the USB board, follow these steps:

1. Shut down the computer. If you are unsure whether the computer is off or in Hibernation, turn the computer on, and then shut it down through the operating system.
2. Disconnect all external devices connected to the computer.
3. Disconnect the power from the computer by first unplugging the power cord from the AC outlet, and then unplugging the AC adapter from the computer.
4. Remove the bottom cover (see [Bottom cover on page 34](#)).
5. Disconnect the battery cable from the system board (see [Battery on page 47](#)).

Remove the USB board:

1. Disconnect the cable from the USB board **(1)**.
2. Remove the Phillips M2.0×3.0 screw **(2)** that secures the board to the computer.
3. Lift the bracket from atop the board **(3)**.
4. Remove the board from the computer **(4)**.

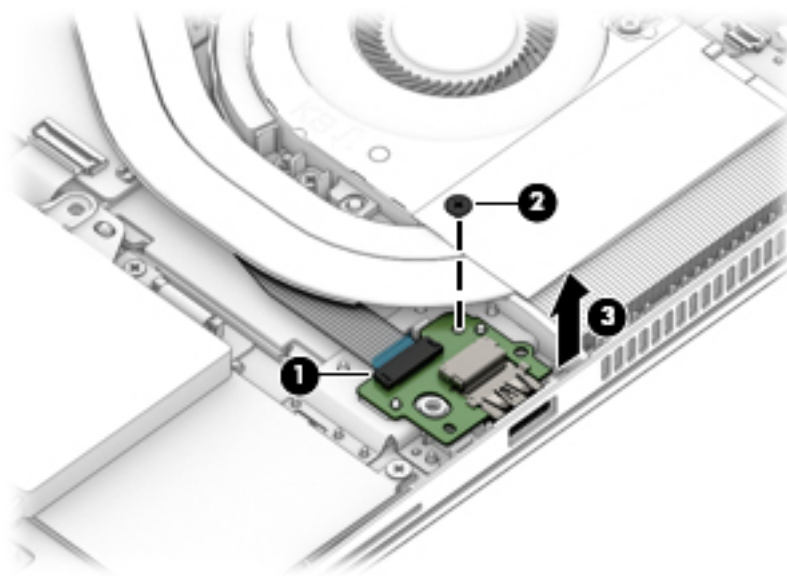

Reverse this procedure to install the USB board.

RJ-45 board with bracket

Description	Spare part number
RJ-45 board with bracket	L14386-001

Before removing the RJ-45 board and bracket, follow these steps:

1. Shut down the computer. If you are unsure whether the computer is off or in Hibernation, turn the computer on, and then shut it down through the operating system.
2. Disconnect all external devices connected to the computer.
3. Disconnect the power from the computer by first unplugging the power cord from the AC outlet, and then unplugging the AC adapter from the computer.
4. Remove the bottom cover (see [Bottom cover on page 34](#)).
5. Disconnect the battery cable from the system board (see [Battery on page 47](#)).

Remove the RJ-45 board and bracket:

1. Remove the five Phillips M2.5×5.0 screws **(1)** that secure the assembly to the computer.
2. Rotate the assembly out of the computer **(2)**.

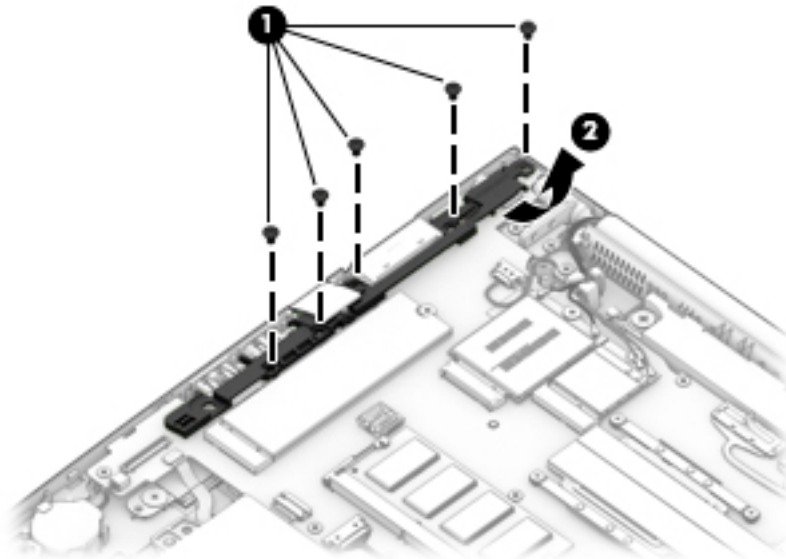

Reverse this procedure to install the RJ-45 assembly.

Power button board

Description	Spare part number
Power button board assembly	L14374-001

Before removing the power button board, follow these steps:

1. Shut down the computer. If you are unsure whether the computer is off or in Hibernation, turn the computer on, and then shut it down through the operating system.
2. Disconnect all external devices connected to the computer.
3. Disconnect the power from the computer by first unplugging the power cord from the AC outlet, and then unplugging the AC adapter from the computer.
4. Remove the bottom cover (see [Bottom cover on page 34](#)).
5. Disconnect the battery cable from the system board (see [Battery on page 47](#)).

Remove the power button board:



NOTE: The power button board sits under the right display hinge. You do not have to remove the display to remove the board, but you do have to rotate the right display hinge upward to gain access.

1. Remove the two Phillips M2.5×5.0 screws **(1)** that secure the right display hinge, and then rotate the hinge upward from atop the power button board **(2)**.
2. Disconnect the cable from the power button board **(3)**.
3. Remove the Phillips M2.0×3.0 screw **(4)** that secures the power button board to the computer.
4. Remove the power button board from the computer **(5)**.

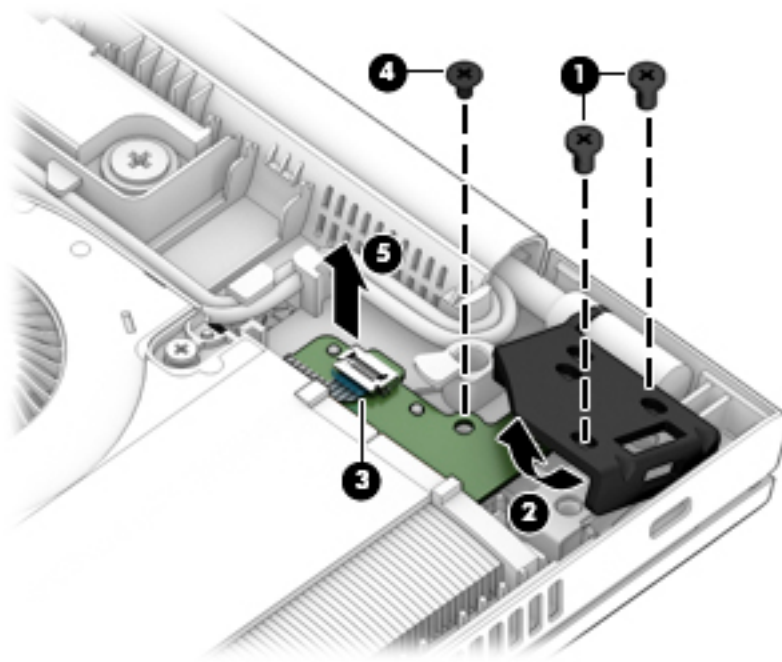

Reverse this procedure to install the power button board.

Speaker assembly

Description	Spare part number
Speaker assembly (includes cable)	L14368-001

Before removing the speaker assembly, follow these steps:

1. Turn off the computer. If you are unsure whether the computer is off or in Hibernation, turn the computer on, and then shut it down through the operating system.
2. Disconnect the power from the computer by unplugging the power cord from the computer.
3. Disconnect all external devices from the computer.
4. Remove the bottom cover (see [Bottom cover on page 34](#)).
5. Disconnect the battery cable from the system board (see [Battery on page 47](#)).

Remove the speaker assembly:

1. Disconnect the speaker cable from the system board **(1)**, and then remove the cable from the clip **(2)**.
2. Remove the two Phillips M2.0×2.5 screws **(3)** that secure the speaker to the computer.
3. Remove the speaker from the computer **(4)**.

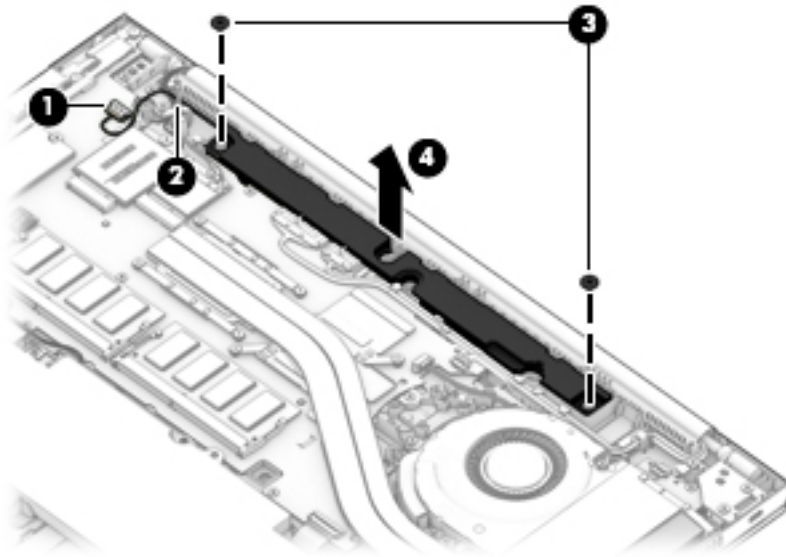

Reverse this procedure to install the speaker.

Fingerprint reader assembly

Description	Spare part number
Fingerprint reader assembly	L13681-001
Fingerprint reader insert (for use in models without a fingerprint reader)	L22111-001 (Plastics Kit)

Before removing the fingerprint reader assembly, follow these steps:

1. Shut down the computer. If you are unsure whether the computer is off or in Hibernation, turn the computer on, and then shut it down through the operating system.
2. Disconnect all external devices connected to the computer.
3. Disconnect the power from the computer by first unplugging the power cord from the AC outlet, and then unplugging the AC adapter from the computer.
4. Remove the bottom cover (see [Bottom cover on page 34](#)).
5. Remove the battery (see [Battery on page 47](#)).

Remove the fingerprint reader assembly:

1. Remove the Phillips M2.0×3.0 screw (1) that secures the fingerprint reader bracket to the computer.
2. Lift the bracket from atop the fingerprint reader assembly (2).
3. Use a tool to pry the fingerprint reader board free from the computer (3), and then remove the assembly from the computer (4).

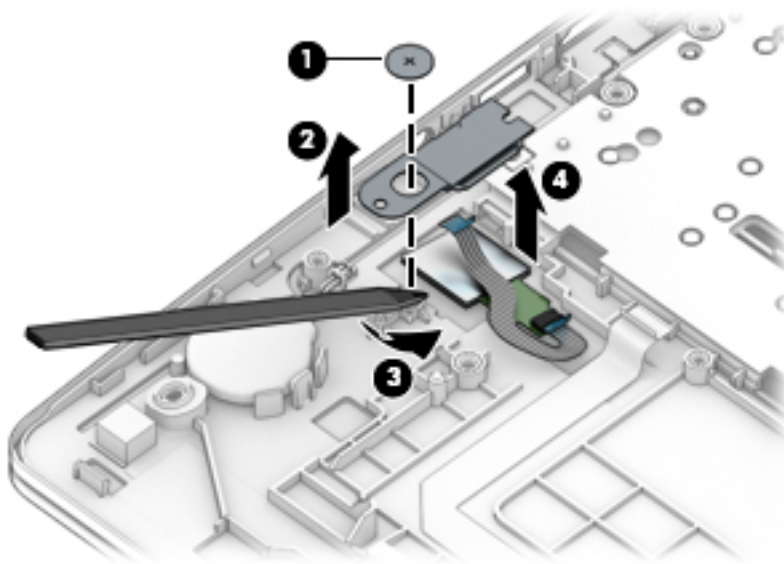

Reverse this procedure to install the fingerprint reader assembly.

TouchPad

Description	Spare part number
TouchPad for use in models without an NFC module	L14369-001
TouchPad for use in models with an NFC module	L19416-001

Before removing the TouchPad, follow these steps:

1. Shut down the computer. If you are unsure whether the computer is off or in Hibernation, turn the computer on, and then shut it down through the operating system.
2. Disconnect all external devices connected to the computer.
3. Disconnect the power from the computer by first unplugging the power cord from the AC outlet, and then unplugging the AC adapter from the computer.
4. Remove the bottom cover (see [Bottom cover on page 34](#)).
5. Remove the battery (see [Battery on page 47](#)).

Remove the TouchPad:

1. Disconnect the NFC module cable from the ZIF connector on the NFC module **(1)**.
2. Disconnect the TouchPad button board cable from the ZIF connector on the TouchPad **(2)**.
3. Disconnect the card reader cable from the ZIF connector on the TouchPad **(3)**.

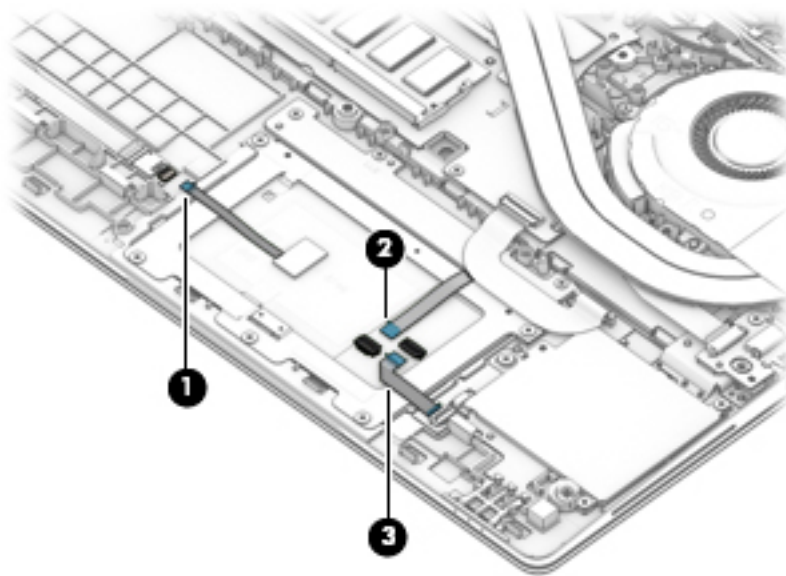

4. Remove the five Phillips M2.0x2.5 screws **(1)** that secure the TouchPad to the computer.

5. Remove the TouchPad from the computer (2).

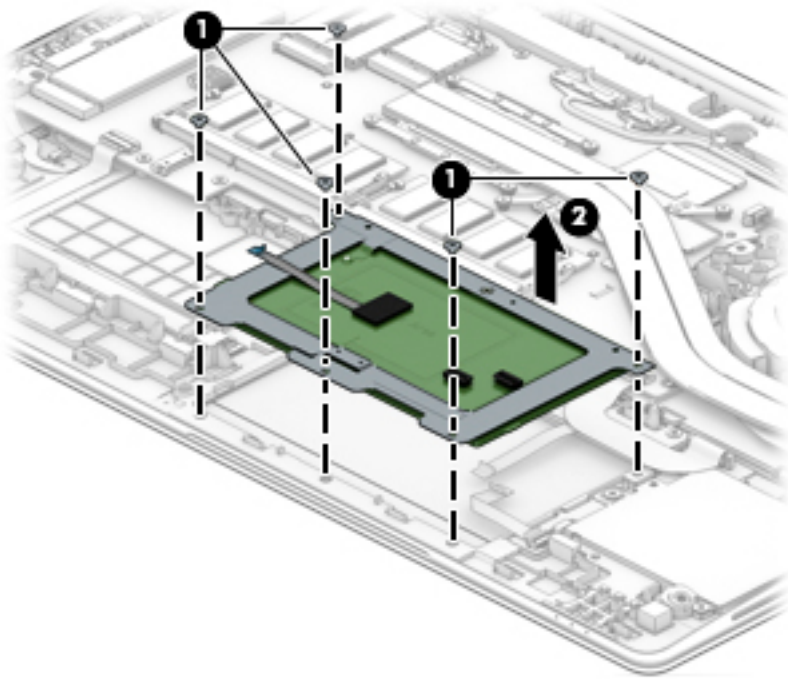

Reverse this procedure to install the TouchPad.

TouchPad button board

Description	Spare part number
TouchPad button board	L18311-001

Before removing the TouchPad button board, follow these steps:

1. Shut down the computer. If you are unsure whether the computer is off or in Hibernation, turn the computer on, and then shut it down through the operating system.
2. Disconnect all external devices connected to the computer.
3. Disconnect the power from the computer by first unplugging the power cord from the AC outlet, and then unplugging the AC adapter from the computer.
4. Remove the bottom cover (see [Bottom cover on page 34](#)).
5. Remove the battery (see [Battery on page 47](#)).

Remove the TouchPad button board:

1. Disconnect the TouchPad button board cable from the ZIF connector on the TouchPad **(1)**.
2. Remove the four Phillips M2.0x3.0 screws **(2)** that secure the board to the computer, and then remove the board from the computer **(3)**.

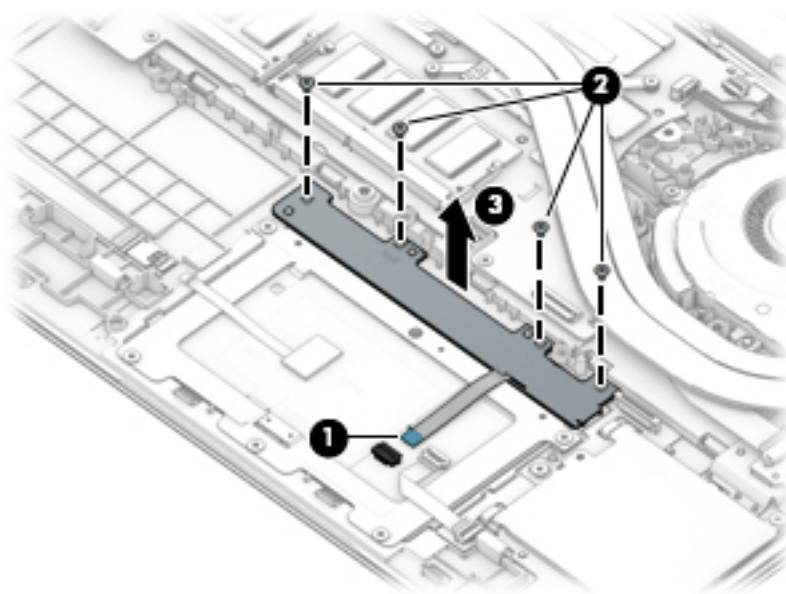

Reverse this procedure to install the TouchPad button board.

NFC module

Description	Spare part number
NFC module (includes antenna and TouchPad foam)	L14385-001

Before removing the NFC module, follow these steps:

1. Turn off the computer. If you are unsure whether the computer is off or in Hibernation, turn the computer on, and then shut it down through the operating system.
2. Disconnect the power from the computer by unplugging the power cord from the computer.
3. Disconnect all external devices from the computer.
4. Remove the bottom cover (see [Bottom cover on page 34](#)).
5. Remove the battery (see [Battery on page 47](#)).

Remove the NFC module:

1. Disconnect the system board cable **(1)** and the NFC antenna **(2)** from the ZIF connectors on the NFC module.
2. Use a tool to release the NFC module from the adhesive securing it to the computer **(3)**, and then remove the module from the computer **(4)**.

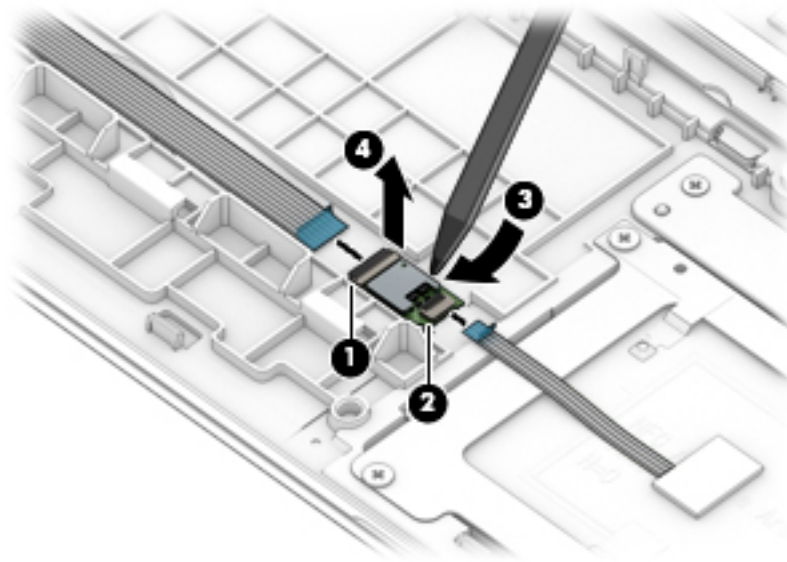

Reverse the removal procedures to install the NFC module.

Smart card reader

Description	Spare part number
Smart card reader	L18312-001
Smart card reader cable (available in Cable Kit)	L14361-001 (Cable Kit)
Smart card reader insert (for use in models without a smart card reader)	L22111-001 (Plastics Kit)
Smart card insert	L22111-001 (Plastics Kit)

Before removing the card reader, follow these steps:

1. Shut down the computer. If you are unsure whether the computer is off or in Hibernation, turn the computer on, and then shut it down through the operating system.
2. Disconnect all external devices connected to the computer.
3. Disconnect the power from the computer by first unplugging the power cord from the AC outlet, and then unplugging the AC adapter from the computer.
4. Remove the bottom cover (see [Bottom cover on page 34](#)).
5. Remove the battery (see [Battery on page 47](#)).

Remove the smart card reader:



NOTE: Before you remove the smart card reader, make sure nothing (memory card or plastic insert) is inserted in the reader.

1. Disconnect the system board cable from the connector on the smart card reader board (1).
2. Disconnect the TouchPad cable from the ZIF connector on the smart card reader board (2).
3. Remove the three Phillips M2.0x2.5 screws (3) that secure the smart card reader to the computer.
4. Remove the smart card reader from the computer (4).

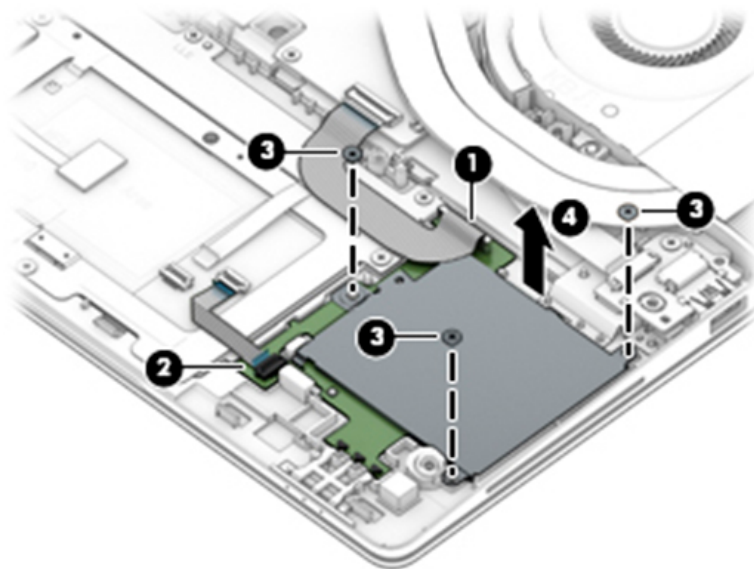

Reverse this procedure to install the smart card reader.

Fan

Description	Spare part number
Fan	L22307-001

Before removing the fan, follow these steps:

1. Shut down the computer. If you are unsure whether the computer is off or in Hibernation, turn the computer on, and then shut it down through the operating system.
2. Disconnect all external devices connected to the computer.
3. Disconnect the power from the computer by first unplugging the power cord from the AC outlet, and then unplugging the AC adapter from the computer.
4. Remove the bottom cover (see [Bottom cover on page 34](#)).
5. Remove the battery (see [Battery on page 47](#)).
6. Remove the keyboard (see [Keyboard on page 43](#)).

Remove the fan:



NOTE: To remove the fan you must remove screws from both the top (under the keyboard) and bottom of the computer.

1. Position the computer upright and open as far as possible.
2. Remove the four Phillips M2.0×3.0 screws that secure the fan to the computer.

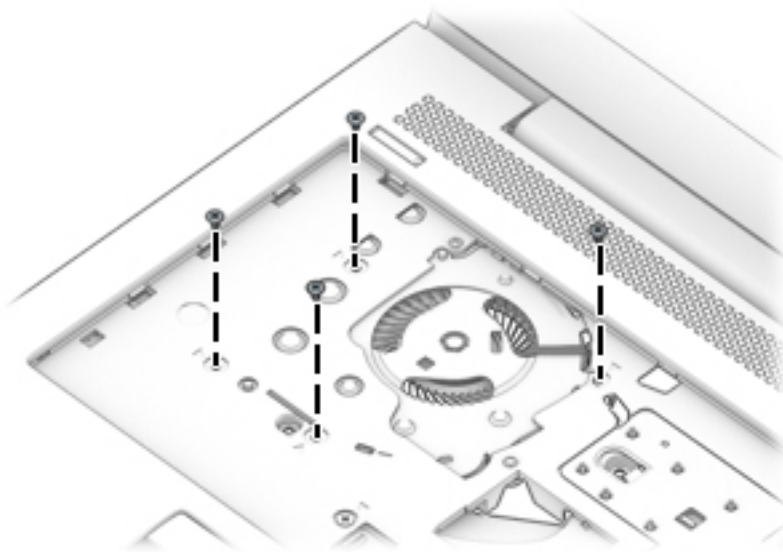

3. Close the computer and position it upside down.
4. Disconnect the fan cable from the system board **(1)**.
5. Remove the Phillips M2.0×3.0 screw **(2)** that secures the fan to the computer.
6. Loosen the two captive Phillips screws **(3)** that secure the fan to the computer.

7. Remove the fan from the computer (4).

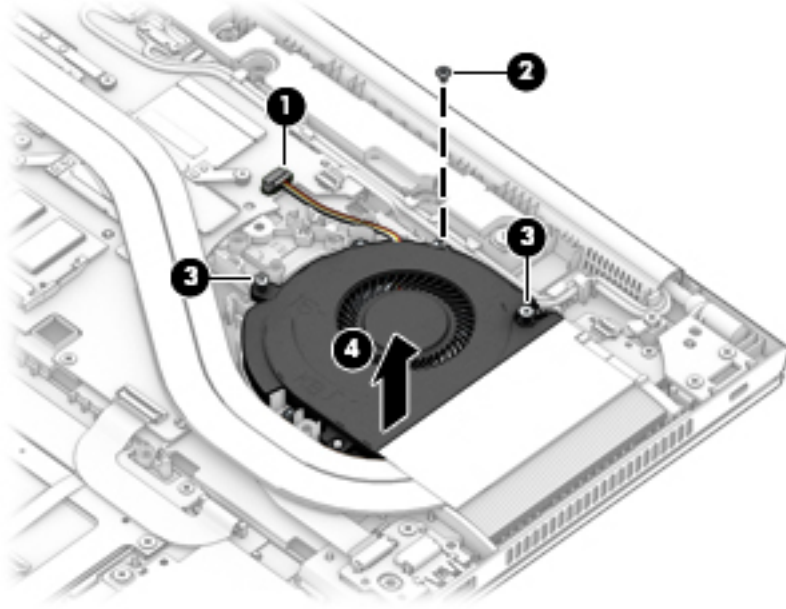

Reverse this procedure to install the fan.

System board



NOTE: All system board spare part kits include replacement thermal material.

All system boards use the following part numbers:

xxxxxx-001: Non-Windows operating systems

xxxxxx-601: Windows operating system

Description	Spare part number
System board with AMD Ryzen 7 PRO 2700U processor	L21938-xx1
System board with AMD Ryzen 5 PRO 2500U processor	L21937-xx1
System board with AMD Ryzen 3 PRO 2300U processor	L21936-xx1

Before removing the system board, follow these steps:

1. Shut down the computer. If you are unsure whether the computer is off or in Hibernation, turn the computer on, and then shut it down through the operating system.
2. Disconnect all external devices connected to the computer.
3. Disconnect the power from the computer by first unplugging the power cord from the AC outlet, and then unplugging the AC adapter from the computer.
4. Remove the bottom cover (see [Bottom cover on page 34](#)).
5. Remove the battery (see [Battery on page 47](#)).
6. Remove the keyboard (see [Keyboard on page 43](#)).
7. Remove the RJ-45 board and bracket (see [RJ-45 board with bracket on page 53](#)).
8. Remove the fan (see [Fan on page 62](#)).

When replacing the system board, be sure to remove the following components (as applicable) from the defective system board and install on the replacement system board:

- SIM card blank (only models without WWAN)



IMPORTANT: After removing the system board, remove the SIM card blank from the old system board and insert into the new system board.

- Solid-state drive (see [Solid-state drive \(SSD\) on page 36](#))
- Memory modules (see [Memory modules on page 37](#))
- WLAN/Bluetooth module (see [WLAN/Bluetooth combo card on page 39](#))
- WWAN module (see [WWAN module on page 41](#))
- Heat sink (see [Heat sink assembly on page 49](#))

Remove the system board:

1. Position the computer upright and open as far as possible.

2. Remove the three Phillips M2.5×3.0 screws that secure the system board to the computer.

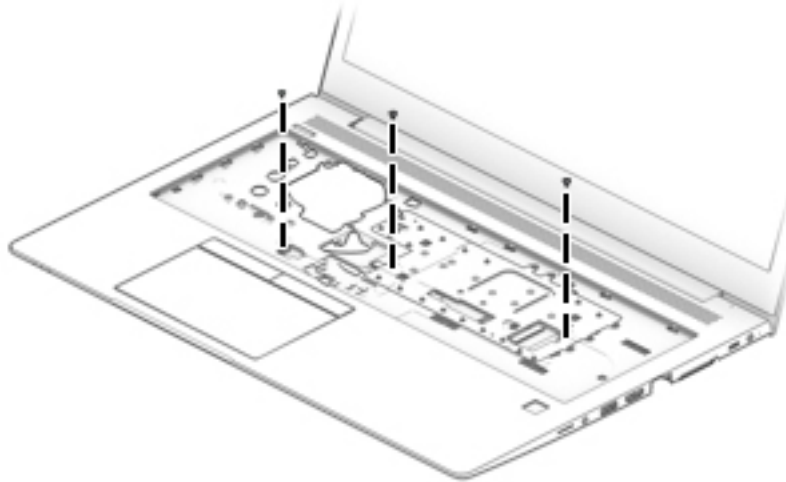

3. Close the computer and position it upside down.
4. Disconnect the following cables from the system board:
 - (1) Speaker cable
 - (2) Display cable
 - (3) Camera cable
 - (4) Power button board cable
 - (5) USB cable
 - (6) Smart card reader cable
 - (7) NFC module cable
 - (8) RTC battery cable
 - (9) Fingerprint reader cable

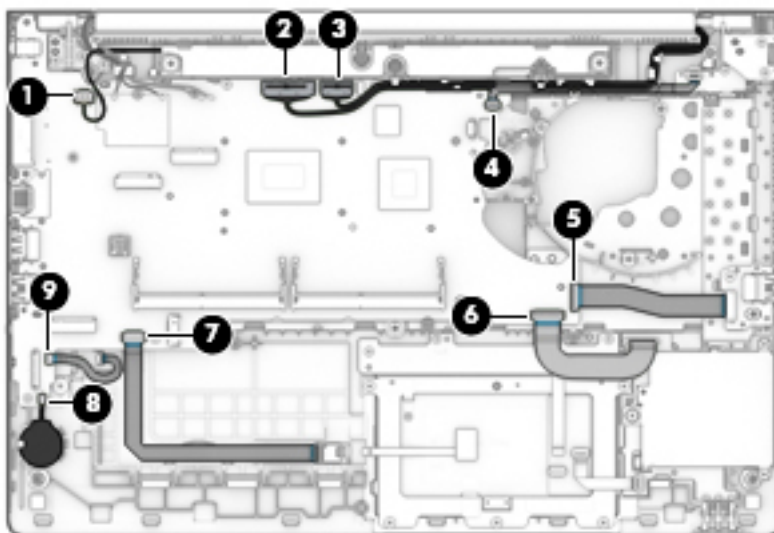

5. Remove the six Phillips M2.5×3.0 screws that secure the system board to the computer.

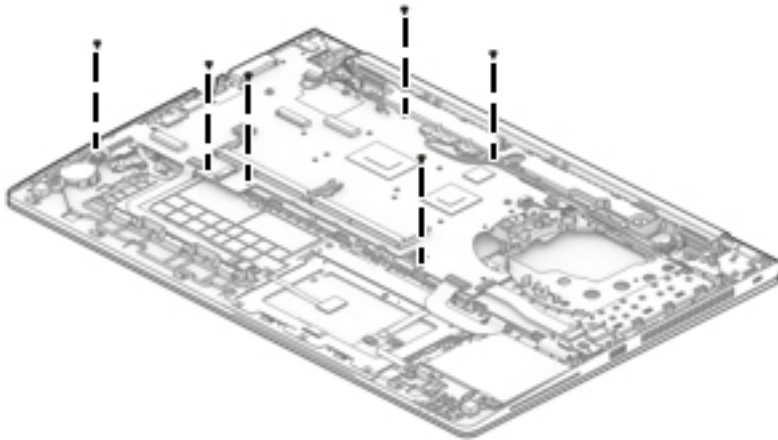

6. Lift the right side of the system board up at an angle (1).
7. Pull the system board up and toward the right to disengage the connectors from the left side of the computer, and then remove the system board (2).

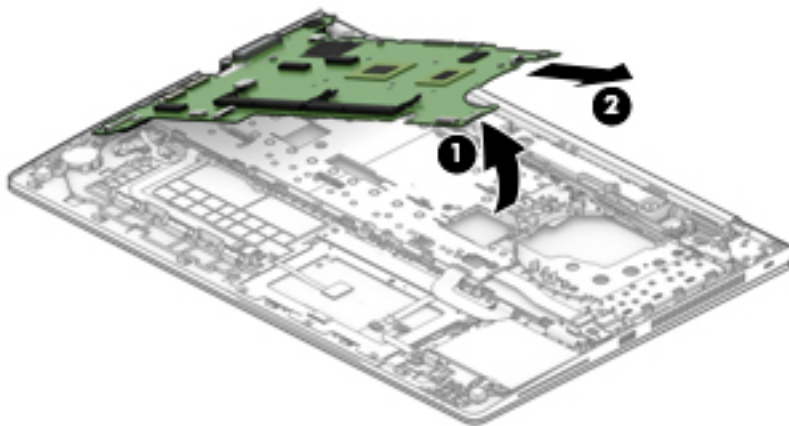

Reverse this procedure to install the system board.

Display assembly

 **NOTE:** Display assemblies are spared at the subcomponent level only. Additional display assembly spare part information is available at [Display assembly subcomponents on page 25](#).

Before removing the display assembly, follow these steps:

1. Shut down the computer. If you are unsure whether the computer is off or in Hibernation, turn the computer on, and then shut it down through the operating system.
2. Disconnect all external devices connected to the computer.
3. Disconnect the power from the computer by first unplugging the power cord from the AC outlet, and then unplugging the AC adapter from the computer.
4. Remove the bottom cover (see [Bottom cover on page 34](#)).
5. Disconnect the battery cable from the system board (see [Battery on page 47](#)).

Remove the display assembly:

1. Disconnect the antenna cables from the WWAN module **(1)** and the WLAN module **(2)**.
2. Remove the antenna cables from the clips built into the computer **(3)**.
3. Disconnect the display cable **(4)** and the camera cable **(5)** from the system board.
4. Remove the cables from the clips built into the computer **(6)**.

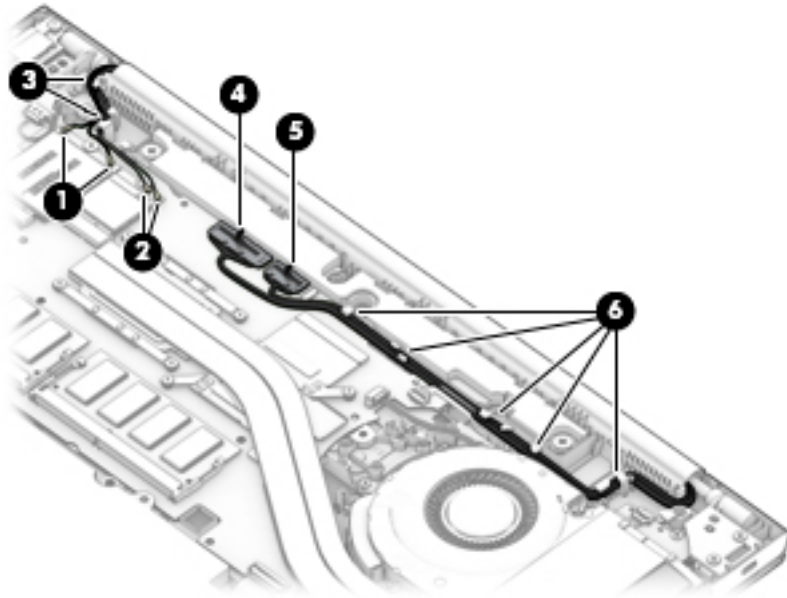

5. With the computer upside down, open the display, and then place the computer on a table with the display positioned off the edge of the table.
6. Remove the five Phillips M2.5×5.0 screws **(1)** from the display hinges.

7. Lift the display assembly straight up and remove it (2).

CAUTION: When installing the display assembly, be sure that the wireless antenna cables are routed and arranged properly.

Failure to properly route the antennas can result in degradation of the computer's wireless performance.

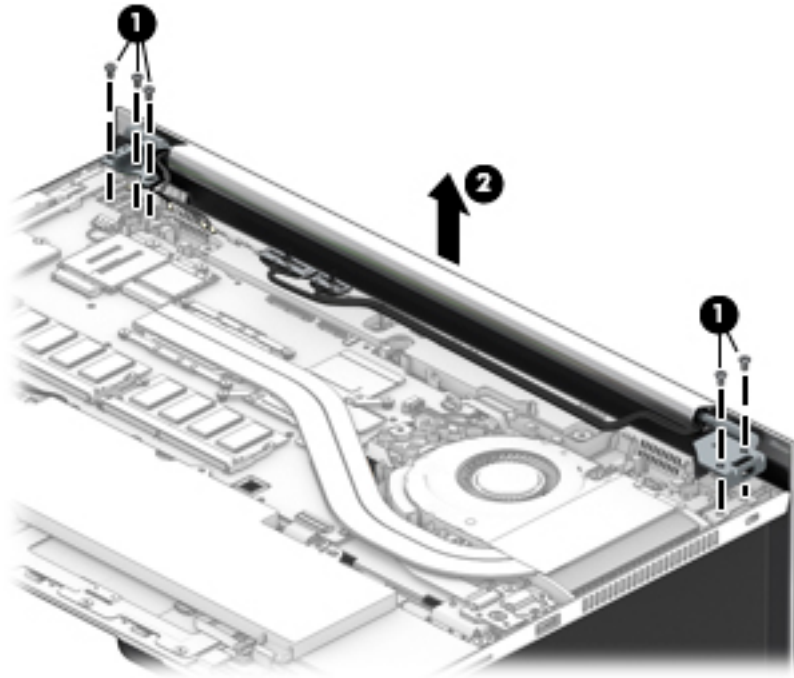

8. To remove the display hinge cover, rotate top of hinge cover away from display enclosure to disengage the tabs **(1)**, and then pull the cover off the enclosure **(2)**.

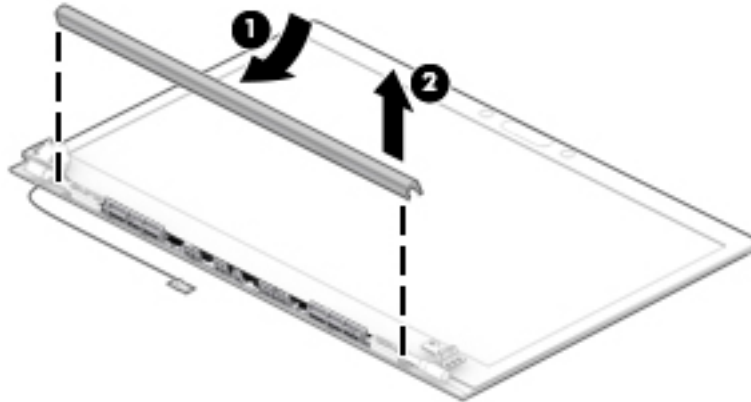

The display hinge cover (for non-privacy displays) is available in the Hinge Kit (for touch displays) using spare part number L14364-001. The display hinge cover (for non-touch displays) is available using spare part number L14365-001.

When installing the hinge cover, make sure all cables are routed correctly under the hinge cover and the hooks on the end of the cover are aligned correctly with the snaps on the bottom of the display **(1)**. Press the left **(2)**, and then right **(3)** middle sections of the hinge cover until it snaps into place.

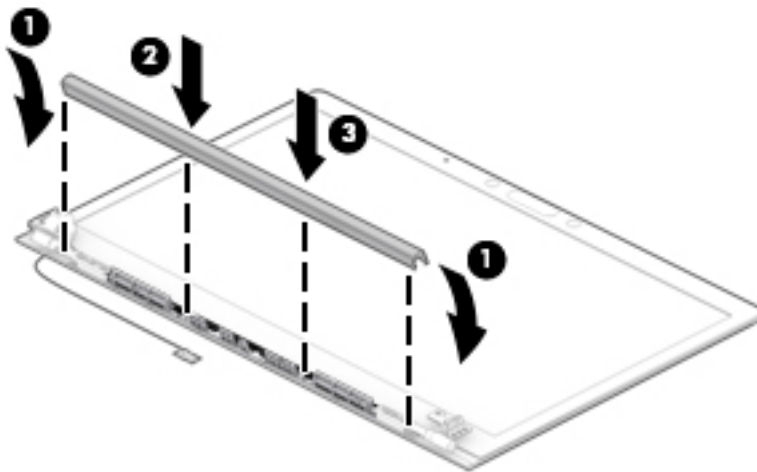

9. To remove the display bezel, flex the top **(1)** of the bezel, the inside edges of the left and right sides **(2)**, and then the bottom **(3)** of the bezel until it disengages from the display enclosure.

10. Remove the display bezel (4).

The display bezel is available using the following spare part numbers:

Models with a microphone module: L15526-001

Models with an HD camera: L15527-001

Models with an IR camera: L15528-001

Models with an IR camera and an ambient light sensor: L15529-001

Camera shutters are available in the Plastics Kit, spare part number L22111-001.

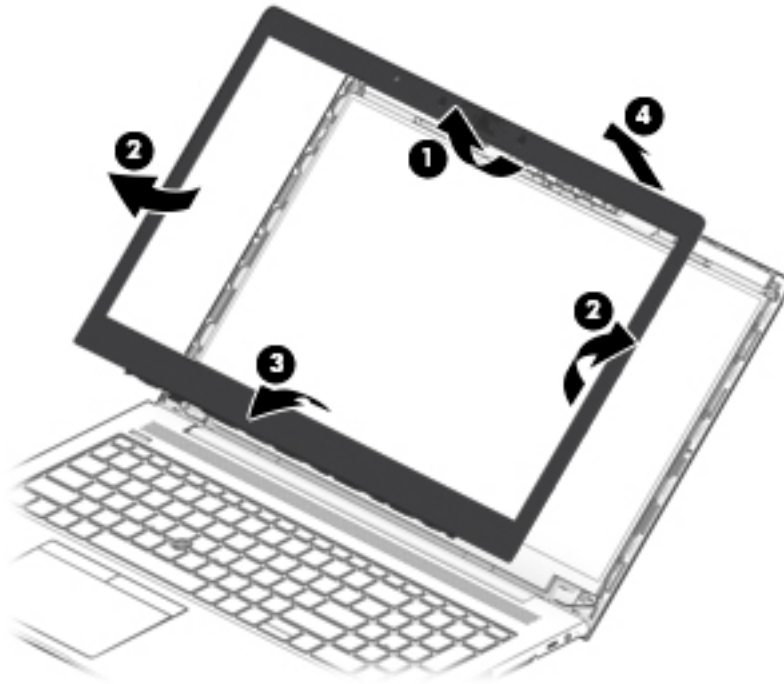

11. Two different camera modules are available. Refer to the following procedure appropriate for your computer if it is necessary to replace the camera module:

a. HD camera or microphone module

Lift upward to disengage the module from the adhesive on the display enclosure (1), disconnect the cable from the module (2), and then remove the module from the display (3).

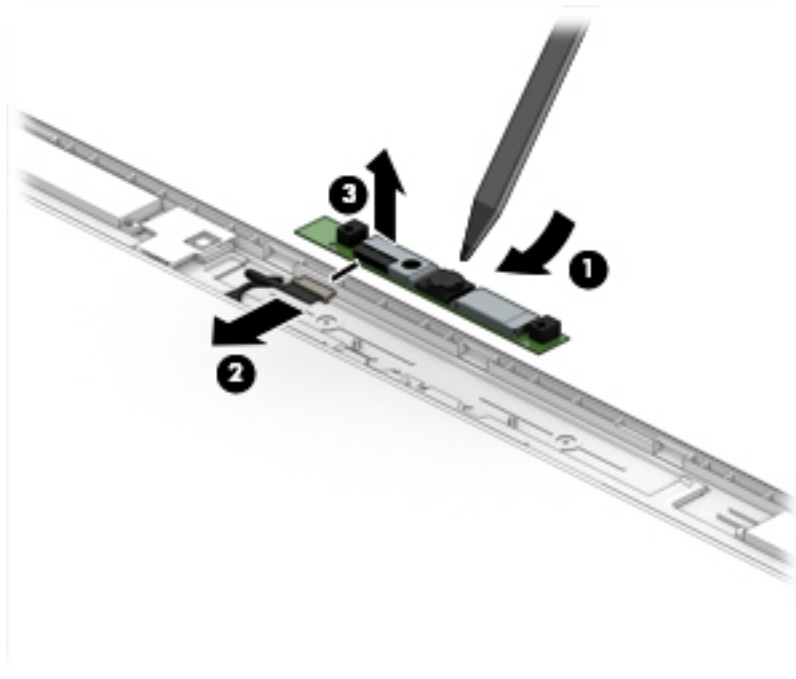

The HD camera module is available using spare part number L28405-001. The microphone module is available using spare part number L15512-001.

b. IR camera

Remove the tape from atop the module (1), lift upward to disengage the module from the adhesive on the display enclosure (2), disconnect the cables from the left and right sides of the module (3), and then remove the camera module from the display (4).

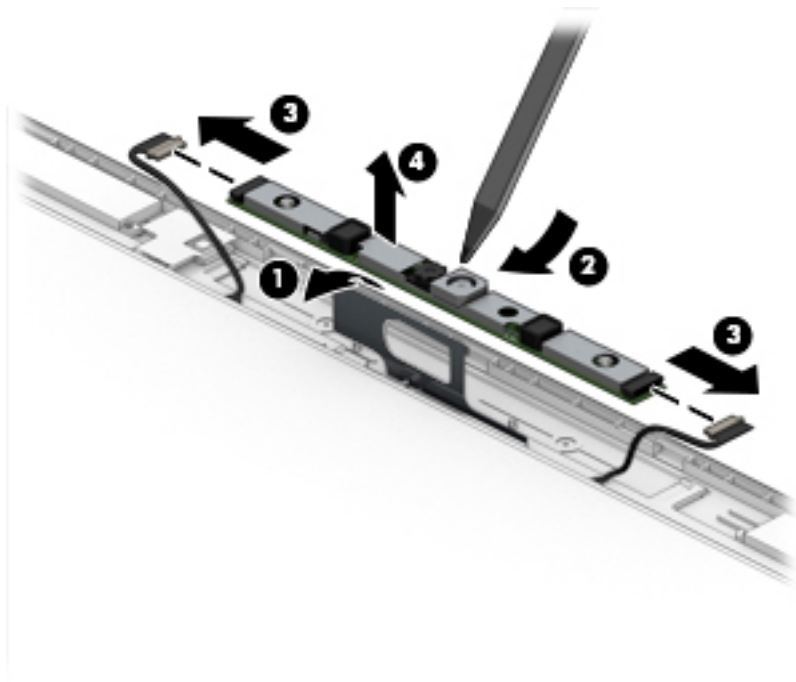

The IR camera module is available using spare part number L28404-001.

12. If it is necessary to remove the ambient light sensor board, disconnect the cable from the board **(1)**, lift upward to disengage the board from the adhesive on the display enclosure **(2)**, and then remove the board from the display **(3)**.

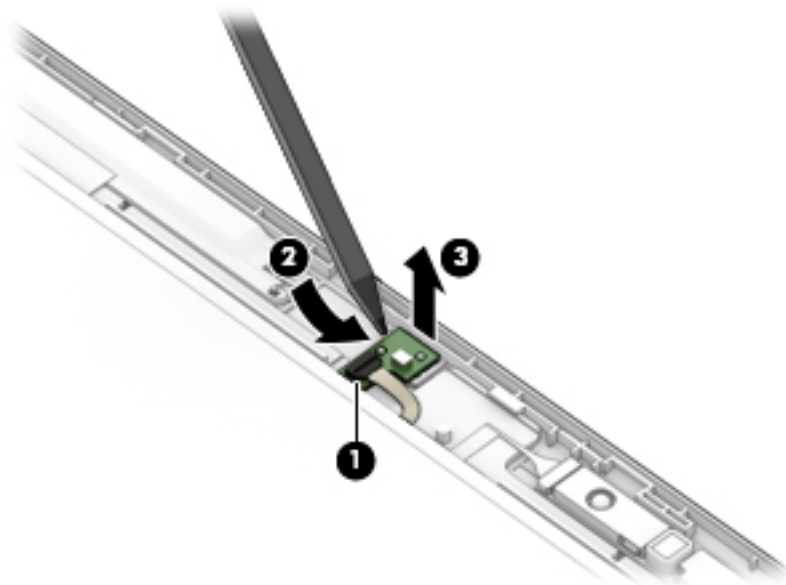

The ambient light sensor board is available using spare part number L15511-001.

13. If it is necessary to remove the display panel from the enclosure, remove the four Phillips M2.0×2.0 screws that secure the panel to the display enclosure.



14. Rotate the display panel over onto the keyboard **(1)**.

15. On the back of the display panel, lift the tape from atop the connector (2), and then disconnect the display cable from the rear of the panel (3).

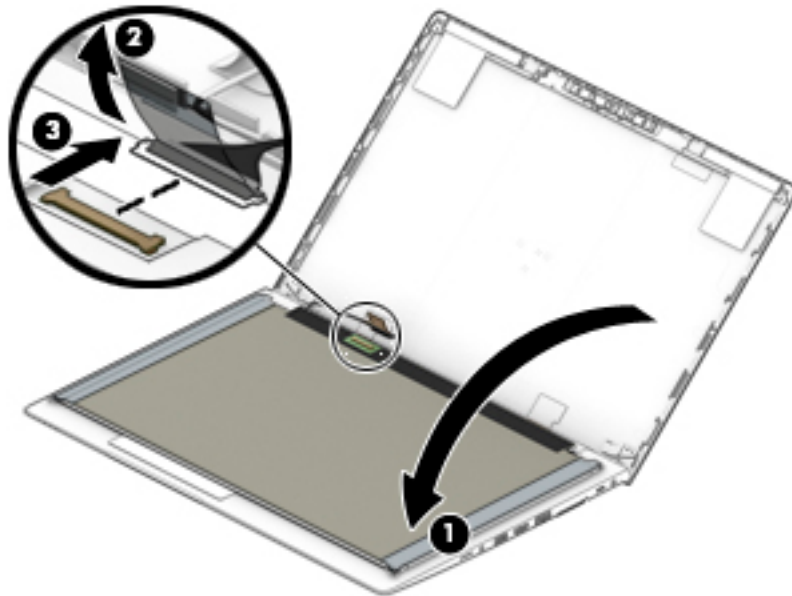

The raw display panel is available using the following spare part numbers:

 **NOTE:** Display panel kits include panel, touch module (as applicable), display cable, and interior panel bezel.

FHD panel, non-touch, HD camera: L22092-001

FHD panel, non-touch, IR camera, ambient light sensor: L22093-001

FHD panel, touch, non-privacy: L22094-001

FHD panel, touch, privacy: L30679-001

16. If it is necessary to replace the display hinges, remove the three Phillips M2.5x11.0 screws that secure each hinge (1), and then remove the hinges from the display enclosure (2).

Display hinges (for touch displays) are available in the Hinge Kit using spare part number L14364-001. Display hinges (for non-touch displays) are available using spare part number L14365-001.

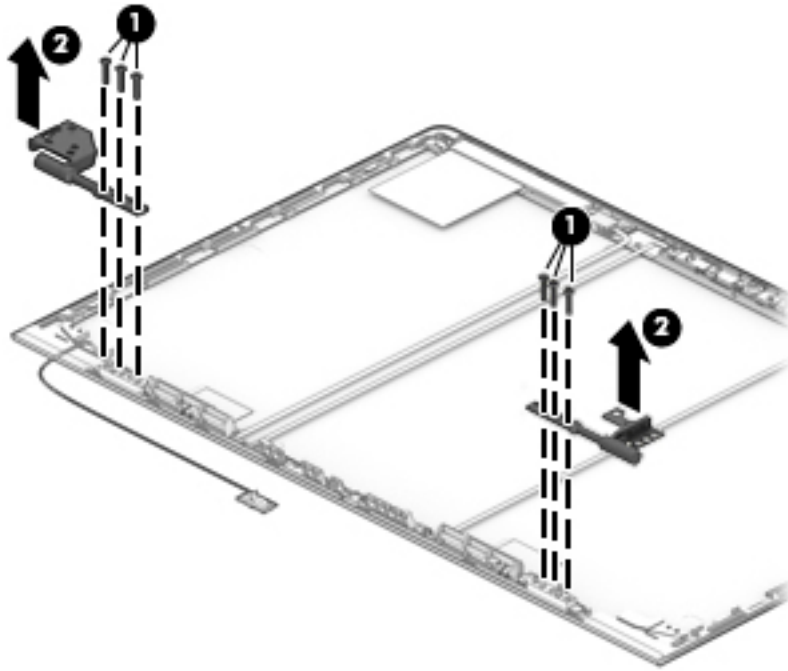

17. If it is necessary to replace the display cable, lift the cable from the routing path in the display enclosure.

The display cable is available in the Cable Kit, using spare part number L14361-001. The privacy panel display cable is available using spare part number L31996-001.

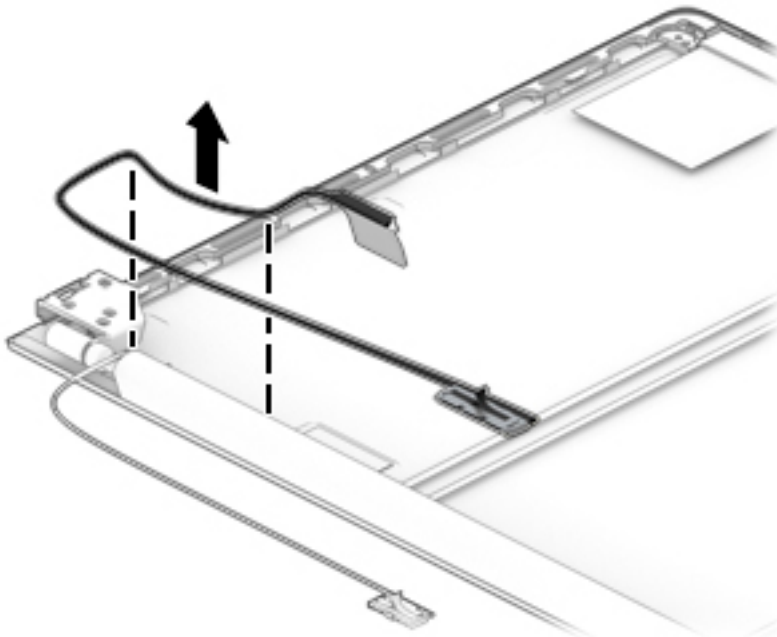

18. If it is necessary to replace the camera/ambient light sensor cable:

a. HD camera models

Disconnect the cable from the ambient light sensor board **(1)** and from the HD camera **(2)**, and then remove the cable from the display enclosure **(3)**.

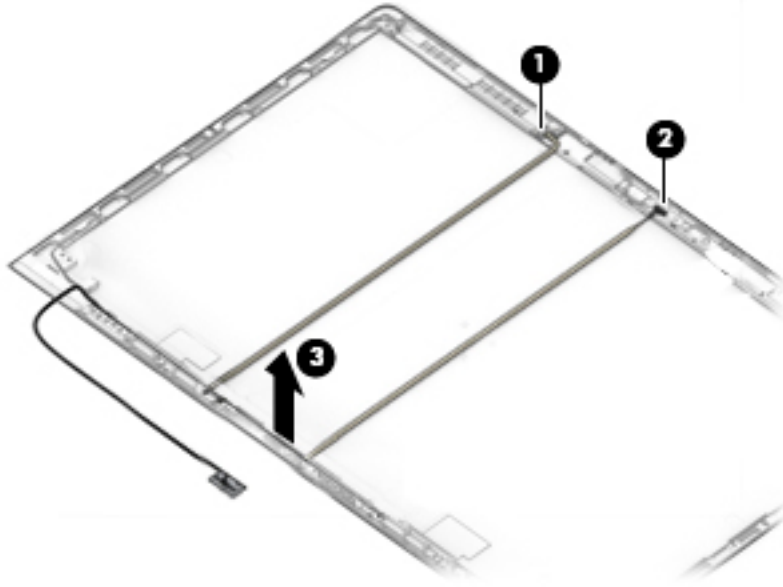

b. IR camera models

Disconnect the cable from the ambient light sensor board **(1)**, from the left **(2)** and right **(3)** sides of the IR camera, and then remove the cable from the display enclosure **(4)**.

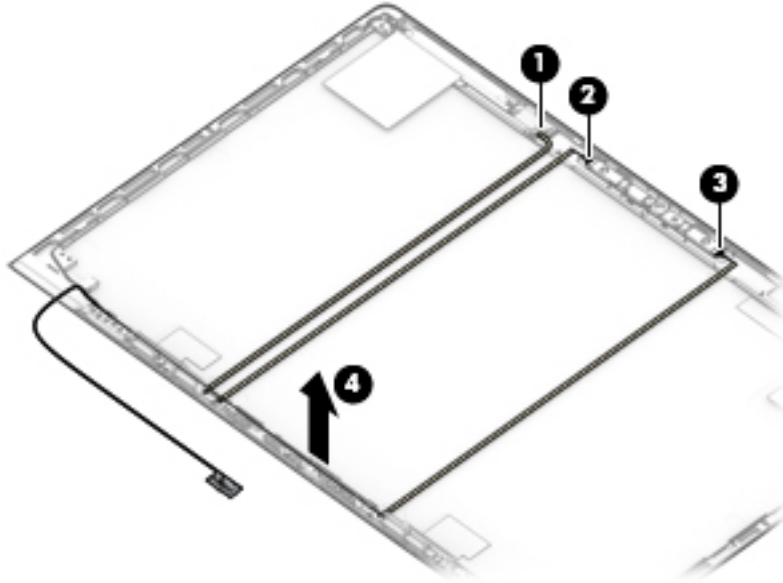

19. If it is necessary to replace the WLAN antenna cables, peel the antennas from the top of the display enclosure (1), remove the antenna cables from the routing path on the bottom of the display enclosure (2), and then remove the antenna cables (3).

 **NOTE:** The WLAN antennas are spared with the display enclosure.

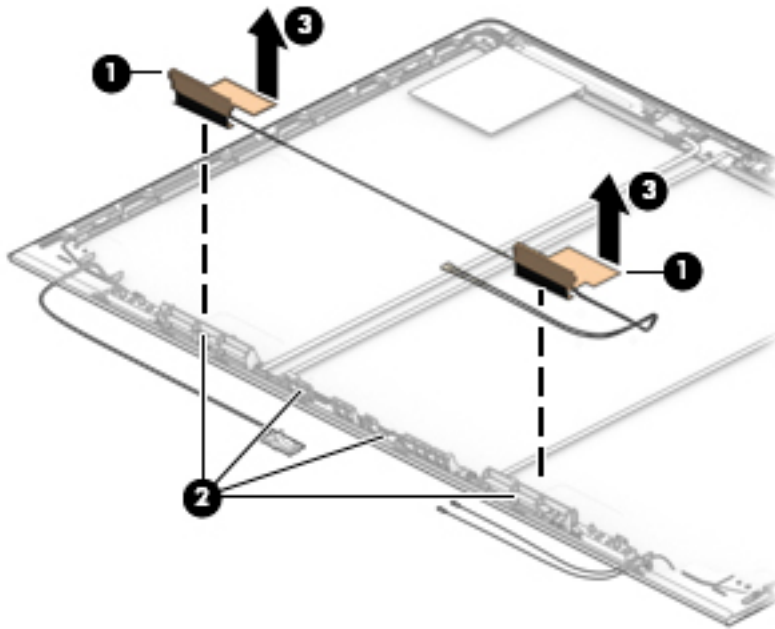

20. If it is necessary to replace the WWAN antenna cables, peel the antennas from the top of the display enclosure (1), remove the antenna cables from the bottom and sides of the display enclosure (2), and then remove the antenna cables (3).

 **NOTE:** The WWAN antennas are spared with the display enclosure.

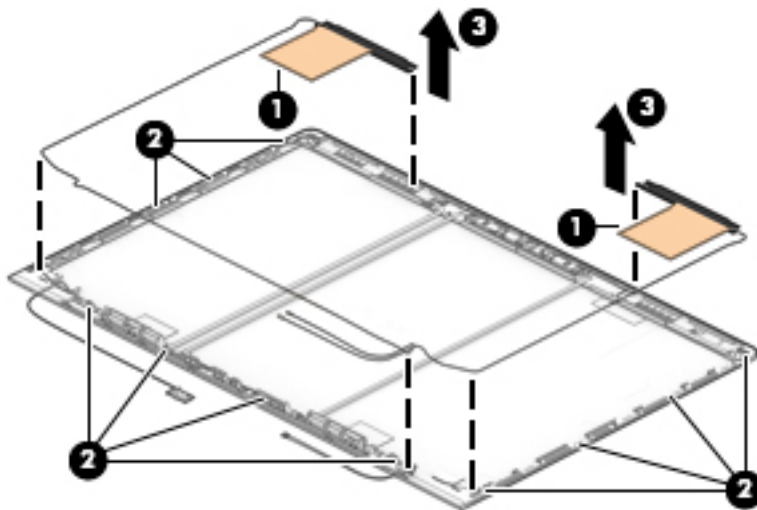

The display enclosure is available using spare part number L15525-001 for models without a WLAN module and L15524-001 for models with a WWAN module.

Reverse this procedure to reassemble and install the display assembly.

Top cover

Description	Spare part number
Top cover	L22091-001

The top cover remains after removing all other spared parts from the computer.

7 Interpreting system validation diagnostic front panel LEDs and audible codes

During the system validation phase that occurs at system startup, the BIOS validates the functionality of the following subsystems and conditions:

- AC adapter
- System board power
- Processor failure
- BIOS corruption
- Memory failure
- Graphics failure
- System board failure
- BIOS authentication failure

If an error is detected, specific patterns of long and short blinks, accompanied by long and short beeps (where applicable) are used to identify the error. These patterns will make up a two part code:

- Major – the category of the error
- Minor – the specific error within the category



NOTE: Single beep/blink codes are not used.

Number of long beeps/blinks	Error category
1	Not used
2	BIOS
3	Hardware
4	Thermal
5	System board

Patterns of blink/beep codes are determined by using the following parameters:

- 1 second pause occurs after the last major blink.
- 2 second pause occurs after the last minor blink.
- Beep error code sequences occur for the first 5 iterations of the pattern and then stop.
- Blink error code sequences continue until the computer is unplugged or the power button is pressed.



NOTE: Not all diagnostic lights and audible codes are available on all models.

The red LED blinks to represent the major error category (long blinks). The white LED blinks to represent the minor error category (short blinks). For example, '3.5' indicates 3 long red blinks and 5 short white blinks to communicate the processor is not detected.

Component tested	Major/minor code	Error condition	Notebook Caps Lock/Num Lock LED	Desktop	Action
BIOS	2.2	The main area (DXE) of BIOS has become corrupted and there is no recovery binary image available	CAP/NUM Blink = 2	2.2 - Power LED (red.white)	Follow the Crisis Recovery instructions at http://support.hp.com/us-en/document/c02693833/ .
	2.3	The embedded controller policy requires the user to enter a key sequence (SureStart 2.0)	CAP/NUM Blink = 8	2.3 - Power LED (red.white)	If analysis of the event that caused Sure Start recovery is desired, replace the board and send the bad board back. Otherwise, press this key combination to restore BIOS and boot: Up Arrow+ Down Arrow+ Esc.
	2.4	The embedded controller is recovering the boot block or DXE. Since it takes 10 sec. or so to load the DXE image and get video in the DXE case, this blink code is necessary. (SureStart)	Battery LED White and Amber blinking	2.4 - Power LED (red.white)	Wait for DXE recovery to complete.
Hardware	3.2	The embedded controller has timed out waiting for BIOS to return from memory initialization	CAP/NUM Blink = 3	3.2 - Power LED (red.white)	System board replacement.
	3.3	The embedded controller has timed out waiting for BIOS to return from graphics initialization (4/13- Graphics adaptor not found)	CAP/NUM Blink = 4	3.3 - Power LED (red.white)	If the system has an MXM module, try a different MXM module. Otherwise, the board most likely needs to be replaced.
	3.4	The system board displays a power failure (crowbar) *	CAP/NUM Blink = 5	3.4 - Power LED (red.white)	System board replacement.
System board	5.2	The embedded controller cannot find valid firmware	CAP/NUM Blink = 7 (2 BB failure) Battery LED Blinking = 1 Hz (3 B failure)	5.2 - Power LED (red.white)	System board replacement.
	5.3	The embedded controller has timed out waiting for the BIOS	CAP/NUM Blink = 1	Not implemented	System board replacement.

8 Computer Setup (BIOS), TPM, and HP Sure Start

Using Computer Setup

Computer Setup, or Basic Input/Output System (BIOS), controls communication between all the input and output devices on the system (such as disk drives, display, keyboard, mouse, and printer). Computer Setup includes settings for the types of devices installed, the startup sequence of the computer, and the amount of system and extended memory.

 **NOTE:** Use extreme care when making changes in Computer Setup. Errors can prevent the computer from operating properly.

Starting Computer Setup

- ▲ Turn on or restart the computer, and when the HP logo appears, press **f10** to enter Computer Setup.

Using a USB keyboard or USB mouse to start Computer Setup (BIOS)

You can start Computer Setup by using a keyboard or mouse connected to a USB port, but you must first disable FastBoot.

1. Turn on or restart the computer, and when the HP logo appears, press **f9** to enter the Boot Device Options menu.
2. Clear the check box for **Fast Boot**.
3. To save your changes and exit, select the **Save** icon in the lower-right corner of the screen, and then follow the on-screen instructions.

– or –

Select **Main**, select **Save Changes and Exit**, and then press **enter**.

Your changes go into effect when the computer restarts.

Navigating and selecting in Computer Setup

- To select a menu or a menu item, use the **tab** key and the keyboard arrow keys and then press **enter**, or use a pointing device to select the item.
- To scroll up and down, select the up arrow or the down arrow in the upper-right corner of the screen, or use the up arrow key or the down arrow key on the keyboard.
- To close open dialog boxes and return to the main Computer Setup screen, press **esc**, and then follow the on-screen instructions.

To exit Computer Setup menus, choose one of the following methods:

- To exit Computer Setup menus without saving your changes:
Select the **Exit** icon in the lower-right corner of the screen, and then follow the on-screen instructions.
– or –
Select **Main**, select **Ignore Changes and Exit**, and then press [enter](#).
- To save your changes and exit Computer Setup menus:
Select the **Save** icon in the lower-right corner of the screen, and then follow the on-screen instructions.
– or –
Select **Main**, select **Save Changes and Exit**, and then press [enter](#).

Your changes go into effect when the computer restarts.

Restoring factory settings in Computer Setup

 **NOTE:** Restoring defaults will not change the hard drive mode.

To return all settings in Computer Setup to the values that were set at the factory, follow these steps:

1. Start Computer Setup. See [Starting Computer Setup on page 80](#).
2. Select **Main**, and then select **Apply Factory Defaults and Exit**.

 **NOTE:** On select products, the selections may display **Restore Defaults** instead of **Apply Factory Defaults and Exit**.

3. Follow the on-screen instructions.
4. To save your changes and exit, select the **Save** icon in the lower-right corner of the screen, and then follow the on-screen instructions.
– or –
Select **Main**, select **Save Changes and Exit**, and then press [enter](#).

Your changes go into effect when the computer restarts.

 **NOTE:** Your password settings and security settings are not changed when you restore the factory settings.

Updating the BIOS

Updated versions of the BIOS may be available on the HP website.

Most BIOS updates on the HP website are packaged in compressed files called *SoftPaqs*.

Some download packages contain a file named *Readme.txt*, which contains information regarding installing and troubleshooting the file.

Determining the BIOS version

To decide whether you need to update Computer Setup (BIOS), first determine the BIOS version on your computer.

BIOS version information (also known as *ROM date* and *System BIOS*) can be accessed by pressing [fn+esc](#) (if you are already in Windows) or by using Computer Setup.

1. Start Computer Setup. See [Starting Computer Setup on page 80](#).
2. Select **Main**, and then select **System Information**.
3. To exit Computer Setup without saving your changes, select the **Exit** icon in the lower-right corner of the screen, and then follow the on-screen instructions.

– or –

Select **Main**, select **Ignore Changes and Exit**, and then press [enter](#).

To check for later BIOS versions, see [Downloading a BIOS update on page 82](#).

Downloading a BIOS update

 **CAUTION:** To reduce the risk of damage to the computer or an unsuccessful installation, download and install a BIOS update only when the computer is connected to reliable external power using the AC adapter. Do not download or install a BIOS update while the computer is running on battery power, docked in an optional docking device, or connected to an optional power source. During the download and installation, follow these instructions:

Do not disconnect power on the computer by unplugging the power cord from the AC outlet.

Do not shut down the computer or initiate Sleep.

Do not insert, remove, connect, or disconnect any device, cable, or cord.

1. Type `support` in the taskbar search box, and then select the HP Support Assistant app.

– or –

Select the question mark icon in the taskbar.

2. Select **Updates**, and then select **Check for updates and messages**.
3. Follow the on-screen instructions.
4. At the download area, follow these steps:
 - a. Identify the most recent BIOS update and compare it to the BIOS version currently installed on your computer. Make a note of the date, name, or other identifier. You may need this information to locate the update later, after it has been downloaded to your hard drive.
 - b. Follow the on-screen instructions to download your selection to the hard drive.

Make a note of the path to the location on your hard drive where the BIOS update is downloaded. You will need to access this path when you are ready to install the update.

 **NOTE:** If you connect your computer to a network, consult the network administrator before installing any software updates, especially system BIOS updates.

BIOS installation procedures vary. Follow any instructions that are displayed on the screen after the download is complete. If no instructions are displayed, follow these steps:

1. Type `file` in the taskbar search box, and then select **File Explorer**.
2. Select your hard drive designation. The hard drive designation is typically Local Disk (C:).
3. Using the hard drive path you recorded earlier, open the folder that contains the update.
4. Double-click the file that has an `.exe` extension (for example, *filename.exe*).

The BIOS installation begins.
5. Complete the installation by following the on-screen instructions.



NOTE: After a message on the screen reports a successful installation, you can delete the downloaded file from your hard drive.

Changing the boot order using the f9 prompt

To dynamically choose a boot device for the current startup sequence, follow these steps:

1. Access the Boot Device Options menu:
 - Turn on or restart the computer, and when the HP logo appears, press **f9** to enter the Boot Device Options menu.
2. Select a boot device, press **enter**, and then follow the on-screen instructions.

TPM BIOS settings (select products only)



IMPORTANT: Before enabling Trusted Platform Module (TPM) functionality on this system, you must ensure that your intended use of TPM complies with relevant local laws, regulations and policies, and approvals or licenses must be obtained if applicable. For any compliance issues arising from your operation/usage of TPM which violates the above mentioned requirement, you shall bear all the liabilities wholly and solely. HP will not be responsible for any related liabilities.

TPM provides additional security for your computer. You can modify the TPM settings in Computer Setup (BIOS).



NOTE: If you change the TPM setting to Hidden, TPM is not visible in the operating system.

To access TPM settings in Computer Setup:

1. Start Computer Setup. See [Starting Computer Setup on page 80](#).
2. Select **Security**, select **TPM Embedded Security**, and then follow the on-screen instructions.

Using HP Sure Start (select products only)

Select computer models are configured with HP Sure Start, a technology that monitors the computer's BIOS for attacks or corruption. If the BIOS becomes corrupted or is attacked, HP Sure Start automatically restores the BIOS to its previously safe state, without user intervention.

HP Sure Start is configured and already enabled so that most users can use the HP Sure Start default configuration. The default configuration can be customized by advanced users.

To access the latest documentation on HP Sure Start, go to <http://www.hp.com/support>. Select **Find your product**, and then follow the on-screen instructions.

9 Using HP PC Hardware Diagnostics (UEFI)

HP PC Hardware Diagnostics is a Unified Extensible Firmware Interface (UEFI) that allows you to run diagnostic tests to determine whether the computer hardware is functioning properly. The tool runs outside the operating system so that it can isolate hardware failures from issues that are caused by the operating system or other software components.

When HP PC Hardware Diagnostics (UEFI) detects a failure that requires hardware replacement, a 24-digit Failure ID code is generated. This ID code can then be provided to support to help determine how to correct the problem.

 **NOTE:** To start diagnostics on a convertible computer, your computer must be in notebook mode and you must use the keyboard attached.

To start HP PC Hardware Diagnostics (UEFI), follow these steps:

1. Turn on or restart the computer, and quickly press *esc*.
2. Press *f2*.

The BIOS searches three places for the diagnostic tools, in the following order:

- a. Connected USB drive

 **NOTE:** To download the HP PC Hardware Diagnostics (UEFI) tool to a USB drive, see [Downloading HP PC Hardware Diagnostics \(UEFI\) to a USB device on page 84](#).

- b. Hard drive
- c. BIOS

3. When the diagnostic tool opens, select the type of diagnostic test you want to run, and then follow the on-screen instructions.

 **NOTE:** If you need to stop a diagnostic test, press *esc*.

Downloading HP PC Hardware Diagnostics (UEFI) to a USB device

 **NOTE:** The HP PC Hardware Diagnostics (UEFI) download instructions are provided in English only, and you must use a Windows computer to download and create the HP UEFI support environment because only .exe files are offered.

There are two options to download HP PC Hardware Diagnostics to a USB device.

Download the latest UEFI version

1. Go to <http://www.hp.com/go/techcenter/pcdiags>. The HP PC Diagnostics home page is displayed.
2. In the HP PC Hardware Diagnostics section, select the **Download** link, and then select **Run**.

Download any version of UEFI for a specific product

1. Go to <http://www.hp.com/support>.
2. Select **Get software and drivers**.

3. Enter the product name or number.

– or –

Select **Identify now** to let HP automatically detect your product.

4. Select your computer, and then select your operating system.
5. In the **Diagnostic** section, follow the on-screen instructions to select and download the UEFI version you want.

Additional BIOS crisis recovery tool

HP provides a BIOS crisis recovery tool through the HP PC Hardware Diagnostics 3-in-1 USB key. This tool can be used by HP authorized service providers to recover systems that have failed due to a corrupted BIOS. For more information about using the 3-in-1 USB key for BIOS crisis recovery, go to <http://www.hp.com/go/techcenter/pcdiags>. Additional information is included in the web-based training offered by HP University. See the modules that cover HP PC Hardware Diagnostics (UEFI).

10 Backing up, restoring, and recovering

This chapter provides information about the following processes. The information in the chapter is standard procedure for most products.

- Creating recovery media and backups
- Restoring and recovering your system

For additional information, refer to the HP Support Assistant app.

▲ Type `support` in the taskbar search box, and then select the **HP Support Assistant** app.

– or –

Select the question mark icon in the taskbar.



IMPORTANT: If you will be performing recovery procedures on a tablet, the tablet battery must be at least 70% charged before you start the recovery process.

IMPORTANT: For a tablet with a detachable keyboard, connect the tablet to the keyboard base before beginning any recovery process.

Creating recovery media and backups

The following methods of creating recovery media and backups are available on select products only. Choose the available method according to your computer model.

- Use HP Recovery Manager to create HP Recovery media after you successfully set up the computer. This step creates a backup of the HP Recovery partition on the computer. The backup can be used to reinstall the original operating system in cases where the hard drive is corrupted or has been replaced. For information on creating recovery media, see [Using HP Recovery media \(select products only\) on page 86](#). For information on the recovery options that are available using the recovery media, see [Using Windows tools on page 87](#).
- Use Windows tools to create system restore points and create backups of personal information. See [Using Windows tools on page 87](#).



NOTE: If storage is 32 GB or less, Microsoft System Restore is disabled by default.

- On select products, use the HP Cloud Recovery Download Tool to create a bootable USB flash drive for your HP recovery media. For more information, see [Using the HP Cloud Recovery Download Tool \(select products only\) on page 88](#).

Using HP Recovery media (select products only)

If possible, check for the presence of the Recovery partition and the Windows partition. Right-click the **Start** button, select **File Explorer**, and then select **This PC**.

- If your computer does not list the Windows partition and the Recovery partition, you can obtain recovery media for your system from support. You can find contact information on the HP website. Go to <http://www.hp.com/support>, select your country or region, and follow the on-screen instructions.
- If your computer does list the Recovery partition and the Windows partition, you can use HP Recovery Manager to create recovery media after you successfully set up the computer. HP Recovery media can be

used to perform system recovery if the hard drive becomes corrupted. System recovery reinstalls the original operating system and software programs that were installed at the factory and then configures the settings for the programs. HP Recovery media can also be used to customize the system or restore the factory image if you replace the hard drive.

- Only one set of recovery media can be created. Handle these recovery tools carefully, and keep them in a safe place.
- HP Recovery Manager examines the computer and determines the required storage capacity for the media that will be required.
- To create recovery discs, your computer must have an optical drive with DVD writer capability, and you must use only high-quality blank DVD-R, DVD+R, DVD-R DL, or DVD+R DL discs. Do not use rewritable discs such as CD±RW, DVD±RW, double-layer DVD±RW, or BD-RE (rewritable Blu-ray) discs; they are not compatible with HP Recovery Manager software. Or, instead, you can use a high-quality blank USB flash drive.
- If your computer does not include an integrated optical drive with DVD writer capability, but you would like to create DVD recovery media, you can use an external optical drive (purchased separately) to create recovery discs. If you use an external optical drive, it must be connected directly to a USB port on the computer; the drive cannot be connected to a USB port on an external device, such as a USB hub. If you cannot create DVD media yourself, you can obtain recovery discs for your computer from HP. You can find contact information on the HP website. Go to <http://www.hp.com/support>, select your country or region, and follow the on-screen instructions.
- Be sure that the computer is connected to AC power before you begin creating the recovery media.
- The creation process can take an hour or more. Do not interrupt the creation process.
- If necessary, you can exit the program before you have finished creating all of the recovery DVDs. HP Recovery Manager will finish burning the current DVD. The next time you start HP Recovery Manager, you will be prompted to continue.

To create HP Recovery media using HP recovery manager:

 **IMPORTANT:** For a tablet with a detachable keyboard, connect the tablet to the keyboard base before beginning these steps.

1. Type `recovery` in the taskbar search box, and then select **HP Recovery Manager**.
2. Select **Create recovery media**, and then follow the on-screen instructions.

If you ever need to recover the system, see [Recovering using HP Recovery Manager on page 88](#).

Using Windows tools

You can create recovery media, system restore points, and backups of personal information using Windows tools.

 **NOTE:** If storage is 32 GB or less, Microsoft System Restore is disabled by default.

For more information and steps, see the Get Help app.

- ▲ Select the **Start** button, and then select the **Get Help** app.

 **NOTE:** You must be connected to the Internet to access the Get Help app.

Using the HP Cloud Recovery Download Tool (select products only)

To create HP Recovery media using the HP Cloud Recovery Download Tool:

1. Go to <http://www.hp.com/support>.
2. Select **Software and Drivers**, and then follow the on-screen instructions.

Restore and recovery

There are several options for recovering your system. Choose the method that best matches your situation and level of expertise:

 **IMPORTANT:** Not all methods are available on all products.

- Windows offers several options for restoring from backup, refreshing the computer, and resetting the computer to its original state. For more information see the Get Help app.
 - ▲ Select the **Start** button, and then select the **Get Help** app.

 **NOTE:** You must be connected to the Internet to access the Get Help app.

- If you need to correct a problem with a preinstalled application or driver, use the Reinstall drivers and/or applications option (select products only) of HP Recovery Manager to reinstall the individual application or driver.
 - ▲ Type `recovery` in the taskbar search box, select **HP Recovery Manager**, select **Reinstall drivers and/or applications**, and then follow the on-screen instructions.
- If you want to recover the Windows partition to original factory content, you can choose the System Recovery option from the HP Recovery partition (select products only) or use the HP Recovery media. For more information, see [Recovering using HP Recovery Manager on page 88](#). If you have not already created recovery media, see [Using HP Recovery media \(select products only\) on page 86](#).
- On select products, if you want to recover the computer's original factory partition and content, or if you have replaced the hard drive, you can use the Factory Reset option of HP Recovery media. For more information, see [Recovering using HP Recovery Manager on page 88](#).
- On select products, if you want to remove the Recovery partition to reclaim hard drive space, HP Recovery Manager offers the Remove Recovery Partition option.

For more information, see [Removing the HP Recovery partition \(select products only\) on page 90](#).

Recovering using HP Recovery Manager

HP Recovery Manager software allows you to recover the computer to its original factory state by using the HP Recovery media that you either created or that you obtained from HP, or by using the HP Recovery partition (select products only). If you have not already created recovery media, see [Using HP Recovery media \(select products only\) on page 86](#).

What you need to know before you get started

- HP Recovery Manager recovers only software that was installed at the factory. For software not provided with this computer, you must either download the software from the manufacturer's website or reinstall the software from the media provided by the manufacturer.

 **IMPORTANT:** Recovery through HP Recovery Manager should be used as a final attempt to correct computer issues.

- HP Recovery media must be used if the computer hard drive fails. If you have not already created recovery media, see [Using HP Recovery media \(select products only\) on page 86](#).
- To use the Factory Reset option (select products only), you must use HP Recovery media. If you have not already created recovery media, see [Using HP Recovery media \(select products only\) on page 86](#).
- If your computer does not allow the creation of HP Recovery media or if the HP Recovery media does not work, you can obtain recovery media for your system from support. You can find contact information from the HP website. Go to <http://www.hp.com/support>, select your country or region, and follow the on-screen instructions.

 **IMPORTANT:** HP Recovery Manager does not automatically provide backups of your personal data. Before beginning recovery, back up any personal data you want to retain.

Using HP Recovery media, you can choose from one of the following recovery options:

 **NOTE:** Only the options available for your computer display when you start the recovery process.

- System Recovery—Reinstalls the original operating system, and then configures the settings for the programs that were installed at the factory.
- Factory Reset—Restores the computer to its original factory state by deleting all information from the hard drive and re-creating the partitions. Then it reinstalls the operating system and the software that was installed at the factory.

The HP Recovery partition (select products only) allows System Recovery only.

Using the HP Recovery partition (select products only)

The HP Recovery partition allows you to perform a system recovery without the need for recovery discs or a recovery USB flash drive. This type of recovery can be used only if the hard drive is still working.

To start HP Recovery Manager from the HP Recovery partition:

 **IMPORTANT:** For a tablet with a detachable keyboard, connect the tablet to the keyboard base before beginning these steps (select products only).

1. Type `recovery` in the taskbar search box, select **HP Recovery Manager**, and then select **Windows Recovery Environment**.

– or –

For computers or tablets with keyboards attached, press **f11** while the computer boots, or press and hold **f11** as you press the power button.

For tablets without keyboards:

- Turn on or restart the tablet, and then quickly hold down the volume up button; then select **f11**.

– or –

- Turn on or restart the tablet, and then quickly hold down the volume down button; then select **f11**.

2. Select **Troubleshoot** from the boot options menu.
3. Select **Recovery Manager**, and then follow the on-screen instructions.

Using HP Recovery media to recover

You can use HP Recovery media to recover the original system. This method can be used if your system does not have an HP Recovery partition or if the hard drive is not working properly.

1. If possible, back up all personal files.
2. Insert the HP Recovery media, and then restart the computer.

 **NOTE:** If the computer does not automatically restart in HP Recovery Manager, change the computer boot order. See [Changing the computer boot order on page 90](#).

3. Follow the on-screen instructions.

Changing the computer boot order

If your computer does not restart in HP Recovery Manager, you can change the computer boot order, which is the order of devices listed in BIOS where the computer looks for startup information. You can change the selection to an optical drive or a USB flash drive.

To change the boot order:

 **IMPORTANT:** For a tablet with a detachable keyboard, connect the tablet to the keyboard base before beginning these steps.

1. Insert the HP Recovery media.
2. Access the system **Startup** menu.

For computers or tablets with keyboards attached:

- ▲ Turn on or restart the computer or tablet, quickly press **esc**, and then press **f9** for boot options.

For tablets without keyboards:

- ▲ Turn on or restart the tablet, and then quickly hold down the volume up button; then select **f9**.

– or –

Turn on or restart the tablet, and then quickly hold down the volume down button; then select **f9**.

3. Select the optical drive or USB flash drive from which you want to boot.
4. Follow the on-screen instructions.

Removing the HP Recovery partition (select products only)

HP Recovery Manager software allows you to remove the HP Recovery partition to free up hard drive space.

 **IMPORTANT:** After you remove the HP Recovery partition, you will not be able to perform System Recovery or create HP Recovery media from the HP Recovery partition. So before you remove the Recovery partition, create HP Recovery media; see [Using HP Recovery media \(select products only\) on page 86](#).

 **NOTE:** The Remove Recovery Partition option is only available on products that support this function.

Follow these steps to remove the HP Recovery partition:

1. Type `recovery` in the taskbar search box, and then select **HP Recovery Manager**.
2. Select **Remove Recovery Partition**, and then follow the on-screen instructions.

11 Specifications

Computer specifications

	Metric	U.S.
Dimensions		
Depth	251.7 mm	9.91 in
Width	370.8 mm	14.60 in
Height (non-touch)	18.25 mm	0.72 in
Height (touch)	18.60 mm	0.73 in
Weight		
WWAN and ALS display, no fingerprint reader, 1 SODIMM, WLAN module, with IR camera, no WWAN module, non-touch panel	1.86 kg	4.09 lbs
WWAN display, no fingerprint reader, 1 SODIMM, WLAN module, IR camera, no WWAN module, touch panel	1.98 kg	4.37 lbs
Input power		
Operating voltage	19.0 V dc @ 4.74 A – 90 W or 18.5 V dc @ 3.5 A - 65 W or 45 W	
Operating current	4.74 A or 3.5 A	
Temperature		
Operating (not writing to optical disc)	0°C to 35°C	32°F to 95°F
Operating (writing to optical disc)	5°C to 35°C	41°F to 95°F
Nonoperating	-20°C to 60°C	-4°F to 140°F
Relative humidity		
Operating	10% to 90%	
Nonoperating	5% to 95%	
Maximum altitude (unpressurized)		
Operating (14.7 to 10.1 psia)	-15 m to 3,048 m	50 ft to 10,000 ft
Nonoperating (14.7 to 4.4 psia)	-15 m to 12,192 m	-50 ft to 40,000 ft
Shock		
Operating	125 g, 2 ms, half-sine	
Nonoperating	200 g, 2 ms, half-sine	
Random vibration		
Operating	0.75 g zero-to-peak, 10 Hz to 500 Hz, 0.25 oct/min sweep rate	

	Metric	U.S.
Nonoperating	1.50 g zero-to-peak, 10 Hz to 500 Hz, 0.5 oct/min sweep rate	

NOTE: Applicable product safety standards specify thermal limits for plastic surfaces. The computer operates well within this range of temperatures.

39.6-cm (15.6-in) display specifications

	Metric	U.S.
Active diagonal size	39.6-cm	15.6-in
Resolution	FHD: 1920×1080	
Surface treatment	Anti-glare (except touch screen)	
Brightness	FHD (45% CG): 220 nits FHD (72% CG): 400 nits	
Viewing angle	UWVA	
Backlight	LED	
Aspect ratio	16:9	
Display panel interface	eDP	

M.2 PCIe solid-state drive specifications

	256-GB*	512-GB*	1-TB*
Dimensions			
Height	1 mm	1 mm	1 mm
Length	50.8 mm	50.8 mm	50.8 mm
Width	28.9 mm	28.9 mm	28.9 mm
Weight	< 10 g	< 10 g	< 10 g
Interface type	ATA-7	ATA-7	ATA-7
Transfer rate			
Sequential Read	Up to 2150 MB/s	Up to 2150 MB/s	Up to 2150 MB/s
Random Read	Up to 300,000 IOPs	Up to 300,000 IOPs	Up to 300,000 IOPs
Sequential Write	Up to 1260 MB/s	Up to 1550 MB/s	Up to 1550 MB/s
Random Write	Up to 100,000 IOPs	Up to 100,000 IOPs	Up to 100,000 IOPs
Ready time, Maximum (to not busy)	1.0 s	1.0 s	1.0 s
Access times			
Logical	0.1	0.1	0.1
Total logical sectors	500,118,192	1,000,215,216	1,500,336,388
Operating temperature			
Operating	0° to 70°C (32°F to 158°F)	0° to 70°C (32°F to 158°F)	0° to 70°C (32°F to 158°F)
Non-operating	-40° to 80°C (-40°F to 176°F)	-40° to 85°C (-40°F to 185°F)	-40° to 85°C (-40°F to 185°F)
*1 GB = 1 billion bytes when referring to hard drive storage capacity. Actual accessible capacity is less.			
NOTE: Certain restrictions and exclusions apply. Contact technical support for details.			

M.2 SATA solid-state drive specifications

	128-GB*	256-GB*	512-GB*
Height	1.35 mm	1.35 mm	1.35 mm
Weight	< 10 g	< 10 g	< 10 g
Form factor	M.2 2280-D2-B-M	M.2 2280-D2-B-M	M.2 2280-D2-B-M
Transfer rate	up to 540 MB/sec	up to 540 MB/sec	up to 540 MB/sec
Interface type	SATA-3	SATA-3	SATA-3
Ready time, maximum (to not busy)	1.0 ms	< 1.0 ms	< 1.0 ms
Access times, logical	0.1 ms	0.1 ms	0.1 ms
Total logical sectors	234,441,648	468,883,296	937,766,592
Operating temperature	0°C to 70°C (32°F to 158°F)		

*1 GB = 1 billion bytes when referring to hard drive storage capacity. Actual accessible capacity is less. Actual drive specifications may differ slightly.

NOTE: Certain restrictions and exclusions apply. Contact technical support for details.

12 Power cord set requirements

The wide-range input feature of the computer permits it to operate from any line voltage from 100 to 120 volts AC, or from 220 to 240 volts AC.

The 3-conductor power cord set included with the computer meets the requirements for use in the country or region where the equipment is purchased.

Power cord sets for use in other countries and regions must meet the requirements of the country or region where the computer is used.

Requirements for all countries

The following requirements are applicable to all countries and regions:

- The length of the power cord set must be at least **1.0 m** (3.3 ft) and no more than **2.0 m** (6.5 ft).
- All power cord sets must be approved by an acceptable accredited agency responsible for evaluation in the country or region where the power cord set will be used.
- The power cord sets must have a minimum current capacity of 10 amps and a nominal voltage rating of 125 or 250 V AC, as required by the power system of each country or region.
- The appliance coupler must meet the mechanical configuration of an EN 60 320/IEC 320 Standard Sheet C13 connector for mating with the appliance inlet on the back of the computer.

Requirements for specific countries and regions

Country/region	Accredited agency	Applicable note number
Australia	EANSW	1
Austria	OVE	1
Belgium	CEBC	1
Canada	CSA	2
Denmark	DEMKO	1
Finland	FIMKO	1
France	UTE	1
Germany	VDE	1
Italy	IMQ	1
Japan	METI	3
The Netherlands	KEMA	1
Norway	NEMKO	1
The People's Republic of China	COC	5
South Korea	EK	4

Country/region	Accredited agency	Applicable note number
Sweden	SEMKO	1
Switzerland	SEV	1
Taiwan	BSMI	4
The United Kingdom	BSI	1
The United States	UL	2

1. The flexible cord must be Type H05VV-F, 3-conductor, 1.0-mm² conductor size. Power cord set fittings (appliance coupler and wall plug) must bear the certification mark of the agency responsible for evaluation in the country or region where it will be used.
2. The flexible cord must be Type SPT-3 or equivalent, No. 18 AWG, 3-conductor. The wall plug must be a two-pole grounding type with a NEMA 5-15P (15 A, 125 V) or NEMA 6-15P (15 A, 250 V) configuration.
3. The appliance coupler, flexible cord, and wall plug must bear a “T” mark and registration number in accordance with the Japanese Dentori Law. The flexible cord must be Type VCT or VCTF, 3-conductor, 1.00-mm² conductor size. The wall plug must be a two-pole grounding type with a Japanese Industrial Standard C8303 (7 A, 125 V) configuration.
4. The flexible cord must be Type RVV, 3-conductor, 0.75-mm² conductor size. Power cord set fittings (appliance coupler and wall plug) must bear the certification mark of the agency responsible for evaluation in the country or region where it will be used.
5. The flexible cord must be Type VCTF, 3-conductor, 0.75-mm² conductor size. Power cord set fittings (appliance coupler and wall plug) must bear the certification mark of the agency responsible for evaluation in the country or region where it will be used.

13 Statement of memory volatility

The purpose of this chapter is to provide general information regarding nonvolatile memory in HP Business computers. This chapter also provides general instructions for restoring nonvolatile memory that can contain personal data after the system has been powered off and the hard drive has been removed.

HP Business computer products that use Intel®-based or AMD®-based system boards contain volatile DDR memory. The amount of nonvolatile memory present in the system depends upon the system configuration. Intel-based and AMD-based system boards contain nonvolatile memory subcomponents as originally shipped from HP, assuming that no subsequent modifications have been made to the system and assuming that no applications, features, or functionality have been added to or installed on the system.

Following system shutdown and removal of all power sources from an HP Business computer system, personal data can remain on volatile system memory (DIMMs) for a finite period of time and will also remain in nonvolatile memory. Use the steps below to remove personal data from the computer, including the nonvolatile memory found in Intel-based and AMD-based system boards.

 **NOTE:** If your tablet has a keyboard base, connect to the keyboard base before beginning steps in this chapter.

Current BIOS steps

1. Follow steps (a) through (l) below to restore the nonvolatile memory that can contain personal data. Restoring or reprogramming nonvolatile memory that does not store personal data is neither necessary nor recommended.
 - a. Turn on or restart the computer, and then press **esc** while the “Press the ESC key for Startup Menu” message is displayed at the bottom of the screen.

 **NOTE:** If the system has a BIOS administrator password, enter the password at the prompt.
 - b. Select **Main**, select **Apply Factory Defaults and Exit**, and then select **Yes** to load defaults.
The computer will reboot.
 - c. During the reboot, press **esc** while the “Press the ESC key for Startup Menu” message is displayed at the bottom of the screen.

 **NOTE:** If the system has a BIOS administrator password, enter the password at the prompt.
 - d. Select the **Security** menu, select **Restore Security Settings to Factory Defaults**, and then select **Yes** to restore security level defaults.
The computer will reboot.
 - e. During the reboot, press **esc** while the “Press the ESC key for Startup Menu” message is displayed at the bottom of the screen.

 **NOTE:** If the system has a BIOS administrator password, enter the password at the prompt.
 - f. If an asset or ownership tag is set, select the **Security** menu and scroll down to the **Utilities** menu. Select **System IDs**, and then select **Asset Tracking Number**. Clear the tag, and then make the selection to return to the prior menu.

- g. If a DriveLock password is set, select the **Security** menu, and scroll down to **Hard Drive Utilities** under the **Utilities** menu. Select **Hard Drive Utilities**, select **DriveLock**, then uncheck the checkbox for **DriveLock password on restart**. Select **OK** to proceed.
- h. Select the **Main** menu, and then select **Reset BIOS Security to factory default**. Click **Yes** at the warning message.
The computer will reboot.
- i. During the reboot, press **esc** while the “Press the ESC key for Startup Menu” message is displayed at the bottom of the screen.



NOTE: If the system has a BIOS administrator password, enter the password at the prompt.

- j. Select the **Main** menu, select **Apply Factory Defaults and Exit**, select **Yes** to save changes and exit, and then select **Shutdown**.
 - k. Reboot the system. If the system has a Trusted Platform Module (TPM) and/or fingerprint reader, one or two prompts will appear—one to clear the TPM and the other to Reset Fingerprint Sensor; press or tap **F1** to accept or **F2** to reject.
 - l. Remove all power and system batteries for at least 24 hours.
2. Complete one of the following:
- Remove and retain the storage drive.
 - or –
 - Clear the drive contents by using a third party utility designed to erase data from an SSD.
 - or –
 - Clear the contents of the drive by using the following BIOS Setup Secure Erase command option steps:



IMPORTANT: If you clear data using Secure Erase, it cannot be recovered.

- a. Turn on or restart the computer, and then press **esc** while the “Press the ESC key for Startup Menu” message is displayed at the bottom of the screen.
- b. Select the **Security** menu and scroll down to the **Utilities** menu.
- c. Select **Hard Drive Utilities**.
- d. Under **Utilities**, select **Secure Erase**, select the hard drive storing the data you want to clear, and then follow the on-screen instructions to continue.

Nonvolatile memory usage

Nonvolatile Memory Type	Amount (Size)	Does this memory store customer data?	Does this memory retain data when power is removed?	What is the purpose of this memory?	How is data input into this memory?	How is this memory write-protected?
HP Sure Start flash (select models only)	8 MBytes	No	Yes	Provides protected backup of critical System BIOS code, EC firmware, and critical computer configuration data for select platforms that support HP Sure Start. For more information, see Using HP Sure Start (select models only) on page 102 .	Data cannot be written to this device via the host processor. The content is managed solely by the HP Sure Start Embedded Controller.	This memory is protected by the HP Sure Start Embedded Controller.
Real Time Clock (RTC) battery backed-up CMOS configuration memory	256 Bytes	No	Yes	Stores system date and time and noncritical data.	RTC battery backed-up CMOS is programmed using the Computer Setup (BIOS), or changing the Microsoft Windows date & time.	This memory is not write-protected.
Controller (NIC) EEPROM	64 KBytes (not customer accessible)	No	Yes	Stores NIC configuration and NIC firmware.	NIC EEPROM is programmed using a utility from the NIC vendor that can be run from DOS.	A utility is required to write data to this memory and is available from the NIC vendor. Writing data to this ROM in an inappropriate manner will render the NIC non-functional.
DIMM Serial Presence Detect (SPD) configuration data	256 Bytes per memory module, 128 Bytes programmable (not customer accessible)	No	Yes	Stores memory module information.	DIMM SPD is programmed by the memory vendor.	Data cannot be written to this memory when the module is installed in a computer. The specific write-protection method varies by memory vendor.
System BIOS	9 MBytes	Yes	Yes	Stores system BIOS code and computer configuration data.	System BIOS code is programmed at the factory. Code is updated when the system BIOS is updated. Configuration data and settings are input using the Computer Setup (BIOS) or a custom utility.	NOTE: Writing data to this ROM in an inappropriate manner can render the computer non-functional. A utility is required for writing data to this memory and is available on the HP website; go to http://www.hp.com/support . Select Find your

Nonvolatile Memory Type	Amount (Size)	Does this memory store customer data?	Does this memory retain data when power is removed?	What is the purpose of this memory?	How is data input into this memory?	How is this memory write-protected?
Intel Management Engine Firmware (present only in select Elite or Z models. For more information, go to http://www.hp.com/support . Select Find your product , and then follow the on-screen instructions.)	1.5 MBytes or 7 MBytes	Yes	Yes	Stores Management Engine Code, Settings, Provisioning Data and iAMT third-party data store.	Management Engine Code is programmed at the factory. Code is updated via Intel secure firmware update utility. Unique Provisioning Data can be entered at the factory or by an administrator using the Management Engine (MEBx) setup utility. The third party data store contents can be populated by a remote management console or local applications that have been registered by an administrator to have access to the space.	product , and then follow the on-screen instructions. The Intel chipset is configured to enforce hardware protection to block all direct read/write access to this area. An Intel utility is required for updating the firmware. Only firmware updates digitally signed by Intel can be applied using this utility.
Bluetooth flash (select products only)	2 Mbit	No	Yes	Stores Bluetooth configuration and firmware.	Bluetooth flash is programmed at the factory. Tools for writing data to this memory are not publicly available but can be obtained from the silicon vendor.	A utility is required for writing data to this memory and is made available through newer versions of the driver whenever the flash requires an upgrade.
802.11 WLAN EEPROM	4 Kbit to 8 Kbit	No	Yes	Stores configuration and calibration data.	802.11 WLAN EEPROM is programmed at the factory. Tools for writing data to this memory are not made public.	A utility is required for writing data to this memory and is typically not made available to the public unless a firmware upgrade is necessary to address a unique issue.
Webcam (select products only)	64 Kbit	No	Yes	Stores webcam configuration and firmware.	Webcam memory is programmed using a utility from the device manufacturer that can be run from Windows.	A utility is required for writing data to this memory and is typically not made available to the public unless a firmware upgrade is necessary to address a unique issue.
Fingerprint reader (select products only)	512 KByte flash	Yes	Yes	Stores fingerprint templates.	Fingerprint reader memory is programmed by user enrollment in HP ProtectTools Security Manager.	Only a digitally signed application can make the call to write to the flash.

Questions and answers

1. How can the BIOS settings be restored (returned to factory settings)?



IMPORTANT: Restore defaults does not securely erase any data on your hard drive. See question and answer 6 for steps to securely erase data.

Restore defaults does not reset the Custom Secure Boot keys. See question and answer 7 for information about resetting the keys.

- a. Turn on or restart the computer, and then press **esc** while the “Press the ESC key for Startup Menu” message is displayed at the bottom of the screen.
- b. Select **Main**, and then select **Apply Factory Defaults and Exit**.
- c. Follow the on-screen instructions.
- d. Select **Main**, select **Save Changes and Exit**, and then follow the on-screen instructions.

2. What is a UEFI BIOS, and how is it different from a legacy BIOS?

The Unified Extensible Firmware Interface (UEFI) BIOS is an industry-standard software interface between the platform firmware and an operating system (OS). It is a replacement for the older BIOS architecture, but supports much of the legacy BIOS functionality.

Like the legacy BIOS, the UEFI BIOS provides an interface to display the system information and configuration settings and to change the configuration of your computer before an OS is loaded. BIOS provides a secure run-time environment that supports a Graphic User Interface (GUI). In this environment, you can use either a pointing device (Touchscreen, TouchPad, pointing stick, or USB mouse) or the keyboard to navigate and make menu and configuration selections. The UEFI BIOS also contains basic system diagnostics.

The UEFI BIOS provides functionality beyond that of the legacy BIOS. In addition, the UEFI BIOS works to initialize the computer’s hardware before loading and executing the OS; the run-time environment allows the loading and execution of software programs from storage devices to provide more functionality, such as advanced hardware diagnostics (with the ability to display more detailed system information) and advanced firmware management and recovery software.

HP has provided options in Computer Setup (BIOS) to allow you to run in legacy BIOS, if required by the operating system. Examples of this requirement would be if you upgrade or downgrade the OS.

3. Where does the UEFI BIOS reside?

The UEFI BIOS resides on a flash memory chip. A utility is required to write to the chip.

4. What kind of configuration data is stored on the DIMM Serial Presence Detect (SPD) memory module? How would this data be written?

The DIMM SPD memory contains information about the memory module, such as size, serial number, data width, speed/timing, voltage, and thermal information. This information is written by the module manufacturer and stored on an EEPROM. This EEPROM cannot be written to when the memory module is installed in a computer. Third-party tools do exist that can write to the EEPROM when the memory module is not installed in a computer. Various third-party tools are available to read SPD memory.

5. What is meant by “Restore the nonvolatile memory found in Intel-based system boards”?

This message relates to clearing the Real Time Clock (RTC) CMOS memory that contains computer configuration data.

6. How can the BIOS security be reset to factory defaults and data erased?

 **IMPORTANT:** Resetting will result in the loss of information.

These steps will not reset Custom Secure Boot Keys. See question and answer 7 for information about resetting the keys.

- a. Turn on or restart the computer, and then press **esc** while the “Press the ESC key for Startup Menu” message is displayed at the bottom of the screen.
- b. Select **Main**, and then select **Reset Security to Factory Defaults**.
- c. Follow the on-screen instructions.
- d. Select **Main**, select **Save Changes and Exit**, and then follow the on-screen instructions.

7. How can the Custom Secure Boot Keys be reset?

Secure Boot is a feature to ensure that only authenticated code can start on a platform. If you enabled Secure Boot and created Custom Secure Boot Keys, simply disabling Secure Boot will not clear the keys. You must also select to clear the Custom Secure Boot Keys. Use the same Secure Boot access procedure you used to create the Custom Secure Boot Keys, but make the selection to clear or delete all Secure Boot Keys.

- a. Turn on or restart the computer, and then press **esc** while the “Press the ESC key for Startup Menu” message is displayed at the bottom of the screen.
- b. Select the **Security** menu, select **Secure Boot Configuration**, and then follow the on-screen instructions.
- c. At the **Secure Boot Configuration** window, select **Secure Boot**, select **Clear Secure Boot Keys**, and then follow the on-screen instructions to continue.

Using HP Sure Start (select models only)

Select computer models are configured with HP Sure Start, a technology that continuously monitors your computer's BIOS for attacks or corruption. If the BIOS becomes corrupted or is attacked, HP Sure Start restores the BIOS to its previously safe state, without user intervention. Those select computer models ship with HP Sure Start configured and enabled. HP Sure Start is configured and already enabled so that most users can use the HP Sure Start default configuration. The default configuration can be customized by advanced users.

To access the latest documentation on HP Sure Start, go to <http://www.hp.com/support>. Select **Find your product**, and then follow the on-screen instructions.

14 Recycling

When a non-rechargeable or rechargeable battery has reached the end of its useful life, do not dispose of the battery in general household waste. Follow the local laws and regulations in your area for battery disposal.

HP encourages customers to recycle used electronic hardware, HP original print cartridges, and rechargeable batteries. For more information about recycling programs, see the HP Web site at <http://www.hp.com/recycle>.

Index

Symbols/Numerics

- `product description
- ethernet 2

A

- AC adapter, spare part numbers 28
- action keys 16
 - identifying 16
 - keyboard backlight 16
 - mute 16
 - privacy screen 16
 - screen brightness 16
 - speaker volume 16
 - switch screen image 16
 - using 16
 - wireless 16
- ambient light sensor board
 - spare part number 26
- ambient light sensor, identifying 10
- antennas
 - disconnecting 39, 41
- audible codes 78
- audio
 - adjusting volume 16
- audio, product description 2
- audio-out (headphone)/audio-in (microphone) combo jack, identifying 6

B

- backups 86
- battery
 - removing 47
 - spare part number 47
 - spare part numbers 24
- battery light 7
- beep codes 78
- bezel
 - spare part number 25
- BIOS
 - determining version 81
 - downloading an update 82
 - updating 81
- Bluetooth card
 - spare part number 39

- Bluetooth label 21
- boot order
 - changing 90
 - changing using the f9 prompt 83
- bottom 21
- bottom cover
 - removing 34
 - spare part number 24, 34
- buttons
 - left TouchPad 11
 - power 14
 - right TouchPad 11

C

- Cable Kit
 - contents 27
 - spare part number 27
- call answer light 12
- call end light 13
- camera 9, 10
 - identifying 9, 10
- camera cable
 - spare part number 26
- camera light, identifying 9, 10
- camera module
 - removal 70
 - spare part number 26
- caps lock light, identifying 12
- chipset, product description 1
- components
 - bottom 18
 - cover 20
 - display 9
 - front 19
 - keyboard area 11
 - left side 8
 - right side 6
- computer major components 22
- Computer Setup
 - navigating and selecting 80
 - restoring factory settings 81
 - using a USB keyboard or USB mouse to start Computer Setup 80

- computer setup 80
- computer specifications 91
- connector, power 7

D

- display assembly
 - removal 67
 - spare part numbers 67
 - subcomponents 25
- display bezel
 - removal 69
- display components 9
- display enclosure
 - spare part number 26
- display hinge
 - removal 72
- display panel
 - product description 1
- display specifications 92
- docking
 - product description 3
- docking connector, identifying 7
- drive light 19

E

- error
 - codes 78
- esc key, identifying 15
- ethernet
 - product description 2

F

- fan
 - removal 62
 - spare part number 23, 62
- fingerprint reader
 - spare part number 23
- fingerprint reader assembly
 - removal 56
 - spare part number 56
- fingerprint reader, identifying 14
- flashing LEDs 78
- fn key, identifying 15
- fn lock light 13

G

graphics, product description 1

H

HDMI port, identifying 6

heat sink

removal 49

spare part number 23

spare part numbers 49

hinge

removal 72

hot keys

microphone mute 16

hotkeys, using 17

HP PC Hardware Diagnostics (UEFI)

using 84

HP Recovery Manager

correcting boot problems 90

starting 89

HP Recovery media

recovery 90

using 86

HP Recovery partition

recovery 89

removing 90

HP Sure Start 102

I

integrated numeric keypad,
identifying 15

internal microphones, identifying 9,
10, 20

J

jacks

audio-out (headphone)/audio-in
(microphone) combo 6

network 7

RJ-45 (network) 7

K

keyboard

product description 3

removal 43

spare part number 23

spare part numbers 43

keyboard backlight

action key 16

keypad

integrated numeric 15

keys

esc 15

fn 15

num lock 15

Windows key 15

L

labels

Bluetooth 21

regulatory 21

serial number 21

service 21

wireless certification 21

WLAN 21

left side components 8

lights

AC adapter and battery 7

battery 7

call answer 12

call end 13

camera 9, 10

caps lock 12

drive 19

fn lock 13

microphone mute 12

num lock 13

power 12, 19

RJ-45 (network) 7

sharing or presenting 12

wireless 12, 19

M

M.2 solid-state drive

specifications 93

memory

nonvolatile 97

product description 1

volatile 97

memory module

removal 37

spare part number 23

spare part numbers 37

microphone

product description 2

microphone module

spare part number 26

microphone mute key, identifying
16

microphone mute light, identifying
12

minimized image recovery 89

minimized image, creating 88

model name 1

mute volume action key 16

N

network jack, identifying 7

NFC module

removal 60

spare part number 23, 60

NFC tapping area

Near Field Communications 11

nonvolatile memory 97

num lock light 13

O

operating system, product

description 4

original system recovery 88

P

Plastics Kit, spare part number 28

pointing device, product

description 3

pointing stick, identifying 11

ports

HDMI 6

product description 3

USB 3.x SuperSpeed 6

USB 3.x SuperSpeed port with HP
Sleep and Charge 8

USB Type-C power connector and
Thunderbolt port with HP Sleep
and Charge 7

power button board

spare part number 23

power button board assembly

removal 54

spare part number 54

power button, identifying 14

power connector

identifying 7

identifying USB Type-C 7

power cord

set requirements 95

power lights 12, 19

power requirements, product
description 4

primary storage

product description 2

- privacy screen action key, identifying 16
- processors, product description 1
- product description
 - audio 2
 - chipset 1
 - display panel 1
 - docking 3
 - graphics 1
 - keyboard 3
 - memory 1
 - microphone 2
 - operating system 4
 - pointing device 3
 - ports 3
 - power requirements 4
 - primary storage 2
 - processors 1
 - product name 1
 - security 4
 - serviceability 5
 - video 2
 - wireless networking 2
- product name 1
- product name and number, computer 21

R

- raw panel
 - spare part number 25
- recover
 - options 88
- recovery
 - discs 87, 90
 - HP Recovery Manager 88
 - media 90
 - starting 89
 - supported discs 87
 - system 88
 - USB flash drive 90
 - using HP Recovery media 87
- recovery media
 - creating using HP Recovery Manager 87
 - using 86
- recovery partition
 - removing 90
- regulatory information
 - regulatory label 21
 - wireless certification labels 21

- removal/replacement
 - procedures 34, 46
- removing personal data from volatile system memory 97
- right side components 6
- RJ-45 (network) jack, identifying 7
- RJ-45 (network) lights, identifying 7
- RJ-45 board with bracket
 - removal 53
 - spare part number 23, 53
- RTC battery
 - removal 51
 - spare part number 23, 51

S

- screen brightness action keys 16
- Screw Kit, spare part number 28
- security cable slot, identifying 8
- security, product description 4
- serial number, computer 21
- service labels, locating 21
- serviceability, product description 5
- setup utility
 - navigating and selecting 80
 - restoring factory settings 81
- sharing or presenting light 12
- SIM card slot, identifying 6
- slots
 - security cable 8
 - SIM card 6
 - smart card 8
- smart card reader
 - removal 61
 - spare part number 61
- smart card reader board
 - spare part numbers 23
- smart card slot, identifying 8
- solid-state drive
 - removal 36
 - spare part numbers 24, 36
 - specifications 94
- speaker assembly
 - removal 55
 - spare part number 55
- speaker volume action keys 16
- speakers, identifying 14
- special keys, using 15
- specifications
 - computer 91

- display 92
- M.2 solid-state drive 93
- solid-state drive 94
- supported discs, recovery 87
- Sure Start
 - using 83
- switch screen image action key 16
- system board
 - removal 64
 - spare part number 23
 - spare part numbers 64
- system memory, removing personal data from volatile 97
- system recovery 88
- system restore point
 - creating 87
- system restore point, creating 86

T

- Thunderbolt port with HP Sleep and Charge
 - identifying USB Type-C 7
- top cover
 - removal 77
 - spare part number 23, 77
- TouchPad
 - buttons 11
 - removal 57
 - spare part number 23, 57
- TouchPad button board
 - removal 59
 - spare part number 23, 59
- TouchPad zone
 - identifying 11
- TPM settings 83
- traveling with the computer 21

U

- USB 3.x SuperSpeed port with HP Sleep and Charge, identifying 8
- USB 3.x SuperSpeed port, identifying 6
- USB board
 - removal 52
 - spare part number 23, 52
- USB Type-C power connector and Thunderbolt port with HP Sleep and Charge, identifying 7

V

- vents, identifying 8, 14, 18

video, product description 2

volume

adjusting 16

mute 16

W

Windows

system restore point 86, 87

Windows key, identifying 15

Windows tools

using 87

wireless action key 16

wireless antennas

disconnecting 39, 41

wireless antennas, identifying 9, 10

wireless certification label 21

wireless light, identifying 12, 19

wireless networking

product description 2

WLAN antenna

spare part number 26

WLAN antennas, identifying 9, 10

WLAN device 21

WLAN label 21

WLAN/Bluetooth combo card

removal 39

spare part number 24, 39

WWAN antenna

spare part number 26

WWAN antennas, identifying 9, 10

WWAN module

removal 41

spare part number 24, 41