



HP mt21 Mobile Thin Client

Maintenance and Service Guide

© Copyright 2017, 2019 HP Development Company, L.P.

AMD is a trademark of Advanced Micro Devices, Inc. Bluetooth is a trademark owned by its proprietor and used by HP Inc. under license. Intel is a trademark of Intel Corporation in the U.S. and other countries. Microsoft and Windows are trademarks of the Microsoft group of companies.

The information contained herein is subject to change without notice. The only warranties for HP products and services are set forth in the express warranty statements accompanying such products and services. Nothing herein should be construed as constituting an additional warranty. HP shall not be liable for technical or editorial errors or omissions contained herein.

Second Edition: May 2019

First Edition: September 2017

Document Part Number: L02708-002

Product notice

This user guide describes features that are common to most models. Some features may not be available on your computer.

Not all features are available in all editions of Windows. This computer may require upgraded and/or separately purchased hardware, drivers and/or software to take full advantage of Windows functionality. Go to <http://www.microsoft.com> for details.

Your product does not support Windows 8 or Windows 7

In accordance with Microsoft's support policy, HP does not support the Windows 8 or Windows 7 operating system on this product or provide any Windows 8 or Windows 7 drivers on <http://support.hp.com>.

Software terms

By installing, copying, downloading, or otherwise using any software product preinstalled on this computer, you agree to be bound by the terms of the HP End User License Agreement (EULA). If you do not accept these license terms, your sole remedy is to return the entire unused product (hardware and software) within 14 days for a full refund subject to the refund policy of your seller.

For any further information or to request a full refund of the price of the computer, please contact your seller.

Important Notice about Customer Self-Repair Parts

 **CAUTION:** Your computer includes Customer Self-Repair parts and parts that should only be accessed by an authorized service provider. See Chapter 5, "Removal and replacement procedures for Customer Self-Repair parts," for details. Accessing parts described in Chapter 6, "Removal and replacement procedures for Authorized Service Provider only parts," can damage the computer or void your warranty.

Safety warning notice

 **WARNING!** To reduce the possibility of heat-related injuries or of overheating the device, do not place the device directly on your lap or obstruct the device air vents. Use the device only on a hard, flat surface. Do not allow another hard surface, such as an adjoining optional printer, or a soft surface, such as pillows or rugs or clothing, to block airflow. Also, do not allow the AC adapter to contact the skin or a soft surface, such as pillows or rugs or clothing, during operation. The device and the AC adapter comply with the user-accessible surface temperature limits defined by applicable safety standards.

Table of contents

1 Product description	1
2 Components	4
Right	4
Left	5
Display	7
Keyboard area	8
TouchPad	8
Lights	9
Buttons, speakers, and fingerprint reader	10
Special keys	11
Bottom	12
Labels	13
3 Illustrated parts catalog	15
Computer major components	15
Display components	17
Cable Kit	18
Plastics Kit	19
Bracket Kit	19
Miscellaneous parts	20
4 Removal and replacement procedures preliminary requirements	22
Tools required	22
Service considerations	22
Plastic parts	22
Cables and connectors	22
Drive handling	23
Workstation guidelines	23
Electrostatic discharge information	23
Generating static electricity	24
Preventing electrostatic damage to equipment	24
Personal grounding methods and equipment	25
Grounding the work area	25
Recommended materials and equipment	25
Packaging and transporting guidelines	26

5 Removal and replacement procedures for Customer Self-Repair parts	27
Component replacement procedures	27
Battery Safe mode	27
Service doors	28
Memory modules	30
WLAN/Bluetooth combo card	32
M.2 solid-state drive	34
Keyboard	35
6 Removal and replacement procedures for Authorized Service Provider parts	38
Component replacement procedures	38
Top cover	39
Fingerprint reader assembly	42
Power button board	44
Speaker assembly	46
TouchPad assembly	48
Card reader board	50
Fan	51
RTC battery	53
Battery	54
USB board	55
System board	57
Heat sink assembly	60
Display assembly – non-touch	62
Power cable	67
7 Interpreting system validation diagnostic front panel LEDs and audible codes	68
8 Diagnostics and troubleshooting	70
LEDs	70
Wake-on LAN	71
Power-On Sequence	71
Resetting the Setup and Power-on passwords	72
Power-on diagnostic tests	72
Interpreting POST diagnostic front panel LEDs and audible codes	73
POST numeric codes and text messages	75
Troubleshooting	77
Basic troubleshooting	77
Diskless (No-Flash) unit troubleshooting	78
Configuring a PXE server	79

9 Using HP ThinUpdate to restore the image	80
10 Device management	81
11 Computer Setup (BIOS), TPM, and HP Sure Start	82
Using Computer Setup	82
Starting Computer Setup	82
Navigating and selecting in Computer Setup	82
Restoring factory settings in Computer Setup	82
Updating the BIOS	83
Determining the BIOS version	83
Downloading a BIOS update	84
Changing the boot order using the f9 prompt	84
TPM BIOS settings (select products only)	85
Using HP Sure Start (select products only)	85
12 Using HP PC Hardware Diagnostics (UEFI)	86
Downloading HP PC Hardware Diagnostics (UEFI) to a USB device	86
Using Remote HP PC Hardware Diagnostics (UEFI) settings (select products only)	87
Customizing Remote HP PC Hardware Diagnostics (UEFI) settings	87
13 Backup and recovery information	88
14 Specifications	89
Computer specifications	89
35.6-cm (14.0-in) display specifications	90
Solid-state drive specifications	91
15 Statement of memory volatility	92
Nonvolatile memory usage	94
Questions and answers	96
Using HP Sure Start (select models only)	97
16 Power cord set requirements	98
Requirements for all countries	98
Requirements for specific countries and regions	99
17 Recycling	101

1 Product description

Table 1-1 Product components and their descriptions

Category	Description
Product Name	HP mt21 Mobile Thin Client
Processor	Intel Celeron 3867U processor (1.8 GHz, 2-MB SmartCache, dual core, 12.5 W; Intel HD Graphics 610)
Graphics	<p>Integrated UMA Graphics GT1 and GT2</p> <p>Supports HD decode, DX12, HDMI 1.4b, HDCP 2.2 via HDMI up to 4K@60Hz</p> <p>Integrated with shared video memory; dynamically allocated</p>
Panel	<p>35.6 cm (14.0-inch), LED backlight, 16:9 aspect ratio, anti glare, SVA, HD (1366x768), 220 nits, eDP, slim (3.0 mm)</p> <p>2 WLAN antennas</p> <p>Camera, 2 WLAN antennas</p> <p>35.6 cm (14.0-inch), LED backlight, 16:9 aspect ratio, anti-glare, anti glare, UWVA, FHD (1920x1080), 220 nits; eDP, IPS, slim (3.0 mm)</p> <p>2 WLAN antennas</p> <p>Camera, 2 WLAN antennas</p>
Memory	<p>Two customer-accessible memory module slots supporting up to 16 GB of RAM</p> <p>Supports dual-channel memory</p> <p>PC4, 2400-MHz, DDR4 SODIMMs</p> <p>Supports the following configurations:</p> <ul style="list-style-type: none"> 8192 MB (4096 × 2; dual channel) 4096 MB (4096 × 1)
Primary M.2 storage	<p>M.2 2280 SSD (NGFF)</p> <p>128 GB, SATA, TLC</p>
Audio/Visual	<p>Audio controls</p> <p>Integrated mono microphone (non-camera models only)</p> <p>Integrated dual-array microphone (camera models only)</p> <p>Integrated camera (720p HD) (supports Wide Dynamic Range [WDR])</p> <p>Stereo speakers (2)</p> <p>Headphone/microphone combo jack</p>
Ethernet	<p>Realtek RTL8111HSH 10/100/1000</p> <p>S3/S4/S5 wake on LAN (AC mode and battery mode)</p>
Wireless	Integrated WLAN options by way of wireless module

Table 1-1 Product components and their descriptions (continued)

Category	Description
	<p>WLAN antennas built into top of display assembly</p> <p>Supports the following wireless adapters via minicard connector:</p> <ul style="list-style-type: none"> • Intel Dual Band Wireless-AC 8265, 802.11ac, 2×2 Wi-Fi + Bluetooth 4.2 combination adapter (non-vPro)
	<p>Wireless Personal Area Network (PAN) Bluetooth</p> <p>Bluetooth 4.2 supported using combo card</p>
External media card	<p>Digital Media Reader Slot</p> <p>Supports SD, SDHC, SDXC</p>
Ports (Input/output)	<p>VGA (Dsub 15-pin) supporting:</p> <ul style="list-style-type: none"> • 2048×1536 external resolution at 60-GHz • Hot plug/unplug and auto detect • HDMI 1.4b <p>USB 3.0 + powered port (left)</p> <p>USB 3.0 (right)</p> <p>USB Type-C (PD+DP, gen 1)</p> <p>Headphone/microphone combo jack</p> <p>RJ-45 (Ethernet, includes link and activity lights)</p> <p>Multi-pin AC port</p>
Docking	Docking via USB Type-C
Keyboard/pointing devices	<p>Keyboard</p> <p>HP Premium Keyboard</p> <p>TouchPad</p> <p>Full-sized, chiclet, spill-resistant keyboard (backlit or not backlit)</p> <p>TouchPad requirements</p> <p>Windows 10 gestures: taps enabled by default: on/off control by driver, 2-finger scrolling and zoom enabled by default, OSD (enable/disable), 3-finger tap - Cortana, 3-finger flick - App switch, 4-finger tap - Action Center</p>
Power requirements	<p>Battery</p> <p>3-cell prismatic, 48-Wh, long-life, Li-ion battery</p> <p>AC adapters</p> <p>65-W Smart AC adapter, right angle, 4.5 mm – EM</p> <p>45-W Smart AC adapter, right angle, 4.5 mm</p> <p>45-W Smart AC adapter, right angle, 4.5 mm – Argentina</p> <p>45-W Smart AC adapter, right angle, 2-prong, 4.5 mm (Japan only)</p> <p>Power cords</p> <p>3-wire plug (C5), 1.8 m</p>

Table 1-1 Product components and their descriptions (continued)

Category	Description
	3-wire plug (C5), 1.0 m
	2-wire plug (C7), 1.0 m
Security	Security lock
	Integrated fingerprint reader (select models only)
	TPM 2.0 SLB9670 (Infineon; soldered down)
	Hardware enforced firmware protection: HP Hardware Root of Trust
	ANSSI Certified Hardware Root of Trust: Yes
	Hardware enforced software protection: No
	Firmware based operating system recovery: No
Operating system	Operating system version
	Windows 10 IoT Enterprise 2016 LTSB
	HP ThinPro 6 (Linux)
	HP Smart Zero Core (Linux)
Serviceability	End-user replaceable parts
	AC adapter
	M.2 solid-state drive
	Memory module
	WLAN module
	Keyboard

2 Components

Your computer features top-rated components. This chapter provides details about your components, where they're located, and how they work.

Right

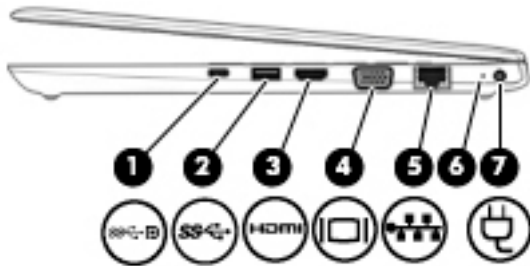

Table 2-1 Right-side components and their descriptions







Component	Description
<p>(1)</p> 	<p>USB Type-C power connector port, SuperSpeed port, and DisplayPort</p> <p>Connects an AC adapter that has a USB Type-C connector, supplying power to the computer and, if needed, charging the computer battery.</p> <p>– and –</p> <p>Connects a USB device that has a Type-C connector, such as a cell phone, camera, activity tracker, or smartwatch, and provides high-speed data transfer.</p> <p>– and –</p> <p>Connects a display device that has a USB Type-C connector, providing DisplayPort output.</p> <p>NOTE: Cables and/or adapters (purchased separately) may be required.</p>
<p>(2)</p> 	<p>USB 3.x SuperSpeed port</p> <p>Connects a USB device, such as a cell phone, camera, activity tracker, or smartwatch, and provides high-speed data transfer.</p>
<p>(3)</p> 	<p>HDMI port</p> <p>Connects an optional video or audio device, such as a high-definition television, any compatible digital or audio component, or a high-speed High Definition Multimedia Interface (HDMI) device.</p>
<p>(4)</p> 	<p>External monitor port</p> <p>Connects an external VGA monitor or projector.</p>
<p>(5)</p> 	<p>RJ-45 (network) jack/status lights</p> <p>Connects a network cable.</p> <ul style="list-style-type: none"> Green (right): The network is connected. Amber (left): Activity is occurring on the network.
<p>(6)</p>	<p>Battery light</p> <p>When AC power is connected:</p> <ul style="list-style-type: none"> White: The battery charge is greater than 90 percent. Amber: The battery charge is from 0 to 90 percent.

Table 2-1 Right-side components and their descriptions (continued)

Component	Description
	<ul style="list-style-type: none"> Off: The battery is not charging. <p>When AC power is disconnected (battery not charging):</p> <ul style="list-style-type: none"> Blinking amber: The battery has reached a low battery level. When the battery has reached a critical battery level, the battery light begins blinking rapidly. Off: The battery is not charging.
(7) 	<p>Power connector</p> <p>Connects an AC adapter.</p>

Left

**Table 2-2 Left-side components and their descriptions**

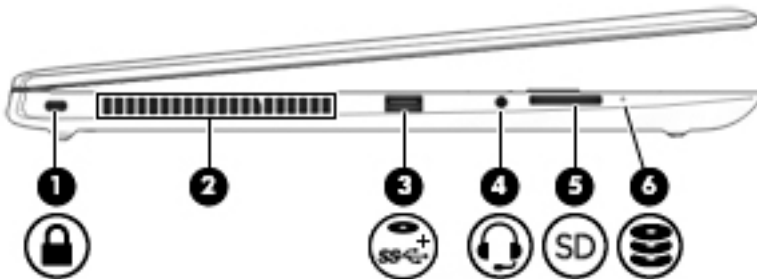



Component	Description
(1) 	<p>Security cable slot</p> <p>Attaches an optional security cable to the computer.</p> <p>NOTE: The security cable is designed to act as a deterrent, but it may not prevent the computer from being mishandled or stolen.</p>
(2)	<p>Vent</p> <p>Enables airflow to cool internal components.</p> <p>NOTE: The computer fan starts up automatically to cool internal components and prevent overheating. It is normal for the internal fan to cycle on and off during routine operation.</p>
(3) 	<p>USB 3.x SuperSpeed powered port</p> <p>Connects a USB device, such as a cell phone, camera, activity tracker, optical drive, or smartwatch, and provides high-speed data transfer.</p>
(4) 	<p>Audio-out (headphone)/Audio-in (microphone) combo jack</p> <p>Connects optional powered stereo speakers, headphones, earbuds, a headset, or a television audio cable. Also connects an optional headset microphone. This jack does not support optional standalone microphones.</p>

Table 2-2 Left-side components and their descriptions (continued)

Component	Description
	<p>WARNING! To reduce the risk of personal injury, adjust the volume before putting on headphones, earbuds, or a headset. For additional safety information, refer to the <i>Regulatory, Safety, and Environmental Notices</i>.</p> <p>To access this guide:</p> <ol style="list-style-type: none">1. Type <code>support</code> in the taskbar search box, and then select the HP Support Assistant app. <p>– or –</p> <p>Click the question mark icon in the taskbar.</p> <ol style="list-style-type: none">2. Select My PC, select the Specifications tab, and then select User Guides. <p>NOTE: When a device is connected to the jack, the computer speakers are disabled.</p>
<p>(5)  Memory card reader</p>	<p>Reads optional memory cards that store, manage, share, or access information.</p> <p>To insert a card:</p> <ol style="list-style-type: none">1. Hold the card label-side up, with the connectors facing the computer.2. Insert the card into the memory card reader, and then press in on the card until it is firmly seated. <p>To remove a card:</p> <ul style="list-style-type: none">▲ Press in on the card, and then remove it from the memory card reader.
<p>(6)  Drive light</p>	<ul style="list-style-type: none">● Blinking white: The solid-state drive is being accessed.

Display

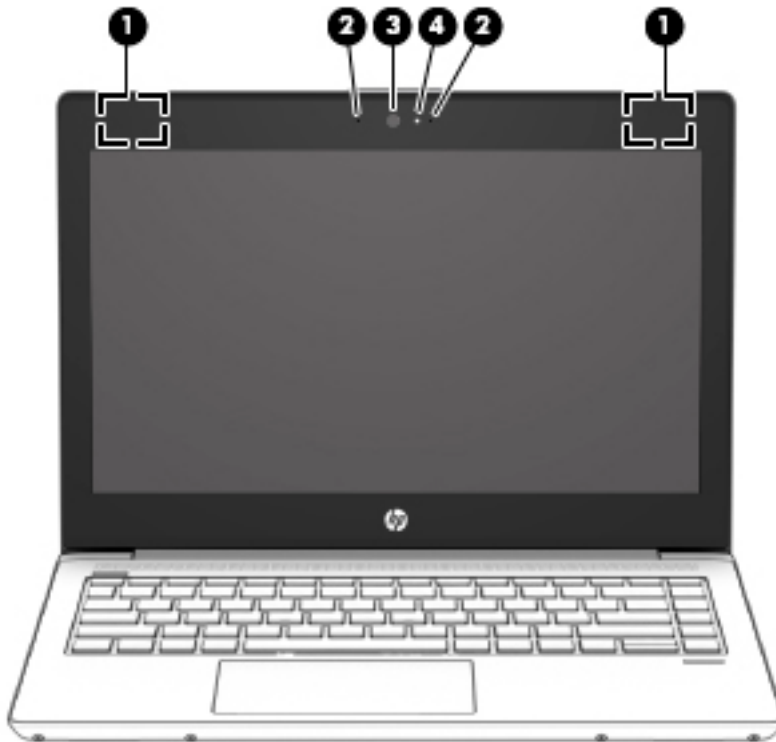

Table 2-3 Display components and their descriptions

Component	Description
(1) WLAN antennas	Send and receive wireless signals to communicate with wireless local area networks (WLANs).
(2) Internal microphones	Record sound.
(3) Camera	Allow you to video chat, record video, and record still images. Some cameras also allow a facial recognition logon to Windows, instead of a password logon. NOTE: Camera functions vary depending on the camera hardware and software installed on your product.
(4) Camera light	On: Cameras is in use.

*The antennas are not visible from the outside of the computer. For optimal transmission, keep the areas immediately around the antennas free from obstructions.

For wireless regulatory notices, see the section of the *Regulatory, Safety, and Environmental Notices* that applies to your country or region.

To access this guide:

1. Type `support` in the taskbar search box, and then select the **HP Support Assistant** app.
– or –
Click the question mark icon in the taskbar.
2. Select **My PC**, select the **Specifications** tab, and then select **User Guides**.

Keyboard area

TouchPad

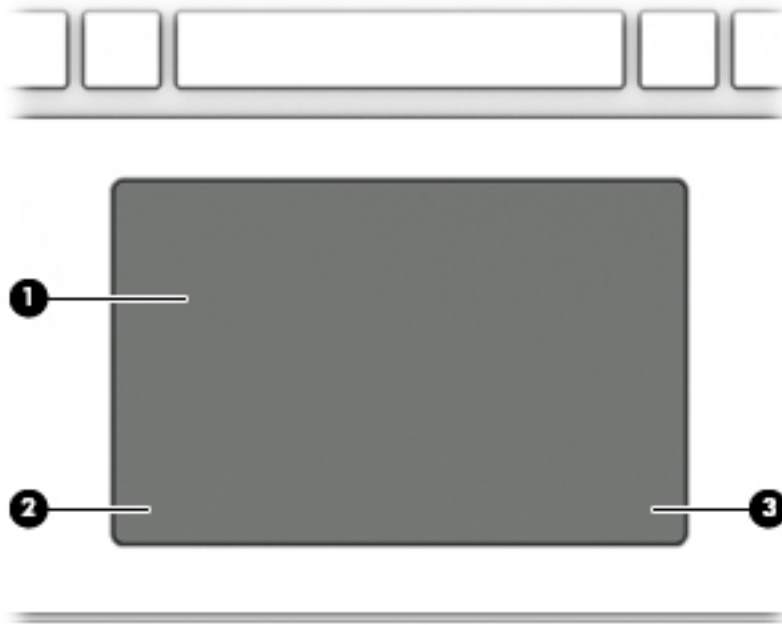

Table 2-4 TouchPad components and their descriptions

Component	Description
(1)	TouchPad zone Reads your finger gestures to move the pointer or activate items on the screen.
(2)	Left TouchPad button Functions like the left button on an external mouse.
(3)	Right TouchPad button Functions like the right button on an external mouse.

Lights

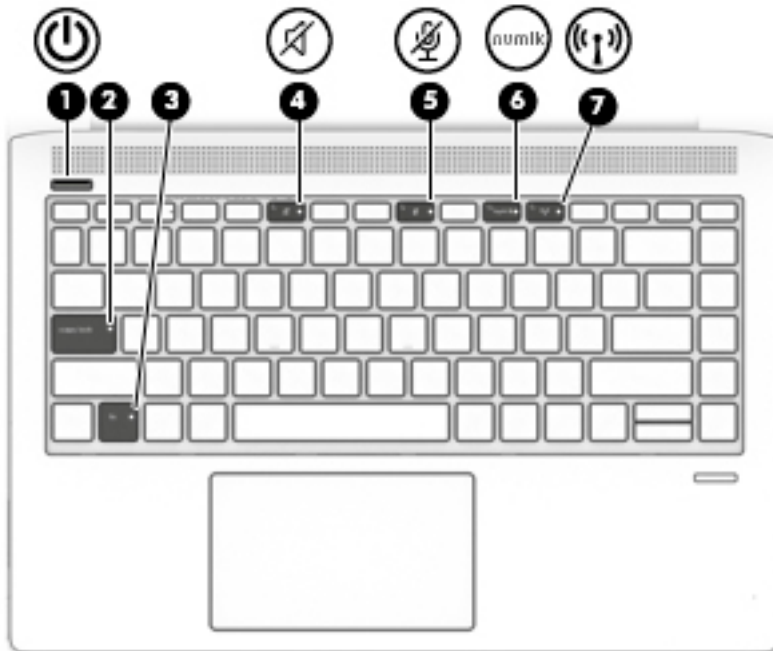





Table 2-5 Lights and their descriptions

Component	Description
(1)  Power light	<ul style="list-style-type: none"> On: The computer is on. Blinking: The computer is in the Sleep state, a power-saving state. The computer shuts off power to the display and other unneeded components. Off: The computer is off or in Hibernation. Hibernation is a power-saving state that uses the least amount of power.
(2) Caps lock light	On: Caps lock is on, which switches the key input to all capital letters.
(3) Fn lock light	On: The fn key is locked.
(4)  Mute light	<ul style="list-style-type: none"> Amber: Computer sound is off. Off: Computer sound is on.
(5)  Microphone mute light	<ul style="list-style-type: none"> Amber: Microphone is off. Off: Microphone is on.
(6) numlk Num lk light	On: Num lock is on.
(7)  Wireless light	<p>On: An integrated wireless device, such as a wireless local area network (WLAN) device and/or a Bluetooth® device, is on.</p> <p>NOTE: On some models, the wireless light is amber when all wireless devices are off.</p>

Buttons, speakers, and fingerprint reader

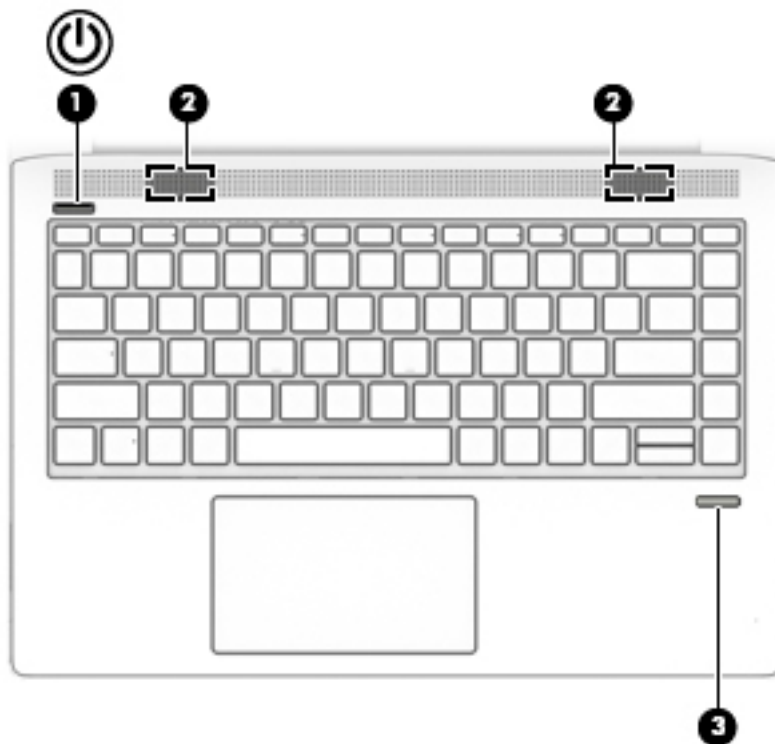



Table 2-6 Buttons, speakers, and fingerprint reader components and their descriptions

Component	Description
(1)  Power button	<ul style="list-style-type: none"> • When the computer is off, press the button to turn on the computer. • When the computer is on, press the button briefly to initiate Sleep. • When the computer is in the Sleep state, press the button briefly to exit Sleep. • When the computer is in Hibernation, press the button briefly to exit Hibernation. <p>CAUTION: Pressing and holding down the power button results in the loss of unsaved information.</p> <p>If the computer has stopped responding and shutdown procedures are ineffective, press and hold the power button for at least 5 seconds to turn off the computer.</p> <p>To learn more about your power settings, see your power options.</p> <p>▲ Right-click the Power meter icon  and then select Power Options.</p>
(2) Speakers (2)	Produce sound.
(3) Fingerprint reader (select products only)	Allows a fingerprint logon to Windows, instead of a password logon.

Special keys

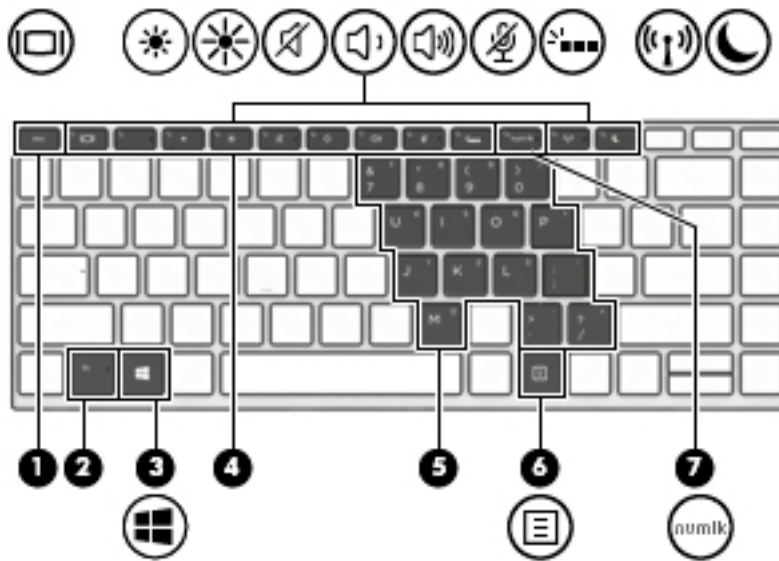



Table 2-7 Special keys and their descriptions

Component	Description
(1) <code>esc</code> key	Displays system information when pressed in combination with the <code>fn</code> key.
(2) <code>fn</code> key	Executes frequently used system functions when pressed in combination with another key. Such key combinations are called <i>hot keys</i> .
(3)  Windows key	Opens the Start menu. NOTE: Pressing the Windows key again will close the Start menu.
(4) Action keys	Execute frequently used system functions.
(5) Embedded numeric keypad	A numeric keypad superimposed over the keyboard alphabet keys. When <code>fn+num lk</code> is pressed, the keypad can be used like an external numeric keypad. Each key on the keypad performs the function indicated by the icon in the upper-right corner of the key. NOTE: If the keypad function is active when the computer is turned off, that function is reinstated when the computer is turned back on.
(6)  Windows application key	Displays options for a selected object.
(7) <code>num lk</code> key	Turns the embedded numeric keypad on and off when pressed in combination with the <code>fn</code> key. – or – Alternates between the navigational and numeric functions on the integrated numeric keypad.

Bottom

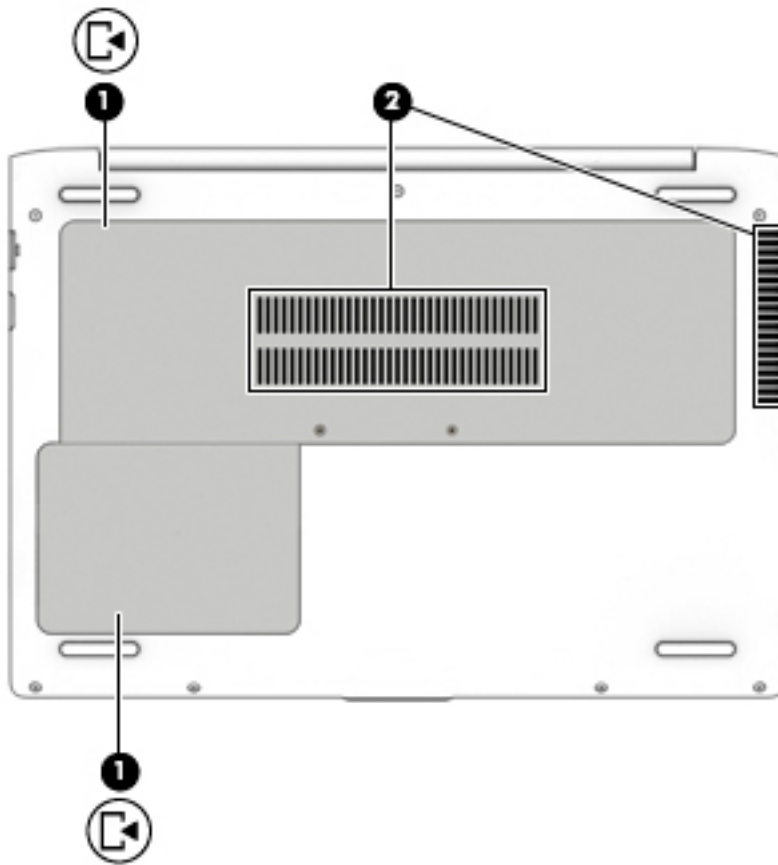



Table 2-8 Bottom components and their descriptions

Component	Description
(1) 	<p>Service doors (2) Provide access to the WLAN module slot and the memory module slots.</p> <p>CAUTION: To prevent an unresponsive system, replace the wireless module only with a wireless module authorized for use in the computer by the governmental agency that regulates wireless devices in your country or region. If you replace the module and then receive a warning message, remove the module to restore computer functionality, and then contact support.</p> <p>▲ Type <code>support</code> in the taskbar search box, and then select the HP Support Assistant app.</p> <p>– or –</p> <p>Click the question mark icon in the taskbar.</p>
(2)	<p>Vents Enable airflow to cool internal components.</p> <p>NOTE: The computer fan starts up automatically to cool internal components and prevent overheating. It is normal for the internal fan to cycle on and off during routine operation.</p>

Labels

The labels affixed to the computer provide information you may need when you troubleshoot system problems or travel internationally with the computer.

IMPORTANT: Check the following locations for the labels described in this section: the bottom of the computer, the bottom of a tablet kickstand, inside the battery bay, under the service door, or on the back of the display.

- Service label—Provides important information to identify your computer. When contacting support, you will probably be asked for the serial number, and possibly for the product number or the model number. Locate these numbers before you contact support.

Your service label will resemble one of the examples shown below. Refer to the illustration that most closely matches the service label on your computer.



Table 2-9 Service label components

Component	
(1)	Serial number
(2)	Product number
(3)	Warranty period
(4)	Model number (select products only)

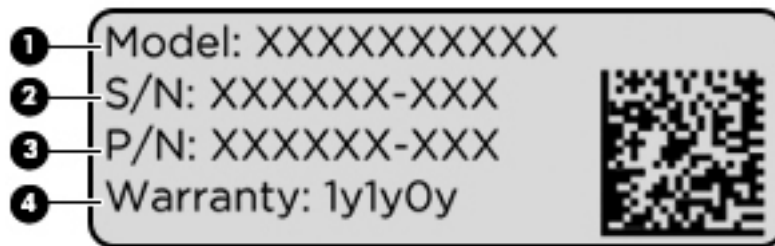

Table 2-10 Service label components

Component	
(1)	Model name (select products only)
(2)	Serial number

Table 2-10 Service label components (continued)

Component	
(3)	Product number
(4)	Warranty period

- Regulatory label(s)—Provide(s) regulatory information about the computer.
- Wireless certification label(s)—Provide(s) information about optional wireless devices and the approval markings for the countries or regions in which the devices have been approved for use.

3 Illustrated parts catalog

Computer major components

 **NOTE:** HP continually improves and changes product parts. For complete and current information on supported parts for your computer, go to <http://partsurfer.hp.com>, select your country or region, and then follow the on-screen instructions.

 **NOTE:** Details about your computer, including model, serial number, product key, and length of warranty, are on the service tag at the bottom of your computer. See [Labels on page 13](#) for details.

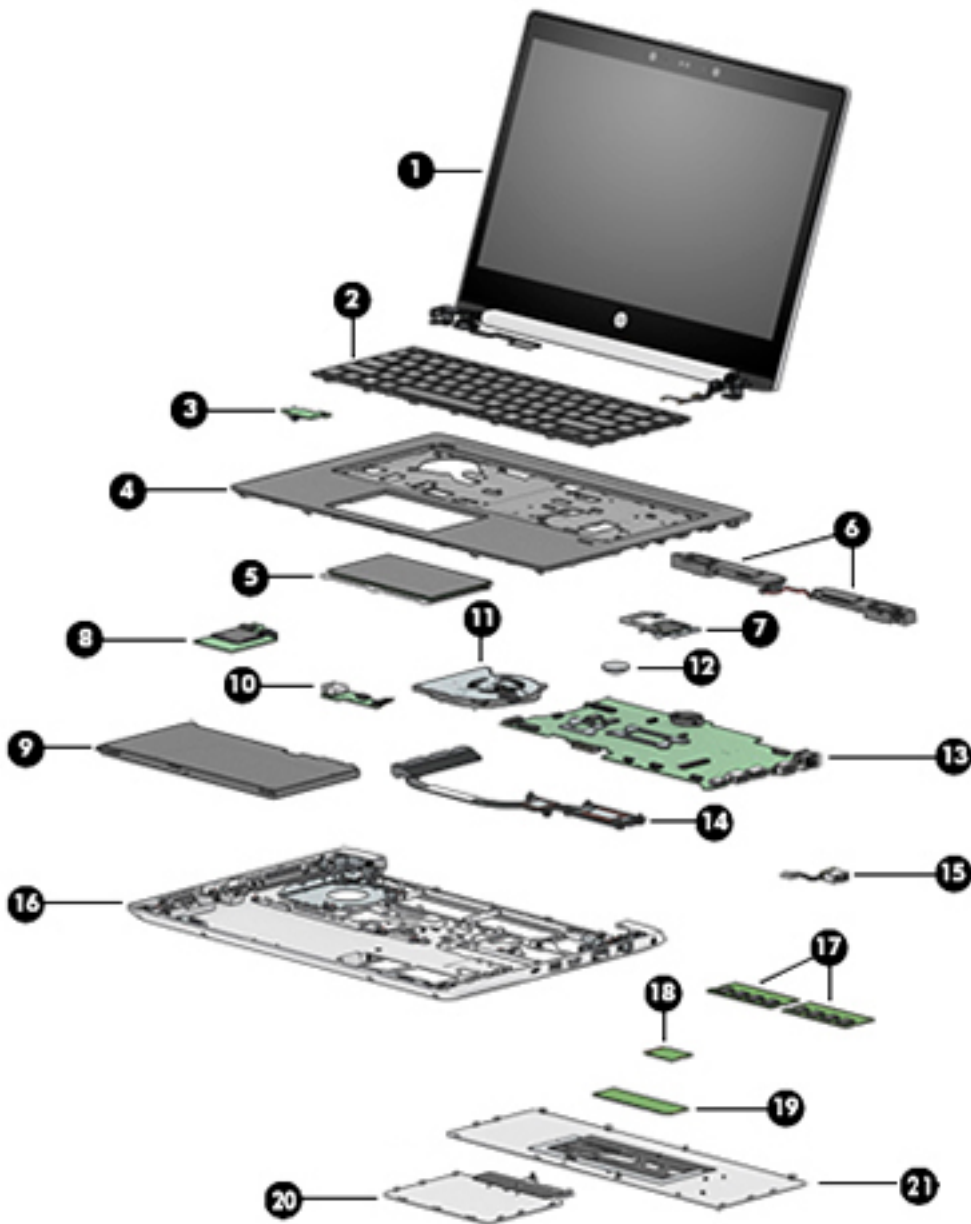

Table 3-1 Computer major components and their descriptions

Item	Description	Spare part number
(1)	Display panel assembly NOTE: Non-touch displays are spared only at the subcomponent level. Non-touch assemblies are not spared as whole units.	not spared
(2)	Keyboard (includes cable) NOTE: For a detailed list of keyboard country codes, see Keyboard on page 35 .	
	No backlight	L01072-xxx
	Backlit	L01071-xxx
(3)	Power button board	L01044-001
(4)	Top cover	L01089-001
(5)	TouchPad	L01056-001
(6)	Speaker assembly	L01087-001
(7)	Fingerprint reader assembly (includes cable)	L01091-001
(8)	Card reader board	L01045-001
(9)	Battery, Li-ion (4-cell, 48 WHr, 4.21 Ah)	851610-855
(10)	USB board	L01043-001
(11)	Fan	L01088-001
(12)	RTC battery	746439-001
(13)	System board with Celeron 3867U processor (includes replacement thermal material)	
	For use in models with Windows 10 IoT	L68817-001
	For use in models without a Windows operating system	L68817-301
(14)	Heat sink assembly (includes replacement thermal material)	L01085-001
(15)	Power connector cable	L07857-001
(16)	Base enclosure	L01090-001
(17)	Memory modules, 4 GB (DDR4-2133)	820569-001
(18)	WLAN module , Intel Dual Band Wireless-AC 8265, 802.11ac, 2x2 Wi-Fi + Bluetooth 4.2 combination adapter	851594-001
(19)	M.2 solid-state drive, 128 GB	L01099-001
(20)	Drive door	not spared
(21)	Service door NOTE: The main service door is included in the Plastics Kit.	L01084-001

Display components

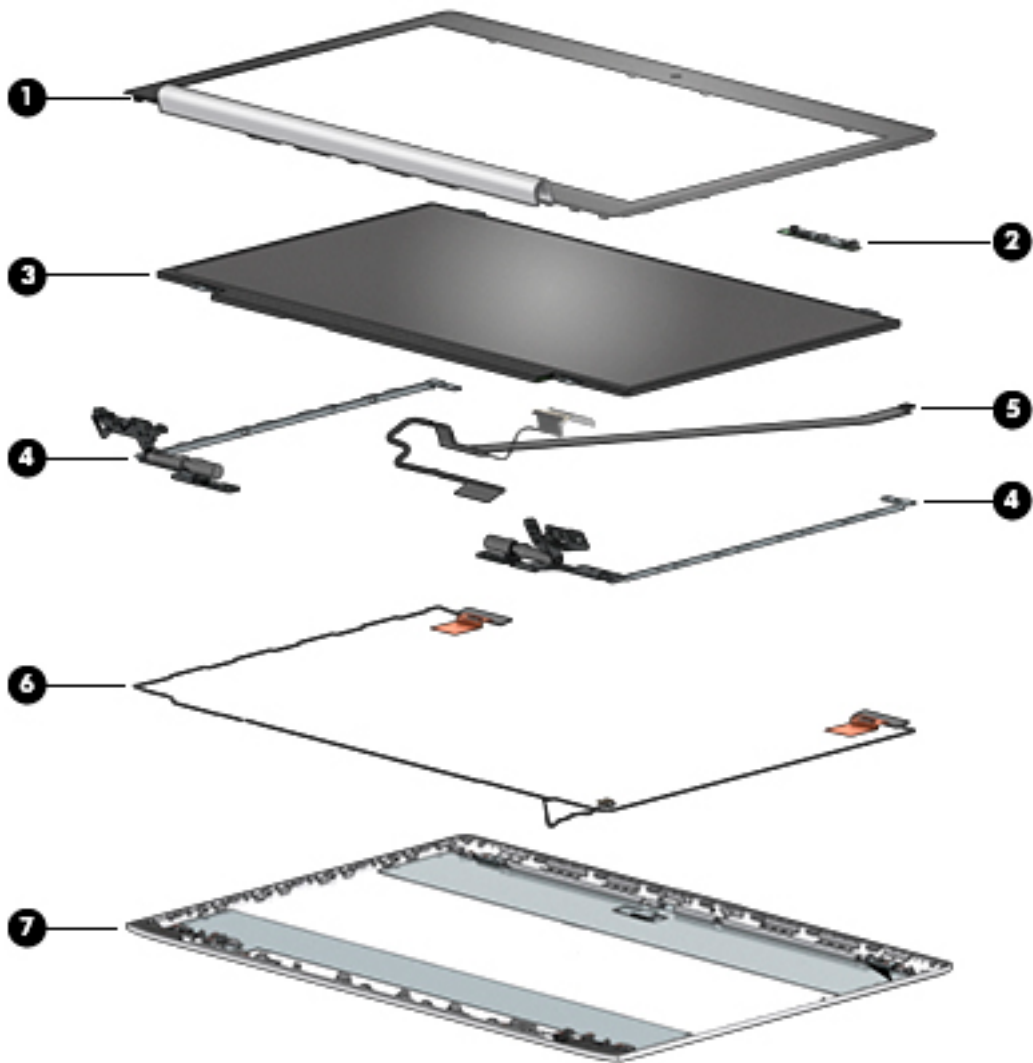

Table 3-2 Display components and their descriptions

Item	Description	Spare part number
(1)	Display bezel	
	Models without a camera	L01094-001
	Models with a camera	L01093-001
(2)	Camera module	L01065-001
	Microphone board	L01046-001
(3)	Display panel (raw)	
	FHD	L01103-001
	HD	L01104-001
(4)	Hinge Kit (includes left and right hinges)	L01097-001

Table 3-2 Display components and their descriptions (continued)

Item	Description	Spare part number
(5)	Display/camera cable assembly	L01095-001
(6)	WLAN antennas	L01949-001
(7)	Display rear cover (includes wireless antennas)	L01092-001

Cable Kit

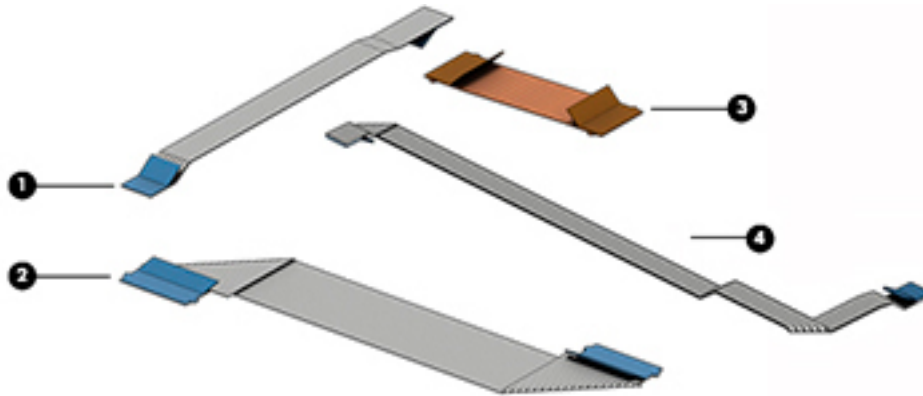

Table 3-3 Cable Kit components and their descriptions

Item	Description	Spare part number
	Cable Kit	L01082-001
(1)	TouchPad cable	
(2)	Card reader board cable	
(3)	USB board cable	
(4)	Power button board cable	

Plastics Kit

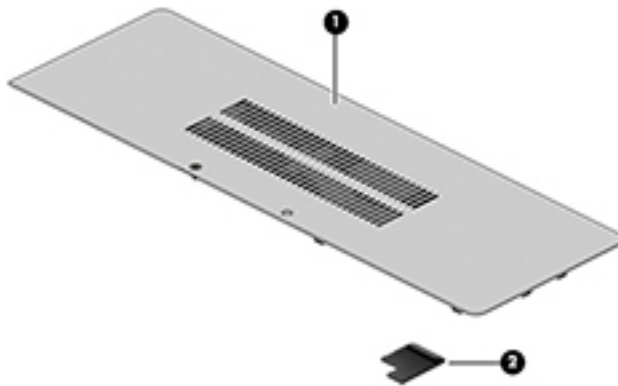

Table 3-4 Plastics Kit components and their descriptions

Item	Description	Spare part number
Plastics Kit		L01084-001
(1)	Main service door	
(2)	Fingerprint reader insert (for use in models without a fingerprint reader)	

Bracket Kit

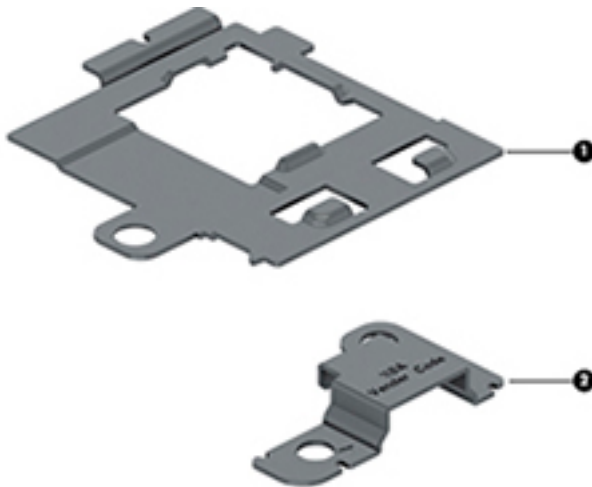

Table 3-5 Bracket Kit components and their descriptions

Item	Description	Spare part number
Bracket Kit		L01051-001
(1)	Fingerprint reader bracket	
(2)	USB reader bracket	
	Keyboard conductive tape (not illustrated)	

Miscellaneous parts

Table 3-6 Miscellaneous parts and their descriptions

Description	Spare part number
AC adapters	
65-W Smart AC power adapter, 4.5 mm barrel connector, EM	913691-850
45-W Smart AC power adapter, 4.5 mm barrel connector, non-slim	741553-850
45-W Smart AC power adapter, 4.5 mm barrel connector, 2 prong	742436-001
Power cord (3-pin, C5, black, 1.0-m), for use in:	
Argentina	931249-001
Australia	923430-001
Brazil	923430-002
Denmark	923430-003
Europe (Austria, Belgium, Finland, France, Germany, the Netherlands, Norway and Sweden)	923430-004
India	923430-006
Israel	923430-005
Italy	923430-007
North America	923430-008
The People's Republic of China	931251-001
South Africa	923430-009
South Korea	931250-001
Switzerland	923430-010
Taiwan	923430-012
Thailand	923430-011
United Kingdom and Singapore	923430-013
Power cord (3-pin, C5, black, 1.8-m), for use in:	
Argentina	931257-001
Australia	931265-001
Brazil	931258-001
Denmark	931261-001
Europe (Austria, Belgium, Finland, France, Germany, the Netherlands, Norway and Sweden)	931259-001
India	931270-001
Israel	931262-001
Italy	931256-001
North America	931255-001
The People's Republic of China	931268-001

Table 3-6 Miscellaneous parts and their descriptions (continued)

Description	Spare part number
South Africa	931264-001
South Korea	931267-001
Switzerland	931263-001
Taiwan	931269-001
Thailand	931266-001
United Kingdom and Singapore	931260-001
Power cord (3-pin, C7, black, 1.00-m), for use in:	
Japan	931325-001
Screw Kit	L01098-001

4 Removal and replacement procedures preliminary requirements

Tools required

You will need the following tools to complete the removal and replacement procedures:

- Flat-bladed screwdriver
- Phillips P0 and P1 screwdrivers
- Torx T8 screwdriver

Service considerations

The following sections include some of the considerations that you must keep in mind during disassembly and assembly procedures.



NOTE: As you remove each subassembly from the computer, place the subassembly (and all accompanying screws) away from the work area to prevent damage.

Plastic parts



IMPORTANT: Using excessive force during disassembly and reassembly can damage plastic parts.

Cables and connectors



IMPORTANT: When servicing the computer, be sure that cables are placed in their proper locations during the reassembly process. Improper cable placement can damage the computer.

Cables must be handled with extreme care to avoid damage. Apply only the tension required to unseat or seat the cables during removal and insertion. Handle cables by the connector whenever possible. In all cases, avoid bending, twisting, or tearing cables. Be sure that cables are routed in such a way that they cannot be caught or snagged by parts being removed or replaced. Handle flex cables with extreme care; these cables tear easily.

Drive handling



IMPORTANT: Drives are fragile components that must be handled with care. To prevent damage to the computer, damage to a drive, or loss of information, observe these precautions:

Before removing or inserting a hard drive, shut down the computer. If you are unsure whether the computer is off or in Hibernation, turn the computer on, and then shut it down through the operating system.

Before handling a drive, be sure that you are discharged of static electricity. While handling a drive, avoid touching the connector.

Before removing an optical drive, be sure that a disc is not in the drive and be sure that the optical drive tray is closed.

Handle drives on surfaces covered with at least 2.54 cm (1 inch) of shock-proof foam.

Avoid dropping drives from any height onto any surface.

After removing a hard drive or an optical drive, place it in a static-proof bag.

Avoid exposing an internal hard drive to products that have magnetic fields, such as monitors or speakers.

Avoid exposing a drive to temperature extremes or liquids.

If a drive must be mailed, place the drive in a bubble pack mailer or other suitable form of protective packaging and label the package “FRAGILE.”

Workstation guidelines

Follow these grounding workstation guidelines:

- Cover the workstation with approved static-shielding material.
- Use a wrist strap connected to a properly grounded work surface and use properly grounded tools and equipment.
- Use conductive field service tools, such as cutters, screw drivers, and vacuums.
- When fixtures must directly contact dissipative surfaces, use fixtures made only of static-safe materials.
- Keep the work area free of nonconductive materials, such as ordinary plastic assembly aids and Styrofoam.
- Handle ESD-sensitive components, parts, and assemblies by the case or PCM laminate. Handle these items only at static-free workstations.
- Avoid contact with pins, leads, or circuitry.
- Turn off power and input signals before inserting or removing connectors or test equipment.

Electrostatic discharge information

A sudden discharge of static electricity from your finger or other conductor can destroy static-sensitive devices or microcircuitry. Often the spark is neither felt nor heard, but damage occurs. An electronic device exposed to electrostatic discharge (ESD) might not appear to be affected at all and can work perfectly throughout a normal cycle. The device might function normally for a while, but it has been degraded in the internal layers, reducing its life expectancy.

Networks built into many integrated circuits provide some protection, but in many cases, the discharge contains enough power to alter device parameters or melt silicon junctions.



IMPORTANT: To prevent damage to the device when you are removing or installing internal components, observe these precautions:

Keep components in their electrostatic-safe containers until you are ready to install them.

Before touching an electronic component, discharge static electricity by using the guidelines described in this section.

Avoid touching pins, leads, and circuitry. Handle electronic components as little as possible.

If you remove a component, place it in an electrostatic-safe container.

Generating static electricity

Note the following:

- Different activities generate different amounts of static electricity.
- Static electricity increases as humidity decreases.

Table 4-1 Static electricity occurrence based on activity and humidity

Event	Relative humidity		
	55%	40%	10%
Walking across carpet	7,500 V	15,000 V	35,000 V
Walking across vinyl floor	3,000 V	5,000 V	12,000 V
Motions of bench worker	400 V	800 V	6,000 V
Removing DIPs (dual in-line packages) from plastic tube	400 V	700 V	2,000 V
Removing DIPs from vinyl tray	2,000 V	4,000 V	11,500 V
Removing DIPs from Styrofoam	3,500 V	5,000 V	14,500 V
Removing bubble pack from PCB (printed circuit board)	7,000 V	20,000 V	26,500 V
Packing PCBs in foam-lined box	5,000 V	11,000 V	21,000 V

Multiple electric components can be packaged together in plastic tubes, trays, or Styrofoam.



NOTE: As little as 700 V can degrade a product.

Preventing electrostatic damage to equipment

Many electronic components are sensitive to ESD. Circuitry design and structure determine the degree of sensitivity. The following packaging and grounding precautions are necessary to prevent static electricity damage to electronic components.

- To avoid hand contact, transport products in static-safe containers such as tubes, bags, or boxes.
- Protect all electrostatic parts and assemblies with conductive or approved containers or packaging.
- Keep electrostatic-sensitive parts in their containers until they arrive at static-free stations.
- Place items on a grounded surface before removing them from their container.
- Always be properly grounded when touching a sensitive component or assembly.

- Avoid contact with pins, leads, or circuitry.
- Place reusable electrostatic-sensitive parts from assemblies in protective packaging or conductive foam.

Personal grounding methods and equipment

Use the following equipment to prevent static electricity damage to electronic components:

- **Wrist straps** are flexible straps with a maximum of $1\text{ M}\Omega \pm 10\%$ resistance in the ground cords. To provide proper ground, a strap must be worn snug against bare skin. The ground cord must be connected and fit snugly into the banana plug connector on the grounding mat or workstation.
- **Heel straps/Toe straps/Boot straps** can be used at standing workstations and are compatible with most types of shoes or boots. On conductive floors or dissipative floor mats, use them on both feet with a maximum of $1\text{ M}\Omega \pm 10\%$ resistance between the operator and ground.

Table 4-2 Static shielding protection levels

Static shielding protection levels	
Method	Voltage
Antistatic plastic	1,500
Carbon-loaded plastic	7,500
Metallized laminate	15,000

Grounding the work area

To prevent static damage at the work area, use the following precautions:

- Cover the work surface with approved static-dissipative material. Provide a wrist strap connected to the work surface and properly grounded tools and equipment.
- Use static-dissipative mats, foot straps, or air ionizers to give added protection.
- Handle electrostatic sensitive components, parts, and assemblies by the case or PCB laminate. Handle them only at static-free work areas.
- Turn off power and input signals before inserting and removing connectors or test equipment.
- Use fixtures made of static-safe materials when fixtures must directly contact dissipative surfaces.
- Keep work area free of nonconductive materials such as ordinary plastic assembly aids and Styrofoam.
- Use field service tools, such as cutters, screwdrivers, and vacuums, that are conductive.

Recommended materials and equipment

HP recommends the following materials and equipment to prevent static electricity:

- Antistatic tape
- Antistatic smocks, aprons, or sleeve protectors
- Conductive bins and other assembly or soldering aids
- Conductive foam
- Conductive tabletop workstations with ground cord of $1\text{ M}\Omega \pm 10\%$ resistance
- Static-dissipative table or floor mats with hard tie to ground

- Field service kits
- Static awareness labels
- Wrist straps and footwear straps providing $1\text{ M}\Omega \pm 10\%$ resistance
- Material handling packages
- Conductive plastic bags
- Conductive plastic tubes
- Conductive tote boxes
- Opaque shielding bags
- Transparent metallized shielding bags
- Transparent shielding tubes

Packaging and transporting guidelines

Follow these grounding guidelines when packaging and transporting equipment:

- To avoid hand contact, transport products in static-safe tubes, bags, or boxes.
- Protect ESD-sensitive parts and assemblies with conductive or approved containers or packaging.
- Keep ESD-sensitive parts in their containers until the parts arrive at static-free workstations.
- Place items on a grounded surface before removing items from their containers.
- Always be properly grounded when touching a component or assembly.
- Store reusable ESD-sensitive parts from assemblies in protective packaging or nonconductive foam.
- Use transporters and conveyors made of antistatic belts and roller bushings. Be sure that mechanized equipment used for moving materials is wired to ground and that proper materials are selected to avoid static charging. When grounding is not possible, use an ionizer to dissipate electric charges.

5 Removal and replacement procedures for Customer Self-Repair parts

 **CAUTION:** The Customer Self-Repair program is not available in all locations. Installing a part not supported by the Customer Self-Repair program may void your warranty. Check your warranty to determine if Customer Self-Repair is supported in your location.

 **NOTE:** HP continually improves and changes product parts. For complete and current information on supported parts for your computer, go to <http://partsurfer.hp.com>, select your country or region, and then follow the on-screen instructions.

Component replacement procedures

 **NOTE:** Please read and follow the procedures described here to access and replace Customer Self-Repair parts successfully.

 **NOTE:** Details about your computer, including model, serial number, product key, and length of warranty, are on the service tag at the bottom of your computer. See [Labels on page 13](#) for details.

This chapter provides removal and replacement procedures for Customer Self-Repair parts.

There are as many as 6 screws that must be removed, replaced, or loosened when servicing Customer Self-Repair parts. Make special note of each screw size and location during removal and replacement.

Battery Safe mode

Before removing internal components, you must place the computer in “Battery Safe mode.” This mode avoids short-circuits or system malfunction by removing power from internal components.

To place the computer in “Battery Safe mode,” follow these steps:

1. With the computer turned off and AC adapter connected, press the following key and button combination: **Windows key + Backspace key + Power button.**
2. Turn the computer on to initiate “Battery Safe mode.”
3. After the computer powers off, disconnect the AC adapter.

In “Battery Safe mode,” the power button will not turn the computer on if the AC adapter is not connected.

To disengage “Battery Safe mode,” plug in the AC adapter and press the power button.

Service doors

Table 5-1 Service door description and part number

Description	Spare part number
Service door (included in Plastics Kit)	L01084-001
Drive service door	not spared

The bottom of the computer has two service doors. The drive service door provides access to the M.2 solid-state drive. The main service door provides access to the memory modules, and wireless module, and keyboard screws.

Before removing the service doors, follow these steps:

1. Shut down the computer. If you are unsure whether the computer is off or in Hibernation, turn the computer on, and then shut it down through the operating system.
2. Place the computer in “Battery Safe mode” ([Battery Safe mode on page 27](#)).
3. Disconnect all external devices connected to the computer.
4. Disconnect the power from the computer by first unplugging the power cord from the AC outlet, and then unplugging the AC adapter from the computer.

Remove the service doors:

Main service door

1. Loosen the captive Phillips screw **(1)**.
2. Lift the bottom of the door upward **(2)**, and then remove the door from the computer **(3)**.

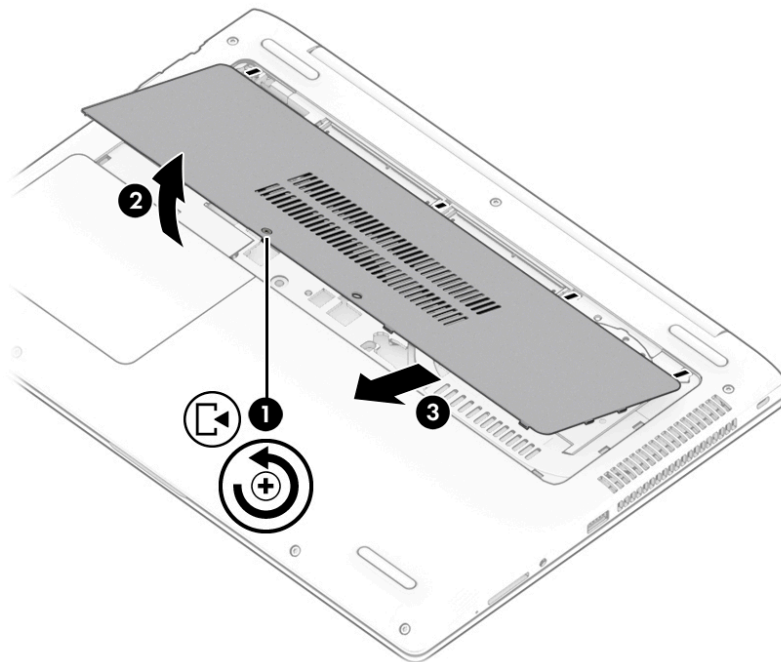

Drive service door

3. Loosen the captive Phillips screw **(1)**.

4. Lift the bottom of the door upward **(2)**, and then remove the door from the computer **(3)**.

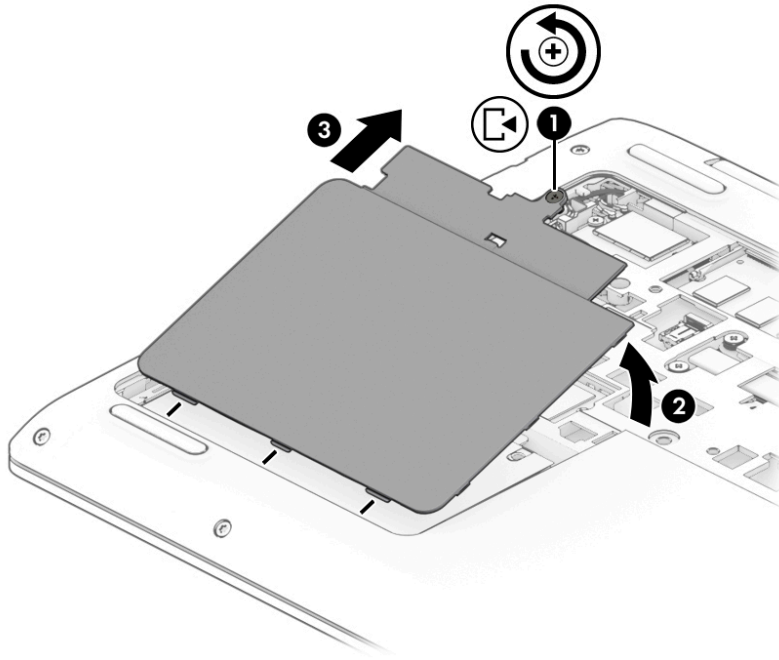

Reverse these procedures to install the service doors.

Memory modules

Table 5-2 Memory module description and part number

Description	Spare part number
4-GB (DDR4-2133)	820569-001

Update BIOS before adding memory modules

Before adding new memory, make sure you update the computer to the latest BIOS.

 **CAUTION:** Failure to update the computer to the latest BIOS prior to installing new memory may result in various system problems.

To update BIOS:

1. Navigate to www.hp.com.
2. Move the cursor over **Support** to display the pull-down menu, and then click **Software & drivers**.
3. Type your product name, number, or serial number, and then click **Find**.
4. Click **BIOS**, and then click **Download**.
5. Follow the on-screen instructions.

Before removing the memory module, follow these steps:

1. Shut down the computer. If you are unsure whether the computer is off or in Hibernation, turn the computer on, and then shut it down through the operating system.
2. Place the computer in “Battery Safe mode” ([Battery Safe mode on page 27](#)).
3. Disconnect all external devices connected to the computer.
4. Disconnect the power from the computer by first unplugging the power cord from the AC outlet, and then unplugging the AC adapter from the computer.
5. Remove the main service door ([Service doors on page 28](#)).

Remove the memory module:

1. Spread the retaining tabs **(1)** on each side of the memory module slot to release the memory module. (The edge of the module opposite the slot rises away from the computer.)

2. Remove the memory module (2) by pulling the module away from the slot at an angle.

 **NOTE:** Memory modules are designed with a notch to prevent incorrect insertion into the memory module slot.

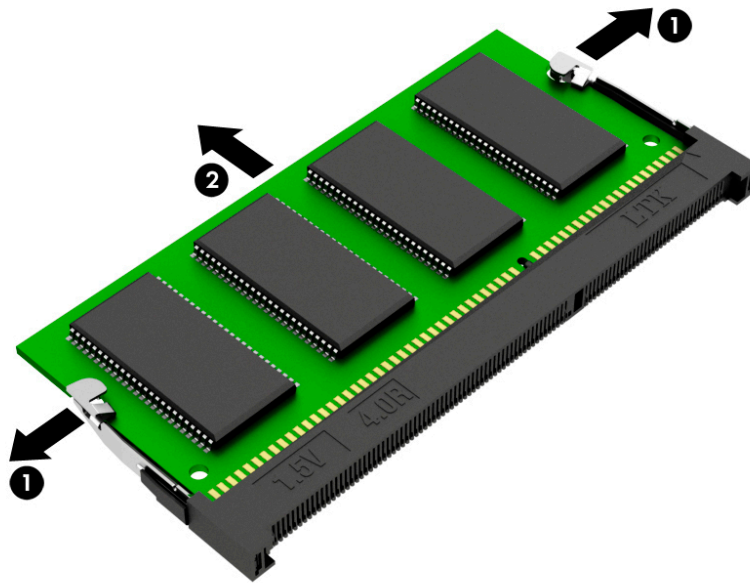

Reverse this procedure to install a memory module.

WLAN/Bluetooth combo card

The computer uses a card that provides both WLAN and Bluetooth functionality.

Table 5-3 WLAN module description and part number

Description	Spare part number
Intel Dual Band Wireless-AC 8265, 802.11ac, 2x2 Wi-Fi + Bluetooth 4.2 combination adapter	851594-001

Before removing the WLAN module, follow these steps:

1. Shut down the computer. If you are unsure whether the computer is off or in Hibernation, turn the computer on, and then shut it down through the operating system.
2. Place the computer in “Battery Safe mode” ([Battery Safe mode on page 27](#)).
3. Disconnect all external devices connected to the computer.
4. Disconnect the power from the computer by first unplugging the power cord from the AC outlet, and then unplugging the AC adapter from the computer.
5. Remove the main service door ([Service doors on page 28](#)).

Remove the WLAN module:

1. Disconnect the WLAN antenna cables **(1)** from the terminals on the WLAN module.





NOTE: The WLAN antenna cable labeled “1” connects to the WLAN module “Main” terminal labeled “1”. The WLAN antenna cable labeled “2” connects to the WLAN module “Aux” terminal labeled “2”. If the computer is equipped with an 802.11a/b/g/n WLAN module, the yellow WLAN antenna cable connects to the middle terminal on the WLAN module.

2. Remove the Phillips M2.0×4.0 screw **(2)** that secures the WLAN module to the computer. (The edge of the module opposite the slot rises away from the computer.)

3. Remove the WLAN module (3) by pulling the module away from the slot at an angle.

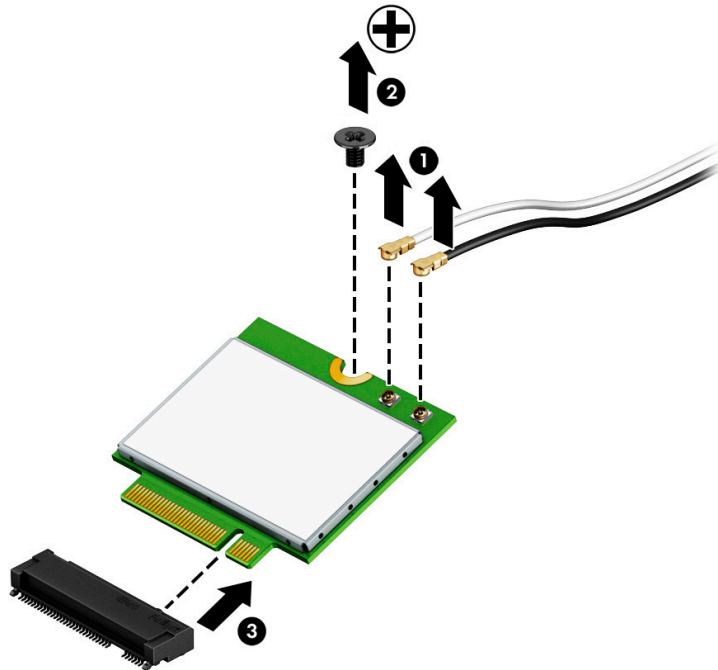
 **NOTE:** WLAN modules are designed with a notch to prevent incorrect insertion.



 **NOTE:** If the WLAN antennas are not connected to the terminals on the WLAN module, the protective sleeves must be installed on the antenna connectors, as shown in the following illustration.

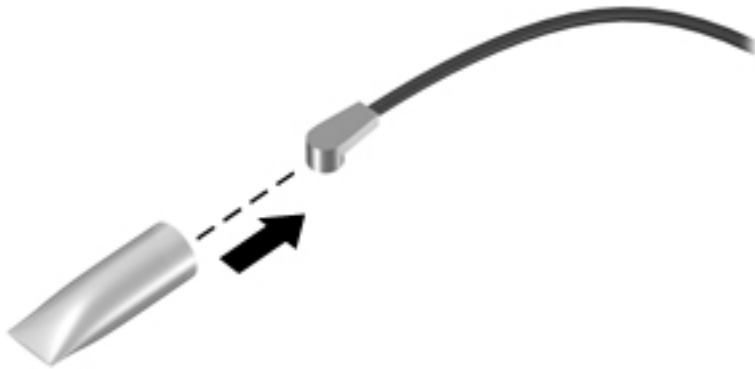

Reverse this procedure to install the WLAN module.

M.2 solid-state drive

Table 5-4 Solid-state drive description and part number

Description	Spare part number
128-GB, SATA-3, TLC	L01099-001

Before removing the solid-state drive, follow these steps:

1. Shut down the computer. If you are unsure whether the computer is off or in Hibernation, turn the computer on, and then shut it down through the operating system.
2. Place the computer in “Battery Safe mode” ([Battery Safe mode on page 27](#)).
3. Disconnect all external devices connected to the computer.
4. Disconnect the power from the computer by first unplugging the power cord from the AC outlet, and then unplugging the AC adapter from the computer.
5. Remove the main service door ([Service doors on page 28](#)).
6. Remove the drive service door ([Service doors on page 28](#)).

Remove the solid-state drive:

1. Remove the Phillips M2.0×4.0 screw **(1)** that secures the solid-state drive to the computer. (The edge of the module opposite the slot rises away from the computer.)
2. Remove the solid-state drive **(2)** by pulling the module away from the slot at an angle.

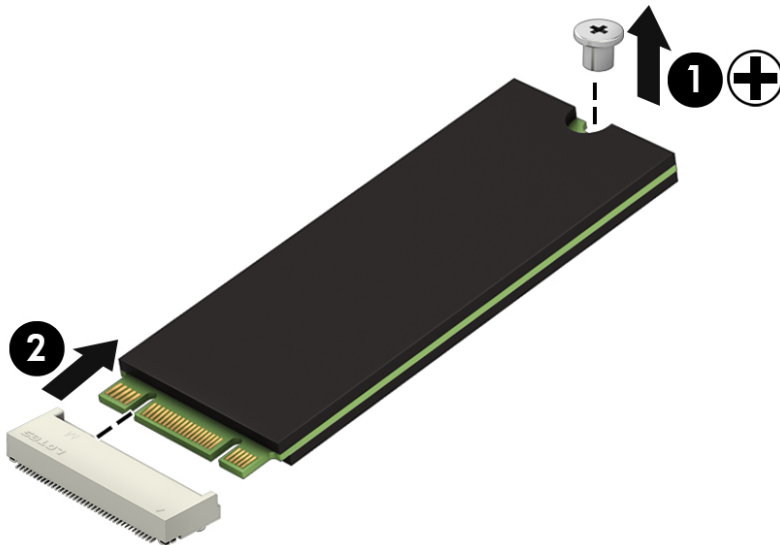

Reverse this procedure to install the solid-state drive.

Keyboard

In this section, the first table provides the main spare part number for the keyboards. The second table provides the country codes.

Table 5-5 Keyboard descriptions and part numbers

Description	Spare part number
Keyboard, no backlight	L01072-xxx
Keyboard, backlit	L01071-xxx

Table 5-6 Keyboard country codes

For use in country or region	Spare part number	For use in country or region	Spare part number	For use in country or region	Spare part number
Belgium	-A41	Iceland	-DD1	Saudi Arabia	-171
Brazil	-201	India	-D61	Slovenia	-BA1
Bulgaria	-261, -262	Israel	-BB1, BB2	South Korea	-AD1
Canada	-DB1, DB2	Italy	-061	Spain	-071
Czech Republic and Slovakia	-FL1, FL2	Japan	-291	Switzerland	-BG1
Denmark	-081	Latin America	-161	Taiwan	-AB1
Denmark, Finland, and Norway	-DH1	The Netherlands	-B31	Thailand	-281
France	-051	Northern Africa	-FP1	Turkey	-141
Germany	-041	Portugal	-131	Ukraine	-BD1
Greece	-151	Romania	-272	United Kingdom	-031, -032
Hungary	-211	Russia	-251	United States	-001

Before removing the keyboard, follow these steps:

1. Shut down the computer. If you are unsure whether the computer is off or in Hibernation, turn the computer on, and then shut it down through the operating system.
2. Place the computer in “Battery Safe mode” ([Battery Safe mode on page 27](#)).
3. Disconnect all external devices connected to the computer.
4. Disconnect the power from the computer by first unplugging the power cord from the AC outlet, and then unplugging the AC adapter from the computer.
5. Remove the main service door ([Service doors on page 28](#)).

Remove the keyboard:

1. Remove the 2 Phillips M2.5×5.0 screws that secure the keyboard to the computer **(1)**.

2. Insert a tool into the access hole next to the fan in the bottom of the computer and push to disengage the keyboard from the top cover **(2)**.

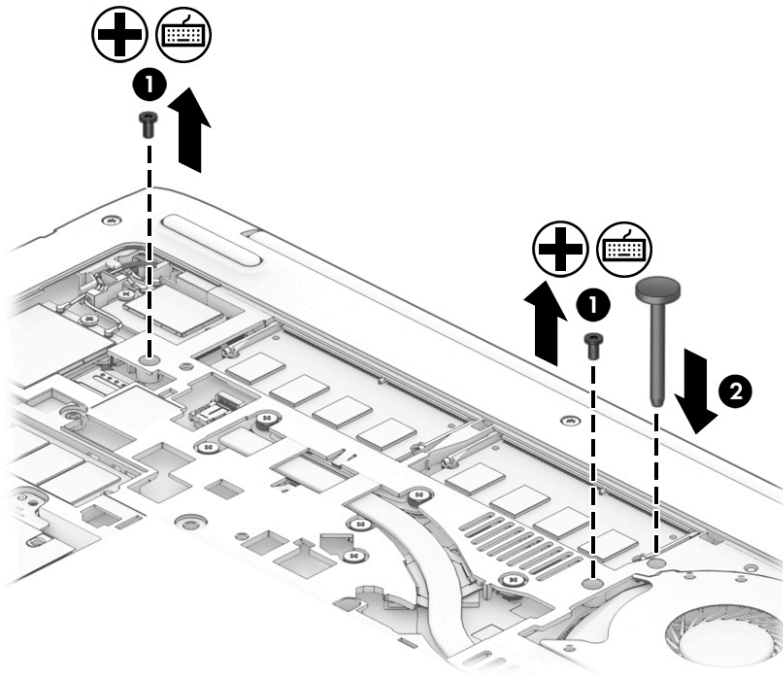

3. Lift the top of the keyboard upward, and then rotate the keyboard until it rests on the palm rest.



NOTE: A cable (or cables) connect the bottom of the keyboard to the system board. Make sure not to prematurely pull the cables out of the system board connector(s).



4. If applicable, disconnect the backlight cable by lifting the ZIF connector latch **(1)**, and then disconnect the cable from the system board **(2)**.

5. Disconnect the keyboard cable by lifting the reverse ZIF connector latch **(3)**, and then disconnect the keyboard cable from the system board **(4)**.
6. Remove the keyboard **(5)**.

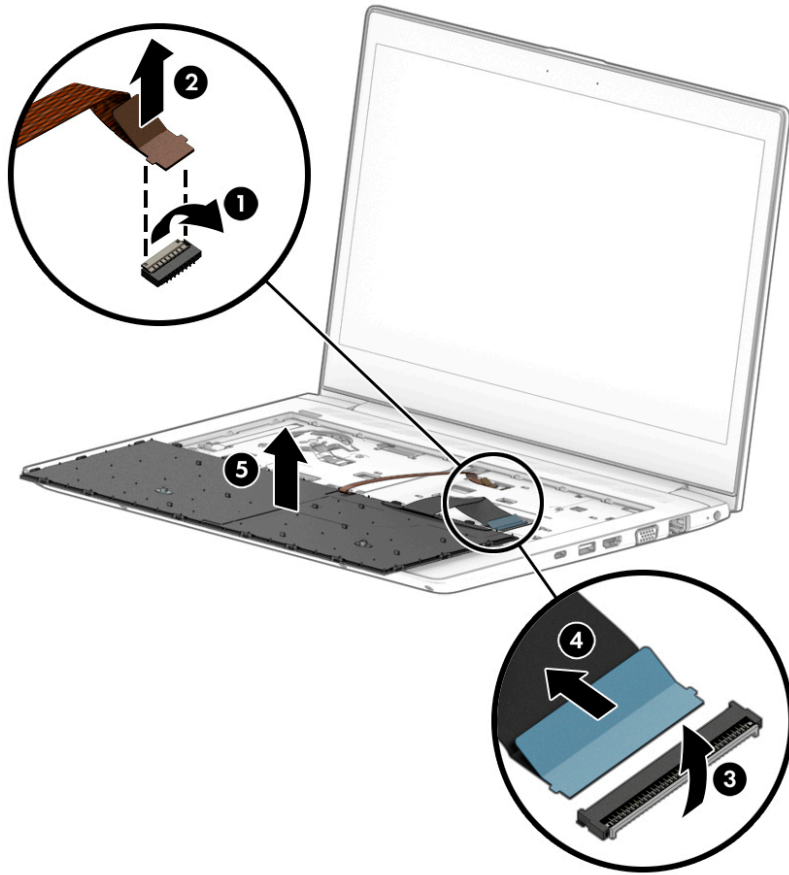

Reverse this procedure to install the keyboard.

6 Removal and replacement procedures for Authorized Service Provider parts

 **CAUTION:** Components described in this chapter should only be accessed by an authorized service provider. Accessing these parts can damage the computer or void the warranty.

 **NOTE:** HP continually improves and changes product parts. For complete and current information on supported parts for your computer, go to <http://partsurfer.hp.com>, select your country or region, and then follow the on-screen instructions.

Component replacement procedures

 **NOTE:** Details about your computer, including model, serial number, product key, and length of warranty, are on the service tag at the bottom of your computer. See [Labels on page 13](#) for details.

This chapter provides removal and replacement procedures for Authorized Service Provider only parts.

There are as many as 51 screws that must be removed, replaced, or loosened when servicing Authorized Service Provider only parts. Make special note of each screw size and location during removal and replacement.

Top cover

Table 6-1 Top cover description and part number

Description	Spare part number
Top cover	L01089-001

Before removing the top cover, follow these steps:

1. Shut down the computer. If you are unsure whether the computer is off or in Hibernation, turn the computer on, and then shut it down through the operating system.
2. Place the computer in “Battery Safe mode” ([Battery Safe mode on page 27](#)).
3. Disconnect all external devices connected to the computer.
4. Disconnect the power from the computer by first unplugging the power cord from the AC outlet, and then unplugging the AC adapter from the computer.
5. Remove the following components:
 - a. Service doors ([Service doors on page 28](#)).
 - b. Keyboard ([Keyboard on page 35](#))

Remove the top cover:

1. Position the computer upside-down with the front toward you.
2. Remove the 8 Torx T8 2.5×6.0 screws **(1)** from around the edges of the computer.
3. Remove the Phillips broad head M2.0×2.0 screw **(2)** from the drive bay.

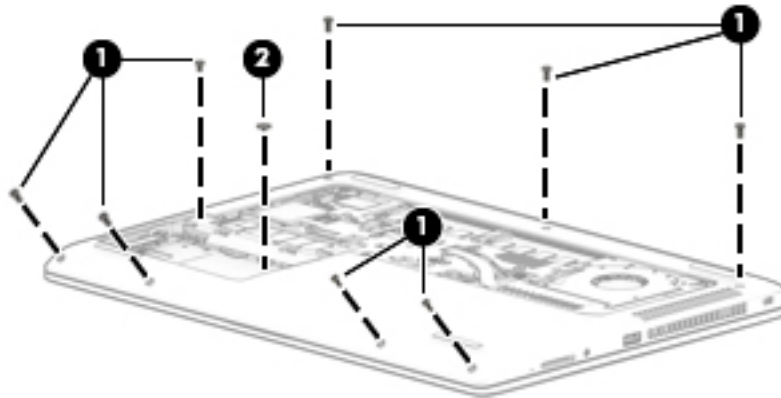

4. Position the computer upright and open it as far as possible.

5. Remove the 6 Torx T8 2.5×5.0 screws from under the keyboard.

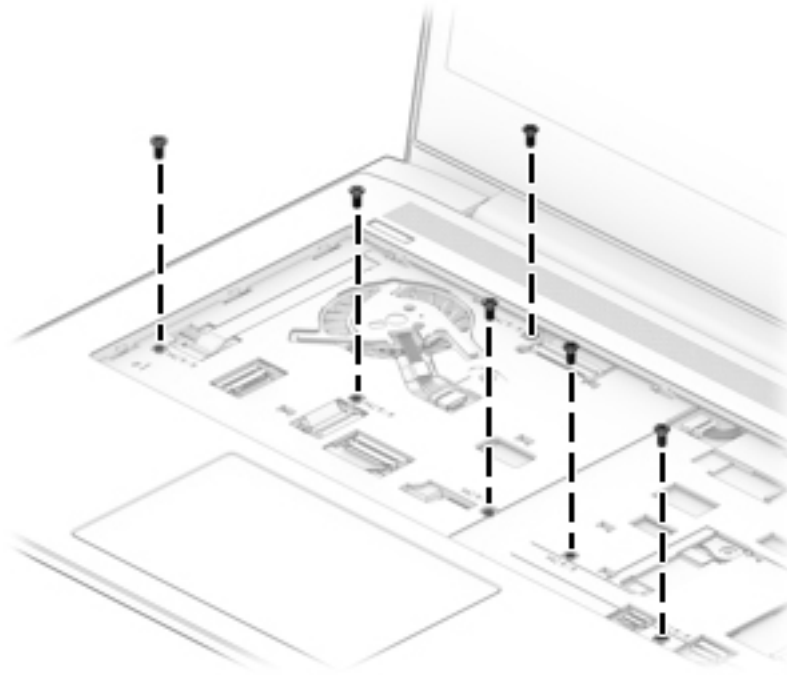

6. Disconnect the following cables from the system board:

- (1) Power button board cable
- (2) Speaker cable
- (3) TouchPad board cable
- (4) Fingerprint reader cable

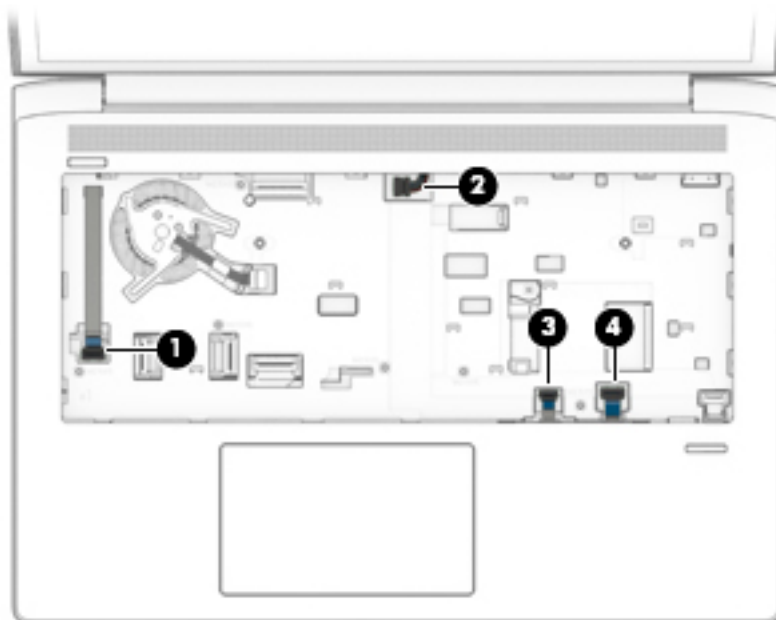

7. To remove the top cover, start prying upward on both sides of the TouchPad **(1)**, and then remove the top cover from the computer **(2)**.

 **NOTE:** The top cover may be secured very tightly to the computer.

 **TIP:** After disengaging the front of the top cover, the rear near the display may remain connected. If this is the case, lift up on the rear part of the top cover to remove.

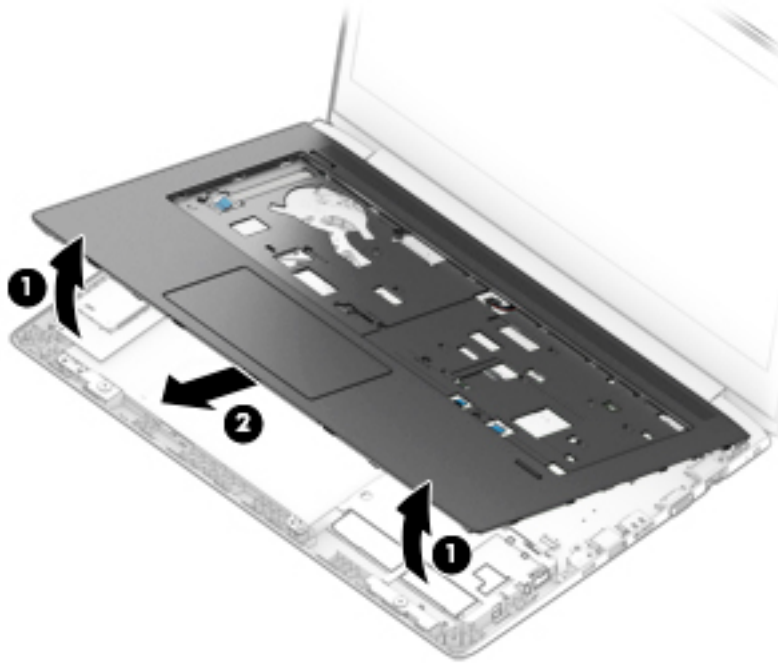

Reverse this procedure to install the top cover.

Fingerprint reader assembly

Table 6-2 Fingerprint reader assembly description and part number

Description	Spare part number
Fingerprint reader assembly (includes cable)	L01091-001
Fingerprint reader bracket (included in Bracket Kit)	L01051-001
Fingerprint reader insert (included in Plastics Kit; for use in models without a fingerprint reader)	L01084-001

Before removing the fingerprint reader assembly, follow these steps:

1. Shut down the computer. If you are unsure whether the computer is off or in Hibernation, turn the computer on, and then shut it down through the operating system.
2. Place the computer in “Battery Safe mode” ([Battery Safe mode on page 27](#)).
3. Disconnect all external devices connected to the computer.
4. Disconnect the power from the computer by first unplugging the power cord from the AC outlet, and then unplugging the AC adapter from the computer.
5. Remove the following components:
 - a. Service doors ([Service doors on page 28](#)).
 - b. Keyboard ([Keyboard on page 35](#))
 - c. Top cover ([Top cover on page 39](#))

Remove the fingerprint reader assembly:

1. Position the top cover upside-down.
2. If necessary, lift the tape from atop the bracket **(1)**.
3. Slide the bracket toward the side of the top cover, and then lift it off the fingerprint reader board **(2)**.

 **TIP:** A tool may be required to push and disengage the bracket.

4. Lift the fingerprint reader cable (3) and board (4) to disengage the adhesive that secures them to the top cover, and then remove the board and cable assembly from the top cover.

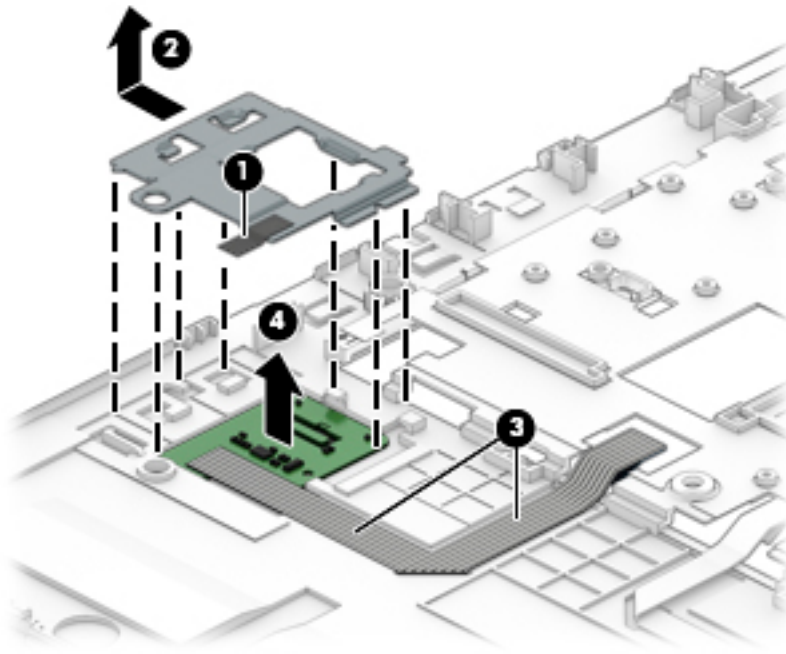

Reverse this procedure to install the fingerprint reader assembly.

Power button board

Table 6-3 Power button board description and part number

Description	Spare part number
Power button board	L01044-001
Power button board cable (included in Cable Kit)	L01082-001

Before removing the power button board, follow these steps:

1. Shut down the computer. If you are unsure whether the computer is off or in Hibernation, turn the computer on, and then shut it down through the operating system.
2. Place the computer in “Battery Safe mode” ([Battery Safe mode on page 27](#)).
3. Disconnect all external devices connected to the computer.
4. Disconnect the power from the computer by first unplugging the power cord from the AC outlet, and then unplugging the AC adapter from the computer.
5. Remove the following components:
 - a. Service doors ([Service doors on page 28](#))
 - b. Keyboard ([Keyboard on page 35](#))
 - c. Top cover ([Top cover on page 39](#))

Remove the power button board:

1. Position the top cover upside-down.
2. Disconnect the cable from the connector on the board **(1)**.
3. Remove the Phillips M2.0×3.0 screw **(2)** that secures the board to the top cover.
4. Lift the left side of the board **(3)**, and then pull the board to the left **(4)** to remove it from under the tab **(5)**.

5. If you need to replace the cable, note the cable routing path inside of the top cover.

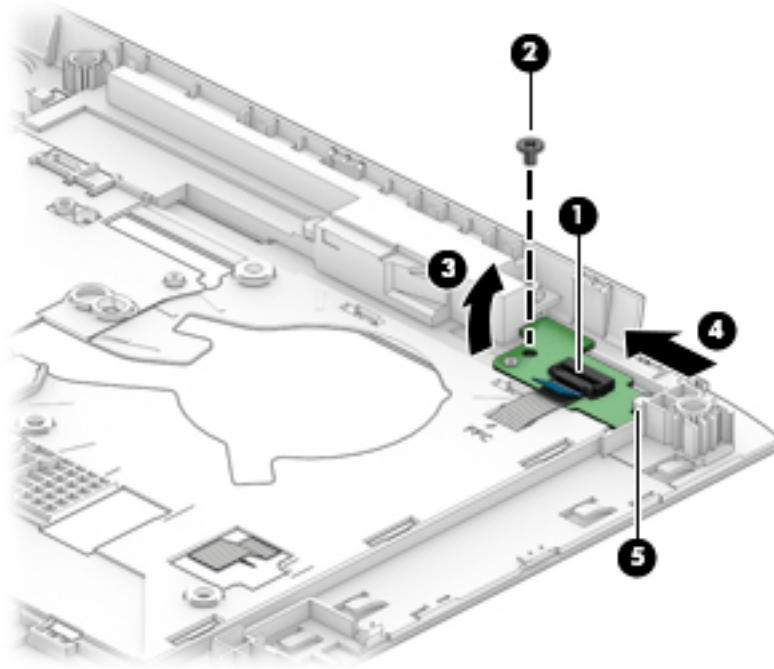

Reverse this procedure to install the power button board.

Speaker assembly

Table 6-4 Speaker assembly description and part number

Description	Spare part number
Speaker assembly	L01087-001

Before removing the speaker assembly, follow these steps:

1. Shut down the computer. If you are unsure whether the computer is off or in Hibernation, turn the computer on, and then shut it down through the operating system.
2. Place the computer in “Battery Safe mode” ([Battery Safe mode on page 27](#)).
3. Disconnect all external devices connected to the computer.
4. Disconnect the power from the computer by first unplugging the power cord from the AC outlet, and then unplugging the AC adapter from the computer.
5. Remove the following components:
 - a. Service doors ([Service doors on page 28](#)).
 - b. Keyboard ([Keyboard on page 35](#))
 - c. Top cover ([Top cover on page 39](#))

Remove the speaker assembly:

1. Position the top cover upside-down.
2. Remove the 2 Phillips M2.0×6.0 screws **(1)** that secure the speaker assembly to the top cover.
3. Remove the cable from the clips in the top cover **(2)**.

4. Remove the speakers from the top cover (3).

 **IMPORTANT:** When removing the speakers, make sure the rubber feet (4) and rubber screw gaskets (5) remain attached to the speakers. These parts must be installed with the speakers.

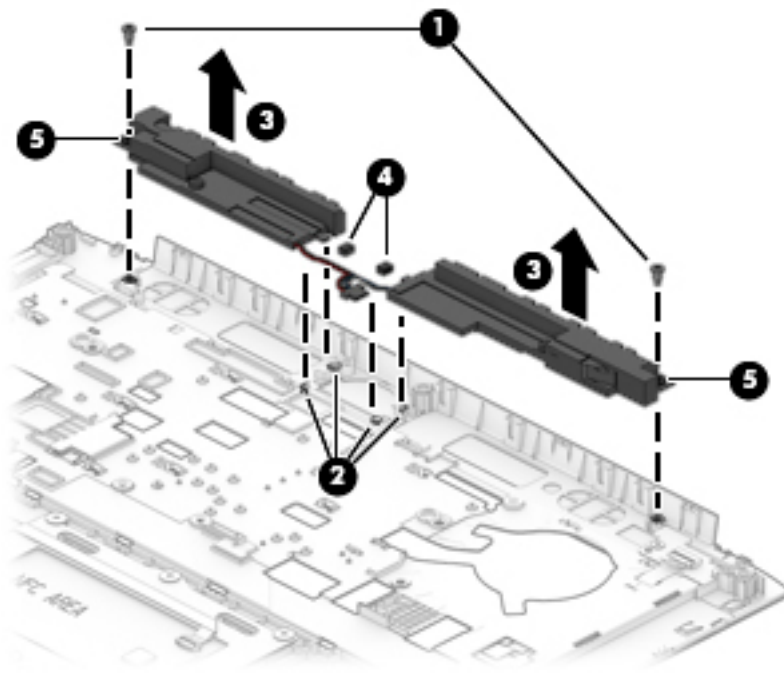

Reverse this procedure to install the speaker assembly.

TouchPad assembly

Table 6-5 TouchPad assembly description and part number

Description	Spare part number
TouchPad assembly	L01056-001
TouchPad assembly cable (included in Cable Kit)	L01082-001

Before removing the TouchPad assembly, follow these steps:

1. Shut down the computer. If you are unsure whether the computer is off or in Hibernation, turn the computer on, and then shut it down through the operating system.
2. Place the computer in “Battery Safe mode” ([Battery Safe mode on page 27](#)).
3. Disconnect all external devices connected to the computer.
4. Disconnect the power from the computer by first unplugging the power cord from the AC outlet, and then unplugging the AC adapter from the computer.
5. Remove the following components:
 - a. Service doors ([Service doors on page 28](#)).
 - b. Keyboard ([Keyboard on page 35](#))
 - c. Top cover ([Top cover on page 39](#))

Remove the TouchPad assembly:

1. Position the top cover upside-down.
2. Disconnect the cable from the ZIF connector on the TouchPad **(1)**.
3. Lift the cable to remove it from the adhesive that secures it to the top cover **(2)**.
4. Remove the 6 broad head Phillips M2.0×2.0 screws **(3)** that secure the TouchPad to the top cover.

5. Lift the TouchPad off the top cover (4).

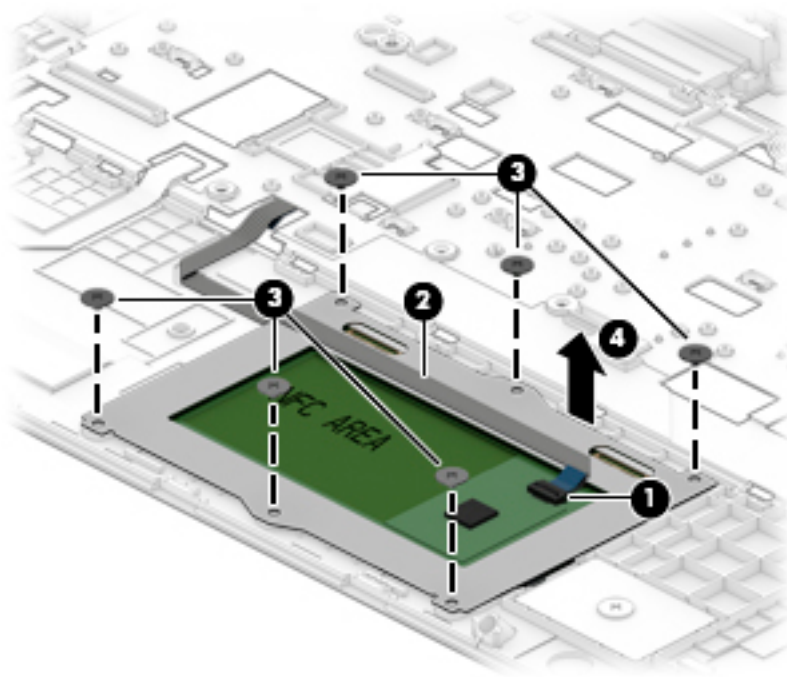

Reverse this procedure to install the TouchPad assembly.

Card reader board

Table 6-6 Card reader board description and part number

Description	Spare part number
Card reader board assembly	L01045-001
Card reader board cable (included in Cable Kit)	L01082-001

Before removing the card reader board, follow these steps:

1. Shut down the computer. If you are unsure whether the computer is off or in Hibernation, turn the computer on, and then shut it down through the operating system.
2. Place the computer in “Battery Safe mode” ([Battery Safe mode on page 27](#)).
3. Disconnect all external devices connected to the computer.
4. Disconnect the power from the computer by first unplugging the power cord from the AC outlet, and then unplugging the AC adapter from the computer.
5. Remove the following components:
 - a. Service doors ([Service doors on page 28](#))
 - b. Keyboard ([Keyboard on page 35](#))
 - c. Top cover ([Top cover on page 39](#))

Remove the card reader board:

1. Position the computer upright on a flat surface and open the display as far as possible.
2. Disconnect the cable from the system board ZIF connector **(1)**.
3. Remove the 2 Torx T8 2.5×4.0 screws **(2)** that secure the board to the computer.
4. Lift the board out of the computer **(3)**.

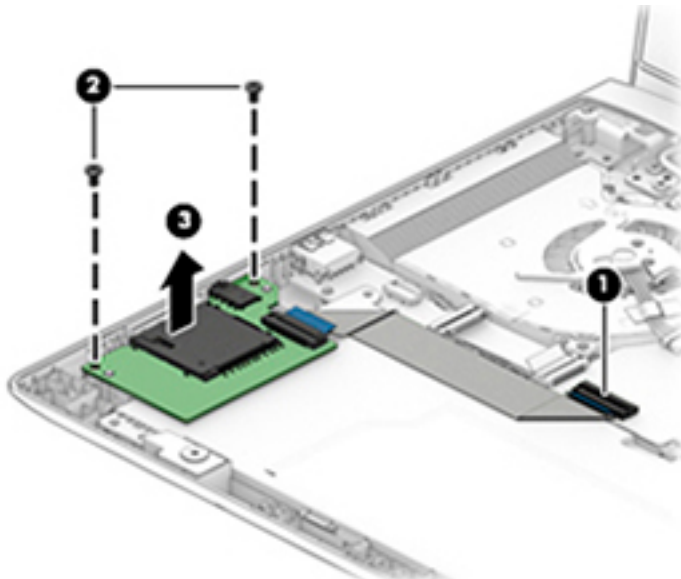

Reverse this procedure to install the card reader board.

Fan

Table 6-7 Fan description and part number

Description	Spare part number
Fan	L01088-001



NOTE: To properly ventilate the computer, allow at least **7.6 cm** (3.0 in) of clearance on the sides of the computer. The computer uses an electric fan for ventilation. The fan is controlled by a temperature sensor and is designed to turn on automatically when high temperature conditions exist. These conditions are affected by high external temperatures, system power consumption, power management/battery conservation configurations, battery fast charging, and software requirements. Exhaust air is displaced through the ventilation grill.

Before removing the fan, follow these steps:

1. Shut down the computer. If you are unsure whether the computer is off or in Hibernation, turn the computer on, and then shut it down through the operating system.
2. Place the computer in “Battery Safe mode” ([Battery Safe mode on page 27](#)).
3. Disconnect all external devices connected to the computer.
4. Disconnect the power from the computer by first unplugging the power cord from the AC outlet and then unplugging the AC adapter from the computer.
5. Remove the battery ([Battery on page 54](#)), and then remove the following components:
 - a. Service doors ([Service doors on page 28](#)).
 - b. Keyboard ([Keyboard on page 35](#))
 - c. Top cover ([Top cover on page 39](#))

To remove the fan:

1. Position the computer upright on a flat surface and open the display as far as possible.
2. Disconnect the fan cable **(1)** from the system board.
3. Remove the display cable from atop the screw **(2)**.
4. Remove the two Torx T8 2.5×5.0 screws **(3)** that secure the fan to the computer.

5. Lift the fan out of the computer (4).

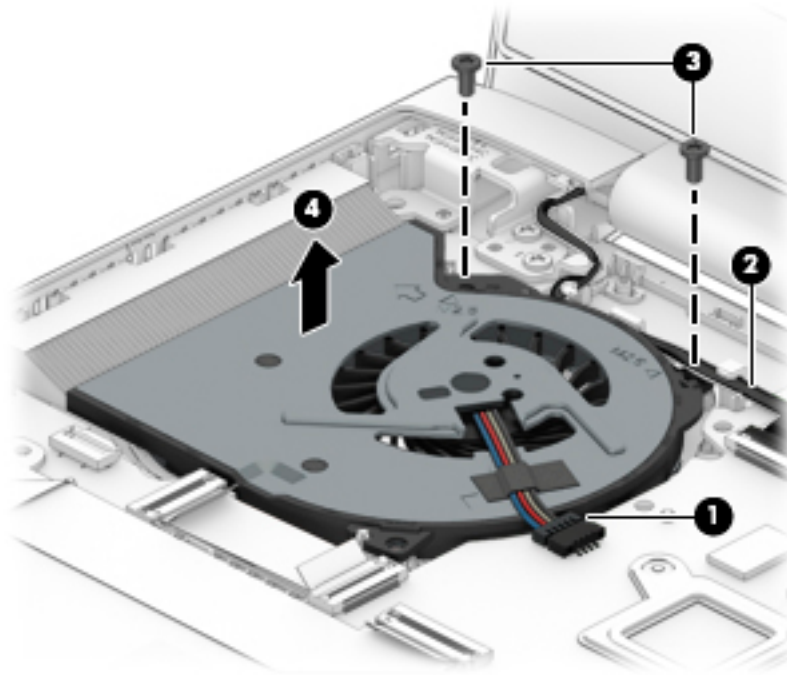

Reverse this procedure to install the fan.

RTC battery

Table 6-8 RTC battery description and part number

Description	Spare part number
RTC battery	746439-001

Before removing the RTC battery, follow these steps:

1. Shut down the computer. If you are unsure whether the computer is off or in Hibernation, turn the computer on, and then shut it down through the operating system.
2. Place the computer in “Battery Safe mode” ([Battery Safe mode on page 27](#)).
3. Disconnect all external devices connected to the computer.
4. Disconnect the power from the computer by first unplugging the power cord from the AC outlet, and then unplugging the AC adapter from the computer.
5. Remove the following components:
 - a. Service doors ([Service doors on page 28](#)).
 - b. Keyboard ([Keyboard on page 35](#))
 - c. Top cover ([Top cover on page 39](#))

Remove the RTC battery:

1. Position the computer upright on a flat surface and open the display as far as possible.
2. Use a tool to pry the battery out of the socket (**1**).
3. Remove the battery from the system board (**2**).

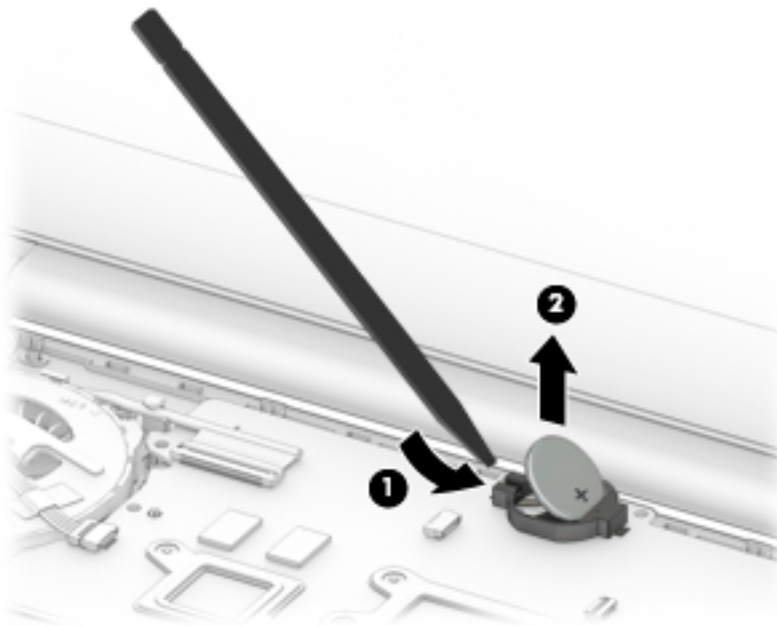

Reverse this procedure to install the RTC battery.

Battery

Table 6-9 Battery description and part number

Description	Spare part number
Battery, 4-cell, 48 WHr, 4.21 Ah	851610-855

Before removing the battery, follow these steps:

1. Shut down the computer. If you are unsure whether the computer is off or in Hibernation, turn the computer on, and then shut it down through the operating system.
2. Place the computer in “Battery Safe mode” ([Battery Safe mode on page 27](#)).
3. Disconnect all external devices connected to the computer.
4. Disconnect the power from the computer by first unplugging the power cord from the AC outlet, and then unplugging the AC adapter from the computer.
5. Remove the following components:
 - a. Service doors ([Service doors on page 28](#)).
 - b. Keyboard ([Keyboard on page 35](#))
 - c. Top cover ([Top cover on page 39](#))
 - d. Card reader board ([Card reader board on page 50](#))

To remove the battery:

1. Position the computer upright on a flat surface and open the display as far as possible.
2. Remove the Torx T8 2.5×5.0 screw **(1)** that secures the battery to the computer.
3. Rotate the bottom of the battery upward **(2)**, and then lift the battery out of the computer **(3)**.

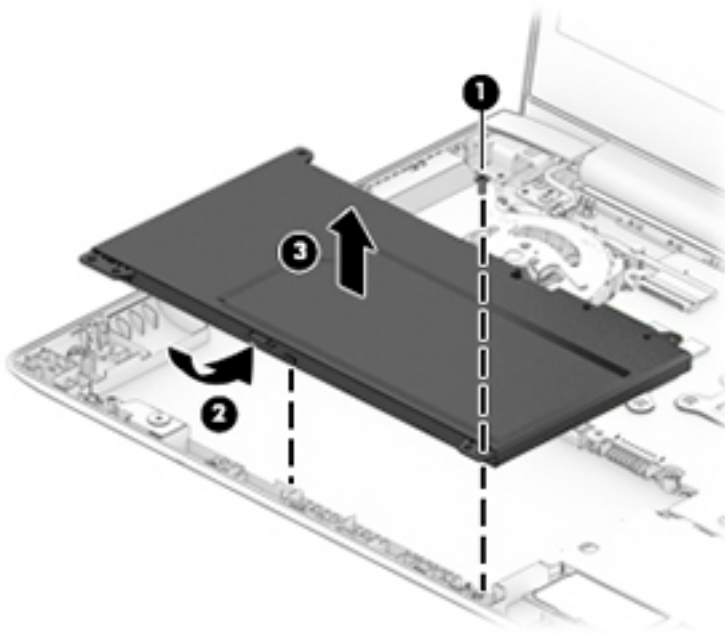

Reverse this procedure to install the battery.

USB board

Table 6-10 USB board description and part number

Description	Spare part number
USB board	L01043-001
USB board cable (included in Cable Kit)	L01082-001

Before removing the USB board, follow these steps:

1. Shut down the computer. If you are unsure whether the computer is off or in Hibernation, turn the computer on, and then shut it down through the operating system.
2. Place the computer in “Battery Safe mode” ([Battery Safe mode on page 27](#)).
3. Disconnect all external devices connected to the computer.
4. Disconnect the power from the computer by first unplugging the power cord from the AC outlet, and then unplugging the AC adapter from the computer.
5. Remove the following components:
 - a. Service doors ([Service doors on page 28](#)).
 - b. Keyboard ([Keyboard on page 35](#))
 - c. Top cover ([Top cover on page 39](#))
 - d. Card reader board ([Card reader board on page 50](#))
 - e. Battery ([Battery on page 54](#))

Remove the USB board:

1. Position the computer upright on a flat surface and open the display as far as possible.
2. Disconnect the cable from the ZIF connector on the USB board **(1)**.
3. Use a tool to pry the side of the board near the fan upward **(2)**, and then pull the board away from the tab that secures it **(3)**.

4. Remove the USB board from the computer (4).

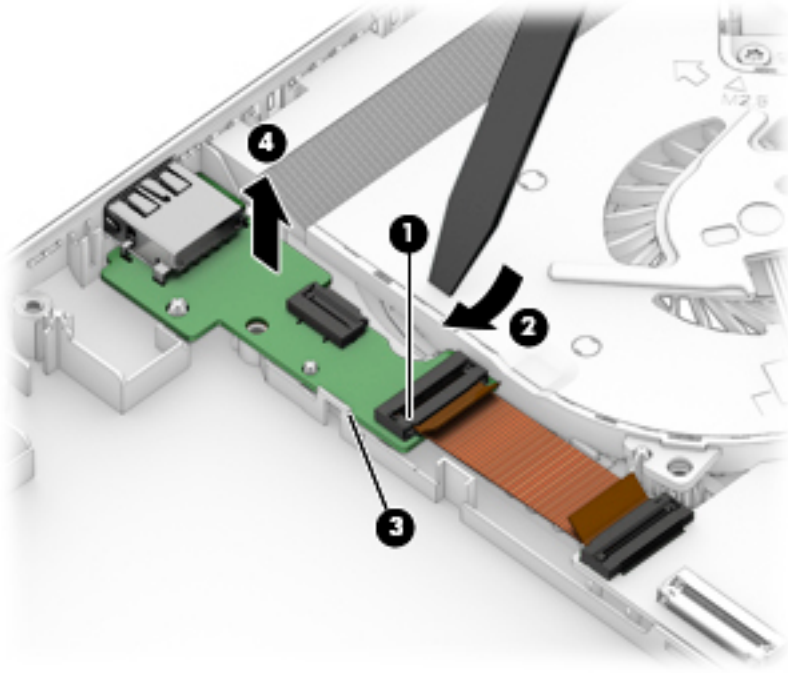

Reverse this procedure to install the USB board.

System board



NOTE: All system board spare part kits include replacement thermal material.

All system boards use the following part numbers:

xxxxxx-001: Non-Windows operating systems

xxxxxx-601: Windows 10 operating system

Table 6-11 System board description and part number

Description	Spare part number
System board with Celeron 3867U processor for use in models with Windows 10 IoT	L68817-001
System board with Celeron 3867U processor for use in models without a Windows operating system	L68817-301

Before removing the system board, follow these steps:

1. Shut down the computer. If you are unsure whether the computer is off or in Hibernation, turn the computer on, and then shut it down through the operating system.
2. Place the computer in “Battery Safe mode” ([Battery Safe mode on page 27](#)).
3. Disconnect all external devices connected to the computer.
4. Disconnect the power from the computer by first unplugging the power cord from the AC outlet, and then unplugging the AC adapter from the computer.
5. Remove the following components:
 - a. Service doors ([Service doors on page 28](#)).
 - b. Keyboard ([Keyboard on page 35](#))
 - c. Top cover ([Top cover on page 39](#))
 - d. Card reader board ([Card reader board on page 50](#))
 - e. Battery ([Battery on page 54](#))

When replacing the system board, be sure to remove the following components (as applicable) from the defective system board and install on the replacement system board:

- Memory modules ([Memory modules on page 30](#))
- WLAN/Bluetooth module ([WLAN/Bluetooth combo card on page 32](#))
- M.2 solid-state drive ([M.2 solid-state drive on page 34](#))

Remove the system board:

1. Position the computer upright on a flat surface and open the display as far as possible.

2. Disconnect the following cables from the system board:

(1): Display cable

(2): Power connector cable

(3): Hard drive connector cable (ZIF)

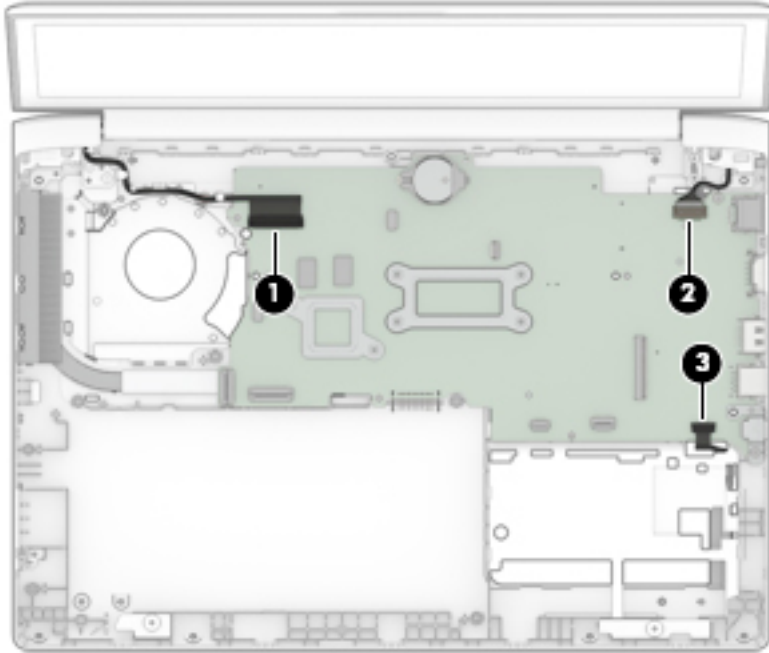

3. Remove the 2 Torx T8 2.5×4.0 screws **(1)** that secure the system board to the computer.
4. Lift the bracket from atop the USB-Type C port **(2)**.
The USB bracket is available using spare part number L01051-001.
5. Rotate the left side of the system board upward **(3)**.

6. Pull the system board away from the connectors on the side of the chassis to remove it from the computer (4).

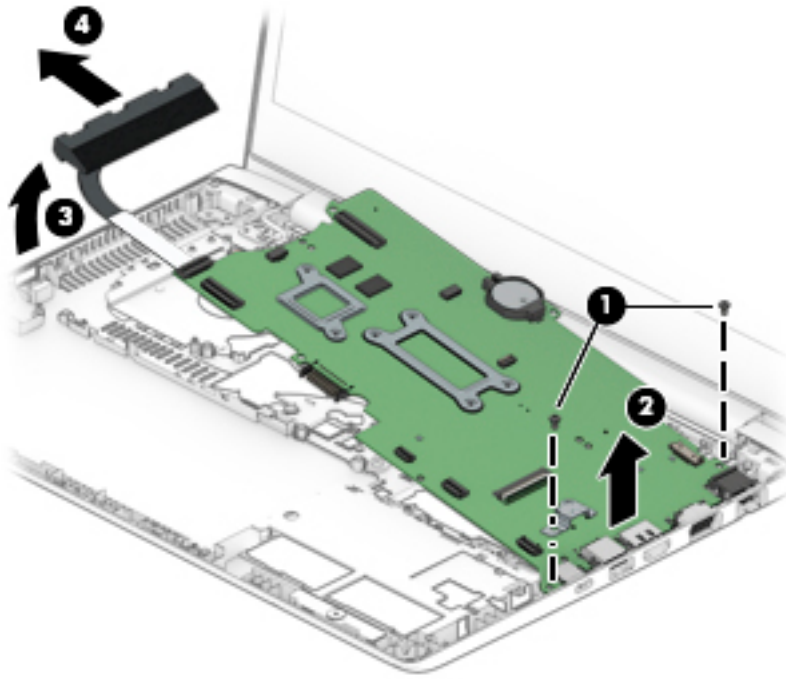

Reverse this procedure to install the system board.

Heat sink assembly

All heat sink assembly spare part kits include replacement thermal material.

Table 6-12 Heat sink assembly description and part number

Description	Spare part number
Heat sink	L01085-001

Before removing the heat sink assembly, follow these steps:

1. Shut down the computer. If you are unsure whether the computer is off or in Hibernation, turn the computer on, and then shut it down through the operating system.
2. Place the computer in “Battery Safe mode” ([Battery Safe mode on page 27](#)).
3. Disconnect all external devices connected to the computer.
4. Disconnect the power from the computer by first unplugging the power cord from the AC outlet, and then unplugging the AC adapter from the computer.
5. Remove the following components:
 - a. Service doors ([Service doors on page 28](#)).
 - b. Keyboard ([Keyboard on page 35](#))
 - c. Top cover ([Top cover on page 39](#))
 - d. Card reader board ([Card reader board on page 50](#))
 - e. Battery ([Battery on page 54](#))
 - f. System board ([System board on page 57](#))

Remove the heat sink assembly:

1. Position the system board upside-down.
2. In the order indicated on the heat sink, loosen the 4 captive Phillips screws **(1)** that secure the heat sink to the system board.

3. Lift the heat sink from the system board (2).

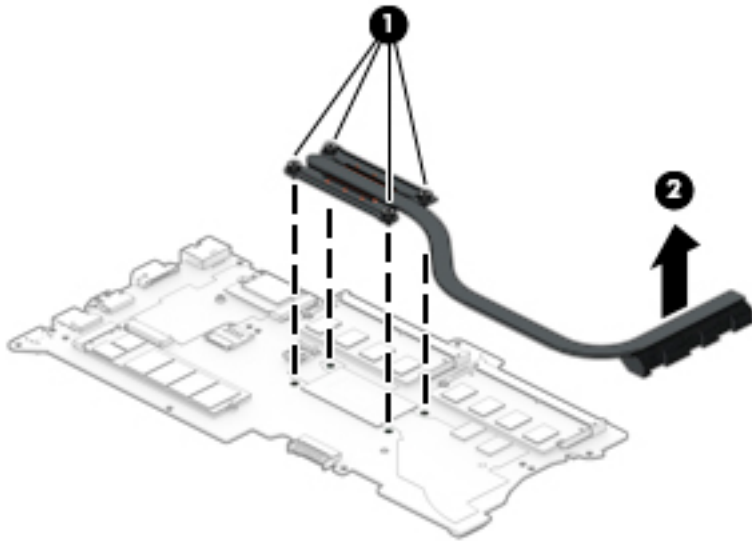

 **NOTE:** Thoroughly clean thermal material from the surfaces of the system board components (1) and the heat sink (2) each time you remove the heat sink. All heat sink and processor spare part kits include thermal material.

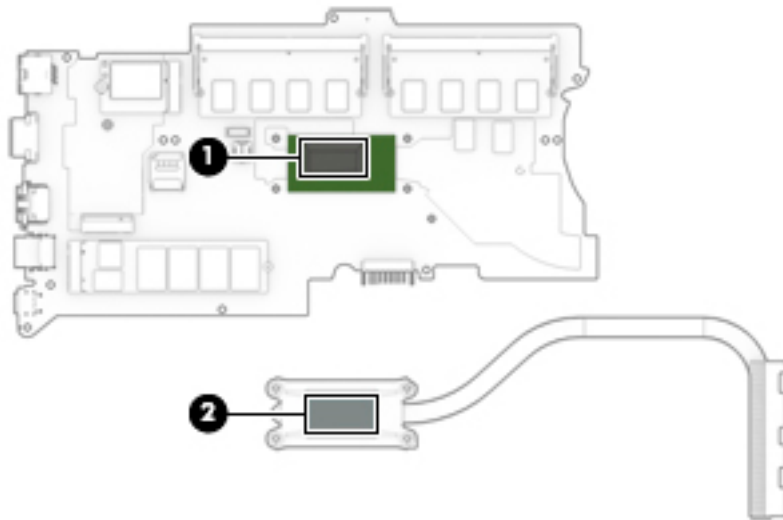

Reverse this procedure to install the heat sink assembly.

Display assembly – non-touch

 **NOTE:** Non-touch displays are spared only at the subcomponent level. Non-touch assemblies are not spared as whole units.

Before disassembling the display assembly, follow these steps:

1. Shut down the computer. If you are unsure whether the computer is off or in Hibernation, turn the computer on, and then shut it down through the operating system.
2. Place the computer in “Battery Safe mode” ([Battery Safe mode on page 27](#)).
3. Disconnect all external devices connected to the computer.
4. Disconnect the power from the computer by first unplugging the power cord from the AC outlet, and then unplugging the AC adapter from the computer.
5. Remove the following components:
 - a. Service doors ([Service doors on page 28](#)).
 - b. Keyboard ([Keyboard on page 35](#))
 - c. Top cover ([Top cover on page 39](#))

Disassemble the display assembly:

1. Position the computer upright on a flat surface and open the display as far as possible.
2. Flex the top **(1)** of the bezel, the inside edges of the left and right sides **(2)**, and then the right side of the bottom **(3)** and the left side of the bottom **(4)** of the bezel until it disengages from the display enclosure.

 **TIP:** The bottom, inside of the bezel is secured to the display enclosure with double-sided adhesive. When removing the bezel, be sure to remove the tape from the bezel so that it remains connected to the display.

3. Remove the display bezel **(5)**.

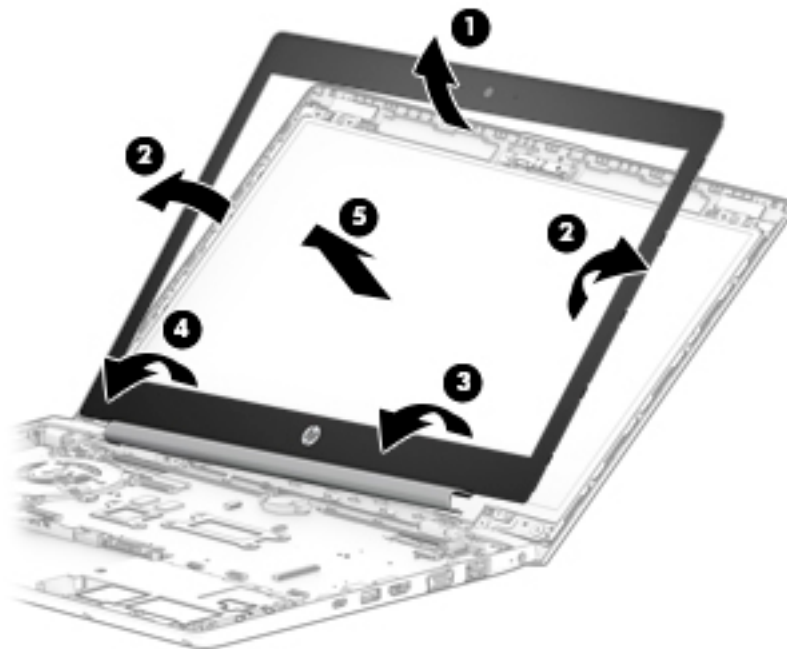

4. If it is necessary to remove or replace the display panel, remove the 4 Phillips M2.0×2.0 screws **(1)** that secure the display panel to the enclosure.
5. Rotate the display panel onto the keyboard **(2)** to gain access to the display cable connector on the back of the panel.

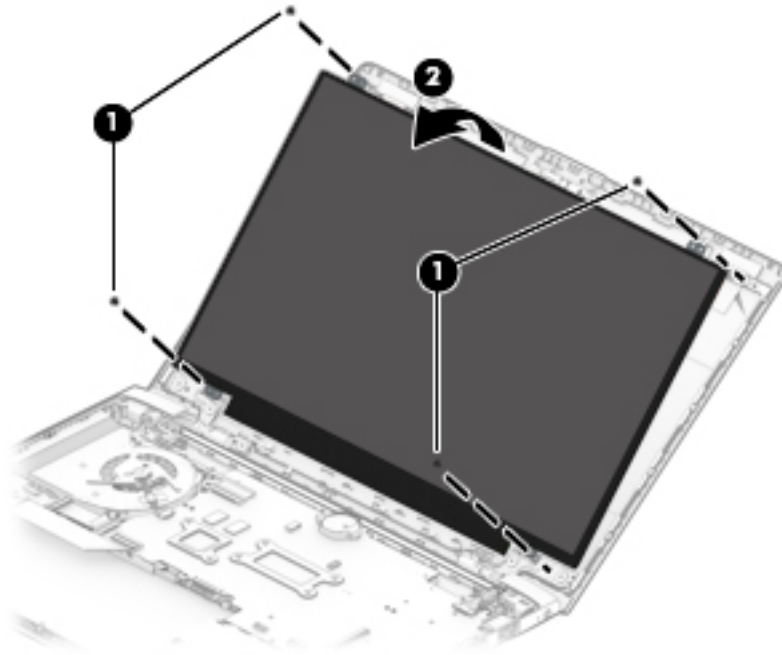

6. Lift the tape from atop the connector on the display panel **(1)**, lift the connector latch **(2)**, and then disconnect the cable from the panel **(3)**.
7. Remove the panel **(4)**.

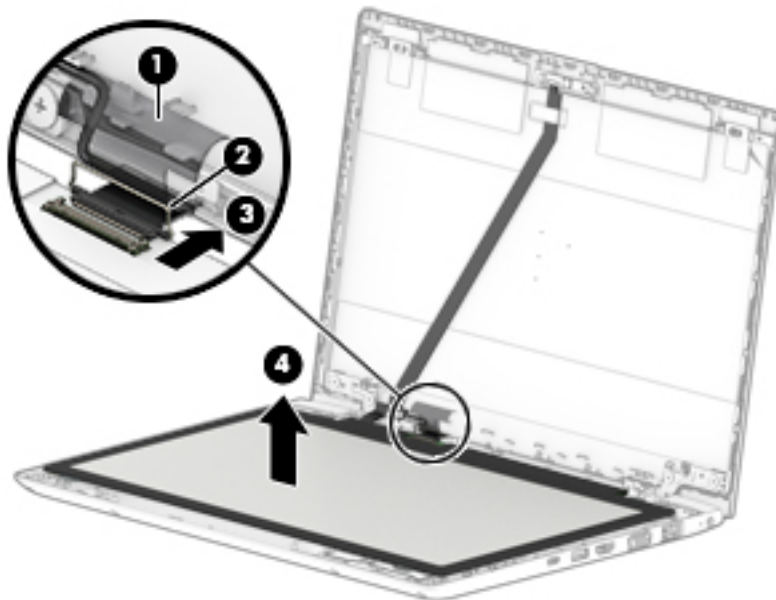

8. To remove the display enclosure, position the computer with the display enclosure lying on a flat surface and the computer upward at a 90 degree angle.
9. Remove the 6 Phillips broad head M2.5×2.5 screws (1) from the bottom of the display hinges and the 2 Phillips M2.0×2.0 screws (2) from the top of the display hinges.
10. Separate the display enclosure from the hinges (3).

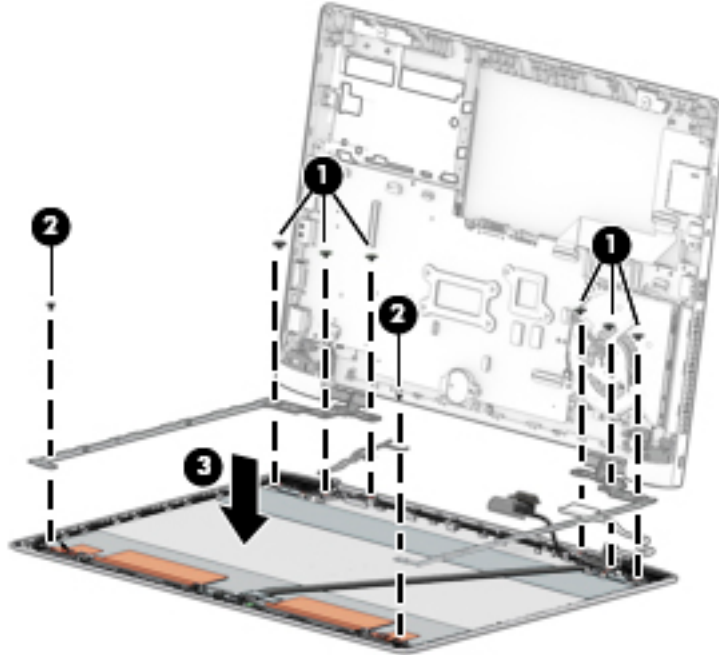

11. To remove the display hinges and brackets, remove the 4 Torx T8 2.5×4.0 screws (1) that secure the hinges to the computer, and then slide the hinges toward each other to remove them (2).

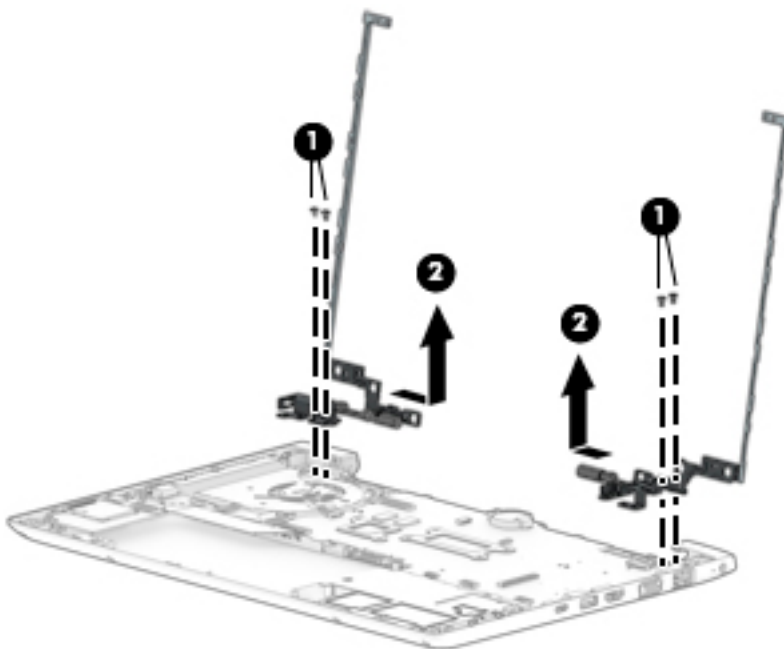

12. If it is necessary to replace the WLAN antennas, peel the antennas from the display enclosure (1), remove the cables from the clips in the sides of the enclosure (2), and then lift the cables and antennas from the enclosure (3).

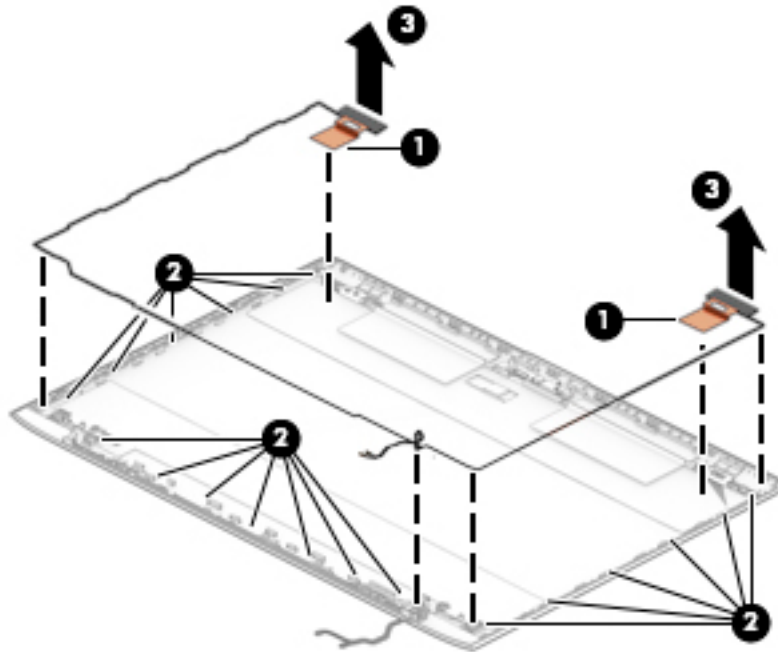

13. If it is necessary to remove or replace the HD camera, disconnect the cable from the camera (1), and then peel the camera module up to remove it from the adhesive that secures it to the enclosure (2).

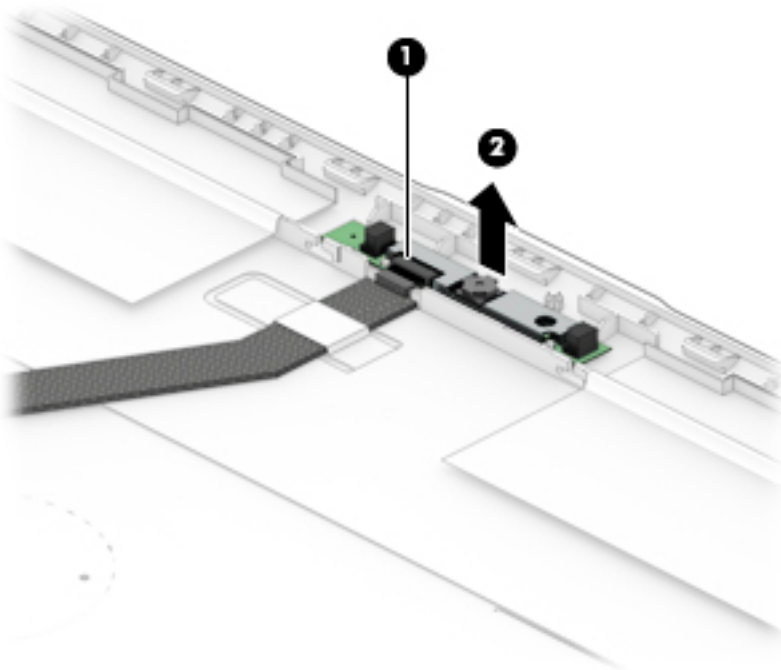

14. If it is necessary to remove or replace the HD display/camera cable, remove the cable from under the tab that secures it to the enclosure (1), and then remove the cable from the display enclosure (2).

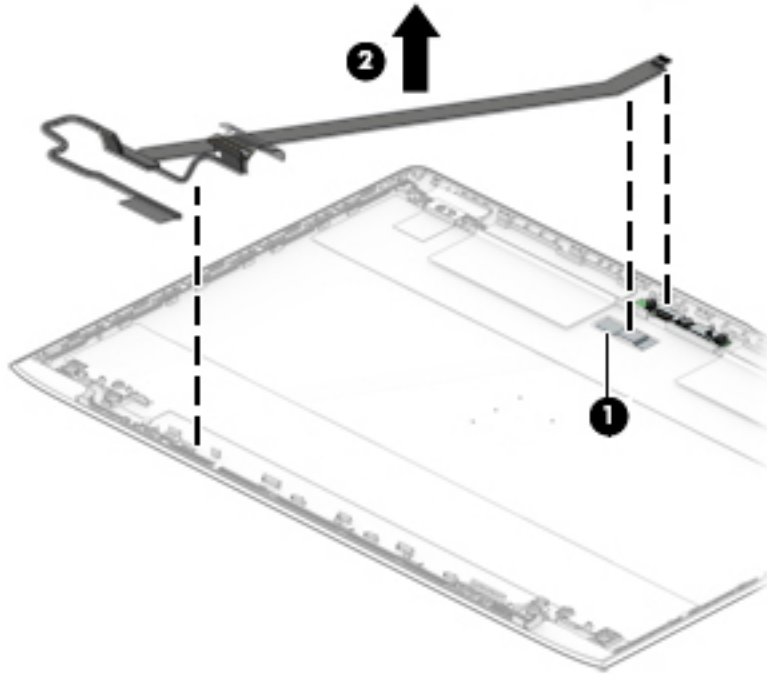

Reverse this procedure to reassemble the touch display assembly.

Power cable

Table 6-13 Power cable description and part number

Description	Spare part number
Power cable	L07857-001

Before removing the power cable, follow these steps:

1. Shut down the computer. If you are unsure whether the computer is off or in Hibernation, turn the computer on, and then shut it down through the operating system.
2. Place the computer in “Battery Safe mode” ([Battery Safe mode on page 27](#)).
3. Disconnect all external devices connected to the computer.
4. Disconnect the power from the computer by first unplugging the power cord from the AC outlet, and then unplugging the AC adapter from the computer.
5. Remove the following components:
 - a. Service door ([Service doors on page 28](#)).
 - b. Keyboard ([Keyboard on page 35](#))
 - c. Top cover ([Top cover on page 39](#))
 - d. Card reader board ([Card reader board on page 50](#))
 - e. Battery ([Battery on page 54](#))
 - f. Display assembly right hinge ([Display assembly – non-touch on page 62](#))

Remove the power cable:

1. Disconnect the cable from the system board (1).
2. Remove the power cable from the computer (2).

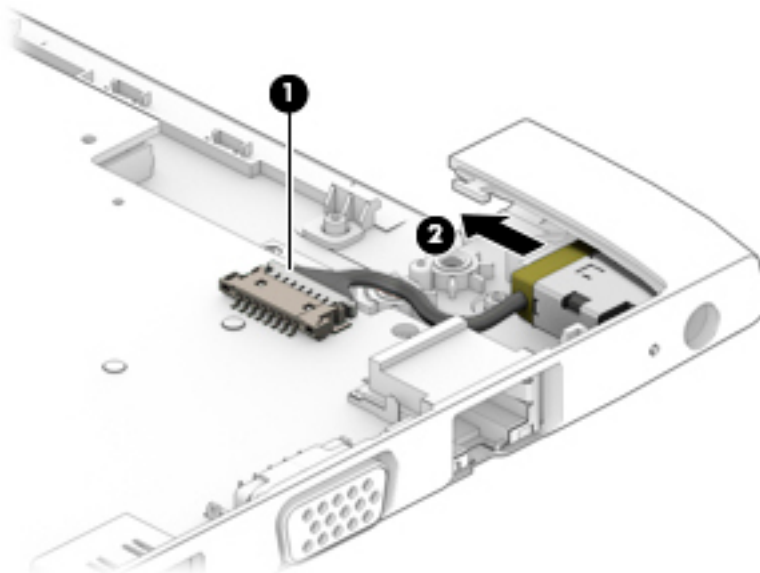

Reverse this procedure to install the power cable.

7 Interpreting system validation diagnostic front panel LEDs and audible codes

During the system validation phase that occurs at system startup, the BIOS validates the functionality of the following subsystems and conditions:

- AC adapter
- System board power
- Processor failure
- BIOS corruption
- Memory failure
- Graphics failure
- System board failure
- BIOS authentication failure

If an error is detected, specific patterns of long and short blinks, accompanied by long and short beeps (where applicable) are used to identify the error. These patterns will make up a two part code:

- Major – the category of the error
- Minor – the specific error within the category

 **NOTE:** Single beep/blink codes are not used.

Table 7-1 Interpreting system validation diagnostic front panel LEDs and audible codes

Number of long beeps/blinks	Error category
1	Not used
2	BIOS
3	Hardware
4	Thermal
5	System board

Patterns of blink/beep codes are determined by using the following parameters:

- 1 second pause occurs after the last major blink.
- 2 second pause occurs after the last minor blink.
- Beep error code sequences occur for the first 5 iterations of the pattern and then stop.
- Blink error code sequences continue until the computer is unplugged or the power button is pressed.

 **NOTE:** Not all diagnostic lights and audible codes are available on all models.

The red LED blinks to represent the major error category (long blinks). The white LED blinks to represent the minor error category (short blinks). For example, '3.5' indicates 3 long red blinks and 5 short white blinks to communicate the processor is not detected.

Table 7-2 Interpreting system validation diagnostic front panel LEDs and audible codes

Component tested	Major/minor code	Error condition	Notebook Caps Lock/Num Lock LED	Desktop	Action
BIOS	2.2	The main area (DXE) of BIOS has become corrupted and there is no recovery binary image available	CAP/NUM Blink = 2	2.2 - Power LED (red.white)	Follow the Crisis Recovery instructions at http://support.hp.com/us-en/document/c02693833/ .
	2.3	The embedded controller policy requires the user to enter a key sequence (SureStart 2.0)	CAP/NUM Blink = 8	2.3 - Power LED (red.white)	If analysis of the event that caused Sure Start recovery is desired, replace the board and send the bad board back. Otherwise, press this key combination to restore BIOS and boot: Up Arrow+ Down Arrow+ Esc.
	2.4	The embedded controller is recovering the boot block or DXE. Since it takes 10 sec. or so to load the DXE image and get video in the DXE case, this blink code is necessary. (SureStart)	Battery LED White and Amber blinking	2.4 - Power LED (red.white)	Wait for DXE recovery to complete.
Hardware	3.2	The embedded controller has timed out waiting for BIOS to return from memory initialization	CAP/NUM Blink = 3	3.2 - Power LED (red.white)	System board replacement.
	3.3	The embedded controller has timed out waiting for BIOS to return from graphics initialization (4/13- Graphics adaptor not found)	CAP/NUM Blink = 4	3.3 - Power LED (red.white)	If the system has an MXM module, try a different MXM module. Otherwise, the board most likely needs to be replaced.
	3.4	The system board displays a power failure (crowbar) *	CAP/NUM Blink = 5	3.4 - Power LED (red.white)	System board replacement.
System board	5.2	The embedded controller cannot find valid firmware	CAP/NUM Blink = 7 (2 BB failure) Battery LED Blinking = 1 Hz (3 B failure)	5.2 - Power LED (red.white)	System board replacement.
	5.3	The embedded controller has timed out waiting for the BIOS	CAP/NUM Blink = 1	Not implemented	System board replacement.

8 Diagnostics and troubleshooting

LEDs

Table 8-1 Power and IDE Flash Activity LEDs

LED	Status
Power LED Off	When the unit is plugged into the wall socket and the Power LED is off, the unit is powered off. However, the network can trigger a Wake On LAN event in order to perform management functions.
Power LED On	Displays during boot sequence and while the unit is on. During boot sequence, hardware initialization is processed and startup tests are performed on the following: <ul style="list-style-type: none">• Processor initialization• Memory detection and initialization• Video detection and initialization <p>NOTE: If one of the tests fails, the unit will simply stop, but the LED will stay on. If the video test fails, the unit beeps. There are no messages sent to video for any of these failed tests.</p> <p>NOTE: After the video subsystem is initialized, anything that fails will have an error message.</p>
<p>NOTE: RJ-45 LEDs are located inside the RJ-45 connector on the top, rear panel of the thin client. The LEDs are visible when the connector is installed. Blinking green indicates network activity, and amber indicates a 100MB speed connection.</p>	
IDE LED is Off	When the unit is powered on and the flash activity light is off, then there is no access to the system flash.
IDE LED blinks white	Indicates the system is accessing the internal IDE flash.

Wake-on LAN

Wake-on LAN (WOL) allows a computer to be turned on or resumed from sleep state by a network message. You can enable or disable WOL in Computer Setup using the **S5 Maximum Power Savings** setting.

To enable or disable WOL:

1. Turn on or restart the computer.
2. Press either **esc** or **F10** while the “Press the ESC key for Startup Menu” message is displayed at the bottom of the screen.



NOTE: If you do not press **esc** or **F10** at the appropriate time, you must restart the computer and again press **esc** or **F10** when the monitor light turns green to access the utility.

3. If you pressed **esc**, press **F10** to enter Computer Setup.
4. Navigate to **Power > Hardware Power Management**.
5. Set **S5 Maximum Power Savings** as follows:
 - Disable WOL = Enabled
 - Enable WOL = Disabled
6. Press **F10** to accept any changes.
7. Select **File > Save Changes and Exit**.

Power-On Sequence

At power-on, the flash boot block code initializes the hardware to a known state, then performs basic power-on diagnostic tests to determine the integrity of the hardware. Initialization performs the following functions:

1. Initializes CPU and memory controller.
2. Initializes and configures all PCI devices.
3. Initializes video software.
4. Initializes the video to a known state.
5. Initializes USB devices to a known state.
6. Performs power-on diagnostics. For more information, see “Power-On Diagnostic Tests”.
7. The unit boots the operating system.

Resetting the Setup and Power-on passwords

You can reset the Setup and Power-on passwords as follows:

1. Turn off the computer and disconnect the power cord from the power outlet.
2. Remove the side access panel and the metal side cover.
3. Remove the password jumper from the system board header labeled PSWD/E49.
4. Replace the metal side cover and the side access panel.
5. Connect the computer to AC power, and then turn on the computer.
6. Turn off the computer and disconnect the power cord from the power outlet.
7. Remove the side access panel and the metal side cover.
8. Replace the password jumper.
9. Replace the metal side cover and the side access panel.

Power-on diagnostic tests

The Power-on diagnostics performs basic integrity tests of the hardware to determine its functionality and configuration. If a diagnostic test fails during hardware initialization the unit simply stops. There are no messages sent to video.



NOTE: You may try to restart the unit and run through the diagnostic tests a second time to confirm the first shutdown.

The following table lists the tests that are performed on the unit.

Table 8-2 Power-on diagnostic test

Test	Description
Boot Block Checksum	Tests boot block code for proper checksum value
DRAM	Simple write/read pattern test of the first 640k of memory
Serial Port	Tests the serial port using simple port verification test to determine if ports are present
Timer	Tests timer interrupt by using polling method
RTC CMOS battery	Tests integrity of RTC CMOS battery
NAND flash device	Tests for proper NAND flash device ID present

Interpreting POST diagnostic front panel LEDs and audible codes

This section covers the front panel LED codes as well as the audible codes that may occur before or during POST that do not necessarily have an error code or text message associated with them.

 **WARNING!** When the computer is plugged into an AC power source, voltage is always applied to the system board. To reduce the risk of personal injury from electrical shock and/or hot surfaces, be sure to disconnect the power cord from the wall outlet and allow the internal system components to cool before touching.

 **NOTE:** Recommended actions in the following table are listed in the order in which they should be performed.

Not all diagnostic lights and audible codes are available on all models.

Table 8-3 Diagnostic front panel LEDs and audible codes

Activity	Beeps	Possible Cause	Recommended Action
White Power LED On.	None	Computer on.	None
White Power LED flashes every two seconds.	None	Computer in Suspend to RAM mode (some models only) or normal Suspend mode.	No action required. Press any key or move the mouse to wake the computer.
Red Power LED flashes two times, once every second, followed by a two second pause. Beeps stop after fifth iteration but LEDs continue until problem is solved.	2	Processor thermal protection activated: A fan may be blocked or not turning. OR The heat sink/fan assembly is not properly attached to the processor. OR The unit has vents blocked or is in a location where the ambient temperature is too high.	<ol style="list-style-type: none"> 1. Ensure that the computer air vents are not blocked and the processor cooling fan is plugged in and running, if equipped. 2. Contact an authorized reseller or service provider.
Red Power LED flashes four times, once every second, followed by a two second pause. Beeps stop after fifth iteration but LEDs continue until problem is solved.	4	Power failure (power supply is overloaded). OR The incorrect external power supply adapter is being used on the unit.	<ol style="list-style-type: none"> 1. Check if a device is causing the problem by removing ALL attached devices. Power on the system. If the system enters the POST, then power off and replace one device at a time and repeat this procedure until failure occurs. Replace the device that is causing the failure. Continue adding devices one at a time to ensure all devices are functioning properly. 2. Replace the power supply. 3. Replace the system board.
Red Power LED flashes five times, once every second, followed by a two second pause. Beeps stop after fifth iteration but LEDs continue until problem is solved.	5	Pre-video memory error.	<p>CAUTION: To avoid damage to the memory modules or the system board, you must unplug the computer power cord before attempting to reseat, install, or remove a memory module.</p> <ol style="list-style-type: none"> 1. Reseat memory modules. 2. Replace memory modules one at a time to isolate the faulty module.

Table 8-3 Diagnostic front panel LEDs and audible codes (continued)

Activity	Beeps	Possible Cause	Recommended Action
			<ol style="list-style-type: none">3. Replace third-party memory with HP memory.4. Replace the system board.
Red Power LED flashes six times, once every second, followed by a two second pause. Beeps stop after fifth iteration but LEDs continue until problem is solved.	6	Pre-video graphics error.	For systems with a graphics card: <ol style="list-style-type: none">1. Reseat the graphics card.2. Replace the graphics card.3. Replace the system board. For systems with integrated graphics, replace the system board.
Red Power LED flashes eight times, once every second, followed by a two second pause. Beeps stop after fifth iteration but LEDs continue until problem is solved.	8	Invalid ROM based on bad checksum.	<ol style="list-style-type: none">1. Reflash the system ROM with the latest BIOS image using the BIOS Recovery procedure.2. Replace the system board.
System does not power on and LEDs are not flashing.	None	System unable to power on.	Press and hold the power button for less than four seconds. If the solid-state drive LED turns white, the power button is working correctly. Try the following: <ol style="list-style-type: none">1. Remove the power cord from the computer.2. Open the computer and press the yellow CMOS button on the system board for four seconds (located near the front USB ports).3. Verify that the AC cord is plugged into the power supply.4. Close the unit and reattach the power cord.5. Try to power on the computer.6. Replace the unit.

POST numeric codes and text messages

This section covers those POST errors that have numeric codes associated with them. The section also includes some text messages that may be encountered during POST.



NOTE: The computer will beep once after a POST text message is displayed on the screen.

Table 8-4 Numeric Codes and Text Messages

Control panel message	Description	Recommended action
103-System Board Failure	DMA or timers.	<ol style="list-style-type: none">1. Clear CMOS.2. Remove expansion boards.3. Replace the system board.
110-Out of Memory Space for Option ROMs	Recently added PCI expansion card contains an option ROM too large to download during POST.	<ol style="list-style-type: none">1. If a PCI expansion card was recently added, remove it to see if the problem remains.2. In Computer Setup, set Advanced > Device Options > NIC PXE Option ROM Download to DISABLE to prevent PXE option ROM for the internal NIC from being downloaded during POST to free more memory for an expansion card's option ROM. Internal PXE option ROM is used for booting from the NIC to a PXE server.
161-Real-Time Clock Power Loss	Invalid time or date in configuration memory. RTC (real-time clock) battery may need to be replaced.	Reset the date and time under Control Panel (Computer Setup can also be used). If the problem persists, replace the RTC battery. See the Removal and Replacement section for instructions on installing a new battery, or contact an authorized dealer or reseller for RTC battery replacement.
164-MemorySize Error	Memory amount has changed since the last boot (memory added or removed).	Press the F1 key to save the memory changes.
201-Memory Error	RAM failure.	<ol style="list-style-type: none">1. Ensure memory modules are correctly installed.2. Verify proper memory module type.3. Remove and replace the identified faulty memory module(s).4. If the error persists after replacing memory modules, replace the system board.
214-DIMM Configuration Warning	Populated DIMM Configuration is not optimized.	Rearrange the DIMMs so that each channel has the same amount of memory.
301-Keyboard Error	Keyboard failure.	<ol style="list-style-type: none">1. Reconnect keyboard with computer turned off.2. Check connector for bent or missing pins.3. Ensure that none of the keys are depressed.4. Replace keyboard.
510-Flash Screen Image Corrupted	Flash Screen image has errors.	Reflash the system ROM with the latest BIOS image.

Table 8-4 Numeric Codes and Text Messages (continued)

Control panel message	Description	Recommended action
512-Chassis, Rear Chassis, or Front Chassis Fan not Detected	Chassis, rear chassis, or front chassis fan is not connected or may have malfunctioned.	<ol style="list-style-type: none">1. Reseat chassis, rear chassis, or front chassis fan.2. Reseat fan cable.3. Replace chassis, rear chassis, or front chassis fan.
513-Front Chassis fan not detected	Front chassis fan is not connected or may have malfunctioned.	<ol style="list-style-type: none">1. Reseat front chassis fan.2. Reseat fan cable.3. Replace front chassis fan.
912-Computer Cover Has Been Removed Since Last System Startup	Computer cover was removed since last system startup.	No action required.
921-Device in PCI Express slot failed to initialize	There is an incompatibility/problem with this device and the system or PCI Express Link could not be retrained to an x1.	Try rebooting the system. If the error reoccurs, the device may not work with this system
1720-SMART Hard Drive Detects Imminent Failure	Hard drive is about to fail. (Some hard drives have a hard drive firmware patch that will fix an erroneous error message.)	<ol style="list-style-type: none">1. Determine if hard drive is giving correct error message. Run the Drive Protection System test using F2 Diagnostics.2. Apply hard drive firmware patch if applicable. (Available at http://www.hp.com/support.)3. Back up contents and replace hard drive.
Invalid Electronic Serial Number	Electronic serial number is missing.	Enter the correct serial number in Computer Setup.
Network Server Mode Active and No Keyboard Attached	Keyboard failure while Network Server Mode enabled.	<ol style="list-style-type: none">1. Reconnect keyboard with computer turned off.2. Check connector for bent or missing pins.3. Ensure that none of the keys are depressed.4. Replace keyboard.
Parity Check 2	Parity RAM failure.	Run Computer Setup and Diagnostic utilities.

Troubleshooting

Basic troubleshooting

If the thin client is experiencing operating problems or will not power on, review the following items.

Table 8-5 Power-on troubleshooting

Issue	Procedures
The thin client unit is experiencing operating problems.	Ensure that the following connectors are securely plugged into the thin client unit: Power connector, keyboard, mouse, network RJ-45 connector, display
The thin client unit does not power on.	<ol style="list-style-type: none">1. Verify that the power supply is good by installing it on a known working unit and testing it. If the power supply does not work on the test unit, replace the power supply.2. If the unit does not work properly with the replaced power supply, have the unit serviced.
The thin client unit powers on and displays a splash screen, but does not connect to the server.	<ol style="list-style-type: none">1. Verify that the network is operating and the network cable is working properly.2. Verify that the unit is communicating with the server by having the System Administrator ping the unit from the server:<ul style="list-style-type: none">– If the thin client pings back, then the signal was accepted and the unit is working. This indicates a configuration issue.– If the thin client does not ping back and the thin client does not connect to the server, re-image the unit.
No link or activity on the network RJ-45 LEDs or the LEDs do not illuminate blinking green after powering on the thin client unit. (The network LEDs are located inside the RJ-45 connector on the top, rear panel of the thin client. Indicator lights are visible when the connector is installed.)	<ol style="list-style-type: none">1. Verify that the network is not down.2. Make sure the RJ-45 cable is good by installing the RJ-45 cable onto a known working device—if a network signal is detected then the cable is good.3. Verify the power supply is good by replacing the power cable to the unit with a known working power supply cable and testing it.4. If network LEDs still do not light and you know the power supply is good, then re-image the unit.5. If network LEDs still do not light, run the IP configuration procedure.6. If network LEDs still do not light, have the unit serviced.
A newly connected unknown USB peripheral does not respond or USB peripherals connected prior to the newly connected USB peripheral will not complete their device actions.	An unknown USB peripheral may be connected and disconnected to a running platform as long as you do not reboot the system. If problems occur, disconnect the unknown USB peripheral and reboot the platform.
Video does not display.	<ol style="list-style-type: none">1. Verify that the monitor brightness is set to a readable level.2. Verify the monitor is good by connecting it to a known working computer and ensure its front LED turns green (assuming the monitor is Energy Star compliant). If the monitor is defective, replace it with a working monitor and repeat testing.3. Re-image the thin client unit and power on the monitor again.4. Test the thin client unit on a known working monitor. If the monitor does not display video, replace the thin client unit.

Diskless (No-Flash) unit troubleshooting

This section is only for those units that do not have ATA Flash capability. Because there is no ATA Flash in this model the boot priority sequence is:

- USB device
 - PXE
1. When the unit boots, the monitor should display the following information:

Table 8-6 Diskless unit troubleshooting

Item	Information	Action
MAC Address	NIC portion of the system board is OK	If no MAC Address, the system board is at fault. Contact the Call Center for service.
GUID	General system board information	If no GUID information, the system board is at fault and should be replaced.
Client ID	Information from server	If no Client ID information there is no network connection. This may be caused by a bad cable, the server is down, or a bad system board. Contact the Call Center for service for the bad system board.
MASK	Information from server	If no MASK information there is no network connection. This may be caused by a bad cable, the server is down, or a bad system board. Contact the Call Center for service for the bad system board.
DHCP IP	Information from server	If no DHCP IP information there is no network connection. This may be caused by a bad cable, the server is down, or a bad system board. Contact the Call Center for service for the bad system board.

If you are running in a Microsoft RIS PXE environment, go to step 2.

If you are running in a Linux environment, go to step 3.

2. If you are running in a Microsoft RIS PXE environment, press the **F12** key to activate the network service boot as soon as the DHCP IP information appears on the screen.

If the unit does not boot to the network, the server is not configured to PXE.

If you missed the F12 cue, the system will try to boot to the ATA flash that is not present. The message on the screen will read: **ERROR: Non-system disk or disk error. Replace and press any key when ready.**

Pressing any key will restart the boot cycle.

3. If you are running in a Linux environment, an error message will appear on the screen if there is no Client IP. **ERROR: Non-system disk or disk error. Replace and press any key when ready.**

Configuring a PXE server

 **NOTE:** All PXE software is supported by authorized service providers on a warranty or service contract basis. Customers who call the HP Customer Service Center with PXE issues and questions should be referred to their PXE provider for assistance.

Additionally, refer to the following:

– For Windows Server 2008 R2: <http://technet.microsoft.com/en-us/library/7d837d88-6d8e-420c-b68f-a5b4baeb5248.aspx>

– For Windows Server 2012: <http://technet.microsoft.com/en-us/library/jj648426.aspx>

The services listed below must be running, and they may be running on different servers:

1. Domain Name Service (DNS)
2. Remote Installation Services (RIS)

 **NOTE:** Active Directory DHCP is not required, but is recommended.

9 Using HP ThinUpdate to restore the image

HP ThinUpdate software is installed on Thin Client computers (select products only) to provide backup and recovery. If it is not installed on your computer, you can download it from <http://www.hp.com/support> (search for the Thin Client model and click on the **Drivers & software** section of the support page for that model. For information on using this software, refer to the Manuals section).

 **NOTE:** HP recommends periodically going to the website to check for application updates.

Use HP ThinUpdate software for the following processes:

- Creating recovery media and backups
- Restoring and recovering your system
- Installing and updating software

HP ThinUpdate allows you to download images and add-ons from HP, capture an HP thin client image, and create bootable USB flash drives for image deployment.

- The Image Downloads feature lets you download an image from HP to either local storage or a USB flash drive. The USB flash drive option creates a bootable USB flash drive that can be used to deploy the image to other thin clients.
- The Image Capture feature lets you capture an image from an HP thin client and save it to a USB flash drive, which can be used to deploy the image to other thin clients.
- The Add-on Downloads feature lets you download add-ons from HP to either local storage or a USB flash drive.
- The USB Drive Management feature lets you do the following:
 - Create a bootable USB flash drive from an image file on local storage
 - Copy an .ibr image file from a USB flash drive to local storage
 - Restore a USB flash drive layout

You can use a bootable USB flash drive created with HP ThinUpdate to deploy an HP thin client image to another HP thin client of the same model with the same operating system.

System requirements

To create a recovery device for the purpose of reflashing or restoring the software image on the flash, you will need the following:

- One or more HP thin clients.
- USB flash device in the following size or larger:
 - Windows 10 IoT (if using the USB format): 32 GB

 **NOTE:** Optionally, you can use the tool on a Windows computer.

This restore method will not work with all USB flash devices. USB flash devices that do not show up as removable drive in Windows do not support this restore method. USB flash devices with multiple partitions generally do not support this restore method. The range of USB flash devices available on the market is constantly changing. Not all USB flash devices have been tested with the HP Thin Client Imaging Tool.

10 Device management

The thin client includes a license for HP Device Manager and has a Device Manager agent pre-installed. HP Device Manager is a thin client optimized management tool used to manage the full life cycle of HP thin clients to include Discover, Asset Management, Deployment and Configuration. For more information on HP Device Manager, please visit www.hp.com/go/hpdm.

If you wish to manage the thin client with other management tools such as Microsoft SCCM or LANDesk, go to www.hp.com/go/clientmanagement for more information.

11 Computer Setup (BIOS), TPM, and HP Sure Start

Using Computer Setup

Computer Setup, or Basic Input/Output System (BIOS), controls communication between all the input and output devices on the system (such as disk drives, display, keyboard, mouse, and printer). Computer Setup includes settings for the types of devices installed, the startup sequence of the computer, and the amount of system and extended memory.

 **NOTE:** Use extreme care when making changes in Computer Setup. Errors can prevent the computer from operating properly.

Starting Computer Setup

 **NOTE:** An external keyboard or mouse connected to a USB port can be used with Computer Setup only if USB legacy support is enabled.

- ▲ Turn on or restart the computer, and when the HP logo appears, press **f10** to enter Computer Setup.

Navigating and selecting in Computer Setup

- To select a menu or a menu item, use the **tab** key and the keyboard arrow keys and then press **enter**, or use a pointing device to select the item.
- To scroll up and down, select the up arrow or the down arrow in the upper-right corner of the screen, or use the up arrow key or the down arrow key on the keyboard.
- To close open dialog boxes and return to the main Computer Setup screen, press **esc**, and then follow the on-screen instructions.

To exit Computer Setup menus, choose one of the following methods:

- To exit Computer Setup menus without saving your changes:
Select the **Exit** icon in the lower-right corner of the screen, and then follow the on-screen instructions.
– or –
Select **Main**, select **Ignore Changes and Exit**, and then press **enter**.
- To save your changes and exit Computer Setup menus:
Select the **Save** icon in the lower-right corner of the screen, and then follow the on-screen instructions.
– or –
Select **Main**, select **Save Changes and Exit**, and then press **enter**.

Your changes go into effect when the computer restarts.

Restoring factory settings in Computer Setup

 **NOTE:** Restoring defaults will not change the hard drive mode.

To return all settings in Computer Setup to the values that were set at the factory, follow these steps:

1. Start Computer Setup. See [Starting Computer Setup on page 82](#).
2. Select **Main**, and then select **Apply Factory Defaults and Exit**.



NOTE: On select products, the selections may display **Restore Defaults** instead of **Apply Factory Defaults and Exit**.

3. Follow the on-screen instructions.
4. To save your changes and exit, select the **Save** icon in the lower-right corner of the screen, and then follow the on-screen instructions.

– or –

Select **Main**, select **Save Changes and Exit**, and then press [enter](#).

Your changes go into effect when the computer restarts.



NOTE: Your password settings and security settings are not changed when you restore the factory settings.

Updating the BIOS

Updated versions of the BIOS may be available on the HP website.

Most BIOS updates on the HP website are packaged in compressed files called *SoftPaqs*.

Some download packages contain a file named Readme.txt, which contains information regarding installing and troubleshooting the file.

Determining the BIOS version

To decide whether you need to update Computer Setup (BIOS), first determine the BIOS version on your computer.

BIOS version information (also known as *ROM date* and *System BIOS*) can be accessed by pressing [fn+esc](#) (if you are already in Windows) or by using Computer Setup.

1. Start Computer Setup. See [Starting Computer Setup on page 82](#).
2. Select **Main**, and then select **System Information**.
3. To exit Computer Setup without saving your changes, select the **Exit** icon in the lower-right corner of the screen, and then follow the on-screen instructions.

– or –

Select **Main**, select **Ignore Changes and Exit**, and then press [enter](#).

To check for later BIOS versions, see [Downloading a BIOS update on page 84](#).

Downloading a BIOS update

 **CAUTION:** To reduce the risk of damage to the computer or an unsuccessful installation, download and install a BIOS update only when the computer is connected to reliable external power using the AC adapter. Do not download or install a BIOS update while the computer is running on battery power, docked in an optional docking device, or connected to an optional power source. During the download and installation, follow these instructions:

Do not disconnect power on the computer by unplugging the power cord from the AC outlet.

Do not shut down the computer or initiate Sleep.

Do not insert, remove, connect, or disconnect any device, cable, or cord.

1. To access HP Support, go to <http://www.hp.com/support>, and select your country. Select **Drivers & Downloads**, and then follow the on-screen instructions to access BIOS downloads.
2. At the BIOS download area, follow these steps:
 - a. Identify the most recent BIOS update and compare it to the BIOS version currently installed on your computer. Make a note of the date, name, or other identifier. You may need this information to locate the update later, after it has been downloaded to your hard drive.
 - b. Follow the on-screen instructions to download your selection to the hard drive.
Make a note of the path to the location on your hard drive where the BIOS update is downloaded. You will need to access this path when you are ready to install the update.

 **NOTE:** If you connect your computer to a network, consult the network administrator before installing any software updates, especially system BIOS updates.

BIOS installation procedures vary. Follow any instructions that are revealed on the screen after the download is complete. If no instructions are revealed, follow these steps:

1. Type `file` in the taskbar search box, and then select **File Explorer**.
2. Select your hard drive designation. The hard drive designation is typically Local Disk (C:).
3. Using the hard drive path you recorded earlier, open the folder that contains the update.
4. Double-click the file that has an `.exe` extension (for example, `filename.exe`).
The BIOS installation begins.
5. Complete the installation by following the on-screen instructions.

 **NOTE:** After a message on the screen reports a successful installation, you can delete the downloaded file from your hard drive.

Changing the boot order using the f9 prompt

To dynamically choose a boot device for the current startup sequence, follow these steps:

1. Access the Boot Device Options menu:
 - Turn on or restart the computer, and when the HP logo appears, press **f9** to enter the Boot Device Options menu.
2. Select a boot device, then press **enter**.

TPM BIOS settings (select products only)

 **IMPORTANT:** Before enabling Trusted Platform Module (TPM) functionality on this system, you must ensure that your intended use of TPM complies with relevant local laws, regulations and policies, and approvals or licenses must be obtained if applicable. For any compliance issues arising from your operation/usage of TPM which violates the above mentioned requirement, you shall bear all the liabilities wholly and solely. HP will not be responsible for any related liabilities.

TPM provides additional security for your computer. You can modify the TPM settings in Computer Setup (BIOS).

 **NOTE:** If you change the TPM setting to Hidden, TPM is not visible in the operating system.

To access TPM settings in Computer Setup:

1. Start Computer Setup. See [Starting Computer Setup on page 82](#).
2. Select **Security**, select **TPM Embedded Security**, and then follow the on-screen instructions.

Using HP Sure Start (select products only)

Select computer models are configured with HP Sure Start, a technology that monitors the computer's BIOS for attacks or corruption. If the BIOS becomes corrupted or is attacked, HP Sure Start automatically restores the BIOS to its previously safe state, without user intervention.

HP Sure Start is configured and already enabled so that most users can use the HP Sure Start default configuration. The default configuration can be customized by advanced users.

To access the latest documentation on HP Sure Start, go to <http://www.hp.com/support>. Select **Find your product**, and then follow the on-screen instructions.

12 Using HP PC Hardware Diagnostics (UEFI)

HP PC Hardware Diagnostics is a Unified Extensible Firmware Interface (UEFI) that allows you to run diagnostic tests to determine whether the computer hardware is functioning properly. The tool runs outside the operating system so that it can isolate hardware failures from issues that are caused by the operating system or other software components.

When HP PC Hardware Diagnostics (UEFI) detects a failure that requires hardware replacement, a 24-digit Failure ID code is generated. This ID code can then be provided to support to help determine how to correct the problem.

 **NOTE:** To start diagnostics on a convertible computer, your computer must be in notebook mode and you must use the keyboard attached.

To start HP PC Hardware Diagnostics (UEFI), follow these steps:

1. Turn on or restart the computer, and quickly press *esc*.
2. Press *f2*.

The BIOS searches three places for the diagnostic tools, in the following order:

- a. Connected USB drive

 **NOTE:** To download the HP PC Hardware Diagnostics (UEFI) tool to a USB drive, see [Downloading HP PC Hardware Diagnostics \(UEFI\) to a USB device on page 86](#).

- b. Hard drive

- c. BIOS

3. When the diagnostic tool opens, select the type of diagnostic test you want to run, and then follow the on-screen instructions.

 **NOTE:** If you need to stop a diagnostic test, press *esc*.

Downloading HP PC Hardware Diagnostics (UEFI) to a USB device

 **NOTE:** The HP PC Hardware Diagnostics (UEFI) download instructions are provided in English only, and you must use a Windows computer to download and create the HP UEFI support environment because only .exe files are offered.

There are two options to download HP PC Hardware Diagnostics to a USB device.

Download the latest UEFI version

1. Go to <http://www.hp.com/go/techcenter/pcdiags>. The HP PC Diagnostics home page is displayed.
2. In the HP PC Hardware Diagnostics section, select the **Download** link, and then select **Run**.

Download any version of UEFI for a specific product

1. Go to <http://www.hp.com/support>.
2. Select **Get software and drivers**.
3. Enter the product name or number.

4. Select your computer, and then select your operating system.
5. In the **Diagnostic** section, follow the on-screen instructions to select and download the UEFI version you want.

Using Remote HP PC Hardware Diagnostics (UEFI) settings (select products only)

Your computer supports Remote HP PC Hardware Diagnostics (UEFI). This is a firmware (BIOS) feature that downloads HP PC Hardware Diagnostics UEFI to your computer.

It executes the diagnostics on your computer, and then may upload results to a preconfigured server.

Using the Remote HP PC Hardware Diagnostics setting in Computer Setup (BIOS), you can perform the following customizations:

- Set a schedule for running diagnostics unattended. You can also start diagnostics immediately in interactive mode by selecting **Execute Remote HP PC Hardware Diagnostics**.
- Set the location for downloading the diagnostic tools. This feature provides access to the tools from the HP website or from a server that has been preconfigured for use. Your computer does not require the traditional local storage (such as a disk drive or USB flash drive) to run remote diagnostics.
- Set a location for storing the test results. You can also set the user name and password settings used for uploads.
- Display status information about the diagnostics run previously.

Customizing Remote HP PC Hardware Diagnostics (UEFI) settings

1. Turn on or restart the computer, and when the HP logo appears, press **f10** to enter Computer Setup.
2. Select **Advanced**, and then select **Settings**.
3. Make your customization selections.
4. Select **Main**, and then **Save Changes and Exit** to save your settings.

Your changes take effect when the computer restarts.

To access documentation on using Remote HP PC Hardware Diagnostics (UEFI) to configure a server for remote diagnostics or to customize which diagnostic tests are run, go to <http://www.hp.com/support>. Select **Find your product**, and then follow the on-screen instructions.

13 Backup and recovery information

This chapter provides information on software to be used for backup and recovery. The information in the chapter is standard procedure for most Thin Client products.

HP ThinUpdate software is installed on Thin Client computers (select products only) to provide backup and recovery. If it is not installed on your computer, you can download it from <http://www.hp.com/support> (search for the Thin Client model and click on the **Drivers & software** section of the support page for that model. For information on using this software, refer to the Manuals section).



NOTE: HP recommends periodically going to the website to check for application updates.

Use HP ThinUpdate software for the following processes:

- Creating recovery media and backups
- Restoring and recovering your system
- Installing and updating software

14 Specifications

Computer specifications

Table 14-1 Specifications

	Metric	U.S.
Dimensions		
Depth	238.0 mm	9.37 in
Width	336.0 mm	13.23 in
Height	19.95 mm	0.79 in
Weight		
1 DIMM, WLAN, no camera, no fingerprint reader	1.635 kg	3.6 lbs
Input power		
Operating voltage	19.0 V dc @ 4.74 A – 90 W or 18.5 V dc @ 3.5 A - 65 W	
Operating current	4.74 A or 3.5 A	
Temperature		
Operating (not writing to optical disc)	0°C to 35°C	32°F to 95°F
Operating (writing to optical disc)	5°C to 35°C	41°F to 95°F
Nonoperating	-20°C to 60°C	-4°F to 140°F
Relative humidity		
Operating	10% to 90%	
Nonoperating	5% to 95%	
Maximum altitude (unpressurized)		
Operating (14.7 to 10.1 psia)	-15 m to 3,048 m	50 ft to 10,000 ft
Nonoperating (14.7 to 4.4 psia)	-15 m to 12,192 m	-50 ft to 40,000 ft
Shock		
Operating	125 g, 2 ms, half-sine	
Nonoperating	200 g, 2 ms, half-sine	
Random vibration		
Operating	0.75 g zero-to-peak, 10 Hz to 500 Hz, 0.25 oct/min sweep rate	
Nonoperating	1.50 g zero-to-peak, 10 Hz to 500 Hz, 0.5 oct/min sweep rate	

NOTE: Applicable product safety standards specify thermal limits for plastic surfaces. The computer operates well within this range of temperatures.

35.6-cm (14.0-in) display specifications

Table 14-2 Display specifications

	Metric	U.S.
Active diagonal size	35.6-cm	14.0-in
Resolution	HD: 1366x768 FHD: 1920x1080	
Surface treatment	Anti-glare	
Panel Width	3.0 mm	
Brightness	220 nits	
Viewing angle	SVA UWVA	
Backlight	LED	
Aspect ratio	16:9	

Solid-state drive specifications

Table 14-3 Solid-state drive specifications

	128-GB*
Height	1.0 mm
Length	50.8 mm
Width	28.9 mm
Weight	< 10 g
Transfer rate	
Sequential read	up to 2150 MB/sec
Random read	Up to 300,000 IOPs
Sequential write	up to 1260 MB/sec
Random write	Up to 100,000 IOPs
Interface type	SATA-3
Ready time, maximum (to not busy)	1.0 ms
Access times, logical	0.1 ms
Total logical sectors	234,441,648
Operating temperature	0°C to 70°C (32°F to 158°F)
*1 GB = 1 billion bytes when referring to drive storage capacity. Actual accessible capacity is less. Actual drive specifications may differ slightly.	
NOTE: Certain restrictions and exclusions apply. Contact technical support for details.	

15 Statement of memory volatility

The purpose of this chapter is to provide general information regarding nonvolatile memory in HP Business computers. This chapter also provides general instructions for restoring nonvolatile memory that can contain personal data after the system has been powered off and the solid-state drive has been removed.

HP Business computer products that use Intel®-based or AMD®-based system boards contain volatile DDR memory. The amount of nonvolatile memory present in the system depends upon the system configuration. Intel-based and AMD-based system boards contain nonvolatile memory subcomponents as originally shipped from HP, assuming that no subsequent modifications have been made to the system and assuming that no applications, features, or functionality have been added to or installed on the system.

Following system shutdown and removal of all power sources from an HP Business computer system, personal data can remain on volatile system memory (DIMMs) for a finite period of time and will also remain in nonvolatile memory. Use the steps below to remove personal data from the computer, including the nonvolatile memory found in Intel-based and AMD-based system boards.

 **NOTE:** If your tablet has a keyboard base, connect to the keyboard base before beginning steps in this chapter.

Current BIOS steps

1. Follow steps (a) through (l) below to restore the nonvolatile memory that can contain personal data. Restoring or reprogramming nonvolatile memory that does not store personal data is neither necessary nor recommended.
 - a. Turn on or restart the computer, and then press **esc** while the “Press the ESC key for Startup Menu” message is displayed at the bottom of the screen.

 **NOTE:** If the system has a BIOS administrator password, enter the password at the prompt.

- b. Select **Main**, select **Apply Factory Defaults and Exit**, and then select **Yes** to load defaults.
The computer will reboot.
 - c. During the reboot, press **esc** while the “Press the ESC key for Startup Menu” message is displayed at the bottom of the screen.

 **NOTE:** If the system has a BIOS administrator password, enter the password at the prompt.

- d. Select the **Security** menu, select **Restore Security Settings to Factory Defaults**, and then select **Yes** to restore security level defaults.
The computer will reboot.
 - e. During the reboot, press **esc** while the “Press the ESC key for Startup Menu” message is displayed at the bottom of the screen.

 **NOTE:** If the system has a BIOS administrator password, enter the password at the prompt.

- f. If an asset or ownership tag is set, select the **Security** menu and scroll down to the **Utilities** menu. Select **System IDs**, and then select **Asset Tracking Number**. Clear the tag, and then make the selection to return to the prior menu.

Nonvolatile memory usage

Table 15-1 Troubleshooting steps for nonvolatile memory usage

Nonvolatile Memory Type	Amount (Size)	Does this memory store customer data?	Does this memory retain data when power is removed?	What is the purpose of this memory?	How is data input into this memory?	How is this memory write-protected?
HP Sure Start flash (select models only)	8 MBytes	No	Yes	Provides protected backup of critical System BIOS code, EC firmware, and critical computer configuration data for select platforms that support HP Sure Start. For more information, see Using HP Sure Start (select models only) on page 97 .	Data cannot be written to this device via the host processor. The content is managed solely by the HP Sure Start Embedded Controller.	This memory is protected by the HP Sure Start Embedded Controller.
Real Time Clock (RTC) battery backed-up CMOS configuration memory	256 Bytes	No	Yes	Stores system date and time and noncritical data.	RTC battery backed-up CMOS is programmed using the Computer Setup (BIOS), or changing the Microsoft Windows date & time.	This memory is not write-protected.
Controller (NIC) EEPROM	64 KBytes (not customer accessible)	No	Yes	Stores NIC configuration and NIC firmware.	NIC EEPROM is programmed using a utility from the NIC vendor that can be run from DOS.	A utility is required to write data to this memory and is available from the NIC vendor. Writing data to this ROM in an inappropriate manner will render the NIC non-functional.
DIMM Serial Presence Detect (SPD) configuration data	256 Bytes per memory module, 128 Bytes programmable (not customer accessible)	No	Yes	Stores memory module information.	DIMM SPD is programmed by the memory vendor.	Data cannot be written to this memory when the module is installed in a computer. The specific write-protection method varies by memory vendor.
System BIOS	9 MBytes	Yes	Yes	Stores system BIOS code and computer configuration data.	System BIOS code is programmed at the factory. Code is updated when the system BIOS is updated. Configuration data and settings are input using the Computer Setup (BIOS) or a custom utility.	NOTE: Writing data to this ROM in an inappropriate manner can render the computer non-functional. A utility is required for writing data to this memory and is available on the HP website; go to http://www.hp.com/

Table 15-1 Troubleshooting steps for nonvolatile memory usage (continued)

Nonvolatile Memory Type	Amount (Size)	Does this memory store customer data?	Does this memory retain data when power is removed?	What is the purpose of this memory?	How is data input into this memory?	How is this memory write-protected?
Intel Management Engine Firmware (present only in select Elite or Z models. For more information, go to http://www.hp.com/support . Select Find your product , and then follow the on-screen instructions.)	1.5 MBytes or 7 MBytes	Yes	Yes	Stores Management Engine Code, Settings, Provisioning Data and iAMT third-party data store.	Management Engine Code is programmed at the factory. Code is updated via Intel secure firmware update utility. Unique Provisioning Data can be entered at the factory or by an administrator using the Management Engine (MEBx) setup utility. The third party data store contents can be populated by a remote management console or local applications that have been registered by an administrator to have access to the space.	support . Select Find your product , and then follow the on-screen instructions. The Intel chipset is configured to enforce hardware protection to block all direct read/write access to this area. An Intel utility is required for updating the firmware. Only firmware updates digitally signed by Intel can be applied using this utility.
Bluetooth flash (select products only)	2 Mbit	No	Yes	Stores Bluetooth configuration and firmware.	Bluetooth flash is programmed at the factory. Tools for writing data to this memory are not publicly available but can be obtained from the silicon vendor.	A utility is required for writing data to this memory and is made available through newer versions of the driver whenever the flash requires an upgrade.
802.11 WLAN EEPROM	4 Kbit to 8 Kbit	No	Yes	Stores configuration and calibration data.	802.11 WLAN EEPROM is programmed at the factory. Tools for writing data to this memory are not made public.	A utility is required for writing data to this memory and is typically not made available to the public unless a firmware upgrade is necessary to address a unique issue.
Camera (select products only)	64 Kbit	No	Yes	Stores camera configuration and firmware.	Camera memory is programmed using a utility from the device manufacturer that can be run from Windows.	A utility is required for writing data to this memory and is typically not made available to the public unless a firmware upgrade is necessary to address a unique issue.
Fingerprint reader (select products only)	512 KByte flash	Yes	Yes	Stores fingerprint templates.	Fingerprint reader memory is programmed by user enrollment in HP ProtectTools Security Manager.	Only a digitally signed application can make the call to write to the flash.

Questions and answers

1. How can the BIOS settings be restored (returned to factory settings)?



IMPORTANT: Restore defaults does not securely erase any data on your solid-state drive. See question and answer 6 for steps to securely erase data.

Restore defaults does not reset the Custom Secure Boot keys. See question and answer 7 for information about resetting the keys.

- a. Turn on or restart the computer, and then press **esc** while the “Press the ESC key for Startup Menu” message is displayed at the bottom of the screen.
- b. Select **Main**, and then select **Apply Factory Defaults and Exit**.
- c. Follow the on-screen instructions.
- d. Select **Main**, select **Save Changes and Exit**, and then follow the on-screen instructions.

2. What is a UEFI BIOS, and how is it different from a legacy BIOS?

The Unified Extensible Firmware Interface (UEFI) BIOS is an industry-standard software interface between the platform firmware and an operating system (OS). It is a replacement for the older BIOS architecture, but supports much of the legacy BIOS functionality.

Like the legacy BIOS, the UEFI BIOS provides an interface to display the system information and configuration settings and to change the configuration of your computer before an OS is loaded. BIOS provides a secure run-time environment that supports a Graphic User Interface (GUI). In this environment, you can use either a pointing device (Touchscreen, TouchPad, pointing stick, or USB mouse) or the keyboard to navigate and make menu and configuration selections. The UEFI BIOS also contains basic system diagnostics.

The UEFI BIOS provides functionality beyond that of the legacy BIOS. In addition, the UEFI BIOS works to initialize the computer’s hardware before loading and executing the OS; the run-time environment allows the loading and execution of software programs from storage devices to provide more functionality, such as advanced hardware diagnostics (with the ability to display more detailed system information) and advanced firmware management and recovery software.

HP has provided options in Computer Setup (BIOS) to allow you to run in legacy BIOS, if required by the operating system. Examples of this requirement would be if you upgrade or downgrade the OS.

3. Where does the UEFI BIOS reside?

The UEFI BIOS resides on a flash memory chip. A utility is required to write to the chip.

4. What kind of configuration data is stored on the DIMM Serial Presence Detect (SPD) memory module? How would this data be written?

The DIMM SPD memory contains information about the memory module, such as size, serial number, data width, speed/timing, voltage, and thermal information. This information is written by the module manufacturer and stored on an EEPROM. This EEPROM cannot be written to when the memory module is installed in a computer. Third-party tools do exist that can write to the EEPROM when the memory module is not installed in a computer. Various third-party tools are available to read SPD memory.

5. What is meant by “Restore the nonvolatile memory found in Intel-based system boards”?

This message relates to clearing the Real Time Clock (RTC) CMOS memory that contains computer configuration data.

6. How can the BIOS security be reset to factory defaults and data erased?

 **IMPORTANT:** Resetting will result in the loss of information.

These steps will not reset Custom Secure Boot Keys. See question and answer 7 for information about resetting the keys.

- a. Turn on or restart the computer, and then press **esc** while the “Press the ESC key for Startup Menu” message is displayed at the bottom of the screen.
- b. Select **Main**, and then select **Reset Security to Factory Defaults**.
- c. Follow the on-screen instructions.
- d. Select **Main**, select **Save Changes and Exit**, and then follow the on-screen instructions.

7. How can the Custom Secure Boot Keys be reset?

Secure Boot is a feature to ensure that only authenticated code can start on a platform. If you enabled Secure Boot and created Custom Secure Boot Keys, simply disabling Secure Boot will not clear the keys. You must also select to clear the Custom Secure Boot Keys. Use the same Secure Boot access procedure you used to create the Custom Secure Boot Keys, but make the selection to clear or delete all Secure Boot Keys.

- a. Turn on or restart the computer, and then press **esc** while the “Press the ESC key for Startup Menu” message is displayed at the bottom of the screen.
- b. Select the **Security** menu, select **Secure Boot Configuration**, and then follow the on-screen instructions.
- c. At the **Secure Boot Configuration** window, select **Secure Boot**, select **Clear Secure Boot Keys**, and then follow the on-screen instructions to continue.

Using HP Sure Start (select models only)

Select computer models are configured with HP Sure Start, a technology that continuously monitors your computer's BIOS for attacks or corruption. If the BIOS becomes corrupted or is attacked, HP Sure Start restores the BIOS to its previously safe state, without user intervention. Those select computer models ship with HP Sure Start configured and enabled. HP Sure Start is configured and already enabled so that most users can use the HP Sure Start default configuration. The default configuration can be customized by advanced users.

To access the latest documentation on HP Sure Start, go to <http://www.hp.com/support>. Select **Find your product**, and then follow the on-screen instructions.

16 Power cord set requirements

The wide-range input feature of the computer permits it to operate from any line voltage from 100 to 120 V ac, or from 220 to 240 V ac.

The 3-conductor power cord set included with the computer meets the requirements for use in the country or region where the equipment is purchased.

Power cord sets for use in other countries or regions must meet the requirements of the country and region where the computer is used.

Requirements for all countries

The following requirements are applicable to all countries and regions:

- The length of the power cord set must be at least **1.0 m** (3.3 ft) and no more than **2.0 m** (6.5 ft).
- All power cord sets must be approved by an acceptable accredited agency responsible for evaluation in the country or region where the power cord set will be used.
- The power cord sets must have a minimum current capacity of 10 A and a nominal voltage rating of 125 or 250 V ac, as required by the power system of each country or region.
- The appliance coupler must meet the mechanical configuration of an EN 60 320/IEC 320 Standard Sheet C13 connector for mating with the appliance inlet on the back of the computer.

Requirements for specific countries and regions

Table 16-1 Power cord requirements for specific countries and regions

Country/region	Accredited agency	Applicable note number
Argentina	IRAM	1
Australia	SAA	1
Austria	OVE	1
Belgium	CEBEC	1
Brazil	ABNT	1
Canada	CSA	2
Chile	IMQ	1
Denmark	DEMKO	1
Finland	FIMKO	1
France	UTE	1
Germany	VDE	1
India	BIS	1
Israel	SII	1
Italy	IMQ	1
Japan	JIS	3
The Netherlands	KEMA	1
New Zealand	SANZ	1
Norway	NEMKO	1
The People's Republic of China	CCC	4
Saudi Arabia	SASO	7
Singapore	PSB	1
South Africa	SABS	1
South Korea	KTL	5
Sweden	SEMKO	1
Switzerland	SEV	1
Taiwan	BSMI	6
Thailand	TISI	1
The United Kingdom	ASTA	1
The United States	UL	2

1. The flexible cord must be Type H05VV-F, 3-conductor, 0.75 mm² conductor size. Power cord set fittings (appliance coupler and wall plug) must bear the certification mark of the agency responsible for evaluation in the country or region where it will be used.

Table 16-1 Power cord requirements for specific countries and regions (continued)

Country/region	Accredited agency	Applicable note number
		2. The flexible cord must be Type SVT/SJT or equivalent, No. 18 AWG, 3-conductor. The wall plug must be a two-pole grounding type with a NEMA 5-15P (15 A, 125 V ac) or NEMA 6-15P (15 A, 250 V ac) configuration. CSA or C-UL mark. UL file number must be on each element.
		3. The appliance coupler, flexible cord, and wall plug must bear a “T” mark and registration number in accordance with the Japanese Dentori Law. The flexible cord must be Type VCTF, 3-conductor, 0.75 mm ² or 1.25 mm ² conductor size. The wall plug must be a two-pole grounding type with a Japanese Industrial Standard C8303 (7 A, 125 V ac) configuration.
		4. The flexible cord must be Type RVV, 3-conductor, 0.75 mm ² conductor size. Power cord set fittings (appliance coupler and wall plug) must bear the CCC certification mark.
		5. The flexible cord must be Type H05VV-F 3-conductor, 0.75 mm ² conductor size. KTL logo and individual approval number must be on each element. Corset approval number and logo must be printed on a flag label.
		6. The flexible cord must be Type HVCTF 3-conductor, 1.25 mm ² conductor size. Power cord set fittings (appliance coupler, cable, and wall plug) must bear the BSMI certification mark.
		7. For 127 V ac, the flexible cord must be Type SVT or SJT 3-conductor, 18 AWG, with plug NEMA 5-15P (15 A, 125 V ac), with UL and CSA or C-UL marks. For 240 V ac, the flexible cord must be Type H05VV-F 3-conductor, 0.75 mm ² or 1.00 mm ² conductor size, with plug BS 1363/A with BSI or ASTA marks.

17 Recycling

When a non-rechargeable or rechargeable battery has reached the end of its useful life, do not dispose of the battery in general household waste. Follow the local laws and regulations in your area for battery disposal.

HP encourages customers to recycle used electronic hardware, HP original print cartridges, and rechargeable batteries. For more information about recycling programs, see the HP Web site at <http://www.hp.com/recycle>.

Index

- A**
 - AC adapter, spare part numbers 20
 - action keys, identifying 11
 - antennas
 - disconnecting 32
 - audible codes 68, 73
 - audio, product description 1
 - audio-out (headphone)/audio-in (microphone) combo jack, identifying 5
- B**
 - backup and recovery 88
 - base enclosure, spare part number 16
 - basic troubleshooting 77
 - battery
 - removing 54
 - spare part number 16, 54
 - battery light 4
 - beep codes 68, 73
 - BIOS
 - determining version 83
 - downloading an update 84
 - updating 83
 - Bluetooth card
 - spare part number 32
 - Bluetooth label 14
 - bottom 14
 - Bracket Kit
 - contents 19
 - spare part number 19
 - buttons
 - left TouchPad 8
 - power 10
 - right TouchPad 8
- C**
 - Cable Kit
 - contents 18
 - spare part number 18
 - camera 7
 - product description 1
 - camera light, identifying 7
 - camera module
 - spare part number 17
 - camera, identifying 7
 - caps lock light, identifying 9
 - card reader board
 - removal 50
 - spare part number 16, 50
 - cautions
 - electrostatic discharge 23
 - components
 - bottom 12
 - display 7
 - left side 5
 - right side 4
 - top 8
 - Computer Setup
 - navigating and selecting 82
 - restoring factory settings 82
 - computer specifications 89
 - connector, power 5
- D**
 - diagnostics and troubleshooting 70
 - disabling/enabling Wake-on LAN (WOL) 71
 - diskless troubleshooting 78
 - display assembly
 - removal 62
 - spare part numbers 17, 62
 - display bezel
 - spare part numbers 17
 - display panel
 - product description 1
 - display rear cover
 - spare part number 18
 - display specifications 90
 - DisplayPort
 - identifying USB Type-C 4
 - drive light, identifying 6
- E**
 - electrostatic discharge (ESD) 23
 - preventing damage 24
 - embedded numeric keypad, identifying 11
- F**
 - error
 - codes 68, 73
 - messages 75
 - esc key, identifying 11
 - Ethernet, product description 1
 - external media cards, product description 2
 - external monitor port, using 4
- G**
 - fan
 - removing 51
 - spare part number 16
 - fingerprint reader assembly
 - removal 42
 - spare part number 16, 42
 - fingerprint reader, identifying 10
 - flashing LEDs 68, 73
 - fn key, identifying 11
 - fn lock light 9
- G**
 - graphics, product description 1
 - grounding methods 25
 - guidelines
 - packaging 26
 - transporting 26
 - workstation 23
- H**
 - HDMI port, identifying 4
 - heat sink
 - removal 60
 - spare part number 16, 60
 - Hinge Kit
 - spare part number 17
 - HP PC Hardware Diagnostics (UEFI) using 86
 - HP Sure Start 97
- I**
 - integrated camera light, identifying 7
 - internal microphones, identifying 7

J

jacks

- audio-out (headphone)/audio-in (microphone) combo 5
- network 4
- RJ-45 (network) 4

K

keyboard

- product description 2
- removal 35
- spare part numbers 16, 35

keypad

- embedded numeric 11

keys

- esc 11
- fn 11
- Windows application 11
- Windows key 11

L

labels

- Bluetooth 14
- regulatory 14
- serial number 13
- service 13
- wireless certification 14
- WLAN 14

LEDs 70

- blinking power 73

legacy support, USB 82

lights 6

- battery 4
- camera 7
- caps lock 9
- fn lock 9
- microphone mute 9
- num lock 9
- power 9
- RJ-45 (network) 4
- wireless 9

M

memory

- nonvolatile 92
- volatile 92

memory card reader, identifying 6

memory module

- identifying 12
- product description 1

removal 30

- spare part numbers 16, 30

microphone (audio-in) jack

- product description 1

microphone board

- spare part number 17

microphone mute light, identifying

9

mini card

- product description 1

model name 1

N

network jack, identifying 4

nonvolatile memory 92

num lock light 9

numeric error codes 75

O

operating system, product description 3

P

packaging guidelines 26

Plastics Kit

- contents 19
- spare part number 19

pointing device, product description 2

ports

- external monitor 4
- HDMI 4
- product description 2
- USB 3.x SuperSpeed 4, 5
- USB Type-C DisplayPort 4
- USB Type-C power connector 4
- USB Type-C SuperSpeed 4

power and IDE flash activity LEDs 70

power button board

- removal 44
- spare part number 16, 44

power button, identifying 10

power cable

- removal 67
- spare part number 16, 67

Power connector

- identifying USB Type-C 4

power connector, identifying 5

power cord

- requirements for all countries 98

- requirements for specific countries and regions 99

- set requirements 98

- spare part numbers 20, 21

power lights 9

power requirements, product description 2

power-on diagnostic tests 72

power-on sequence 71

processor

- product description 1

product description

- audio 1
- camera 1
- display panel 1
- Ethernet 1
- external media cards 2
- graphics 1
- keyboard 2
- memory module 1
- microphone 1
- mini card 1
- operating system 3
- pointing devices 2
- ports 2
- power requirements 2
- processors 1
- product name 1
- security 3
- serviceability 3
- wireless 1

product name 1

product name and number, computer 13

R

regulatory information

- regulatory label 14
- wireless certification labels 14

removal/replacement

- procedures, Authorized Service Provider 38
- procedures, Customer Self-Repair 27

removing personal data from volatile system memory 92

- resetting the Administrator password 72
- RJ-45 (network) jack, identifying 4
- RJ-45 (network) lights, identifying 4
- RTC battery
 - removal 53
 - spare part number 16, 53
- S**
- Screw Kit, spare part number 21
- security cable slot, identifying 5
- security, product description 3
- serial number 13
- serial number, computer 13
- service doors
 - removing 28
 - spare part number 28
- service labels, locating 13
- serviceability, product description 3
- setup utility
 - navigating and selecting 82
 - restoring factory settings 82
- slots
 - security cable 5
- solid-state drive
 - removal 34
 - spare part numbers 16, 34
 - specifications 91
- speaker assembly
 - removal 46
 - spare part number 16, 46
- speakers, identifying 10
- special keys, using 11
- specifications
 - computer 89
 - display 90
 - solid-state drive 91
- static electricity 24
- Sure Start
 - using 85
- system board
 - removal 57
 - spare part numbers 16, 57
- system memory, removing personal data from volatile 92
- T**
- thermal material, replacement 61
- top cover
 - removal 39
 - spare part number 16, 39
- TouchPad
 - buttons 8
 - spare part number 16
- TouchPad assembly
 - removal 48
 - spare part number 48
- TouchPad zone
 - identifying 8
- TPM settings 85
- transporting guidelines 26
- traveling with the computer 14
- troubleshooting 77
- U**
- USB
 - spare part number 16
- USB 3.x SuperSpeed port, identifying 4
- USB 3.x SuperSpeed powered port, identifying 5
- USB board
 - removal 55
 - spare part number 55
- USB legacy support 82
- USB Type-C power connector port, identifying 4
- USB Type-C SuperSpeed port, identifying 4
- V**
- vents, identifying 5, 12
- W**
- Wake-on LAN (WOL) 71
- Windows application key, identifying 11
- Windows key, identifying 11
- wireless antennas
 - disconnecting 32
- wireless certification label 14
- wireless light 9
- wireless, product description 1
- WLAN antennas, identifying 7
- WLAN device 14
- WLAN label 14
- WLAN/Bluetooth combo card
 - removal 32
 - spare part number 16, 32
- workstation guidelines 23