



Maintenance and Service Guide

HP ZBook 15 G6 Mobile Workstation

© Copyright 2019 HP Development Company, L.P.

AMD, AMD Radeon, and Enduro are trademarks of Advanced Micro Devices, Inc. Bluetooth is a trademark owned by its proprietor and used by HP Inc. under license. Intel Core, Optane, Xeon, XMM, vPro, and Thunderbolt are trademarks of Intel Corporation or its subsidiaries in the U.S. and/or other countries. Linux is the registered trademark of Linus Torvalds in the U.S. and other countries. Microsoft and Windows are either registered trademarks or trademarks of Microsoft Corporation in the United States and/or other countries. NVIDIA, Optimus, and Quadro are trademarks and/or registered trademarks of NVIDIA Corporation in the U.S. and other countries. Red Hat is a registered trademark of Red Hat, Inc. in the United States and other countries. DisplayPort and the DisplayPort logo are trademarks owned by the Video Electronics Standards Association (VESA) in the United States and other countries.

The information contained herein is subject to change without notice. The only warranties for HP products and services are set forth in the express warranty statements accompanying such products and services. Nothing herein should be construed as constituting an additional warranty. HP shall not be liable for technical or editorial errors or omissions contained herein.

First Edition: July 2019

Document Part number: L58963-001

Product notice

This guide describes features that are common to most models. Some features may not be available on your computer.

Not all features are available in all editions or versions of Windows. Systems may require upgraded and/or separately purchased hardware, drivers, software or BIOS update to take full advantage of Windows functionality. Windows 10 is automatically updated, which is always enabled. ISP fees may apply and additional requirements may apply over time for updates. Go to <http://www.microsoft.com> for details.

To access the latest user guides, go to <http://www.hp.com/support>, and follow the instructions to find your product. Then select **User Guides**.

Software terms

By installing, copying, downloading, or otherwise using any software product preinstalled on this computer, you agree to be bound by the terms of the HP End User License Agreement (EULA). If you do not accept these license terms, your sole remedy is to return the entire unused product (hardware and software) within 14 days for a full refund subject to the refund policy of your seller.

For any further information or to request a full refund of the price of the computer, please contact your seller.

Important Notice about Customer Self-Repair Parts



IMPORTANT: Your computer includes Customer Self-Repair parts and parts that should be accessed by only an authorized service provider. See Chapter 5, "Removal and replacement procedures for Customer Self-Repair parts," for details. Accessing parts described in Chapter 6, "Removal and replacement procedures for authorized service provider parts," can damage the computer or void your warranty.

Safety warning notice

 **WARNING!** To reduce the possibility of heat-related injuries or of overheating the device, do not place the device directly on your lap or obstruct the device air vents. Use the device only on a hard, flat surface. Do not allow another hard surface, such as an adjoining optional printer, or a soft surface, such as pillows or rugs or clothing, to block airflow. Also, do not allow the AC adapter to contact the skin or a soft surface, such as pillows or rugs or clothing, during operation. The device and the AC adapter comply with the user-accessible surface temperature limits defined by applicable safety standards.

Table of contents

1 Product description	1
2 Components	7
Right	7
Left	9
Display	10
Keyboard area	11
Touchpad	11
Lights	12
Button, speakers, and fingerprint reader	14
Shortcut keys	15
Hot keys (select products only)	16
Cover	16
Bottom	17
Labels	18
3 Illustrated parts catalog	19
Computer major components	19
Display assembly subcomponents	22
Bracket Kit	24
Cable Kit	25
Plastics Kit	25
Mass storage devices	26
Miscellaneous parts	27
4 Removal and replacement procedures preliminary requirements	28
Tools required	28
Service considerations	28
Plastic parts	28
Cables and connectors	28
Drive handling	29
Workstation guidelines	29
Electrostatic discharge information	29
Generating static electricity	30
Preventing electrostatic damage to equipment	30
Personal grounding methods and equipment	31

Grounding the work area	31
Recommended materials and equipment	31
Packaging and transporting guidelines	32
5 Removal and replacement procedures for Customer Self-Repair parts	33
Component replacement procedures	33
Preparation for disassembly	33
Service door	33
Battery	35
Solid-state drives (M.2)	36
Hard drive	37
WWAN module	39
Memory module	41
6 Removal and replacement procedures for authorized service provider parts	43
Component replacement procedures	43
Keyboard	43
Bottom cover	46
Service door latch	48
Touchpad module	49
Smart card reader	51
NFC module	52
Fans	53
Heat sink assembly	56
System board	59
RTC battery	62
Memory module	64
Speakers	66
Fingerprint reader board	67
Power button board	68
Display assembly	69
7 Troubleshooting guide	79
Resources	80
General troubleshooting steps	80
Identify the issue	80
1. Understand the issue	81
Boot up sequence	81
Failure classification	81
2. Examine the environment	83

3. Perform a visual inspection of hardware	84
4. Update BIOS and drivers	84
Manually updating BIOS and drivers	84
Remotely deploying BIOS and drivers	84
Analyze the issue	84
5. Remove or uninstall recently added hardware, software	84
6. HP Hardware Diagnostics and Tools	85
Non HP diagnostics tools	85
7. Status lights, blinking light codes, troubleshooting lights, and POST error messages	86
Status lights	86
Blinking light codes	87
POST error messages	87
Resolve the issue	88
8. Hard reset	88
9. Soft reset (Default Settings)	89
10. Reseat cables and connections	89
11. Test with minimum configuration	90
Essential hardware configuration	90
Safe mode	91
12. Test with verified working configuration (hardware and/or operating system)	91
13. Replace the system board	91
Verify solution	92
Helpful Hints	92
At startup	93
During operation	93
Consulting with HP Service	94
Common issues and possible solutions	94
Power-on issues	94
No Power	94
Intermittent power-on, shutdown, reboot	96
AC adapter issue	97
Battery not recognized, not charging	98
Battery discharges too fast	99
Burnt smell	100
POST	100
No video (with power)	100
Blinking lights	101
Diagnostics error messages	102
BIOS password	103
Performance (OS)	103

Intermittent shutdown	104
Blue screen	105
Freeze at Windows Logo (hang/lockup)	107
Electromagnetic Interference (EMI)	108
No wake up	109
Unresponsive	110
Slow performance	110
HP Smart Adapter warning message	111
Incorrect time and date	111
Display	112
Display anomalies	112
Symptom	112
Quick check	113
HP PC Hardware Diagnostics (UEFI) for video test	113
Display assembly diagram	114
Dead pixel	114
No video (internal)	114
No video (external)	115
DisplayPort/VGA	115
HDMI	115
No or bad external video via docking	116
Incorrect or missing color/distorted image	116
Touch screen	117
I/O devices	118
Keyboard	118
Keyboard point stick	119
Keyboard backlight	119
Touchpad	120
Network Connectivity Ethernet (RJ-45 jack)	120
Network connectivity wireless (WLAN)	121
WWAN	122
USB	123
Smart card reader	124
Speaker, headphone - audio issues	125
Thunderbolt (TB)	126
Storage	127
Hard drive/solid-state drive not recognized	128
No boot to operating system (no read/write error)	128
Read-write error	129
Slow performance	129
Blue screen (BSOD) error	129

Noisy hard drive	130
Mechanical	131
Fan error message - 90B	131
Noise (sound)	132
Fan runs constantly	133
Thermal shutdown (hot)	134
Stuck power button	134
Additional information	135
Acronyms	135
Blinking lights and boot error codes	136
Processor not executing code	136
BIOS recovery code unable to find valid BIOS recovery image	136
Memory module error	136
Graphics Controller Error (No Controller)	137
Failure - System Board Error	137
Intel Trusted Execution Technology (TXT) Error	137
Sure Start unable to find valid BIOS Boot Block image	137
Sure Start has identified a problem (Manual Recovery Policy Set)	138
POST Error Messages and User Actions	138
Routine Maintenance for Performance Improvement	140
Common Blue Screen Error Messages	140
Error message list	140
Bug check symbolic names	140
Microsoft general troubleshooting of Windows bug check codes	141
Use Windows Debugging Tool	141
Windows Software Development Kit (SDK)	142
Display Issue: Pixel Anomalies	146
Cable management	147
Connector types	148
8 Computer Setup (BIOS), TPM, and HP Sure Start	150
Using Computer Setup	150
Starting Computer Setup	150
Navigating and selecting in Computer Setup	150
Restoring factory settings in Computer Setup	150
Updating the BIOS	151
Determining the BIOS version	151
Downloading a BIOS update	151
Changing the boot order using the f9 prompt	152
TPM BIOS settings (select products only)	152
Using HP Sure Start (select products only)	153

9 Backing up, restoring, and recovering	154
Backing up information and creating recovery media	154
Using Windows tools	154
Using the HP Cloud Recovery Download Tool to create recovery media (select products only) ...	154
Restoring and recovery	155
Restoring, resetting, and refreshing using Windows tools	155
Recovering using HP Recovery media	155
Changing the computer boot order	155
Using HP Sure Recover (select products only)	156
10 Using HP PC Hardware Diagnostics	157
Using HP PC Hardware Diagnostics Windows (select products only)	157
Downloading HP PC Hardware Diagnostics Windows	157
Downloading the latest HP PC Hardware Diagnostics Windows version	158
Downloading HP Hardware Diagnostics Windows by product name or number (select products only)	158
Installing HP PC Hardware Diagnostics Windows	158
Using HP PC Hardware Diagnostics UEFI	158
Starting HP PC Hardware Diagnostics UEFI	159
Downloading HP PC Hardware Diagnostics UEFI to a USB flash drive	159
Downloading the latest HP PC Hardware Diagnostics UEFI version	159
Downloading HP PC Hardware Diagnostics UEFI by product name or number (select products only)	159
Using Remote HP PC Hardware Diagnostics UEFI settings (select products only)	160
Downloading Remote HP PC Hardware Diagnostics UEFI	160
Downloading the latest Remote HP PC Hardware Diagnostics UEFI version	160
Downloading Remote HP PC Hardware Diagnostics UEFI by product name or number	160
Customizing Remote HP PC Hardware Diagnostics UEFI settings	160
11 Specifications	162
Computer specifications	162
39.6 cm (15.6 in) display specifications	162
12 Power cord set requirements	164
Requirements for all countries	164
Requirements for specific countries and regions	165
13 Statement of memory volatility	167
Nonvolatile memory usage	169

Questions and answers	171
Using HP Sure Start (select models only)	172
14 Recycling	173
Index	174

1 Product description

Table 1-1 Product components and their descriptions

Category	Description
Product Name	HP ZBook 15 G6 Mobile Workstation
Processors	9th-generation Intel® Core™ processors Intel Core i9-9880H (2.3 GHz, up to 4.8 GHz with Intel Turbo Boost Technology, 2666 MHz, octa-core, 16 MB L3 cache, 45 W) Intel Core i7-9850H (2.6 GHz, up to 4.6 GHz with Intel Turbo Boost Technology, 2666 MHz, hexa-core, 12 MB L3 cache, 45 W) Intel Core i7-9750H (2.6 GHz, up to 4.5 GHz with Intel Turbo Boost Technology, 2666 MHz, hexa-core, 12 MB L3 cache, 45 W) Intel Core i5-9400H (2.5 GHz, up to 4.3 GHz with Intel Turbo Boost Technology, 2666 MHz, quad, 8 MB L3 cache, 45 W) Intel Core i5-9300H (2.4 GHz, up to 4.1 GHz with Intel Turbo Boost Technology, 2666 MHz, quad-core, 8 MB L3 cache, 45 W) Intel® Xeon®, octa-core, BGA, processor Intel Xeon E-2286M (2.4 GHz, up to 5.0 GHz with Intel Turbo Boost Technology, octa-core, 2666 MHz, 16 MB L3 cache, 45 W)
Graphics	Integrated UMA graphics Configure as UMA-only or use with hybrid when GPU configured on Core i5. Configure as hybrid-only when GPU configured on Core i7 or Xeon processor. <ul style="list-style-type: none">• Core processors: Intel UHD graphics 630• Xeon processors: Intel UHD graphics P630 Discrete graphics (select products only) <ul style="list-style-type: none">• Supports discrete only in BIOS• NVIDIA® GC6 3.0 and GC OFF• Hybrid (Switchable) Graphics• NVIDIA Optimus™ Technology• Open GL 4.5/Open CL 1.2/Vulkan 1.0• DisplayPort 1.4b with discrete (supported through Thunderbolt™ 3)• NVIDIA Mosaic Technology• Supports up to four discrete displays or three UMA displays (through the optional docking station) Supports the following graphics cards: <ul style="list-style-type: none">• NVIDIA Quadro® T1000• NVIDIA Quadro T2000

Table 1-1 Product components and their descriptions (continued)

Category	Description
Panel	39.6 cm (15.6 in), LED backlight, UWVA
	FHD (1920 × 1080), antiglare, LED, UWVA, slim, eDP, 60% sRGB, slim, 250 nits with or without HD camera or FHD camera + IR camera
	FHD (1920 × 1080), antiglare, 72% sRGB, eDP + PSR, slim, 400 nits with ambient light sensor and with or without HD camera or FHD camera + IR camera
	UHD (3840 × 2160), antiglare, slim, eDP + PSR, slim, 400 nits with ambient light sensor, with FHD camera + IR camera
	UHD (3840 × 2160), antiglare, RG phosphors + B-LED, DreamColor , 100% DCI P3, 600 nits, 10 (8 + 2) bit, with HD camera or FHD + IR camera
	UHD (3840 × 2160), antiglare, RG phosphors + B-LED, HDR, 100% DCI P3, 600 nits, 10 (8 + 2) bit, with HD camera or FHD + IR camera
	FHD (1920 × 1080), antiglare, eDP + PSR, 72% sRGB, uslim, privacy, 1000 nits with FHD camera + IR camera
	FHD (1920 × 1080), BrightView, eDP + PSR, touch screen, 72% sRGB, uslim, privacy, 1000 nits with FHD camera + IR camera
Memory	UHD (3840 × 2160), eDP + PSR, 72% sRGB, touch screen, slim, 400 nits with ambient light sensor and with FHD camera + IR camera
	Four memory module slots; two slots are customer accessible and upgradeable
	DDR4-2666 SODIMMs
	Supports dual-channel memory
	Supports up to 128 GB of system RAM in the following configurations:
	<ul style="list-style-type: none"> • 131072 MB (32768 MB × 4) • 65536 MB (32768 × 2 or 16384 MB × 4) • 32768 MB (32768 × 1, 16384 MB × 2, or 8192 MB × 4) • 16384 MB (16384 MB × 1, 8192 MB × 2, or 4096 MB × 4) • 8192 MB (8192 MB × 1 or 4096 MB × 2)
	ECC DDR4-2666 (Xeon processors only)
	<ul style="list-style-type: none"> • 65536 MB (16384 MB × 4) • 32768 MB (16384 MB × 2) • 16384 MB (16384 MB × 1)
Primary M.2 storage	M.2 (NGFF) SS/DS solid-state drives (2280)
	512 GB, SATA-3, TLC, FIPS-140-2
	256 GB, PCIe, NVMe, TLC
	512 GB, PCIe, NVMe, TLC
	512 GB, PCIe, NVMe, TLC, Opal 2
	1 TB, PCIe, NVMe, TLC
	2 TB, PCIe, NVMe, TLC

Table 1-1 Product components and their descriptions (continued)

Category	Description
Secondary storage	M.2 solid-state drives (2280) (only available if primary M.2 is selected)
	512 GB, SATA-3, TLC, FIPS-140-2
	256 GB, PCIe, NVMe, TLC
	512 GB, PCIe, NVMe, TLC
	512 GB, PCIe, NVMe, TLC, Opal 2
	1 TB, PCIe, NVMe, TLC
	2 TB, PCIe, NVMe, TLC
Primary 2.5 inch SATA storage	Hard drive, 2.5 inch, 7 mm/9.5 mm (primary 2.5 inch storage is not a required category if M.2 solid-state drive is selected)
	2 TB, 5400 rpm
	1 TB, 7200 rpm
	500 GB, 7200 rpm Self Encrypting Drive (SED, FIPS-140-2)
	500 GB, 7200 rpm
	Solid-state drive, 2.5 inch
	256 GB, SATA, TLC
	1 TB, SATA, TLC
Flash cache	16 GB Intel Optane™ cache, only available if HDD (except FIPS or SED) and Windows® 10 is selected and M.2 storage is available
RAID	NVMe RAID 1 (only available if 1 TB M.2 + 1 TB 2nd M.2 or 2 TB M.2 + 2 TB 2nd M.2 are selected)
Audio and video	HP Bang & Olufsen Audio
	HP Noise Cancellation Software
	HP Clear Sound amp
	Discrete amp
	Intel SST Audio
	Dual array and rear-facing microphones
	Stereo speakers (2)
	Camera HD 720p
	Camera FHD + IR RGB
	Camera privacy cover (only with non-touch camera panels)
	Support for models without camera
RJ-45 (network)	Intel Ethernet Connection I219-LM 10/100/1000 (vPro)
	Intel Ethernet Connection I219-V 10/100/1000
	S3/S4/S5 wake on LAN with embedded NIC
Wireless networking	Bluetooth® 5.0

Table 1-1 Product components and their descriptions (continued)

Category	Description
	<p>Wireless local area network (WLAN) with dual antennas (M.2 12 × 16 soldered down PCIe/USB; select products only)</p> <ul style="list-style-type: none"> Intel Wi-Fi 6 AX200 + Bluetooth 5 (802.11ax 2 × 2 vPro, supporting gigabit transfer speeds) Intel Wi-Fi 6 AX200 + Bluetooth 5 (802.11ax 2 × 2 non-vPro, supporting gigabit transfer speeds) <p>Two WLAN antennas built into top of display assembly</p> <p>Compatible with Wi-Fi CERTIFIED Miracast™ devices</p> <p>Support WoWLAN S3/S4</p> <p>Support HP LAN-Wireless Protection (WLAN/LAN/WWAN switching)</p> <p>Support HP Connection Optimizer</p> <p>Support Fast PCIe Error Identification</p> <p>Support Turbo Lite Wi-Fi</p> <p>Near-Field Communication (NFC) (select products only)</p> <p>NXP NPC300 Near Field Communication Module (NFC Mirage XRVA-1 [NXP NPC300 I2C 10 mm x 17 mm])</p> <p>NFC antenna</p> <p>Wireless wide area network (WWAN) (M.2 30 × 42 socket, select products only)</p> <p>Integrated wireless wide area network (WWAN) options by way of wireless module, SIM Module (3FF/micro SIM) (user accessible behind battery)</p> <p>Two WWAN antennas (worldwide 5 band, configured at top of display panel)</p> <p>Supports the following WWAN format:</p> <ul style="list-style-type: none"> Intel XMM™ 7360 LTE-Advanced (CAT 9) <p>Support for WWAN aftermarket option (AMO)</p>
Media card reader	microSD media reader slot supports SD™, SDHC™, and SDXC™
Ports	<p>Two USB Type-C (Thunderbolt 3), USB 3.1 Gen 2 + pass through DisplayPort 1.3 support + Thunderbolt 3 with PD, supported with BC 1.2</p> <p>USB 3.1 Gen 1 port</p> <p>USB 3.1 Gen 1 charging port (S3/S5)</p> <p>HDMI 2.0b (models with discrete graphics), HDMI 1.4 (models with UMA graphics)</p> <p>RJ-45 (network)</p> <p>Audio-out (headphone)/audio-in (microphone) combo jack</p> <p>Multiple pin AC port</p>
Docking	<p>HP Thunderbolt Dock 120 W G2</p> <p>HP Thunderbolt Docking Station</p> <p>HP USB-C/A Universal Dock G2</p>

Table 1-1 Product components and their descriptions (continued)

Category	Description
	HP Elite USB-C Dock G5
Keyboard/pointing devices	Keyboard
	Full sized Chiclet (island-style) keyboard with separate numeric keypad (backlit and non-backlit)
	Windows 10 dual point (3-pick button pointing stick and 3-pick buttons on touchpad)
	Windows 10 dual point (3-pick button pointing stick and 3-pick buttons on touchpad) – privacy
	Touchpad
	On/off button
	Glass with chemical etched surface
	Supports 2-way scroll, taps enabled by default, image sensor
	Gestures enabled by default: 2-finger scrolling, 2-finger zoom (pinch)
	Image sensor touchpad
	DreamColor calibrator, built in under the touchpad
Power requirements	Battery
	HP Long Life Polymer Soft Pack Battery, 4 cell, 90 Wh, 5.85 Ah
	HP Fast Charge Technology
	AC adapter
	150 W Slim Smart AC Adapter
	Power cord
	2-wire plug (C15), 1.0 m
Security	Security lock
	Trusted Platform Module (TPM) 2.0 (Infineon, soldered down)
	Touch fingerprint sensor (select products only)
	Hardware-enforced firmware protection: HP Hardware Root of Trust + Sure Start Gen 4
	Smart Card reader (active)
	Preboot authentication (password, smart card, fingerprint)
	Drive Encryption preboot option (password, fingerprint, smart card)
Operating system	Preinstalled
	Windows® 10 Home 64 Advanced
	Windows 10 Home 64 Advanced Single Language
	Windows 10 Home 64 High-end Chinese Market CPPP
	Windows 10 Home 64 Plus
	Windows 10 Home 64 Plus Single Language

Table 1-1 Product components and their descriptions (continued)

Category	Description
	Windows 10 Professional 64
	Windows 10 Professional 64 Chinese Market
	Windows 10 Professional 64 High End Chinese Market
	Windows 10 Professional 64 for Workstations Plus
	Windows 10 Professional 64 for Workstations Plus Chinese Market
	FreeDOS 3.0
	Restore Media
	Windows 10 DRDVD, available with any Windows 10 operating system
	Windows 10 Pro 64 OSDVD
	Certified
	Microsoft® WHQL
	Web-only support
	Windows 10 Enterprise 64
	Red Hat™ Linux™ 7
	Red Hat Enterprise Linux 8
	Ubuntu 18.04 LTS
	Drop-in-box
	Red Hat Enterprise
Serviceability	End user replaceable parts
	AC adapter

2 Components

Your computer features top-rated components. This chapter provides details about your components, where they are located, and how they work.

Right

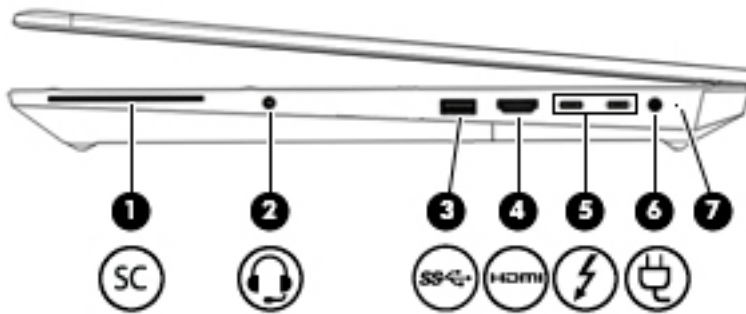

Table 2-1 Right-side components and their descriptions







Component	Description
(1)  Smart card reader	Supports optional smart cards.
(2)  Audio-out (headphone)/Audio-in (microphone) combo jack	Connects optional powered stereo speakers, headphones, earbuds, a headset, or a television audio cable. Also connects an optional headset microphone. This jack does not support optional standalone microphones. WARNING! To reduce the risk of personal injury, adjust the volume before putting on headphones, earbuds, or a headset. For additional safety information, see the <i>Regulatory, Safety, and Environmental Notices</i> . To access this guide: <ul style="list-style-type: none"> Select the Start button, select HP Help and Support, and then select HP Documentation. NOTE: When a device is connected to the jack, the computer speakers are disabled.
(3)  USB SuperSpeed port	Connects a USB device, such as a cell phone, camera, activity tracker, or smartwatch, and provides high-speed data transfer.
(4)  HDMI port	Connects an optional video or audio device, such as a high-definition television, any compatible digital or audio component, or a high-speed High Definition Multimedia Interface (HDMI) device.
(5)  USB Type-C power connector and Thunderbolt™ ports with HP Sleep and Charge (2)	Connect an AC adapter that has a USB Type-C connector, supplying power to the computer and, if needed, charging the computer battery.

Table 2-1 Right-side components and their descriptions (continued)

Component	Description
	<p>– and –</p> <p>Even when the computer is off, connect and charge most USB devices that have a Type-C connector, such as a cell phone, camera, activity tracker, or smartwatch, and provide high-speed data transfer.</p> <p>– and –</p> <p>Connect a display device that has a USB Type-C connector, providing DisplayPort output.</p> <p>NOTE: Your computer may also support a Thunderbolt docking station.</p> <p>NOTE: Cables and/or adapters (purchased separately) may be required.</p>
<p>(6)</p> 	<p>Power connector</p> <p>Connects an AC adapter.</p>
<p>(7)</p>	<p>Battery light</p> <p>When AC power is connected:</p> <ul style="list-style-type: none">• White: The battery charge is greater than 90 percent.• Amber: The battery charge is from 0 to 90 percent.• Off: The battery is not charging. <p>When AC power is disconnected (battery not charging):</p> <ul style="list-style-type: none">• Blinking amber: The battery has reached a low battery level. When the battery has reached a critical battery level, the battery light begins blinking rapidly.• Off: The battery is not charging.

Left

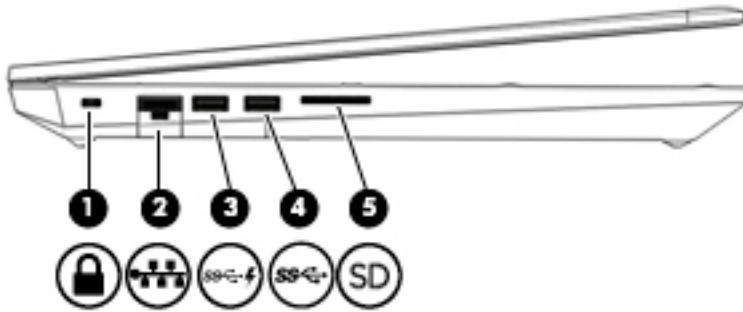







Table 2-2 Left-side components and their descriptions

Component	Description
(1) 	<p>Security cable slot</p> <p>Attaches an optional security cable to the computer.</p> <p>NOTE: The security cable is designed to act as a deterrent, but it may not prevent the computer from being mishandled or stolen.</p>
(2) 	<p>RJ-45 (network) jack/status lights</p> <p>Connects a network cable.</p> <ul style="list-style-type: none"> Green (left): The network is connected. Amber (right): Activity is occurring on the network.
(3) 	<p>USB SuperSpeed port with HP Sleep and Charge</p> <p>Connects a USB device, provides high-speed data transfer, and even when the computer is off, charges most products such as a cell phone, camera, activity tracker, or smartwatch.</p>
(4) 	<p>USB SuperSpeed port</p> <p>Connects a USB device, such as a cell phone, camera, activity tracker, or smartwatch, and provides high-speed data transfer.</p>
(5) 	<p>Memory card reader</p> <p>Reads optional memory cards that store, manage, share, or access information.</p> <p>To insert a card:</p> <ol style="list-style-type: none"> Hold the card label-side up, with the connectors facing the computer. Insert the card into the memory card reader, and then press in on the card until it is firmly seated. <p>To remove a card:</p> <ul style="list-style-type: none"> Press in on the card, and then remove it from the memory card reader.

Display

 **NOTE:** Refer to the illustration that most closely resembles your computer.

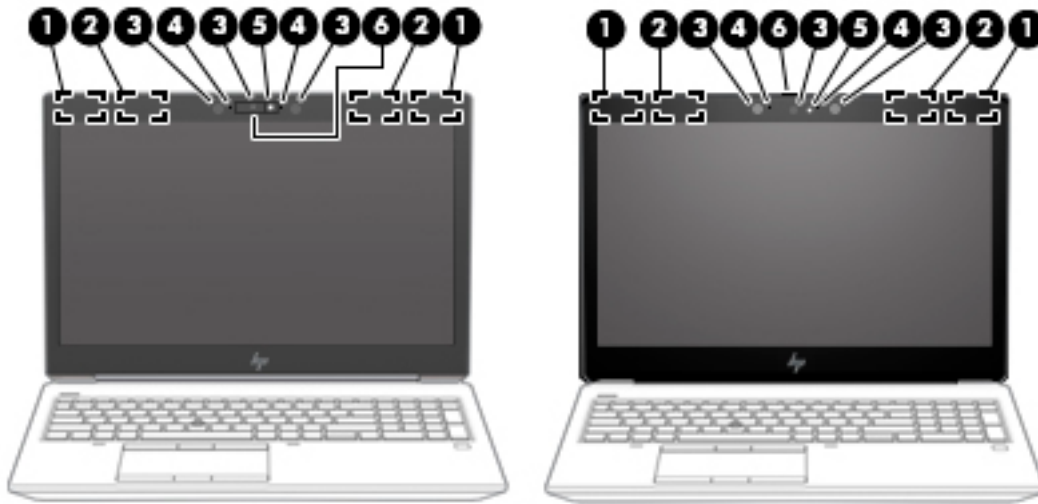

Table 2-3 Display components and their descriptions

Component	Description
(1) WLAN antennas*	Send and receive wireless signals to communicate with wireless local area networks (WLANs).
(2) WWAN antennas*	Send and receive wireless signals to communicate with wireless wide area networks (WWANs).
(3) Camera(s) (select products only)	Allow(s) you to video chat, record video, and record still images. Some cameras also allow a facial recognition logon to Windows, instead of a password logon. NOTE: Camera functions vary depending on the camera hardware and software installed on your product.
(4) Internal microphones (2)	Record sound.
(5) Camera light (select products only)	On: The camera is in use.
(6) Camera privacy cover (select products only)	When closed, the camera privacy cover blocks the camera. <ul style="list-style-type: none"> To unblock the camera, slide the cover to the right. To block the camera, slide the cover to the left.

*The antennas are not visible from the outside of the computer. For optimal transmission, keep the areas immediately around the antennas free from obstructions.

For wireless regulatory notices, see the section of the *Regulatory, Safety, and Environmental Notices* that applies to your country or region.

To access this guide:

- ▲ Select the **Start** button, select **HP Help and Support**, and then select **HP Documentation**.

Keyboard area

Touchpad

Touchpad settings

To adjust touchpad settings and gestures, or to turn off the touchpad:

1. Type `Touchpad settings` in the taskbar search box, and press `enter`.
2. Choose a setting.

To turn on the touchpad:

1. Type `Touchpad settings` in the taskbar search box, and press `enter`.
2. Using an external mouse, click the **Touchpad** button.

– or –

Press the `Tab` key repeatedly until the pointer rests on the **Touchpad** button. Then press the `spacebar` to select the button.

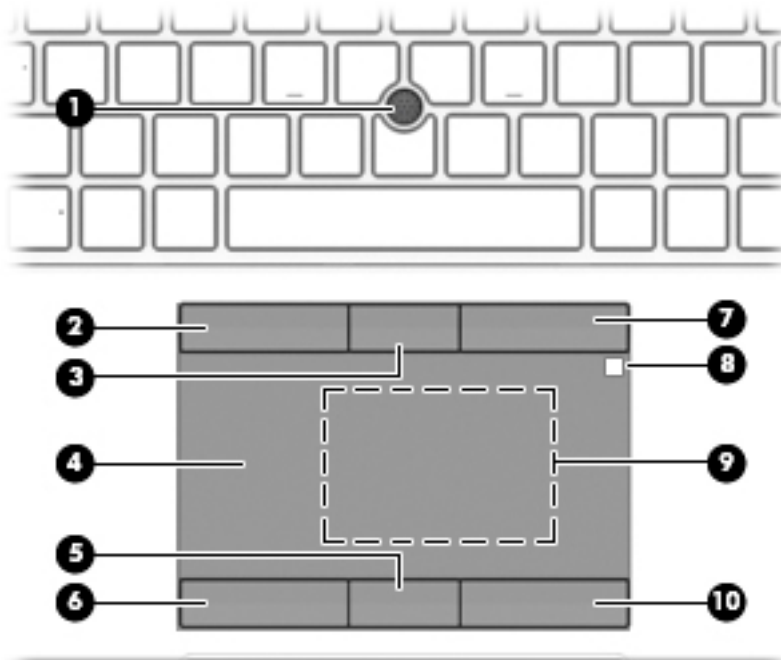

Table 2-4 Touchpad components and their descriptions

Component	Description
(1) Pointing stick	Moves the pointer on the screen.
(2) Left pointing stick button	Functions like the left button on an external mouse.
(3) Center pointing stick button	Functions like the center button on an external mouse.
(4) Touchpad zone	Reads your finger gestures to move the pointer or activate items on the screen.
(5) Center touchpad button	Functions like the center button on an external mouse.
(6) Left touchpad button	Functions like the left button on an external mouse.

Table 2-4 Touchpad components and their descriptions (continued)

Component	Description
(7)	Right pointing stick button Functions like the right button on an external mouse.
(8)	HP DreamColor sensor (select products only) A colorimeter that brings integrated color calibration to your display. This built-in measurement instrument provides the ability to recalibrate a DreamColor color preset without the use of an external measurement instrument. To select a color preset or launch the calibration tool, select the HP DreamColor icon in the Windows taskbar. Make a selection from the menu and follow the on-screen instructions. NOTE: For accurate calibration, keep the sensor window clean and free from obstructions.
(9)	Near Field Communications (NFC) tapping area and antenna* Allows you to wirelessly share information when you tap it with an NFC-enabled device.
(10)	Right Touchpad button Functions like the right button on an external mouse.

*The antenna is not visible from the outside of the computer. For optimal transmission, keep the area immediately around the antenna free from obstructions.

For wireless regulatory notices, see the section of the *Regulatory, Safety, and Environmental Notices* that applies to your country or region.

To access this guide:

- ▲ Select the **Start** button, select **HP Help and Support**, and then select **HP Documentation**.

Lights

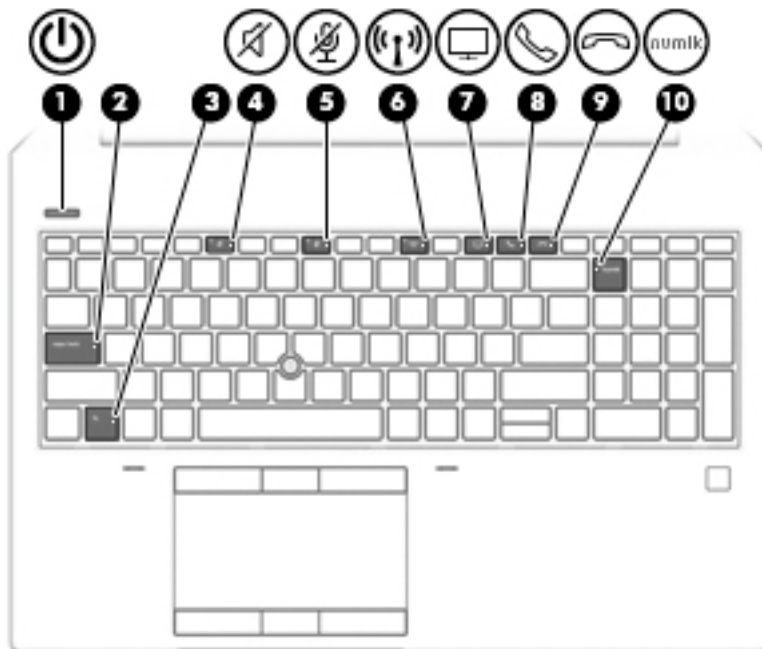









Table 2-5 Lights and their descriptions

Component	Description
(1)  Power light	<ul style="list-style-type: none">• On: The computer is on.• Blinking: The computer is in the Sleep state, a power-saving state. The computer shuts off power to the display and other unneeded components.• Off: The computer is off.
(2) Caps lock light	On: Caps lock is on, which switches the key input to all capital letters.
(3) Fn lock light	On: The fn key is locked. For more information, see Hot keys (select products only) on page 16 .
(4)  Mute light	<ul style="list-style-type: none">• On: Computer sound is off.• Off: Computer sound is on.
(5)  Microphone mute light	<ul style="list-style-type: none">• On: Microphone is off.• Off: Microphone is on.
(6)  Wireless light	On: An integrated wireless device, such as a wireless local area network (WLAN) device and/or a Bluetooth® device, is on. NOTE: On some models, the wireless light is amber when all wireless devices are off.
(7)  Sharing or presenting light	On: Sharing is on.
(8)  Call answer light	On: Call answer is on.
(9)  Call end light	On: Call end is on.
(10)  Num lk light	On: Num lock is on.

Button, speakers, and fingerprint reader

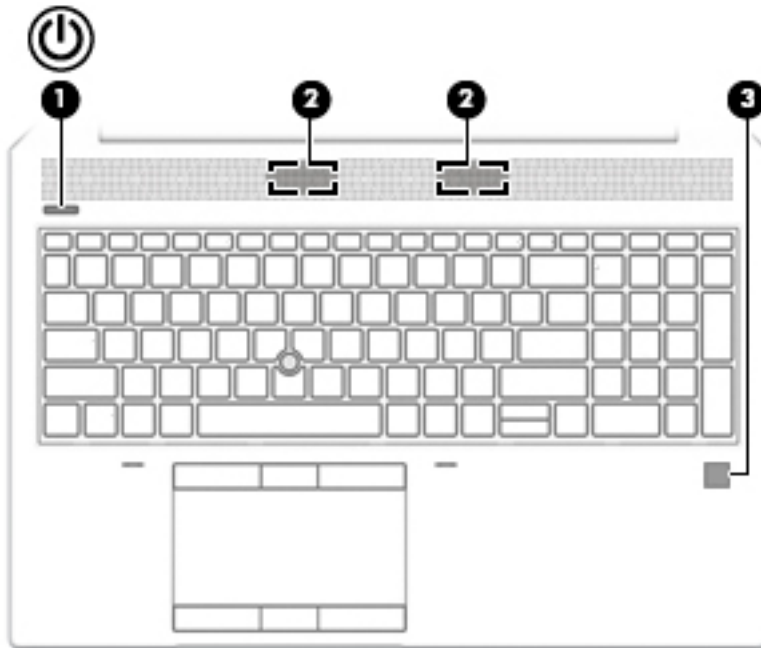



Table 2-6 Button, speakers, and fingerprint reader and their descriptions

Component	Description
<p>(1)  Power button</p>	<ul style="list-style-type: none"> • When the computer is off, press the button to turn on the computer. • When the computer is on, press the button briefly to initiate Sleep. • When the computer is in the Sleep state, press the button briefly to exit Sleep (select products only). <p>IMPORTANT: Pressing and holding down the power button results in the loss of unsaved information.</p> <p>If the computer has stopped responding and shutdown procedures are ineffective, press and hold the power button for at least 5 seconds to turn off the computer.</p> <p>To learn more about your power settings, see your power options.</p> <p>▲ Right-click the Power meter icon  and then select Power Options.</p>
(2) Speakers (2)	Produce sound.
(3) Fingerprint reader (select products only)	<p>Allows a fingerprint logon to Windows, instead of a password logon.</p> <p>▲ Touch your finger to the fingerprint reader.</p> <p>IMPORTANT: To prevent fingerprint logon issues, make sure when you register your fingerprint that all sides of your finger are registered by the fingerprint reader.</p> <p>IMPORTANT: To verify that your computer has a fingerprint reader, type <i>Sign-in options</i> in the taskbar search box and follow the on-screen instructions. If <i>Fingerprint reader</i> is listed as an option, then your computer includes a fingerprint reader.</p>

Shortcut keys

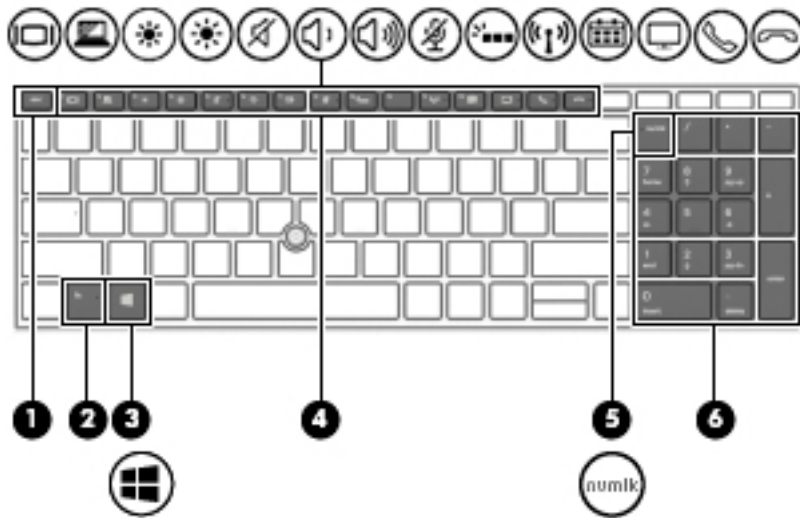



Table 2-7 Shortcut keys and their descriptions

Component	Description
(1) esc key	Displays system information when pressed in combination with the fn key.
(2) fn key	Executes frequently used system functions when pressed in combination with another key. Such key combinations are called <i>hot keys</i> . See Hot keys (select products only) on page 16 .
(3)  Windows key	Opens the Start menu. NOTE: Pressing the Windows key again closes the Start menu.
(4) Icon keys	Execute frequently used system functions.
(5) num lk key	Alternates between the navigational and numeric functions on the integrated numeric keypad.
(6) Integrated numeric keypad	A separate keypad to the right of the alphabet keyboard. When num lk is pressed, the integrated keypad can be used like an external numeric keypad. NOTE: If the keypad function is active when the computer is turned off, that function is reinstated when the computer is turned back on.

Hot keys (select products only)

A hot key is the combination of the **fn** key and another key.

To use a hot key:

- ▲ Press the **fn** key, and then press one of the keys listed in the following table.

Table 2-8 Hot keys and their descriptions

Key	Description
C	Turns on scroll lock.
E	Turns on the insert function.
R	Breaks the operation.
S	Sends a programming query.
W	Pauses the operation.

Cover



Table 2-9 Cover components and their descriptions

Component	Description
Internal Microphones (2)	Record sound.

Bottom

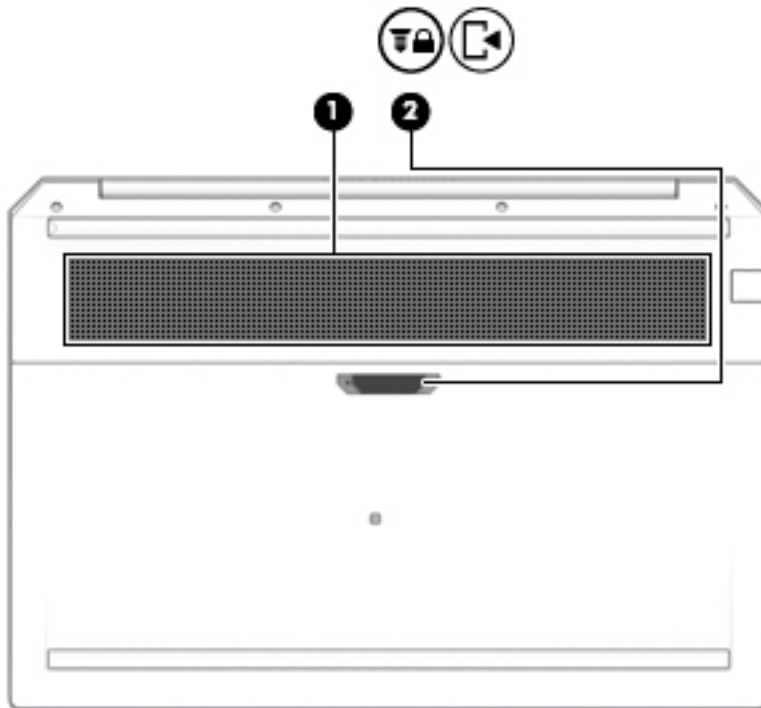





Table 2-10 Bottom components and their descriptions

Component	Vent	Description
(1)	Vent	Enables airflow to cool internal components. NOTE: The computer fan starts up automatically to cool internal components and prevent overheating. It is normal for the internal fan to cycle on and off during routine operation.
(2)	  Service door release latch and security screw	Releases the service door after you remove the security screw.

Labels

The labels affixed to the computer provide information you may need when you troubleshoot system problems or travel internationally with the computer. Labels may be in paper form or imprinted on the product.

 **IMPORTANT:** Check the following locations for the labels described in this section: the bottom of the computer, inside the battery bay, under the service door, on the back of the display, or on the bottom of a tablet kickstand.

- Service label—Provides important information to identify your computer. When contacting support, you may be asked for the serial number, the product number, or the model number. Locate this information before you contact support.

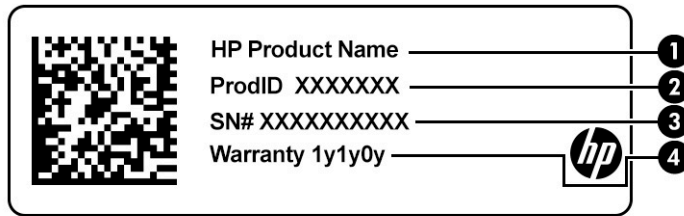

Table 2-11 Service label components

Component
(1) HP product name
(2) Product ID
(3) Serial number
(4) Warranty period

- Regulatory label(s)—Provide(s) regulatory information about the computer.
- Wireless certification label(s)—Provide(s) information about optional wireless devices and the approval markings for the countries or regions in which the devices have been approved for use.

3 Illustrated parts catalog

Computer major components

 **NOTE:** HP continually improves and changes product parts. For complete and current information on supported parts for your computer, go to <http://partsurfer.hp.com>, select your country or region, and then follow the on-screen instructions.

 **NOTE:** Details about your computer, including model, serial number, product key, and length of warranty, are on the service tag at the bottom of your computer. See [Labels on page 18](#) for details.

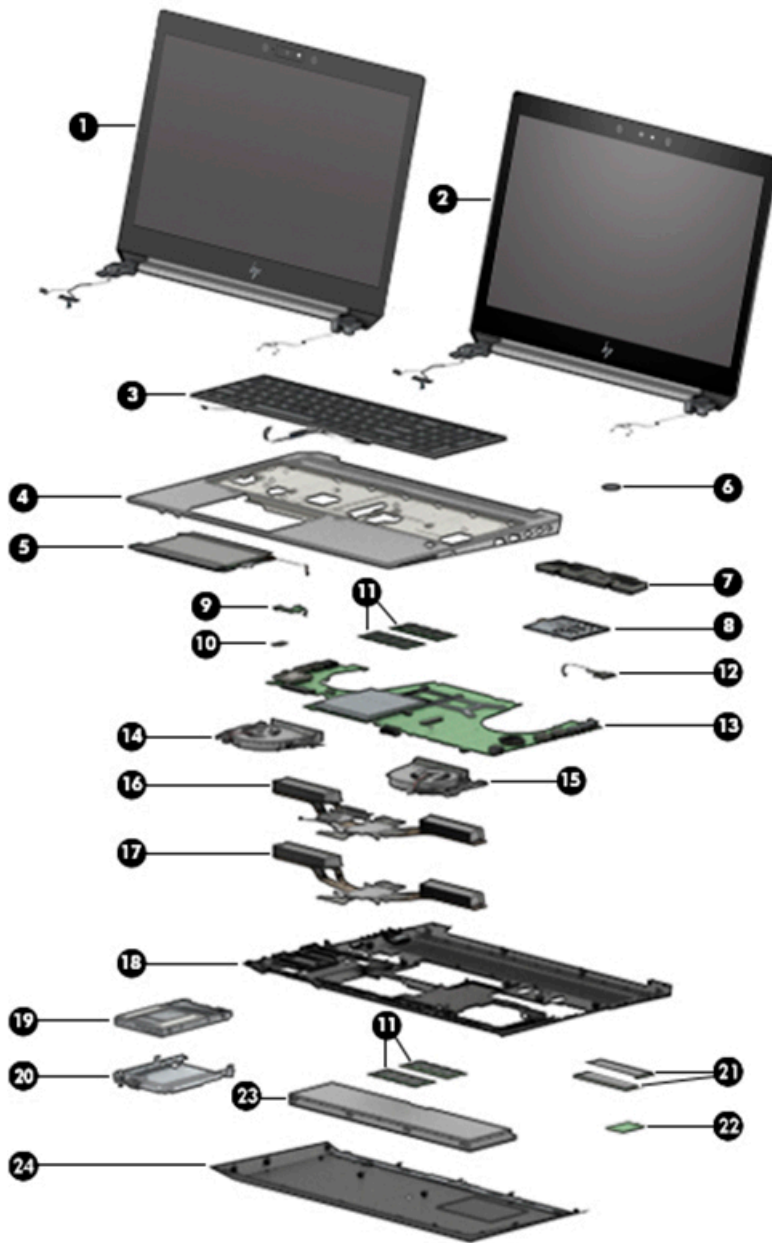

Table 3-1 Computer major components and their descriptions

Item	Component	Spare part number
(1)	Display assembly (touch screen; UHD; UWVA)	not available
(2)	Display assembly (DreamColor, non-touch; UHD, UWVA) For more display assembly spare part information, see Display assembly subcomponents on page 22 .	
	DreamColor, non-touch, UHD, UWVA	L68847-001
	DreamColor, non-touch, UHD, UWVA, with IR camera	L76718-001
(3)	Keyboard (backlit; includes keyboard, backlight, and pointing stick cables) For a list of keyboard country codes, see Keyboard on page 43 .	
	For use with non-privacy screens	L28407-xx1
	For use with privacy screens	L29635-xx1
(4)	Top cover (includes touchpad)	L68835-001
(5)	Touchpad module (includes protective shielding tape) The touchpad module cable is available in the Cable Kit using spare part number L68854-001.	
	Touchpad module	L30663-001
	DreamColor touchpad module	L28745-001
(6)	RTC battery	not available
(7)	Speaker Kit (includes cable)	L28719-001
(8)	Smart card reader	not available
(9)	Fingerprint reader board The fingerprint reader bracket is available in the Bracket Kit, spare part number L68842-001. The fingerprint reader cable is available in the Cable Kit, spare part number L68854-001.	L67969-001
(10)	NFC module The NFC cable is available in the Cable Kit, spare part number L68854-001.	L02249-001
(11)	Memory module (2666 MHz, DDR4) For use in models with Intel Core and Intel Xeon processors	
	• 32 GB	L50384-001
	• 16 GB	937438-850
	• 8 GB	937236-850
	• 4 GB	L10598-850
	For use in models with Intel Xeon processors	
	• 16 GB	L24981-001
	• 8 GB	L24983-001
(12)	Power button board (includes cable)	L68834-001
(13)	System board (includes integrated processor and replacement thermal material)	

Table 3-1 Computer major components and their descriptions (continued)

Item	Component	Spare part number
	All system boards use the following part numbers: xxxxxx-001: non-Windows operating systems xxxxxx-601: Windows 10 operating system	
	System board equipped with an Intel Xeon E-2286M processor and NVIDIA Quadro RTX 3000 graphics	L68831-xx1
	System board equipped with an Intel Xeon E-2286M processor and NVIDIA Quadro T1000 graphics	L68826-xx1
	System board equipped with an Intel Xeon E-2286M processor and NVIDIA Quadro T2000 graphics	L68830-xx1
	System board equipped with an Intel Core i9-9880H processor and NVIDIA Quadro RTX 3000 graphics	L68833-xx1
	System board equipped with an Intel Core i9-9880H processor and NVIDIA Quadro T2000 graphics	L68829-xx1
	System board equipped with an Intel Core i9-9880H processor and NVIDIA Quadro T1000 graphics	L68825-xx1
	System board equipped with an Intel Core i7-9850H processor and NVIDIA Quadro RTX 3000 graphics	L68832-xx1
	System board equipped with an Intel Core i7-9850H processor and NVIDIA Quadro T2000 graphics	L68828-xx1
	System board equipped with an Intel Core i7-9850H processor and NVIDIA Quadro T1000 graphics	L68824-xx1
	System board equipped with an Intel Core i7-9750H processor	L68823-xx1
	System board equipped with an Intel Core i5-9400H processor and NVIDIA Quadro T2000 graphics	L68827-xx1
	System board equipped with an Intel Core i5-9400H processor and NVIDIA Quadro T1000 graphics	L68822-xx1
	System board equipped with an Intel Core i5-9300H processor	L68821-xx1
(14)	Fan (for use in models with NVIDIA Quadro T2000 or T1000 graphics)	L68840-001
(15)	Fan (for use in models with NVIDIA Quadro RTX 3000 graphics)	L68841-001
(16)	Heat sink assembly , discrete graphics (includes thermal replacement material)	
	For use in models with NVIDIA Quadro T2000 or T1000 graphics	L68856-001
	For use in models with NVIDIA Quadro RTX 3000 graphics	L68857-001
(17)	Heat sink assembly , UMA graphics (includes thermal replacement material)	L68855-001
(18)	Bottom cover	L68838-001
(19)	Hard drive (does not include drive bracket or screws) For more hard drive spare part information, see Mass storage devices on page 26 .	
(20)	Hard drive bracket The hard drive bracket is available in the Bracket Kit using spare part number L68842-001.	
(21)	Solid-state drive For more solid-state drive spare part information, see Mass storage devices on page 26 .	
(22)	WWAN module	
	HP lt4120 LTE/HSPA+ w/GPS M.2	L15398-001
(23)	Battery	L05766-850
(24)	Service door	L28746-001

Display assembly subcomponents

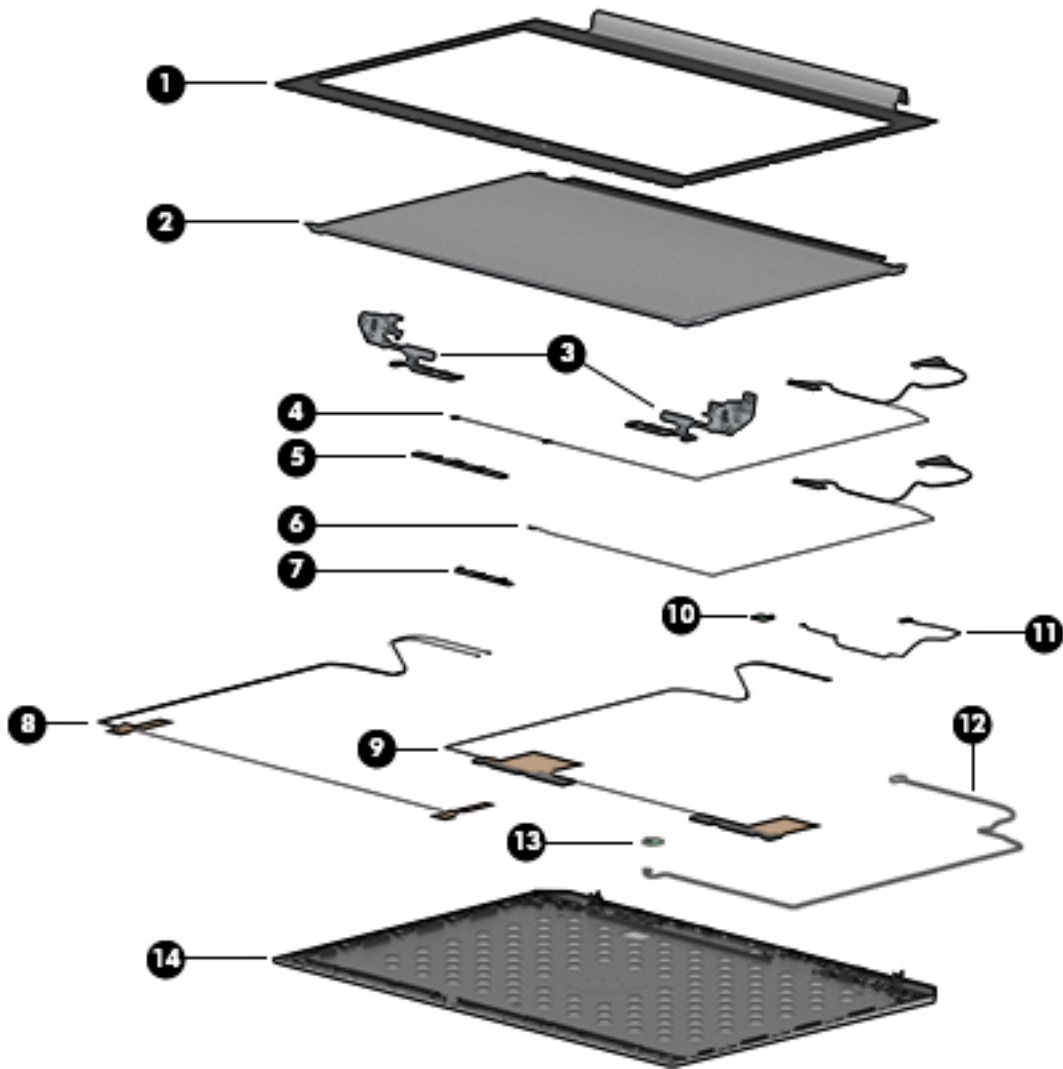

Table 3-2 Display components and their descriptions

Item	Component	Spare part number
(1)	Display bezel	
	For use in models with a IR camera and transparent camera privacy cover	L68869-001
	For use in models with a IR camera and black camera privacy cover	L68870-001
	For use in models with an RGB camera and transparent camera privacy cover	L68871-001
	For use in models with an RGB camera and black camera privacy cover	L68872-001
	For use in models without a camera and a transparent camera privacy cover	L70633-001
	For use in models without a camera and a black camera privacy cover	L70634-001
(2)	Display panel (includes cables and bezel adhesive)	
	Non-touch, FHD, 250 nits	L68848-001

Table 3-2 Display components and their descriptions (continued)

Item	Component	Spare part number
	Non-touch, FHD, 400 nits	L68849-001
	Non-touch, FHD, 1000 nits	L68850-001
	Non-touch, UHD, 400 nits	L68851-001
	Touch screen, privacy	L68845-001
	Touch screen, non-privacy	L68846-001
(3)	Display hinges (includes left and right hinges)	
	For use in non-touch screen models	L28703-001
	For use in touch screen models	L77464-001
(4)	Display/IR camera cable	L68873-001
(5)	FHD/IR camera module	L68852-001
	The camera privacy cover is available as spare part number L70637-001.	
(6)	Display/camera cable	
	For use in non-touch screen models	L68873-001
	For use in touch screen models	L77463-001
(7)	HD camera module	L68853-001
	Microphone module (includes bezel adhesive)	L28743-001
(8)	WLAN antenna	L28740-001
(9)	WWAN antenna	L28740-001
(10)	Color board	L70635-001
(11)	Color board cable (Cable Kit)	L68854-001
(12)	Ambient light sensor cable (Cable Kit)	L68854-001
(13)	Ambient light sensor board	L70635-001
(14)	Back cover (includes bezel adhesive)	
	For use with FHD panels	L28702-001
	For use with UHD panels	L34481-001
	For use with touch panels	L68844-001
	For use with privacy panels	L78818-001

Bracket Kit

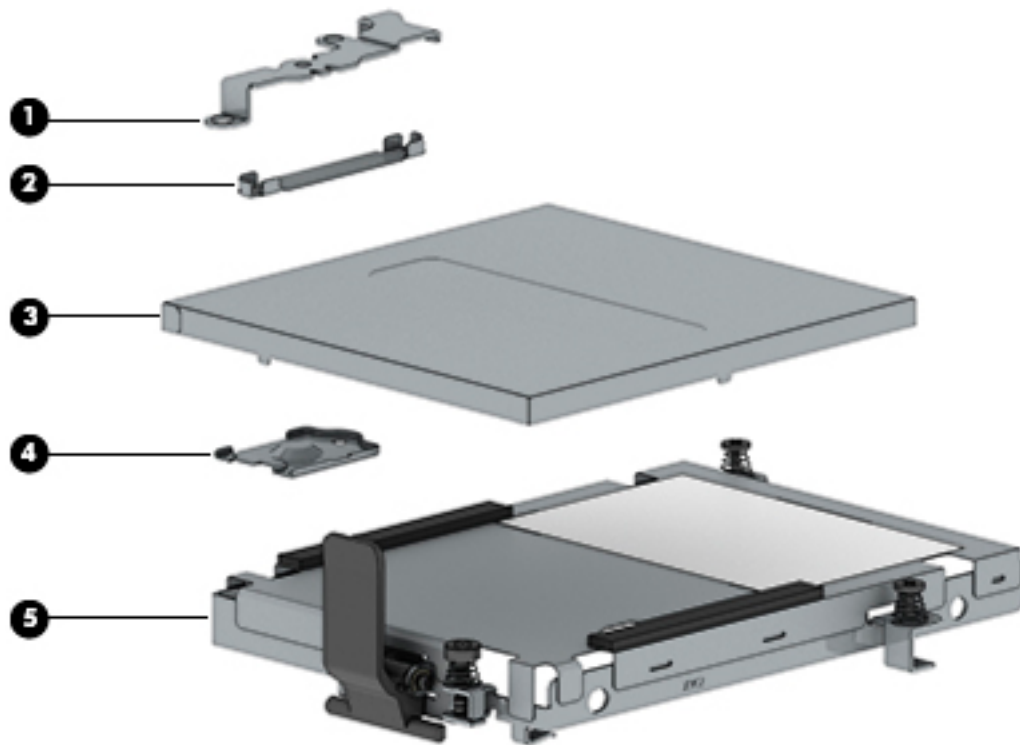

Table 3-3 Bracket components and their descriptions

Item	Component	Spare part number
	Bracket Kit , includes the following parts:	L68842-001
(1)	USB Type-C bracket	
(2)	EDP bracket (display cable bracket)	
(3)	Memory cage shield	
(4)	Fingerprint reader bracket	
(5)	Hard drive bracket	
	Memory top shield (not illustrated)	
	Display bracket kit (LG) (not illustrated)	
	Display bracket kit (IVO) (not illustrated)	

Cable Kit

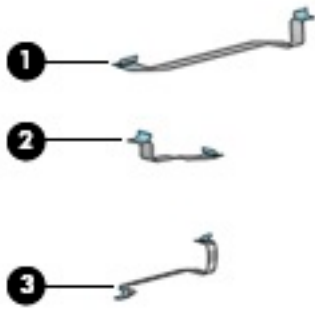

Table 3-4 Cable Kit components and their descriptions

Item	Component	Spare part number
	Cable Kit , includes the following parts:	L68854-001
(1)	Touchpad cable Touchpad connector protective shielding tape (not illustrated)	
(2)	NFC cable	
(3)	Fingerprint reader cable Power board cable (not illustrated) Ambient light sensor board cable (not illustrated) Color board cable (not illustrated)	

Plastics Kit

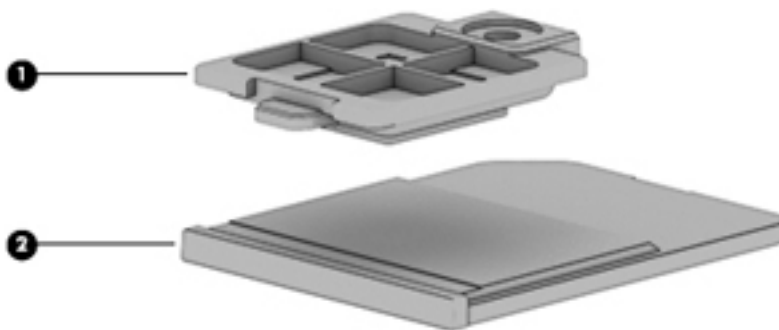

Table 3-5 Plastics Kit components and their descriptions

Item	Component	Spare part number
	Plastics Kit , includes the following parts:	L28722-001
(1)	SD card blank	
(2)	Fingerprint reader blank	

Mass storage devices

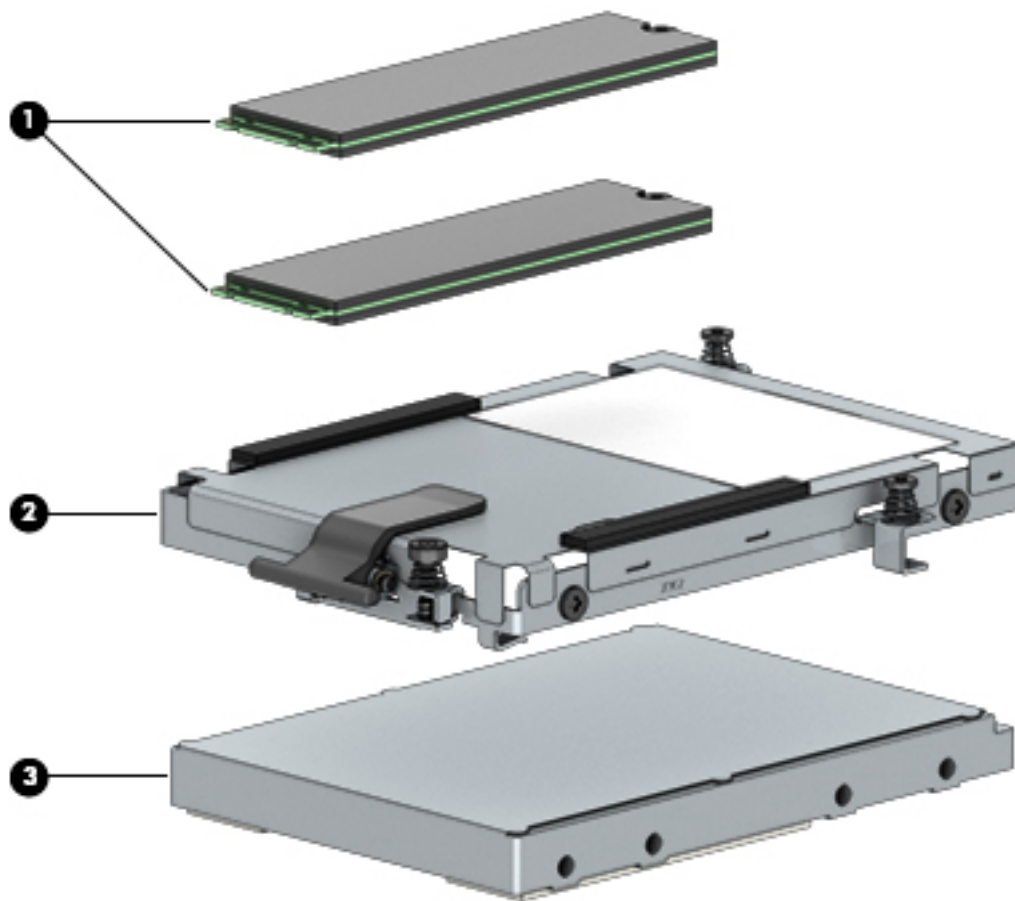

Table 3-6 Mass storage devices and their descriptions

Item	Component	Spare part number
(1)	Solid-state drive, M.2	
	2 TB, PCIe, NVMe TLC	L68864-001
	1 TB, PCIe, NVMe TLC	L68863-001
	1 TB, SATA-3, TLC	L68868-001
	512 GB, PCIe, NVMe TLC	L68862-001
	512 GB, PCIe, NVMe, SED, Opal 2, TLC	L68865-001
	512 GB, SATA-3, FIPS, TLC	L68860-001
	256 GB, PCIe, NVMe, TLC	L68861-001
	256 GB, SATA-3, TLC	L68867-001
	118 GB Optane memory module	L68866-001
	16 GB Optane memory module	L68859-001
(2)	Hard drive bracket , available in the Bracket Kit	L68842-001

Table 3-6 Mass storage devices and their descriptions (continued)

Item	Component	Spare part number
(3)	Hard drive/solid-state drive, 2.5 inch (does not include drive bracket or screws)	
	2 TB, 5400 rpm	912487-850
	1 TB, 7200 rpm	766644-001
	500 GB, 7200 rpm, self-encrypting drive (FIPS-140-2)	820572-001

Miscellaneous parts

Table 3-7 Miscellaneous parts and their descriptions

Component	Spare part number
AC adapter (150 W, HP Smart adapter, slim, 4.5 mm)	L32661-001
Power cord (C5, 1.0 m)	
For use in Argentina	920689-003
For use in Australia	L30769-001
For use in Brazil	L30770-001
For use in Denmark	L30771-001
For use in Europe	L30772-001
For use in India	920689-016
For use in Israel	L30773-001
For use in Italy	L30774-001
For use in Japan	L30775-001
For use in North America	920689-001
For use in the People's Republic of China	920689-014
For use in South Korea	L30776-001
For use in Switzerland	L30778-001
For use in Taiwan	L30780-001
For use in Thailand	L30779-001
For use in the United Kingdom	L30781-001
Camera privacy cover (for models with an IR camera)	L70637-001
Protective tape kit (includes tape for the WWAN card, WLAN card, and power board)	L33679-001
HP DreamColor Board (includes cable)	L70636-001
Screw Kit	L68858-001

4 Removal and replacement procedures preliminary requirements

Tools required

You will need the following tools to complete the removal and replacement procedures:

- Non-conductive, non-marking pry tool
- Magnetic Phillips P1 screwdriver
- Torx T5 screwdriver

Service considerations

The following sections include some of the considerations that you must keep in mind during disassembly and assembly procedures.



NOTE: As you remove each subassembly from the computer, place the subassembly (and all accompanying screws) away from the work area to prevent damage.

Plastic parts



IMPORTANT: Using excessive force during disassembly and reassembly can damage plastic parts.

Cables and connectors



IMPORTANT: When servicing the computer, be sure that cables are placed in their proper locations during the reassembly process. Improper cable placement can damage the computer.

Cables must be handled with extreme care to avoid damage. Apply only the tension required to unseat or seat the cables during removal and insertion. Handle cables by the connector whenever possible. In all cases, avoid bending, twisting, or tearing cables. Be sure that cables are routed in such a way that they cannot be caught or snagged by parts being removed or replaced. Handle flex cables with extreme care; these cables tear easily.

Drive handling



IMPORTANT: Drives are fragile components that must be handled with care. To prevent damage to the computer, damage to a drive, or loss of information, observe these precautions:

Before removing or inserting a hard drive, shut down the computer. If you are unsure whether the computer is off or in Hibernation, turn the computer on, and then shut it down through the operating system.

Before handling a drive, be sure that you are discharged of static electricity. While handling a drive, avoid touching the connector.

Before removing an optical drive, be sure that a disc is not in the drive and be sure that the optical drive tray is closed.

Handle drives on surfaces covered with at least 2.54 cm (1 inch) of shock-proof foam.

Avoid dropping drives from any height onto any surface.

After removing a hard drive or an optical drive, place it in a static-proof bag.

Avoid exposing an internal hard drive to products that have magnetic fields, such as monitors or speakers.

Avoid exposing a drive to temperature extremes or liquids.

If a drive must be mailed, place the drive in a bubble pack mailer or other suitable form of protective packaging and label the package “FRAGILE.”

Workstation guidelines

Follow these grounding workstation guidelines:

- Cover the workstation with approved static-shielding material.
- Use a wrist strap connected to a properly grounded work surface and use properly grounded tools and equipment.
- Use conductive field service tools, such as cutters, screw drivers, and vacuums.
- When fixtures must directly contact dissipative surfaces, use fixtures made only of static-safe materials.
- Keep the work area free of nonconductive materials, such as ordinary plastic assembly aids and polystyrene foam.
- Handle ESD-sensitive components, parts, and assemblies by the case or PCM laminate. Handle these items only at static-free workstations.
- Avoid contact with pins, leads, or circuitry.
- Turn off power and input signals before inserting or removing connectors or test equipment.

Electrostatic discharge information

A sudden discharge of static electricity from your finger or other conductor can destroy static-sensitive devices or microcircuitry. Often the spark is neither felt nor heard, but damage occurs. An electronic device exposed to electrostatic discharge (ESD) might not appear to be affected at all and can work perfectly throughout a normal cycle. The device might function normally for a while, but it has been degraded in the internal layers, reducing its life expectancy.

Networks built into many integrated circuits provide some protection, but in many cases, the discharge contains enough power to alter device parameters or melt silicon junctions.



IMPORTANT: To prevent damage to the device when you are removing or installing internal components, observe these precautions:

Keep components in their electrostatic-safe containers until you are ready to install them.

Before touching an electronic component, discharge static electricity by using the guidelines described in this section.

Avoid touching pins, leads, and circuitry. Handle electronic components as little as possible.

If you remove a component, place it in an electrostatic-safe container.

Generating static electricity

Note the following:

- Different activities generate different amounts of static electricity.
- Static electricity increases as humidity decreases.

Table 4-1 Static electricity occurrence based on activity and humidity

Event	Relative humidity		
	55%	40%	10%
Walking across carpet	7,500 V	15,000 V	35,000 V
Walking across vinyl floor	3,000 V	5,000 V	12,000 V
Motions of bench worker	400 V	800 V	6,000 V
Removing DIPs (dual in-line packages) from plastic tube	400 V	700 V	2,000 V
Removing DIPs from vinyl tray	2,000 V	4,000 V	11,500 V
Removing DIPs from polystyrene foam	3,500 V	5,000 V	14,500 V
Removing bubble pack from PCB (printed circuit board)	7,000 V	20,000 V	26,500 V
Packing PCBs in foam-lined box	5,000 V	11,000 V	21,000 V

Multiple electric components can be packaged together in plastic tubes, trays, or polystyrene foam.



NOTE: As little as 700 V can degrade a product.

Preventing electrostatic damage to equipment

Many electronic components are sensitive to ESD. Circuitry design and structure determine the degree of sensitivity. The following packaging and grounding precautions are necessary to prevent static electricity damage to electronic components.

- To avoid hand contact, transport products in static-safe containers such as tubes, bags, or boxes.
- Protect all electrostatic parts and assemblies with conductive or approved containers or packaging.
- Keep electrostatic-sensitive parts in their containers until they arrive at static-free stations.
- Place items on a grounded surface before removing them from their container.
- Always be properly grounded when touching a sensitive component or assembly.

- Avoid contact with pins, leads, or circuitry.
- Place reusable electrostatic-sensitive parts from assemblies in protective packaging or conductive foam.

Personal grounding methods and equipment

Use the following equipment to prevent static electricity damage to electronic components:

- **Wrist straps** are flexible straps with a maximum of $1\text{ M}\Omega \pm 10\%$ resistance in the ground cords. To provide proper ground, a strap must be worn snug against bare skin. The ground cord must be connected and fit snugly into the banana plug connector on the grounding mat or workstation.
- **Heel straps/Toe straps/Boot straps** can be used at standing workstations and are compatible with most types of shoes or boots. On conductive floors or dissipative floor mats, use them on both feet with a maximum of $1\text{ M}\Omega \pm 10\%$ resistance between the operator and ground.

Table 4-2 Static shielding protection levels

Static shielding protection levels	
Method	Voltage
Antistatic plastic	1,500
Carbon-loaded plastic	7,500
Metallized laminate	15,000

Grounding the work area

To prevent static damage at the work area, use the following precautions:

- Cover the work surface with approved static-dissipative material. Provide a wrist strap connected to the work surface and properly grounded tools and equipment.
- Use static-dissipative mats, foot straps, or air ionizers to give added protection.
- Handle electrostatic sensitive components, parts, and assemblies by the case or PCB laminate. Handle them only at static-free work areas.
- Turn off power and input signals before inserting and removing connectors or test equipment.
- Use fixtures made of static-safe materials when fixtures must directly contact dissipative surfaces.
- Keep work area free of nonconductive materials such as ordinary plastic assembly aids and polystyrene foam.
- Use field service tools, such as cutters, screwdrivers, and vacuums, that are conductive.

Recommended materials and equipment

HP recommends the following materials and equipment to prevent static electricity:

- Antistatic tape
- Antistatic smocks, aprons, or sleeve protectors
- Conductive bins and other assembly or soldering aids
- Conductive foam
- Conductive tabletop workstations with ground cord of $1\text{ M}\Omega \pm 10\%$ resistance

- Static-dissipative table or floor mats with hard tie to ground
- Field service kits
- Static awareness labels
- Wrist straps and footwear straps providing $1\text{ M}\Omega \pm 10\%$ resistance
- Material handling packages
- Conductive plastic bags
- Conductive plastic tubes
- Conductive tote boxes
- Opaque shielding bags
- Transparent metallized shielding bags
- Transparent shielding tubes

Packaging and transporting guidelines

Follow these grounding guidelines when packaging and transporting equipment:

- To avoid hand contact, transport products in static-safe tubes, bags, or boxes.
- Protect ESD-sensitive parts and assemblies with conductive or approved containers or packaging.
- Keep ESD-sensitive parts in their containers until the parts arrive at static-free workstations.
- Place items on a grounded surface before removing items from their containers.
- Always be properly grounded when touching a component or assembly.
- Store reusable ESD-sensitive parts from assemblies in protective packaging or nonconductive foam.
- Use transporters and conveyors made of antistatic belts and roller bushings. Be sure that mechanized equipment used for moving materials is wired to ground and that proper materials are selected to avoid static charging. When grounding is not possible, use an ionizer to dissipate electric charges.

5 Removal and replacement procedures for Customer Self-Repair parts

 **NOTE:** The Customer Self-Repair program is not available in all locations. Installing a part not supported by the Customer Self-Repair program may void your warranty. Check your warranty to determine if Customer Self-Repair is supported in your location.

Component replacement procedures

 **NOTE:** Please read and follow the procedures described here to access and replace Customer Self-Repair parts successfully.

 **NOTE:** Details about your computer, including model, serial number, product key, and length of warranty, are on the service tag at the bottom of your computer. See Service tag on page 16 for details.

This chapter provides removal and replacement procedures for Customer Self-Repair parts.

There are as many as 12 screws that must be removed, replaced, and/or loosened when servicing Customer Self-Repair parts. Make special note of each screw size and location during removal and replacement.

Preparation for disassembly

See [Removal and replacement procedures preliminary requirements on page 28](#) for initial safety procedures.

1. Turn off the computer. If you are unsure whether the computer is off or in Hibernation, turn the computer on, and then shut it down through the operating system.
2. Disconnect the power from the computer by unplugging the power cord from the computer.
3. Disconnect all external devices from the computer.

Service door

Table 5-1 Service door description and part number

Description	Spare part number
Service door	L28746-001

Before removing the service door, follow this step:

- ▲ Prepare the computer for disassembly ([Preparation for disassembly on page 33](#)).

Remove the service door:

1. Slide the service door latch to the right **(1)**.
2. If there is a security screw present, remove it **(2)**.
3. Slide the service door away from the computer until it unlatches **(3)**.

4. Lift the service door away from the computer to remove it (4).

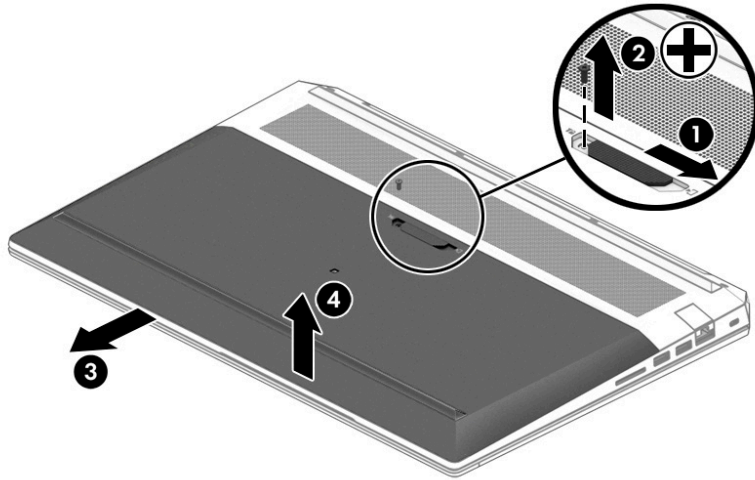

Reverse this procedure to install the service door.

Battery

Table 5-2 Battery description and part number

Description	Spare part number
4-cell, 90 Wh battery	L05766-850

Before removing the battery, follow these steps:

1. Prepare the computer for disassembly ([Preparation for disassembly on page 33](#)).
2. Remove the service door (see [Service door on page 33](#)).

Remove the battery:

WARNING! To reduce potential safety issues, use only the user-replaceable battery provided with the computer, a replacement battery provided by HP, or a compatible battery purchased from HP.

IMPORTANT: Removing a user-replaceable battery that is the sole power source for the computer can cause loss of information. To prevent loss of information, save your work or shut down the computer through Windows before removing the battery.

1. Slide the left latch to the left **(1)**.
2. Slide the right latch to the left **(2)** that secure the battery to the computer.
3. Lift by the tab and remove the battery from the computer **(3)**.

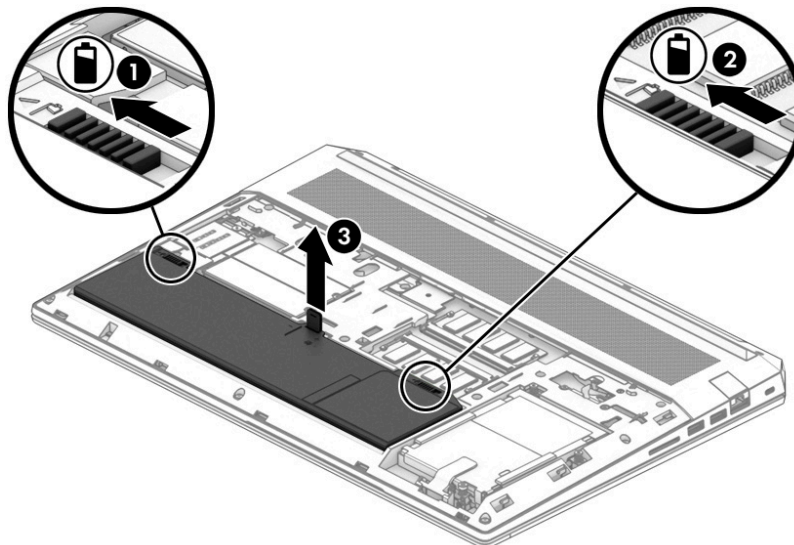

Reverse this procedure to install the battery.

Solid-state drives (M.2)

Table 5-3 Solid-state drive descriptions and part numbers

Description	Spare part number
2 TB, PCIe, NVMe TLC	L68864-001
1 TB, PCIe, NVMe TLC	L68863-001
1 TB, SATA-3, TLC	L68868-001
512 GB, PCIe, NVMe TLC	L68862-001
512 GB, PCIe, NVMe, SED, Opal 2, TLC	L68865-001
512 GB, SATA-3, FIPS, TLC	L68860-001
256 GB, PCIe, NVMe, TLC	L68861-001
256 GB, SATA-3, TLC	L68867-001
118 GB Optane memory module	L68866-001
16 GB Optane memory module	L68859-001

Before removing the solid-state drives, follow these steps:

1. Prepare the computer for disassembly ([Preparation for disassembly on page 33](#)).
2. Remove the service door (see [Service door on page 33](#)).
3. Disconnect the battery (see [Battery on page 35](#)).

Remove the solid-state drives:

1. Remove the Phillips M2.0 × 3.5 screw **(1)** that secures the solid-state drive to the system board.
2. Remove the solid-state drive **(2)** by pulling the drive away from the slot at an angle.

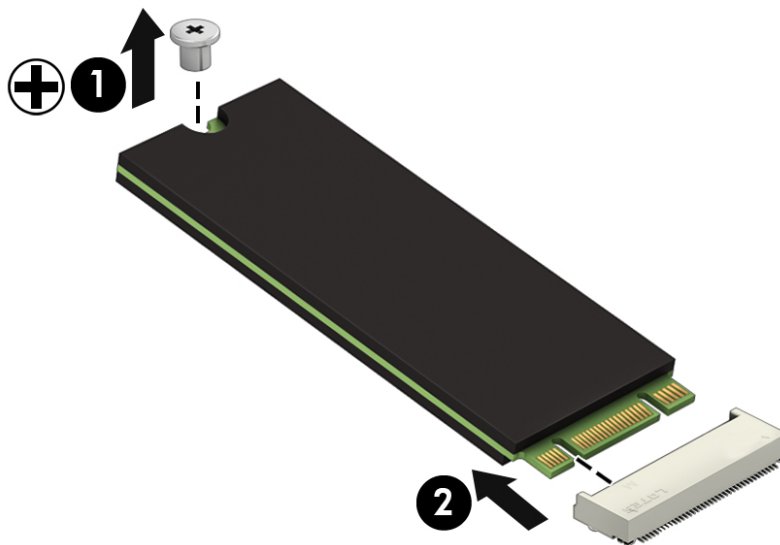

Reverse this procedure to install the solid-state drives.

Hard drive



NOTE: The hard drive spare part kit does not include the hard drive bracket or screws. These components are included in the Hard Drive Hardware Kit, spare part number L68842-001.

Table 5-4 Hard drive descriptions and part numbers

Description	Spare part number
Hard drive/solid-state drive (2.5 in)	
2 TB, 5400 rpm	912487-850
1 TB, 7200 rpm	766644-001
500 GB, 7200 rpm, self-encrypting drive (FIPS-140-2)	820572-001

Before removing the hard drive, follow these steps:

1. Prepare the computer for disassembly ([Preparation for disassembly on page 33](#)).
2. Remove the service door (see [Service door on page 33](#)).
3. Disconnect the battery (see [Battery on page 35](#)).

Remove the hard drive:

1. Loosen the three captive screws (1).
2. Lift the quick release tab (2), and then remove the hard drive from the computer (3).

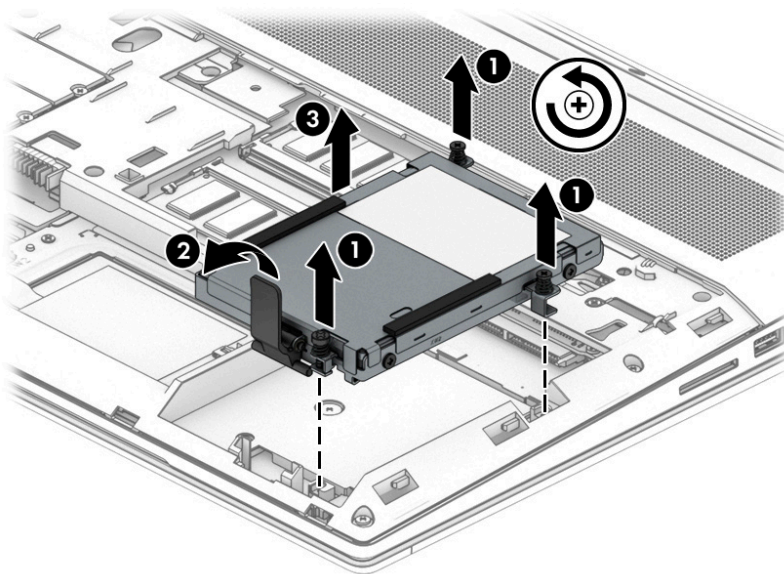

3. If it is necessary to disassemble the hard drive, perform the following steps:
 - a. Remove the four Phillips M3.0 × 3.0 screws (1) that secure the hard drive bracket to the hard drive.
 - b. Remove the hard drive bracket from the hard drive (2).

The hard drive bracket and screws are available in the Hard Drive Hardware Kit, spare part number L68842-001.

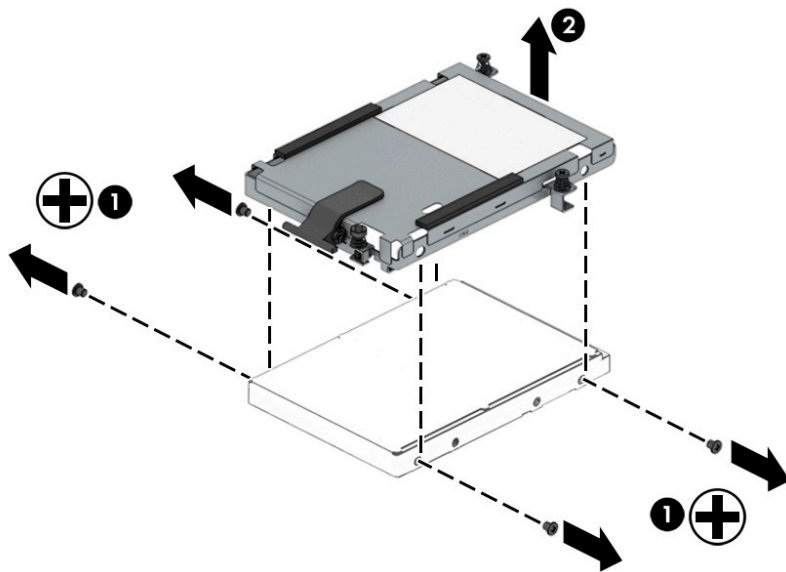

Reverse this procedure to install the hard drive.

WWAN module

Table 5-5 WWAN module descriptions and part numbers

Description	Spare part number
HP lt41 20 LTE/HSPA+ w/GPS M.2	L15398-001

 **IMPORTANT:** To prevent an unresponsive system, replace the wireless module only with a wireless module authorized for use in the computer by the governmental agency that regulates wireless devices in your country or region. If you replace the module and then receive a warning message, remove the module to restore device functionality, and then contact technical support.

Before removing the WWAN module, follow these steps:

1. Prepare the computer for disassembly ([Preparation for disassembly on page 33](#)).
2. Remove the bottom cover (see [Service door on page 33](#)).
3. Disconnect the battery (see [Battery on page 35](#)).

Remove the WWAN module:

1. Disconnect the WWAN antenna cables (**1**) from the terminals on the WWAN module.

 **NOTE:** The WWAN antenna cable labeled 5 connects to the Main terminal labeled 5. The WWAN antenna cable labeled 6 connects to the Aux/GPS terminal labeled 6.

2. Remove the Phillips M2.0 × 3.0 screw (**2**) that secures the WWAN module to the system board. (The WWAN module tilts up.)
3. Remove the WWAN module (**3**) by pulling the module away from the slot at an angle.

 **NOTE:** WWAN modules are notched to prevent incorrect installation.

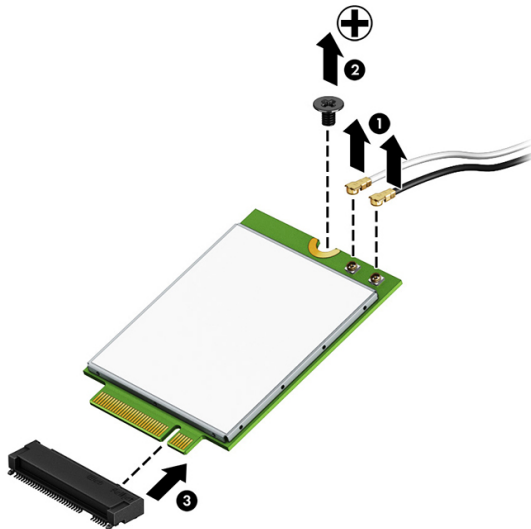

 **NOTE:** If the WWAN antenna cables are not connected to the terminals on the WWAN module, protective sleeves should be installed on the antenna connectors, as shown in the following illustration.

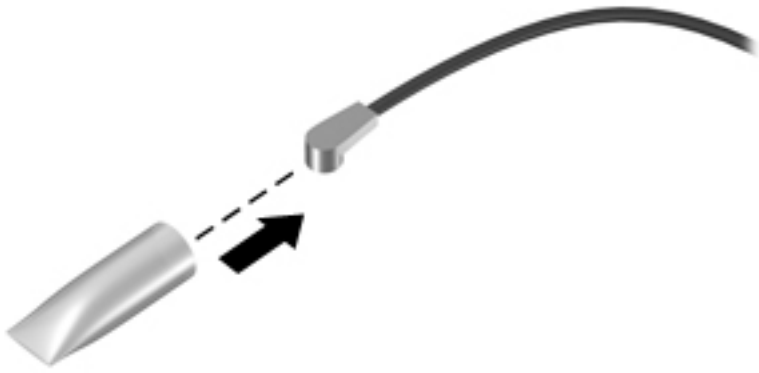

Reverse this procedure to install the WWAN module.

Memory module

Table 5-6 Memory module descriptions and part numbers

Description	Spare part number
For use in models with Intel Core or Xeon processors	
32 GB	L50384-001
16 GB	937438-850
8 GB	937236-850
4 GB	L10598-850
For use in models with Intel Xeon processors	
16 GB	L24981-001
8 GB	L24983-001

Before adding new memory, make sure you update the computer to the latest BIOS.



IMPORTANT: Failure to update the computer to the latest BIOS prior to installing new memory may result in various system problems.

Before removing a memory module, follow these steps:

1. Prepare the computer for disassembly ([Preparation for disassembly on page 33](#)).
2. Remove the service door (see [Service door on page 33](#)).
3. Disconnect the battery (see [Battery on page 35](#)).

The computer includes four memory module sockets. Two memory module sockets are accessible for customer self-repair.

Remove the memory module:

1. Spread the retaining tabs **(1)** on each side of the memory module slot to release the memory module. (The memory module tilts up.)

2. Remove the memory module (2) by pulling the module away from the slot at an angle.

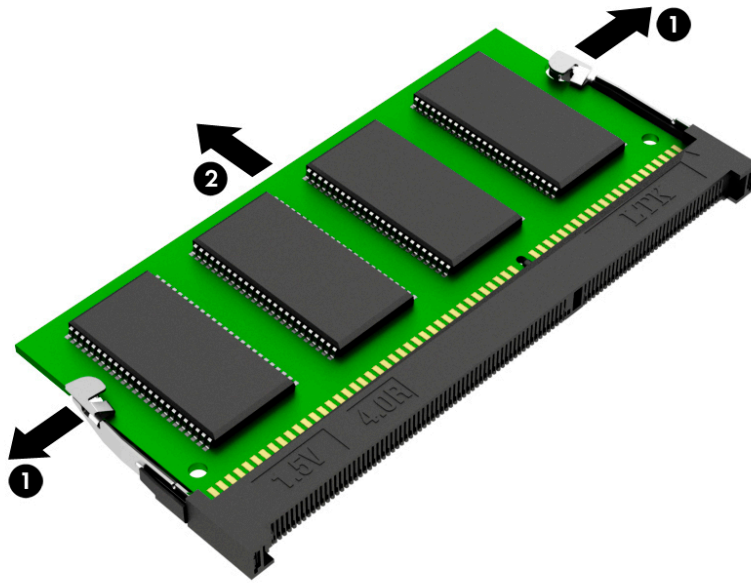

Reverse this procedure to install a memory module.



NOTE: Memory modules are notched to prevent incorrect installation.

6 Removal and replacement procedures for authorized service provider parts

 **IMPORTANT:** Components described in this chapter should only be accessed by an authorized service provider. Accessing these parts can damage the computer or void the warranty.

Component replacement procedures

This chapter provides removal and replacement procedures for Authorized Service Provider only parts.

There are as many as 68 screws that must be removed, replaced, and/or loosened when servicing the computer. Make special note of each screw size and location during removal and replacement.

Keyboard

In this section, the first table provides the main spare part number for the keyboards. The second table provides the country codes.

Table 6-1 Keyboard descriptions and part numbers

Description	Spare part number
Keyboard with backlight and pointing stick (includes cables)	L28407-xx1
Keyboard with backlight and pointing stick, privacy (includes cables)	L29635-xx1

Table 6-2 Keyboard country codes

For use in country or region	Spare part number	For use in country or region	Spare part number	For use in country or region	Spare part number
Belgium	-A41	India	-D61	Slovenia	-BA1
Brazil	-201	Israel	-BB1	South Korea	-AD1
Bulgaria	-261	Italy	-061	Spain	-071
Canada	-DB1	Japan	-291	Sweden and Finland	-B71
Czech Republic and Slovakia	-FL1	Latin America	-161	Switzerland	-BG1
Denmark	-081	The Netherlands	-B31	Taiwan	-AB1
Denmark, Finland, and Norway	-DH1	Northern Africa	-FP1	Thailand	-281
France	-051	Norway	-091	Turkey	-141
Germany	-041	Portugal	-131	Turkey F	-541
Greece	-151	Romania	-271	United Kingdom	-031

Table 6-2 Keyboard country codes (continued)

For use in country or region	Spare part number	For use in country or region	Spare part number	For use in country or region	Spare part number
Hungary	-211	Russia	-251	United States	-001
Iceland	-DD1	Saudi Arabia	-171		

Before removing the keyboard, follow these steps:

1. Prepare the computer for disassembly ([Preparation for disassembly on page 33](#)).
2. Remove the service door (see [Service door on page 33](#)).
3. Disconnect the battery (see [Battery on page 35](#)).

Remove the keyboard:

1. Remove the three Phillips M2.0 × 2.0 screws that secure the keyboard to the computer.

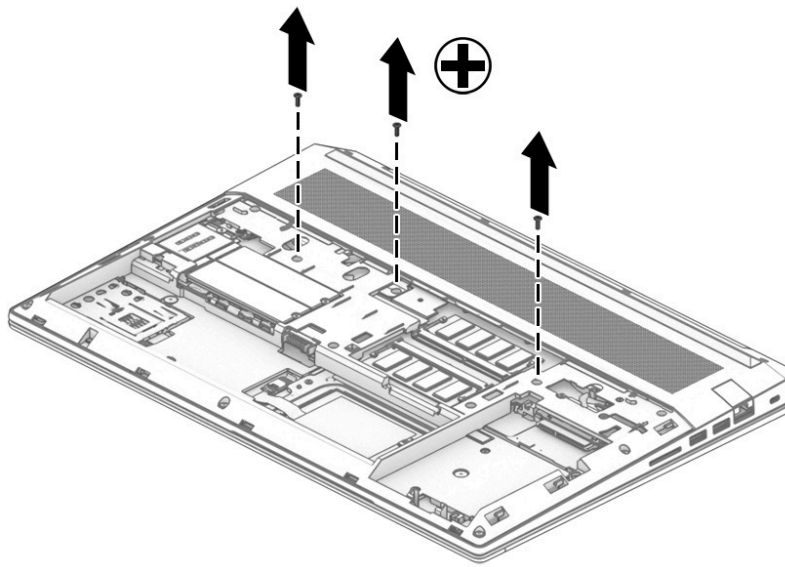

2. Partially open the computer.
3. Rest and secure the computer on its left side.

4. Insert a thin, non-conductive tool into the keyboard release hole near the vent, and then press on the back of the keyboard until the keyboard disengages from the computer.

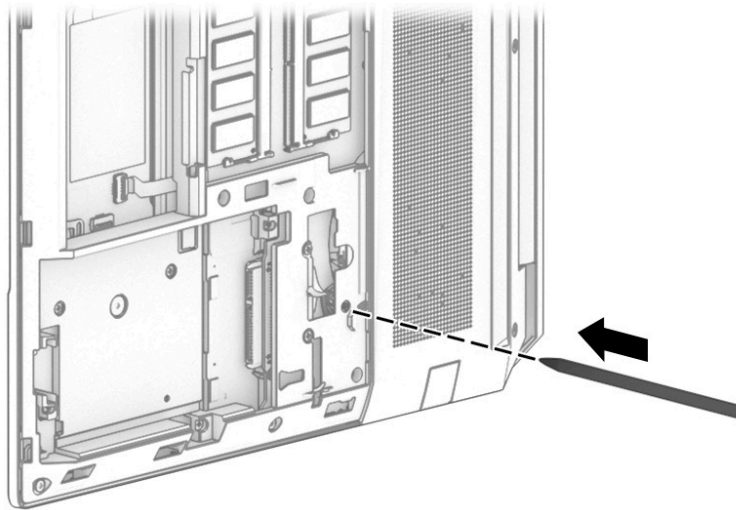

5. Turn the computer right-side up, with the front toward you.
6. Open the computer as far as it will open.
7. Lift the rear edge of the keyboard and swing it up and forward until it rests upside down on the palm rest **(1)**.
8. Release the zero insertion force (ZIF) connector to which the pointing stick cable is attached, and then disconnect the pointing stick cable from the system board **(2)**.
9. Release the ZIF connector to which the keyboard cable is attached, and then disconnect the keyboard cable from the system board **(3)**.
10. Release the ZIF connector to which the keyboard cable is attached, and then disconnect the keyboard cable from the system board **(4)**.

11. Remove the keyboard (5).

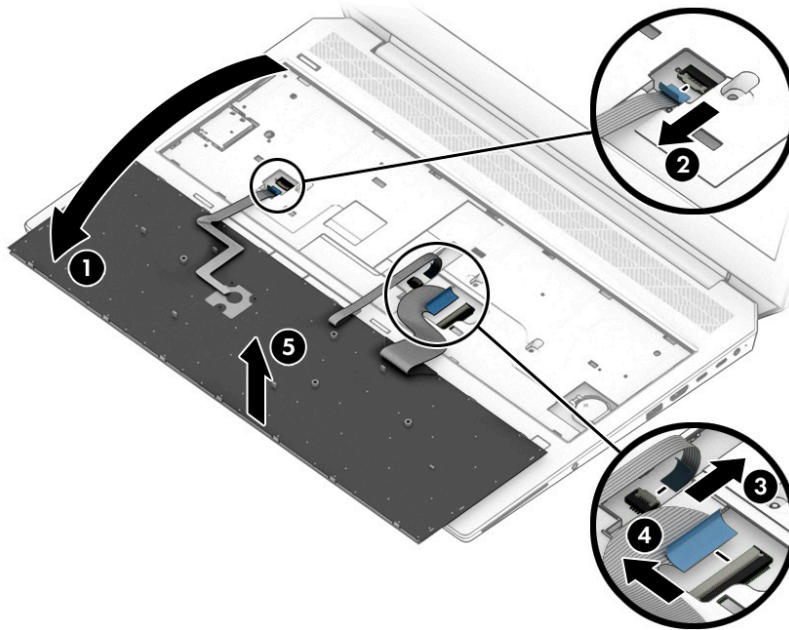

Reverse this procedure to install the keyboard.

Bottom cover

Table 6-3 Bottom cover description and part number

Description	Spare part number
Bottom cover	L68838-001

Before removing the bottom cover, follow these steps:

1. Prepare the computer for disassembly ([Preparation for disassembly on page 33](#)).
2. Remove the service door (see [Service door on page 33](#)).
3. Disconnect the battery (see [Battery on page 35](#)).
4. Remove the hard drive (see [Hard drive on page 37](#)).

Remove the bottom cover:

1. Position the computer upside down.
2. Remove the screws securing the keyboard (see [Keyboard on page 43](#)).

3. Remove the nine Torx T8 2.5 × 6.5 screws that secure the bottom cover to the computer.

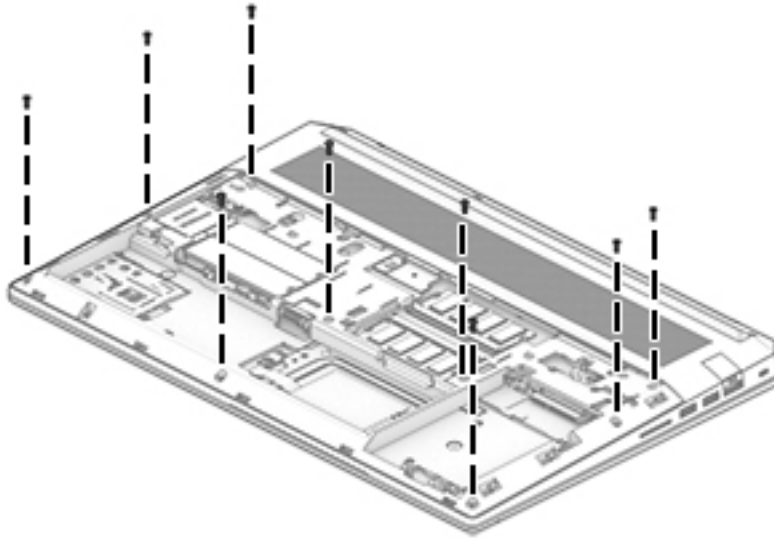

4. Remove the four Torx T8 2.5 × 6.5 screws from the rear edge of the bottom cover **(1)**.
5. Remove the three Torx T8 2.5 × 2.5 screws from the bottom cover **(2)**.
6. Lift the bottom cover off the computer **(3)**.

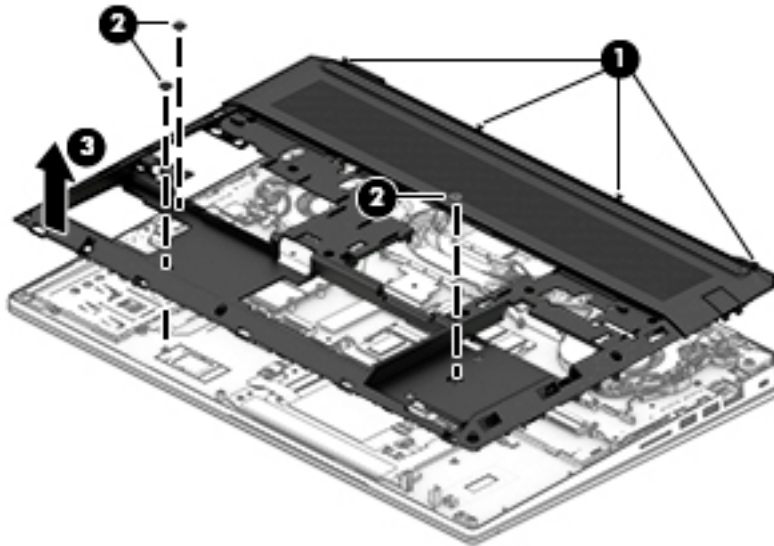

Reverse this procedure to install the bottom cover.

Service door latch

Table 6-4 Door latch description and part number

Description	Spare part number
Service door latch	L76717-001

Before removing the service door latch, follow these steps:

1. Prepare the computer for disassembly ([Preparation for disassembly on page 33](#)).
2. Remove the service door (see [Service door on page 33](#)).

Remove the service door latch:

1. Position the service door upside down.
2. Remove the Phillips M2.0 × 2.0 screw **(1)** that secures the release button, and then remove the release button **(2)**.
3. Remove the four Phillips M2.0 × 2.0 screws **(3)** that secure the inner latch.
4. Rotate the latch **(4)**, and then remove the latch from the clips on the inside of the service door **(5)**.
5. Lift the latch off the service door **(6)**, and remove the spring from the latch **(7)**.

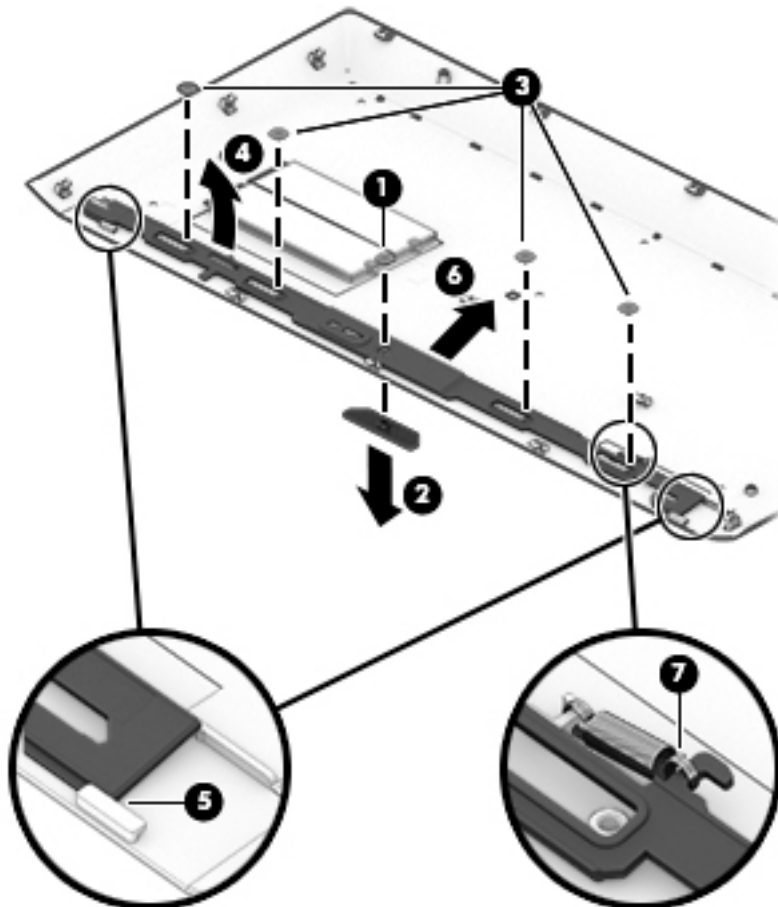

Reverse this procedure to install the service door latch.

Touchpad module

Table 6-5 Touchpad module description and part number

Description	Spare part number
Touchpad module (includes protective shielding tape)	L30663-001
Touchpad DreamColor module (includes protective shielding tape)	L28745-001
The touchpad module cable and protective shielding tape are available in the Cable Kit using spare part number L68854-001.	

Before removing the touchpad module, follow these steps:

1. Prepare the computer for disassembly ([Preparation for disassembly on page 33](#)).
2. Remove the service door (see [Service door on page 33](#)).
3. Disconnect the battery (see [Battery on page 35](#)).
4. Remove the hard drive (see [Hard drive on page 37](#)).
5. Remove the bottom cover (see [Bottom cover on page 46](#)).

Remove the touchpad module:

1. Disconnect the touchpad cable from the system board **(1)**, and peel it away from the top cover **(2)**.
2. Disconnect the second touchpad cable from the system board **(3)**

 **IMPORTANT:** When installing the touchpad click board, be sure to place the protective shielding tape on the touchpad connector **(5)** with the edge of the tape aligned with the white line and touching the touchpad bracket.

3. If an NFC module is present, disconnect the NFC module cable from the NFC module **(4)**.

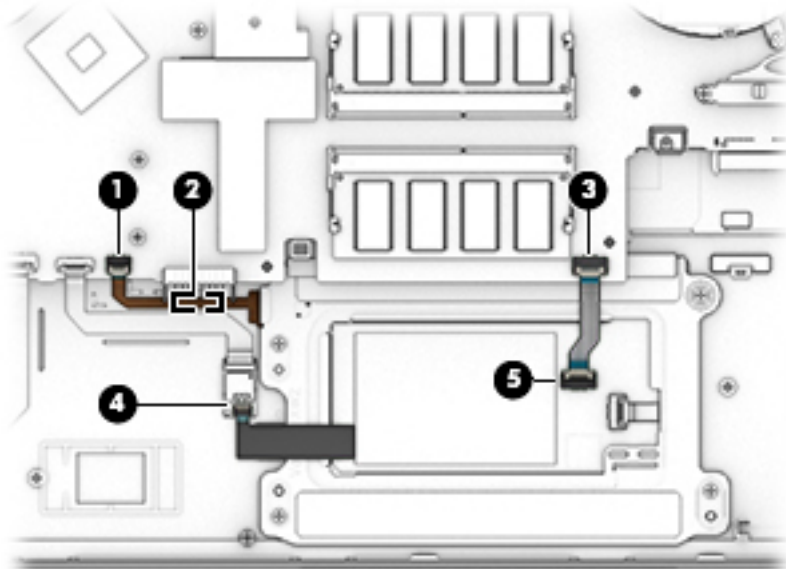

4. Remove the four Phillips M2.5 × 2.5 screws that secure the touchpad module to the top cover **(1)**.

5. Lift the touchpad module up **(2)**, and remove it and the cables from the computer **(3)**.

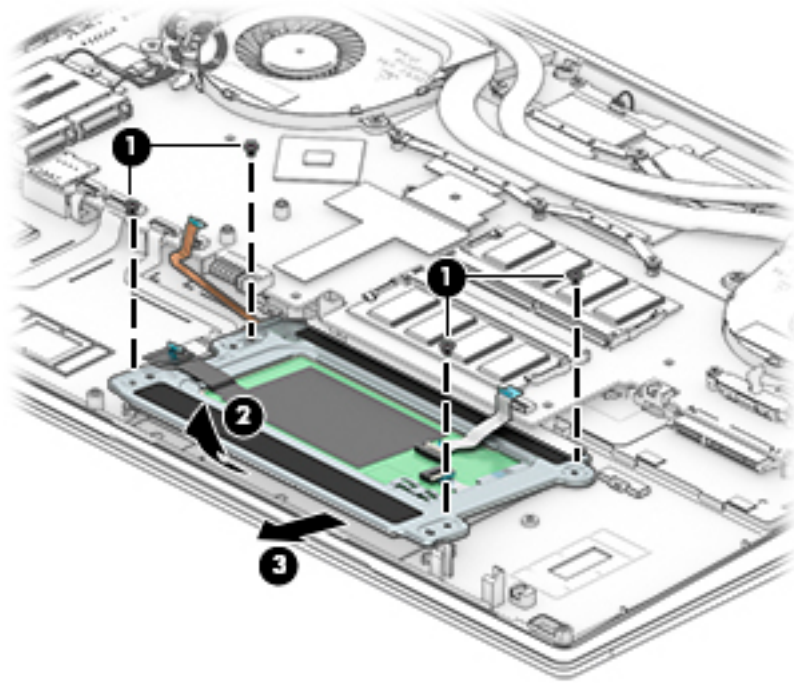

Reverse this procedure to install the touchpad module.

Smart card reader

Table 6-6 Smart card reader description and part number

Description	Spare part number
Smart card reader (includes cable)	not available

Before removing the smart card reader, follow these steps:

1. Prepare the computer for disassembly ([Preparation for disassembly on page 33](#)).
2. Remove the service door (see [Service door on page 33](#)).
3. Disconnect the battery (see [Battery on page 35](#)).
4. Remove the hard drive (see [Hard drive on page 37](#)).
5. Remove the bottom cover (see [Bottom cover on page 46](#)).

Remove the smart card reader:

1. Release the ZIF connector **(1)** to which the smart card reader cable is attached, and then disconnect the smart card reader cable from the system board.
2. Loosen the three Phillips M2.5 × 2.5 screws **(2)** that secure the smart card reader to the top cover.
3. Remove the smart card reader **(3)**.

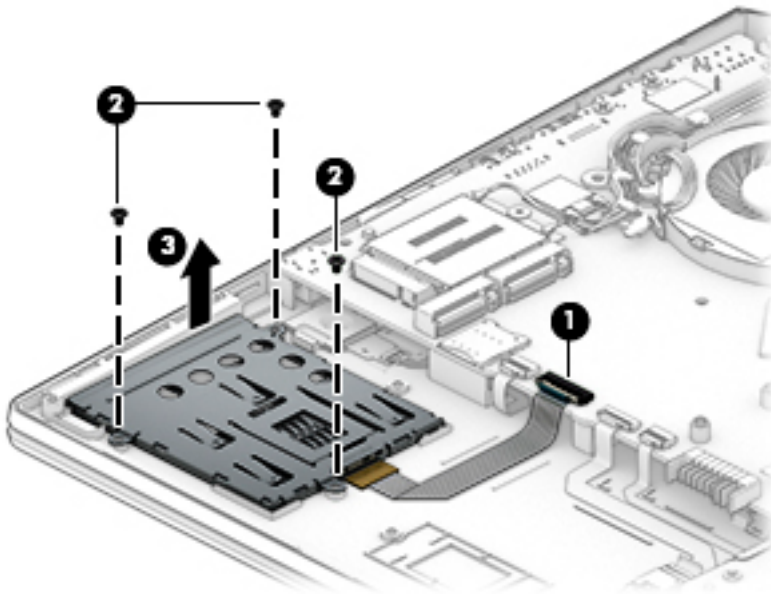

Reverse this procedure to install the smart card reader and cable.

NFC module

Table 6-7 NFC module description and part number

Description	Spare part number
NFC module	L02249-001
NFC antenna	L66204-001

Before removing the NFC module, follow these steps:

1. Prepare the computer for disassembly ([Preparation for disassembly on page 33](#)).
2. Remove the service door (see [Service door on page 33](#)).
3. Remove the battery (see [Battery on page 35](#)).
4. Remove the hard drive (see [Hard drive on page 37](#)).
5. Remove the bottom cover (see [Bottom cover on page 46](#)).

Remove the NFC module:

1. Disconnect the NFC antenna **(1)** and the system board cable **(2)** from the ZIF connectors on the NFC module.
2. Use a tool to release the NFC module from the adhesive securing it to the computer **(3)**, and then remove the module from the computer **(4)**.

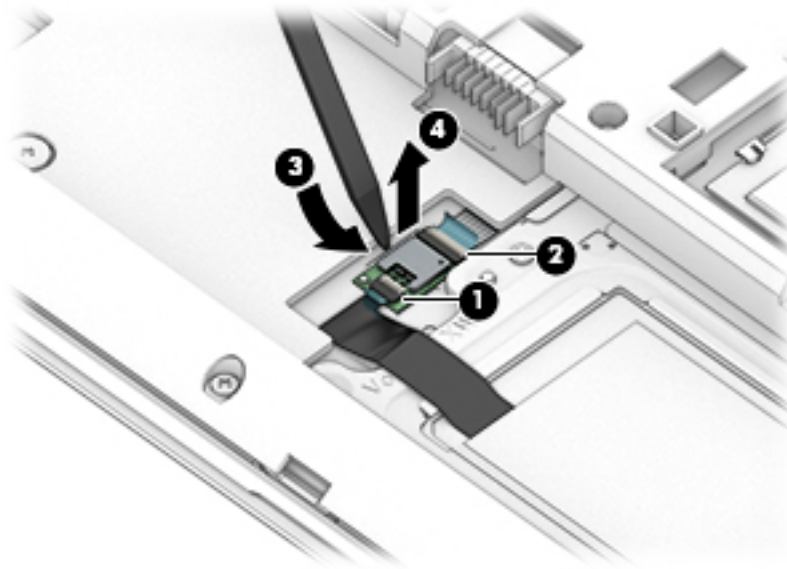

Reverse the removal procedures to install the NFC module.

Fans

Table 6-8 Fan descriptions and part numbers

Description	Spare part number
Fan for use in models with NVIDIA Quadro T2000 or T1000 graphics	L68840-001
Fan for use in models with NVIDIA Quadro RTX 3000 graphics	L68841-001

Before removing the fan, follow these steps:

1. Prepare the computer for disassembly ([Preparation for disassembly on page 33](#)).
2. Remove the service door (see [Service door on page 33](#)).
3. Disconnect the battery (see [Battery on page 35](#)).
4. Remove the hard drive (see [Hard drive on page 37](#)).
5. Remove the bottom cover (see [Bottom cover on page 46](#)).

Remove the fans:

1. To remove the CPU fan (left side of computer):
 - a. Disconnect the WWAN antenna cables from the WWAN card **(1)**, disconnect the WLAN antenna cables from the WLAN card **(2)**, and then remove the antenna cables from the clips in the fan **(3)**.

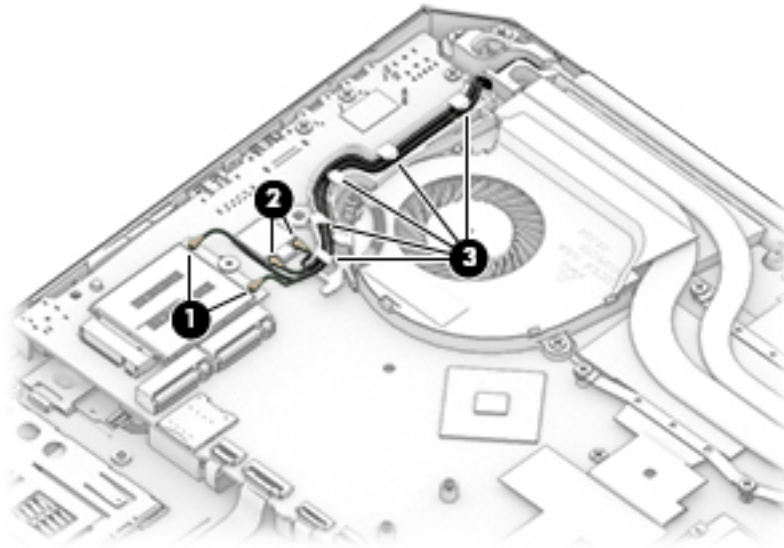

- b. Disconnect the fan cable from the system board **(1)**.
- c. Loosen the two captive Phillips screws that secure the fan to the computer **(2)**.
- d. Rotate the fan assembly away from the heat sink **(3)**, and then remove it from the computer **(4)**.

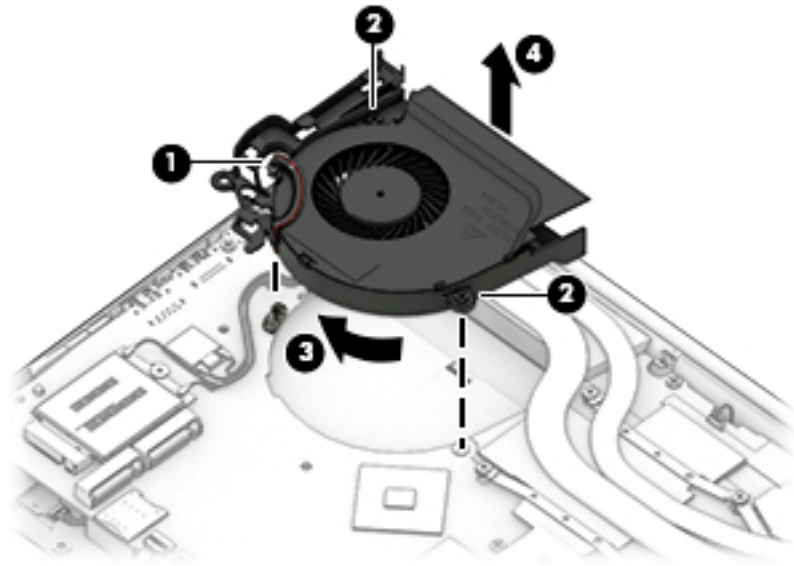

2. To remove the graphics board fan (right side of computer):

- a. Remove the two Phillips M2.5 × 2.5 screws securing the display cable bracket (1), remove the display cable bracket (2), disconnect the display cable (3), disconnect the ALS cable (4), disconnect the camera module cable (5), and then remove the display cables from the clips in the fan (6).

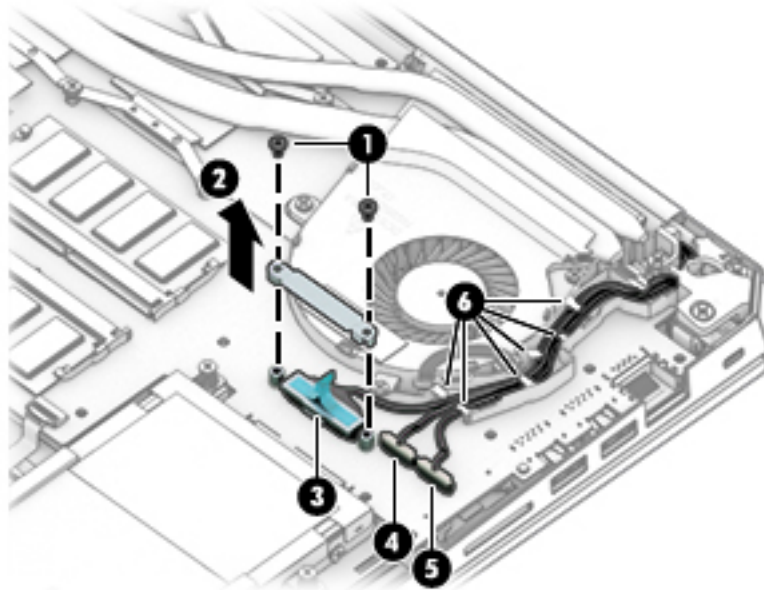

- b. Disconnect the fan cable from the system board (1).
- c. Loosen the three captive Phillips screws that secure the fan to the computer (2).
- d. Rotate the fan assembly away from the heat sink (3), and then remove it from the computer (4).

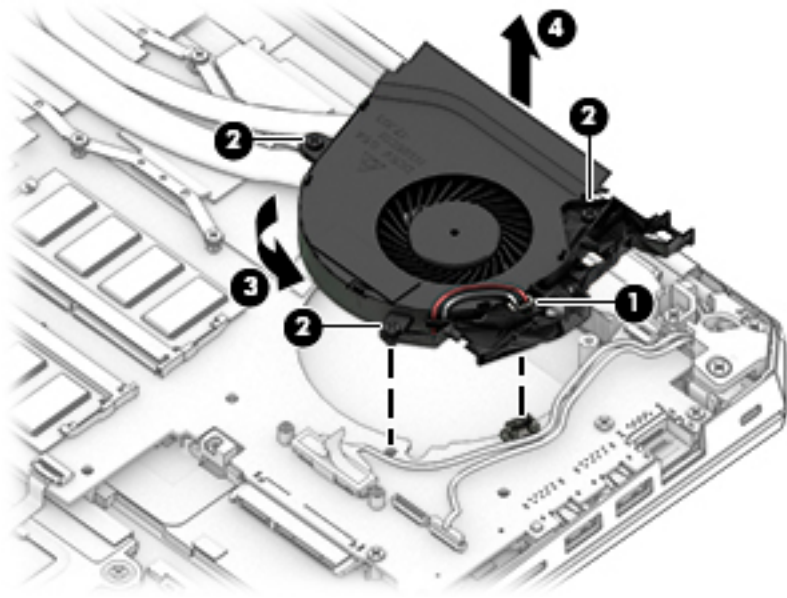

Reverse this procedure to install the fan.

Heat sink assembly

 **NOTE:** Remove only the heat sink from the system board if its removal is required to remove other components. It is preferred to leave the heat sink connected to the system board when possible to preserve the thermal materials used between the heat sink and system board. Removal of the heat sink requires reapplication of this thermal material.

 **NOTE:** The heat sink assembly spare part kit includes replacement thermal material.

Table 6-9 Heat sink assembly descriptions and part numbers

Description	Spare part number
Heat sink for use in models with NVIDIA Quadro T2000 or T1000 graphics	L68856-001
Heat sink for use in models with NVIDIA Quadro RTX 3000 graphics	L68857-001
Heat sink for use in models with UMA graphics memory	L68855-001

Before removing the heat sink assembly, follow these steps:

1. Prepare the computer for disassembly ([Preparation for disassembly on page 33](#)).
2. Remove the service door (see [Service door on page 33](#)).
3. Disconnect the battery (see [Battery on page 35](#)).
4. Remove the hard drive (see [Hard drive on page 37](#)).
5. Remove the bottom cover (see [Bottom cover on page 46](#)).

Remove the heat sink assembly:

1. On models with discrete graphics memory:
 - a. Following the sequence stamped into the processor heat sink, loosen the six Phillips captive screws that secure the processor heat sink to the system board **(1)**.

- b. Remove the fan/heat sink assembly (2).

 **NOTE:** Due to the adhesive quality of the thermal material located between the fan/heat sink assembly and the system board components, it may be necessary to move the heat sink assembly from side to side to detach it.

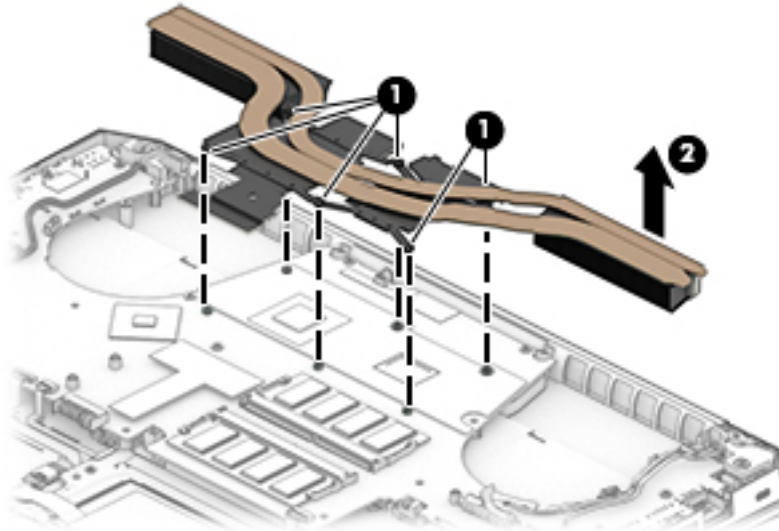

- c. Thoroughly clean the thermal material from the surfaces of the heat sink assembly and the system board components each time the fan/heat sink assembly is removed. Replacement thermal material is included with the fan/heat sink assembly, processor, and system board spare part kits.
- Thermal pads are used on the processor (1) and the graphics board (3) and the heat sink sections (2) and (4) that service them.

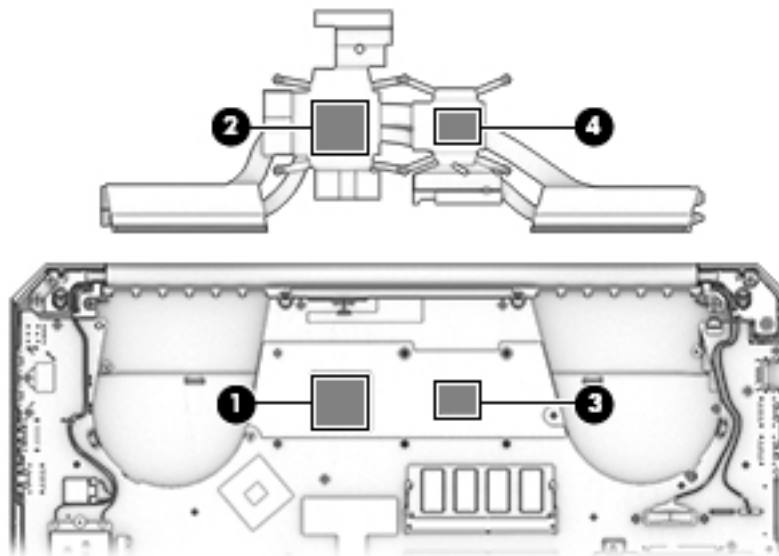

2. On models with UMA graphics memory:

- a. Following the sequence stamped into the processor heat sink, loosen the four Phillips captive screws that secure the processor heat sink to the system board (1).

- b. Remove the fan/heat sink assembly (2).

 **NOTE:** Due to the adhesive quality of the thermal material located between the fan/heat sink assembly and the system board components, it may be necessary to move the heat sink assembly from side to side to detach it.

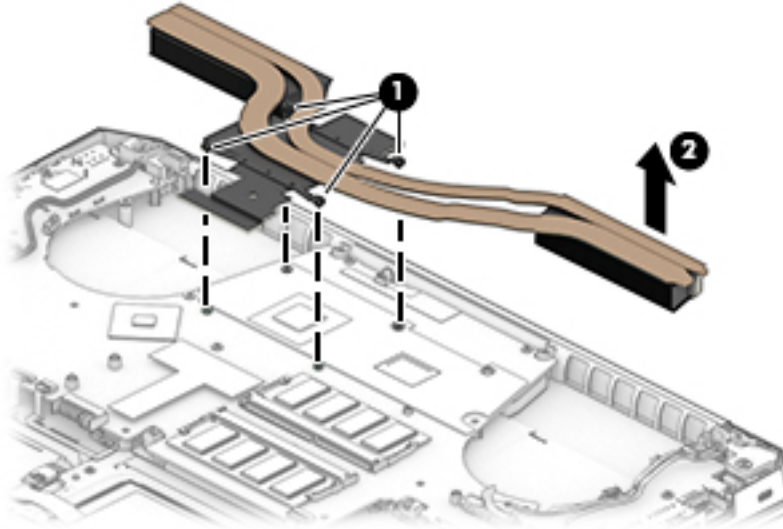

- c. Thoroughly clean the thermal material from the surfaces of the heat sink assembly and the system board components each time the fan/heat sink assembly is removed. Replacement thermal material is included with the fan/heat sink assembly, processor, and system board spare part kits.

Thermal pads are used on the processor (1) and the heat sink section (2) that services it

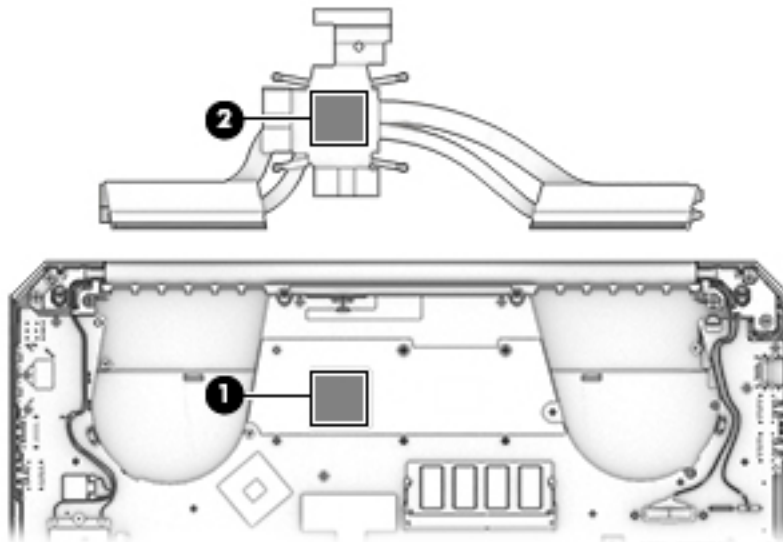

Reverse this procedure to install the heat sink assembly.

System board



NOTE: The system board spare part kit includes battery connector bracket and replacement thermal material.

All system boards use the following part numbers:

xxxxxx-001: non-Windows operating systems

xxxxxx-601: Windows 10 operating system

Table 6-10 System board descriptions and part numbers

Description	Spare part number
System board equipped with an Intel Xeon E-2286M processor and NVIDIA Quadro RTX 3000 graphics	L68831-xx1
System board equipped with an Intel Xeon E-2286M processor and NVIDIA Quadro T1000 graphics	L68826-xx1
System board equipped with an Intel Xeon E-2286M processor and NVIDIA Quadro T2000 graphics	L68830-xx1
System board equipped with an Intel Core i9-9880H processor and NVIDIA Quadro RTX 3000 graphics	L68833-xx1
System board equipped with an Intel Core i9-9880H processor and NVIDIA Quadro T2000 graphics	L68829-xx1
System board equipped with an Intel Core i9-9880H processor and NVIDIA Quadro T1000 graphics	L68825-xx1
System board equipped with an Intel Core i7-9850H processor and NVIDIA Quadro RTX 3000 graphics	L68832-xx1
System board equipped with an Intel Core i7-9850H processor and NVIDIA Quadro T2000 graphics	L68828-xx1
System board equipped with an Intel Core i7-9850H processor and NVIDIA Quadro T1000 graphics	L68824-xx1
System board equipped with an Intel Core i7-9750H processor	L68823-xx1
System board equipped with an Intel Core i5-9400H processor and NVIDIA Quadro T2000 graphics	L68827-xx1
System board equipped with an Intel Core i5-9400H processor and NVIDIA Quadro T1000 graphics	L68822-xx1
System board equipped with an Intel Core i5-9300H processor	L68821-xx1
System board equipped with an Intel Core i5-9300H processor and UMA graphics	L68820-xxx

Before removing the system board, follow these steps:

1. Prepare the computer for disassembly ([Preparation for disassembly on page 33](#)).
2. Remove the service door (see [Service door on page 33](#)).
3. Disconnect the battery (see [Battery on page 35](#)).
4. Remove the hard drive (see [Hard drive on page 37](#)).
5. Remove the keyboard (see [Keyboard on page 43](#)).
6. Remove the bottom cover (see [Bottom cover on page 46](#)).
7. Remove the touchpad module (see [Touchpad module on page 49](#)).
8. Remove the smart card reader (see [Smart card reader on page 51](#)).
9. Remove the NFC module (see [NFC module on page 52](#)).
10. Remove the fans (see [Fans on page 53](#)).

 **NOTE:** When replacing the system board, be sure that the following components are removed from the defective system board and installed on the replacement system board:

- Solid-state drive (see [Solid-state drives \(M.2\) on page 36](#))
- WWAN module (see [WWAN module on page 39](#))
- Memory modules (see [Memory module on page 41](#))

 **NOTE:** The WLAN feature is soldered to the system board and not removable.

Remove the system board:

1. Disconnect any remaining cables from the system board:
 - (1) Speaker cable
 - (2) Power button board cable
 - (3) Touchpad cable
 - (4) Touchpad cable
 - (5) NFC module cable
 - (6) Smart card reader cable
 - (7) Fingerprint reader cable

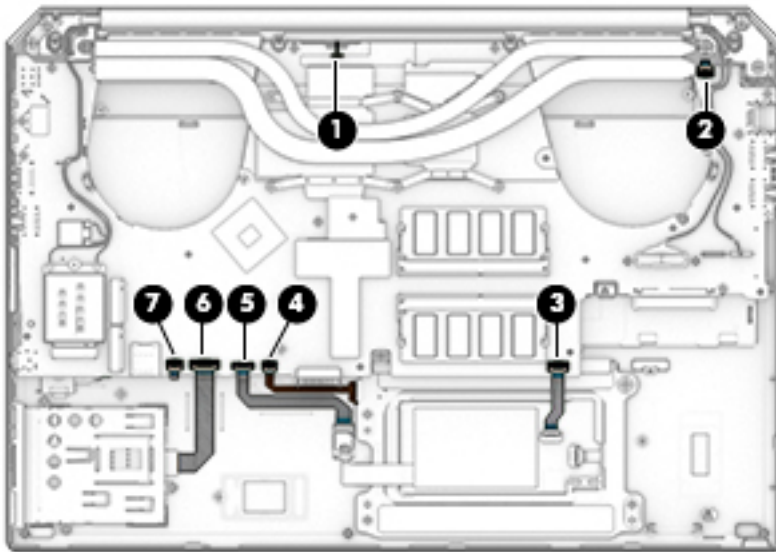

2. If present, eject the memory card reader blank (1).

3. Remove the eight Phillips M2.5 × 2.5 screws securing the system board to the top cover (2).

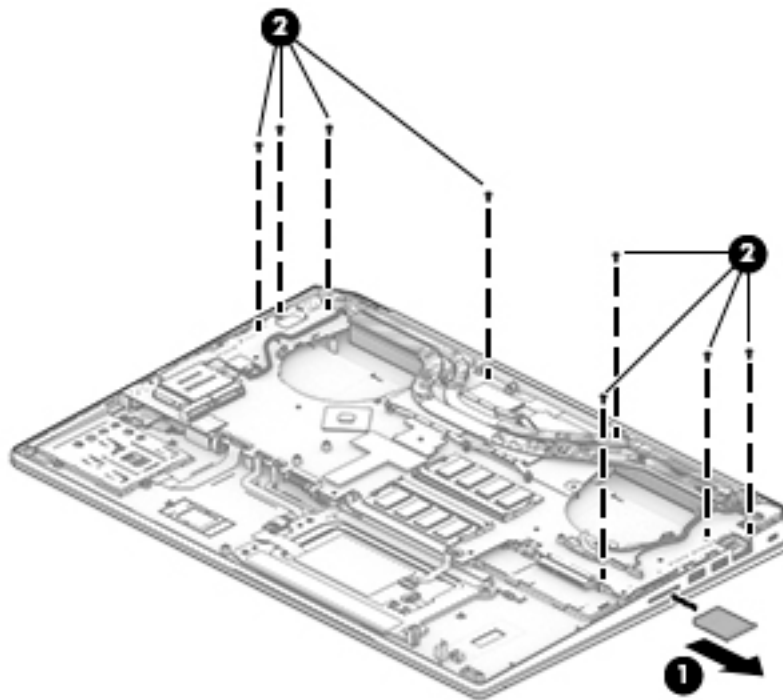

4. Lift up on the right side of the system board (1) until it rests at an angle.
5. Remove the system board (2) by sliding it up and to the right.

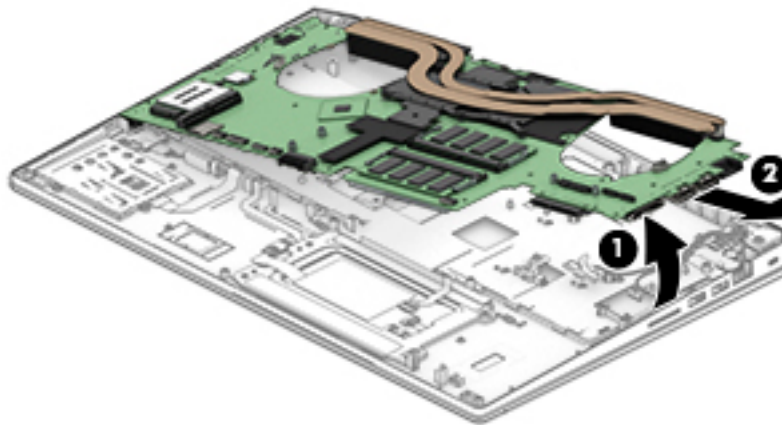

6. When you remove the screw through the USB Type-C bracket to remove the system board (1), the USB Type-C bracket is then unsecured and can be removed after the system board is removed (2).

The USB Type-C bracket is available in the Bracket Kit, spare part number L68842-001.

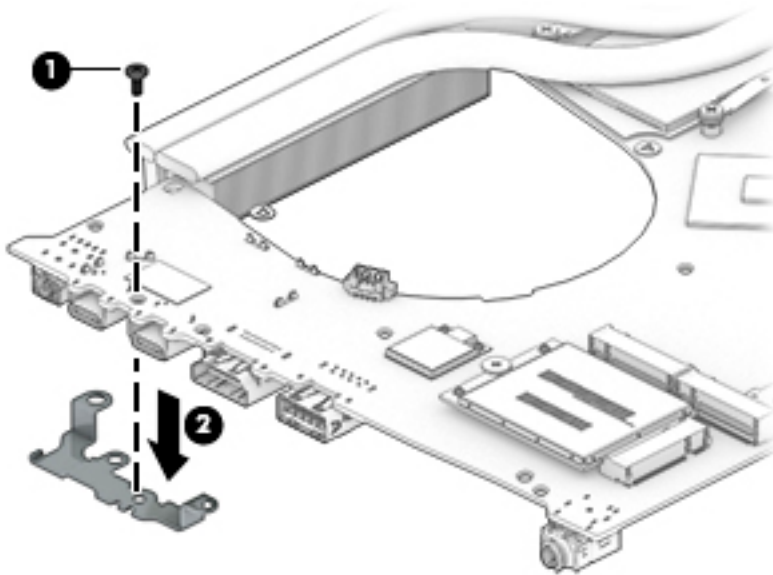

Reverse this procedure to install the system board.

RTC battery

Table 6-11 RTC battery description and part number

Description	Spare part number
RTC battery	L72624-001

Before removing the RTC battery, follow these steps:

1. Prepare the computer for disassembly ([Preparation for disassembly on page 33](#)).
2. Remove the bottom cover (see [Service door on page 33](#)).
3. Disconnect the battery (see [Battery on page 35](#)).
4. Remove the hard drive (see [Hard drive on page 37](#)).
5. Remove the keyboard [Keyboard on page 43](#).
6. Remove the bottom cover (see [Bottom cover on page 46](#)).
7. Remove the system board (see [System board on page 59](#)).

Remove the RTC battery:

1. Insert a thin, non-conductive tool beneath the edge of the RTC battery (1).

2. Pry the RTC battery away from the computer **(2)**.

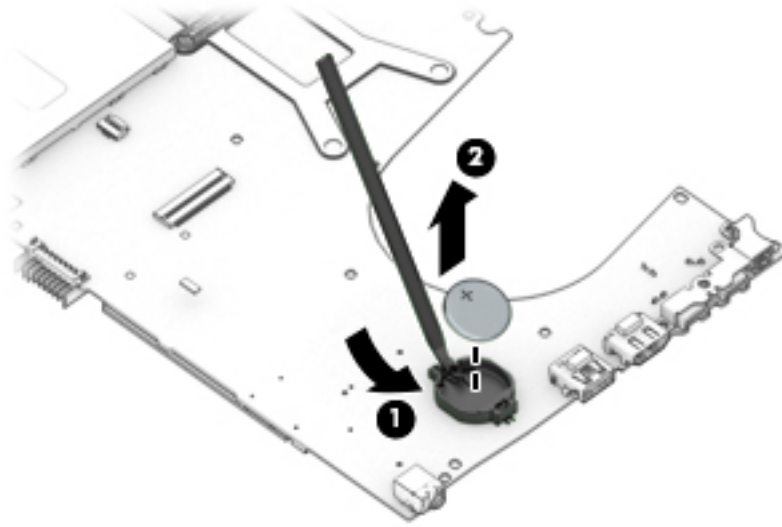

3. Remove the RTC battery and cable.

Reverse this procedure to install the RTC battery.

Memory module

Table 6-12 Memory module description and part number

Description	Spare part number
For use in models with Intel Core or Xeon processors	
32 GB	L50384-001
16 GB	937438-850
8 GB	937236-850
4 GB	L10598-850
For use in models with Intel Xeon processors	
16 GB	L24981-001
8 GB	L24983-001

Before adding new memory, make sure you update the computer to the latest BIOS.

 **IMPORTANT:** Failure to update the computer to the latest BIOS prior to installing new memory may result in various system problems.

Before removing a memory module, follow these steps:

1. Prepare the computer for disassembly ([Preparation for disassembly on page 33](#)).
2. Remove the service door (see [Service door on page 33](#)).
3. Disconnect the battery (see [Battery on page 35](#)).
4. Remove the hard drive (see [Hard drive on page 37](#)).
5. Remove the keyboard (see [Keyboard on page 43](#)).
6. Remove the bottom cover (see [Bottom cover on page 46](#)).
7. Remove the system board (see [System board on page 59](#)).

The computer includes four memory module sockets. The two memory module sockets under the system board are accessible only for authorized service providers.

Remove the memory module:

1. Remove the memory shield.

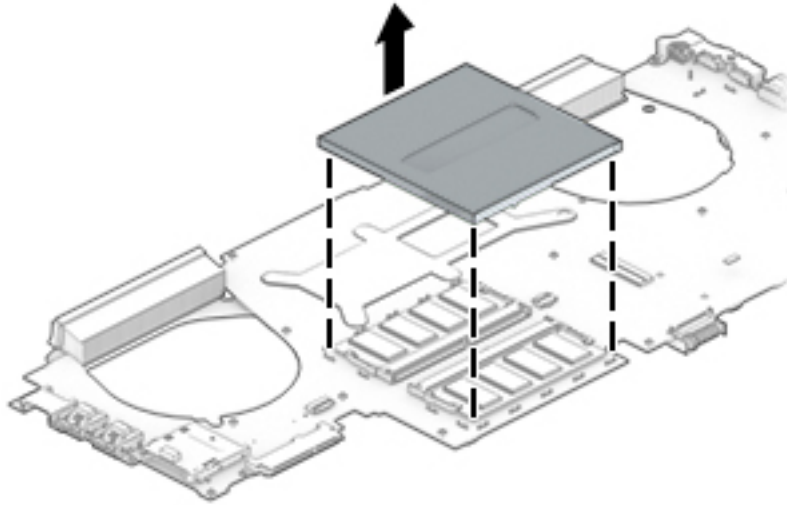

2. Spread the retaining tabs **(1)** on each side of the memory module slot to release the memory module. (The memory module tilts up.)
3. Remove the memory module **(2)** by pulling the module away from the slot at an angle.

 **NOTE:** When removing the memory module, remove the old thermal pad and replace it with the new pad that comes in the solid-state drive spare part kit.

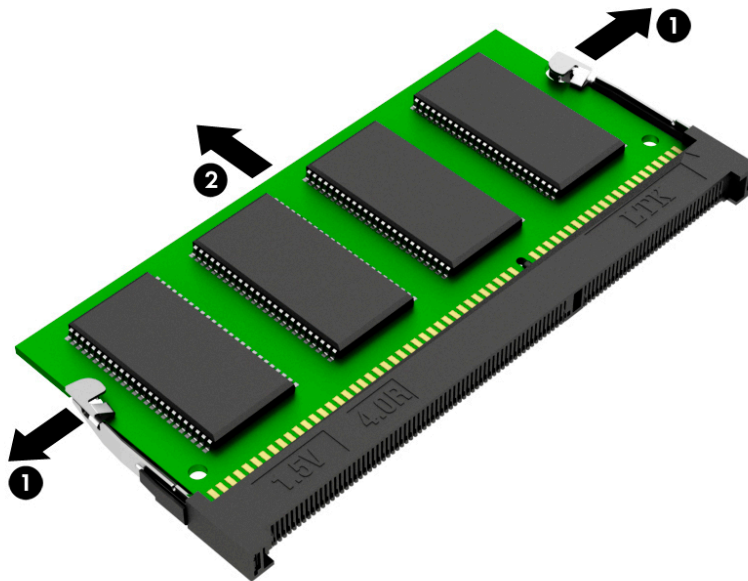

Reverse this procedure to install a memory module.

 **NOTE:** Memory modules are notched to prevent incorrect installation.

Speakers

Table 6-13 Speakers description and part number

Description	Spare part number
Speakers (includes cable)	L28719-001

Before removing the speakers, follow these steps:

1. Prepare the computer for disassembly ([Preparation for disassembly on page 33](#)).
2. Remove the service door (see [Service door on page 33](#)).
3. Disconnect the battery (see [Battery on page 35](#)).
4. Remove the hard drive (see [Hard drive on page 37](#)).
5. Remove the keyboard (see [Keyboard on page 43](#)).
6. Remove the bottom cover (see [Bottom cover on page 46](#)).
7. Remove the system board (see [System board on page 59](#)).

Remove the speakers:

1. Remove the three Phillips M2.5 × 2.5 screws **(1)** that secure the speakers to the top cover.
2. Remove the speakers **(2)**.

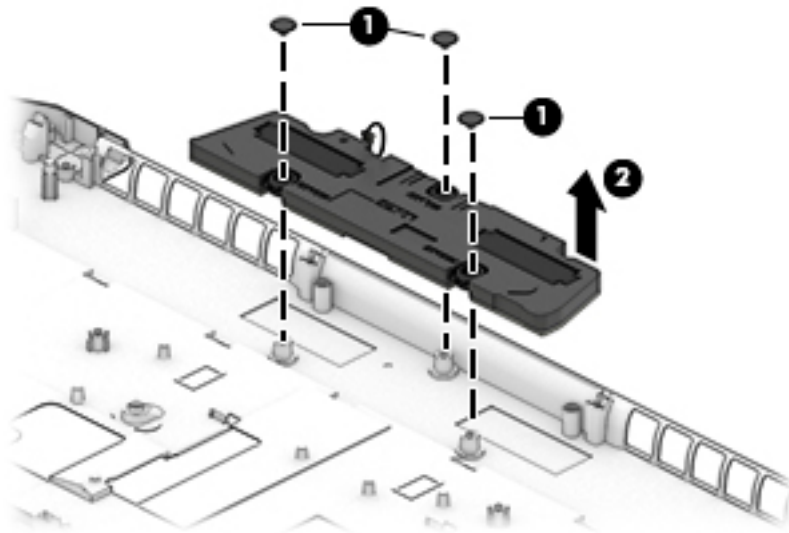

Reverse this procedure to install the speakers.

Fingerprint reader board

Table 6-14 Fingerprint reader board description and part number

Description	Spare part number
Fingerprint reader board	L67969-001
NOTE: The fingerprint reader bracket is available in the Bracket Kit, spare part number L68842-001.	
NOTE: The fingerprint reader cable is available in the Cable Kit, spare part number L68854-001.	

Before removing the fingerprint reader board, follow these steps:

1. Prepare the computer for disassembly ([Preparation for disassembly on page 33](#)).
2. Remove the service door (see [Service door on page 33](#)).
3. Disconnect the battery (see [Battery on page 35](#)).
4. Remove the service door (see [Service door on page 33](#)).
5. Remove the hard drive (see [Hard drive on page 37](#)).
6. Remove the keyboard (see [Keyboard on page 43](#)).
7. Remove the bottom cover (see [Bottom cover on page 46](#)).
8. Remove the system board (see [System board on page 59](#)).

Remove the fingerprint reader board:

1. Remove the Phillips M2.5 × 2.5 screw **(1)** that secures the fingerprint reader board and bracket to the top cover.
2. Lift the fingerprint reader board bracket off the fingerprint reader board **(2)**.
3. Remove the fingerprint reader board **(3)**

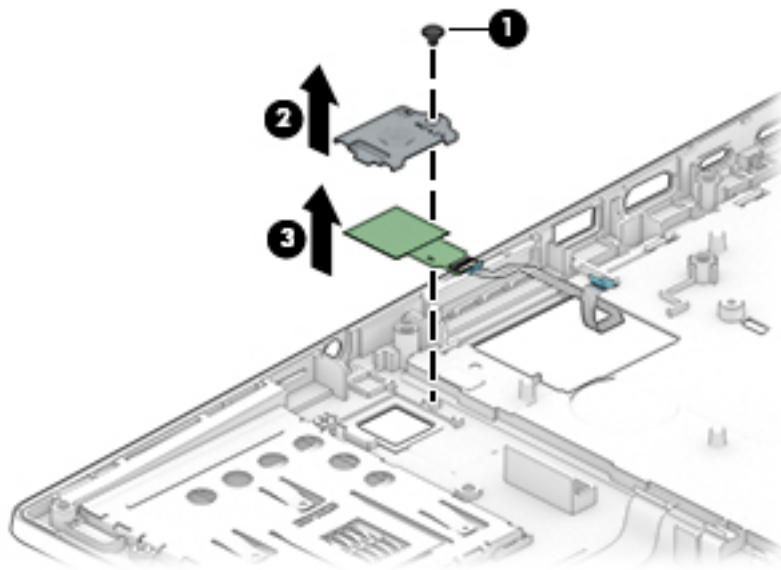

Reverse this procedure to install the fingerprint reader board.

Power button board

Table 6-15 Power button board description and part number

Description	Spare part number
Power button board	L68834-001

Before removing the power button board, follow these steps:

1. Prepare the computer for disassembly ([Preparation for disassembly on page 33](#)).
2. Remove the service door (see [Service door on page 33](#)).
3. Disconnect the battery (see [Battery on page 35](#)).
4. Remove the hard drive (see [Hard drive on page 37](#)).
5. Remove the keyboard (see [Keyboard on page 43](#)).
6. Remove the bottom cover (see [Bottom cover on page 46](#)).
7. Remove the system board (see [System board on page 59](#)).

Remove the power button board:

1. Remove the two Phillips M2.5 × 2.5 screws **(1)** that secure the power button board to the top cover.
2. Remove the power button board from the computer **(2)**.

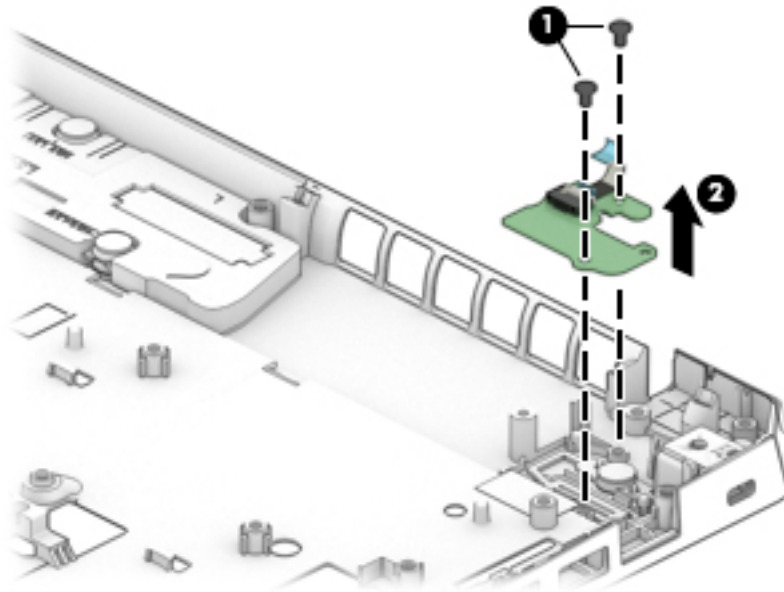

Reverse this procedure to install the power button board.

Display assembly

Table 6-16 Display assembly descriptions and part numbers

Description	Spare part number
Display assembly, DreamColor, non-touch, UHD, UWVA	L68847-001
Display assembly, DreamColor, non-touch, UHD, UWVA, with IR camera	L76718-001

To remove the display assembly and display subcomponents, follow these steps:

1. Prepare the computer for disassembly ([Preparation for disassembly on page 33](#)).
2. Remove the bottom cover (see [Service door on page 33](#)).
3. Disconnect the battery (see [Battery on page 35](#)).
4. Remove the hard drive (see [Hard drive on page 37](#)).
5. Remove the bottom cover (see [Bottom cover on page 46](#)).
6. Disconnect the antenna and display cables from the system board (see [Fans on page 53](#)).

Remove the display assembly:

1. Remove the six Phillips M2.5 × 2.5 screws **(1)** that secure the hinges to the computer.
2. Angle the computer toward the hinges **(2)**.
3. Separate the display from the computer **(3)**.

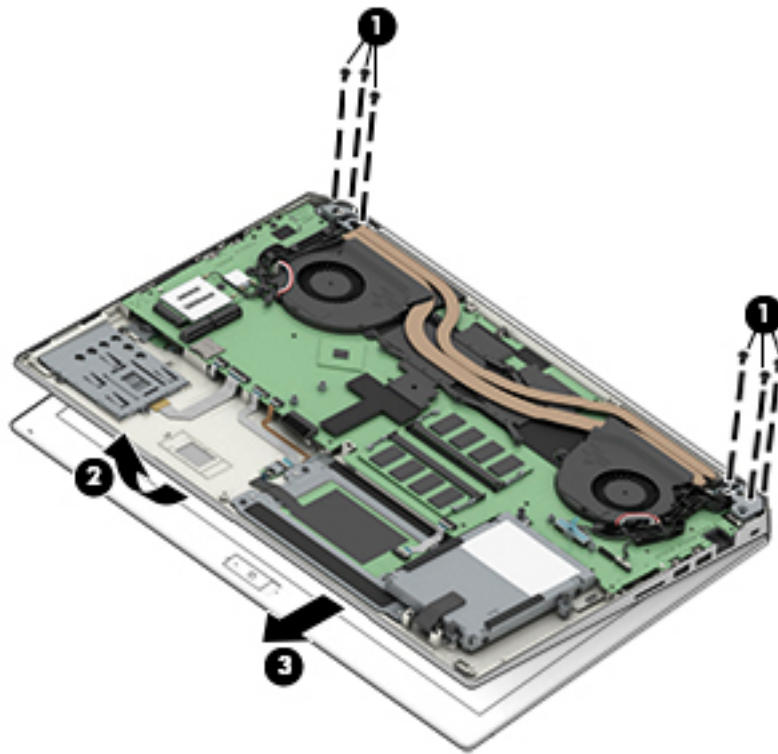

4. If it is necessary to replace the display assembly subcomponents:

- a. Flex the inside edges of the top edge **(1)**, the left and right sides **(2)**, and the bottom edge **(3)** of the display bezel until the bezel disengages from the display enclosure.
- b. Remove the display bezel **(4)**.

The display bezel is available using the following spare part numbers:

L68869-001: Models with a IR camera and transparent camera privacy cover

L68870-001: Models with a IR camera and black camera privacy cover

L68871-001: Models with an RGB camera and transparent camera privacy cover

L68872-001: Models with an RGB camera and black camera privacy cover

L70633-001: Models without a camera and a transparent camera privacy cover

L70634-001: Models without a camera and a black camera privacy cover

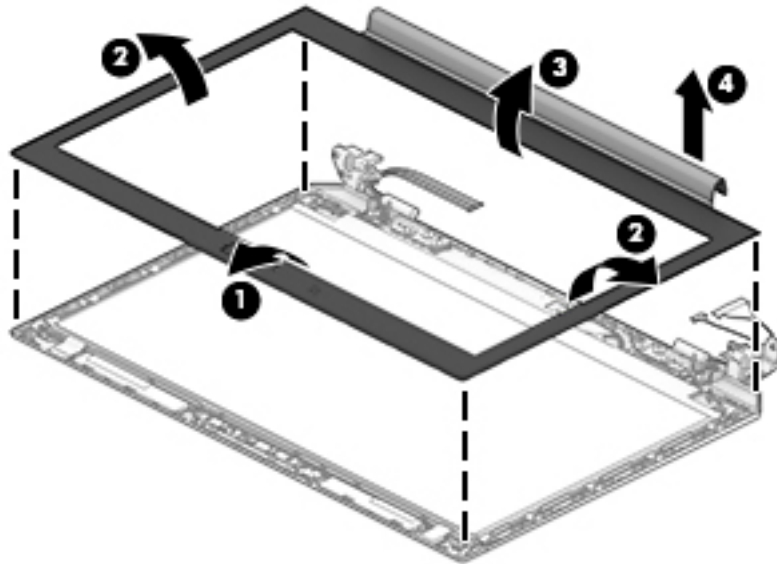

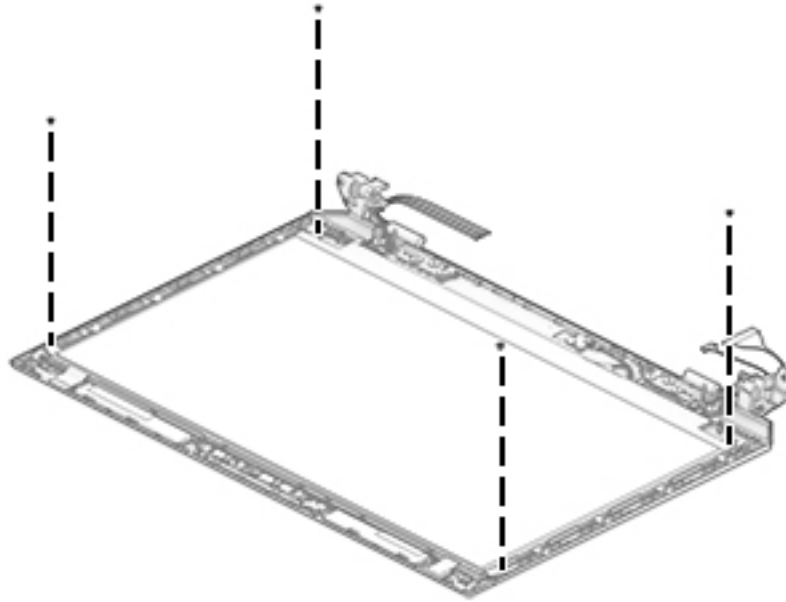

5. If it is necessary to replace the display panel:
 - a. **Non-privacy panels:** Remove the four Phillips M2.5 × 2.5 screws that secure the display panel to the display enclosure.

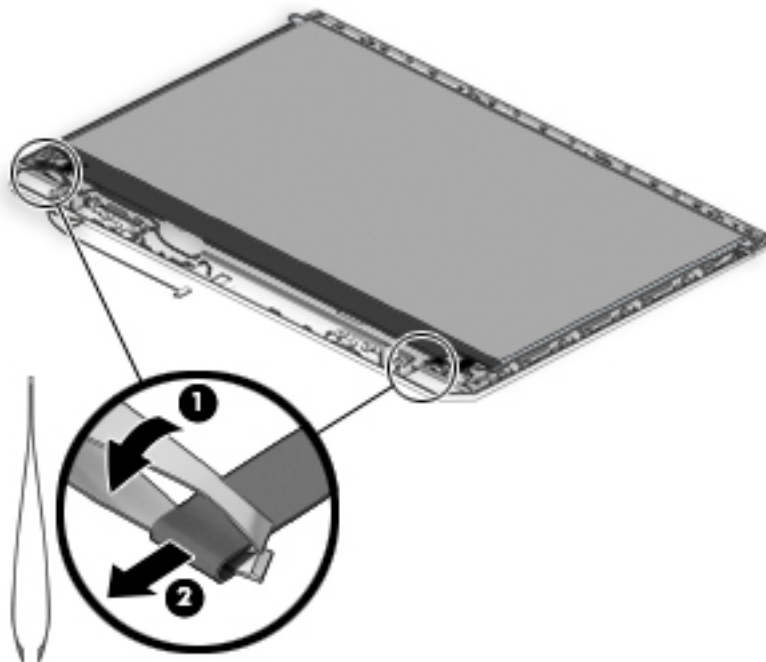

Privacy panels: Use a tweezer to grasp the end of the tape that routes behind the panel and wrap the tape around the tweezer **(1)** as you are pulling the tape out from behind both sides of the panel **(2)**

 **IMPORTANT:** Wrapping the tape around the tweezer and you remove it allows for a slow, even removal of the tape. Use care when removing the tape to avoid tearing it.



 **IMPORTANT:** Before turning the display panel upside down, make sure the work surface is clear of tools, screws, and any other foreign objects. Failure to follow this caution can result in damage to the display panel.

- b.** Lift the top edge of the display panel **(1)** and swing it up and forward until it rests upside down in front of the display enclosure.

- c. Release the adhesive strip that secures the display panel cable connector to the rear of the display panel **(2)**.
- d. Disconnect the display cable from the panel **(3)**.

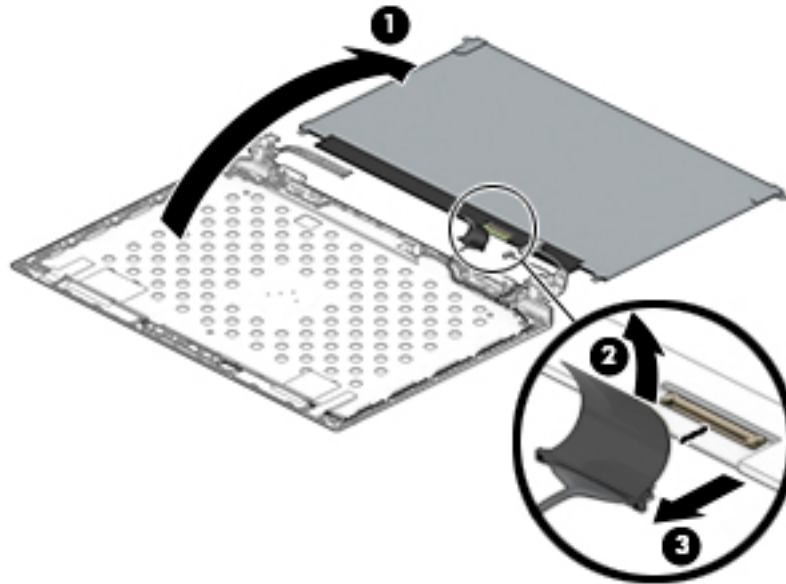

- e. Remove the display panel.
The display panel is available as spare part numbers L68848-001 (FHD, 250 nit, non-touch), L68849-001 (FHD, 400 nit, non-touch), L68850-001 (FHD, 1000 nit, non-touch), L68851-001 (UHD, 400 nit, non-touch), L68845-001 (touch, privacy), or L68846-001 (touch, non-privacy).
- f. Note the following tips when replacing a privacy panel:
 - i. Install the tape that secures the panel on the left and right sides of the inside of the display back cover. Position the top of both pieces of tape just below the gaskets along the top of the display back cover **(1)**, and then install the tape next to (but not touching) the insides of the gaskets **(2)** along the left and right sides of the display back cover.

 **IMPORTANT:** Make sure the tape does not touch the gaskets.

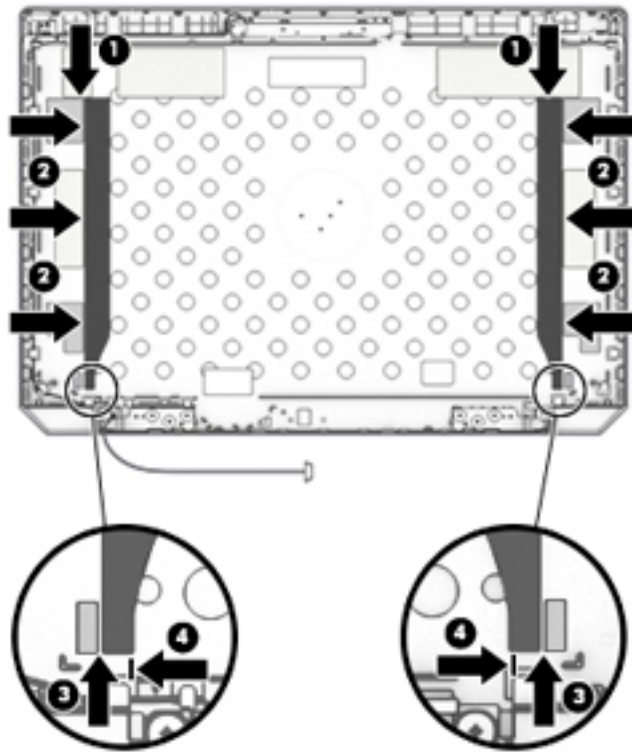

- ii. Position the display panel against the two rubber alignment bumpers near the left edge (1) and near the top edge (2) on the inside of the display back cover.

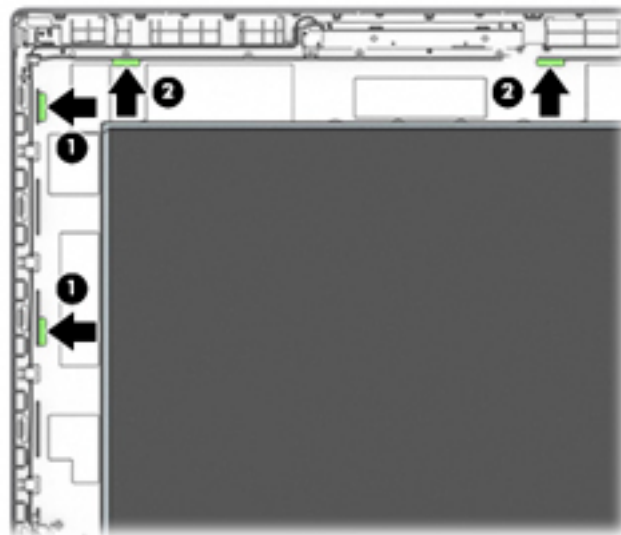

- 6. If it is necessary to replace the HD camera module:

 **IMPORTANT:** Handle the module with caution. These modules have a thin profile and are susceptible to damage when not handled carefully.

- a. Detach the camera module (1) and remove it from the display enclosure. (The camera module is attached to the display enclosure with adhesive.)

- b. Disconnect the cable (2) from the camera module.

The HD camera module is available as spare part number L68853-001.

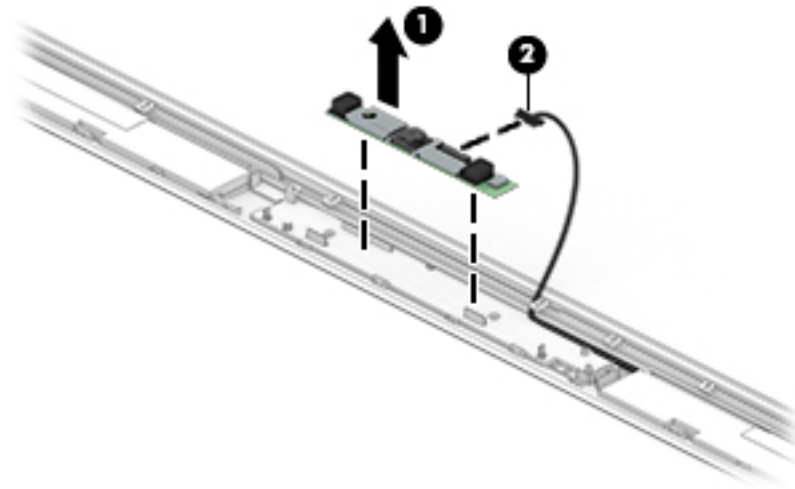

- 7. If it is necessary to replace the IR camera module:

CAUTION: Handle the IR module with caution. These modules have a thin profile and are susceptible to damage when not handled carefully.

- a. Detach the IR camera module (1) from the display enclosure and remove it from the display enclosure. (The camera/microphone module is attached to the display enclosure with adhesive.)
- b. Disconnect the left camera cable (2) and the disconnect the right camera cable (3) from the IR camera module.

The FHD/IR camera module is available as spare part number L68852-001.

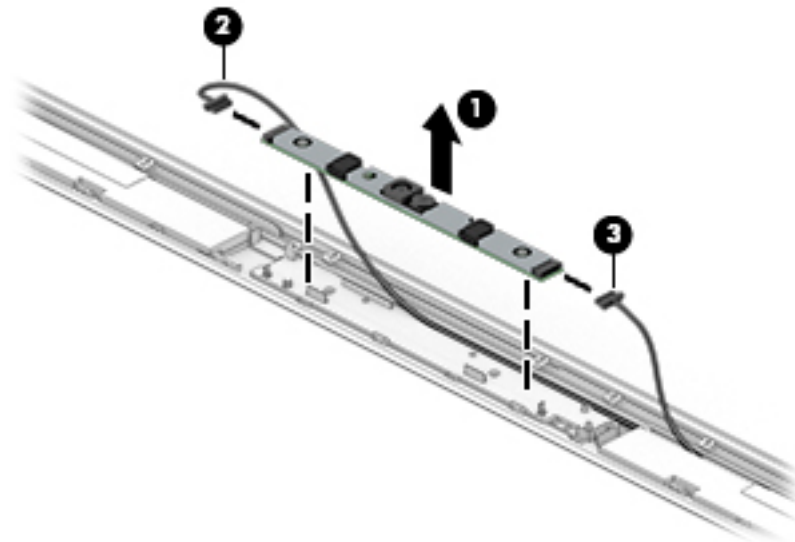

8. If it is necessary to remove the ambient light sensor board, disconnect the cable from the board **(1)**, and then lift upward to remove the board from the display **(2)**.

The ambient light sensor board is available as spare part number L70635-001.

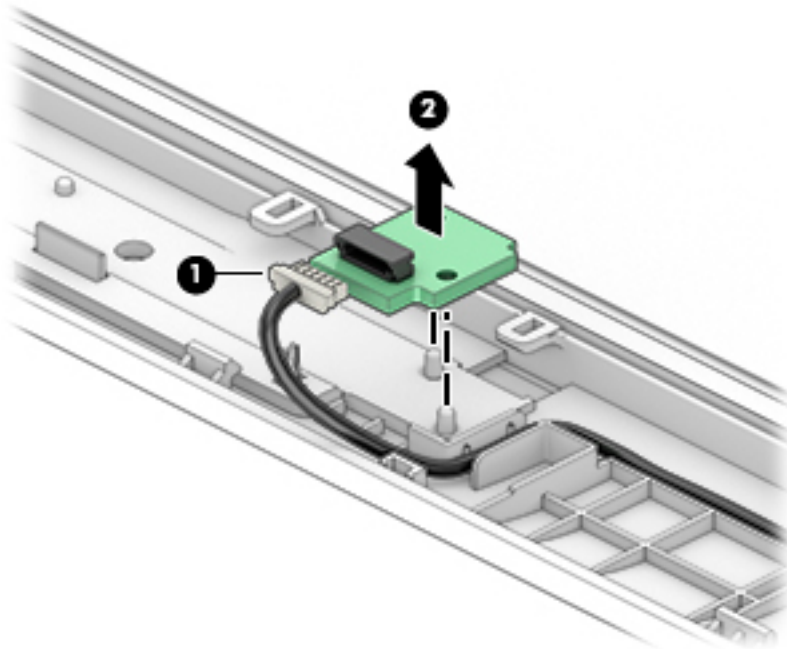

9. If it is necessary to remove the color board, disconnect the cable from the board **(1)**, and then lift upward to remove the board from the display **(2)**.

The color board is available as spare part number L70636-001.

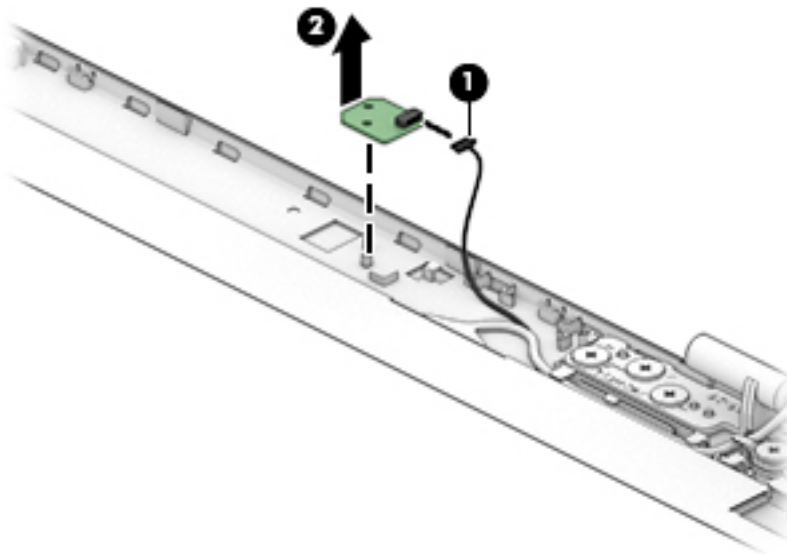

10. If it is necessary to replace the display hinges:

- ▲ Remove the eight Phillips M2.5 × 2.5 screws **(1)**, and then remove the display hinges from the enclosure **(2)**.

The display hinges are available as spare part number L28703-001 for non-touch models and L77464-001 for touch models. and include the left and right hinges.

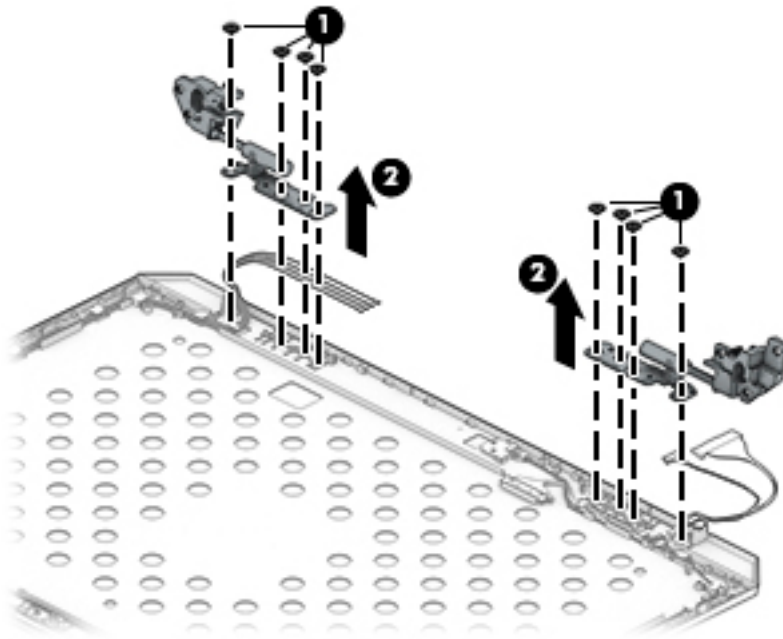

11. If it is necessary to replace the display and camera cables:

- a.** Remove the cables from under the tape on the left side of the display enclosure **(1)**.
- b.** Remove the cables from the enclosure **(2)**.

The display cable is available as spare part number L68873-001 for non-touch models and L77463-001 for models with a touch screen.

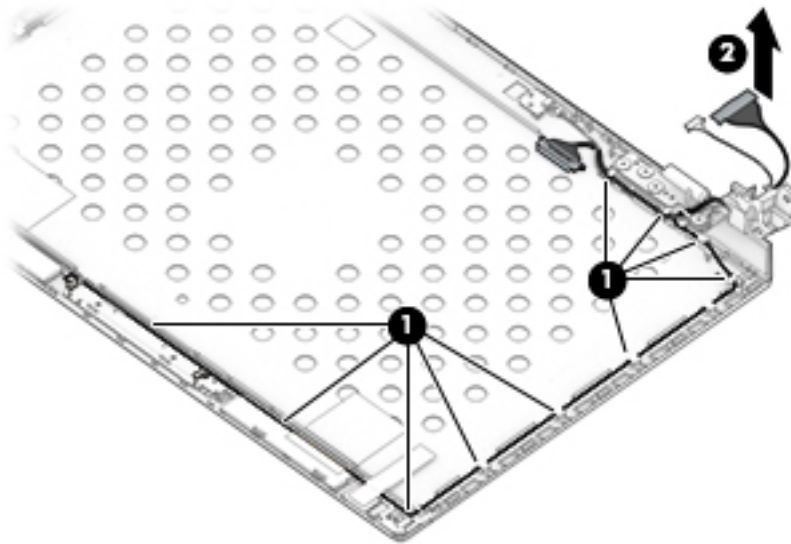

12. If it is necessary to replace the WLAN antennas, release the WLAN antenna cables from the routing channels built into the display enclosure (1), and then lift the cables from the display enclosure (2).

The WLAN antennas are available as spare part number L28740-001.

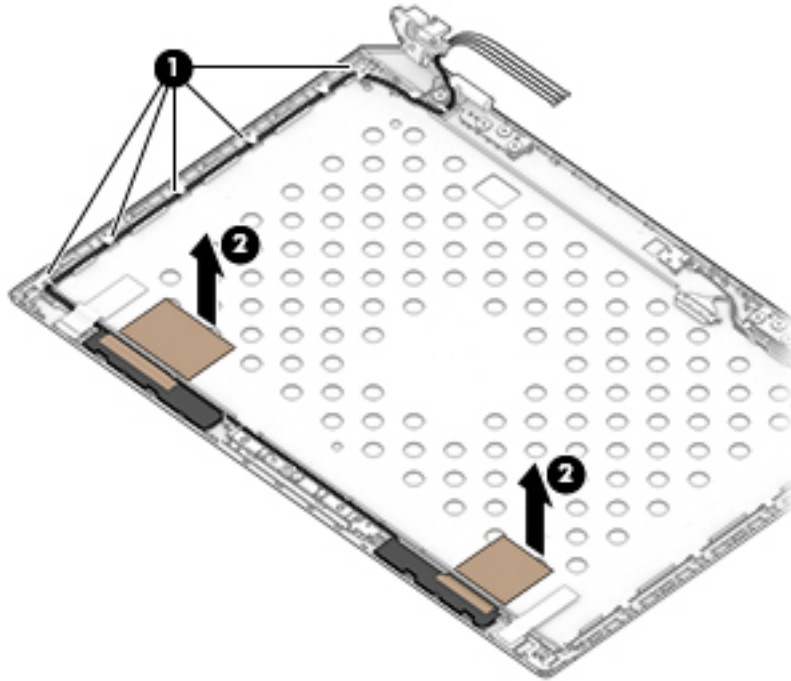

13. If it is necessary to replace the WWAN antennas, release the WWAN antenna cables from the routing channels built into the display enclosure (1), and then lift the cables from the display enclosure (2).

The WWAN antennas are available as spare part number L28740-001.

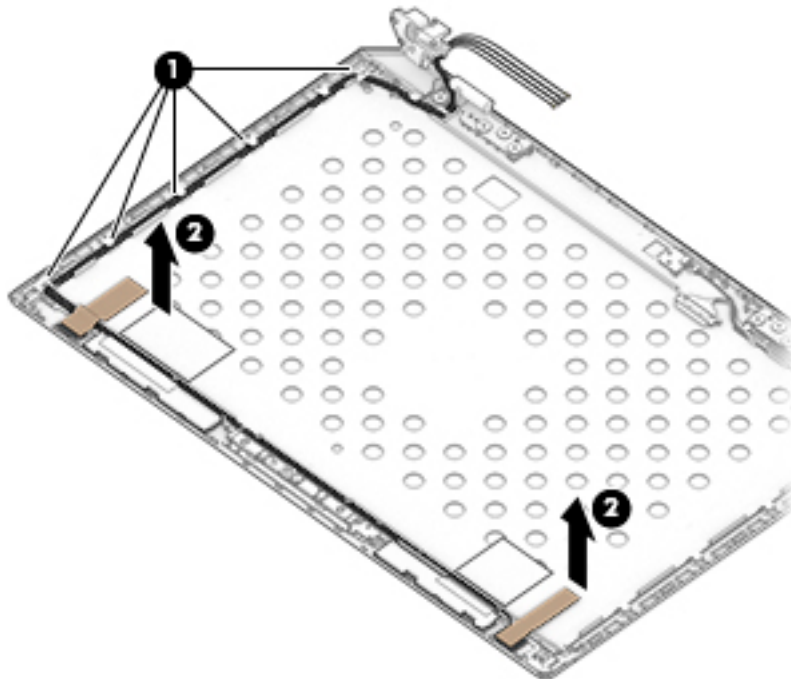

14. If it is necessary to replace the camera/ambient light sensor cable, release the cable from the routing channels built into the display enclosure (1), and then lift the cable from the display enclosure (2).

The ambient light sensor cable is available in the Cable Kit as spare part number L68854-001.

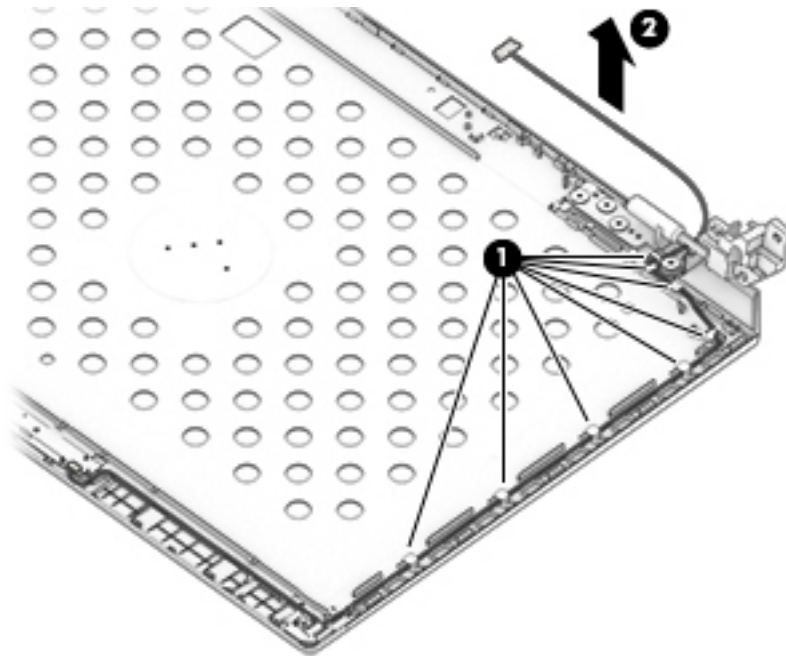

15. If it is necessary to replace the color board cable, release the cable from the routing channels built into the display enclosure (1), and then lift the cable from the display enclosure (2).

The color board cable is available in the Cable Kit as spare part number L68854-001.

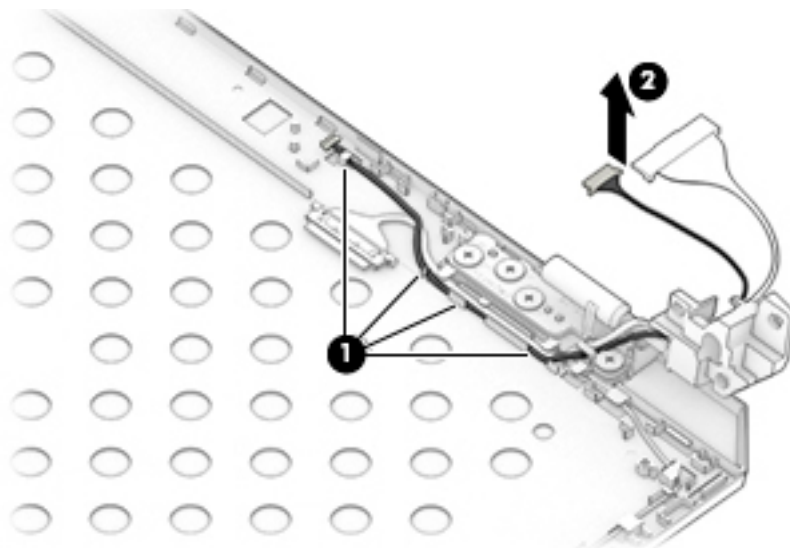

16. The back cover for FHD panels is available as spare part number L28702-001. The back cover for UHD panels is available as spare part number L34481-001. The back cover for touch panels is available as spare part number L68844-001. The back cover for privacy panels is available as spare part number L78818-001.

Reverse this procedure to reassemble and install the display assembly.

7 Troubleshooting guide

This chapter is primarily focused on troubleshooting HP Mobile Workstations and HP Notebooks. The information is provided so that you can solve problems yourself or at least narrow down what may be causing the problem. Based on some of the most common symptoms, this chapter helps to identify logical steps and available resources or tools for resolving an issue. HP recommends that you follow the instructions carefully, observe safety precautions, and note any observations or results. Capturing this information may help identify and resolve the problem faster.

 **WARNING!** To reduce the risk of electric shock or damage to the equipment:

- Do not disable the power cord grounding plug. The grounding plug is an important safety feature.
- Plug the power cord into a grounded (earthed) outlet that is easily accessible at all times.
- Disconnect power from the equipment by unplugging the power cord from the AC outlet.
- Before disassembling notebooks, always disconnect power and remove the battery.

 **CAUTION:** Static electricity can damage the electronic components of the computer. To prevent damage to the computer, carefully observe the electrostatic discharge precautions.

- Discharge static electricity by briefly touching a grounded metal object before you begin.
- Work on a static-free mat.
- Wear a static strap to ensure that any accumulated electrostatic charge is discharged from your body to the ground.
- Create a common ground for the equipment you are working on by connecting the static-free mat, static strap, and peripheral units to that piece of equipment.
- Refer to the Electrostatic Discharge Section of the Maintenance & Service Guide for more information.

CAUTION: The computer includes customer self-repair parts and parts that should only be accessed by an authorized service provider. See the chapter titled "Removal and replacement procedures for Customer Self-Repair parts," for details. Accessing parts described in the chapter titled "Removal and replacement procedures for authorized service provider only parts" can damage the computer or void the computer warranty.

Resources

HP Resource Tool	Description	Link
HP Elite Support	Provides live HP Premium support (available 24/7) to Elite computers.	http://www8.hp.com/us/en/ads/elite-products/overview.html
HP Troubleshooting Support page	Provides troubleshooting information for your specific HP computer.	http://www8.hp.com/us/en/troubleshooting.html
Subscribers Choice	Allows you to sign up for HP product updates.	http://www8.hp.com/us/en/subscribe/
HP Support Forums	Provide discussions about HP products and issues.	http://h30434.www3.hp.com/psg/
Service Access Workbench (SAW) (Available for technicians and Business Partners only)	Provides navigable content intended for use by internal and outsourced call center staff and can be a resource for support and product division professionals.	http://sawpro.atlanta.hp.com/km/saw/home.do
Vendors' web sites	Provide additional information for associated components such as Intel (processor, WLAN), Microsoft (Windows 7/8/10), AMD/NVidia (GPU), and so on.	http://www.intel.com/content/www/us/en/homepage.html http://www.amd.com http://www.nvidia.com

General troubleshooting steps

A basic logic should be used when troubleshooting computer issues. This section will help you become familiar with troubleshooting methodology and efficiently resolve problems. Proceed through the steps in the following table until the issue is resolved, and then move on to the next step that is relevant to the issue. For example, if you resolve a memory issue using the HP PC Diagnostics (UEFI) tool in step 6, you can then move on to step 10 to reseat the memory into its memory slot.



NOTE: General troubleshooting steps do not have to be followed in a specific order if an issue does not apply.

Table 7-1 Troubleshooting methodology and general troubleshooting steps

Identify issue	Analyze issue	Resolve issue	Verify solution
1. Understand the issue on page 81	5. Remove or uninstall recently added hardware, software on page 84	8. Hard reset on page 88	Verify solution on page 92
2. Examine the environment on page 83	6. HP Hardware Diagnostics and Tools on page 85	9. Soft reset (Default Settings) on page 89	
3. Perform a visual inspection of hardware on page 84	7. Status lights, blinking light codes, troubleshooting lights, and POST error messages on page 86	10. Reseat cables and connections on page 89	
4. Update BIOS and drivers on page 84		11. Test with minimum configuration on page 90	
		12. Test with verified working configuration (hardware and/or operating system) on page 91	
		13. Replace the system board on page 91	

Identify the issue

1. Understand the issue

It is important to understand the issue that occurred, including related symptoms. It helps to understand the basic computer boot-up sequence as well as the failure itself. The boot-up sequence and associated failures are described below.

Boot up sequence

The computer performs several steps after you press the power button or restart the computer.

It is important to understand where in the boot-up sequence the symptoms occur. The following table lists the phases of the boot-up sequence and explains the symptoms that may occur in each phase. For example, a blue screen error (BSOD) often occurs during the performance phase.

Table 7-2 Boot-up sequence

Item	Procedure
Power-on	After power button is pressed, the computer boots after all internal power rails (i.e., 5V, 3.3V) are stable. Confirm that power lights are on fan is spinning. Common issues: all lights are off; troubleshooting lights are on; does not boot; video is absent.
POST (UEFI/BIOS)	Power-On Self-Test (POST) verifies that hardware components (processor, hard drive, memory, etc.) are functional. When POST is complete, the HP logo displays briefly and then disappears. If there are errors, the computer may exhibit blinking lights and POST error messages Common issues: lights blink, error message appears, hangs.
Performance (operating system)	System boots to operating system, and Windows logo screen appears. Common issues: hangs (lock up/freezes), blue screen, video distorted, driver conflict, slow performance, display issue (dead pixel), I/O issue (no speaker sound), wireless/audio unavailable, noise. See Analyze the issue on page 84 table below for detailed troubleshooting information).

Failure classification

Failure classification is a breakdown of different types of failures and symptoms that could occur during the boot-up sequence. Table 3 and table 4 represent the failure classification for common notebook failures.

Table 3 categorizes failures by the boot-up sequence.

1. Power-on: Common issues are No Power, Recycle/Reboot, etc.
2. POST: Common issues are No Boot (have power), Light Flash or Diagnostics Error.
3. Performance: Common issues are Intermittent Loss of Power, Blue Screen, Hang, etc. In many cases, issues may be identified and associated with a particular hardware (i.e., display, storage).

Table 4 categorizes failures by hardware.

4. Display
5. I/O devices (Input/Output)
6. Storage
7. Mechanical

A single symptom can be listed under different groups. For example, No Video can belong to (1) Power-on or (4) Display; but Flickering when powered should be listed in (4) Display. Or, in another example, a blue screen

can be caused by a driver conflict in Performance (4), but it can also be caused by a defective hard drive under (6) Storage. Therefore, failures that share similar symptoms are noted.

If possible, make a record of the failure symptom, the phase of the boot-up sequence where the failure occurs, and the most likely location in the failure tree ([Table 7-3 Failure classification by boot-up sequence on page 82](#) and [Table 7-4 Failure classification by hardware devices and mechanical on page 83](#)). This will help isolate the issue and indicate the next steps. For example, when the computer is running the operating system, it may experience an issue with (4) Display, (5) I/O devices (keyboard, wireless, and so on), (6) Storage, or (7) Mechanical components (stuck buttons, thermal shutdown, and so on).



NOTE: “Uncategorized” is used if an issue found is not listed. For example, Bluetooth is offered on certain hardware configurations; therefore, a Bluetooth issue can be classified under “I/O Device” if needed.

Failure classification by boot-up sequence

Table 7-3 Failure classification by boot-up sequence

1. Power-on	2. POST	3. Performance
1. No Power on page 94	1. No video (with power) on page 100	1. Intermittent shutdown on page 104^a
2. Intermittent power-on, shutdown, reboot on page 96^a	2. Blinking lights on page 101	2. Blue screen (BSOD) error on page 129^b
3. AC adapter issue on page 97	3. Diagnostics error messages on page 102	3. Freeze at Windows Logo (hang/lockup) on page 107
4. Battery not recognized, not charging on page 98	4. BIOS password on page 103	4. Electromagnetic Interference (EMI) on page 108
5. Battery discharges too fast on page 99		5. No wake up on page 109
6. Burnt smell on page 100		6. Unresponsive on page 110
		7. Slow performance on page 110^c
		8. HP Smart Adapter warning message on page 111
		9. Incorrect time and date on page 111

^{a,b,c} similar symptoms

Failure classification by hardware devices and mechanical

Table 7-4 Failure classification by hardware devices and mechanical

4. Display	5. I/O devices	6. Storage	7. Mechanical
1. Display anomalies on page 112	1. Keyboard on page 118	1. Hard drive/solid-state drive not recognized on page 128	1. Fans on page 53
2. Dead pixel on page 114	2. Keyboard point stick on page 119	2. No boot to operating system (no read/write error) on page 128	2. Noise (sound) on page 132
3. No video (internal) on page 114^d	3. Keyboard backlight on page 119	3. Read-write error on page 129	3. Fan runs constantly on page 133
4. No video (external) on page 115^d	4. Touchpad on page 120	4. Slow performance on page 110^c	4. Stuck power button on page 134
5. DisplayPort/VGA on page 115	5. Network Connectivity Ethernet (RJ-45 jack) on page 120	5. Blue screen (BSOD) error on page 129^b	
6. HDMI on page 115	6. Network connectivity wireless (WLAN) on page 121	6. Noisy hard drive on page 130	
7. No or bad external video via docking on page 116	7. WWAN on page 122		
8. Incorrect or missing color/distorted image on page 116	8. USB on page 123		
9. Touch screen on page 117	9. Smart card reader on page 51		
	10. Speaker, headphone - audio issues on page 125		
	11. Thunderbolt (TB) on page 126		

^{b,c,d} similar symptoms

2. Examine the environment

It is important to examine the computer's environment. If you can quickly identify the cause of the issue, fewer resolution steps may be needed. Perform the following environment inspections:

- Check all cables and connections to be sure that there are no loose connections.
- Confirm that power sources are good, such as wall power type/adaptor (110V/220V ac), power strip. Test with a verified working AC outlet.
- Check for compatibility issues between the computer and third-party devices, peripherals, noncertified devices, incompatible hardware (i.e., Mac OS device). Incompatibility can result in blue screen errors, improper operation, and so on.
- Isolate the computer from sources of electromagnetic interference (EMI), such as cell phones, 2-way radios, floor mats, fans (and other electronic motors). EMI may contribute to a display freeze issue or lock-up.

3. Perform a visual inspection of hardware

It is important to do a visual inspection of the hardware itself. Perform physical inspection of the computer:

- Look for abnormalities such as a cracked display, dented battery, broken latches for battery bay, keyboard key caps popped out, dust over connectors, liquid spill over keyboard, etc.
- Look for signs of drop, movement, or vibration that may cause internal and external loose connections.

4. Update BIOS and drivers

 **IMPORTANT:** Whenever possible, update to the latest BIOS, firmware, and drivers before troubleshooting.

Note that some customer company policies prohibit updates. Check your company policy before taking action.

The updates may include fixes for your computer issues, and they may also enhance system performance. HP continually improves the update process to make it easier. The BIOS update can be done locally through a manual process, through an automatic installation, or through a remote installation on multiple units.

Manually updating BIOS and drivers

- See the Computer Setup chapters to manually update BIOS and drivers.
- Refer to specific BIOS update installation instructions that accompany the download.

Remotely deploying BIOS and drivers

Instead of manually searching for and downloading each SoftPaq, users and IT personnel can use two tools to identify and download all appropriate SoftPaqs for the selected HP models.

- HP SoftPaq Download Manager (SDM) is a software tool designed to streamline the download, extraction, and installation process of SoftPaqs, including BIOS and drivers.
- HP System Software Manager (SSM) is a software tool designed to simplify the deployment of SoftPaqs to HP computers.

Analyze the issue

5. Remove or uninstall recently added hardware, software

HP has designed this computer and validated it using a full-range hardware and software qualification matrix. If an issue appears to have started recently, it may be related to the recent addition of hardware or software. A good method to determine the root cause is to remove recently added components or uninstall applications one at a time and restart the computer when necessary.

 **IMPORTANT:** After you have completed the process of uninstalling hardware or software and are ready to reinstall, when installing a new device be sure that it is seated properly and all cables are correctly connected. After installing the device, restart the computer and make sure the new device is powered on. In addition, if the new device is a root cause of a problem, it could cause a conflict in drivers or incompatibility issues with other programs installed. For any new hardware you have added, be sure to install the latest drivers available from the device vendor website.

6. HP Hardware Diagnostics and Tools

HP offers different diagnostics and tools to diagnose hardware failure.

For more information, see [Using HP PC Hardware Diagnostics on page 157](#).

Non HP diagnostics tools

Windows-to-Go USB

Windows-To-Go USB is a Microsoft-based tool for Enterprise editions of Windows that can help in troubleshooting. You can find a process online about how to create a live Windows USB drive. For more information, see <https://technet.microsoft.com/en-us/library/hh831833.aspx>.

Intel Processor Diagnostic Tool

Determine what processor is in your computer and verify the processor operating frequency. The tool also tests specific processor features and performs a stress test on the processor. For more information, see http://www.intel.com/support/processors/sb/CS-031726.htm?iid=subhdr+tools_procdiagtool.

7. Status lights, blinking light codes, troubleshooting lights, and POST error messages

Carefully observe any behavior the computer may be exhibiting: status lights, blinking lights, and POST error messages during boot. It is important to understand what these indicators mean.

Status lights

See the chapter titled “External Component Identification” for light locations. The following table describes basic lights on the computer.

Component	Description
Power button	<p>When the computer is off, press the button to turn on the computer.</p> <p>When the computer is on, press the button briefly to initiate Sleep (Windows) or Suspend (Linux).</p> <p>When the computer is in the Sleep state, press the button briefly to exit Sleep (Windows) or Suspend (Linux).</p> <p>When the computer is in Hibernation, press the button briefly to exit Hibernation.</p> <p>CAUTION: Pressing and holding down the power button results in the loss of unsaved information.</p> <p>If the computer has stopped responding and operating system shutdown procedures are ineffective, press and hold the power button.</p>
Front power light	<p>On: The computer is on.</p> <p>Blinking: The computer is in the Sleep state.</p> <p>Off: The computer is off.</p>
Front AC adapter and battery light	<p>White: The computer is connected to external power and the battery is charged from 90 to 99 percent.</p> <p>Amber: The computer is connected to external power and the battery is charged from 0 to 90 percent.</p> <p>Blinking amber: A battery that is the only available power source has reached a low battery level. When the battery reaches a critical battery level, the battery light begins blinking rapidly. By default, the critical battery level is defined in Power Options as 5%.</p> <p>Off: The battery is fully charged.</p>
Front hard drive light	<p>Blinking white: The hard drive is being accessed.</p> <p>Amber: HP 3D DriveGuard has temporarily parked the hard drive.</p>
Rear AC adapter light	<p>White: The computer is connected to external power.</p> <p>Off: The computer is not connected to external power.</p>

Blinking light codes

During startup, the computer may not boot properly. If this occurs, blinking light codes that will help identify what is causing the issue. The computer uses the blinking lights below to identify a hardware component that reports an error during startup. For more information, see [Blinking lights and boot error codes on page 136](#).

Table 7-5 Boot-error codes

Blink codes	Error
Amber battery light: blinks 1 Hz continuously	Embedded controller unable to load firmware
Caps/num lock lights = 1 blink	Processor not executing code
Caps/num lock lights = 2 blinks	BIOS recovery code unable to find valid BIOS recovery image
Caps/num lock lights = 3 blinks	Memory module error
Caps/num lock lights = 4 blinks	Graphics controller error
Caps/num lock lights = 5 blinks	System board error
Caps/num lock lights = 6 blinks	Intel Trusted Execution Technology (TXT) Error
Caps/num lock lights = 7 blinks	Sure Start unable to find valid BIOS Boot Block image
Caps/num lock lights = 8 blinks	Sure Start has identified a problem (Manual Recovery Policy Set)

POST error messages

The Power-On Self-Test (POST) is a series of diagnostic tests that runs automatically when the computer is powered on. If the POST encounters a problem, visual error messages are displayed before the operating system starts. POST checks the following items to ensure that the computer system is functioning properly:

- Memory
- Processors
- BIOS
- Mass storage devices
- Fans

The following table describes errors encountered during HP PC Hardware Diagnostics (UEFI).

Table 7-6 System diagnostics failure codes and user actions

Test description	Failure description	Error code	Suggested user actions
Startup Test	Memory module	200	Attempt to reseat the memory module and then repeat the test. For details on troubleshooting issues related to the memory module, search for support documentation at http://www.hp.com/support .
Startup Test	Hard Disk 1 SMART	301	Attempt to reseat the hard drive and repeat the test. The hard drive may have failed.
Boot Device Manager	Boot device not found	3F0	Reset BIOS. Then reseat the hard drive and repeat the test.
BIOS Recovery	BIOS Recovery Occurred	500	This message indicates that BIOS recovery was completed successfully. No further action is required.

Table 7-6 System diagnostics failure codes and user actions (continued)

Test description	Failure description	Error code	Suggested user actions
BIOS Application	BIOS Application Error	501	The BIOS installation may have become corrupted. Download the latest version of the BIOS and install it. If reinstalling the BIOS fails, contact support for further assistance.
CMOS Recovery	CMOS Recovery Occurred	502	This message indicates that CMOS recovery was completed successfully. No further action is required.
Battery Check	Primary Battery Replace	601	This message indicates that the primary battery has very low capacity. Search for support documentation at http://www.hp.com/support for details on using the HP Support Assistant to verify the battery capacity and, if necessary, order a replacement.
Wireless Modules	Not installed or responding	701	Reseat the wireless LAN adapter module and antennas. Because seating or reseating a wireless LAN adapter is unique to each computer model, see the WLAN module removal section in the removal and replacement chapter for further details. Contact support if third-party wireless adapters are installed in the computer.
Fan	Fan not operating correctly	90B	The system fan may be malfunctioning. Replace the fan.

Resolve the issue

8. Hard reset

A hard reset (or forced reset) erases all information in the computer's memory and may restore functionality. Resetting the computer forces the system to clear and reestablish the connections between the BIOS and the hardware. For more information, see <http://support.hp.com/us-en/document/c01684768>.

Performing a hard reset might fix the following common conditions:

- Windows stops responding.
- Computer stops before Windows loads, indicated by incomplete boot-up, blinking cursor on a black background, and errors relating to operating system not found or a missing drive.
- Display suddenly goes blank and stays blank.
- Software freezes.
- Keyboard stops responding.
- The computer does not exit Sleep or Suspend state.
- An external device stops responding. Turn off the power to that device in addition to performing the steps in this document.

Before performing a hard reset, you must disconnect or remove all peripheral devices. You should start and test the computer by itself, and if the problem is not resolved, reconnect one peripheral device at a time. To resolve the startup or operational problem, run HP Support Assistant, or manually install all updated drivers from Microsoft and HP.

Before beginning, turn the computer over and look for a battery compartment door (service door). For 2015 platforms, the battery is considered removable but not accessible. See the battery section for how to remove/unplug the battery.

To perform a hard reset on a computer with a sealed or non removable battery, use the following steps:

1. Turn off the computer.
2. Remove the computer from any port replicator or docking station.
3. Disconnect all external connected peripheral devices such as USB storage devices, external displays, and printers.
4. Unplug the AC adapter from the computer.
5. Disconnect the battery.
6. Press and hold the power button for at least 15 seconds to drain residual power.
7. Reconnect the battery and plug the AC adapter back into the computer, but do not connect any of the peripheral devices.
8. Press the power button to turn on the computer.
9. If a startup menu appears, use the arrow keys to select **Start Windows Normally**, and then press the **Enter** key.
10. After reconnecting each of the peripheral devices, run Windows Update and HP Support Assistant to update all device drivers.

Clear CMOS

CMOS refers to the battery-powered, semiconductor chip located on computer's system board. Notebooks store low-level settings like the system time and hardware settings in CMOS. Sometimes it is necessary to clear CMOS, which requires removing and reinserting the 3V RTC battery for a short period of time (a few minutes before reinserting), in addition to removing the AC adapter and battery.

 **NOTE:** Clearing the CMOS should only be performed for troubleshooting purposes. There is no reason to clear CMOS if the computer is working properly.

The notebook service door must be removed to access the CMOS battery. If the computer has a replaceable RTC battery, see the RTC battery replacement section for the battery removal/replacement.

9. Soft reset (Default Settings)

 **NOTE:** Some company policies prohibit updates or changes. Check whether the computer has custom BIOS settings before taking action.

If your computer is having issues booting, has errors during boot, is running into issues after adding hardware, or you are having other abnormal system behaviors that cannot be resolved through any other methods (i.e., hard reset), it may be necessary to reset the system BIOS to default settings.

To load BIOS to default settings: Reboot the computer, and then press **F10 > Main > Restore defaults**. For more information, see the BIOS F10 Setup technical white paper at <http://support.hp.com>, enter your computer model, and then go to **Manuals > White papers > HP PC BIOS F10 Setup Guide**.

10. Reseat cables and connections

 **NOTE:** Before disassembling the computer to reseat cables and connections, always disconnect power and remove the battery or disconnect a non removable battery.

Many problems are caused by improper connections or loose connections due to abnormal movement and vibration. See [Cable management on page 147](#) and [Connector types on page 148](#) for suggested cable management practices when removing and installing components.

You can access and reseat connections for Customer Self-Repair (CSR) parts (see the “Removal and replacement procedures for Customer Self-Repair parts” chapter for details). Examples of reseating hardware include:

- Reseating the battery into the battery bay can resolve no-battery found and no-charging issues.
- Reseating memory modules can resolve memory error, no-boot, and blue screen issues.
- Reseating the hard drive can resolve a POST error 3F0 (no boot device) issue (see [POST Error Messages and User Actions on page 138](#)).
- Reseating the keyboard cable can resolve an unrecognized keys error.
- Reseating the wireless module and antenna cable can resolve a wireless connection issue.

For field replaceable units (FRUs), authorized service providers can try the following steps (for more information, see the “Removal and replacement procedures for authorized service provider parts” chapter).

- Reseating the fan cable can fix POST error 90B (no fan detected) issue (see [POST Error Messages and User Actions on page 138](#)).
- Reseating the power cable can fix a no boot issue.
- Reseating the daughterboards (some models may have a power button board, VGA board, etc.) can resolve their functional issues.
- Reseating graphics cables and panel connectors can fix distorted/flickering video.
- Replacing thermal pads may resolve thermal power-down issue.

11. Test with minimum configuration

The factory-shipped computer (hardware configuration and preinstalled operating system image) is well tested and ready for use. Therefore, using the original factory hardware configuration and/or booting to operating system safe mode often resolves issues quickly.

- Disconnect any external USB storage, remove any discs in optical drives, remove the computer from a docking station, remove external video, etc.
- In addition to removing recently added components, the issue can be narrowed down further with a minimum configuration. For example, if HP PC Diagnostics reports a memory error, test one memory module at a time to isolate the defective module.
- If the computer does not successfully boot the operating system, booting to safe mode may help identify what may be causing the issue as described below.

Essential hardware configuration



NOTE: This step is to be used by authorized service providers only. HP will not honor the warranty for a system tested with the system board removed without the heat sink, fan, etc.

If none of the steps above resolve the issue, start the computer with essential hardware only. The purpose is to remove as much as hardware as possible while still maintaining the computer’s ability to turn on.

This essential configuration is often used to troubleshoot power-on related issues, such as no-boot, reboot, and freezing issues.

The essential hardware consists of the following:

- System board
- AC adapter (unplug nonremovable battery or remove battery)
- Processor (and heat sink/fan). (Processor may be integrated into the system board.)
- Memory (one verified working memory DIMM)
- Graphics card (if no VGA port is available on the system board). Platform may have both Intel integrated graphics and discrete graphics. Therefore, discrete graphics card may not be needed.
- External VGA monitor
- External USB keyboard
- External mouse



NOTE: After the service door is removed, disconnect all connections (internal keyboard, display, discrete GPU, hard drive/solid-state drive, daughterboards, etc.) to achieve the essential hardware configuration above. DO NOT disassemble the system board from its enclosure at this time.

Reverse the procedure above by reinstalling each piece of hardware removed, one piece at a time, and testing your computer after each installation. Since your computer works with only the essential hardware installed, those parts must be working properly. This means that one of the hardware components removed is causing the computer to not work properly. By installing each device back into the computer and testing each time, the failing hardware will eventually be identified.

Safe mode

A driver conflict often results in a blue screen error message. Therefore, booting in safe mode can resolve many issues in Windows because safe mode forces the computer to load a limited version of Windows which only contains essential files. Safe mode is useful for troubleshooting problems with programs and drivers that might not start correctly or that might prevent Windows from starting correctly.

If a problem does not reappear when you start in safe mode, eliminate the default settings and basic device drivers as possible causes. Refer to the links below for how to start your computer in safe mode:

- <http://support.hp.com/us-en/document/c01835750>
- <http://support.hp.com/us-en/document/c03439317>

12. Test with verified working configuration (hardware and/or operating system)

One troubleshooting technique that can quickly isolate an issue is using a verified working part while testing. A good example is to use an external keyboard, mouse, or VGA monitor when you have issues with an internal keyboard, touchpad, or display. Testing with a verified working AC adapter can identify an error caused by a faulty one. Similarly, testing with a verified working operating system can determine bad behaviors of the current operating system. See [Non HP diagnostics tools on page 85](#) for instructions about obtaining and using a Windows-To-Go USB.



NOTE: In some situations, more than one item may contribute to a problem.

13. Replace the system board

The system board may be replaced only by authorized service providers. This should not be considered an initial step taken to resolve an issue. Review and perform all steps discussed previously before replacing the system board. [4. Update BIOS and drivers on page 84](#), [7. Status lights, blinking light codes, troubleshooting lights, and POST error messages on page 86](#), [8. Hard reset on page 88](#), and [9. Soft reset \(Default Settings\)](#)

on page 89, and/or [10. Reseat cables and connections on page 89](#) can resolve many system board issues without requiring the effort of replacing unnecessary hardware.

Review [Table 7-1 Troubleshooting methodology and general troubleshooting steps on page 80](#) for appropriate troubleshooting steps.

 **IMPORTANT:** System board failure is not common. Do not replace the system board until you have tried all other troubleshooting options.

 **NOTE:** Determine whether a previous service case might be related to the current problem. For example, a fan detection issue may be caused by a loose connection resulting from previous service.

 **TIP:** Without an RTC battery (3V coin-cell battery), the computer automatically reboots. This is a useful feature when the power connector cable (between external AC adapter and system board) is defective.

 **NOTE:** Most of the time, effective troubleshooting can prevent a system board replacement.

Items that may prevent resolution of the issue:

- The information provided about the issue omits key details, including any actions taken before the issue occurred.
 - BIOS, software, and drivers have not been updated.
 - Cables or connections are loose.
 - Technician is unaware of information available from the HP Support website (i.e., CA - Customer Advisory).
 - The issue is related to existing or known issues that may be identified in existing support articles.
 - Technician may have omitted steps in the provided repair instructions (e.g., Spare Part Replacement Instructions).
 - Skipping one of steps from Troubleshooting Methodology table results in No Defect Found (NDF)/No Fault Found (NFF)/No Issue Detected (NID) messages.
-

Verify solution

- Verify that the implemented solution works. Reboot the system or device and try to complete the task that produced the issue.
- If a part has been replaced, verify other basic functions. For example, GPU replacement requires keyboard removal. Therefore, it is good practice to verify all basic components to be sure that the solution is complete.
- Explain to the customer why the issue occurred and what was done to resolve it. If the solution you used was in an HP Public document, provide the document information to the customer, letting them know it can be located on www.hp.com. Also, tell them that there are other solutions available on the website. Advise the customer to check the website first when they have an issue. It may save them time calling in.
- Document the correct issue. Update the case with as many details as possible for other agents and engineering to analyze and study for lessons learned.

Helpful Hints

After you become familiar with the general troubleshooting steps above ([General troubleshooting steps on page 80](#)), follow the helpful hints below before running diagnostics and troubleshooting.

At startup

 **TIP:** If you have installed an operating system other than the factory-installed operating system, go to <http://www.hp.com/go/quickspecs> and verify that it is supported on your system.

1. Be sure that the computer is plugged into a working AC outlet.
2. Be sure that power is connected to the docking station if a dock is used.
3. Be sure that the AC adapter light is on.
4. Be sure that the AC adapter is connected when you update BIOS to avoid BIOS corruption.
5. Be sure that the computer is turned on, the rear power light is solid white (connected to an external power source) and the front power light is solid white (normal operation).
6. Remove all optical and flash drives from your system before turning it on.
7. Be sure that the boot option is set to a working operating system drive.
8. Be sure that externally connected monitors are turned on and their power lights are on. Not all monitors are equipped with lights to indicate their functionality.
9. Turn up the brightness and contrast controls of a display or external display device if the screen is dim.

During operation

1. To wake the computer:
 - a. Press the power button or any key on the keyboard.
 - b. If the system remains in the Sleep (Windows), Suspend (Linux), or Hibernate state, shut down the system by pressing and holding the power button for at least four seconds.
 - c. If the system does not shut down, unplug the power cord, wait a few seconds, and then plug it in again. Then press the power button again to restart the system. If it does not turn on, press the power button to start the computer.
2. Look for blinking lights on the computer. The blinking lights could be error codes that will help diagnose the problem.
3. Check all cables for loose or incorrect connections (external devices, power cords, dock, etc.).
4. After installing a non-Plug and Play expansion board or other option, reconfigure the computer. For example, if you upgrade to a solid-state drive, you may need to reconfigure the boot order.
5. Be sure that all required device drivers have been installed. For example, if you have connected a printer, you must install a printer driver.
6. If there is a network connection issue, plug another computer with a different cable into the network connection. There might be a problem with the network plug or cable.
7. If hardware has recently been installed, remove it and determine whether the computer functions properly.
8. If software has recently been installed, uninstall it and determine whether the computer functions properly.
9. If the screen is blank, confirm the display choice by pressing **Windows logo**  + **P** and set to screen only. Or plug an external monitor into a different video port on the computer if one is available and close the computer lid.

10. Verify that the latest version of BIOS, drivers, and software are installed. A new release might support new features or fix the problem.
11. Press the **caps lock** and/or **num lock** key. If the **caps lock** and/or **num lock** light toggles on or off, the keyboard is likely operating correctly.
12. Press the touchpad On/Off button light. If the light toggles on or off, the touchpad is likely operating correctly.

Consulting with HP Service

If further HP support is required, a lot of the following information may be requested when you call, so it may be helpful to take notes.

- Technical support registration number (if applicable)
- Product serial number
- Product model name and number
- Product identification number
- Applicable error messages
- Add-on boards or hardware
- Third-party hardware or software
- Operating system type and revision level

Common issues and possible solutions



This section contains common issues, symptoms, and a series of tables that describe possible solutions to issues from [Failure classification on page 81](#) tables. The following sections identify the issue with symptoms and solutions to resolve an issue.

Power-on issues

No Power

When a unit experiences no power there are several contributing factors to consider. Be sure to consider all symptoms related to this behavior in troubleshooting.

Items	Procedures
<p><i>Symptoms</i></p> <ul style="list-style-type: none"> • Computer does not start • Display is black or blank • No fan noise • No hard drive spinning • Lights do not glow 	<p><i>Possible causes</i></p> <ul style="list-style-type: none"> Failed power input to the computer (external power source, AC adapter, faulty battery). Bad connection to the computer (bad power button, power connector). Defective parts (memory, hard drive, graphics) or failed system board.
	<p><i>Troubleshooting steps</i></p> <p>Perform quick check</p> <p>Remove all external devices, including docking station.</p>

Items	Procedures
	<p>Verify external power source (2. Examine the environment on page 83).</p> <p>Perform a hard reset (8. Hard reset on page 88).</p>
	<p>Verify AC adapter</p> <p>It is preferable to verify the battery before verifying the AC adapter. However, you can verify the AC adapter first, before opening the service door for a battery check.</p> <ul style="list-style-type: none"> • Verify AC adapter is compatible with product. Verify that the part number is for this computer if possible. • Verify AC adapter and power cord are good (no physical damage, bent middle ID pin). • Verify AC adapter works on a verified working computer. • Plug in AC adapter and power on computer without battery. • Inspect power port on computer side for any damage, dust, or debris. • Check power light (7. Status lights, blinking light codes, troubleshooting lights, and POST error messages on page 86). Rear power light indicates external power to the computer is good.
<p>NOTE: Refer to battery replacement section for removing/replacing the battery</p>	<p>Verify battery condition/status</p> <ol style="list-style-type: none"> 1. Check battery condition (overall result, cycle life, voltage, etc.) using HP PC Hardware Diagnostics (UEFI) or HPSA tools. 2. Verify that battery is installed properly in battery bay without a gap and that latch locks are tight (for models with removable batteries). 3. Check battery status light (7. Status lights, blinking light codes, troubleshooting lights, and POST error messages on page 86). Be sure that battery is not fully discharged, preventing system from booting. 4. Determine whether the computer can turn on with battery only. 5. Remove service door and test with a verified working battery. If the computer boots, inspect original battery before replacement. 6. Test battery with a verified working computer to verify that it is OK. 7. If there is still no boot, remove battery and boot on AC power only.
<p>The sections below are intended for authorized service providers/technicians.</p>	
	<p>Verify AC adapter – voltage</p> <ol style="list-style-type: none"> 1. Measure DC voltage output that should be around 19.5 VDC and acceptable voltage range is from 18.5 – 20.5 VDC. 2. If the DC voltage is out of range, replace the AC adapter. <p>NOTE: This action requires a digital voltmeter.</p>
<p>NOTE: Some models include a power cable between the system board and chassis power connector.</p>	<p>Verify power button, power connector</p> <ol style="list-style-type: none"> 1. Be sure that power button is not stuck. 2. Reseat power connector cable (if applicable). 3. Replace new power connector cable (if the cable exists and is defective) 4. To isolate faulty power connector cable and power button, technicians can short power-on pads/pins to power up the computer. Contact HP Engineering for this information.
	

Items	Procedures
	<p>Verify blinking lights (7. Status lights, blinking light codes, troubleshooting lights, and POST error messages on page 86)</p> <p>At this point, there should be sufficient power from the AC adapter to the system board. Expect to hear the fan spinning and see blinking lights or error messages (i.e., faulty memory, HDD, etc)</p>
	<p>Verify system board</p> <ol style="list-style-type: none"> 1. Test essential hardware configuration (11. Test with minimum configuration on page 90, 12. Test with verified working configuration (hardware and/or operating system) on page 91, 13. Replace the system board on page 91) by removing nonessential parts. 2. If there is still no boot, replace system board.
Tips and tricks	<p>Computer automatically boots without pressing power button when RTC 3V battery has been removed. Therefore, after the service door and RTC 3V battery are removed, no need to press power button from top side.</p> <p>In essential hardware configuration, mWS G1 and G2 may require discrete GPU to boot. However, mWS G3 can boot with integrated graphics.</p>

Intermittent power-on, shutdown, reboot

Items	Procedures
<i>Symptoms</i>	<i>Possible causes</i>
<ul style="list-style-type: none"> • Does not always turn on • Intermittently hangs • Intermittently shuts down • Spontaneously reboots 	<p>Electrical short, fluctuating power source, unstable power rails, loose connections, bent pins, stray wires, dust, obvious damage, nearly faulty parts (bulging/leaking capacitor).</p> <p>Potentially will turn into a no power issue soon (No Power on page 94).</p>
	<i>Troubleshooting steps</i>
	<ol style="list-style-type: none"> 1. Visually check power ports on both AC adapter and computer sides. 2. Inspect power sources: <ol style="list-style-type: none"> a. Verify AC adapter working correctly. Use a confirmed working adapter to test. b. Verify that battery is not depleted while system is in Sleep state. Test with a confirmed working battery.

The sections below are intended for authorized service providers/technicians.

1. Follow actions in [No Power on page 94](#).
 - a. Be sure that AC adapter has correct DC voltage.
 - b. Verify battery - test with a confirmed working battery.
 - c. Verify that power button is not stuck.
 - d. Verify that power connector is not loose.
 - e. Remedy loose connections and reseat major components (processor, memory, GPU, hard drive/solid-state drive, etc).
2. Perform visual check for loose connections, bent pins, stray wires, dust, nearly faulty parts (bulging/leaking capacitor).

Items	Procedures
	<ol style="list-style-type: none"> 3. Test essential hardware configuration (11. Test with minimum configuration on page 90) <ol style="list-style-type: none"> a. If system boots, reinstall nonessential hardware one component at a time to isolate issue. b. If system does not boot, replace essential hardware with verified working parts, one component at a time. If system still does not boot, replace system board.

AC adapter issue

Solution	
<i>Symptoms</i>	<i>Possible causes</i>
<ul style="list-style-type: none"> • No sign of power • No boot • No rear power light • No front power light • Battery does not charge when AC adapter is connected 	AC adapter and others (i.e., external power source)
	<i>Troubleshooting steps</i>
	Quick check
	<ol style="list-style-type: none"> 1. Verify external power source (2. Examine the environment on page 83). 2. Remove all external devices, including docking station. 3. Perform a hard reset for the computer (8. Hard reset on page 88). 4. Disconnect and reassemble the power cord and adapter in case the adapter experienced short circuit, over current, over temperature events. 5. Use a verified working adapter. If the computer operates normally, there is a problem with the original adapter. 6. Verify that the AC adapter works on a verified working computer. If the computer operates normally, there is no problem with the adapter. See HP Smart Adapter warning message on page 111 for further information.
	Verify AC adapter
	<ol style="list-style-type: none"> 1. Remove working battery. 2. Verify that AC adapter is compatible with product. Verify that part number is for this computer if possible. 3. Inspect AC adapter and power cord for physical damage, bent middle ID pin. 4. Plug in AC adapter and power the computer without battery. 5. Inspect the power port on computer side for any damage, dust, debris. 6. Check power light (7. Status lights, blinking light codes, troubleshooting lights, and POST error messages on page 86). Rear power light indicates that external power to the computer is good. 7. If there is still no rear power light or no boot, replace the AC adapter.
Tips and tricks	<p>The HP Smart AC adapter has a special pin in the middle, called the ID pin, for power rating and throttling purpose. If this pin is broken, the rear power light will be on but the power button and front power lights will blink continuously and the computer will not turn on. Third party AC adapter will not work on the computer.</p> <p>Use the AC adapter that came with the computer for better performance.</p>

Battery not recognized, not charging

Items	Procedures
<i>Symptoms</i>	<i>Possible causes</i>
<ul style="list-style-type: none">• No battery status light• Blinking amber (critically low battery level)• No boot without AC adapter	<p>Defective AC adapter and/or battery.</p> <p>NOTE: Before proceeding, verify that the computer can boot to BIOS or Windows with a good AC adapter.</p>
	<i>Troubleshooting steps</i>
	Visual inspections
	<ol style="list-style-type: none">1. Inspect battery connectors for any signs of damage.2. Verify that battery is installed properly in battery bay without gap or obstructions and latch locks are tight. Reseat battery (for models with removable batteries).3. Determine whether battery gets hot (batteries heat up when charging, but not too hot to touch).
	<p>Check battery warranty to see whether the battery is new or its warranty is expired. Battery capacity degrades over time.</p>
	Verify front battery status light
	<ol style="list-style-type: none">1. Battery status light is off: battery not recognized.2. Battery status light is blinking amber: critically low battery level.
	Reset
	<ol style="list-style-type: none">1. Hard reset (8. Hard reset on page 88)2. Soft reset (9. Soft reset (Default Settings) on page 89)
	Verify AC adapter
	<ol style="list-style-type: none">1. Determine whether the computer needs the AC adapter to boot and operate. Sometimes, intermittently bad AC adapter and loose connection between adapter and computer results in inability to charge battery which causes short run time.2. Inspect AC adapter to verify that it is functioning.3. Test with a working AC adapter and confirm whether battery is charging.4. Be sure that battery is fully charged (AC adapter plugged in at least 2.5 hours).
	<p>Diagnostics: HP tools will report results such as passed, calibrate, weak, replace, no battery and unknown, and suggest corresponding actions.</p>
	<p>Use HP Hardware Diagnostics (UEFI) (6. HP Hardware Diagnostics and Tools on page 85)</p>
	<ul style="list-style-type: none">• HP PC Hardware Diagnostics (UEFI) is a good tool to use to isolate and determine faulty battery, especially for quickly discharging (short life) battery.
	Use HP Support Assistant tools in Windows
	<ol style="list-style-type: none">1. Verify that battery is recognized and charging.2. Verify battery condition if battery cycle life is over specs (i.e., long life of 1000-cycle life and 3-year warranty). Battery may have premature capacity loss within its cycle life or warranty.3. If issue remains, test with a verified working battery and verify battery status lights and battery conditions.4. If issue remains, replace system board.

Items	Procedures
	<ol style="list-style-type: none"> Verify the new replacement.
Tips and tricks	See the computer user guide for instructions regarding battery maintenance and increasing battery life. Also reference http://support.hp.com/us-en/document/c01297640?jumpid=hpr_r1002_usen_link3 .

Battery discharges too fast

Items	Procedures
<i>Symptoms</i>	<i>Possible causes</i>
Battery has good status light but discharges too fast	AC adapter and/or battery.
	<i>Troubleshooting steps</i>
	<p>Verify AC adapter</p> <p>Determine whether the computer needs the AC adapter to boot and operate. Sometimes, intermittently bad AC adapter and loose connection between adapter and computer results in inability to charge battery and causes short run time.</p> <ol style="list-style-type: none"> Inspect AC adapter to verify that it is working. Test with AC adapter alone and with a verified working AC adapter.
	<p>Verify battery: Battery capacity can degrade over time, so check the warranty coverage. Run a battery test to confirm if issue is hardware-related.</p> <ol style="list-style-type: none"> Review battery power plans in Control Panel > Power Options that may consume more energy and discharge battery faster. Resetting default to Power Saver option can conserve battery power. Determine whether any graphics processing is running. Verify battery maintenance and operations. Leaving the battery at a high level of charge in a high-temperature environment for extended periods accelerates the loss of capacity. Test and calibrate battery using HP PC Hardware Diagnostics (UEFI). Verify battery life cycle using HP Support Assistant tool. <p>If battery cycle life is over specs (long life battery of 1000-cycle life and 3-year warranty), battery may have capacity loss beyond its lifecycle or warranty.</p> <ol style="list-style-type: none"> Compare discharge time with a verified working battery (remove AC adapter) using Hardware Diagnostics (UEFI) > Hard Drive Tests > Extensive Test > Loop until error.
Tips and tricks	<p>To conserve battery power, turn off Wireless On-Off button and other peripherals/USB devices, applications, processes (in Task Manager) when not in use; also, reduce screen brightness.</p> <p>Follow HP instructions of how to maintain battery and increase battery life. Also reference http://support.hp.com/us-en/document/c01297640?jumpid=hpr_r1002_usen_link3.</p>

Burnt smell

Items	Procedures
<i>Symptoms</i>	<i>Possible causes</i>
Emits smoke, burnt smell	Defective on-board components.
	<i>Troubleshooting steps</i>
	General visual inspection
	<ol style="list-style-type: none">1. Disconnect the computer from power source (AC adapter and battery).2. Inspect for visual damage on AC adapter and battery. Test on a known working computer to isolate issue. If issue follows AC adapter or battery, replace it.3. Inspect any sign of liquid spill on the computer (back of keyboard).
The sections below are intended for authorized service providers/technicians.	
	Further inspection on components
	<ol style="list-style-type: none">1. Inspect further sources internally after disassembling chassis, such as burnt or damaged components.2. If the issue persists, replace boards, AC adapter, and battery for safety concern and report issues to HP.

POST

No video (with power)

Items	Procedures
<i>Symptoms</i>	<i>Possible causes</i>
<ul style="list-style-type: none">• No video (black/blank image) but have power• Light activity• No error messages• Fan noise• Hard drive light blinking and hard drive noise	<p>Failed display</p> <p>Failed critical components (memory, hard drive, system board)</p> <p>Loose connection</p> <p>Recently added hardware</p> <p>NOTE: Assume the computer has not previously been set up for multiple displays.</p>
	<i>Troubleshooting steps</i>
	Quick check
	<ol style="list-style-type: none">1. Verify that system light activity is OK.2. Remove all external devices, including docking station. Recently added hardware and/or applications may cause graphics driver conflict and result in loss of video.3. Perform hardware reset (8. Hard reset on page 88) and verify that HP Logo is presented correctly on display screen when pressing F10.4. Test with external monitor via VGA port (or DisplayPort, HDMI, etc). Press power button and close the computer lid to force video output to external video. If unsuccessful, contact HP service.

Items	Procedures
	<p>5. If external video is OK, update BIOS, software, and drivers (4. Update BIOS and drivers on page 84) and perform soft reset (9. Soft reset (Default Settings) on page 89) if needed. Go to next step to verify display.</p>
	<p>Verify display</p> <ul style="list-style-type: none"> When booting to Windows, determine whether image appears on display screen (via Windows Screen Solutions or Windows logo  + P for display switcher). If there is video on display, disconnect external display device, open the computer lid and restart.
<p>The sections below are intended for authorized service providers/technicians.</p>	
	<ol style="list-style-type: none"> Reseat display cable connection on system board. Reseat display cable connection on display panel side. Examine and reseat major components, such as hard drive, memory. Test with minimum configuration (11. Test with minimum configuration on page 90) by removing hard drive to isolate operating system issues and testing video in F10 Setup. If video is present, restart and retest the computer. If video is present but bad, go to Display on page 112 section. If issue persists (no video), test with external video. If issue persists, test or replace a confirmed working display. If issue persists, replace discrete graphics card. If issue persists, replace system board due to defective video function.
Tips and tricks	<p>Swipe a metal piece (screwdriver) over wireless/mute buttons to act as if closing lid to force video output to external display device. See the “External component identification – Display” section for location of the magnetic sensor.</p>

Blinking lights

Items	Procedures
<p><i>Symptoms</i></p> <p>Lights blink on keyboard caps lock/num lock keys</p>	<p><i>Possible causes</i></p> <p>Blinking lights on startup usually indicate a problem with basic functionality of a critical component (processor, BIOS, graphics cards, memory, etc.) due to loose connection, defective parts, or recently added parts.</p>
	<p><i>Troubleshooting steps</i></p> <ol style="list-style-type: none"> Check for any blink patterns. Count the number of blinks in a sequence, followed by a pause for a few seconds. See Status, Blinking Lights, and Error Message (7. Status lights, blinking light codes, troubleshooting lights, and POST error messages on page 86) for corrective actions. If internal hardware components (memory, hard drive, etc.) have been recently added, a component may not be connected properly. Remove and reseat new components (10. Reseat cables and connections on page 89) one at a time.
Note	<p>Since the display may not be functional, lights are used to indicate an error.</p>

Diagnostics error messages

Items	Procedures
<p><i>Symptoms</i></p> <ul style="list-style-type: none">• Computer has power• POST error message displays (Windows logo has not yet appeared)	<p><i>Possible causes</i></p> <p>Diagnostic error messages indicate a problem. There may be a problem with the instruction being sent from the BIOS to a hardware component (e.g., keyboard failures), or incompatible hardware. Can usually be resolved by installing updated firmware for the component.</p> <p><i>Troubleshooting steps</i></p> <ol style="list-style-type: none">1. See 7. Status lights, blinking light codes, troubleshooting lights, and POST error messages on page 86 for corrective actions. An example of a POST error message is shown below. <div data-bbox="692 627 1442 894" data-label="Image">A screenshot of a blue BIOS error message box. The text inside reads: "Boot Device Not Found", "Please install an operating system on your hard disk.", "Hard Disk - (3F0)", "F2 System Diagnostics", and "For more information, please visit: www.hp.com/go/techcenter/startup".</div> <ol style="list-style-type: none">2. If there is power, you may be able to access BIOS. Reset BIOS to its default condition. (9. Soft reset (Default Settings) on page 89)3. Restore hardware to its original condition (i.e., bootable solid-state drive instead of hard drive).4. Reseat suspected components and verify connection.5. Test suspected components using HP PC Hardware Diagnostics (UEFI) tool.
<p>Note</p>	<p>An Error Message means the system has finished BIOS hardware validation and is ready to launch the Startup Menu. To access the Startup Menu for further options, press the Esc key while restarting the computer.</p>

BIOS password

Items	Procedures
<i>Symptoms</i>	<i>Possible causes</i>
Some sections are unavailable (grayed out)	BIOS administration password is required.
	<i>Troubleshooting steps</i>
	<ol style="list-style-type: none">1. Review F10 BIOS Setup Overview to determine which features must be enabled.2. Your BIOS settings may be managed by a BIOS administrator password setup.3. If you lost or forgot user password, contact your IT personnel.4. If you lost or forgot administrator password, contact HP service to reset the password. This process requires a unique UUID.
Reference	HP F10 Setup Overview http://h10032.www1.hp.com/ctg/Manual/c04460979 http://h10032.www1.hp.com/ctg/Manual/c04685655 2015 Business PC models – see the BIOS F10 Setup technical white paper at http://support.hp.com , enter your computer model, and then go to Manuals > White papers > HP PC BIOS F10 Setup Guide .

Performance (OS)



NOTE: Most software problems occur as a result of the following:

- The application was not installed or configured correctly.
- There is insufficient memory available to run the application.
- There is a conflict between applications.

Make sure that all the needed device drivers are installed.

If an operating system other than the factory operating system is installed, check whether the operating system is supported and the application is certified for the version of the operating system.

HP ships and supports Windows 7 with BIOS Legacy boot mode and Windows 8, 10 with BIOS UEFI boot mode. Therefore, HP recommends that you switch BIOS boot mode from Legacy to UEFI Native for clean Windows 8, 10 installations, or to UEFI Hybrid (if available) for upgrading the option from Windows 7 to Windows 8, 10. UEFI Windows 8, 10 avoids many unexpected behaviors (i.e., blue screen error, graphics/video issues) in the BIOS Legacy setting.

Intermittent shutdown

Items	Procedures
<i>Symptoms</i> <ul style="list-style-type: none">• Shutdown during startup• Shutdown during operation	<i>Possible causes</i> <p>It is often difficult to troubleshoot an intermittent issue. Possible causes include the following:</p> <p>Power-related issue: defective or insufficient power sources, poor connection.</p> <p>OS Custom Setting: Energy Saver (Power Management).</p> <p>Thermal-related issue: thermal sensors reach limits.</p> <p>Hardware related issue: voltage, out-of-range current; electrical short.</p>
	<i>Troubleshooting steps</i> <ol style="list-style-type: none">1. Update BIOS and drivers. (4. Update BIOS and drivers on page 84)2. Perform hard reset (8. Hard reset on page 88)3. Perform soft reset (9. Soft reset (Default Settings) on page 89)
	Power related issue <ol style="list-style-type: none">1. Verify functionality of AC adapter alone. If no functionality, test with a verified working adapter.2. Verify battery alone. Verify that battery is not depleted. Test battery using HP PC Hardware Diagnostics (UEFI) tool.3. Verify connection of power button, power cable.
	OS custom settings <ol style="list-style-type: none">1. Advise users to reset power options and close all applications that are not in use, including applications in the background.2. Test with a confirmed working operating system to isolate custom settings by users or any conflicting applications that cause shutdown.
The sections below are intended for authorized service providers/technicians.	
	Thermal-related issue <ol style="list-style-type: none">1. Verify thermal condition:<ol style="list-style-type: none">a. Test fan using HP PC Hardware Diagnostics (UEFI) tool (6. HP Hardware Diagnostics and Tools on page 85)b. Check fan and connection. Reseat fan cable.c. Be sure that no obstructions or dust are in heat sink fan, fin, or vent.d. Test with a verified working fan.e. Remove old thermal compound and pads and replace with new compound and pads.2. Verify thermal solution:<ul style="list-style-type: none">○ Use Thermal Monitor tool (available only to authorized service providers/technicians) to perform stress test (processor and GPU) (6. HP Hardware Diagnostics and Tools on page 85) and verify that thermal sensors are within limits after thermal condition is serviced.
	Hardware related issue <ol style="list-style-type: none">1. Check for any signs of loose connections, bent pins, stray wires, dust, nearly faulty parts (bulging/leaking capacitor).

Items	Procedures
	<ol style="list-style-type: none"> 2. Verify that lights are solid. 3. If shutdown is reproducible, test essential hardware configuration: <ol style="list-style-type: none"> a. If no issue with hardware configuration, reinstall one non essential component at a time to determine faulty hardware. b. If issue persists, replace essential hardware with a confirmed working part, one at a time. If no boot, replace system board.
Tips and tricks	Intermittent issue is difficult to reproduce and troubleshoot. It is important to record details on shutdown frequencies, system configuration (3D video application) and operating conditions.

Blue screen

Items	Procedures
<p><i>Symptoms</i></p> <ul style="list-style-type: none"> • Have power, light activity, fan spinning • HP Logo displays briefly • Fails to boot into Windows operating system, displays blue screen, and then crashes, restarts, or stops responding 	<p><i>Possible causes</i></p> <p>Recent changes: conflict of instructions from multiple programs or just added hardware.</p> <p>Incompatible hardware and driver.</p> <p>Poor connection (hard drive, memory).</p> <p>Hardware malfunctioning due to overheating (GPU, processor).</p> <p>Defective hardware (memory, hard drive).</p>
Important Notes & Resources	<p><i>Troubleshooting steps</i></p> <p>There are many different ways to troubleshoot a blue screen error. Therefore, you need to identify working configuration (Windows 7/8/10) and specific symptoms of the failure in order to narrow down the issue. Refer to Blue screen (BSOD) error on page 129.</p>
	<p>Recommended resources</p> <p>Microsoft knowledge base:</p> <p>http://windows.microsoft.com/en-us/windows-8/resolve-windows-blue-screen-errors</p> <p>For more information search for HP Troubleshooting Error Messages on a blue screen at http://www.hp.com.</p>

Overview of General Troubleshooting Steps for a blue screen error

1. Note the blue screen error message and what activity was performed at the time.
2. Perform a hard reset ([8. Hard reset on page 88](#)) after disconnecting all external peripherals.
3. Reset BIOS to default ([9. Soft reset \(Default Settings\) on page 89](#)) to prevent booting to another device.
4. Run HP Hardware Diagnostics ([6. HP Hardware Diagnostics and Tools on page 85](#)) to isolate major faulty hardware issues.

- HP PC Hardware Diagnostics (UEFI) tool to test hard drive, memory and system.
 - Thermal Monitor (available only to authorized service providers/technicians) tool to monitor temperature limits of processor and GPU. See “HP Thermal Monitor” in [6. HP Hardware Diagnostics and Tools on page 85](#).
5. Remove or undo recently added hardware ([5. Remove or uninstall recently added hardware, software on page 84](#)). For example, incompatible memory or new solid-state drive storage.
 6. Reseat cables and connections ([10. Reseat cables and connections on page 89](#)). Pay attention to proper installation of memory and hard drive.
 7. Verify that a minimum of at least 100 MB of free space is available on your Windows partition.
 8. If you can start Windows:
 - a. Update BIOS and drivers ([4. Update BIOS and drivers on page 84](#)) to support updates for incompatibilities.
 - b. Get all the latest updates, using Windows Update.
 - c. Undo recent changes:
 - Startup using Last Known Good Configuration.
 - Use System Restore.
 - Roll back device driver in Device Manager.
 - d. Check for specific Error Message. See [Common Blue Screen Error Messages on page 140](#).
 - e. Boot to safe mode ([11. Test with minimum configuration on page 90](#)) to troubleshoot issues.
 9. If you cannot start Windows:
 - a. Boot to safe mode. ([11. Test with minimum configuration on page 90](#))
 - b. Use Startup Repair to fix Windows startup files.
 - c. Undo recent changes using System Restore to revert to a previous “working” state.
 - d. Check for specific STOP error by analyzing Crash Dump (retrieved via a bootable USB). See [Use Windows Debugging Tool on page 141](#).
 - e. Restore computer using System Recovery or image backup to factory settings.
 10. Lastly, test with essential hardware configuration ([11. Test with minimum configuration on page 90](#)) along with a verified working operating system (i.e., USB Windows-To-Go), if available, to isolate the software issue.

Tips & tricks

In some cases, the computer may reboot automatically before you have time to read the blue screen.

To identify the error message itself, disable the automatic restart using one of the following methods:

Right-click on **My Computer**, and then select **Properties** > **Advanced**. Under **Startup and Recovery**, select **Settings**. Clear the **Automatically Restart** check box.

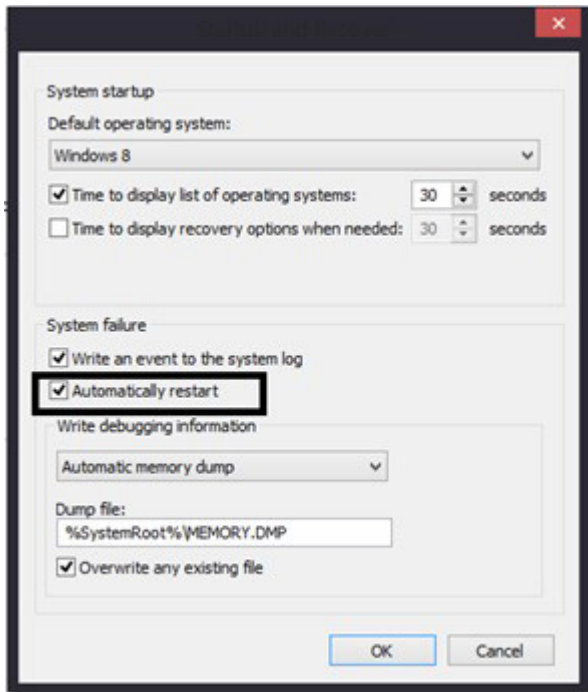

Windows Advanced Boot Option

Windows 7:

1. Press **F8** to open the Windows Advanced Boot Option screen.
2. Select **Disable automatic restart on system failure** to view error messages.

Windows 8:

1. Press **F11** (System Recovery) to open the Windows Advanced Boot Option screen.
2. Select **Startup Settings** to view error messages.

Freeze at Windows Logo (hang/lockup)

Items	Procedures
<p><i>Symptoms</i></p> <ul style="list-style-type: none"> • Has power, light activity, fan spinning • HP Logo displays briefly • Attempt to boot to operating system and freeze/hang at Windows logo • No response to pressing num lock or caps lock key 	<p><i>Possible causes</i></p> <p>Conflict of instructions from multiple programs or drivers; installing a new hardware or program that is not compatible (may also cause a blue screen error—see blue screen issue).</p>

Items	Procedures
	<p data-bbox="699 541 896 569"><i>Troubleshooting steps</i></p> <p data-bbox="699 588 1353 615">Follow suggested steps below one at a time to verify normal boot process:</p> <ol data-bbox="699 634 1433 1291" style="list-style-type: none"> <li data-bbox="699 634 1407 684">1. Disconnect all external peripherals, and perform a hard reset (8. Hard reset on page 88). <li data-bbox="699 703 1305 730">2. Perform soft reset (9. Soft reset (Default Settings) on page 89). <li data-bbox="699 749 1321 863">3. Update BIOS and drivers (4. Update BIOS and drivers on page 84). <ol data-bbox="746 793 1216 863" style="list-style-type: none"> <li data-bbox="746 793 1216 821">a. Roll back to previous version may be necessary. <li data-bbox="746 840 1093 867">b. Go to safe mode to install drivers. <li data-bbox="699 886 1433 936">4. Run Hardware Diagnostics (6. HP Hardware Diagnostics and Tools on page 85) to isolate hardware issue. <li data-bbox="699 955 1385 1005">5. Undo recent changes in Windows (5. Remove or uninstall recently added hardware, software on page 84). <li data-bbox="699 1024 1332 1075">6. Reseat cables and connections (10. Reseat cables and connections on page 89). <li data-bbox="699 1094 1332 1144">7. Start Windows in safe mode (11. Test with minimum configuration on page 90). <li data-bbox="699 1163 1264 1190">8. Use Startup Repair Windows to fix Windows damaged files. <li data-bbox="699 1209 1433 1291">9. Test with essential hardware configuration (11. Test with minimum configuration on page 90) along with a verified working operating system (i.e., USB Windows-To-Go) if available to isolate the software issue. <p data-bbox="252 1318 386 1346">Tips and tricks</p> <p data-bbox="699 1318 1401 1346">For more information, see http://support.hp.com/us-en/document/c03671001.</p>

Electromagnetic Interference (EMI)

Items	Procedures
<p data-bbox="252 1549 347 1577"><i>Symptoms</i></p> <p data-bbox="252 1591 561 1642">System locks up, freezes in certain physical area or location</p>	<p data-bbox="609 1549 746 1577"><i>Possible causes</i></p> <p data-bbox="609 1591 922 1619">Electromagnetic interference (EMI).</p> <hr/> <p data-bbox="609 1642 810 1669"><i>Troubleshooting steps</i></p> <ol data-bbox="609 1688 1433 1852" style="list-style-type: none"> <li data-bbox="609 1688 1417 1738">1. See (2. Examine the environment on page 83). Pay attention to external power source, high-frequency signals such as cell phones, microwave ovens. <li data-bbox="609 1757 1433 1808">2. Move the computer to different locations nearby to determine where it fails and where it does not fail. <li data-bbox="609 1827 1273 1854">3. Test with a verified working computer in original factory configuration.

Items	Procedures
	4. Consult with support.

No wake up

Items	Procedures
<p><i>Symptoms</i></p> <p>When resuming from a power management state the computer may display:</p> <ul style="list-style-type: none"> • Blank screen • Some light activity 	<p><i>Possible causes</i></p> <p>Power-saving mode; multiple-display setting.</p> <hr/> <p><i>Troubleshooting steps</i></p> <ol style="list-style-type: none"> 1. Verify that front power light (7. Status lights, blinking light codes, troubleshooting lights, and POST error messages on page 86) is blinking (indicating Sleep state). Press power button to exit Sleep. 2. Reset BIOS to default (associated with OS Power Management in Power Menu) (4. Update BIOS and drivers on page 84) 3. Verify power management settings in Windows Power Options. Disable Sleep options if the issue is resolved.

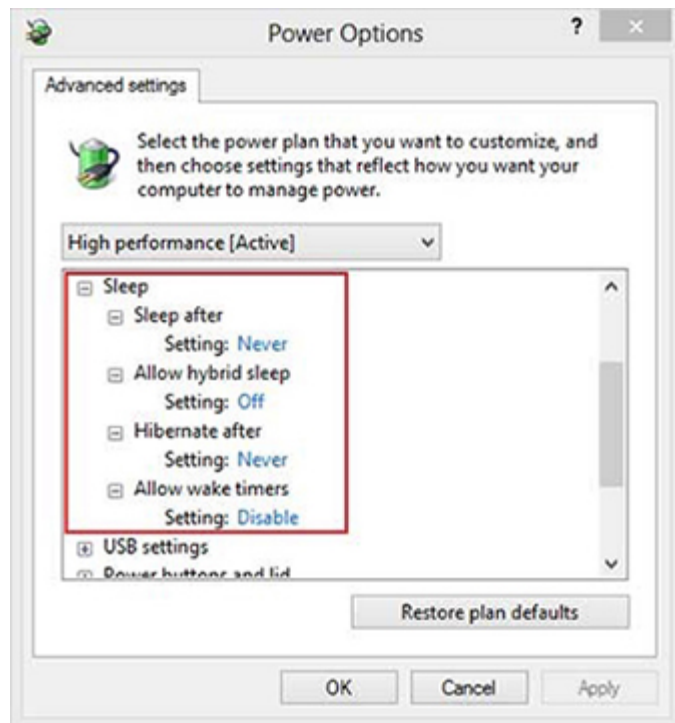

4. Screen saver is set. Press any key or touch touchpad to resume.
5. Verify that Display Choice is set to external video only. Toggle screen control key combination **Fn + F4** or **Windows logo**  **+P**.

Tips and tricks	If you are using a docking station, set your notebook display as a primary display. When the computer is undocked, you may think it is in a power-saving state, but the screen image may actually display on an external display device in the docking configuration.
------------------------	---

Unresponsive

Items	Procedures
<i>Symptom</i>	<i>Possible causes</i>
Unresponsive	Program in use has stopped responding to commands.
	<i>Troubleshooting steps</i>
	<ol style="list-style-type: none">1. If possible, use the Windows Task Manager to isolate and terminate the offending process.2. Attempt the normal Windows shutdown procedure.3. Restart the computer using the power button.

Slow performance

Items	Procedures
<i>Symptom</i>	<i>Possible causes</i>
Slow performance when performing small tasks, or even in idle mode	Processor is hot or hard drive is full.
	<i>Troubleshooting steps</i>
	Processor is hot
	<ol style="list-style-type: none">1. Verify that airflow to the computer is not blocked.2. Verify that chassis fans are connected and working properly. Some fans operate only when needed.3. Verify that the processor heat sink is installed properly.
	Hard drive is full
	<ol style="list-style-type: none">1. Transfer data from the hard drive to create more space on the hard drive. Microsoft recommends at least 200 MB to sync system files.2. Perform disk defragmentation to consolidate fragmented data on the hard drive so it will work more efficiently.
	Also see Slow performance on page 129 .
Tips and tricks	See Routine Maintenance for Performance Improvement on page 140). See http://windows.microsoft.com/en-us/windows-8/free-up-disk-space . See http://windows.microsoft.com/en-us/windows/optimize-windows-better-performance#optimize-windows-better-performance=windows-vista .

HP Smart Adapter warning message

Items	Procedures
<i>Symptom</i>	<i>Possible causes</i>
Warning message displayed in Window	Less powerful AC adapter, BIOS out of date.
	
	<i>Troubleshooting steps</i>
	<ol style="list-style-type: none">1. Update BIOS that may contain a table that assigns an appropriate adapter for a certain configuration.2. Update the latest HP Hotkey Support software from Drivers website.3. Verify sufficient power source (where adapter is connected).4. Use appropriate AC adapter (often supplied with system) for optimum system performance.5. Test with a verified working AC adapter.6. Test the adapter on a verified working computer.7. Contact HP for configuration details.
Note	<p>HP Smart AC adapter warning message: informs you that as power demands increase, the notebook may not perform at full capacity, which may result in longer battery-charging time. In cases of extreme power demands, the system may also throttle back the processor, or with systems that have a discrete video sub-system, a video balance mode may occur to further balance the power needs of the system.</p> <p>System processor functions always have priority over battery charging, so charging delays will occur first.</p>

Incorrect time and date

Item	Procedure
<i>Symptom</i>	<i>Possible cause</i>
Incorrect date and time	Real-time clock (RTC) battery might need replacement.
	<i>Troubleshooting steps</i>
	<ol style="list-style-type: none">1. Reset the date and time in the operating system Control Panel.2. Replace the RTC battery.

Item	Procedure
	3. Verify that date and time are correct.

Display

Display anomalies

The display panel is a field replaceable unit (FRU) and must be replaced by only authorized technicians. However, HP highly recommends that users and technicians observe specific symptom vs. generic symptoms and utilize the HP PC Hardware Diagnostics (UEFI) tool before any replacement.

Symptom

Common display issues with symptoms:

- Blank/black video
- Incorrect/missing color/distorted image
- Flickering image
- Vertical lines (due to LDVS, decreased signal integrity, and data loss)
- Dead pixel (due to display liquid, internal transistor, etc.)
- Horizontal lines (due to video memory)
- Distorted when hot (due to thermal issue)
- Cracked screen/image (physical damage)
- Light leakage/bleeding
 - Contact support for assistance.
- Humming noise (due to frequency settings)
 - Contact support for assistance.

Display anomalies

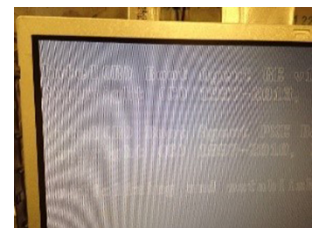
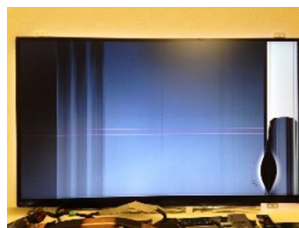

Display anomalies

Cracked screen

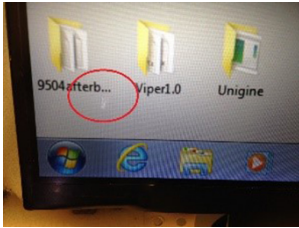

Dead pixel

Cracked image



Vertical lines

Blurred image



Horizontal lines

Quick check

- Visually examine the display for cracked screen, liquid crystal leak, dirty spots on glass, etc.
- Reset and update BIOS and docking firmware.
- Update operating system (OS), graphics/video drivers (Intel/AMD/NVidia, etc).

For custom images, HP highly recommends upgrading or installing Windows in UEFI mode (or Legacy disabled) to fully support hybrid graphics and avoid unexpected behaviors (i.e., blue screen error, graphics/video issues) in the BIOS Legacy setting.

- Configure Windows settings (Power options, Screen brightness, Personalization, Screen resolution, etc.).
- Test with a verified working external display.
- Boot to Windows in safe mode.
- Test with a verified working operating system (i.e., shipping image).

HP PC Hardware Diagnostics (UEFI) for video test

Use this tool to quickly determine if the display issue is related to a real hardware issue.

To start HP PC Hardware Diagnostics (UEFI) ([6. HP Hardware Diagnostics and Tools on page 85](#)), when the computer is at boot, press the **F2** key, select **Component Tests**, and then select **Video**.

There are three options:

- **Video Memory Check:** to test video memory
- **Palette Check:** to test the three video color components (red, green, blue)
- **Dead Pixel Check:** to check dead pixels in eight different colors (Dead Pixel Check is available with the “HP PC Diagnostics 3-in-1 USB Key” tool)

Review the video troubleshooting in the Display section below for specific issues and possible solutions. For additional information about display problems, refer to documentation provided by the product manufacturer.

Display assembly diagram

The display assembly diagram shows basic video components: system board, graphics cards, display cables, display connectors, operating system (OS), graphics driver, and LCD display panel. Any component or a combination of these components can contribute to a video issue.

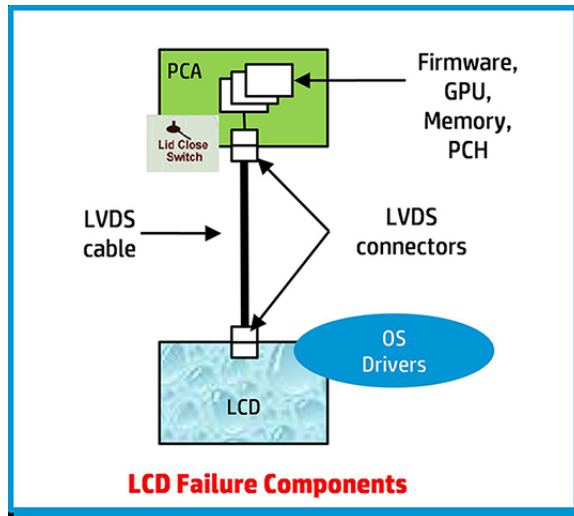

NOTE: The lid close switch is a Hall-effect sensor located in the top cover. When the display is closed, the sensor acts like a switch is closed. A notebook can force a video output to an external monitor, or go to hibernation or standby mode through power management. If the display screen does not light up when the display is open, the lid close switch (Hall-effect sensor) could be faulty.

Dead pixel

Display panel may show one or more pixels that are not properly lit when displaying a single color over the screen area. Use HP PC Hardware Diagnostics (UEFI) tool to determine those defective pixels. There is no solution for dead pixels. Refer to [Display Issue: Pixel Anomalies on page 146](#) for the HP dead pixel policy.

No video (internal)

Items	Procedures
<i>Symptoms</i>	<i>Possible causes</i>
No internal video with certain programs (i.e., video-intensive games)	Display resolution, brightness, faulty lid switch, running a program requiring a higher resolution than the display screen can support. Faulty lid switch may put the system into Sleep or Hibernation mode.
	<i>Troubleshooting steps</i>
	Use an external monitor with higher resolution. Test with external monitor using HDMI or HP port. Press the power button and close the computer lid to force video output to external video. If there is still no video, contact support.
References	See section No video (with power) on page 100 for display information.

No video (external)

Items	Procedures
<i>Symptom</i>	<i>Possible causes</i>
No image on external monitor	External monitor, resolution, display configuration, drivers.
	<i>Troubleshooting steps</i>
	<ol style="list-style-type: none">1. Be sure external monitor is compatible with the computer.2. Be sure that external monitor is turned on.3. Press any key to get out power saving mode.4. Adjust the brightness of the monitor.5. Test with a verified working monitor.6. Test the monitor via internal ports (VGA, DP ports).7. Install latest video driver.8. Reset the screen resolution as described in the documentation.9. Configure display choice, and then force output to external video by closing the notebook lid or pressing Fn + F4 to switch screen output.

DisplayPort/VGA

See [No video \(external\) on page 115](#).

HDMI

Items	Procedures
<i>Symptoms</i>	<i>Possible causes</i>
<ul style="list-style-type: none">• Display issue• Sound issue	Cable, connection, settings.
	<i>Troubleshooting steps</i>
	Quick Check
	<ol style="list-style-type: none">1. Verify HDMI device input source is set correctly (i.e., HDMI1).2. Be sure you are using the correct HDMI cable.3. Check connection and reconnect the HDMI cable.4. Verify if sound output is configured correctly in Control Panel > Sound Manager.
	<ol style="list-style-type: none">1. Perform hard reset (4. Update BIOS and drivers on page 84).2. Update BIOS and drivers (4. Update BIOS and drivers on page 84) when sound is heard but no video on HDTV.
References	http://support.hp.com/us-en/document/c01186408

No or bad external video via docking

Items	Procedures
<i>Symptoms</i>	<i>Possible causes</i>
No or bad image on external monitor via ports of docking station (VGA, DP, TB, display port, etc.)	Rooted from system board, software/drivers, dock connectors, docking station hardware/firmware, dock video ports (DP, VGA, etc).
	<i>Troubleshooting steps</i>
	<ol style="list-style-type: none">1. Be sure that external monitor is powered on.2. Be sure that external monitor is compatible with the computer.3. If applicable, plug the dock in different Type-C ports. For more information, see the technical white paper titled "HP ZBook 65/150/200 W Thunderbolt 3 Dock User Guide." Go to http://support.hp.com/, enter your model number, and then click Manuals > Technical white papers.4. If the screen image is distorted, try a DP-to-VGA adapter. Connect the adapter to each DisplayPort and VGA port of the dock.5. Test the monitor via internal ports (VGA, DP, HDMI, etc.).6. Verify that dock connectors of the notebook and the dock are clean, without dust, debris (e.g., using air duster).7. Ideally, use a verified working operating system/system connected to the dock to isolate the issue of the current operating system.8. Ideally, use a verified working docking station to isolate the faulty dock.9. Update latest dock firmware. Be sure to follow the installation instructions carefully. You may want to try a DP-to-VGA adapter if you have a distorted screen image. Connect the adapter to each DisplayPort of the dock. If you still cannot update the dock, attempt to update it on a confirmed working notebook before having the dock replaced.
Note	See the technical white paper titled "Multiple displays on HP ZBook Mobile Workstations" from HP platform support website. Go to http://support.hp.com/ , enter your model number, and then click Manuals > Technical white papers .

Incorrect or missing color/distorted image

Items	Procedures
<i>Symptoms</i>	<i>Possible causes</i>
System works normally but the display shows:	Loose connection, display cable, display, graphics card.
<ul style="list-style-type: none">• Missing or strange color• Image distortion	<i>Troubleshooting steps</i>
	Verify with external monitor (i.e., VGA)
	<ol style="list-style-type: none">1. Use combination Fn + F4 to enable output to external monitor.2. Close the lid.
	If the external monitor also shows incorrect color, it is graphics card issue. Test with a verified working graphics card.
	Verify display cable and cable connection —Display disassembly is required. Be sure that external display cables are not pinched or damaged.

Items	Procedures
	<p>Be sure that external display cables have good connection at both ends (system board and display panel).</p> <ul style="list-style-type: none"> • If moving cables affects the image, it is display cable. Test with a confirmed working cable. • If moving cables does not affect the image, is display issue. Test with a confirmed working display

Touch screen

Items	Procedures
<i>Symptoms</i>	<i>Possible causes</i>
Unresponsive	Dirt and smudge, driver, touch display configuration, power management.
Inaccurate	<i>Troubleshooting steps</i>
	Quick check
	Turn off the computer, spray glass cleaner onto a soft, damp cloth, and gently wipe the screen to remove dirt and smudge.
	NOTE: Do not spray cleaner directly onto the screen.

Configure the touch display in **Control Panel > Tablet PC Settings**

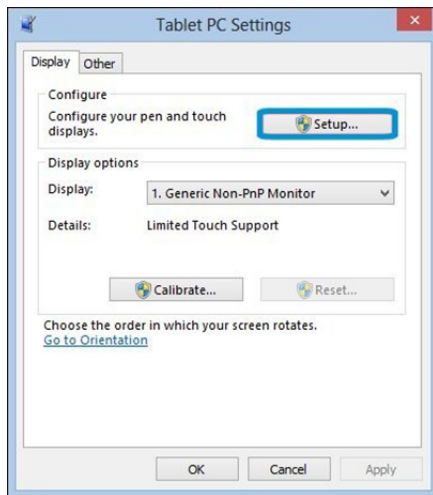

1. Restart the computer.
2. Verify touch screen and graphics drivers.
3. Configure the touch display to identify the screen as a touch screen as shown in the image at left.
4. Calibrate the screen and reset if touch functionality is still not working correctly.
5. Perform diagnostic test in HP Hardware Diagnostics under **Component Tests > Touch Screen**.
If the diagnostics tests pass but the touch screen still does not respond, continue following the steps.
6. Adjust the power management settings for your touch screen.
If the touch screen stops working after waking from sleep, adjust the power management settings so that the touch screen device stays active while the computer is in sleep mode.
7. Perform Microsoft System Restore and restore to a time when the system was working.
8. Perform HP System Recovery if none of the above actions resolves the issue.

References

<https://support.hp.com/us-en/document/c03488148>

I/O devices



NOTE:

- Make sure external devices are supported and compliant (i.e., USB Type C, Thunderbolt 3, PCI Express, etc).
- If you have problems with external devices not provided by HP, contact device manufacturers for compatibility and latest drivers prior to troubleshooting (i.e., USB devices, Thunderbolt devices, PCI Express Card reader, VGA/Display/HDMI monitors, Speakers, etc).
- Be sure I/O devices are properly inserted into the I/O ports, and then be sure the I/O devices are recognized by Windows Device Manager.

Keyboard

Items	Procedures
<i>Symptoms</i>	<i>Possible causes</i>
Keystrokes not recognized	Dust trapped under keycap, loose keycap, loose keyboard connection, defective keyboard.
Characters not matched	
	<i>Troubleshooting steps</i>
	<ol style="list-style-type: none">1. Inspect the keyboard for any signs of dust, liquid, or debris trapped under sticky keys that might prevent keystroke recognition.2. Check for incomplete connection between keyboard and system board by verifying that caps lock or num lock light turns on when key is pressed.3. Verify whether the keyboard is recognized in Windows Device Manager and verify whether the keyboard driver is installed properly.4. Test with a working external keyboard (i.e., USB keyboard). Also test in Windows for special keys (Caps Lock, Shift, Ctrl, Fn, Windows, Alt) if necessary.5. Test with HP PC Hardware Diagnostics (UEFI) to isolate a hardware issue from a software issue.6. Verify that BIOS is up to date. If so, resetting BIOS to default may help.7. Test with verified working operating system or restore operating system to be sure that the issue is not caused by different language settings, sticky keys feature, etc.8. Verify that keyboard flex cables are fully inserted and in good condition.
The sections below are intended for authorized service providers/technicians.	
	<ol style="list-style-type: none">1. Verify if keyboard flex cable is in good condition (no delamination or torn cable end, no missing or cracked tracks, pads).2. Verify keyboard flex cable ends are fully inserted and aligned with connectors on system board, and those connector tabs are properly closed. Reseat cables.3. Replace new internal keyboard and retest.
Tips and tricks	A key only works when pressed with force. Inspect and remove debris trapped under keycap.

Keyboard point stick

Items	Procedures
<i>Symptom</i>	<i>Possible causes</i>
Point stick not working properly	Dust trapped under point stick, loose point stick cap.
	<i>Troubleshooting steps</i>
	<ol style="list-style-type: none">1. Inspect any signs of dust, liquid spill that prevent point stick from working.2. Check whether point stick cap is loose and reseal it if necessary.

The sections below are intended for authorized service providers/technicians.

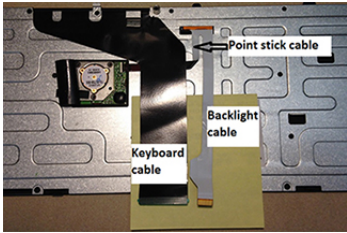

Example of back of keyboard, including keyboard, point stick, and backlight cables.

1. Verify whether keyboard flex cables are in good condition (no delamination or torn cable end, no missing or cracked tracks, pads).
2. Verify keyboard flex cable ends are fully inserted and aligned with connectors on system board and back of keyboard and that connector tabs are properly closed.
3. Reseat point stick cables.

Keyboard backlight

Items	Procedures
<i>Symptom</i>	<i>Possible causes</i>
Backlight function not working properly	Backlight disabled, loose connection.
	<i>Troubleshooting steps</i>
	NOTE: Not all notebook computers have backlit keyboards. A keyboard function key lets you turn the light on and off. Verify if backlit feature is not disabled by pressing a combination of Fn + Backlit key.

The sections below are intended for authorized service providers/technicians.

1. Verify if backlight flex cables are in good condition (no delamination or torn cable end, no missing or cracked tracks, pads).
2. Verify backlight flex cable ends are fully inserted and aligned with connectors on system board and that connector tabs are properly closed.
3. Reseat backlight cable.

Touchpad

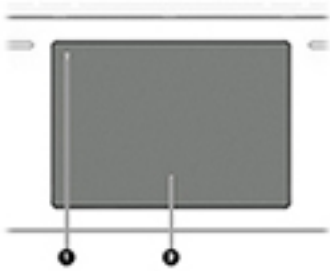
Items	Procedures
<i>Symptoms</i>	<i>Possible causes</i>
Not working properly	On/Off enabled, driver, settings.
(1) – touchpad on/off button	<i>Troubleshooting steps</i>
(2) – touchpad	<ol style="list-style-type: none"> 1. Ensure touchpad On/Off light is not amber (disabled). Double touch to enable. 2. Verify if touchpad device is listed in Device Manager > Mice and other pointing devices. 3. Install the latest touchpad driver. 4. Adjust touchpad settings (Control Panel > Mouse). 5. Test touchpad controller using the HP PC Hardware Diagnostics (UEFI) tool (F2 > Component Tests > Mouse Test > Pointer Test & Drag and Drop Test).
	
The sections below are intended for authorized service providers/technicians.	
	<ol style="list-style-type: none"> 1. Check the touchpad cable for damage or a loose connection, and then reseal the touchpad cable. 2. If issue persists, replace the touchpad and verify the change.

Network Connectivity Ethernet (RJ-45 jack)

Items	Procedures
<i>Symptoms</i>	<i>Possible causes</i>
<ul style="list-style-type: none"> • Unable to find networks (yellow bang) • Connection dropouts • Slow performance 	Network source, cable, connection, RJ-45 port, driver, settings.
	<i>Troubleshooting steps</i>
	Quick Check: verify the network status lights that supposed to flash when there is network activity.
HP Support Assistant tool - No network detected in HPSA	<ol style="list-style-type: none"> 1. Turn off the computer's wireless feature (press wireless button). 2. Verify that networking source with recommended distance to the base is less than 300 feet. 3. Examine the Ethernet cable for damage. Test with a verified working cable. 4. Test with different networks and jacks and check with IT for hardware compatibility settings. 5. Connect a verified working RJ-45 cable directly to the computer to isolate other related issues (e.g., router, switch, docking station). 6. Verify Ethernet port lights (RJ-45): <ul style="list-style-type: none"> – Green (left): network is connected. – Amber (right): network is showing activity.
	

Items	Procedures
	<ol style="list-style-type: none"> 7. Test with HP Support Assistant in Windows. 8. Diagnose with HP PC Hardware Diagnostics (UEFI) to isolate a hardware issue from a software issue. 9. Examine Ethernet ports on the computer, docking station, and wall for damage, dust, obstructions. 10. Update drivers: Verify that Ethernet module is displayed in Device Manager and be sure that device driver is up to date. If updating drivers does not help, try rolling back to previous drivers. 11. Reset BIOS to Default: If other devices can connect to network, but computer cannot connect, a BIOS setting might be the cause of the problem. Restore BIOS to default. 12. Test with verified working operating system or perform operating system recovery to verify that the issue is not caused by customized settings. 13. Replace system board and verify that the issue is fixed.

Network connectivity wireless (WLAN)

Items	Procedures
<p><i>Symptoms</i></p> <ul style="list-style-type: none"> • Unable to find networks (yellow bang) • Connection dropouts • Slow performance 	<p><i>Possible causes</i></p> <p>Network source, cable, connection, wireless module, driver, settings.</p>

HP Support Assistant tool - No network detected in HPSA



Wireless Adapter Properties - U-APSD support

Troubleshooting steps

1. Turn off the computer's wired network (remove RJ-45 cable).
2. Examine environment for interference, such as cell phone or microwave, that may emit high frequencies (above 1 GHz).
3. Verify wireless source by moving computer closer to the wireless base/router.
4. Test with different wireless networks and check with your IT department for hardware compatibility, settings.
5. Verify that the wireless light is on. If the light is amber, press the wireless button to enable the wireless device.
6. Test with HP Support Assistant in Windows.
7. Diagnose with HP PC Hardware Diagnostics (UEFI) to isolate a hardware issue from a software issue.
8. **Update drivers:** Verify that wireless module is displayed in Device Manager and be sure that wireless drivers are up to date using www.hp.com or HP Support Assistant. If updating drivers does not help, try rolling back to previous drivers.
9. **Reset BIOS to Default:** If other devices can connect to your wireless network, but your computer cannot connect, a BIOS setting might be the cause of the problem. Restore BIOS to default.
10. Configure power management advanced settings as necessary.

Items**Procedures**

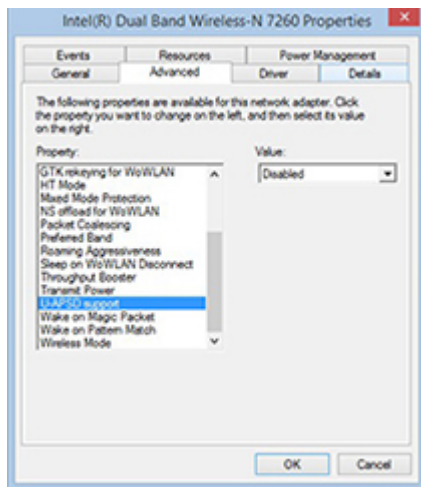

In the example to the left, **U-APSD support** (Unscheduled Automatic Power Save Delivery) is changed to **Disabled** to resolve an incompatible access point. If disabling U-APSD improves the throughput issue, check with the access point provider for updated firmware that resolves the issue.

11. Test with verified working operating system or perform operating system recovery to verify that the issue is not caused by customized settings.
12. Test with a verified working wireless module.

The sections below are intended for authorized service providers/technicians.

1. Verify that the wireless module and its antenna cables are fully inserted and in good condition (see WLAN module removal and replacement section). Reseat wireless module and antenna connection.
2. Verify module antenna cable connection are not loose.
3. Verify antenna cables are properly connected to the MAIN and AUX terminals (see WLAN module removal and replacement section).

WWAN

Items**Procedures**

Symptom

Unable to find networks/service

Possible causes

Network source, cable, connection, driver, settings.

Troubleshooting steps

1. Update to the latest driver and utility.
2. Check with network service provider for signal coverage.
3. Make sure signal strength is good.
4. Make sure your service is active.

The sections below are intended for authorized service providers/technicians.

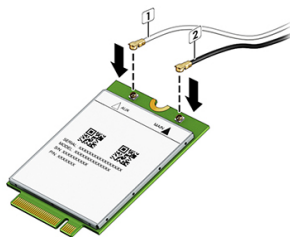

- Verify module and antenna cable connections are not loose.
- Verify antenna cables are properly connected to the correct terminals. For example, the antenna cable labeled "1" connects to the "Main" terminal labeled "1". The antenna cable labeled "2" connects to the "Aux" terminal labeled "2".

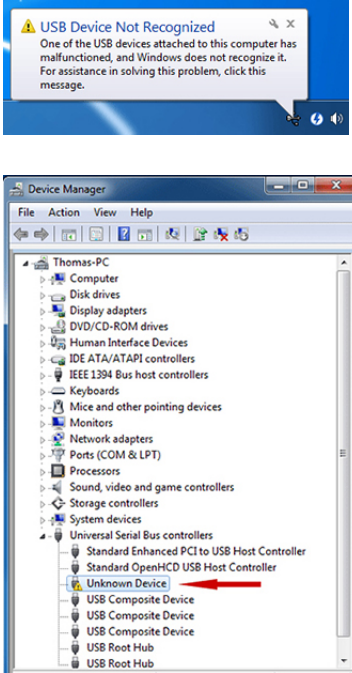
Items	Procedures
<p><i>Symptoms</i></p> <ul style="list-style-type: none"> • USB devices are not recognized • USB devices are not charging 	<p><i>Possible causes</i></p> <p>USB devices do not have the latest software drivers, port insufficient power, or not compliant.</p> <p>NOTE: USB Type-C uses a different connector entirely</p>
<p>Examples of USB device Not Recognized</p>	<p><i>Troubleshooting steps</i></p>
 <p>The top image shows a Windows error dialog box titled "USB Device Not Recognized" with a yellow warning icon. The text inside reads: "One of the USB devices attached to this computer has malfunctioned, and Windows does not recognize it. For assistance in solving this problem, click this message." The bottom image shows a screenshot of the Windows Device Manager window. The tree view is expanded to "Universal Serial Bus controllers", and an "Unknown Device" is highlighted with a red arrow. Other devices listed include "Standard Enhanced PCI to USB Host Controller", "Standard OpenHDC USB Host Controller", "USB Composite Device", and "USB Root Hub".</p>	<ol style="list-style-type: none"> 1. Unplug USB device and/or restart the computer (wait for 2-5 minutes) to reset USB port/hub in case of power surge. 2. Soft Reset (9. Soft reset (Default Settings) on page 89) and verify if USB device is recognized. 3. Verify if USB device is recognized in Device Manager > Universal Serial Bus Controller, or USB is recognized without Yellow bang. 4. Verify if the latest USB driver or/and USB chipset driver are installed. USB driver could be removed and reinstalled. 5. Make sure USB device is supported, for example, USB 3.0 device requires more power drawn (0.9A) from USB port than USB 2.0 device (0.5A). As a result, identify USB charging port to be used for charging a USB device, or an external AC power adapter may be required for an external USB storage to work properly. 6. Test with verified working USB devices (keyboard, mouse, USB key) to make sure USB ports are functional. 7. Test USB device on a verified working computer to make sure USB device is not malfunctioning.

Smart card reader

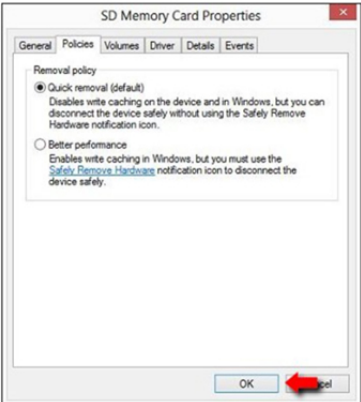
Items	Procedures
<p><i>Symptoms</i></p> <ul style="list-style-type: none">• Not recognized• Unable to write	<p><i>Possible causes</i></p> <p>Physical damage, incorrect insertion, dirt, driver, malfunctioning card reader.</p> <p>NOTE: Some cards have a read/write security switch on the card. Make sure that switch is set to “write enabled” before attempting to write data to it.</p>
<p>Card Reader Removal Policy</p> 	<p><i>Troubleshooting steps</i></p> <ol style="list-style-type: none">1. Verify card reader removal policy.2. Make sure there is no physical damage to the card.3. Inspect the ends of the memory cards for dirt or material closing a hole or spoiling a metal contact. Clean the contacts with a lint-free cloth and small amounts of isopropyl alcohol. Replace the memory card if necessary.4. Reinstall and update the drivers for the card reader.5. Make sure the smart card reader is compliant with ISO 7816 Class A, B, and C.6. Reinsert the card reader with correct face as described in its documentation.7. Check reader function with a verified working card.
	<p>CAUTION: If the card reader has an in-use indicator light, do not insert or remove memory cards while the light is flashing. Doing so may cause loss of data on the card or may permanently damage the card reader.</p>

Speaker, headphone - audio issues

Items	Procedures
<p><i>Symptoms</i></p> <ul style="list-style-type: none"> No sound from external or internal speakers Distorted sound, too soft, too loud, intermittent 	<p><i>Possible causes</i></p> <p>Volume turned down, sound card not recognized, malfunctioning hardware, electronic interference.</p> <hr/> <p><i>Troubleshooting steps</i></p> <ol style="list-style-type: none"> Remove any device connected to the Audio jack to enable the internal speaker. Close all open programs. Adjust volume by pressing Fn + F6/F7. Be sure that volume button light is not amber (mute). <ul style="list-style-type: none"> - or - Adjust Windows volume control by clicking the speaker icon on the Windows taskbar. Be sure that the sound is not muted. Verify that sound card is detected in Windows Device Manager. Reinstall the latest audio driver. Test audio device using HP PC Hardware Diagnostics (UEFI) tool (F2 > Component Tests > Audio). Test with a verified working operating system. If issue is resolved, restore full operating system. Test with verified working external speakers or headset. Reseat internal speaker connections. Test with verified working internal speakers. Replace internal speakers.
No sound from headphones	<ol style="list-style-type: none"> Adjust volume by pressing Fn + F6/F7. Be sure that volume button light is not amber (mute). Or adjust Windows volume control by clicking the speaker icon on the Windows taskbar. Be sure that the sound it not muted. Check headphone cable connection. Test with a verified working audio board. Replace audio board and verify the change.
No sound from external speakers	<ol style="list-style-type: none"> Verify that external speakers are turned on. Disconnect headphones from headphone jack. Adjust volume by pressing Fn + F6/F7. Be sure that volume button light is not amber (mute). <ul style="list-style-type: none"> - or - Adjust Windows volume control by clicking the speaker icon on the Windows taskbar. Be sure that the sound is not muted. Check for possible interference devices nearby that may impact the audio (cell phone or portable communications handset.)

Thunderbolt (TB)

Items	Procedures
<i>Symptom</i>	<i>Possible causes</i>
Thunderbolt device not working	BIOS, drivers, and user settings.

Troubleshooting steps

1. Update to the latest BIOS and choose appropriate TB Port settings.
2. Reset **User Account Settings** to default.
3. Update Intel Thunderbolt software that includes firmware version (for TB controller), driver version (operating system driver), and application version.

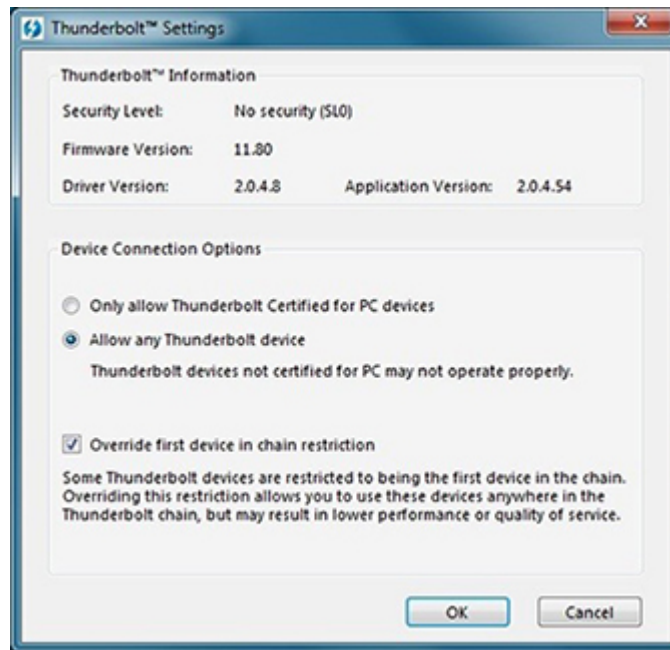

4. Verify that TB device is detected in Windows Device Manager.
5. Verify TB port, cable and connection.
6. Test with a verified working TB board, if possible.

NOTE: Thunderbolt is new technology. Thunderbolt cable and Thunderbolt device must be compatible with Windows. To determine whether your device is Thunderbolt Certified for Windows, see <https://thunderbolttechnology.net/products>.

Storage



NOTE:

- Back up all critical data prior to drive troubleshooting.
- Prior to contacting support, HP recommends that you run a drive (HDD, SSD, M.2 drive) test using the HP PC Hardware Diagnostics (UEFI) tool on the suspected failed drive.
- Diagnose the hard drive using BIOS, Diagnostics built in the shipping image, or an external USB (http://www8.hp.com/us/en/campaigns/hpsupportassistant/pc-diags.html?jumpid=va_r602_us/en/any/pps/pl_ot_ob_ds_pd/HP_PC_Hardware_Diagnostics_cc/dt).
- The drive quick test is recommended to quickly (less than 10 minutes) identify the malfunctioning drive. If the issue still exists, run Extensive Test (more than 2 hours, or loop mode, which will run until an error occurs).
- If any test fails, record failure code and contact support for instructions on how to order a replacement hard drive.
- If all of the tests pass, the hard drive is not damaged. As a rule, HP will not replace a hard drive under warranty that does not fail the HP Hard Drive Self-Test.
- If there is no physical problem with the hard drive (or memory), then try reinstalling the Windows operating system to troubleshoot the problem.

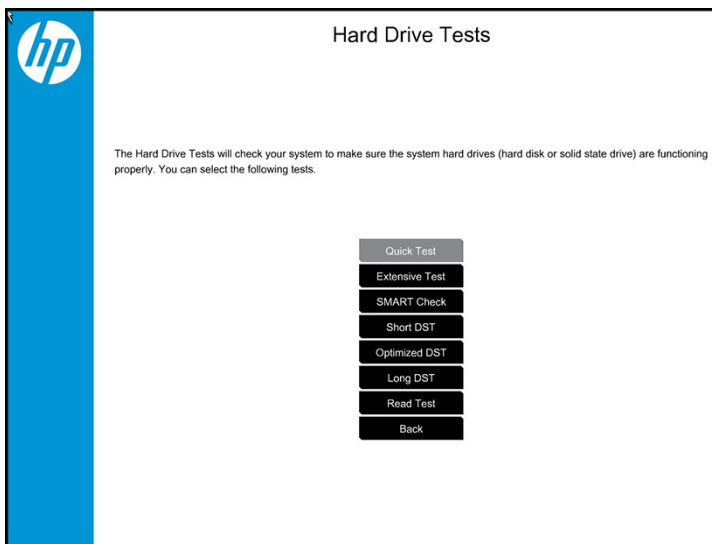

Hard drive/solid-state drive not recognized

Items	Procedures
<i>Symptom</i>	<i>Possible causes</i>
Hard drive is not recognized during POST	Loose connection, faulty hard drive, faulty drive configuration/BIOS setting.
	<i>Troubleshooting steps</i>
	<ol style="list-style-type: none">1. Perform a hard reset (8. Hard reset on page 88).2. Reset BIOS to default.3. Verify hard drive connection and flex cable. Reseat hard drive and cable connection. For multiple storage devices, keep the primary drive with the operating system and remove other devices.4. Use the HP Hardware Diagnostics tool to verify the drive is recognized and test it.5. If the hard drive fails diagnostics, record failure and have the drive replaced.6. Identify when the issue is related to software. If the hard drive passes diagnostics, test the drive on a verified working computer. If the failure follows the drive, reinstall the operating system to make sure software is not an issue.7. Test with a verified working hard drive. If it is still not recognized, the system board is faulty.
	NOTE: If the drive is seen in BIOS and Diagnostics, try a secure erase prior to replacing a drive as this may resolve related issues.

No boot to operating system (no read/write error)

Items	Procedures
<i>Symptoms</i>	<i>Possible causes</i>
<ul style="list-style-type: none">• Post error message: Boot Device not found (3F0)• Hang when booting to operating system	Operating system, loose connection, faulty hard drive, BIOS configuration, Secure Boot.
	<i>Troubleshooting steps</i>
	<ol style="list-style-type: none">1. Verify if Secure Boot is enabled in BIOS. Secure Boot prevents legacy boot devices from starting the computer, including bootable CDs and DVDs. For more information, see http://support.hp.com/us-en/document/c03653226.2. Reset BIOS to default. Be sure that BIOS Boot Mode in Boot Option is set up properly for bootable device and its operating system (i.e., UEFI Native for Windows 8). Another example, choosing Legacy Boot Order for an UEFI device will cause "Boot Device not found (3F0)" error.3. Verify hard drive connection and flex cable. Reseat connection. For multiple storage devices, keep the primary drive with the operating system and remove other devices.4. Use PC Hardware Diagnostics tool to test. Record failure code and have the hard drive replaced.5. If there is no error, reinstall the operating system using HP Restore.6. Test with a verified working operating system hard drive, if available.
Note	If there is a hard drive POST error message, see POST Error Messages and User Actions on page 138 .

Read-write error

Items	Procedures
<i>Symptoms</i>	<i>Possible causes</i>
<ul style="list-style-type: none">Post error message (i.e., error code 301)Hang when working on data, files, documents	Loose connection, faulty hardware.
	<i>Troubleshooting steps</i>
	<ol style="list-style-type: none">Perform a hard reset (8. Hard reset on page 88).Reset BIOS to default (9. Soft reset (Default Settings) on page 89).Verify drive connection and flex cable. Reseat connection (10. Reseat cables and connections on page 89).Use the HP Hardware Diagnostics tool to test. If failed, record failure code and have the hard drive replaced.If no error with HP PC Hardware Diagnostics (UEFI) tool, try to repair the hard drive and its files in Windows (using command "<code>CHKDSK /f /r /x</code>"). Use HP Restore to reinstall the operating system, if needed.Test with a verified working hard drive. If it is not recognized, the system board is faulty.
Note	If there is a hard drive POST error message, see POST Error Messages and User Actions on page 138 .

Slow performance

Items	Procedures
<i>Symptoms</i>	<i>Possible causes</i>
Slow performance even when performing small read/write operations	Operating system files, hard drive is full.
	<i>Troubleshooting steps</i>
	<ol style="list-style-type: none">Transfer data from the hard drive to create more space. Microsoft recommends at least 200 MB to sync system files.Perform disk defragmentation to consolidate fragmented data on the hard drive so it will work more efficiently. <p>NOTE: Do not defrag an SSD.</p>
Tips & tricks	For optimal system performance, you need to place your operating system and all of your most commonly used applications and files in the fastest hard drive (solid-state drive) and fastest areas on the drive (primary partition of 200 GB max).
	See Routine Maintenance for Performance Improvement on page 140 .

Blue screen (BSOD) error

Faulty hard drive may cause blue screen error. Perform the drive tests using the HP Diagnostics Tool to make sure the drive is functional. If all of the tests pass, see [Common Blue Screen Error Messages on page 140](#) for detailed troubleshooting steps.

Noisy hard drive



IMPORTANT: An SSD has no moving parts, so it does not make loud or clicking noise.

Depending on type and rotational speed, some hard drives will make more noise than others.

Not all noises are related to the fan or hard drive.

Items	Procedures
<i>Symptoms</i>	<i>Possible causes</i>
<ul style="list-style-type: none">Loud noise from hard driveClicking noise from hard driveStill boots to operating system and operates normally	BIOS, hard drive firmware, driver, faulty drive, power supply (AC adapter).
	<i>Troubleshooting steps</i>
	<ol style="list-style-type: none">Update BIOS and hard drive firmware.Examine AC adapter to be sure that it is not faulty or overloaded. Disconnect all peripherals (USB storages, dock, etc.).Remove hard drive to isolate the noise.Test the hard drive on a verified working computer if the noise continues. If the hard drive makes the same noise or clicking sounds, the sounds are either normal sounds for the hard drive or a fault with the hard drive.Verify original hard drive connection and flex cable. Reseat hard drive and connection.Run HP PC Hardware Diagnostics (UEFI). If failed, record failure code and have the hard drive replaced.If no error with HP PC Hardware Diagnostics (UEFI), perform disk defragmentation (some hard drives make a clicking noise when highly fragmented).
Tips & tricks	For optimal system performance, place your operating system and all of your most commonly used applications and files on the fastest hard drive or solid-state drive and on the fastest areas on the drive (primary partition of 200 GB max). See Routine Maintenance for Performance Improvement on page 140 .

Mechanical

Fan error message - 90B

Items	Procedures
<p><i>Symptoms</i></p> <p>Fan error 90B at boot</p> <p>CAUTION: May lead to system shutdown, data loss or possible system damage.</p>	<p><i>Possible causes</i></p> <p>Defective fan; out-of-date BIOS.</p> <ul style="list-style-type: none">• The system fan is not spinning or not spinning properly (loose connection, fan is stuck or defective).• The temperature inside the case is too high, and the fan cannot spin fast enough to remove the heat due to an obstruction to air flow. <div data-bbox="699 590 1422 884" style="border: 1px solid black; padding: 5px;"><p>The system has detected that a cooling fan is not operating correctly.</p><p>Continued operation is not recommended and may cause unpredictable behavior that could result in random shutdown, data loss or possible system damage. The system will shut down in 15 seconds. To prevent shutdown and continue operation, press the enter key now.</p><p>System Fan (90B) ENTER – Continue Startup</p><p>For more information, please visit: www.hp.com/go/techcenter/startup</p></div>
	<p><i>Troubleshooting steps</i></p> <p>General actions</p> <ol style="list-style-type: none">1. Update BIOS and drivers (4. Update BIOS and drivers on page 84) or reset BIOS to default. BIOS may implement new fan characteristics and updates for other components.2. Perform a hard reset (8. Hard reset on page 88). Performing a hard reset can reset recorded thermal values in memory. <p>Thermal-related issue</p> <ol style="list-style-type: none">1. Verify thermal condition:<ol style="list-style-type: none">a. Check fan and connection. Reseat fan cable.b. Be sure that no obstructions or dust are in heat sink fan, fin, or vent.c. Test fan using HP PC Hardware Diagnostics (UEFI) tool (6. HP Hardware Diagnostics and Tools on page 85). Be sure that the fan is not producing loud noise and that fan blades spin correctly.d. Test with a verified working fan.e. Remove old thermal compound and pads, and replace properly with new pads.2. Verify thermal solution<ul style="list-style-type: none">▲ Use Thermal Monitor tool (available only to authorized service providers/ technicians) to run stress test (processor and GPU) and verify that thermal sensors are within limits after thermal condition is serviced.
<p>Note</p>	<p>BIOS currently omits fan presence detection to shorten boot time delay less than four seconds. Therefore, the fan error is generated based on previous boot to operating system that found system fan error.</p> <p>Fan often is part of thermal solution, including heat sink, fin/ muffler, and thermal grease. Fan replacement requires reboot and fan function verification using HP PC Hardware Diagnostics (UEFI) tool.</p>

Items	Procedures
	See https://support.hp.com/us-en/document/c01657439 .



Noise (sound)

Items	Procedures
<i>Symptoms</i>	<i>Possible causes</i>
Computer emits abnormal noise	Aside from basic components (power adapter/supply, fan, speaker, hard drive, optical drive, display panel, external devices), it is also common for electronic components to produce noise.
	<i>Troubleshooting steps</i>
	<ol style="list-style-type: none"> 1. Inspect external power source and change to verified working one. 2. Determine whether the noise comes from AC power adapter. Test with a verified working AC adapter.
	Disconnect external devices and all cables connected to the computer to isolate issue to computer only.
Noisy fan	Determine whether the noise comes from the fan. Disconnect the fan briefly to isolate whether noise originates from fan. If noise is absent with fan disconnected, refer to Fan runs constantly on page 133 .
Noisy hard drive	Determine whether the noise comes from the hard drive. See Noisy hard drive on page 130 .
Noisy optical drive	<ol style="list-style-type: none"> 1. Determine whether the noise comes from an optical drive. 2. Remove CD/DVD from the optical drive.
Noisy speaker	<ol style="list-style-type: none"> 1. Determine whether the noise comes from speaker. 2. Test with a verified working external headset/speaker.
Noisy display	Determine whether the noise comes from display panel (humming noise). Change display frequency settings. See Display on page 112 .
The section below is intended for authorized service providers/technicians.	
	<ol style="list-style-type: none"> 1. After disassembling the chassis, inspect components of the interior for excessive wear or damage. 2. If noise issues persist, proceed with process of elimination for battery, AC adapter, or boards.

Fan runs constantly

Items	Procedures
<i>Symptoms</i>	<i>Possible causes</i>
<ul style="list-style-type: none">• Fan never stops running• Generates heat• Decreased computer performance	<ul style="list-style-type: none">• BIOS not up to date.• Thermal condition (fan, air flow)--fan may not be defective but must run constantly to remove excess heat generated by electrical components.• Inappropriate configuration.
	<i>Troubleshooting steps</i>
	General actions
	<ol style="list-style-type: none">1. Verify whether BIOS is set to Fan Always on while on AC Power F10 Setup. When booting the computer, press F10 to open Setup, and then select Advanced > Built-In Device Options Menu.2. Update BIOS and drivers (4. Update BIOS and drivers on page 84) and reset BIOS to default. BIOS may implement new fan characteristics and updates for other components.3. Perform a hard reset (8. Hard reset on page 88). Performing a hard reset can reset recorded thermal values in memory.
	Thermal-related issue
	<ol style="list-style-type: none">1. Verify fan is spinning. Reseat fan cable before moving to next step.<ol style="list-style-type: none">a. Check fan and connection. Reseat fan cable.b. Be sure that no obstructions or dust are in heat sink fan, heat sink fin, or vent.c. Test fan using HP PC Hardware Diagnostics (UEFI) tool (6. HP Hardware Diagnostics and Tools on page 85). Be sure that the fan is not producing loud noise and that fan blades spin correctly.d. Test with a verified working fan.e. Replace the fan.2. Verify thermal solution<p>Use Thermal Monitor tool (available only to authorized service providers/technicians) to run stress test (processor and GPU) and verify that thermal sensors are within limits after thermal condition is serviced.</p>
	User configuration
	Change Power Options in Windows (i.e., choosing Balanced mode instead of High performance). High performance and extensive graphics may cause the fan run constantly to release the heat.
Notes	<p>BIOS currently omits fan presence detection to shorten boot time delay less than four seconds. Therefore, the fan error is generated based on previous boot to operating system that found system fan error.</p> <p>Fan often is part of thermal solution, including heat sink, heat sink fin/muffler, and thermal grease. Fan replacement requires reboot and fan function verification using HP PC Hardware Diagnostics (UEFI) tool.</p> <p>For more information, see the following links:</p> <ul style="list-style-type: none">• http://support.hp.com/us-en/document/c01007591.• https://support.hp.com/us-en/document/c01657439.

Thermal shutdown (hot)

Items	Procedures
<p><i>Symptoms</i></p> <p>Similar to fan runs constantly issue (Fan runs constantly on page 133)</p> <ul style="list-style-type: none"> • System shutdown • Abnormal heat • Continually running fan • Decreased computer performance 	<p><i>Possible causes</i></p> <p>BIOS not up to date, thermal condition (fan, air flow)</p> <hr/> <p><i>Troubleshooting steps</i></p> <ol style="list-style-type: none"> 1. Update BIOS and drivers (4. Update BIOS and drivers on page 84) and reset BIOS to default. BIOS may implement new fan characteristics and updates for other component. 2. Perform a hard reset (8. Hard reset on page 88). Performing a hard reset can reset recorded thermal values in memory. 3. Determine whether you are using a correct AC adapter. 4. Be sure to turn power off completely when putting a notebook in a travel bag.
 	<p>Thermal-related issue</p> <ol style="list-style-type: none"> 1. Verify thermal condition: <ol style="list-style-type: none"> a. Check fan and connection. Reseat fan cable. b. Be sure that no obstructions or dust are in heat sink fan, fin, or vent. c. Be sure that the notebook is not sitting on a hot surface that blocks vent intakes. d. Test fan using HP PC Hardware Diagnostics (UEFI) tool (6. HP Hardware Diagnostics and Tools on page 85). Be sure that the fan is not producing a loud noise and that fan blades spin correctly. e. Test with a verified working fan. f. Remove old thermal compound and pads, and replace properly with new pads. 2. Verify thermal solution: <ul style="list-style-type: none"> ○ Use Thermal Monitor tool (available only to authorized service providers/technicians) to run stress test (processor and GPU) and verify that thermal sensors are within limits after thermal condition is serviced.
Note	See https://support.hp.com/us-en/document/c01657439 .

Stuck power button

Items	Procedures
<p><i>Symptoms</i></p> <ul style="list-style-type: none"> • Rear power indicator light is on • Will not turn on when power button is pressed • Automatically powers on 	<p><i>Possible causes</i></p> <p>Sticky or defective power button.</p> <hr/> <p><i>Troubleshooting steps</i></p> <p>General actions</p> <ol style="list-style-type: none"> 1. Perform a hard reset (8. Hard reset on page 88). 2. Perform a soft reset if system can turn on.
The sections below are intended for authorized service providers/technicians.	
	<ol style="list-style-type: none"> 1. Disassemble the unit. 2. Inspect power button on the top cover and on the system board to make sure these buttons moves freely.

Additional information

The following sections provide additional information that can be used during the troubleshooting process.

Acronyms

The following acronyms are used in this chapter.

Blue screen (BSOD)—A Windows error screen that can occur if a problem causes your computer to shut down or restart unexpectedly. When you experience this type of error, you will not be able to see items such as the Start menu or the taskbar when your computer is turned on. Instead you might see a blue screen with a message that your computer ran into a problem and needs to restart.

CPU—Central processing unit

DIMM—Dual in-line memory module

Daughterboard—Type of circuit board that plugs into or is attached to the system board or similar expansion card to extend its features and services.

GPU—Graphics processor unit

GTS—General Troubleshooting Step

HDD—Hard drive

KB—Keyboard

LVDS—Low-Voltage Differential Signaling

MSG—Maintenance and Service Guide

mWS—Mobile Workstations

WS—Workstations

OS—Operating system

PC—Personal computer

POST—Power-On Self-Test

SSD—Solid-state drive

TSG—Troubleshooting Guide

UEFI—Unified Extensible Firmware Interface

WLAN—Wireless local area network

WWAN—Wireless wide area network

Blinking lights and boot error codes

The information below is from the white paper <http://h10032.www1.hp.com/ctg/Manual/c04685655>.

In some cases, when the host processor is not executing code or does not have the necessary code to drive the display, light blink codes inform you of a problem.

Table 7-7 Boot-error codes

Blink codes	Error
Amber battery light: blinks 1 Hz continuously	Embedded Controller unable to load firmware
Caps/num lock lights = 1 blink	Processor not executing code
Caps/num lock lights = 2 blinks	BIOS recovery code unable to find valid BIOS recovery image
Caps/num lock lights = 3 blinks	Memory module error
Caps/num lock lights = 4 blinks	Graphics controller error
Caps/num lock lights = 5 blinks	System board error
Caps/num lock lights = 6 blinks	Intel Trusted Execution Technology (TXT) Error
Caps/num lock lights = 7 blinks	Sure Start unable to find valid BIOS Boot Block image
Caps/num lock lights = 8 blinks	Sure Start has identified a problem (Manual Recovery Policy Set)

Processor not executing code

This computer has experienced a problem due to the failure of certain code to execute, resulting in a failed startup of the processor. The issue could be related to the processor or the system board in the computer. If the processor is socketed, be sure that the processor is seated correctly in the socket. If this error reoccurs, refer to [General troubleshooting steps on page 80](#).

 **NOTE:** The computer will attempt to notify you of this problem through a series of blinking lights. When you attempt to turn on the computer from an “Off” or “Hibernated” state, lights associated with the [caps lock](#) and [num lock](#) keys will both **blink once** followed by a pause, and then continue in a repeating pattern.

BIOS recovery code unable to find valid BIOS recovery image

This computer has experienced a problem in locating a valid BIOS image, resulting in a failed startup. This problem may be resolved by placing a clean copy of the system BIOS on a USB key or in the appropriate hard drive directory and performing a reboot. If this error reoccurs, refer to [General troubleshooting steps on page 80](#).

 **NOTE:** The computer will attempt to notify you of this problem through a series of blinking lights. When you attempt to turn on the computer from an “Off” or “Hibernated” state, lights associated with the [caps lock](#) and [num lock](#) keys will both **blink twice** followed by a pause, and then continue in a repeating pattern.

Memory module error

This computer has experienced a memory initialization problem resulting in a failed startup. This issue may be related to the memory modules in the computer. This problem may be resolved by ensuring that memory modules are correctly inserted and seated. If this error reoccurs, a service event is required to determine the source of the error (memory modules or system board) and take the appropriate corrective action.

 **NOTE:** The computer will attempt to notify you of this problem through a series of blinking lights. When you attempt to turn on the computer from an “Off” or “Hibernated” state, lights associated with the [caps lock](#) and [num lock](#) keys will both **blink three times** followed by a pause, then continue in a repeating pattern.

Graphics Controller Error (No Controller)

This computer has experienced a graphics controller initialization problem resulting in a failed startup. This issue may be related to the graphics controller in your machine. This problem may be resolved by ensuring that the graphics controller module is seated correctly in machines with modular graphics. If this error reoccurs, a service event is required to identify the source of the error and take the appropriate corrective action.

 **NOTE:** The computer will attempt to notify you of this problem through a series of blinking lights. When you attempt to turn on the computer from an “Off” or “Hibernated” state, lights associated with the [caps lock](#) and [num lock](#) keys will both **blink four times** followed by a pause, then continue in a repeating pattern.

Failure - System Board Error

This computer has experienced a system board initialization problem resulting in a failed startup. This issue may be related to the system board in the computer. A service event is required to identify the source of the error and take the appropriate corrective action.

 **NOTE:** The computer will attempt to notify you of this problem through a series of blinking lights. When you attempt to turn on the computer from an “Off” or “Hibernated” state, lights associated with the [caps lock](#) and [num lock](#) keys will both **blink five times** followed by a pause, then continue in a repeating pattern.

Intel Trusted Execution Technology (TXT) Error

This computer has experienced a problem related to the Intel Trusted Execution Technology resulting in a failed startup. The error occurs when all of the following are true:

- The Intel Trusted Execution Technology (TXT) has been enabled on the computer.
- Policies have been set to prevent startup if the BIOS measurement has changed.
- The BIOS measurement has changed.

For more information about Intel TXT, go to <http://www.intel.com/content/dam/www/public/us/en/documents/white-papers/trusted-execution-technology-security-paper.pdf>.

A service event is required to resolve this issue.

 **NOTE:** The computer will attempt to notify you of this problem through a series of blinking lights. When you attempt to turn on the computer from an “Off” or “Hibernated” state, lights associated with the [caps lock](#) and [num lock](#) keys will both **blink six times** followed by a pause, then continue in a repeating pattern.

Sure Start unable to find valid BIOS Boot Block image

This computer has experienced a problem in locating a valid BIOS image, resulting in a failed startup. A service event is required to identify the source of the error and take appropriate corrective action.

 **NOTE:** The computer will attempt to notify you of this problem through a series of blinking lights. When you attempt to turn on the computer from an “Off” or “Hibernated” state, lights associated with the [caps lock](#) and [num lock](#) keys will both **blink seven times** followed by a pause, then continue in a repeating pattern.

Sure Start has identified a problem (Manual Recovery Policy Set)

This computer has experienced a problem in locating a valid BIOS image, resulting in a failed startup. HP Sure Start will normally repair this type of issue; however, on this computer HP Sure Start has been configured to operate in manual mode key sequence. To proceed with the repair, press and hold the following keys: <ESC> +<UP arrow>+<DOWN arrow>. To avoid the need for this manual recovery step, set the HP Sure Start recovery policy to automatic. If this error reoccurs, a service event is required to identify the source of the error and take appropriate corrective action.



NOTE: The computer will attempt to notify you of this problem through a series of blinking lights. When you attempt to turn on the computer from an “Off” or “Hibernated” state, lights associated with the **caps lock** and **num lock** keys will both **blink eight times** followed by a pause, then continue in a repeating pattern.

POST Error Messages and User Actions

Test description	Failure descriptions	Error code	Possible user actions
Product information	Invalid value	00A	Contact support for assistance.
Startup test	Memory module	200	Attempt to reseat the memory module and then repeat the test. Search http://www.hp.com/support for details on troubleshooting issues related to the memory module. If the memory module still fails, contact support.
Startup test	Hard Disk 1 SMART	301	Attempt to reseat the hard drive and repeat the test. The hard disk drive may have failed. Contact support for assistance.
Startup test	Hard Disk 2 SMART	302	The hard drive may have failed. Contact support for assistance.
Startup test	Hard Disk 1 Quick	303	The hard drive may have failed. Contact support for assistance.
Startup test	Hard Disk 2 Quick	304	The hard drive may have failed. Contact support for assistance.
Run-in test	Memory module	200	Attempt to reseat the memory module and then repeat the test. Search http://www.hp.com/support for details on troubleshooting issues related to the memory module. If the memory module still fails, contact support.
Run-in test	Hard Disk 1 SMART	301	Attempt to reseat the hard drive and repeat the test. The hard drive may have failed. Contact support for assistance.
Run-in test	Hard Disk 2 SMART	302	The hard drive may have failed. Contact support for assistance.
Run-in test	Hard Disk 1 Quick	303	The hard drive may have failed. Contact support for assistance.
Run-in test	Hard Disk 2 Quick	304	The hard drive may have failed. Contact support for assistance.
Hard Disk Test	Hard Disk 1 SMART	301	Attempt to reseat the hard drive and repeat the test. The hard drive may have failed. Contact support for assistance.
Hard Disk Test	Hard Disk 2 SMART	302	The hard drive may have failed. Contact support for assistance.
Hard Disk Test	Hard Disk 1 Quick	303	The hard drive may have failed. Contact support for assistance.
Hard Disk Test	Hard Disk 2 Quick	304	The hard drive may have failed. Contact support for assistance.
Hard Disk Test	Hard Disk 1 Full	305	The hard drive may have failed. Contact support for assistance.

Test description	Failure descriptions	Error code	Possible user actions
Hard Disk Test	Hard Disk 2 Full	306	The hard drive may have failed. Contact support for assistance.
Boot Device Manager	Boot device not found	3F0	Indicates a potential problem with the hard drive. Please run the hard drive test. See https://support.hp.com/emea_africa-en/document/c01443371 for more information.
Boot Device Manager	Hard Disk 1 Error	3F1	Indicates a potential problem with the hard drive. Run the hard drive test. See https://support.hp.com/emea_africa-en/document/c01443371 for more information.
Boot Device Manager	Hard Disk 2 Error	3F2	Indicates a potential problem with the hard drive. Run the hard drive test. See https://support.hp.com/emea_africa-en/document/c01443371 for more information.
Boot Device Manager	Hard Disk 1 SMART	301	Indicates a potential problem with the hard drive. Run the hard drive test. See https://support.hp.com/emea_africa-en/document/c01443371 for more information.
Boot Device Manager	Hard Disk 2 SMART	302	Indicates a potential problem with the hard drive. Run the hard drive test. See https://support.hp.com/emea_africa-en/document/c01443371 for more information.
BIOS Recovery	BIOS Recovery Occurred	500	This message indicates that BIOS recovery was completed successfully. No further action is required.
BIOS Application	BIOS Application Error	501	The BIOS installation may have become corrupted. Download the latest version of the BIOS and install it. See 4. Update BIOS and drivers on page 84 for more information. If reinstalling the BIOS fails, contact support for further assistance.
CMOS Recovery	CMOS Recovery Occurred	502	This message indicates that CMOS recovery was completed successfully. No further action is required.
Battery Check	Primary Battery Replace	601	This indicates that the primary battery has very low capacity. Search http://www.hp.com/support for details on using the HP Support Assistant to verify the battery capacity and, if necessary, order a replacement.
Battery Check	Secondary Battery Replace	602	This indicates that the secondary battery has very low capacity. Search http://www.hp.com/support for details on using the HP Support Assistant to verify the battery capacity and, if necessary, order a replacement.
Wireless Module	Not installed or responding	701	Reseat the wireless LAN adapter module, if your notebook supports it. Because seating or reseating a wireless LAN adapter is unique to each computer model. For more information, see the chapter titled "Removal and replacement procedures for Customer Self-Repair parts."
Fan	Fan not operating correctly	90B	The system fan may be malfunctioning. For information on troubleshooting heat-related issues, see http://support.hp.com/us-en/document/c01007591 . A hard reset can sometimes restore the system fan to working order. See https://support.hp.com/us-en/document/c01684768 for details. If the system fan continues to malfunction, contact support.

Routine Maintenance for Performance Improvement

The following table presents a summary of the suggested times for performing the routine maintenance tasks described in this document.

Tasks	Weekly	Monthly	Occasionally
Perform a system tune up.	X		
Run Windows Update.	X		
Scan for and remove viruses.	X		
Scan for and remove spyware and adware.	X		
Empty the Recycle Bin.	X		
Delete temporary Internet files.	X		
Back up user files.		X	
Create a restore point.		X	
Defragment the hard drive.		X	
Run Scan Disk.		X	
Clean the exterior of the computer.			X
Close programs that are not being used.			X
Prevent programs from loading at startup.			X

Common Blue Screen Error Messages

Error message list

The following image shows an example of one possible “[https://msdn.microsoft.com/en-us/library/windows/hardware/hh994433\(v=vs.85\).aspx](https://msdn.microsoft.com/en-us/library/windows/hardware/hh994433(v=vs.85).aspx)” from Microsoft:

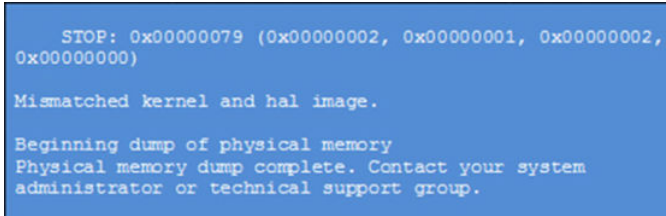

```
STOP: 0x00000079 (0x00000002, 0x00000001, 0x00000002,
0x00000000)

Mismatched kernel and hal image.

Beginning dump of physical memory
Physical memory dump complete. Contact your system
administrator or technical support group.
```

The hexadecimal number following the word "STOP" is called the bug check code or Stop code. This is the most important item on the screen.

Bug check symbolic names

Each bug check code also has an associated symbolic name. In the example, the screen shows [https://msdn.microsoft.com/en-us/library/windows/hardware/ff559209\(v=vs.85\).aspx](https://msdn.microsoft.com/en-us/library/windows/hardware/ff559209(v=vs.85).aspx) (MISMATCHED_HAL).

Microsoft general troubleshooting of Windows bug check codes

- If you recently added hardware to the system, try removing or replacing it. Or check with the manufacturer to see if any patches are available.
- Try running HP PC Hardware Diagnostics (UEFI).
- Check with the manufacturer to see if an updated system BIOS or firmware is available.
- Be sure that any expansion board is properly seated and all cables are completely connected.
- Confirm that any new hardware that is installed is compatible with the installed version of Windows.
- If new device drivers or system services have been added recently, try removing or updating them.



NOTE: Use safe mode when removing or disabling components. Safe mode loads only the minimum required drivers and system services during the Windows startup. To enter safe mode, restart your computer and press **F8** at the menu that displays the operating system choices. At the resulting **Windows Advanced Options** menu, choose **Safe Mode**.

- Run a virus detection program. Viruses can infect all types of hard drives formatted for Windows, and resulting drive corruption can generate system bug check codes. Be sure that the virus detection program checks the Master Boot Record for infections.
- Verify that the system has the latest service pack installed. To detect which service pack, if any, is installed on your system, click **Start**, click **Run**, type `winver`, and then press **Enter**. The **About Windows** dialog box displays the Windows version number and the version number of the service pack, if one has been installed.
- Disable BIOS memory options such as caching or shadowing.
- Check the System Log and Application Log in Event Viewer to see if any additional error messages have been logged recently. These might pinpoint the cause of the error.

Use Windows Debugging Tool

The [https://msdn.microsoft.com/library/windows/hardware/ff551063%20\(v=vs.85\).aspx](https://msdn.microsoft.com/library/windows/hardware/ff551063%20(v=vs.85).aspx) is one of the primary tools used by Microsoft software developers to analyze and resolve errors that result in memory dumps. Use the tool to determine the cause of the error. Follow general steps for downloading, setting up, and using the Windows 10 debugging tool. A similar process is used for Windows 7 or Windows 8.



NOTE: The following screen shots provide only an example of the tool. Specifics shown are not representative of all applications of the debugging tool. This is a Microsoft tool supported by Microsoft.

Windows Software Development Kit (SDK)

1. Download the SDK from the following link:
<https://dev.windows.com/en-US/downloads/windows-10-sdk>
2. Set up the SDK in the configuration window (Windows 10 shown).

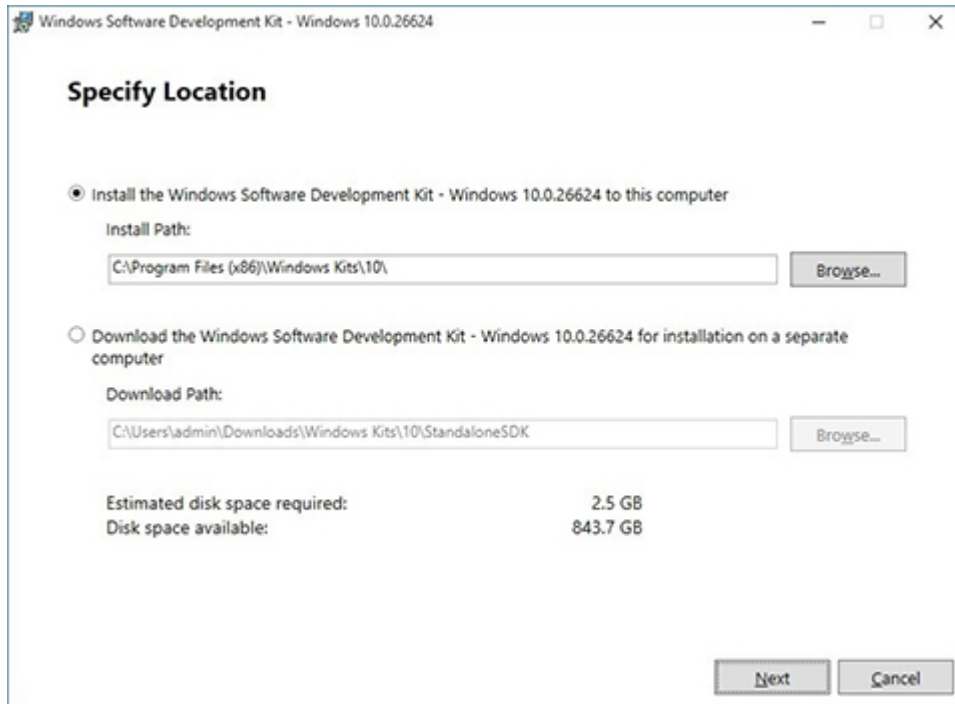

3. Select features to install.

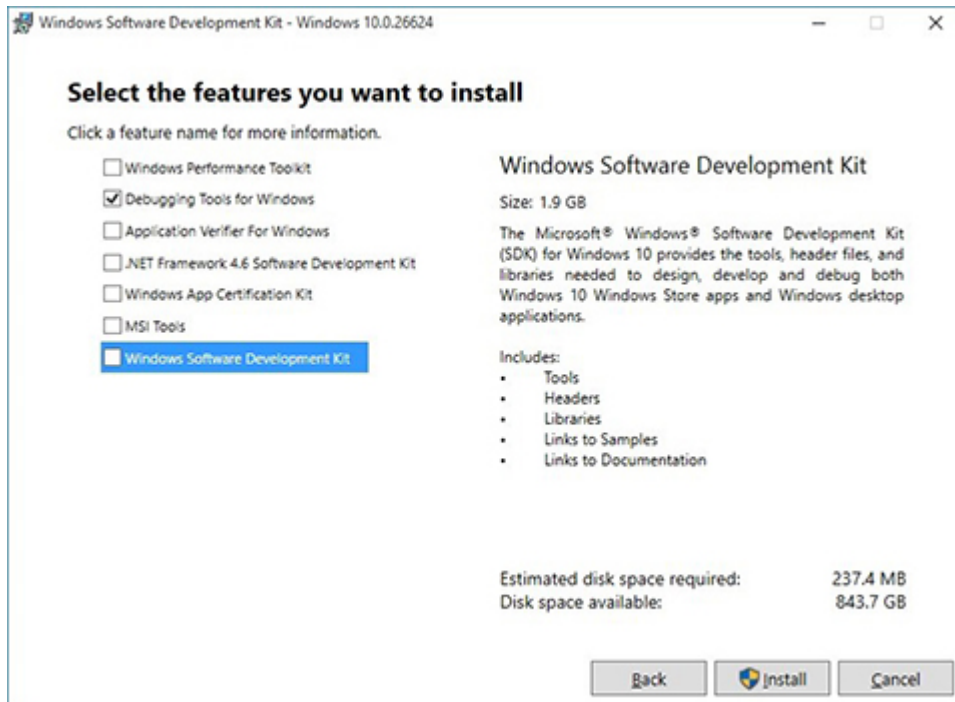

4. Run the SDK as an administrator.

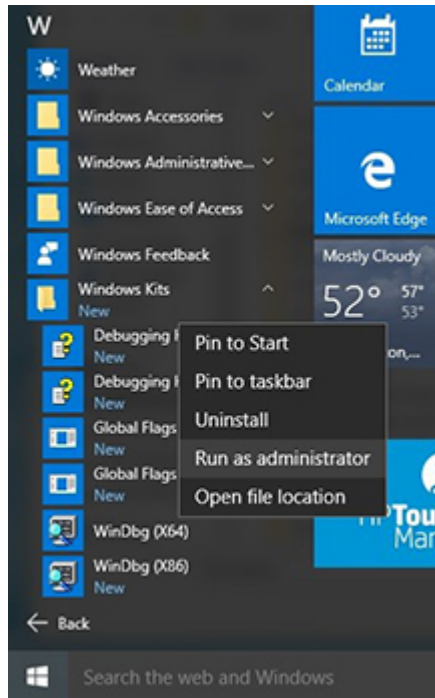

5. Set the symbol path. Select **File > Symbol File Path**.

- In the **Symbol path** box, type `SRV*C:\Windows\symbol_cache*http://msdl.microsoft.com/download/symbols`.
- Save the workspace.

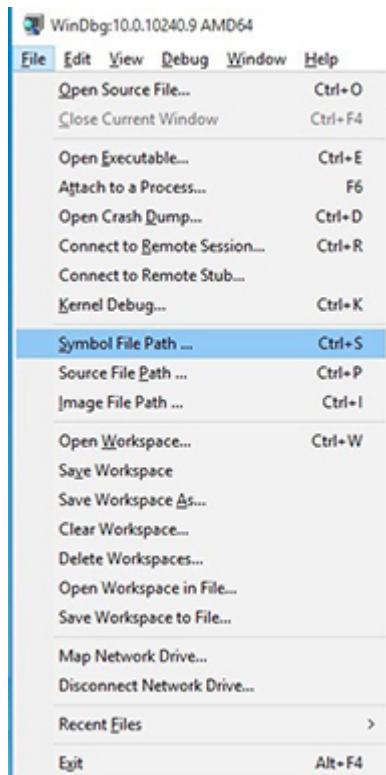

6. Open the crash dump file.

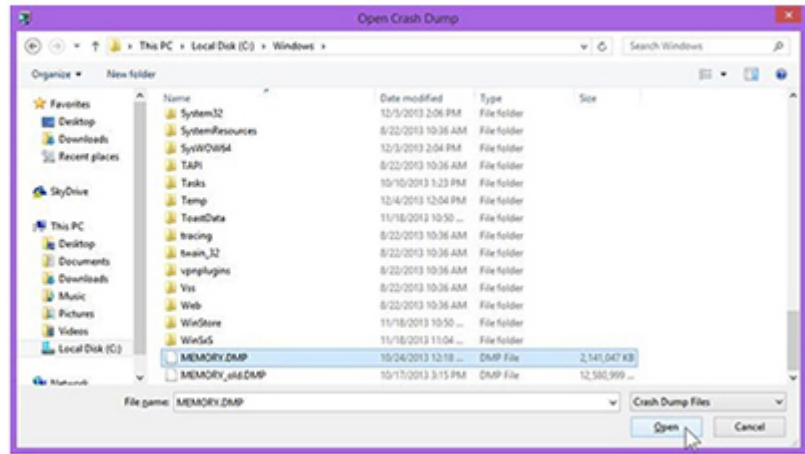
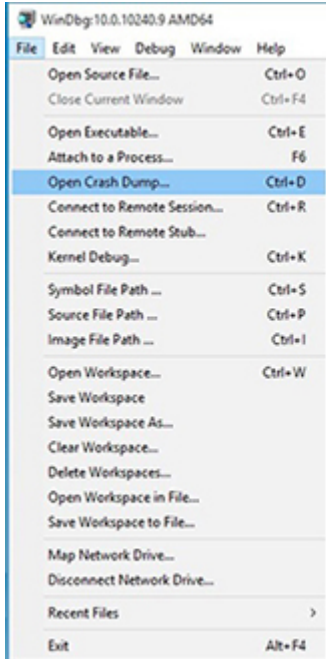

- Analyze the file. In the following memory dump sample, look for Bug Check 0x3B. The ATKMAG driver needs to be investigated for further root cause.

Lookup for Bug Check 0xC2.

```
1: kd> !analyze -v
.....
*
*                               Bugcheck Analysis
*
*
*
.....

SYSTEM_SERVICE_EXCEPTION (3b)
An exception happened while executing a system service routine.
Arguments:
Arg1: 0000000c00000005, Exception code that caused the bugcheck
Arg2: fffff8006d927acf, Address of the instruction which caused the bugcheck
Arg3: fffffd00020e4e500, Address of the context record for the exception that caused the bugcheck
Arg4: 0000000000000000, zero.

Debugging Details:
-----
BUGCHECK_P1: c0000005
BUGCHECK_P2: fffff8006d927acf
BUGCHECK_P3: fffffd00020e4e500
BUGCHECK_P4: 0
EXCEPTION_CODE: (NTSTATUS) 0xc0000005 - The instruction at 0x%p referenced memory at 0x%p. The memory

FAULTING_IP:
atikmpag+2facf
fffff800`6d927acf 4539bc2434030000 cmp     dword ptr [r12+334h],r15d
...

SYMBOL_STACK_INDEX: 0
SYMBOL_NAME: atikmpag+2facf
FOLLOWUP_NAME: MachineOwner
MODULE_NAME: atikmpag
IMAGE_NAME: atikmpag.sys
DEBUG_FLR_IMAGE_TIMESTAMP: 55479b42
STACK_COMMAND: .cxr 0xffffd00020e4e500 ; kb
BUCKET_ID_FUNC_OFFSET: 2facf
FAILURE_BUCKET_ID: 0x3B_atikmpag!Unknown_Function
BUCKET_ID: 0x3B_atikmpag!Unknown_Function
PRIMARY_PROBLEM_CLASS: 0x3B_atikmpag!Unknown_Function
ANALYSIS_SOURCE: KM
FAILURE_ID_HASH_STRING: km:0x3b_atikmpag!unknown_function
FAILURE_ID_HASH: {adb00875-801c-005a-68e8-645bb2f2c848}
```

```
Command - Dump C:\Windows\MEMORY.DMP - WinDbg.6.3.9600.16384 AMD64
.....
Loading User Symbols
Loading unloaded module list
.....
*
*                               Bugcheck Analysis
*
*
*
.....

Use !analyze -v to get detailed debugging information.
BugCheck C2, {7, 1205, 1159400, fffff0001137350}
*** ERROR: Module load completed but symbols could not be loaded for nldr.sys
Probably caused by : NETIO.SYS ( NETIO! ?? ::FNODOBFN::'string'+797c )

Followup: MachineOwner

<----->
0: kd>
```

Display Issue: Pixel Anomalies

All HP notebook displays adhere to strict quality and reliability specifications. A small percentage of display panels may have minor cosmetic manufacturing anomalies or irregularities such as bright or dark dots in the viewable area. These cosmetic imperfections are common to all display panel types and are not specific to any HP model or product line.

All display panel defects should be examined at the highest possible resolution using both the brightest and darkest possible backgrounds, because some sub-pixel failures may not be readily visible under certain conditions.

- Type 1: Bright dot on a dark background = Always On
- Type 2: Dark dot on a bright background = Always Off
- Combination = in any combination and any color that are always on or off

Use the HP PC Hardware Diagnostics (UEFI) tool to determine numbers of pixels and their distance. HP uses the following set of criteria when damaged displays are submitted for warranty coverage.

Source: <http://support.hp.com/us-en/document/c00035844>

Table 7-8 Electrical defect allowances

Panel resolution	Accept	Reject
Sub-pixel faults		
VGA, SVGA, SD, WSVGA, XGA, 720p, SD+, WXGA, HD	$N \leq 2$ Type 1 $N \leq 2$ Type 2	$N \geq 3$ Type 1
WXGA+, SXGA+, HD+, SXGA+	$N \leq 3$ Type 1 $N \leq 3$ Type 2	$N \geq 4$ Type 1
WSXGA+, UXGA, FHD, WUXGA	$N \leq 4$ Type 1 $N \leq 4$ Type 2	$N \geq 5$ Type 1
QHD, QHD+, WQXGA, UD	$N \leq 5$ Type 1 $N \leq 5$ Type 2	$N \geq 6$ Type 1
Electrical defect clusters (defects within a 5x5 pixel block)		
Minimum distance between ANY allowable defects (unless otherwise specified)	$S \geq 25$ mm	$S < 25$ mm
Cluster with 2 or more sub-pixels with sub-pixel faults		Not allowed
Dim lines		Not allowed
Cross line(s) on/off		Not allowed
Horizontal line(s) on/off		Not allowed
Vertical line(s) on/off		Not allowed

 **NOTE:** All LCD panel defects should be examined at the highest possible resolution using both the brightest and darkest possible backgrounds, as some sub-pixel failures may not be readily visible under certain conditions.

 **NOTE:** Contact support for assistance if issues are not listed.

Cable management

Proper routing of the internal cables is critical to the operation of the computer. Follow good cable management practices when removing and installing components.

- Handle cables with care to avoid damage.
- Apply only the tension required to seat or unseat cables during insertion or removal from the connector.
- When possible, handle cables by the connector or pull-strap.
- Route cables in such a way that they cannot be caught or snagged by parts being removed or replaced.
- Keep cables away from direct contact with major heat sources, such as the heat sink. (Some air flow guides have a cable guide that lets you route cables safely around the heat sink.)
- Do not jam cables on top of daughterboards or memory modules (DIMMs). Circuit cards and DIMMs are not designed to take excessive pressure.
- Keep cables clear of any movable or rotating parts (such as a fan) to prevent them from being cut or crimped when the component is lowered into its normal position.
- In all cases, avoid bending or twisting the cables. Do not bend any cable sharply. A sharp bend can break the internal wires.
- Do not rely on components like the keyboard or service door to push cables down internally. Always position the cables to lay properly by themselves or in the cable guides and chassis areas designed for cable routing.

 **CAUTION:** Always release connector latch before removing the cable. Otherwise, pulling the cable could damage the cable pins and result in a failed device.

Connector types

 **IMPORTANT:** Connector pins and connector gold fingers should not be touched directly with bare hands.

There are several different types of connectors on the system board with different requirements for cable removal or insertion.

Flex cable

When connecting flex cables to a ZIF connector, rotate the latch to 90 degrees, push the cable completely, evenly into the connector, and then close the latch.

When removing flex cables from a ZIF connector on the system board, the latch must be released before the cable can be removed. Always follow these steps:

1. Flip the connector latch 90 degrees to release the cable.
2. Grasp the cable end of the connector and pull it straight out.

 **CAUTION:** Always release connector latch before removing the cable. Otherwise, pulling the cable could damage the cable pins and result in a failed device.

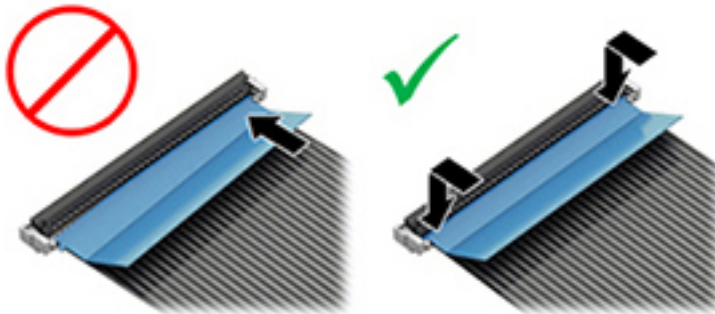

Horizontal installation cable

Use flat tool to pull connector evenly. Do not pull on cable to remove.

Slide connector into receptacle on same horizontal plane as board and use flat tool to push evenly into receptacle.

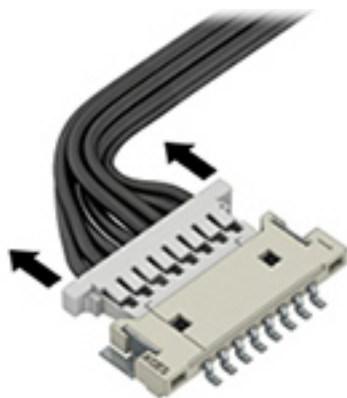

Multi-pin horizontal insert connector (LVDS cable to display panel)

Insert procedure:

1. Slide connector evenly into receptacle on same horizontal plane as PCB connector.
2. Pull lock bar to insert and push both side connector horizontally to firmly lock.
3. Tape down lock bar over the panel to hold in position.

Reverse the procedure above to remove the connector:

1. Remove tape.
2. Pull up bar (pull tape) and release the lock with the PCB connector.
3. Pull to the direction in parallel with PCB to withdraw the connector.

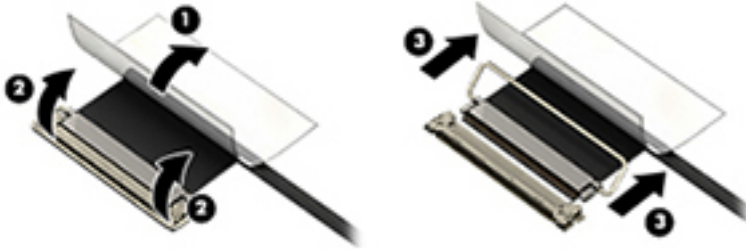

Multi-pin vertical insert connector (LVDS cable to system board)

- Remove the connector gasket prior to removing the connector.
- If the connector has a plastic pull tab, use the tab to disconnect. Otherwise, use flat tool under the connector to remove evenly. Do not pull on the cable to remove.
- Press evenly when reseating/reconnecting/installing the connector.

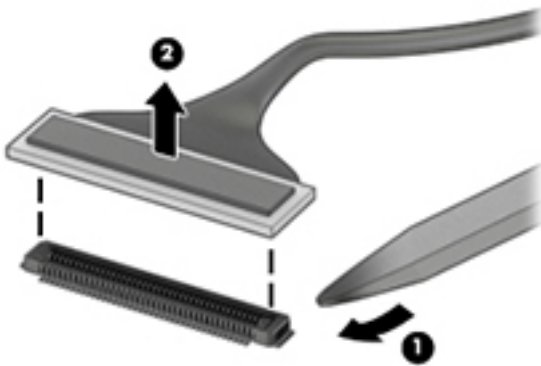

For more information about cable management, see [Cable management on page 147](#).

8 Computer Setup (BIOS), TPM, and HP Sure Start

Using Computer Setup

Computer Setup, or Basic Input/Output System (BIOS), controls communication between all the input and output devices on the system (such as disk drives, display, keyboard, mouse, and printer). Computer Setup includes settings for the types of devices installed, the startup sequence of the computer, and the amount of system and extended memory.

 **NOTE:** Use extreme care when making changes in Computer Setup. Errors can prevent the computer from operating properly.

Starting Computer Setup

- ▲ Turn on or restart the computer, and when the HP logo appears, press **f10** to enter Computer Setup.

Navigating and selecting in Computer Setup

- To select a menu or a menu item, use the **tab** key and the keyboard arrow keys and then press **enter**, or use a pointing device to select the item.
- To scroll up and down, select the up arrow or the down arrow in the upper-right corner of the screen, or use the up arrow key or the down arrow key on the keyboard.
- To close open dialog boxes and return to the main Computer Setup screen, press **esc**, and then follow the on-screen instructions.

To exit Computer Setup, choose one of the following methods:

- To exit Computer Setup menus without saving your changes, select **Main**, select **Ignore Changes and Exit**, and then select **Yes**.

 **NOTE:** If you are using arrow keys to highlight your choice, you must then press **enter**.

- To save your changes and exit Computer Setup menus, select **Main**, select **Save Changes and Exit**, and then select **Yes**.

 **NOTE:** If you are using arrow keys to highlight your choice, you must then press **enter**.

Your changes go into effect when the computer restarts.

Restoring factory settings in Computer Setup

 **NOTE:** Restoring defaults will not change the hard drive mode.

To return all settings in Computer Setup to the values that were set at the factory, follow these steps:

1. Start Computer Setup. See [Starting Computer Setup on page 150](#).
2. Select **Main**, select **Apply Factory Defaults and Exit**, and then select **Yes**.

 **NOTE:** If you are using arrow keys to highlight your choice, you must then press **enter**.

 **NOTE:** On select products, the selections may display **Restore Defaults** instead of **Apply Factory Defaults and Exit**.

Your changes go into effect when the computer restarts.

 **NOTE:** Your password settings and security settings are not changed when you restore the factory settings.

Updating the BIOS

Updated versions of the BIOS may be available on the HP website.

Most BIOS updates on the HP website are packaged in compressed files called *SoftPaqs*.

Some download packages contain a file named *Readme.txt*, which contains information regarding installing and troubleshooting the file.

Determining the BIOS version

To decide whether you need to update Computer Setup (BIOS), first determine the BIOS version on your computer.

BIOS version information (also known as *ROM date* and *System BIOS*) can be accessed by pressing **fn+esc** (if you are already in Windows) or by using Computer Setup.

1. Start Computer Setup. See [Starting Computer Setup on page 150](#).
2. Select **Main**, and then select **System Information**.
3. To exit Computer Setup menus without saving your changes, select **Main**, select **Ignore Changes and Exit**, and then select **Yes**.

 **NOTE:** If you are using arrow keys to highlight your choice, you must then press **enter**.

To check for later BIOS versions, see [Downloading a BIOS update on page 151](#).

Downloading a BIOS update

 **CAUTION:** To reduce the risk of damage to the computer or an unsuccessful installation, download and install a BIOS update only when the computer is connected to reliable external power using the AC adapter. Do not download or install a BIOS update while the computer is running on battery power, docked in an optional docking device, or connected to an optional power source. During the download and installation, follow these instructions:

Do not disconnect power on the computer by unplugging the power cord from the AC outlet.

Do not shut down the computer or initiate Sleep.

Do not insert, remove, connect, or disconnect any device, cable, or cord.

1. Type `support` in the taskbar search box, and then select the HP Support Assistant app.
– or –
Select the question mark icon in the taskbar.
2. Select **Updates**, and then select **Check for updates and messages**.
3. Follow the on-screen instructions.
4. At the download area, follow these steps:

- a. Identify the most recent BIOS update and compare it to the BIOS version currently installed on your computer. Make a note of the date, name, or other identifier. You may need this information to locate the update later, after it has been downloaded to your hard drive.
- b. Follow the on-screen instructions to download your selection to the hard drive.

Make a note of the path to the location on your hard drive where the BIOS update is downloaded. You will need to access this path when you are ready to install the update.

 **NOTE:** If you connect your computer to a network, consult the network administrator before installing any software updates, especially system BIOS updates.

BIOS installation procedures vary. Follow any instructions that are displayed on the screen after the download is complete. If no instructions are displayed, follow these steps:

1. Type *file* in the taskbar search box, and then select **File Explorer**.
2. Select your hard drive designation. The hard drive designation is typically Local Disk (C:).
3. Using the hard drive path you recorded earlier, open the folder that contains the update.
4. Double-click the file that has an .exe extension (for example, *filename.exe*).

The BIOS installation begins.

5. Complete the installation by following the on-screen instructions.

 **NOTE:** After a message on the screen reports a successful installation, you can delete the downloaded file from your hard drive.

Changing the boot order using the f9 prompt

To dynamically choose a boot device for the current startup sequence, follow these steps:

1. Access the Boot Device Options menu:
 - Turn on or restart the computer, and when the HP logo appears, press **f9** to enter the Boot Device Options menu.
2. Select a boot device, press **enter**, and then follow the on-screen instructions.

TPM BIOS settings (select products only)

 **IMPORTANT:** Before enabling Trusted Platform Module (TPM) functionality on this system, you must ensure that your intended use of TPM complies with relevant local laws, regulations and policies, and approvals or licenses must be obtained if applicable. For any compliance issues arising from your operation/usage of TPM which violates the above mentioned requirement, you shall bear all the liabilities wholly and solely. HP will not be responsible for any related liabilities.

TPM provides additional security for your computer. You can modify the TPM settings in Computer Setup (BIOS).

 **NOTE:** If you change the TPM setting to Hidden, TPM is not visible in the operating system.

To access TPM settings in Computer Setup:

1. Start Computer Setup. See [Starting Computer Setup on page 150](#).
2. Select **Security**, select **TPM Embedded Security**, and then follow the on-screen instructions.

Using HP Sure Start (select products only)

Select computer models are configured with HP Sure Start, a technology that monitors the computer's BIOS for attacks or corruption. If the BIOS becomes corrupted or is attacked, HP Sure Start automatically restores the BIOS to its previously safe state, without user intervention.

HP Sure Start is configured and already enabled so that most users can use the HP Sure Start default configuration. The default configuration can be customized by advanced users.

To access the latest documentation on HP Sure Start, go to <http://www.hp.com/support>. Select **Find your product**, and then follow the on-screen instructions.

9 Backing up, restoring, and recovering

This chapter provides information about the following processes, which are standard procedure for most products:

- **Backing up your personal information**—You can use Windows tools to back up your personal information (see [Using Windows tools on page 154](#)).
- **Creating a restore point**—You can use Windows tools to create a restore point (see [Using Windows tools on page 154](#)).
- **Creating recovery media** (select products only)—You can use the HP Cloud Recovery Download Tool (select products only) to create recovery media (see [Using the HP Cloud Recovery Download Tool to create recovery media \(select products only\) on page 154](#)).
- **Restoring and recovery**—Windows offers several options for restoring from backup, refreshing the computer, and resetting the computer to its original state (see [Using Windows tools on page 154](#)).

 **IMPORTANT:** If you will be performing recovery procedures on a tablet, the tablet battery must be at least 70% charged before you start the recovery process.

IMPORTANT: For a tablet with a detachable keyboard, connect the tablet to the keyboard base before beginning any recovery process.

Backing up information and creating recovery media

Using Windows tools

 **IMPORTANT:** Windows is the only option that allows you to back up your personal information. Schedule regular backups to avoid information loss.

You can use Windows tools to back up personal information and create system restore points and recovery media.

 **NOTE:** If computer storage is 32 GB or less, Microsoft System Restore is disabled by default.

For more information and steps, see the Get Help app.

1. Select the **Start** button, and then select the **Get Help** app.
2. Enter the task you want to perform.

 **NOTE:** You must be connected to the Internet to access the Get Help app.

Using the HP Cloud Recovery Download Tool to create recovery media (select products only)

You can use the HP Cloud Recovery Download Tool to create HP Recovery media on a bootable USB flash drive.

To download the tool:

- ▲ Go to the Microsoft Store and search for HP Cloud Recovery.

For details, go to <http://www.hp.com/support>, search for HP Cloud Recovery, and then select "HP PCs – Using the Cloud Recovery Tool (Windows 10, 7)."



NOTE: If you cannot create recovery media yourself, contact support to obtain recovery discs. Go to <http://www.hp.com/support>, select your country or region, and then follow the on-screen instructions.

Restoring and recovery

Restoring, resetting, and refreshing using Windows tools

Windows offers several options for restoring, resetting, and refreshing the computer. For details, see [Using Windows tools on page 154](#).

Recovering using HP Recovery media

HP Recovery media is used to recover the original operating system and software programs that were installed at the factory. On select products, it can be created on a bootable USB flash drive using the HP Cloud Recovery Download Tool. For details, see [Using the HP Cloud Recovery Download Tool to create recovery media \(select products only\) on page 154](#).



NOTE: If you cannot create recovery media yourself, contact support to obtain recovery discs. Go to <http://www.hp.com/support>, select your country or region, and then follow the on-screen instructions.

To recover your system:

- ▲ Insert the HP Recovery media, and then restart the computer.

Changing the computer boot order

If your computer does not restart using the HP Recovery media, you can change the computer boot order. This is the order of devices listed in BIOS where the computer looks for startup information. You can change the selection to an optical drive or a USB flash drive, depending on the location of your HP Recovery media.

To change the boot order:



IMPORTANT: For a tablet with a detachable keyboard, connect the tablet to the keyboard base before beginning these steps.

1. Insert the HP Recovery media.
2. Access the system **Startup** menu.

For computers or tablets with keyboards attached:

- ▲ Turn on or restart the computer or tablet, quickly press **esc**, and then press **f9** for boot options.

For tablets without keyboards:

- ▲ Turn on or restart the tablet, quickly hold down the volume up button, and then select **f9**.

– or –

Turn on or restart the tablet, quickly hold down the volume down button, and then select **f9**.

3. Select the optical drive or USB flash drive from which you want to boot, and then follow the on-screen instructions.

Using HP Sure Recover (select products only)

Select computer models are configured with HP Sure Recover, a PC OS recovery solution built into the hardware and firmware. HP Sure Recover can fully restore the HP OS image without installed recovery software.

Using HP Sure Recover, an administrator or user can restore the system and install:

- Latest version of the operating system
- Platform-specific device drivers
- Software applications, in the case of a custom image

To access the latest documentation for HP Sure Recover, go to <http://www.hp.com/support>. Select **Find your product**, and then follow the on-screen instructions.

10 Using HP PC Hardware Diagnostics

Using HP PC Hardware Diagnostics Windows (select products only)

HP PC Hardware Diagnostics Windows is a Windows-based utility that allows you to run diagnostic tests to determine whether the computer hardware is functioning properly. The tool runs within the Windows operating system in order to diagnose hardware failures.

If HP PC Hardware Diagnostics Windows is not installed on your computer, first you must download and install it. To download HP PC Hardware Diagnostics Windows, see [Downloading HP PC Hardware Diagnostics Windows on page 157](#).

After HP PC Hardware Diagnostics Windows is installed, follow these steps to access it from HP Help and Support or HP Support Assistant.

1. To access HP PC Hardware Diagnostics Windows from HP Help and Support:

- a. Select the **Start** button, and then select **HP Help and Support**.
- b. Select **HP PC Hardware Diagnostics Windows**.

– or –

To access HP PC Hardware Diagnostics Windows from HP Support Assistant:

- a. Type `support` in the taskbar search box, and then select the **HP Support Assistant** app.

– or –

Select the question mark icon in the taskbar.

- b. Select **Troubleshooting and fixes**.
- c. Select **Diagnostics**, and then select **HP PC Hardware Diagnostics Windows**.

2. When the tool opens, select the type of diagnostic test that you want to run, and then follow the on-screen instructions.



NOTE: If you need to stop a diagnostic test at any time, select **Cancel**.

When HP PC Hardware Diagnostics Windows detects a failure that requires hardware replacement, a 24-digit Failure ID code is generated. The screen displays one of the following options:

- A Failure ID link is displayed. Select the link and follow the on-screen instructions.
- A Quick Response (QR) code is displayed. With a mobile device, scan the code and then follow the on-screen instructions.
- Instructions for calling support are displayed. Follow those instructions.

Downloading HP PC Hardware Diagnostics Windows

- The HP PC Hardware Diagnostics Windows download instructions are provided in English only.
- You must use a Windows computer to download this tool because only .exe files are provided.

Downloading the latest HP PC Hardware Diagnostics Windows version

To download HP PC Hardware Diagnostics Windows, follow these steps:

1. Go to <http://www.hp.com/go/techcenter/pcdiags>. The HP PC Diagnostics home page is displayed.
2. Select **Download HP Diagnostics Windows**, and then select a location on your computer or a USB flash drive.

The tool is downloaded to the selected location.

Downloading HP Hardware Diagnostics Windows by product name or number (select products only)

 **NOTE:** For some products, you might have to download the software to a USB flash drive by using the product name or number.

To download HP PC Hardware Diagnostics Windows by product name or number, follow these steps:

1. Go to <http://www.hp.com/support>.
2. Select **Get software and drivers**, select your type of product, and then enter the product name or number in the search box that is displayed.
3. In the **Diagnostics** section, select **Download**, and then follow the on-screen instructions to select the specific Windows diagnostics version to be downloaded to your computer or USB flash drive.

The tool is downloaded to the selected location.

Installing HP PC Hardware Diagnostics Windows

To install HP PC Hardware Diagnostics Windows, follow these steps:

- ▲ Navigate to the folder on your computer or the USB flash drive where the .exe file was downloaded, double-click the .exe file, and then follow the on-screen instructions.

Using HP PC Hardware Diagnostics UEFI

 **NOTE:** For Windows 10 S computers, you must use a Windows computer and a USB flash drive to download and create the HP UEFI support environment because only .exe files are provided. For more information, see [Downloading HP PC Hardware Diagnostics UEFI to a USB flash drive on page 159](#).

HP PC Hardware Diagnostics UEFI (Unified Extensible Firmware Interface) allows you to run diagnostic tests to determine whether the computer hardware is functioning properly. The tool runs outside the operating system so that it can isolate hardware failures from issues that are caused by the operating system or other software components.

If your PC does not start in Windows, you can use HP PC Hardware Diagnostics UEFI to diagnose hardware issues.

When HP PC Hardware Diagnostics UEFI detects a failure that requires hardware replacement, a 24-digit Failure ID code is generated. For assistance in solving the problem:

- ▲ Select **Get Support**, and then use a mobile device to scan the QR code that displays on the next screen. The HP Customer Support - Service Center page appears with your Failure ID and product number automatically filled in. Follow the on-screen instructions.

– or –

Contact support, and provide the Failure ID code.

 **NOTE:** To start diagnostics on a convertible computer, your computer must be in notebook mode, and you must use the attached keyboard.

 **NOTE:** If you need to stop a diagnostic test, press [esc](#).

Starting HP PC Hardware Diagnostics UEFI

To start HP PC Hardware Diagnostics UEFI, follow these steps:

1. Turn on or restart the computer, and quickly press [esc](#).
2. Press [f2](#).

The BIOS searches three places for the diagnostic tools, in the following order:

- a. Connected USB flash drive

 **NOTE:** To download the HP PC Hardware Diagnostics UEFI tool to a USB flash drive, see [Downloading the latest HP PC Hardware Diagnostics UEFI version on page 159](#).

- b. Hard drive

- c. BIOS

3. When the diagnostic tool opens, select a language, select the type of diagnostic test you want to run, and then follow the on-screen instructions.

Downloading HP PC Hardware Diagnostics UEFI to a USB flash drive

Downloading HP PC Hardware Diagnostics UEFI to a USB flash drive can be useful in the following situations:

- HP PC Hardware Diagnostics UEFI is not included in the preinstallation image.
- HP PC Hardware Diagnostics UEFI is not included in the HP Tool partition.
- The hard drive is damaged.

 **NOTE:** The HP PC Hardware Diagnostics UEFI download instructions are provided in English only, and you must use a Windows computer to download and create the HP UEFI support environment because only .exe files are provided.

Downloading the latest HP PC Hardware Diagnostics UEFI version

To download the latest HP PC Hardware Diagnostics UEFI version to a USB flash drive:

1. Go to <http://www.hp.com/go/techcenter/pcdiags>. The HP PC Diagnostics home page is displayed.
2. Select **Download HP Diagnostics UEFI**, and then select **Run**.

Downloading HP PC Hardware Diagnostics UEFI by product name or number (select products only)

 **NOTE:** For some products, you might have to download the software to a USB flash drive by using the product name or number.

To download HP PC Hardware Diagnostics UEFI by product name or number (select products only) to a USB flash drive:

1. Go to <http://www.hp.com/support>.
2. Enter the product name or number, select your computer, and then select your operating system.
3. In the **Diagnostics** section, follow the on-screen instructions to select and download the specific UEFI Diagnostics version for your computer.

Using Remote HP PC Hardware Diagnostics UEFI settings (select products only)

Remote HP PC Hardware Diagnostics UEFI is a firmware (BIOS) feature that downloads HP PC Hardware Diagnostics UEFI to your computer. It can then execute the diagnostics on your computer, and it might upload results to a preconfigured server. For more information about Remote HP PC Hardware Diagnostics UEFI, go to <http://www.hp.com/go/techcenter/pcdiags>, and then select **Find out more**.

Downloading Remote HP PC Hardware Diagnostics UEFI



NOTE: HP Remote PC Hardware Diagnostics UEFI is also available as a Softpaq that can be downloaded to a server.

Downloading the latest Remote HP PC Hardware Diagnostics UEFI version

To download the latest Remote HP PC Hardware Diagnostics UEFI version, follow these steps:

1. Go to <http://www.hp.com/go/techcenter/pcdiags>. The HP PC Diagnostics home page is displayed.
2. Select **Download Remote Diagnostics**, and then select **Run**.

Downloading Remote HP PC Hardware Diagnostics UEFI by product name or number



NOTE: For some products, it may be necessary to download the software by using the product name or number.

To download HP Remote PC Hardware Diagnostics UEFI by product name or number, follow these steps:

1. Go to <http://www.hp.com/support>.
2. Select **Get software and drivers**, select your type of product, enter the product name or number in the search box that is displayed, select your computer, and then select your operating system.
3. In the **Diagnostics** section, follow the on-screen instructions to select and download the **Remote UEFI** version for the product.

Customizing Remote HP PC Hardware Diagnostics UEFI settings

Using the Remote HP PC Hardware Diagnostics setting in Computer Setup (BIOS), you can perform the following customizations:

- Set a schedule for running diagnostics unattended. You can also start diagnostics immediately in interactive mode by selecting **Execute Remote HP PC Hardware Diagnostics**.
- Set the location for downloading the diagnostic tools. This feature provides access to the tools from the HP website or from a server that has been preconfigured for use. Your computer does not require the traditional local storage (such as a disk drive or USB flash drive) to run remote diagnostics.

- Set a location for storing the test results. You can also set the user name and password settings used for uploads.
- Display status information about the diagnostics run previously.

To customize Remote HP PC Hardware Diagnostics UEFI settings, follow these steps:

1. Turn on or restart the computer, and when the HP logo appears, press **f10** to enter Computer Setup.
2. Select **Advanced**, and then select **Settings**.
3. Make your customization selections.
4. Select **Main**, and then **Save Changes and Exit** to save your settings.

Your changes take effect when the computer restarts.

11 Specifications

Computer specifications

	Metric	U.S.
Dimensions		
Width	376 mm	14.8 in
Depth	264 mm	10.4 in
Height (front to back)	26 mm	1.03 in
Weight	2.63 or 2.85 kg (depending on configuration)	5.79 lb or 6.28 lb (depending on configuration)
Input power		
Operating voltage and current	19.5 V dc @ 7.70 A – 150 W	
Temperature		
Operating	5°C to 35°C	41°F to 95°F
Nonoperating	-20°C to 60°C	-4°F to 140°F
Relative humidity (noncondensing)		
Operating	10% to 90%	
Nonoperating	5% to 95%	
Maximum altitude (unpressurized)		
Operating	-15 m to 3,048 m	-50 ft to 10,000 ft
Nonoperating	-15 m to 12,192 m	-50 ft to 40,000 ft
NOTE: Applicable product safety standards specify thermal limits for plastic surfaces. The device operates well within this range of temperatures.		

39.6 cm (15.6 in) display specifications

	Metric	U.S.
Active diagonal size	39.6 cm	15.6 in
Resolution	FHD: 1920 × 1080 UHD: 3840 × 2160	
Surface treatment	Antiglare (except touch screen)	
Brightness	FHD (60% sRGB): 250 nits FHD (72% sRGB): 400 nits UHD (100% DCI P3): 600 nits	

	Metric	U.S.
	FHD (72% sRGB, privacy): 1000 nits	
	UHD: (72% sRGB): 400 nits	
Viewing angle	UWVA	
Backlight	LED	
Aspect ratio	16:9	
Display panel interface	eDP	

12 Power cord set requirements

The wide-range input feature of the computer permits it to operate from any line voltage from 100 to 120 V ac, or from 220 to 240 V ac.

The 3-conductor power cord set included with the computer meets the requirements for use in the country or region where the equipment is purchased.

Power cord sets for use in other countries or regions must meet the requirements of the country and region where the computer is used.

Requirements for all countries

The following requirements are applicable to all countries and regions:

- The length of the power cord set must be at least **1.0 m** (3.3 ft) and no more than **2.0 m** (6.5 ft).
- All power cord sets must be approved by an acceptable accredited agency responsible for evaluation in the country or region where the power cord set will be used.
- The power cord sets must have a minimum current capacity of 10 A and a nominal voltage rating of 125 or 250 V ac, as required by the power system of each country or region.
- The appliance coupler must meet the mechanical configuration of an EN 60 320/IEC 320 Standard Sheet C13 connector for mating with the appliance inlet on the back of the computer.

Requirements for specific countries and regions

Table 12-1 Power cord requirements for specific countries and regions

Country/region	Accredited agency	Applicable note number
Argentina	IRAM	1
Australia	SAA	1
Austria	OVE	1
Belgium	CEBEC	1
Brazil	ABNT	1
Canada	CSA	2
Chile	IMQ	1
Denmark	DEMKO	1
Finland	FIMKO	1
France	UTE	1
Germany	VDE	1
India	BIS	1
Israel	SII	1
Italy	IMQ	1
Japan	JIS	3
The Netherlands	KEMA	1
New Zealand	SANZ	1
Norway	NEMKO	1
The People's Republic of China	CCC	4
Saudi Arabia	SASO	7
Singapore	PSB	1
South Africa	SABS	1
South Korea	KTL	5
Sweden	SEMKO	1
Switzerland	SEV	1
Taiwan	BSMI	6
Thailand	TISI	1
The United Kingdom	ASTA	1
The United States	UL	2

1. The flexible cord must be Type H05VV-F, 3-conductor, 0.75 mm² conductor size. Power cord set fittings (appliance coupler and wall plug) must bear the certification mark of the agency responsible for evaluation in the country or region where it will be used.

Table 12-1 Power cord requirements for specific countries and regions (continued)

Country/region	Accredited agency	Applicable note number
		2. The flexible cord must be Type SVT/SJT or equivalent, No. 18 AWG, 3-conductor. The wall plug must be a two-pole grounding type with a NEMA 5-15P (15 A, 125 V ac) or NEMA 6-15P (15 A, 250 V ac) configuration. CSA or C-UL mark. UL file number must be on each element.
		3. The appliance coupler, flexible cord, and wall plug must bear a “T” mark and registration number in accordance with the Japanese Dentori Law. The flexible cord must be Type VCTF, 3-conductor, 0.75 mm ² or 1.25 mm ² conductor size. The wall plug must be a two-pole grounding type with a Japanese Industrial Standard C8303 (7 A, 125 V ac) configuration.
		4. The flexible cord must be Type RVV, 3-conductor, 0.75 mm ² conductor size. Power cord set fittings (appliance coupler and wall plug) must bear the CCC certification mark.
		5. The flexible cord must be Type H05VV-F 3-conductor, 0.75 mm ² conductor size. KTL logo and individual approval number must be on each element. Approval number and logo must be printed on a flag label.
		6. The flexible cord must be Type HVCTF 3-conductor, 1.25 mm ² conductor size. Power cord set fittings (appliance coupler, cable, and wall plug) must bear the BSMI certification mark.
		7. For 127 V ac, the flexible cord must be Type SVT or SJT 3-conductor, 18 AWG, with plug NEMA 5-15P (15 A, 125 V ac), with UL and CSA or C-UL marks. For 240 V ac, the flexible cord must be Type H05VV-F 3-conductor, 0.75 mm ² or 1.00 mm ² conductor size, with plug BS 1363/A with BSI or ASTA marks.

13 Statement of memory volatility

The purpose of this chapter is to provide general information regarding nonvolatile memory in HP Business computers. This chapter also provides general instructions for restoring nonvolatile memory that can contain personal data after the system has been powered off and the hard drive has been removed.

HP Business computer products that use Intel®-based or AMD®-based system boards contain volatile DDR memory. The amount of nonvolatile memory present in the system depends upon the system configuration. Intel-based and AMD-based system boards contain nonvolatile memory subcomponents as originally shipped from HP, assuming that no subsequent modifications have been made to the system and assuming that no applications, features, or functionality have been added to or installed on the system.

Following system shutdown and removal of all power sources from an HP Business computer system, personal data can remain on volatile system memory (DIMMs) for a finite period of time and will also remain in nonvolatile memory. Use the steps below to remove personal data from the computer, including the nonvolatile memory found in Intel-based and AMD-based system boards.

 **NOTE:** If your tablet has a keyboard base, connect to the keyboard base before beginning steps in this chapter.

Current BIOS steps

1. Follow steps (a) through (l) below to restore the nonvolatile memory that can contain personal data. Restoring or reprogramming nonvolatile memory that does not store personal data is neither necessary nor recommended.

- a. Turn on or restart the computer, and then press **esc** while the "Press the ESC key for Startup Menu" message is displayed at the bottom of the screen.

 **NOTE:** If the system has a BIOS administrator password, enter the password at the prompt.

- b. Select **Main**, select **Apply Factory Defaults and Exit**, and then select **Yes** to load defaults.

The computer reboots.

- c. During the reboot, press **esc** while the "Press the ESC key for Startup Menu" message is displayed at the bottom of the screen.

 **NOTE:** If the system has a BIOS administrator password, enter the password at the prompt.

- d. Select the **Security** menu, select **Restore Security Settings to Factory Defaults**, and then select **Yes** to restore security level defaults.

The computer reboots.

- e. During the reboot, press **esc** while the "Press the ESC key for Startup Menu" message is displayed at the bottom of the screen.

 **NOTE:** If the system has a BIOS administrator password, enter the password at the prompt.

- f. If an asset or ownership tag is set, select the **Security** menu and scroll down to the **Utilities** menu. Select **System IDs**, and then select **Asset Tracking Number**. Clear the tag, and then make the selection to return to the prior menu.

- g.** If a DriveLock password is set, select the **Security** menu, and scroll down to **Hard Drive Utilities** under the **Utilities** menu. Select **Hard Drive Utilities**, select **DriveLock**, then clear the check box for **DriveLock password on restart**. Select **OK** to proceed.
- h.** Select the **Main** menu, and then select **Reset BIOS Security to factory default**. Click **Yes** at the warning message.
The computer reboots.
- i.** During the reboot, press **esc** while the “Press the ESC key for Startup Menu” message is displayed at the bottom of the screen.



NOTE: If the system has a BIOS administrator password, enter the password at the prompt.

- j.** Select the **Main** menu, select **Apply Factory Defaults and Exit**, select **Yes** to save changes and exit, and then select **Shutdown**.
 - k.** Reboot the system. If the system has a Trusted Platform Module (TPM), fingerprint reader, or both, one or two prompts will appear—one to clear the TPM and the other to Reset Fingerprint Sensor. Press or tap **f1** to accept or **f2** to reject.
 - l.** Remove all power and system batteries for at least 24 hours.
- 2.** Complete one of the following:
- Remove and retain the storage drive.
 - or –
 - Clear the drive contents by using a third-party utility designed to erase data from an SSD.
 - or –
 - Clear the contents of the drive by using the following BIOS Setup Secure Erase command option steps:



IMPORTANT: If you clear data using Secure Erase, it cannot be recovered.

- a.** Turn on or restart the computer, and then press **esc** while the “Press the ESC key for Startup Menu” message is displayed at the bottom of the screen.
 - b.** Select the **Security** menu and scroll down to the **Utilities** menu.
 - c.** Select **Hard Drive Utilities**.
 - d.** Under **Utilities**, select **Secure Erase**, select the hard drive storing the data you want to clear, and then follow the on-screen instructions to continue.
- or –
- Clear the contents of the drive using the following Disk Sanitizer commands steps:



IMPORTANT: If you clear data using Disk Sanitizer, it cannot be recovered.



NOTE: The amount of time it takes for Disk Sanitizer to run can take several hours. Plug the computer into an AC outlet before starting.

- a.** Turn on or restart the computer, and then press **esc** while the “Press the ESC key for Startup Menu” message is displayed at the bottom of the screen.
- b.** Select the **Security** menu and scroll down to the **Utilities** menu.

- c. Select **Hard Drive Utilities**.
- d. Under **Utilities**, select **Disk Sanitizer**, select the hard drive storing the data you want to clear, and then follow the on-screen instructions to continue.

Nonvolatile memory usage

Table 13-1 Troubleshooting steps for nonvolatile memory usage

Nonvolatile memory type	Amount (Size)	Does this memory store customer data?	Does this memory retain data when power is removed?	What is the purpose of this memory?	How is data entered into this memory?	How is this memory write-protected?
HP Sure Start flash (select models only)	8 MB	No	Yes	Provides protected backup of critical System BIOS code, EC firmware, and critical computer configuration data for select platforms that support HP Sure Start. For more information, see Using HP Sure Start (select models only) on page 172.	Data cannot be written to this device via the host processor. The content is managed solely by the HP Sure Start Embedded Controller.	This memory is protected by the HP Sure Start Embedded Controller.
Real Time Clock (RTC) battery backed-up CMOS configuration memory	256 bytes	No	Yes	Stores system date and time and noncritical data.	RTC battery backed-up CMOS is programmed using Computer Setup (BIOS), or by changing the Microsoft® Windows date & time.	This memory is not write-protected.
Controller (NIC) EEPROM	64 KB (not customer accessible)	No	Yes	Stores NIC configuration and NIC firmware.	NIC EEPROM is programmed using a utility from the NIC vendor that can be run from DOS.	A utility must be used to write data to this memory and is available from the NIC vendor. Writing data to this ROM in an inappropriate manner will render the NIC non-functional.
DIMM Serial Presence Detect (SPD) configuration data	256 bytes per memory module, 128 bytes programmable (not customer accessible)	No	Yes	Stores memory module information.	DIMM SPD is programmed by the memory vendor.	Data cannot be written to this memory when the module is installed in a computer. The specific write-protection method varies by memory vendor.

Table 13-1 Troubleshooting steps for nonvolatile memory usage (continued)

Nonvolatile memory type	Amount (Size)	Does this memory store customer data?	Does this memory retain data when power is removed?	What is the purpose of this memory?	How is data entered into this memory?	How is this memory write-protected?
System BIOS	9 MB	Yes	Yes	Stores system BIOS code and computer configuration data.	System BIOS code is programmed at the factory. Code is updated when the system BIOS is updated. Configuration data and settings are entered using the Computer Setup (BIOS) or a custom utility.	NOTE: Writing data to this ROM in an inappropriate manner can render the computer non-functional. A utility must be used for writing data to this memory and is available on the HP website; go to http://www.hp.com/support . Select Find your product , and then follow the on-screen instructions.
Intel Management Engine Firmware (present only in select Elite or Z models. For more information, go to http://www.hp.com/support . Select Find your product , and then follow the on-screen instructions.)	1.5 MB or 7 MB	Yes	Yes	Stores Management Engine Code, Settings, Provisioning Data and iAMT third-party data store.	Management Engine Code is programmed at the factory. Code is updated via Intel secure firmware update utility. Unique Provisioning Data can be entered at the factory or by an administrator using the Management Engine (MEBx) setup utility. The third-party data store contents can be populated by a remote management console or local applications that have been registered by an administrator to have access to the space.	The Intel chipset is configured to enforce hardware protection to block all direct read/write access to this area. An Intel utility must be used for updating the firmware. Only firmware updates digitally signed by Intel can be applied using this utility.
Bluetooth flash (select products only)	2 Mb	No	Yes	Stores Bluetooth configuration and firmware.	Bluetooth flash is programmed at the factory. Tools for writing data to this memory are not publicly available but can be obtained from the silicon vendor.	A utility must be used for writing data to this memory and is made available through newer versions of the driver whenever the flash requires an upgrade.
802.11 WLAN EEPROM	4 Kb to 8 Kb	No	Yes	Stores configuration and calibration data.	802.11 WLAN EEPROM is programmed at the factory. Tools for writing data to this memory are not made public.	A utility must be used for writing data to this memory and is typically not made available to the public unless a firmware upgrade is necessary to address a unique issue.
Webcam (select products only)	64 Kb	No	Yes	Stores webcam configuration and firmware.	Webcam memory is programmed using a utility from the device manufacturer that can be run from Windows.	A utility must be used for writing data to this memory and is typically not made available to the public unless a firmware

Table 13-1 Troubleshooting steps for nonvolatile memory usage (continued)

Nonvolatile memory type	Amount (Size)	Does this memory store customer data?	Does this memory retain data when power is removed?	What is the purpose of this memory?	How is data entered into this memory?	How is this memory write-protected?
Fingerprint reader (select products only)	512 KB flash	Yes	Yes	Stores fingerprint templates.	Fingerprint reader memory is programmed by user enrollment in HP ProtectTools Security Manager.	upgrade is necessary to address a unique issue. Only a digitally signed application can make the call to write to the flash.

Questions and answers

1. How can the BIOS settings be restored (returned to factory settings)?

 **IMPORTANT:** Restore defaults does not securely erase any data on your hard drive. See question and answer 6 for steps to securely erase data.

Restore defaults does not reset the Custom Secure Boot keys. See question and answer 7 for information about resetting the keys.

- a. Turn on or restart the computer, and then press **esc** while the "Press the ESC key for Startup Menu" message is displayed at the bottom of the screen.
- b. Select **Main**, and then select **Apply Factory Defaults and Exit**.
- c. Follow the on-screen instructions.
- d. Select **Main**, select **Save Changes and Exit**, and then follow the on-screen instructions.

2. What is a UEFI BIOS, and how is it different from a legacy BIOS?

The Unified Extensible Firmware Interface (UEFI) BIOS is an industry-standard software interface between the platform firmware and an operating system (OS). It is a replacement for the older BIOS architecture, but supports much of the legacy BIOS functionality.

Like the legacy BIOS, the UEFI BIOS provides an interface to display the system information and configuration settings and to change the configuration of your computer before an OS is loaded. BIOS provides a secure run-time environment that supports a Graphic User Interface (GUI). In this environment, you can use either a pointing device (touch screen, touchpad, pointing stick, or USB mouse) or the keyboard to navigate and make menu and configuration selections. The UEFI BIOS also contains basic system diagnostics.

The UEFI BIOS provides functionality beyond that of the legacy BIOS. In addition, the UEFI BIOS works to initialize the computer's hardware before loading and executing the OS; the run-time environment allows the loading and execution of software programs from storage devices to provide more functionality, such as advanced hardware diagnostics (with the ability to display more detailed system information) and advanced firmware management and recovery software.

HP has provided options in Computer Setup (BIOS) to allow you to run in legacy BIOS, if required by the operating system. Examples of this requirement would be if you upgrade or downgrade the OS.

3. Where does the UEFI BIOS reside?

The UEFI BIOS resides on a flash memory chip. A utility must be used to write to the chip.

4. What kind of configuration data is stored on the DIMM Serial Presence Detect (SPD) memory module? How would this data be written?

The DIMM SPD memory contains information about the memory module, such as size, serial number, data width, speed/timing, voltage, and thermal information. This information is written by the module manufacturer and stored on an EEPROM. This EEPROM cannot be written to when the memory module is installed in a computer. Third-party tools do exist that can write to the EEPROM when the memory module is not installed in a computer. Various third-party tools are available to read SPD memory.

5. What is meant by “Restore the nonvolatile memory found in Intel-based system boards”?

This message relates to clearing the Real Time Clock (RTC) CMOS memory that contains computer configuration data.

6. How can the BIOS security be reset to factory defaults and data erased?

 **IMPORTANT:** Resetting will result in the loss of information.

These steps will not reset Custom Secure Boot Keys. See question and answer 7 for information about resetting the keys.

- a. Turn on or restart the computer, and then press **esc** while the "Press the ESC key for Startup Menu" message is displayed at the bottom of the screen.
- b. Select **Main**, and then select **Reset Security to Factory Defaults**.
- c. Follow the on-screen instructions.
- d. Select **Main**, select **Save Changes and Exit**, and then follow the on-screen instructions.

7. How can the Custom Secure Boot Keys be reset?

Secure Boot is a feature to ensure that only authenticated code can start on a platform. If you enabled Secure Boot and created Custom Secure Boot Keys, simply disabling Secure Boot will not clear the keys. You must also select to clear the Custom Secure Boot Keys. Use the same Secure Boot access procedure you used to create the Custom Secure Boot Keys, but make the selection to clear or delete all Secure Boot Keys.

- a. Turn on or restart the computer, and then press **esc** while the "Press the ESC key for Startup Menu" message is displayed at the bottom of the screen.
- b. Select the **Security** menu, select **Secure Boot Configuration**, and then follow the on-screen instructions.
- c. At the **Secure Boot Configuration** window, select **Secure Boot**, select **Clear Secure Boot Keys**, and then follow the on-screen instructions to continue.

Using HP Sure Start (select models only)

Select computer models are configured with HP Sure Start, a technology that continuously monitors your computer's BIOS for attacks or corruption. If the BIOS becomes corrupted or is attacked, HP Sure Start restores the BIOS to its previously safe state, without user intervention. Those select computer models ship with HP Sure Start configured and enabled. HP Sure Start is configured and already enabled so that most users can use the HP Sure Start default configuration. The default configuration can be customized by advanced users.

To access the latest documentation on HP Sure Start, go to <http://www.hp.com/support>. Select **Find your product**, and then follow the on-screen instructions.

14 Recycling

When a non-rechargeable or rechargeable battery has reached the end of its useful life, do not dispose of the battery in general household waste. Follow the local laws and regulations in your area for battery disposal.

HP encourages customers to recycle used electronic hardware, HP original print cartridges, and rechargeable batteries. For more information about recycling programs, see the HP Web site at <http://www.hp.com/recycle>.

Index

- A**
 - AC adapter, spare part numbers 27
 - ambient light sensor board
 - removal 75
 - spare part number 23, 75
 - ambient light sensor cable
 - spare part number 23
 - audio, product description 3
 - audio-out (headphone)/audio-in (microphone) combo jack, identifying 7
 - B**
 - back cover
 - spare part number 23
 - backup, creating 154
 - backups 154
 - battery
 - removal 35
 - spare part numbers 21, 35
 - battery light 8
 - BIOS
 - determining version 151
 - downloading an update 151
 - updating 151
 - Bluetooth label 18
 - boot order
 - changing using the f9 prompt 152
 - boot order, changing 155
 - bottom 18
 - bottom cover
 - removal 46
 - spare part number 46
 - Bracket Kit
 - components 24
 - spare part number 24
 - buttons
 - center pointing stick 11
 - left Touchpad 11
 - power 14
 - right Touchpad 12
 - C**
 - Cable Kit
 - components 25
 - spare part number 25
 - call answer light 13
 - call end light 13
 - camera 10
 - camera light, identifying 10
 - camera module
 - removal 73
 - camera privacy cover, identifying 10
 - camera(s)
 - identifying 10
 - camera/microphone module
 - removal 74
 - caps lock light, identifying 13
 - cautions
 - electrostatic discharge 29
 - Center Touchpad button, identifying 11
 - color board
 - removal 75
 - spare part number 23, 75
 - components
 - bottom 17
 - display 10
 - keyboard area 11
 - left side 9
 - right side 7
 - components, cover 16
 - computer
 - major components 19
 - Computer Setup
 - navigating and selecting 150
 - restoring factory settings 150
 - starting 150
 - computer setup 150
 - computer specifications 162
 - connector, power 7, 8
 - D**
 - DDR cage shielding
 - illustrated 24
 - display assembly
 - removal 69
 - spare part numbers 20, 69
 - display bezel
 - removal 69
 - spare part numbers 22, 70
 - display cable
 - spare part number 76
 - display components 10
 - display panel
 - product description 2
 - removal 70
 - spare part numbers 22
 - display specifications 162
 - display/camera cable
 - removal 76
 - spare part number 23
 - display/IR camera cable
 - spare part number 23
 - docking
 - product description 4
 - door latch
 - removal 48
 - spare part numbers 48
 - DreamColor sensor, identifying 12
- E**
 - EDP bracket
 - illustrated 24
 - electrostatic discharge (ESD) 29
 - preventing damage 30
 - esc key, identifying 15
 - Ethernet, product description 3
- F**
 - fan
 - removal 53
 - spare part numbers 21, 53
 - finger print reader board
 - spare part numbers 20
 - fingerprnt reader blank, illustrated 25
 - fingerprnt reader board
 - removal 67
 - spare part number 67

- fingerprint reader board bracket
 - removal 67
- fingerprint reader bracket
 - illustrated 24
- fingerprint reader cable
 - illustrated 25
- fingerprint reader, identifying 14
- fn key, identifying 15
- fn lock light, identifying 13

G

- graphics, product description 1
- grounding methods 31
- guidelines
 - packaging 32
 - transporting 32
 - workstation 29

H

- hard drive
 - removal 37
 - spare part numbers 27, 37
- hard drive bracket
 - illustrated 24
 - removal 37
- HD camera
 - spare part number 23
- HD camera module
 - spare part number 74
- HDMI port, identifying 7
- heat sink assembly
 - removal 56
 - spare part numbers 56
- hinge
 - removal 69, 75
 - spare part number 23, 75
- hot keys
 - break 16
 - insert 16
 - pause 16
 - programming query 16
 - scroll lock 16
 - using 16
- HP PC Hardware Diagnostics UEFI
 - downloading 159
 - starting 159
 - using 158
- HP PC Hardware Diagnostics Windows
 - downloading 157

- installing 158
 - using 157
- HP Recovery media
 - recovery 155
- HP Sure Recover 156
- HP Sure Start 172

I

- integrated numeric keypad, identifying 15
- internal microphones, identifying 10
- IR camera
 - spare part number 23
- IR camera module
 - spare part number 74

J

- jacks
 - audio-out (headphone)/audio-in (microphone) combo 7
 - network 9
 - RJ-45 (network) 9

K

- keyboard
 - product description 5
 - removal 43
 - spare part numbers 20, 43
- keypad
 - integrated numeric 15
- keys
 - esc 15
 - fn 15
 - num lock 15
 - Windows 15

L

- labels
 - Bluetooth 18
 - regulatory 18
 - serial number 18
 - service 18
 - wireless certification 18
 - WLAN 18
- left side components 9
- lights
 - AC adapter and battery 8
 - battery 8
 - call answer 13
 - call end 13

- camera 10
- caps lock 13
- fn lock 13
- microphone mute 13
- num lock 13
- power 13
- RJ-45 (network) 9
- sharing or presenting 13
- wireless 13

M

- mass storage device
 - illustrated 26
 - spare part numbers 26
- media card reader
 - product description 4
- memory
 - nonvolatile 167
 - product description 2
 - volatile 167
- memory card reader, identifying 9
- memory module
 - removal 41, 64
 - spare part numbers 20, 41, 64
- microphone
 - product description 3
- microphone mute light, identifying 13
- model name 1

N

- network jack, identifying 9
- NFC cable
 - illustrated 25
- NFC module
 - removal 52
 - spare part number 52
- NFC tapping area, identifying 12
- nonvolatile memory 167
- num lock light 13

O

- operating system, product description 5

P

- packaging guidelines 32
- Plastics Kit
 - components 25
 - spare part number 25
- Plastics Kit, spare part number 33

- pointing device, product description 5
- pointing stick, identifying 11
- ports
 - HDMI 7
 - product description 4
 - USB SuperSpeed 7, 9
 - USB SuperSpeed port with HP Sleep and Charge 9
 - USB Type-C power connector and Thunderbolt ports with HP Sleep and Charge 7
- power button board
 - removal 68
- power button, identifying 14
- power connector
 - identifying 8
 - identifying USB Type-C 7
- power cord
 - requirements for all countries 164
 - requirements for specific countries and regions 165
 - set requirements 164
- power lights 13
- power requirements, product description 5
- primary SATA storage
 - product description 3
- primary storage
 - product description 2
- privacy cover, camera 10
- processors, product description 1
- product description
 - audio 3
 - display panel 2
 - docking 4
 - Ethernet 3
 - flash cache 3
 - graphics 1
 - keyboard 5
 - media card reader 4
 - memory 2
 - microphone 3
 - operating system 5
 - pointing device 5
 - ports 4
 - power requirements 5
 - primary SATA storage 3
 - primary storage 2
 - processors 1
 - product name 1
 - RAID 3
 - secondary storage 3
 - security 5
 - serviceability 6
 - video 3
 - wireless networking 3
- product name 1
- product name and number, computer 18
- R**
- RAID
 - product description 3
- recovery 154
 - discs 155
 - HP Recovery partition 155
 - media 155
 - USB flash drive 155
- recovery media
 - creating using HP Cloud Recovery Download Tool 154
 - creating using Windows tools 154
- regulatory information
 - regulatory label 18
 - wireless certification labels 18
- Remote HP PC Hardware Diagnostics
 - UEFI settings
 - customizing 160
 - using 160
- removal/replacement
 - procedures 33, 43
- removing personal data from volatile system memory 167
- restoring 154
- right side components 7
- RJ-45 (network) jack, identifying 9
- RJ-45 (network) lights, identifying 9
- RTC battery
 - removal 62
 - spare part number 20, 62
- S**
- Screw Kit, spare part number 27
- SD card blank, illustrated 25
- secondary storage
 - product description 3
- security cable slot, identifying 9
- security, product description 5
- serial number, computer 18
- service cover
 - removal 33
- service door
 - spare part number 21, 33
- service door latch
 - removal 48
 - spare part number 48
 - spare part numbers 48
- service labels, locating 18
- serviceability, product description 6
- setup utility
 - navigating and selecting 150
 - restoring factory settings 150
- sharing or presenting light, identifying 13
- shortcut keys, using 15
- slots
 - security cable 9
 - smart card 7
- smart card reader
 - removal 51
 - spare part number 20, 51
- smart card slot, identifying 7
- solid-state drive
 - removal 36
 - spare part numbers 26, 36
- speakers
 - removal 66
 - spare part number 20, 66
- speakers, identifying 14
- specifications
 - computer 162
 - display 162
- static electricity 30
- Sure Start
 - using 153
- system board
 - removal 59
 - spare part numbers 20, 59
- system memory, removing personal data from volatile 167
- system restore point, creating 154
- T**
- Thunderbolt ports with HP Sleep and Charge
 - identifying USB Type-C 7

- top cover
 - spare part number 20
- Touchpad
 - buttons 11
- Touchpad buttons
 - identifying 11, 12
- touchpad cable
 - illustrated 25
- Touchpad module
 - spare part number 20
- touchpad module
 - removal 49
 - spare part number 49
- Touchpad zone, identifying 11
- TPM settings 152
- transporting guidelines 32
- traveling with the computer 18

- WWAN antenna
 - spare part number 23
- WWAN antennas, identifying 10
- WWAN module
 - removal 39
 - spare part numbers 21, 39

U

- USB SuperSpeed port with HP Sleep and Charge, identifying 9
- USB SuperSpeed port, identifying 7, 9
- USB Type-C power connector and Thunderbolt ports with HP Sleep and Charge, identifying 7
- USB-C bracket
 - illustrated 24

V

- vent, identifying 17
- video, product description 3

W

- Windows
 - backup 154
 - recovery media 154
 - system restore point 154
- Windows key, identifying 15
- Windows tools, using 154
- wireless antennas, identifying 10
- wireless certification label 18
- wireless light, identifying 13
- wireless networking
 - product description 3
- WLAN antenna
 - spare part number 23
- WLAN antennas, identifying 10
- WLAN device 18
- WLAN label 18
- workstation guidelines 29