



Color LaserJet Pro MFP M182-M185



www.hp.com/support/ljM182MFP



www.register.hp.com



7KW54-90916

© Copyright 2019 HP Development Company, L.P.
www.hp.com

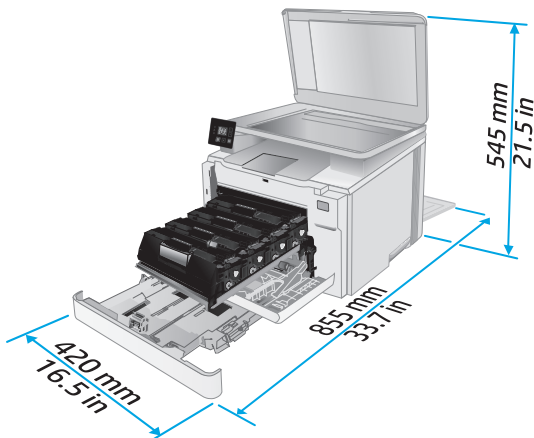
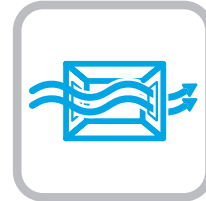
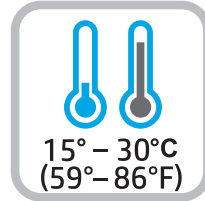
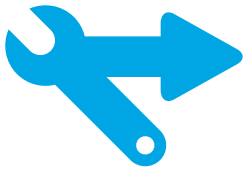
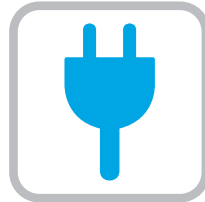

M182n
M182nw

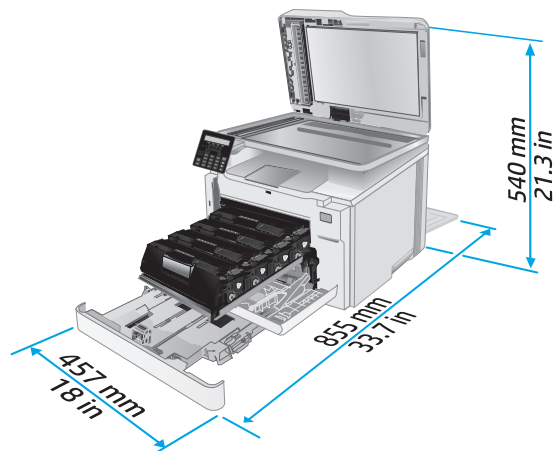

M183fw

1

1.1

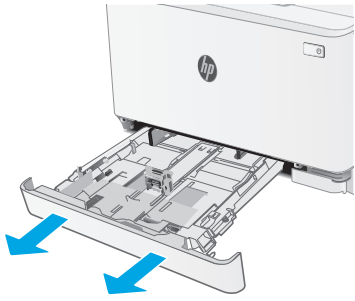

1.2

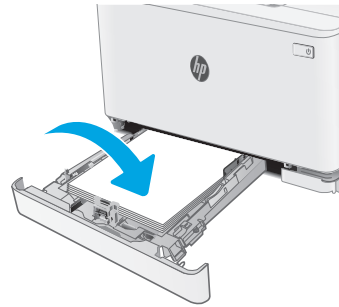

1.3

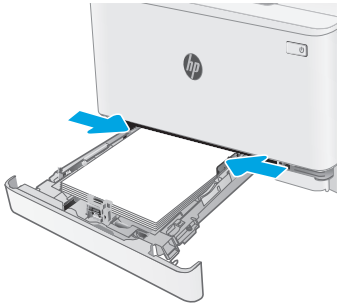

1.4

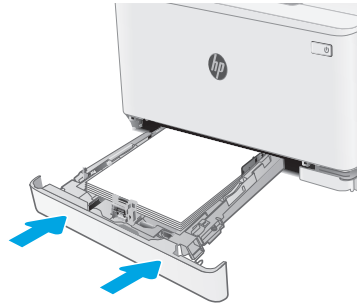

2

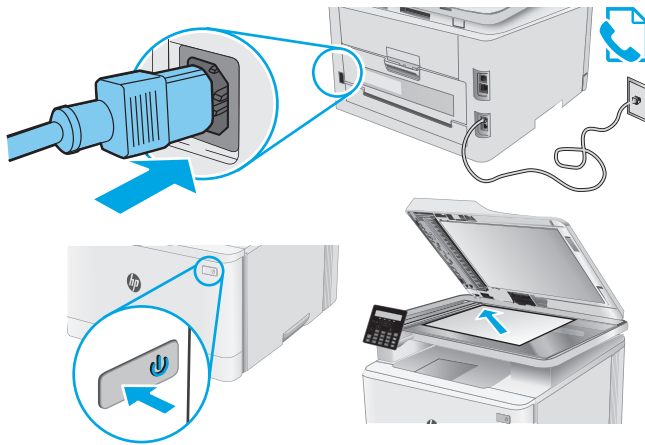

3



123.hp.com





Color LaserJet Pro MFP M182-M185

参考指南

Reference Guide

简体中文..... 4

English..... 7

ZHCN	LED 指示灯控制面板视图.....	4
	2 行 LCD 控制面板视图.....	4
	控制面板指示灯图案.....	5
	控制面板错误消息.....	5
	下载和安装软件.....	5
	移动打印.....	6
	使用扫描功能.....	6
	故障排除.....	6

EN	LED control panel view.....	7
	2-line LCD control panel view.....	7
	Control panel light patterns.....	8
	Control panel error message.....	8
	Download and install the software.....	8
	Mobile printing.....	9
	Use the scan feature.....	9
	Troubleshooting.....	9

需要帮助吗？ - 常见问题解答

有关常见问题解答，请访问
www.hp.com/support/ljM182MFPAQ
 或扫描二维码。



LED 指示灯控制面板视图

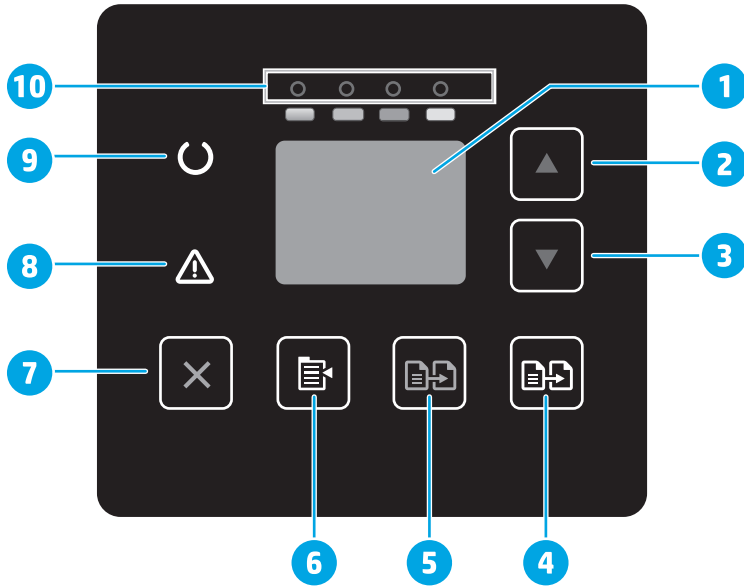



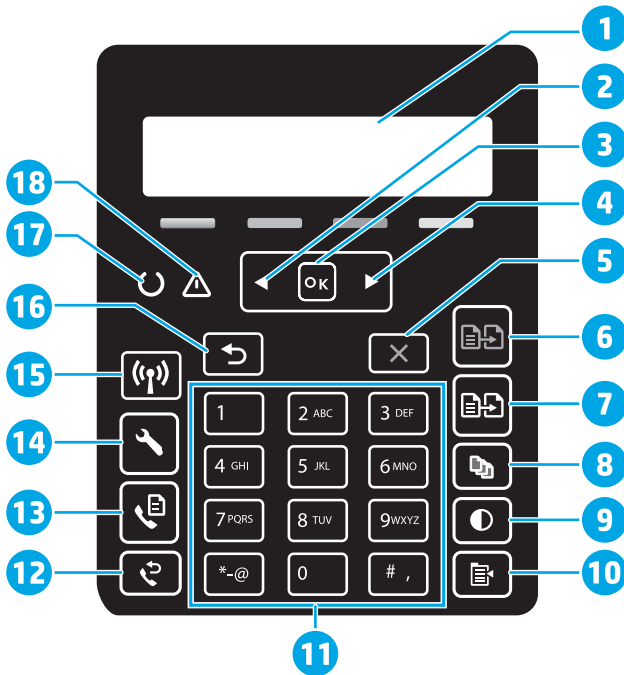

1	控制面板 LED 显示屏
2	向上箭头 ▲ 按钮
3	向下箭头 ▼ 按钮
4	“开始彩色复印” / “确定” 按钮
5	“开始单色复印” 按钮
6	“复印设置” 按钮
7	“取消” × 按钮
8	“注意” △ LED 指示灯
9	“就绪” ○ LED 指示灯
10	耗材 LED 指示灯

2 行 LCD 控制面板视图



1	2 行控制面板显示屏	10	“复印” 菜单 按钮
2	左箭头 ◀ 按钮	11	字母数字小键盘
3	OK 按钮	12	“重拨传真” 按钮 (仅限传真型号)
4	右箭头 ▶ 按钮	13	“开始传真” 按钮 (仅限传真型号)
5	“取消” × 按钮	14	“设置” 按钮
6	“开始单色复印” 按钮	15	“无线” 按钮 (仅限无线型号)
7	“开始彩色复印” 按钮	16	后退箭头 ↶ 按钮
8	“份数” 按钮	17	“就绪” ○ LED 指示灯
9	“更浅/更深” 按钮	18	“注意” △ LED 指示灯

控制面板指示灯图案

指示灯	说明	解决方案
	就绪	无需执行操作。
	碳粉盒达到使用寿命	当发生耗材错误时，“耗材”指示灯闪烁，当耗材量严重不足时，它点亮但不闪烁。
	严重错误	关闭再打开电源。如果仍有错误，请致电 HP 客户服务。
	正在处理	无需执行操作。
	出错/手动进纸/手动双面打印/纸张用尽/挡盖打开/卡纸	<ul style="list-style-type: none">• 手动进纸/手动双面打印 - 就绪时按 OK 按钮。• 纸张用尽 - 插入纸张。• 挡盖打开 - 合上所有挡盖。• 出错/卡纸 - 请参阅《用户指南》。

控制面板错误消息

错误消息	解决方案
装入纸张	插入纸张。
<ul style="list-style-type: none">• 正在初始化...• 正在清洁...• 正在打印...冷却模式	无需执行操作。
挡盖打开	合上所有挡盖。
<ul style="list-style-type: none">• 纸盘 1 卡纸。清除卡纸，然后按 OK。• 碳粉盒区域卡纸。打开顶盖，然后卸下碳粉盒。清除卡纸。	参阅《用户指南》。
<ul style="list-style-type: none">• 手动进纸。普通纸、信纸。或按 OK 以使用可用的介质。• 手动双面打印。将纸张装入纸盘 1。按 OK 以继续。	就绪时按 OK 按钮。
<ul style="list-style-type: none">• 耗材有问题。• 安装碳粉盒。• 不兼容的碳粉盒。• 受保护的碳粉盒。• 未经授权的碳粉盒。	取出再插回碳粉盒。如果仍出错，请访问 www.hp.com/support/liM182MFP 。
<ul style="list-style-type: none">• 碳粉盒中碳粉严重不足。• 正在使用二手或仿冒的碳粉盒。	更换为新的碳粉盒。

下载和安装软件

注：直到提示连接 USB 电缆时再这样做。

方法 1：从 123.hp.com/laserjet 下载

1. 访问 123.hp.com/laserjet (Windows) 或 123.hp.com (OS X)，然后单击 **下载**。
2. 按屏幕上的说明和提示将文件保存到计算机。
3. 从保存软件文件的文件夹中启动该文件。
4. 按照屏幕上的说明安装该软件。
5. 提示选择连接类型时，选择该连接类型的相应选项。

方法 2：从打印机支持网站下载 (Windows)

1. 访问 www.hp.com/support/liM182MFP。
2. 选择 **软件和驱动程序**。
3. 下载适用于您的打印机型号和操作系统的软件。
4. 从保存软件文件的文件夹中启动该文件。
5. 按照屏幕上的说明安装该软件。
6. 提示选择连接类型时，选择该连接类型的相应选项。

方法 1: HP Smart

使用 HP Smart 应用程序进行设置、打印等等。

1. 扫描二维码或访问 123.hp.com。
2. 安装 HP Smart 应用程序。
3. 运行 HP Smart 应用程序，然后按屏幕上的说明进行连接、设置、打印等等。



方法 2: Wi-Fi Direct (仅限无线型号)

通过 Wi-Fi Direct，智能手机、平板电脑或计算机等支持 Wi-Fi 的设备可直接与打印机建立无线网络连接，而不必使用无线路由器或接入点。连接到打印机的 Wi-Fi Direct 信号与将支持 Wi-Fi 的设备连接到新的无线网络或热点的方式相同。

启用 Wi-Fi Direct

要从控制面板中设置 Wi-Fi Direct，请完成以下步骤：

1. 在打印机控制面板上，按“设置”按钮，然后打开“网络设置”菜单。
2. 打开以下菜单：
 - Wi-Fi Direct
 - 开/关
3. 轻触开菜单项。

发现打印机

1. 从移动设备上开启 Wi-Fi，然后搜索无线网络。
2. 选择打印机控制面板上显示的打印机。
示例打印机名称：Direct-bb-HP M182 Laserjet

详细了解移动打印

有关这些和其他操作系统（Chrome/Google 云打印）的进一步信息，请访问 www.hp.com/go/LaserJetMobilePrinting 或扫描二维码。



使用扫描功能

使用计算机上的 HP Scan 软件在打印机上开始进行扫描作业。

Windows

单击**开始**，然后依次选择**程序**或**所有程序**、**HP**、**HP Scan**。

OS X

转到**应用程序**文件夹，然后打开 **HP Smart**。

故障排除

无线连接故障排除

确认打印机在无线网络的覆盖范围内。对于大多数网络，打印机与无线接入点（无线路由器）的距离必须在 30 米（100 英尺）以内。可能需要 USB 电缆用于临时连接打印机与计算机。要确保正确地同步无线设置信息，请直到提示连接该 USB 电缆时再照做。

按照这些步骤还原网络设置：

1. 从打印机上拔下 USB 电缆。
2. 按住打印机控制面板上的“无线”按钮。当“就绪”LED 指示灯和“注意”LED 指示灯一起开始闪烁时，松开“无线”按钮。打印机将自动还原网络默认设置并重新启动。
3. 在“就绪”LED 指示灯点亮时，继续安装软件。

《用户指南》和其他支持资源

《用户指南》中含有打印机使用和故障排除信息。可在 Web 上找到它：访问 www.hp.com/support/ljm182MFP。

检查固件更新

1. 访问 www.hp.com/support/ljm182MFP。
2. 从列表中选择打印机或类别，然后单击**驱动程序**。
3. 选择操作系统，然后单击**下一步**按钮。
4. 选择**固件**，然后单击**下载**按钮。

无线打印

有关无线打印和无线设置的详细信息，请访问 www.hp.com/go/wirelessprinting。



For frequently asked questions, go to www.hp.com/support/ljM182MFPFAQ or scan the QR code.



LED control panel view

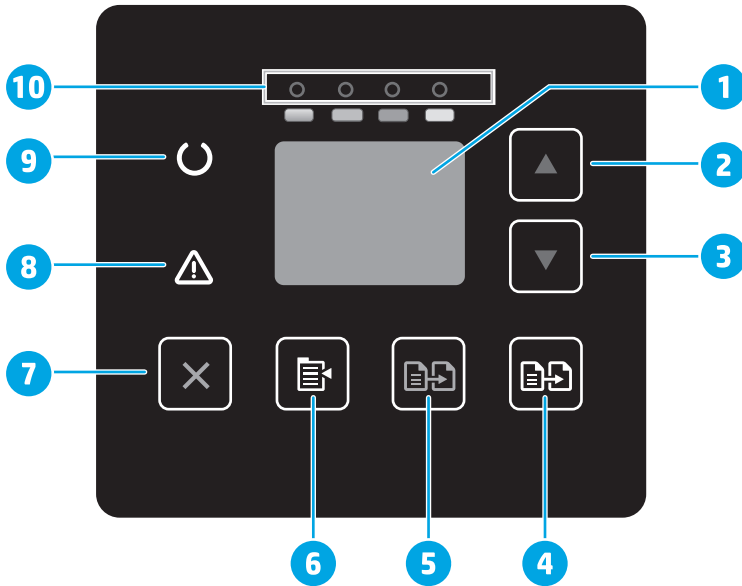

- | | |
|----|------------------------------|
| 1 | Control panel LED display |
| 2 | Up arrow ▲ button |
| 3 | Down arrow ▼ button |
| 4 | Start Color Copy / OK button |
| 5 | Start Mono Copy button |
| 6 | Copy Setup button |
| 7 | Cancel X button |
| 8 | Attention Δ LED |
| 9 | Ready ○ LED |
| 10 | Supplies LEDs |

2-line LCD control panel view

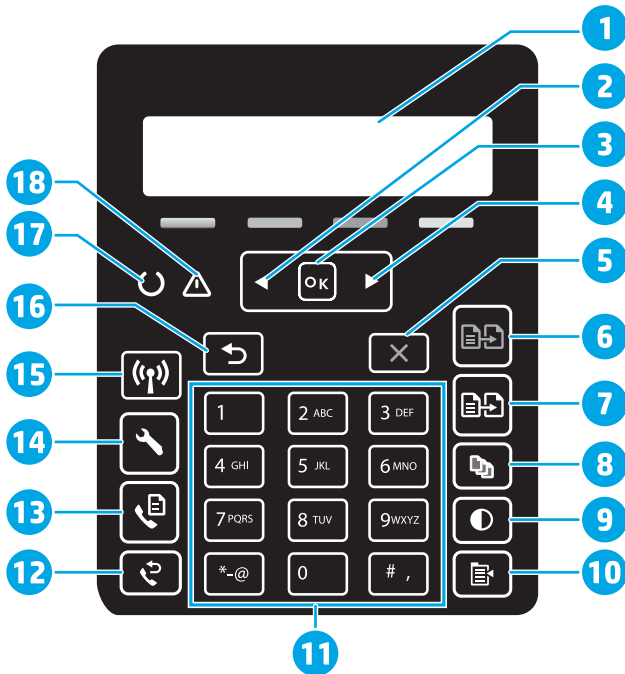

- | | | | |
|---|------------------------------|----|---------------------------------------|
| 1 | 2-line control panel display | 10 | Copy Menu button |
| 2 | Left arrow ◀ button | 11 | Alphanumeric keypad |
| 3 | OK button | 12 | Fax Redial button (fax models only) |
| 4 | Right arrow ▶ button | 13 | Start Fax button (fax models only) |
| 5 | Cancel X button | 14 | Setup button |
| 6 | Start Mono Copy button | 15 | Wireless button (wireless model only) |
| 7 | Start Color Copy button | 16 | Back arrow button |
| 8 | Number of Copies button | 17 | Ready ○ LED |
| 9 | Lighter/Darker button | 18 | Attention Δ LED |

Control panel light patterns

Lights	Description	Solution
	Ready	No action to take.
	Toner cartridge is at end of life	A Supplies light blinks when a supply error occurs, and it glows without blinking when the supply is very low.
	Fatal error	Power cycle. If error still appears, call HP customer service.
	Processing	No action to take.
	Error/Manual Feed/Manual Duplex/Out of paper/Door open/Jam	<ul style="list-style-type: none"> Manual Feed/Manual Duplex - Press the OK button when ready. Out of paper - Insert paper. Door open - Secure all doors. Error/Jam - Refer to User Guide.

Control panel error message

Error Message	Solution
Load Paper	Insert paper.
<ul style="list-style-type: none"> Initializing... Cleaning... Printing... Cool down mode 	No action to take.
Door is open	Secure all doors.
<ul style="list-style-type: none"> Jam in tray 1. Clear jam and then press OK. Jam in cartridge area. Open top cover and remove cartridge. Clear jam. 	Refer to User Guide.
<ul style="list-style-type: none"> Manual Feed. Plain, Letter. Or press OK to use available media. Manual Duplex. Load tray 1. Press OK to continue. 	Press the OK button when ready.
<ul style="list-style-type: none"> Supply problem. Install cartridge. Incompatible cartridge. Protected cartridge. Unauthorized cartridge. 	Take out and reinsert the toner cartridge. If error still appears, go to www.hp.com/support/ljM182MFP .
<ul style="list-style-type: none"> Cartridge is very low. Used or counterfeit cartridge in use. 	Replace with a new cartridge.

Download and install the software

NOTE: Do not connect the USB cable until you are prompted to do so.

Method 1: Download from 123.hp.com/laserjet

- Go to 123.hp.com/laserjet (Windows) or 123.hp.com (OS X), and click **Download**.
- Follow the onscreen instructions and then prompts to save the file to the computer.
- Launch the software file from the folder where the file was saved.
- Follow the onscreen instructions to install the software.
- When prompted to select a connection type, select the appropriate option for the type of connection.

Method 2: Download from printer support website (Windows)

- Go to www.hp.com/support/ljM182MFP.
- Select **Software and Drivers**.
- Download the software for your printer model and operating system.
- Launch the software file from the folder where the file was saved.
- Follow the onscreen instructions to install the software.
- When prompted to select a connection type, select the appropriate option for the type of connection.

Mobile printing

Method 1: HP Smart

Use the HP Smart app to set up, print, and more.

1. Scan the QR code or go to 123.hp.com.
2. Install the HP Smart app.
3. Run the HP Smart app and follow the onscreen instructions to connect, set up, print, and more.



Method 2: Wi-Fi Direct (wireless models only)

Wi-Fi Direct allows Wi-Fi capable devices, such as smart phones, tablets, or computers, to make a wireless network connection directly to the printer without using a wireless router or access point. Connect to the printer's Wi-Fi Direct signal the same way Wi-Fi capable devices are connected to a new wireless network or hotspot.

Enable Wi-Fi Direct

To set up Wi-Fi Direct from the control panel, complete the following steps:

1. On the printer control panel, press the Setup  button, and then open the Network Setup menu.
2. Open the following menus:
 - **Wi-Fi Direct**
 - **On/Off**
3. Touch the **On** menu item.

Discover the printer

1. From the mobile device, turn on the Wi-Fi, and search for wireless networks.
2. Select the printer as shown on the printer control panel.

Example printer name: Direct-bb-HP M182 Laserjet

Learn more about mobile printing

For further information about these and other operating systems (Chrome/Google Cloud Print), go to www.hp.com/go/LaserJetMobilePrinting or scan the QR code.



Use the scan feature

Use the HP Scan software on your computer to start a scan job at the printer.

Windows

Click **Start**, select **Programs** or **All Programs**, select **HP**, and then select **HP Scan**.

OS X





Go to the **Applications** folder and open **HP Smart**.

Troubleshooting

Wireless connection troubleshooting

Verify that the printer is within the range of the wireless network. For most networks, the printer must be within 30 m (100 ft) of the wireless access point (wireless router). A USB cable might be required for temporary connection between the printer and the computer. To ensure that the wireless setup information synchronizes correctly, do not connect the USB cable until prompted to do so.

Follow these steps to restore the network settings:

1. Remove the USB cable from the printer.
2. Press and hold the Wireless  button on the printer control panel. When the Ready  LED and the Attention  LED start blinking simultaneously, release the Wireless  button. Printer will restore network default automatically and restart.
3. When the Ready  LED is on, continue to install the software.

User guide and additional support resources

The user guide includes printer usage and troubleshooting information. It is available on the web: Go to www.hp.com/support/ljM182MFP.

Check for firmware updates

1. Go to www.hp.com/support/ljM182MFP.
2. Select a printer or category from the list, and then click **Drivers**.
3. Select the operating system, and click the **Next** button.
4. Select **Firmware**, and click the **Download** button.

Wireless printing

For more information about wireless printing and wireless setup, go to www.hp.com/go/wirelessprinting.



© Copyright 2019 HP Development Company, L.P.

未经事先书面许可，严禁进行任何形式的复制、改编或翻译，除非版权法另有规定。

此处包含的信息如有更改，恕不另行通知。

此类产品和服务附带的保修声明中明确规定了 HP 产品和服务的所有保修事项。不得将本文的任何内容视为构成附加保修。HP 不对本文档中的技术错误、编辑错误或遗漏承担责任。

商标说明

Windows®是 Microsoft Corporation 在美国的注册商标。

Apple 和 Apple 徽标是 Apple Inc. 在美国和其它国家/地区的注册商标

App Store 是 Apple Inc. 的服务商标。Android、Google Play 和 Google Play 徽标是 Google Inc. 的商标。

OS X 是 Apple Inc. 在美国和其他国家/地区的注册商标。

AirPrint 是 Apple Inc. 在美国和其他国家/地区的注册商标。



www.hp.com

© Copyright 2019 HP Development Company, L.P.

Reproduction, adaptation or translation without prior written permission is prohibited, except as allowed under the copyright laws.

The information contained herein is subject to change without notice.

The only warranties for HP products and services are set forth in the express warranty statements accompanying such products and services. Nothing herein should be construed as constituting an additional warranty. HP shall not be liable for technical or editorial errors or omissions contained herein.

Trademark Credits

Windows® is a U.S. registered trademark of Microsoft Corporation.

Apple and the Apple logo are trademarks of Apple Inc., registered in the U.S. and other countries.

App Store is a service mark of Apple Inc. Android, Google Play, and the Google Play logo are trademarks of Google Inc.

OS X is a trademark of Apple Inc., registered in the U.S. and other countries.

AirPrint is a trademark of Apple Inc., registered in the U.S. and other countries.

