



User Guide

© Copyright 2019 HP Development Company, L.P.

DisplayPort is a trademark owned by the Video Electronics Standards Association (VESA®) in the United States and other countries.

FreeSync is a trademark of Advanced Micro Devices, Inc. HDMI, the HDMI Logo and High-Definition Multimedia Interface are trademarks or registered trademarks of HDMI Licensing LLC. Windows is either a registered trademark or trademark of Microsoft Corporation in the United States and/or other countries.

The information contained herein is subject to change without notice. The only warranties for HP products and services are set forth in the express warranty statements accompanying such products and services. Nothing herein should be construed as constituting an additional warranty. HP shall not be liable for technical or editorial errors or omissions contained herein.

Product notice

This guide describes features that are common to most models. Some features may not be available on your product. To access the latest user guide, go to <http://www.hp.com/support>, and follow the instructions to find your product. Then select **User Guides**.





Second Edition: August 2019

First Edition: July 2019

Document Part Number: L64494-002

About This Guide

This guide provides information about monitor features, setting up the monitor, using the software and technical specifications.

-
-  **WARNING!** Indicates a hazardous situation that, if not avoided, **could** result in serious injury or death.
 -  **CAUTION:** Indicates a hazardous situation that, if not avoided, **could** result in minor or moderate injury.
 -  **IMPORTANT:** Indicates information considered important but not hazard-related (for example, messages related to property damage). Warns the user that failure to follow a procedure exactly as described could result in loss of data or in damage to hardware or software. Also contains essential information to explain a concept or to complete a task.
 -  **NOTE:** Contains additional information to emphasize or supplement important points of the main text.
 -  **TIP:** Provides helpful hints for completing a task.
-



This product incorporates HDMI technology.

Table of contents

1 Getting started	1
Important safety information	1
Product features and components	2
Features	2
Rear components	3
Setting up the monitor	4
Installing the stand	4
Mounting the monitor head	5
Removing the monitor stand	5
Attaching the VESA mounting bracket	6
Connecting the cables	7
Connecting USB devices	9
Adjusting the monitor	10
Installing a security cable	11
Storing headphones	11
Turning on the monitor	12
2 Using the monitor	13
Downloading the monitor driver	13
Using the OSD menu	13
Display mode	14
Using Auto-Sleep Mode	14
Using the Sleep Timer	15
Using the Power-Off Timer	15
Using Ambient Lighting	15
Selecting a faster response time for gaming	16
Adjusting blue light output	16
Using HP Enhance+	16
Using RGB Gain Control	17
Viewing the Frame Rate	17
Using Message Timers	18
Using the Crosshair feature	19
Using Multi-Monitor Align	19
3 Support and troubleshooting	20
Solving common issues	20

Button lockouts	20
Contacting support	21
Preparing to call technical support	21
Locating the serial number and product number	21
4 Maintaining the monitor	22
Maintenance guidelines	22
Cleaning the monitor	22
Shipping the monitor	22
Appendix A Technical specifications	23
Preset display resolutions	24
Entering user modes	25
Appendix B Accessibility	26
HP and accessibility	26
Finding the technology tools you need	26
The HP commitment	26
International Association of Accessibility Professionals (IAAP)	26
Finding the best assistive technology	27
Assessing your needs	27
Accessibility for HP products	27
Standards and legislation	28
Standards	28
Mandate 376 – EN 301 549	28
Web Content Accessibility Guidelines (WCAG)	28
Legislation and regulations	28
Useful accessibility resources and links	29
Organizations	29
Educational institutions	29
Other disability resources	29
HP links	30
Contacting support	30

1 Getting started

Important safety information

An AC adapter and power cord may be included with the monitor. If you use another cord, use only a power source and connection appropriate for this monitor. For information about the correct power cord set to use with the monitor, refer to the *Product Notices* provided in your documentation kit.

 **WARNING!** To reduce the risk of electric shock:

- Plug the power cord into an AC outlet that is easily accessible at all times.
- If the power cord has a 3-pin attachment plug, plug the cord into a grounded (earthed) 3-pin outlet.
- Disconnect power from the computer by unplugging the power cord from the AC outlet. When unplugging the power cord from the AC outlet, grasp the cord by the plug.

For your safety, do not place anything on power cords or cables. Care should be taken to route all cords and cables connected to the monitor so that they cannot be stepped on, pulled, grabbed, or tripped over.

To reduce the risk of serious injury, read the *Safety & Comfort Guide* provided with your user guides. It describes proper workstation setup and proper posture, health, and work habits for computer users. The *Safety & Comfort Guide* also provides important electrical and mechanical safety information. The *Safety & Comfort Guide* is also available on the Web at <http://www.hp.com/ergo>.

 **IMPORTANT:** For the protection of the monitor and the computer, connect all power cords for the computer and its peripheral devices (such as a monitor, printer, scanner) to a surge protection device such as a power strip or uninterruptible power supply (UPS). Not all power strips provide surge protection; the power strip must be specifically labeled as having this capability. Use a power strip whose manufacturer offers a damage replacement policy so that you can replace the equipment if surge protection fails.

Use the appropriate and correctly sized furniture designed to properly support your monitor.

 **WARNING!** Monitors that are inappropriately situated on dressers, bookcases, shelves, desks, speakers, chests, or carts may fall over and cause personal injury.

 **NOTE:** This product is suitable for entertainment purposes. Consider placing the monitor in a controlled luminous environment to avoid interference from surrounding light and bright surfaces that can cause disturbing reflections from the screen.

Product features and components

Features

This monitor supports FreeSync™, which is an Adaptive-Sync technology designed to reduce stuttering and tearing in games and videos by locking the monitor's refresh rate to the frame rate of the graphics card.

Check with your graphics card manufacturer for compatibility with monitors enabled with FreeSync.



NOTE: Adaptive refresh rates vary by display.

To enable Adaptive-Sync on the monitor, press the **Menu** button on the monitor to open the on-screen display (OSD) menu. Select **Gaming**, select **Adaptive-Sync or FreeSync**, and then select **On**. Adaptive-Sync is for DisplayPort™ connections using FreeSync. FreeSync is for HDMI connections only.

The monitor includes the following features:

- 68.47 cm (27-inch) diagonal viewable area with 2560 × 1440 resolution
- Tilt and height-adjustment capabilities
- One High-Definition Multimedia Interface (HDMI) video input
- One DisplayPort video input
- High-bandwidth Digital Content Protection (HDCP) used on all inputs
- USB hub with one upstream port and two downstream ports
- Audio-out (headphone) jack
- HDMI, DisplayPort, and USB Type-B-to-USB Type-A cables included
- Plug and Play capability if supported by your operating system
- OSD adjustments in 10 languages for easy setup and screen optimization
- Frames-per-second indicator displayed on the monitor screen, adjustable using the OSD menu
- Message timer displayed on the monitor screen, adjustable using the OSD menu
- Gaming crosshair displayed on the monitor screen, adjustable using the OSD menu
- Security cable slot on the rear of the monitor for an optional security cable
- User-configurable ambient lighting with full-range LEDs
- Convenient headphone storage hook on monitor stand
- VESA® mounting capability for attaching the display to a wall mount device or swing arm



NOTE: For safety and regulatory information, refer to the *Product Notices* provided in your documentation kit. To access the latest user guide, go to <http://www.hp.com/support> and follow the instructions to find your product. Then select **User Guides**.

Rear components

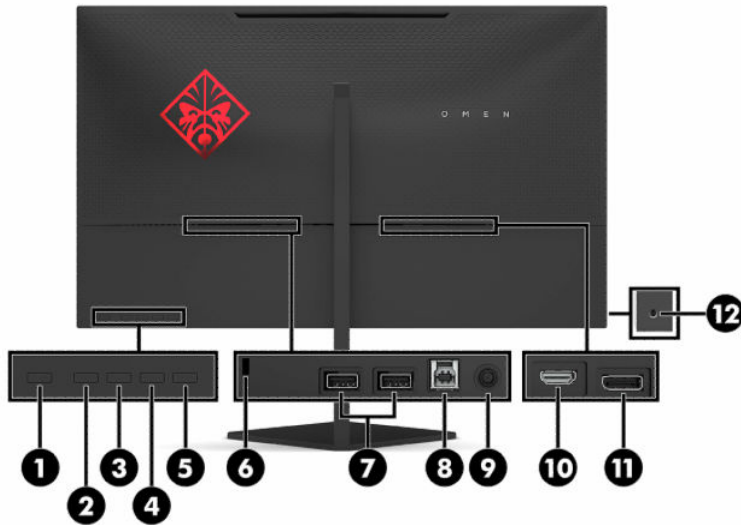

Table 1-1 Rear components

Component	Description
(1) Power button	Turns the monitor on or off.
(2) Back button	If the OSD menu is open, press to exit or return to previous menu level. If the OSD menu is closed, press to open the Brightness menu.
(3) Plus button	If the OSD menu is open, press to navigate forward through the OSD menu and increase adjustment levels. If the OSD menu is closed, press to open the Color menu.
(4) Minus button	If the OSD menu is open, press to navigate backward through the OSD menu and decrease adjustment levels. If the OSD menu is closed, press to open the Information menu.
(5) Menu/OK button	Press to open the OSD menu, or select a menu item from the OSD.
(6) Security cable slot	Connects an optional security cable to the monitor.
(7) USB ports	Connect USB devices.
(8) USB Type-B port	Connects the USB hub cable to a source device such as a computer or game console.
(9) Power connector	Connects an AC adapter.
(10) HDMI port	Connects an HDMI cable to a source device such as a computer or game console.
(11) DisplayPort connector	Connects a DisplayPort cable to a source device such as a computer or game console.
(12) Audio-out (headphones) jack	Connects optional headphones. WARNING! To reduce the risk of personal injury, adjust the source device volume before using headphones, earbuds, or a headset. For additional safety information, see the <i>Product Notices</i> provided in your documentation kit.

Setting up the monitor

WARNING! To reduce the risk of serious injury, read the *Safety & Comfort Guide*. It describes proper workstation setup and proper posture, health, and work habits for computer users. The *Safety & Comfort Guide* also provides important electrical and mechanical safety information. The *Safety & Comfort Guide* is available on the Web at <http://www.hp.com/ergo>.

IMPORTANT: To prevent damage to the monitor, do not touch the surface of the LCD panel. Pressure on the panel can cause nonuniformity of color or disorientation of the liquid crystals. If this occurs, the screen will not recover to its normal condition.

IMPORTANT: To prevent the screen from getting scratched, defaced, or broken and to prevent damage to the control buttons, position the monitor facedown on a flat surface covered with protective sheet foam or a nonabrasive cloth.

Installing the stand

1. Position the monitor facedown on a flat surface covered by a soft clean cloth.
2. Slide the hinge on the stand into the hinge slot on the back of the monitor head to secure the stand to the monitor head. There will be an audible click when the stand is properly seated onto the hinge. Make sure that the stand is properly secured to the monitor head before use.

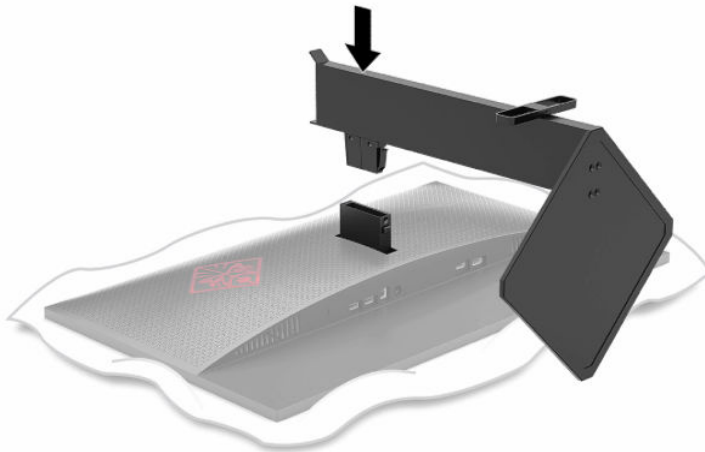

Mounting the monitor head

The monitor head can be attached to a wall, swing arm, or other mounting fixture.

IMPORTANT: This monitor supports the VESA industry-standard 100 mm mounting holes. To attach a third-party mounting solution to the monitor, four 4 mm, 0.7 pitch, and 10 mm–long screws are required. Longer screws can damage the monitor. Be sure to verify that the manufacturer’s mounting solution is compliant with the VESA standard and is rated to support the weight of the monitor head. For best performance, use the power and video cables that are provided with the monitor.

NOTE: This apparatus is intended to be supported by UL- or CSA-listed wall-mount brackets.

Removing the monitor stand

You can remove the monitor head from the stand to install the monitor head on a wall, a swing arm, or other mounting fixture.

IMPORTANT: Before beginning to disassemble the monitor, be sure that the monitor is turned off and all cables are disconnected.

1. Disconnect and remove all cables from the monitor.
2. Position the monitor head facedown on a flat surface covered by a clean, dry cloth.
3. Press the release button on the underside of the stand’s hinge (1), and then slide the stand off the monitor head (2).

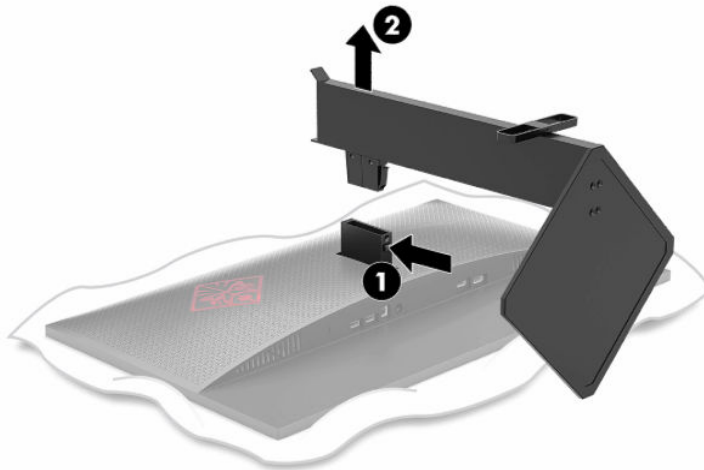

Attaching the VESA mounting bracket

A VESA mounting bracket is included with the monitor for use when attaching the monitor head to a wall, swing arm, or other mounting fixture.

1. Remove the monitor stand if it is attached. See [Removing the monitor stand on page 5](#).
2. Insert the VESA mounting bracket into the slot on the back of the monitor head's hinge to secure the bracket to the monitor head. There will be an audible click when the bracket is properly seated onto the hinge. Make sure that the bracket is properly secured to the monitor head before use.

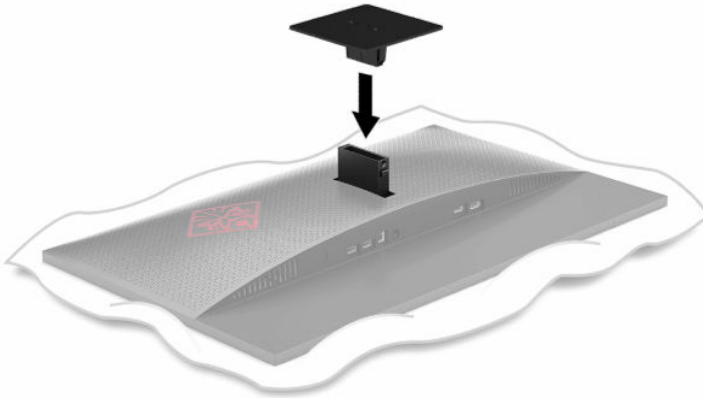

3. To attach the monitor head to a swing arm or other mounting device, insert four mounting screws through the holes on the mounting device and into the screw holes on the VESA mounting bracket.

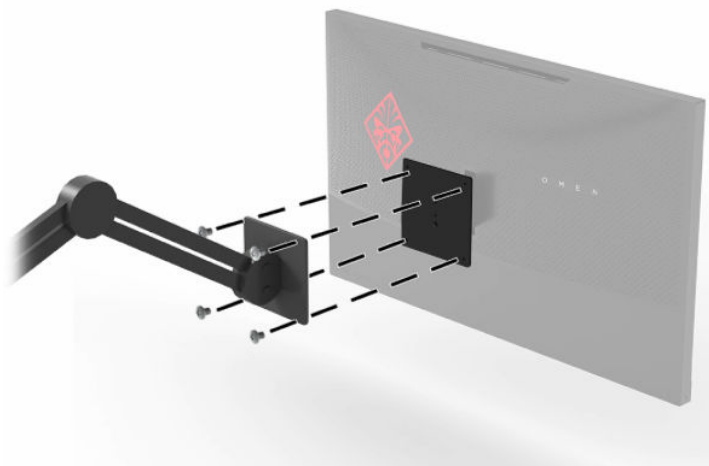

 **IMPORTANT:** Follow the mounting device manufacturer's instructions when mounting the monitor to a wall or swing arm.

Connecting the cables

 **NOTE:** The monitor ships with select cables.

1. Place the monitor in a convenient, well-ventilated location near the computer or source device.
2. Before connecting the cables, route the cables through the cable management guide on the rear of the monitor.

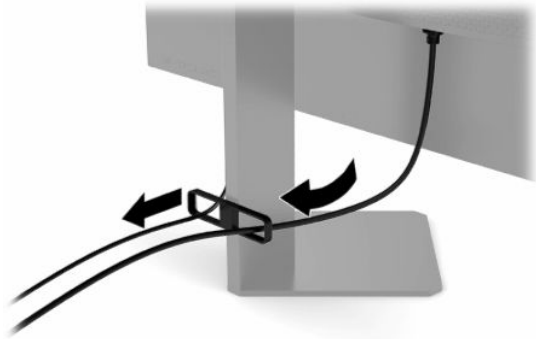

3. Connect a video cable.

 **NOTE:** The monitor automatically determines which inputs have valid video signals. You can also select inputs by pressing the **Menu** button and selecting **Input**.

 **NOTE:** DisplayPort is the preferred connection type for optimal performance.

- Connect one end of a DisplayPort cable to the DisplayPort connector on the rear of the monitor and the other end to the DisplayPort connector on the source device.

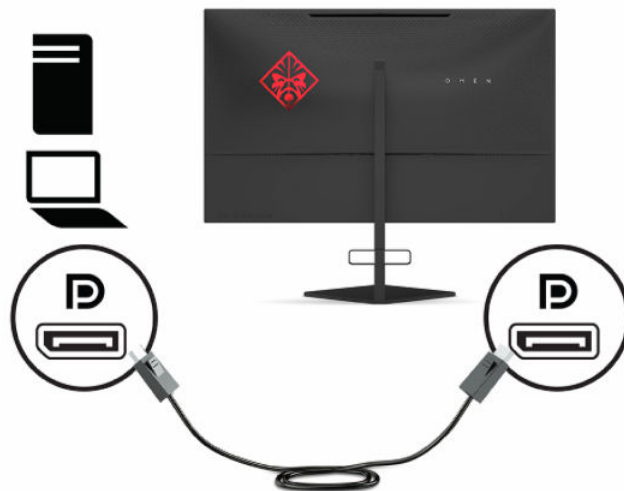

- Connect one end of an HDMI cable to the HDMI port on the rear of the monitor and the other end to the HDMI port on the source device.

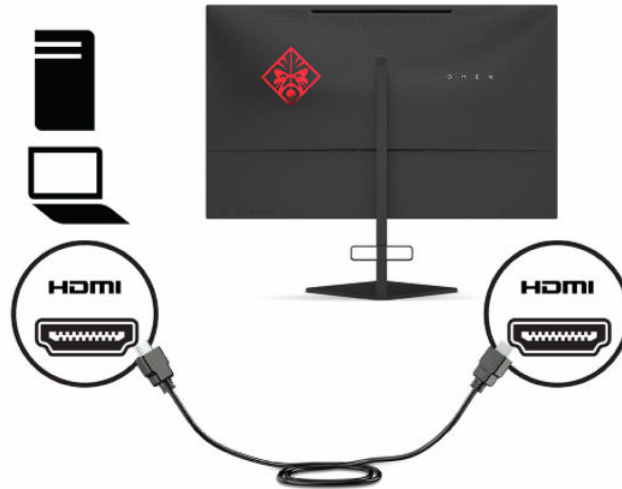

4. Connect the Type-B connector on the USB upstream cable to the USB Type-B upstream port on the rear of the monitor. Then connect the cable's Type-A connector to the USB Type-A downstream port on the source device.

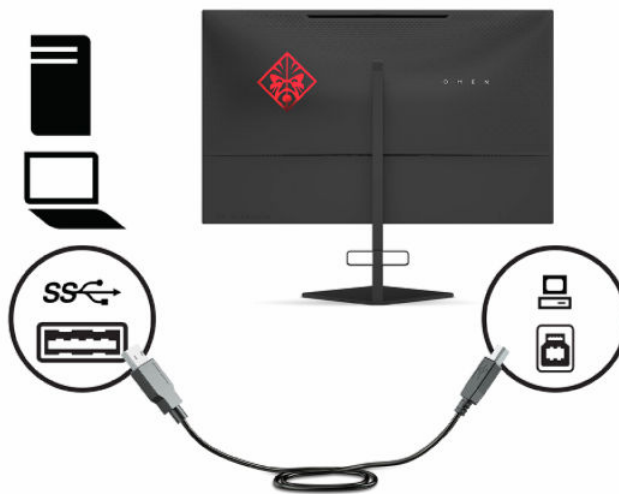

 **NOTE:** You must connect the USB Type-B upstream cable from the source device (computer, laptop, gaming console) to the rear of the monitor to enable the USB Type-A downstream ports on the monitor. For more information, see [Connecting USB devices on page 9](#).

5. Connect one end of the power cord to the AC adapter (1) and the other end to a grounded AC outlet (2), and then connect the AC adapter to the power connector on the monitor (3).

⚠ WARNING! To reduce the risk of electric shock or damage to the equipment:

Do not disable the power cord grounding plug. The grounding plug is an important safety feature.

Plug the power cord into a grounded (earthed) AC outlet that is easily accessible at all times.

Disconnect power from the equipment by unplugging the power cord from the AC outlet.

For your safety, do not place anything on power cords or cables. Arrange them so that no one may accidentally step on or trip over them. Do not pull on a cord or cable. When unplugging the power cord from the AC outlet, grasp the cord by the plug.

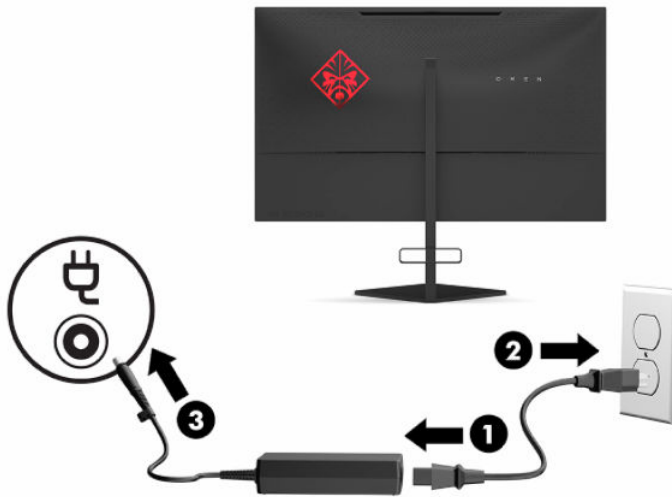

Connecting USB devices

The rear of the monitor provides one USB Type-B upstream port and two USB Type-A downstream ports.

📝 NOTE: You must connect the USB Type-B upstream cable from the source device to the monitor to enable the USB Type-A downstream ports on the monitor.



Adjusting the monitor

⚠ WARNING! To reduce the risk of serious injury, read the *Safety & Comfort Guide*. It describes proper workstation setup and proper posture, health, and work habits for computer users. The *Safety & Comfort Guide* also provides important electrical and mechanical safety information. The *Safety & Comfort Guide* is available on the Web at <http://www.hp.com/ergo>.

1. Tilt the monitor head forward or backward to set it to a comfortable eye level.

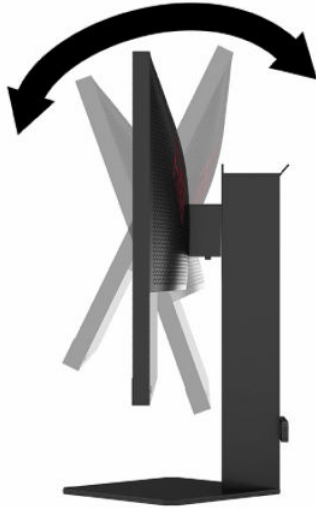

2. Adjust the monitor's height to a comfortable position for your individual workstation. The monitor's top bezel edge should not exceed a height that is parallel to your eye height. A monitor that is positioned low and reclined may be more comfortable for users with corrective lenses. The monitor should be repositioned as you adjust your working posture throughout the work day.

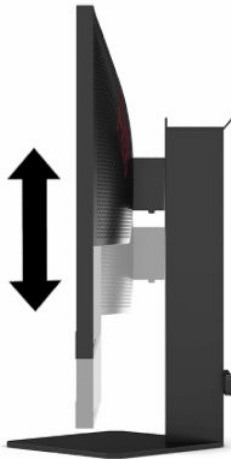

Installing a security cable

You can secure the monitor to a fixed object with an optional security cable available from HP. Use the key provided to attach and remove the lock.

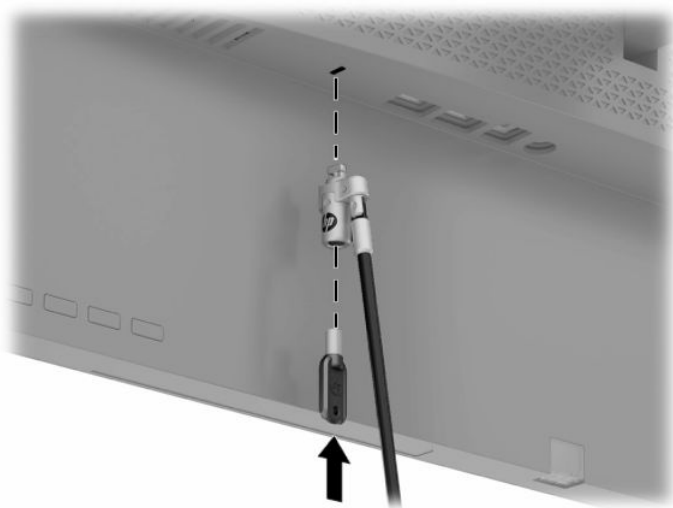

Storing headphones

The monitor features a headphone hook at the top of the stand for convenient headphone storage.



Turning on the monitor

1. Press the power button on the source device to turn it on.
2. Press the power button on the rear of the monitor to turn it on.



IMPORTANT: Burn-in image damage may occur on monitors that display the same static image on the screen for 12 or more consecutive hours of nonuse. To avoid burn-in image damage on the monitor screen, you should always activate a screen saver application or turn off the monitor when it will not be in use for a prolonged period of time. Image retention is a condition that might occur on all LCD screens. A burned-in image on the monitor is not covered under the HP warranty.

NOTE: You can disable the power light in the OSD menu. Press the **Menu** button, and then select **Power**. Select **Power LED**, and then select **Off**.

NOTE: If pressing the power button to turn the monitor off has no effect, the Power Button Lockout feature might be enabled. To disable this feature, press and hold the monitor power button for 10 seconds.

When the monitor is turned on, a monitor status message appears for 5 seconds. The message shows which input is the current active signal, the status of the autoswitch input setting (On or Off; default is On), the current detected display resolution, and the recommended preset display resolution.

The monitor automatically scans the signal inputs for the last active input, or in case of a no-signal condition, the first detected active input for the monitor.

2 Using the monitor

Downloading the monitor driver

You can download and install the monitor INF (Information) driver file from <http://www.hp.com/support>.

1. Go to <http://www.hp.com/support>.
2. Select **Software and Drivers**.
3. Select your product type.
4. Enter your HP monitor model in the search field and follow the on-screen instructions.

This monitor is Windows® Plug and Play-compatible, and the monitor will work correctly without installing the INF file. Monitor Plug and Play compatibility requires that the computer's graphics card is VESA DDC2-compliant and that the monitor connects directly to the graphics card. Plug and Play does not work through separate BNC-type connectors or through distribution buffers or boxes.

Using the OSD menu

Use the OSD menu to adjust the screen image based on your viewing preferences. You can access and make adjustments in the OSD using the buttons at the bottom of the monitor's rear panel.

To access the OSD menu and make adjustments:

1. If the monitor is not already on, press the power button to turn on the monitor.
2. Press the **Menu** button.
3. Use the three function buttons to navigate, select, and adjust the menu choices. The on-screen button labels vary depending on which menu or submenu is active.

The following table lists possible menu selections in the OSD main menu.

Table 2-1 OSD main menu options and their descriptions

Main menu	Description
Gaming	Selects and adjusts gaming preferences, such as Adaptive-Sync, response time, frame rate, message timers, crosshair, ambient lighting, and multiple monitor align.
Image	Adjusts the screen image, including brightness, contrast, dynamic contrast, gamma, sharpness, and image scaling.
Color	Provides a variety of color presets that configure the monitor for different viewing situations.
Input	Selects the video input signal (DisplayPort or HDMI).
Power	Adjusts the power settings.
Menu	Adjusts the OSD menu controls.
Management	Returns all OSD menu settings to the factory default settings.
Information	Displays important information about the monitor.
Exit	Exits the OSD menu screen.

Display mode

The display mode of the monitor is reported in the monitor status message that appears when the monitor is turned on and when the video input is changed. The current display mode is shown in the **Information** menu window and at the bottom of the OSD's main menu in the status bar area. Modes of operation are **Normal** and **Adaptive-Sync or FreeSync**.

To turn on the Adaptive-Sync or FreeSync mode:

1. Press the **Menu** button to open the OSD menu.
2. In the OSD select **Gaming**.
3. Select **Adaptive-Sync or FreeSync**, and then select **On**.



NOTE: The Adaptive-Sync or FreeSync menu default setting is On.

Using Auto-Sleep Mode

The monitor supports an OSD menu option called Auto-Sleep Mode that allows you to enable or disable a reduced power state for the monitor. When Auto-Sleep Mode is enabled (enabled by default), the monitor enters a reduced power state when the computer signals low power mode (absence of either horizontal or vertical sync signal).

Upon entering this reduced power state (sleep mode), the monitor screen is blanked, the backlight is turned off, and the power light turns amber. The monitor draws less than 0.5 W of power when in this reduced power state. The monitor wakes from sleep mode when the computer sends an active signal to the monitor (for example, if you activate the mouse or keyboard).

To disable Auto-Sleep Mode in the OSD:

1. Press the **Menu** button to open the OSD menu.
2. In the OSD, select **Power**.
3. Select **Auto-Sleep Mode**, and then select **Off**.

Using the Sleep Timer

You use the Sleep Timer menu to program the monitor to enter and exit the reduced power or sleep state at predetermined user-selectable times. For example, you can set the monitor to automatically enter sleep mode at 5 p.m. and then automatically wake from sleep mode at 8 a.m. When the monitor is in sleep mode, the power light blinks amber.

To use the Sleep Timer:

1. Press the **Menu** button to open the OSD menu.
2. Select **Power**.
3. Select **Sleep Timer**, and then select **On**.
4. Set the times you want the monitor to enter into sleep mode and wake from sleep mode.



NOTE: The Sleep Timer is disabled if the Power-Off Timer is active.

Using the Power-Off Timer

You use the Power-Off Timer menu to program the monitor to automatically turn off at a predetermined user-selectable time. For example, you can manually turn on the monitor in the morning and configure the Power-Off Timer to automatically turn off the monitor at 6 p.m. in the evening.

To turn on the Power-Off Timer:

1. Press the **Menu** button to open the OSD menu.
2. In the OSD, select **Power**.
3. Select **Power-Off Timer**, and then select **On**.
4. Set the time you want the monitor to turn off.



NOTE: The Power-Off Timer is disabled if Sleep Timer is active.

Using Ambient Lighting

The monitor features Ambient Lighting to illuminate a desktop or wall and enhance the gaming experience. You can adjust the color and brightness of the ambient light or turn it off in the OSD menu or OMEN Command Center.

To adjust the ambient lighting:

1. Press the **Menu** button to open the OSD menu.
2. In the OSD, select **Gaming**, and then select **Ambient Lighting**.
3. Select a setting:
 - **Off:** Turns off the ambient lighting.
 - **Task Light:** Emulates an adjustable white desk light for better reading or viewing.
 - **Fade:** Slowly fades in and out from one color to another.
 - **Static Color:** Sets ambient light colors to red, green, blue, yellow, purple, cyan, orange, or custom.
 - **Random Color:** Randomly cycles ambient light color through the static colors.
 - **LED Brightness:** Adjusts the ambient lighting brightness.



NOTE: Ambient lighting is set to On (OMEN Red) by default.



Selecting a faster response time for gaming

To set a faster response time:

1. Press the **Menu** button to open the OSD menu.
2. Select **Gaming** and then select **Response Time**.
3. Cycle through the adjustment levels to increase or decrease response time.



NOTE: The default response time setting is optimized for gaming purposes. All performance specifications represent the typical specifications provided by HP's component manufacturers; actual performance can vary either higher or lower.

Adjusting blue light output

Decreasing the blue light emitted by the display reduces the blue light exposure to your eyes. HP monitors provide settings to reduce the blue light output and create a more relaxing and less stimulating image while you view content on the screen.

To adjust your monitor to a comfortable viewing light:

1. Press the **Menu** button to open the OSD menu.
2. Select **Color**.
3. Select **Low Blue Light** (TUV certified) for improved eye comfort.

Using HP Enhance+

The HP Enhance+ color submenu adds an additional level of detail (sharpness and contrast) to static images and motion video to enhance their appearance. The three user-selectable options are Low, Medium, and High. The default is Medium.

To turn on HP Enhance+:

1. Press the **Menu** button to open the OSD menu.
2. Select **Color**, and then select **HP Enhance+**.
3. Select either **Low**, **Medium**, or **High**.

Using RGB Gain Control

The RGB Gain Control can be used to manually adjust the color temperature of any color preset, making all color presets adjustable user modes. Adjustments are stored separately for each color preset.

To adjust the color temperature:

1. Press the **Menu** button to open the OSD menu.
2. Select **Color**.
3. Select **RGB Gain Control**.
4. Select either **Red Color ADJ SCALE GRAPHIC**, **Green Color ADJ SCALE GRAPHIC**, or **Blue Color ADJ SCALE GRAPHIC** to make adjustments.



NOTE: Exiting the menu automatically saves the RGB color settings.

Viewing the Frame Rate

Turning on the Frame Rate function allows you to view the current active input frames per second (FPS). If you turn on the Frame Rate function, you see the current active input frames per second (FPS) as a number in one section of the screen. You can select FPS text colors and screen locations from the Color and Location submenus.

To view the FPS on the screen:

1. Press the **Menu** button to open the OSD menu.
2. Select **Gaming**.
3. Select **Frame Rate**, and then select **On**.
4. Set the color and location of the FPS that is displayed on the screen.



NOTE: Frame Rate and Message Timer OSD functions share the same color and location settings.

Using Message Timers

The Message Timers menu presents two types of timers that display preset reminder/information messages. The timer menu will have an On/Off option and Start, Stop, and Reset controls. Selecting On shows the current selected timer value at the current selected location of the screen. The default is the top right corner.

The on-screen timer format initially shows minutes and seconds (0:00) but will display hours as time progresses. There are two different message timer options, but you can choose only one timer (Speedrun or Countdown) at a time. Options for both timers include the color of the timer numbers and the location of the timer on the screen.

To use the message timers:

1. Press the **Menu** button to open the OSD menu.
2. Select **Gaming**, and then select **Message Timers**.
3. Select and adjust the timers using the options described below.
 - **Speedrun Timer:** This is a progress timer showing minutes and seconds (0:00). It starts at zero and continues to 24 hours. When the timer reaches the 24-hour limit, a 20-second message appears to inform you that the timer has expired. This timer allows you to track the amount of time you've spent in a game or performing a specific task.
 - **Countdown Timer:** You can use the adjustment bar to choose a start time between 1 and 5 minutes in single-minute increments and then between 5 and 120 minutes in 5-minute increments. The timer counts down to 0:00 and then shows a message for 20 seconds in the center of the screen. The Message submenu allows you to select the exact message that will appear on the screen. The default value for the countdown timer is 20 minutes.
 - **Start:** Starts the selected timer.
 - **Stop:** Pauses or stops the timer but does not reset the timer. Selecting the Start option again continues the timer counter.
 - **Reset Timer:** Resets the timer counter to the selected start value.
 - **Message:** Allows you to select the on-screen message that appears when the selected timer expires. You can select the following messages:
 - Your Gaming Timer has Expired!
 - Please Stop Playing the Game!
 - Please Take a Break!
 - Please Shutdown the Computer!

To set the message timer as a hot key:

1. Press the **Menu** button to open the OSD menu.
2. In the OSD, select **Menu**.
3. Select **Message Timer** for the button you want to use for the hot key.
4. Use the hot key to cycle between Start, Stop, and Reset.

The following conditions are in effect when using the Message Timer hot key:

- If the FPS option is active, pressing the Message Timer hot key turns on the selected Message Timer and turns off FPS.
- If the Message Timer is active, pressing the FPS hot key turns on the FPS option and turns off Message Timer.

Using the Crosshair feature

The Crosshair menu allows you to customize various characteristics of a monitor-controlled OSD pointer through the following submenus. To use the Crosshair option:

1. Press the **Menu** button to open the OSD menu.
2. In the OSD, select **Gaming**.
3. Select **Crosshair**, and then select **On**.
4. Configure the Crosshair using the following submenus.
 - **Configure:** Select individual graphics parts that make up an on-screen crosshair or pointer by selecting the check boxes next to the options you want to display. You can combine multiple options to form your own customized Crosshair.
 - **Color:** Allows you to select the Crosshair color on the screen.
 - **Location:** Allows you to select the Crosshair location on the screen.

Using Multi-Monitor Align

The Multi-Monitor Align OSD option displays a full-screen alignment pattern that will assist you in setting up multiple monitors side by side. Selecting this option exits the OSD and displays the full screen alignment pattern.

To use Multi-Monitor Align:

1. Press the **Menu** button to open the OSD menu.
2. In the OSD, select **Gaming**.
3. Select **Multi-Monitor Align**, and then select **On**.
4. Press the **Menu** button again to exit the pattern.

3 Support and troubleshooting

Solving common issues

The following table lists possible issues, the possible cause of each issue, and the recommended solutions.

Table 3-1 Common issues and solutions

Issue	Possible cause	Solution
Screen is blank or video is flashing.	Power cord is disconnected.	Connect the power cord.
	Monitor is off.	Press the monitor power button.
	Video cable is not connected.	Connect a video cable between the source device and monitor. Be sure that the computer power is off while you connect the video cable. See Connecting the cables on page 7 for more information.
	System is in sleep mode.	Press any key on the keyboard or move the mouse to exit sleep mode.
Image appears too dark.	Video card is incompatible.	Replace the video card or connect the video cable to one of the computer's onboard video sources.
	Brightness setting is too low.	Open the OSD menu. Select Image and then select Brightness to adjust the brightness scale as needed.
Image appears blurred or indistinct.	Sharpness needs to be adjusted.	Verify that the monitor is at the optimum recommended resolution and then if needed, adjust the Sharpness control in the monitor Image menu.
"Input Signal Not Found" is displayed on the screen.	Video cable is disconnected.	Connect a video cable between the source device and monitor. Be sure that the computer power is off while you connect the video cable. See Connecting the cables on page 7 for more information.
"Input Signal Out of Range" is displayed on the screen.	Video resolution and/or refresh rate are set higher than the monitor supports.	Change the settings to a supported setting (see Preset display resolutions on page 24).
The monitor did not enter into a low-power sleep mode.	The monitor's Auto-Sleep Mode is disabled.	Open the OSD menu. Select Auto-Sleep Mode , and then select On .
"On-screen Menus are Locked" is displayed on the screen.	The monitor's OSD Lockout function is enabled.	While the monitor is on, hold the center of the Menu button down for 10 seconds to turn OSD Lockout on or off.
"Power Button is Locked" is displayed on the screen.	The monitor's Power Button Lockout feature is enabled.	Press and hold the power button for 10 seconds to unlock the power button function.

Button lockouts

Holding down the power button or the **Menu** button for 10 seconds locks out the functionality of the controls. You can restore the functionality by repeating the action. This functionality is available only when the monitor is on, an active signal is displayed, and the OSD menu is closed.

Contacting support

To resolve a hardware or software issue, go to <http://www.hp.com/support>. Use this site to get more information about your product, including links to discussion forums and instructions on troubleshooting. You can also find information about how to contact HP and open a support case.

 **NOTE:** Contact customer support to replace the power cord, the AC adapter (select products only), or any other cables that shipped with your monitor.

Preparing to call technical support

If you cannot solve an issue using the troubleshooting tips in this section, you might need to call technical support. Have the following information available when you call:

- Monitor model number
- Monitor serial number
- Purchase date on invoice
- Conditions under which the issue occurred
- Error messages received
- Hardware configuration
- Name and version of the hardware and software you are using

Locating the serial number and product number

The serial number and product number are located on a label on the bottom edge of the monitor head. You might need these numbers when contacting HP about the monitor model.

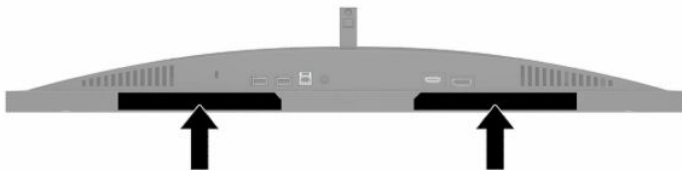

4 Maintaining the monitor

Maintenance guidelines

To enhance the performance and extend the life of the monitor:

- Do not open the monitor cabinet or attempt to service this product yourself. Adjust only those controls that are covered in the operating instructions. If the monitor is not operating properly or has been dropped or damaged, contact an authorized HP dealer, reseller, or service provider.
- Use only a power source and connection appropriate for this monitor, as indicated on the label or back plate of the monitor.
- Be sure that the total ampere rating of the products connected to the AC outlet does not exceed the current rating of the AC outlet and that the total ampere rating of the products connected to the cord does not exceed the rating of the cord. Look on the power label to determine the ampere rating (AMPS or A) for each device.
- Install the monitor near an AC outlet that you can easily reach. Disconnect the monitor by grasping the plug firmly and pulling it from the AC outlet. Never disconnect the monitor by pulling the cord.
- Turn the monitor off when it is not in use and use a screen saver program. Doing this can substantially increase the life expectancy of the monitor.



NOTE: A burned-in image on the monitor is not covered under the HP warranty.

- Never block the slots and openings of the cabinet or push objects into them. These openings provide ventilation.
- Do not drop the monitor or place it on an unstable surface.
- Do not allow anything to rest on the power cord. Do not walk on the cord.
- Keep the monitor in a well-ventilated area, away from excessive light, heat, or moisture.

Cleaning the monitor

1. Turn off the monitor and unplug the power cord from the AC outlet.
2. Disconnect any external devices.
3. Dust the monitor by wiping the screen and the cabinet with a soft, clean antistatic cloth.
4. For more difficult cleaning situations, use a 50/50 mix of water and isopropyl alcohol.



IMPORTANT: Do not use cleaners that contain any petroleum-based materials such as benzene, thinner, or any volatile substance to clean the monitor screen or cabinet. These chemicals can damage the monitor.

IMPORTANT: Spray the cleaner onto a cloth and use the damp cloth to gently wipe the screen surface. Never spray the cleaner directly on the screen surface. It might run behind the bezel and damage the electronics. The cloth should be moist, but not wet. Water dripping into the ventilation openings or other points of entry can cause damage to the monitor. Allow the monitor to air-dry before use.

Shipping the monitor

Keep the original packing box in a storage area. You may need it later if you ship the monitor or move.

A Technical specifications



NOTE: All specifications represent the typical specifications provided by HP's component manufacturers; actual performance can vary either higher or lower.

For the latest specifications or additional specifications on this product, go to <http://www.hp.com/go/quickspecs/> and search for your specific model to find the model-specific QuickSpecs.

Table A-1 Technical specifications

Specification	Measurement	
Display, wide-screen	68.47 cm	27 in.
Panel type	TN LCD	
Viewable image size	68.47 cm, diagonal	27 in., diagonal
Tilt	-5° to 23°	
Height adjustment	0 mm to 130 mm	0 in. to 5.12 in.
Weight (with stand)	7.18 kg	15.83 lb
Dimensions (including stand)		
Height	53.36 cm	21.01 in.
Depth	27.25 cm	10.73 in.
Width	61.36 cm	24.16 in.
Maximum graphic resolution	2560 × 1440 @ 240 Hz	
Optimum graphic resolution	2560 × 1440 @ 240 Hz	
Static contrast ratio	1000:1 typical	
Dynamic contrast ratio	10,000,000:1	
Dot pitch	0.2331 (H) mm × 0.2331 (V) mm	
Pixels per inch	109.0 PPI	
Horizontal scan rate	30–355 kHz	
Vertical scan rate	48–240 Hz	
Response time	The default response time for the monitor is 3.5 ms. You can adjust the response time to as fast as 1 ms in the OSD menu. All performance specifications represent the typical specifications provided by HP's component manufacturers; actual performance can vary either higher or lower.	
Environmental requirements		
Temperature		
Operating temperature	5°C to 35°C	41°F to 95°F
Non-operating temperature	-34°C to 60°C	-29°F to 140°F
Relative humidity	20% to 80%	

Table A-1 Technical specifications (continued)

Specification	Measurement
Altitude	
Operating	0 m to 5,000 m 0 ft to 16,400 ft
Storage	0 m to 12,192 m 0 ft to 40,000 ft
Power source	100 V ac to 240 V ac 50/60 Hz
Measured power consumption	
Full power	90 W
Typical settings	75 W
Sleep	< = 0.5 W
Off	< = 0.3 W
Power adapter	90 W PPP012D-E TPN-DA18
Input terminals	One HDMI port and one DisplayPort connector

Preset display resolutions

The following display resolutions are the most commonly used modes and are set as defaults. The monitor automatically recognizes these preset modes, and they will appear properly sized and centered on the screen.

Table A-2 Preset display resolutions

Preset display resolutions
640 × 480 @ 60 Hz
720 × 480 @ 60 Hz
800 × 600 @ 60 Hz
1024 × 768 @ 60 Hz
1280 × 720 @ 60 Hz
1280 × 768-R @ 60 Hz
1280 × 800 @ 60 Hz
1280 × 960 @ 60 Hz
1280 × 1024 @ 60 Hz
1366 × 768 @ 60 Hz
1440 × 900-R @ 60 Hz
1440 × 900 @ 60 Hz
1600 × 900 @ 60 Hz
1600 × 1200 @ 60 Hz
1680 × 1050 @ 60 Hz

Table A-2 Preset display resolutions (continued)

Preset display resolutions
1920 × 1080 @ 60 Hz
1920 × 1080 @ 240 Hz
1920 × 1200-R @ 60 Hz
1920 × 1200 @ 60 Hz
2560 × 1440 @ 60 Hz
2560 × 1440 @ 70 Hz
2560 × 1440 @ 120 Hz
2560 × 1440 @ 144 Hz
2560 × 1440 @ 165 Hz (DisplayPort only)
2560 × 1440 @ 240 Hz (DisplayPort only)

Entering user modes

Under the following conditions, the video controller signal might occasionally call for a mode that is not preset:

- You are not using a standard graphics adapter.
- You are not using a preset mode.

If this occurs, you might need to readjust the parameters of the monitor screen by using the OSD. You can make your changes to any or all of these modes and save them in memory. The monitor automatically stores the new setting and then recognizes the new mode just as it does a preset mode. In addition to the factory preset modes, you can enter and store at least eight user modes.

B Accessibility

HP and accessibility

Because HP works to weave diversity, inclusion, and work/life into the fabric of the company, it is reflected in everything HP does. HP strives to create an inclusive environment focused on connecting people to the power of technology throughout the world.

Finding the technology tools you need

Technology can unleash your human potential. Assistive technology removes barriers and helps you create independence at home, at work, and in the community. Assistive technology helps increase, maintain, and improve the functional capabilities of electronic and information technology. For more information, see [Finding the best assistive technology on page 27](#).

The HP commitment

HP is committed to providing products and services that are accessible for people with disabilities. This commitment supports the company's diversity objectives and helps ensure that the benefits of technology are available to all.

The HP accessibility goal is to design, produce, and market products and services that can be effectively used by everyone, including people with disabilities, either on a stand-alone basis or with appropriate assistive devices.

To achieve that goal, this Accessibility Policy establishes seven key objectives to guide HP actions. All HP managers and employees are expected to support these objectives and their implementation in accordance with their roles and responsibilities:

- Raise the level of awareness of accessibility issues within HP, and provide employees with the training they need to design, produce, market, and deliver accessible products and services.
- Develop accessibility guidelines for products and services, and hold product development groups accountable for implementing these guidelines where competitively, technically, and economically feasible.
- Involve people with disabilities in the development of accessibility guidelines and in the design and testing of products and services.
- Document accessibility features, and make information about HP products and services publicly available in an accessible form.
- Establish relationships with leading assistive technology and solution providers.
- Support internal and external research and development that improves assistive technology relevant to HP products and services.
- Support and contribute to industry standards and guidelines for accessibility.

International Association of Accessibility Professionals (IAAP)

IAAP is a not-for-profit association focused on advancing the accessibility profession through networking, education, and certification. The objective is to help accessibility professionals develop and advance their careers and to better enable organizations to integrate accessibility into their products and infrastructure.

As a founding member, HP joined to participate with other organizations to advance the field of accessibility. This commitment supports HP's accessibility goal of designing, producing, and marketing products and services that people with disabilities can effectively use.

IAAP will make the profession strong by globally connecting individuals, students, and organizations to learn from one another. If you are interested in learning more, go to <http://www.accessibilityassociation.org> to join the online community, sign up for newsletters, and learn about membership options.

Finding the best assistive technology

Everyone, including people with disabilities or age-related limitations, should be able to communicate, express themselves, and connect with the world using technology. HP is committed to increasing accessibility awareness within HP and with our customers and partners. Whether it's large fonts that are easy on the eyes, voice recognition that lets you give your hands a rest, or any other assistive technology to help with your specific situation—a variety of assistive technologies make HP products easier to use. How do you choose?

Assessing your needs

Technology can unleash your potential. Assistive technology removes barriers and helps you create independence at home, at work, and in the community. Assistive technology (AT) helps increase, maintain, and improve the functional capabilities of electronic and information technology.

You can choose from many AT products. Your AT assessment should allow you to evaluate several products, answer your questions, and facilitate your selection of the best solution for your situation. You will find that professionals qualified to do AT assessments come from many fields, including those licensed or certified in physical therapy, occupational therapy, speech/language pathology, and other areas of expertise. Others, while not certified or licensed, can also provide evaluation information. You will want to ask about the individual's experience, expertise, and fees to determine if they are appropriate for your needs.

Accessibility for HP products

The following links provide information about accessibility features and assistive technology, if applicable, included in various HP products. These resources will help you select the specific assistive technology features and product(s) most appropriate for your situation.

- [HP Elite x3—Accessibility Options \(Windows 10 Mobile\)](#)
- [HP PCs—Windows 7 Accessibility Options](#)
- [HP PCs—Windows 8 Accessibility Options](#)
- [HP PC's—Windows 10 Accessibility Options](#)
- [HP Slate 7 Tablets—Enabling Accessibility Features on Your HP Tablet \(Android 4.1/Jelly Bean\)](#)
- [HP SlateBook PCs—Enabling Accessibility Features \(Android 4.3, 4.2/Jelly Bean\)](#)
- [HP Chromebook PCs—Enabling Accessibility Features on Your HP Chromebook or Chromebox \(Chrome OS\)](#)
- [HP Shopping—peripherals for HP products](#)

If you need additional support with the accessibility features on your HP product, see [Contacting support on page 30](#).

Additional links to external partners and suppliers that may provide additional assistance:

- [Microsoft Accessibility information \(Windows 7, Windows 8, Windows 10, Microsoft Office\)](#)
- [Google Products accessibility information \(Android, Chrome, Google Apps\)](#)

- [Assistive Technologies sorted by impairment type](#)
- [Assistive Technologies sorted by product type](#)
- [Assistive Technology vendors with product descriptions](#)
- [Assistive Technology Industry Association \(ATIA\)](#)

Standards and legislation

Standards

Section 508 of the Federal Acquisition Regulation (FAR) standards was created by the US Access Board to address access to information and communication technology (ICT) for people with physical, sensory, or cognitive disabilities. The standards contain technical criteria specific to various types of technologies, as well as performance-based requirements which focus on functional capabilities of covered products. Specific criteria cover software applications and operating systems, web-based information and applications, computers, telecommunications products, video and multimedia, and self-contained closed products.

Mandate 376 – EN 301 549

The EN 301 549 standard was created by the European Union within Mandate 376 as the basis for an online toolkit for public procurement of ICT products. The standard specifies the functional accessibility requirements applicable to ICT products and services, together with a description of the test procedures and evaluation methodology for each accessibility requirement.

Web Content Accessibility Guidelines (WCAG)

Web Content Accessibility Guidelines (WCAG) from the W3C's Web Accessibility Initiative (WAI) helps web designers and developers create sites that better meet the needs of people with disabilities or age-related limitations. WCAG advances accessibility across the full range of web content (text, images, audio, and video) and web applications. WCAG can be precisely tested, is easy to understand and use, and allows web developers flexibility for innovation. WCAG 2.0 has also been approved as [ISO/IEC 40500:2012](#).

WCAG specifically addresses barriers to accessing the web experienced by people with visual, auditory, physical, cognitive, and neurological disabilities, and by older web users with accessibility needs. WCAG 2.0 provides characteristics of accessible content:

- **Perceivable** (for instance, by addressing text alternatives for images, captions for audio, adaptability of presentation, and color contrast)
- **Operable** (by addressing keyboard access, color contrast, timing of input, seizure avoidance, and navigability)
- **Understandable** (by addressing readability, predictability, and input assistance)
- **Robust** (for instance, by addressing compatibility with assistive technologies)

Legislation and regulations

Accessibility of IT and information has become an area of increasing legislative importance. The links listed below provide information about key legislation, regulations, and standards.

- [United States](#)
- [Canada](#)
- [Europe](#)

- [United Kingdom](#)
- [Australia](#)
- [Worldwide](#)

Useful accessibility resources and links

The following organizations might be good resources for information about disabilities and age-related limitations.



NOTE: This is not an exhaustive list. These organizations are provided for informational purposes only. HP assumes no responsibility for information or contacts you encounter on the Internet. Listing on this page does not imply endorsement by HP.

Organizations

- American Association of People with Disabilities (AAPD)
- The Association of Assistive Technology Act Programs (ATAP)
- Hearing Loss Association of America (HLAA)
- Information Technology Technical Assistance and Training Center (ITTATC)
- Lighthouse International
- National Association of the Deaf
- National Federation of the Blind
- Rehabilitation Engineering & Assistive Technology Society of North America (RESNA)
- Telecommunications for the Deaf and Hard of Hearing, Inc. (TDI)
- W3C Web Accessibility Initiative (WAI)

Educational institutions

- California State University, Northridge, Center on Disabilities (CSUN)
- University of Wisconsin - Madison, Trace Center
- University of Minnesota computer accommodations program

Other disability resources

- ADA (Americans with Disabilities Act) Technical Assistance Program
- ILO Global Business and Disability network
- EnableMart
- European Disability Forum
- Job Accommodation Network
- Microsoft Enable

HP links

[Our contact webform](#)

[HP comfort and safety guide](#)

[HP public sector sales](#)

Contacting support



NOTE: Support is in English only.

- Customers who are deaf or hard of hearing who have questions about technical support or accessibility of HP products:
 - Use TRS/VRS/WebCapTel to call (877) 656-7058 Monday through Friday, 6 a.m. to 9 p.m. Mountain Time.
- Customers with other disabilities or age-related limitations who have questions about technical support or accessibility of HP products, choose one of the following options:
 - Call (888) 259-5707 Monday through Friday, 6 a.m. to 9 p.m. Mountain Time.
 - Complete the [Contact form for people with disabilities or age-related limitations](#).