

# Interactive Part Locator

## HP Spectre x360 13-aw000 Convertible PC

Welcome to the interactive part locator for the  
HP Spectre x360 13-aw000 Convertible PC

### Here's how to use it...

[External Views](#) (Click the link to navigate to the views)

On this page you will find a thumbnail viewer with a menu of this product's external views. To view a specific view in greater detail, simply click that view.

[Parts List](#) (Click the link to navigate to the parts)

On this page, you will find a list of all of the replaceable parts for this product. To view a specific part and its location in the product, click the part name in the list.

**That's it! On every page there is a link that brings you back to either the External Views or the Parts List, enabling you to navigate to whatever view or part you wish to review.**

# External Views

[Back to Welcome page](#)



Front



Left



Right



Rear



Display



Top



Bottom



Internal

[Go to Parts List](#)

# Front View

[Back to External Views](#)



[Go to Parts List](#)

# Left View

[Back to External Views](#)

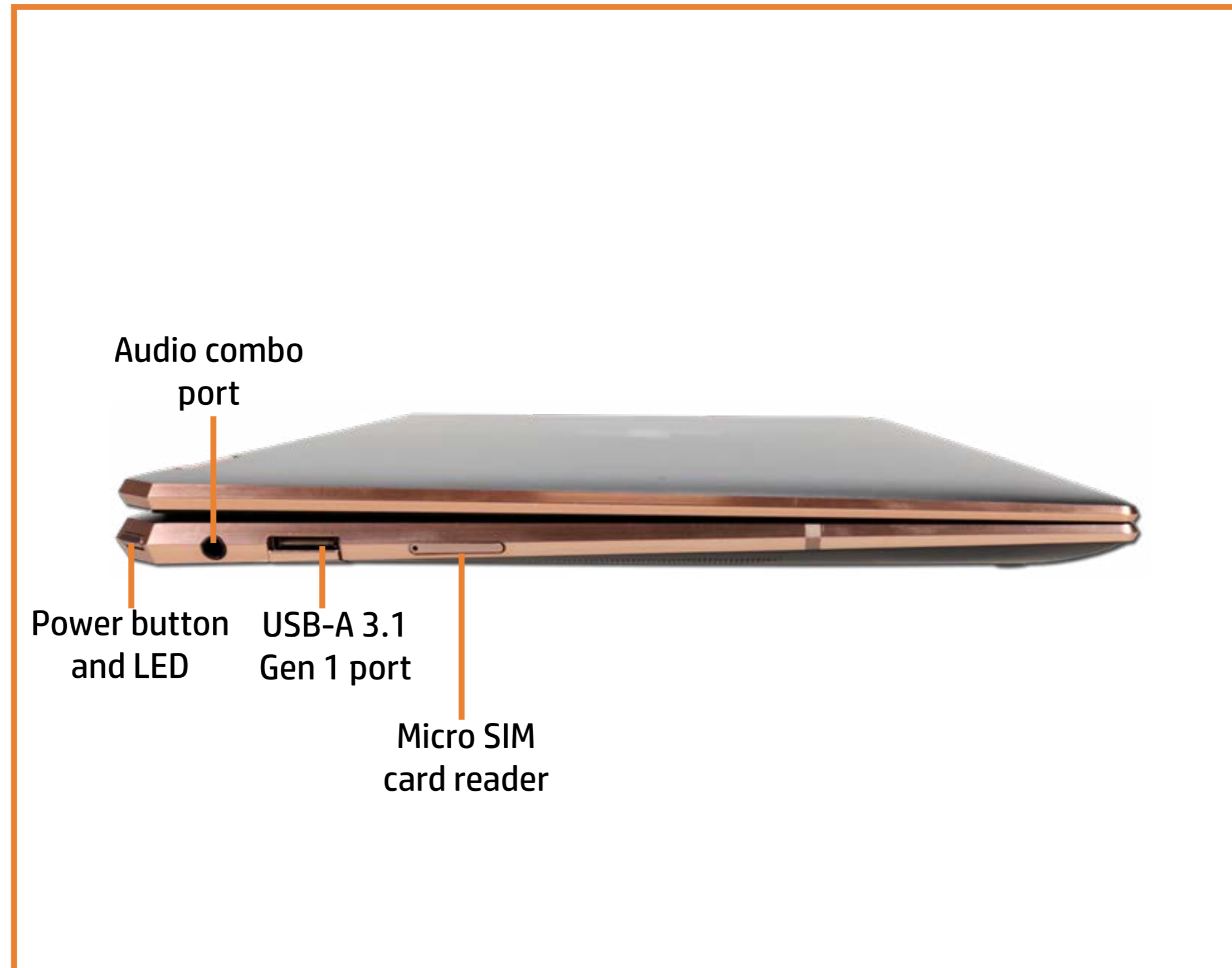

[Go to Parts List](#)

# Right View

[Back to External Views](#)

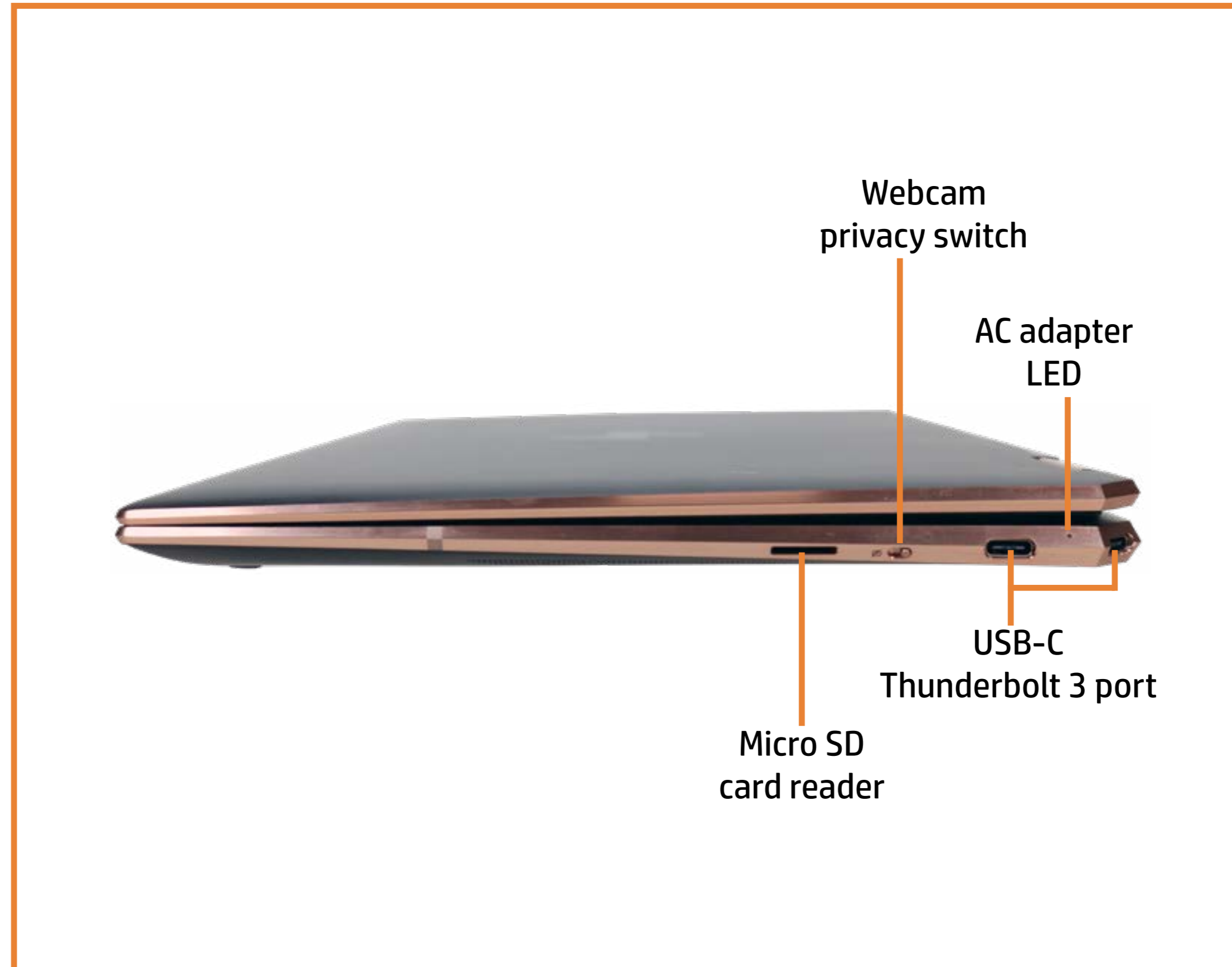

[Go to Parts List](#)

# Rear View

[Back to External Views](#)

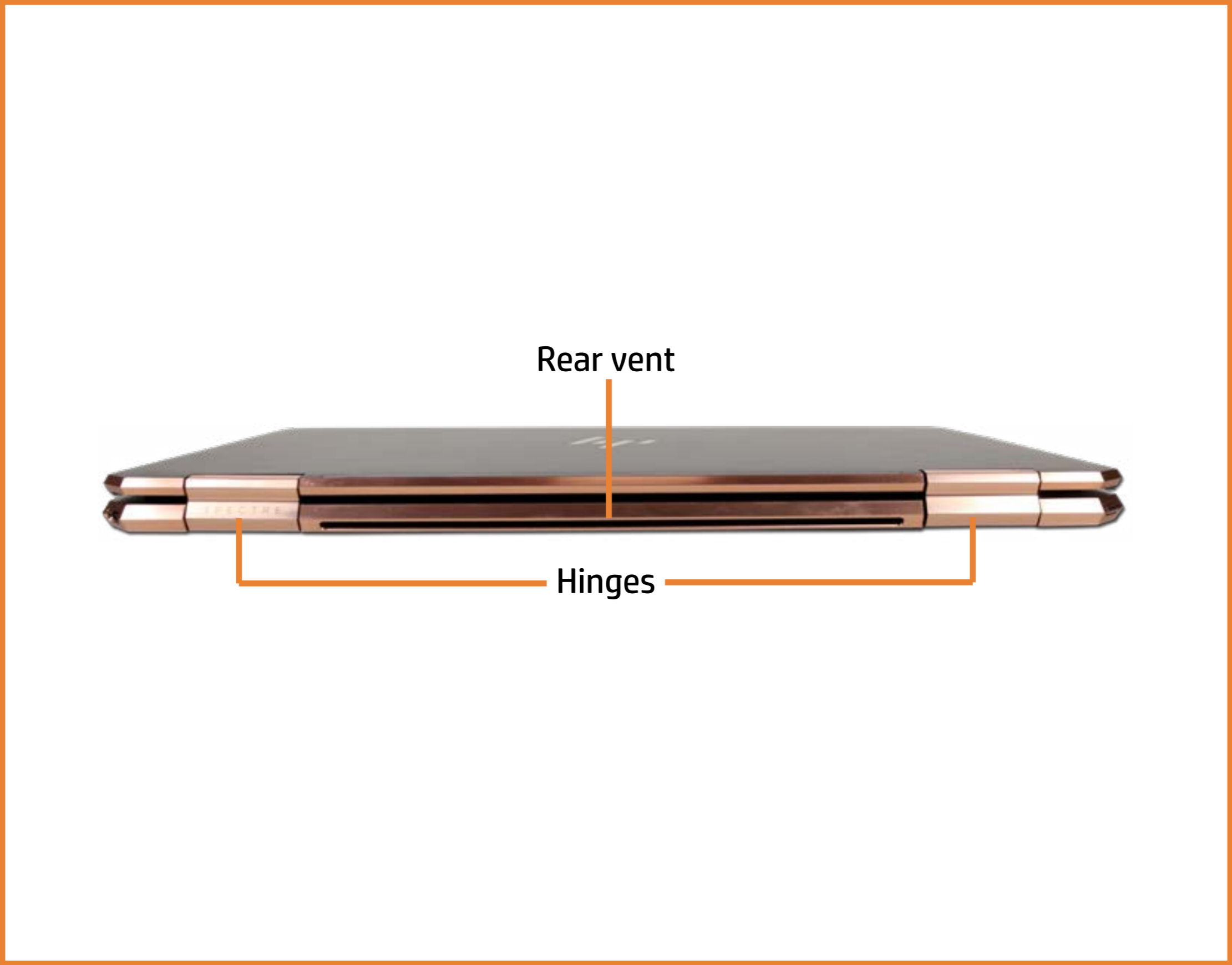

[Go to Parts List](#)

# Display View

[Back to External Views](#)

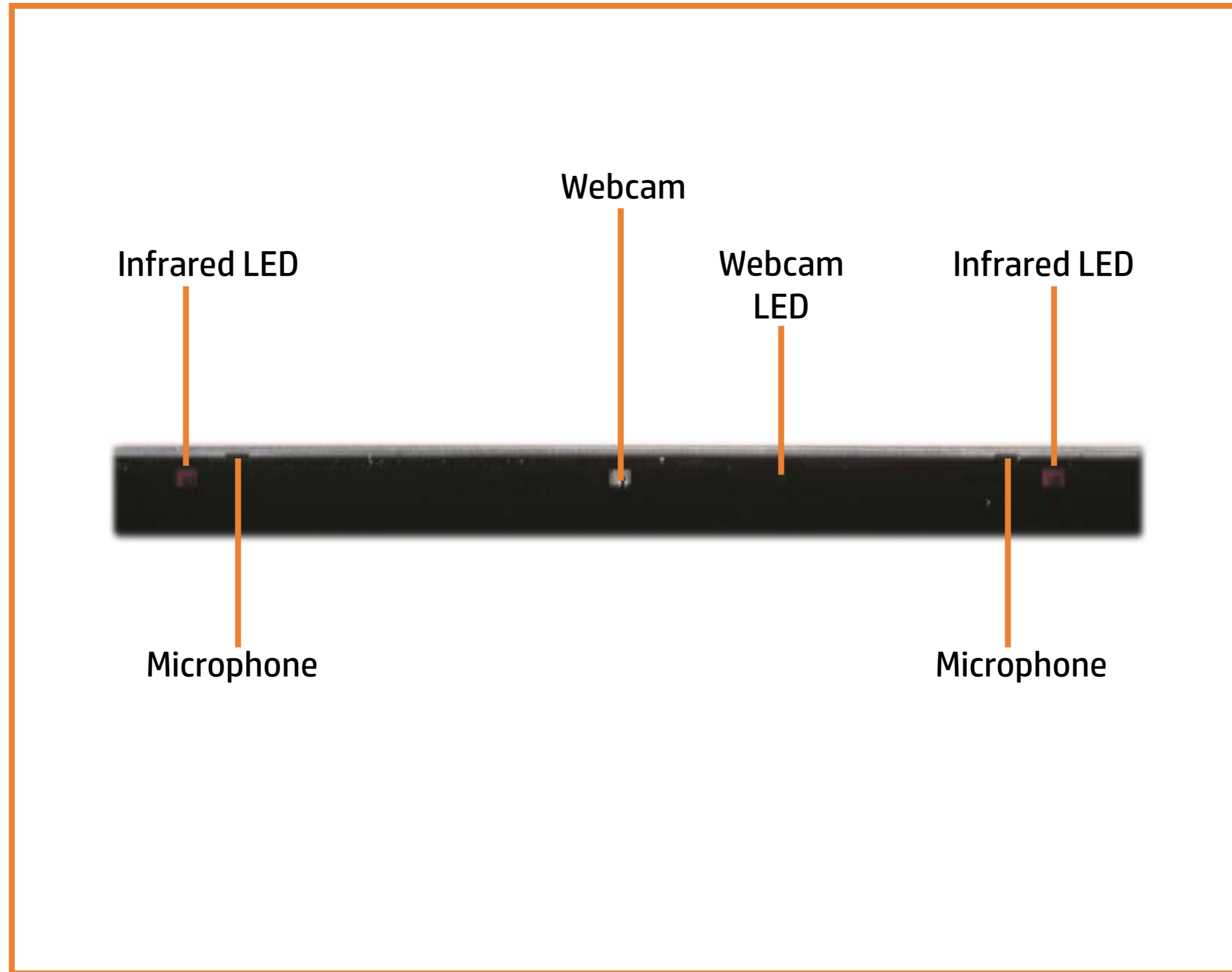

[Go to Parts List](#)

# Top View

[Back to External Views](#)

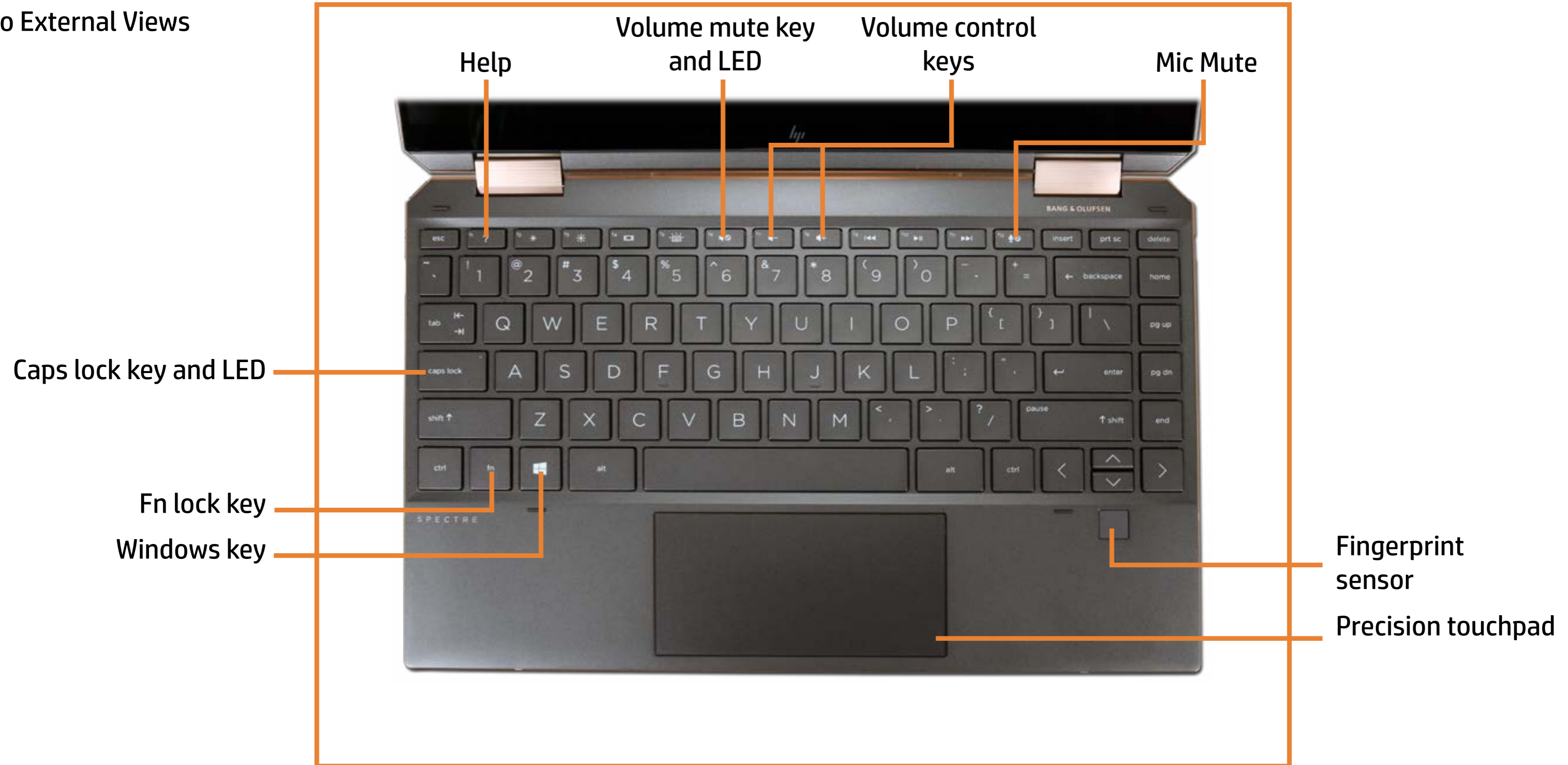

[Go to Parts List](#)



# Bottom View

[Back to External Views](#)

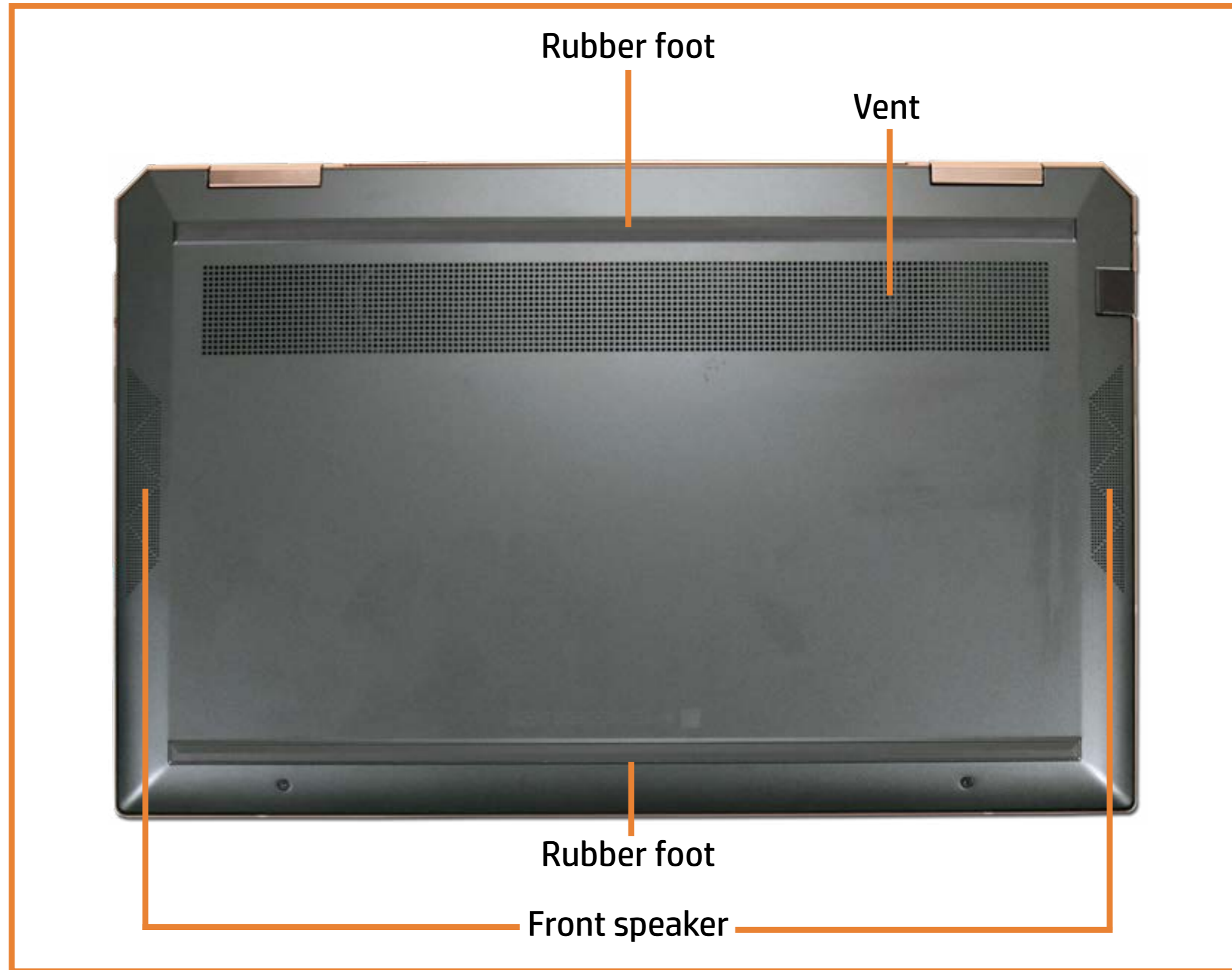

[Go to Parts List](#)

# Internal View

[Back to External Views](#)

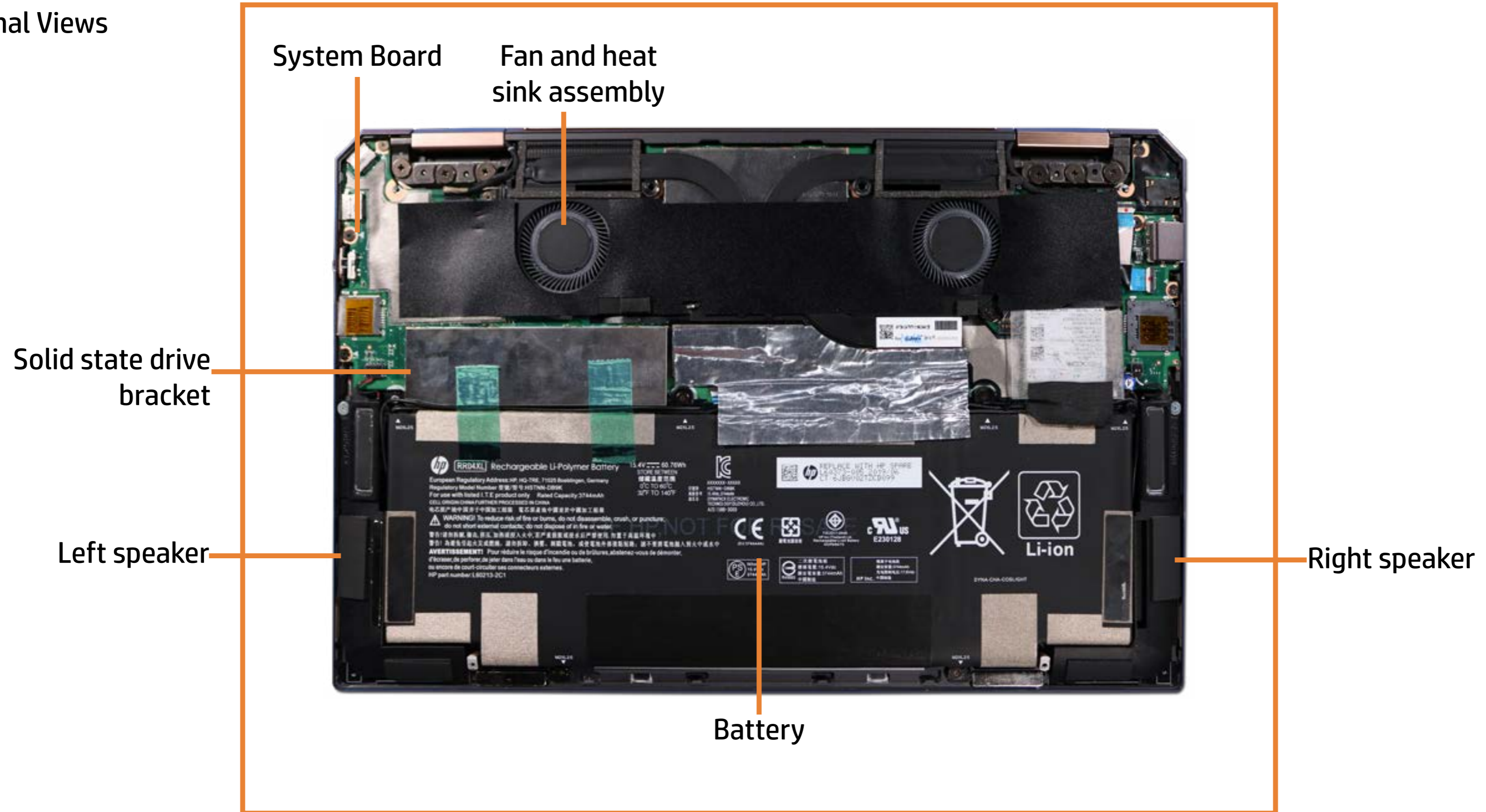

[Go to Parts List](#)

# Base Enclosure

## Base Enclosure

- Battery
- Wireless WAN Module
- Wireless WAN SIM Card slot
- M.2 Solid State Drive Module
- M.2 Solid State Drive Bracket
- Left Speaker
- Right Speaker
- Fingerprint Reader Module
- Fingerprint Reader Bracket
- Touchpad Module
- Audio and Power Button Board
- Wireless WAN Antennas
- Fan and Heat Sink Assembly
- System board (top)
- System board (bottom)
- IR Sensor Board
- Display Panel Assembly
- Keyboard
- Support Brackets
- Top Cover



[Go to External Views](#)



# Battery

Base Enclosure

**Battery**

Wireless WAN Module

Wireless WAN SIM Card slot

M.2 Solid State Drive Module

M.2 Solid State Drive Bracket

Left Speaker

Right Speaker

Fingerprint Reader Module

Fingerprint Reader Bracket

Touchpad Module

Audio and Power Button Board

Wireless WAN Antennas

Fan and Heat Sink Assembly

System board (top)

System board (bottom)

IR Sensor Board

Display Panel Assembly

Keyboard

Support Brackets

Top Cover



[Go to External Views](#)



# Wireless WAN Module

Base Enclosure

Battery

**Wireless WAN Module**

Wireless WAN SIM Card slot

M.2 Solid State Drive Module

M.2 Solid State Drive Bracket

Left Speaker

Right Speaker

Fingerprint Reader Module

Fingerprint Reader Bracket

Touchpad Module

Audio and Power Button Board

Wireless WAN Antennas

Fan and Heat Sink Assembly

System board (top)

System board (bottom)

IR Sensor Board

Display Panel Assembly

Keyboard

Support Brackets

Top Cover

Go to External Views

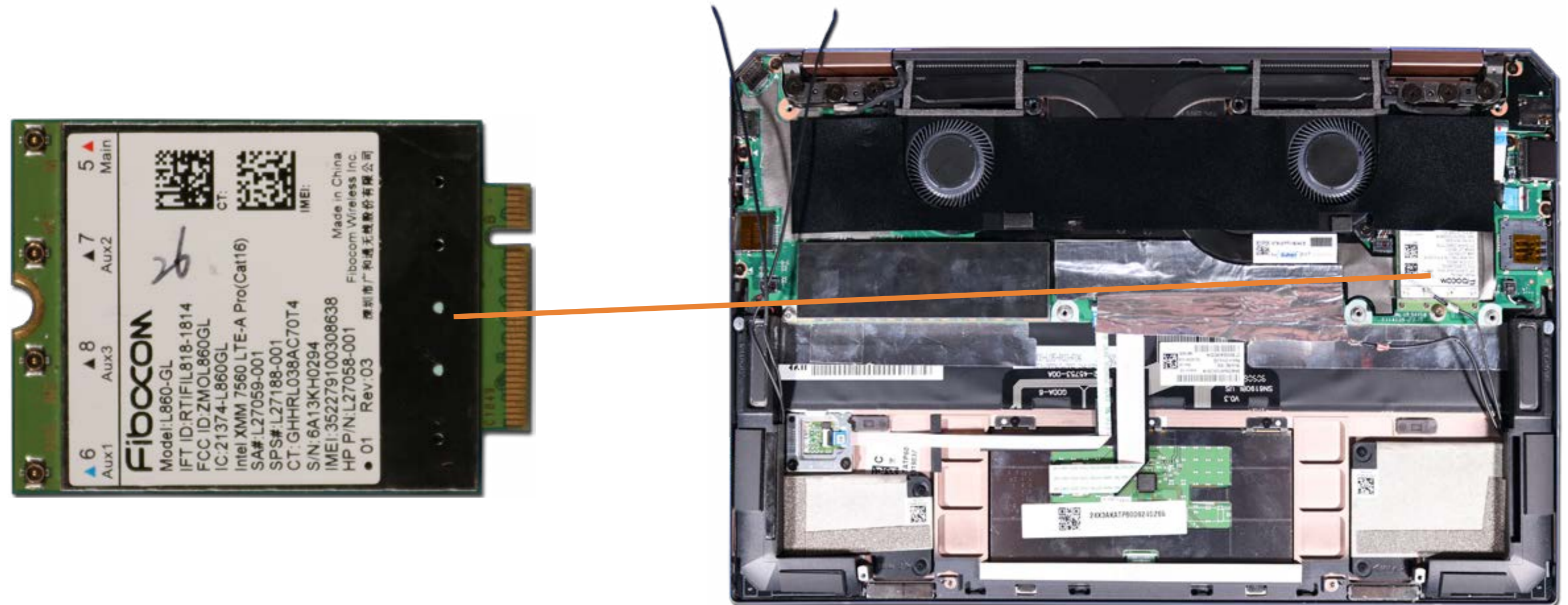



# Wireless WAN SIM Card

Base Enclosure

Battery

Wireless WAN Module

**Wireless WAN SIM Card slot**

M.2 Solid State Drive Module

M.2 Solid State Drive Bracket

Left Speaker

Right Speaker

Fingerprint Reader Module

Fingerprint Reader Bracket

Touchpad Module

Audio and Power Button Board

Wireless WAN Antennas

Fan and Heat Sink Assembly

System board (top)

System board (bottom)

IR Sensor Board

Display Panel Assembly

Keyboard

Support Brackets

Top Cover

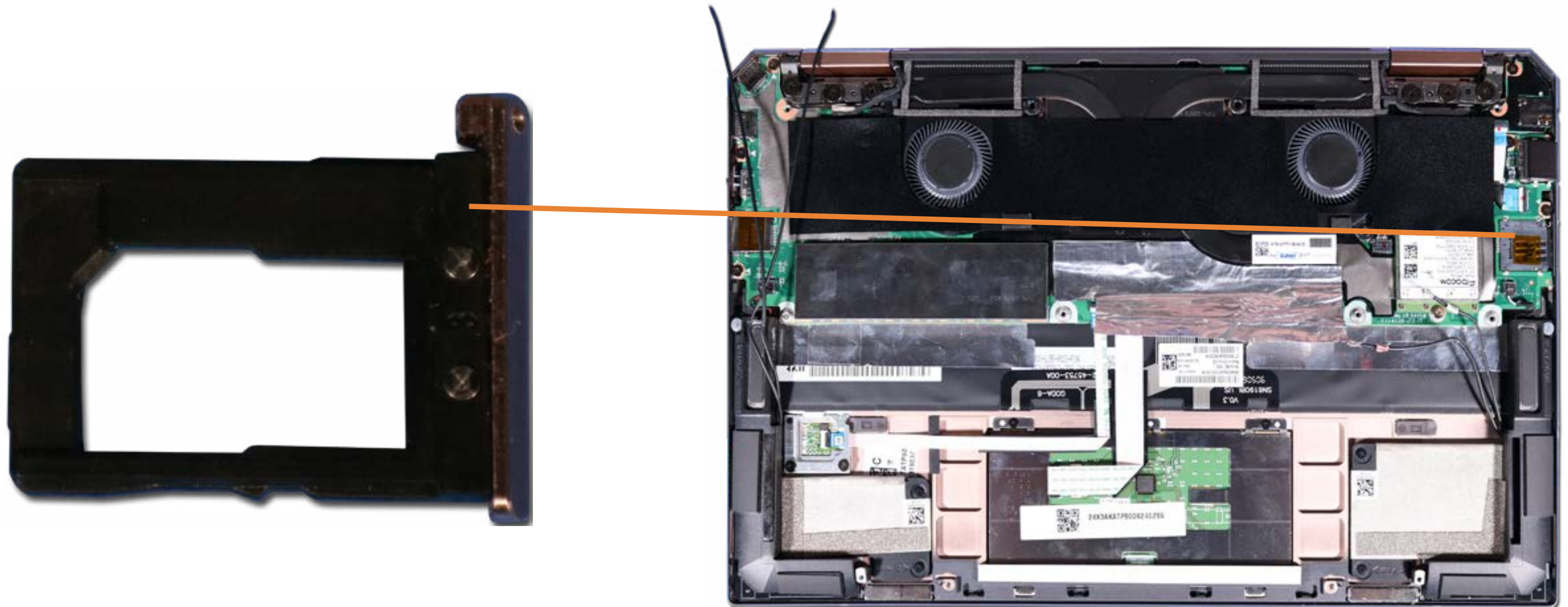

[Go to External Views](#)



# M.2 Solid State Drive Module

Base Enclosure

Battery

Wireless WAN Module

Wireless WAN SIM Card slot

M.2 Solid State Drive Module

M.2 Solid State Drive Bracket

Left Speaker

Right Speaker

Fingerprint Reader Module

Fingerprint Reader Bracket

Touchpad Module

Audio and Power Button Board

Wireless WAN Antennas

Fan and Heat Sink Assembly

System board (top)

System board (bottom)

IR Sensor Board

Display Panel Assembly

Keyboard

Support Brackets

Top Cover

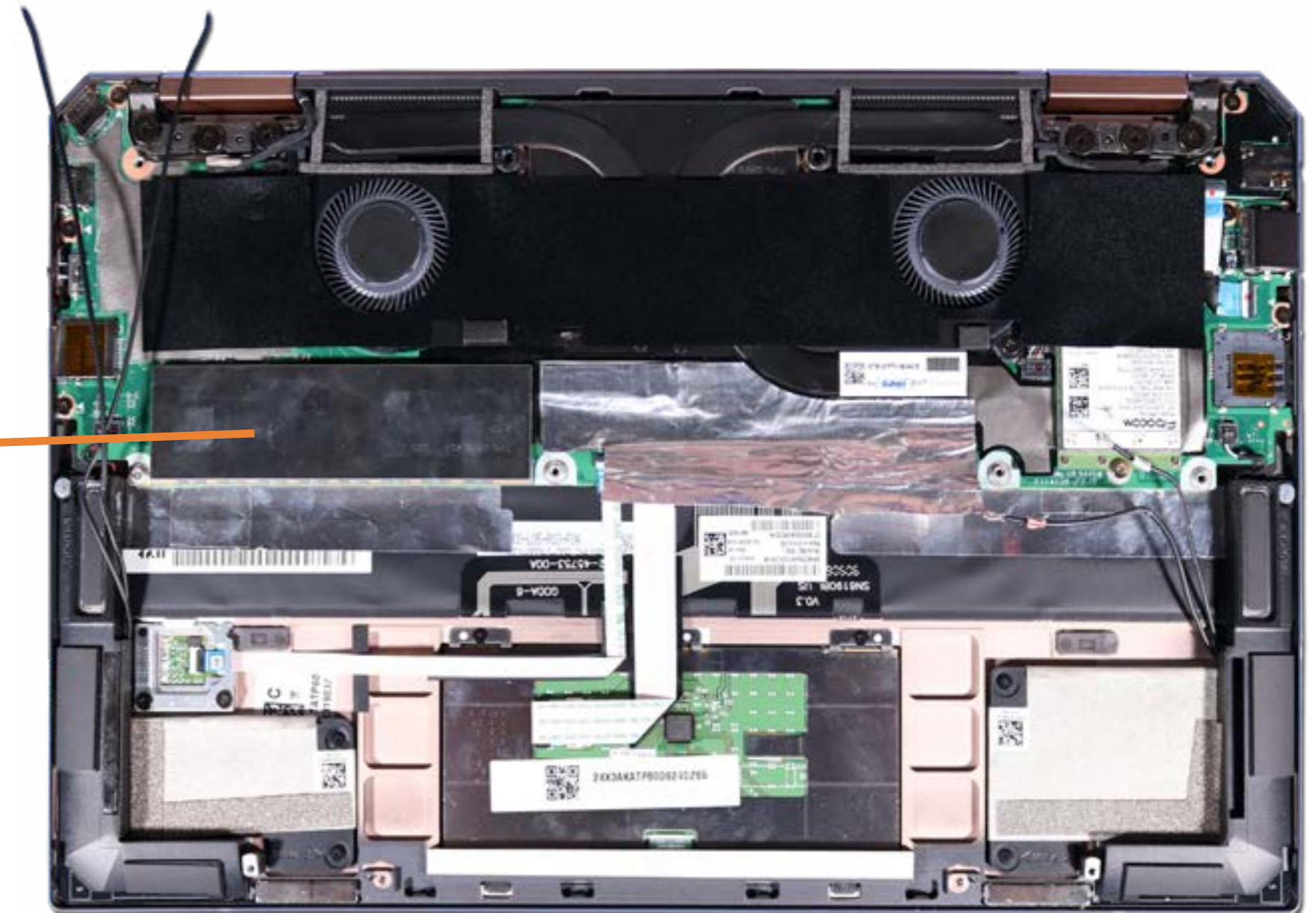

[Go to External Views](#)



# M.2 Solid State Drive Bracket

Base Enclosure

Battery

Wireless WAN Module

Wireless WAN SIM Card slot

M.2 Solid State Drive Module

**M.2 Solid State Drive Bracket**

Left Speaker

Right Speaker

Fingerprint Reader Module

Fingerprint Reader Bracket

Touchpad Module

Audio and Power Button Board

Wireless WAN Antennas

Fan and Heat Sink Assembly

System board (top)

System board (bottom)

IR Sensor Board

Display Panel Assembly

Keyboard

Support Brackets

Top Cover

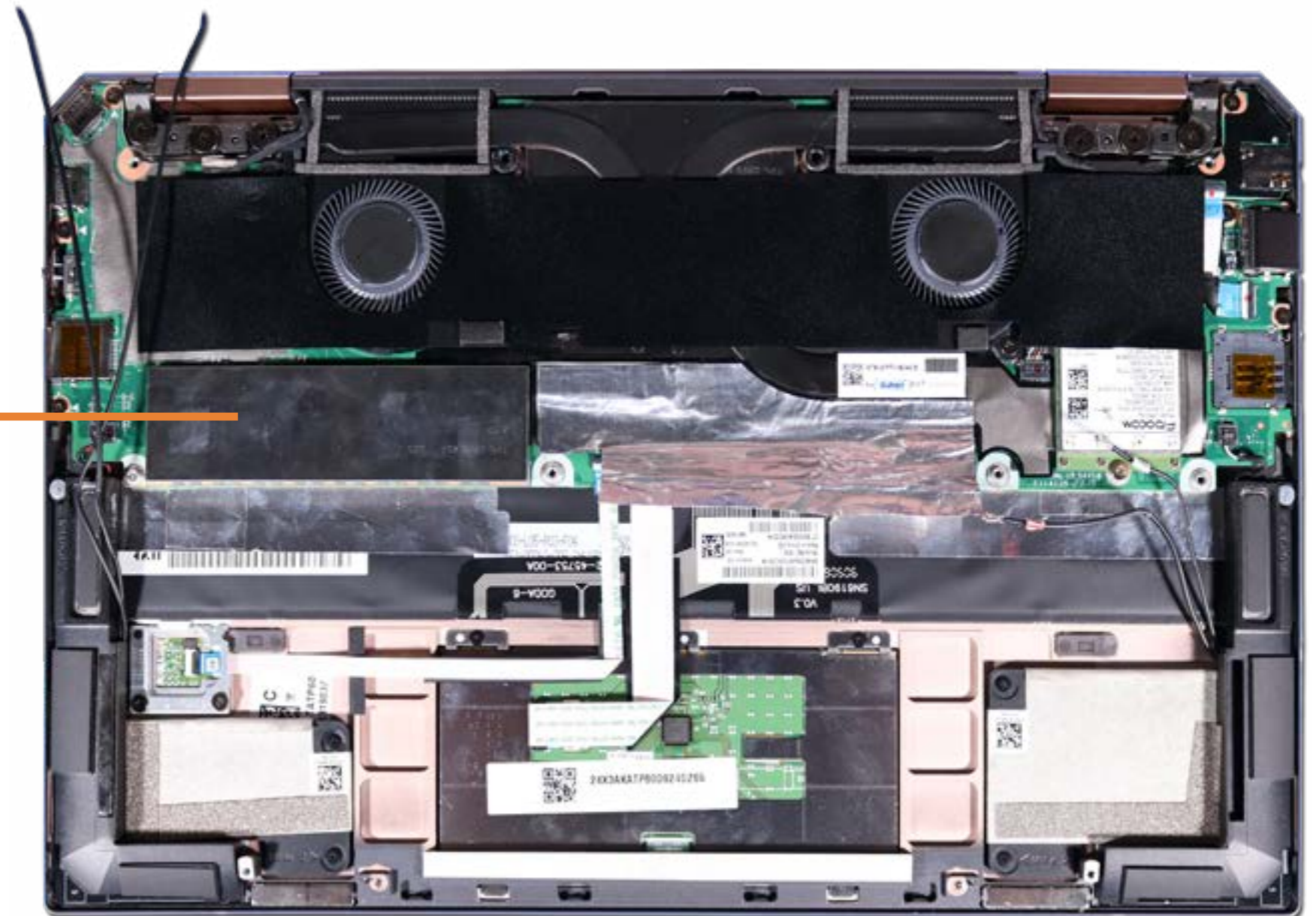

[Go to External Views](#)



# Left Speaker

Base Enclosure

Battery

Wireless WAN Module

Wireless WAN SIM Card slot

M.2 Solid State Drive Module

M.2 Solid State Drive Bracket

**Left Speaker**

Right Speaker

Fingerprint Reader Module

Fingerprint Reader Bracket

Touchpad Module

Audio and Power Button Board

Wireless WAN Antennas

Fan and Heat Sink Assembly

System board (top)

System board (bottom)

IR Sensor Board

Display Panel Assembly

Keyboard

Support Brackets

Top Cover

[Go to External Views](#)

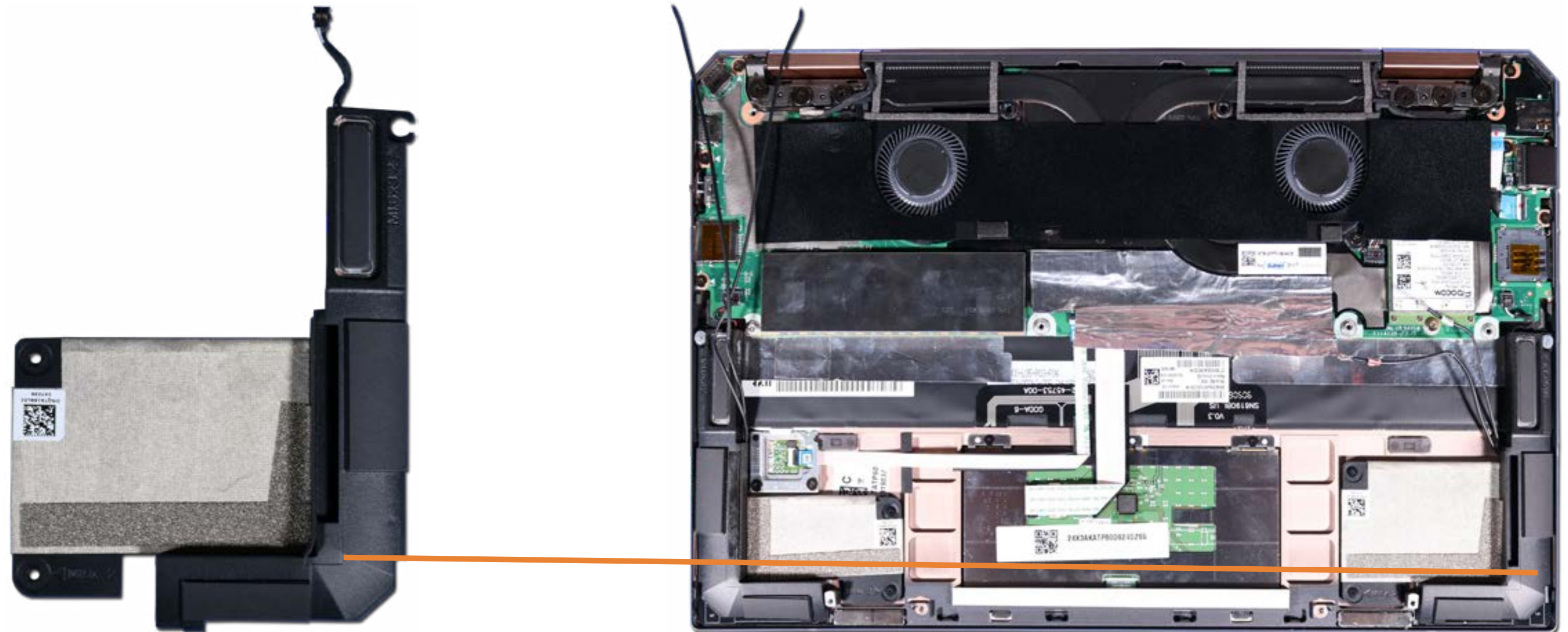



# Right Speaker

Base Enclosure

Battery

Wireless WAN Module

Wireless WAN SIM Card slot

M.2 Solid State Drive Module

M.2 Solid State Drive Bracket

Left Speaker

**Right Speaker**

Fingerprint Reader Module

Fingerprint Reader Bracket

Touchpad Module

Audio and Power Button Board

Wireless WAN Antennas

Fan and Heat Sink Assembly

System board (top)

System board (bottom)

IR Sensor Board

Display Panel Assembly

Keyboard

Support Brackets

Top Cover

[Go to External Views](#)

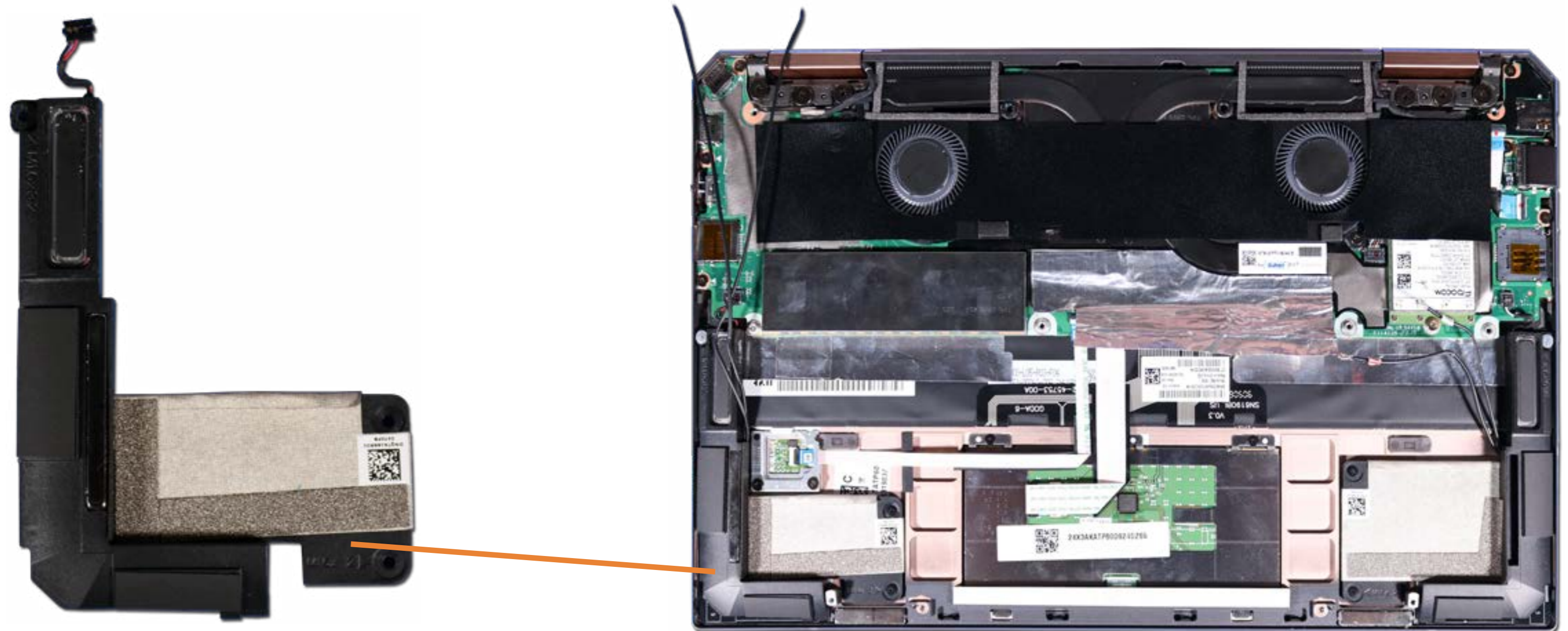



# Fingerprint Reader Module

Base Enclosure

Battery

Wireless WAN Module

Wireless WAN SIM Card slot

M.2 Solid State Drive Module

M.2 Solid State Drive Bracket

Left Speaker

Right Speaker

**Fingerprint Reader Module**

Fingerprint Reader Bracket

Touchpad Module

Audio and Power Button Board

Wireless WAN Antennas

Fan and Heat Sink Assembly

System board (top)

System board (bottom)

IR Sensor Board

Display Panel Assembly

Keyboard

Support Brackets

Top Cover

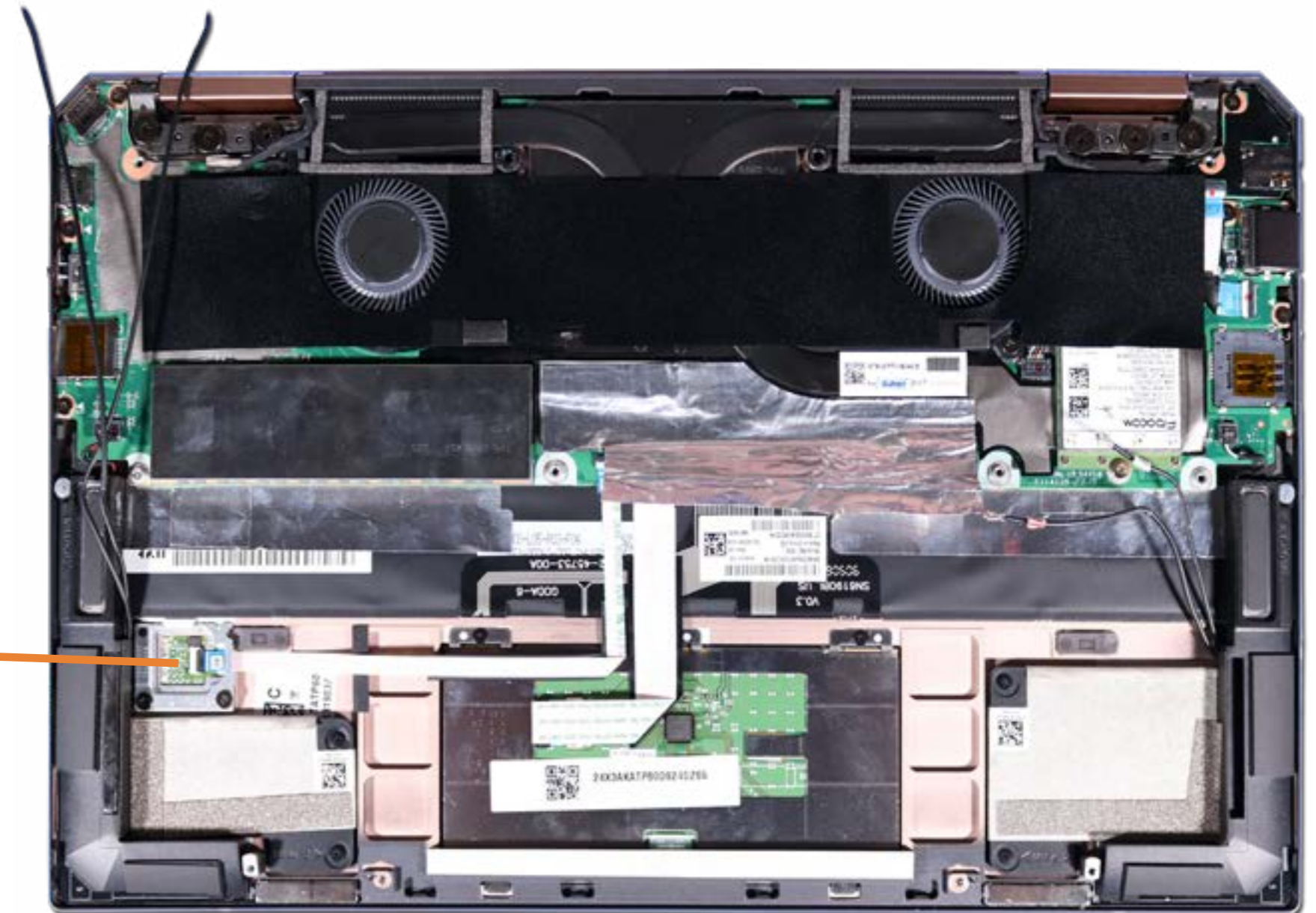
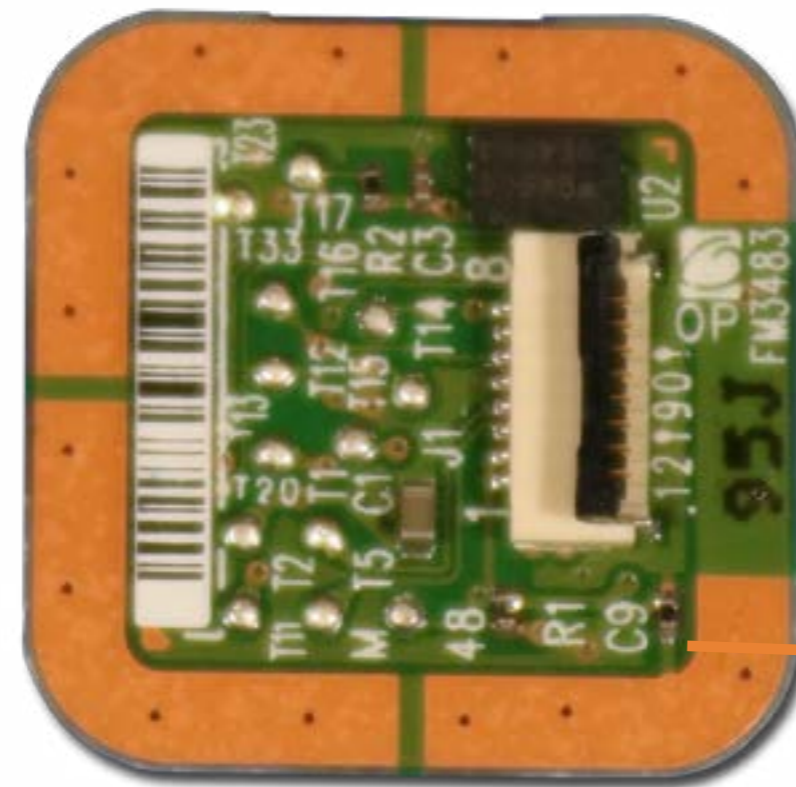

[Go to External Views](#)



# Fingerprint Reader Bracket

Base Enclosure

Battery

Wireless WAN Module

Wireless WAN SIM Card slot

M.2 Solid State Drive Module

M.2 Solid State Drive Bracket

Left Speaker

Right Speaker

Fingerprint Reader Module

**Fingerprint Reader Bracket**

Touchpad Module

Audio and Power Button Board

Wireless WAN Antennas

Fan and Heat Sink Assembly

System board (top)

System board (bottom)

IR Sensor Board

Display Panel Assembly

Keyboard

Support Brackets

Top Cover

[Go to External Views](#)

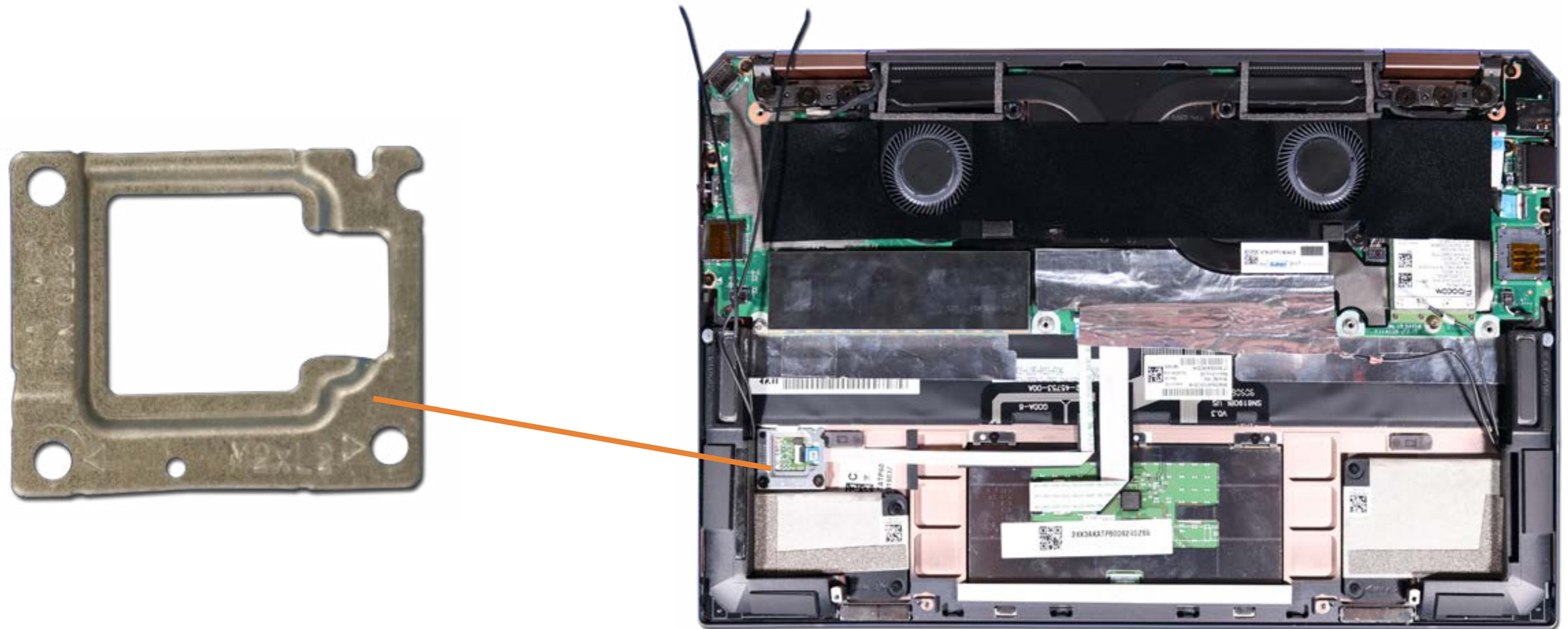



# Touchpad Module

Base Enclosure

Battery

Wireless WAN Module

Wireless WAN SIM Card slot

M.2 Solid State Drive Module

M.2 Solid State Drive Bracket

Left Speaker

Right Speaker

Fingerprint Reader Module

Fingerprint Reader Bracket

**Touchpad Module**

Audio and Power Button Board

Wireless WAN Antennas

Fan and Heat Sink Assembly

System board (top)

System board (bottom)

IR Sensor Board

Display Panel Assembly

Keyboard

Support Brackets

Top Cover

Go to External Views

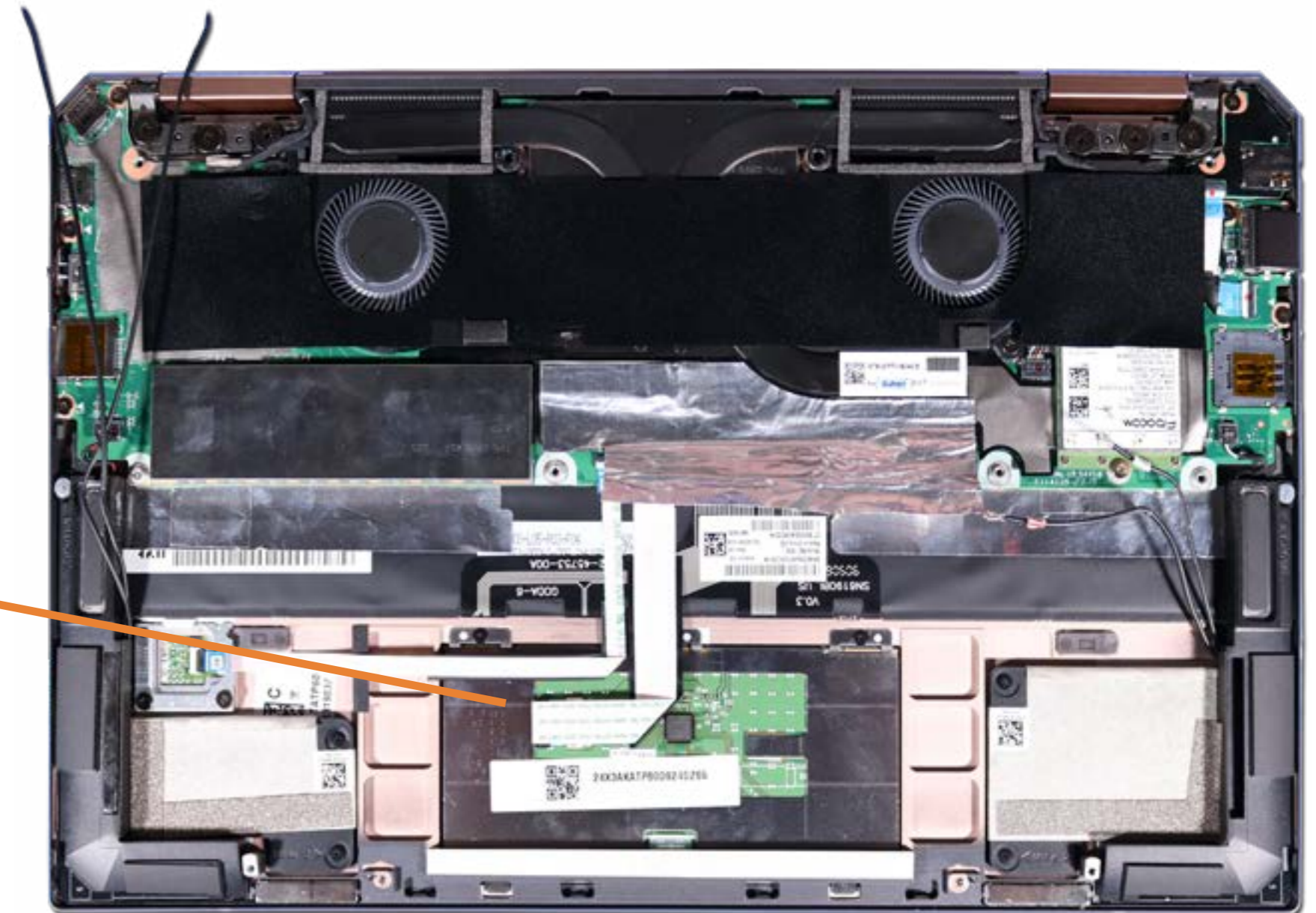



# Audio and Power Button

Base Enclosure

Battery

Wireless WAN Module

Wireless WAN SIM Card slot

M.2 Solid State Drive Module

M.2 Solid State Drive Bracket

Left Speaker

Right Speaker

Fingerprint Reader Module

Fingerprint Reader Bracket

Touchpad Module

**Audio and Power Button Board**

Wireless WAN Antennas

Fan and Heat Sink Assembly

System board (top)

System board (bottom)

IR Sensor Board

Display Panel Assembly

Keyboard

Support Brackets

Top Cover

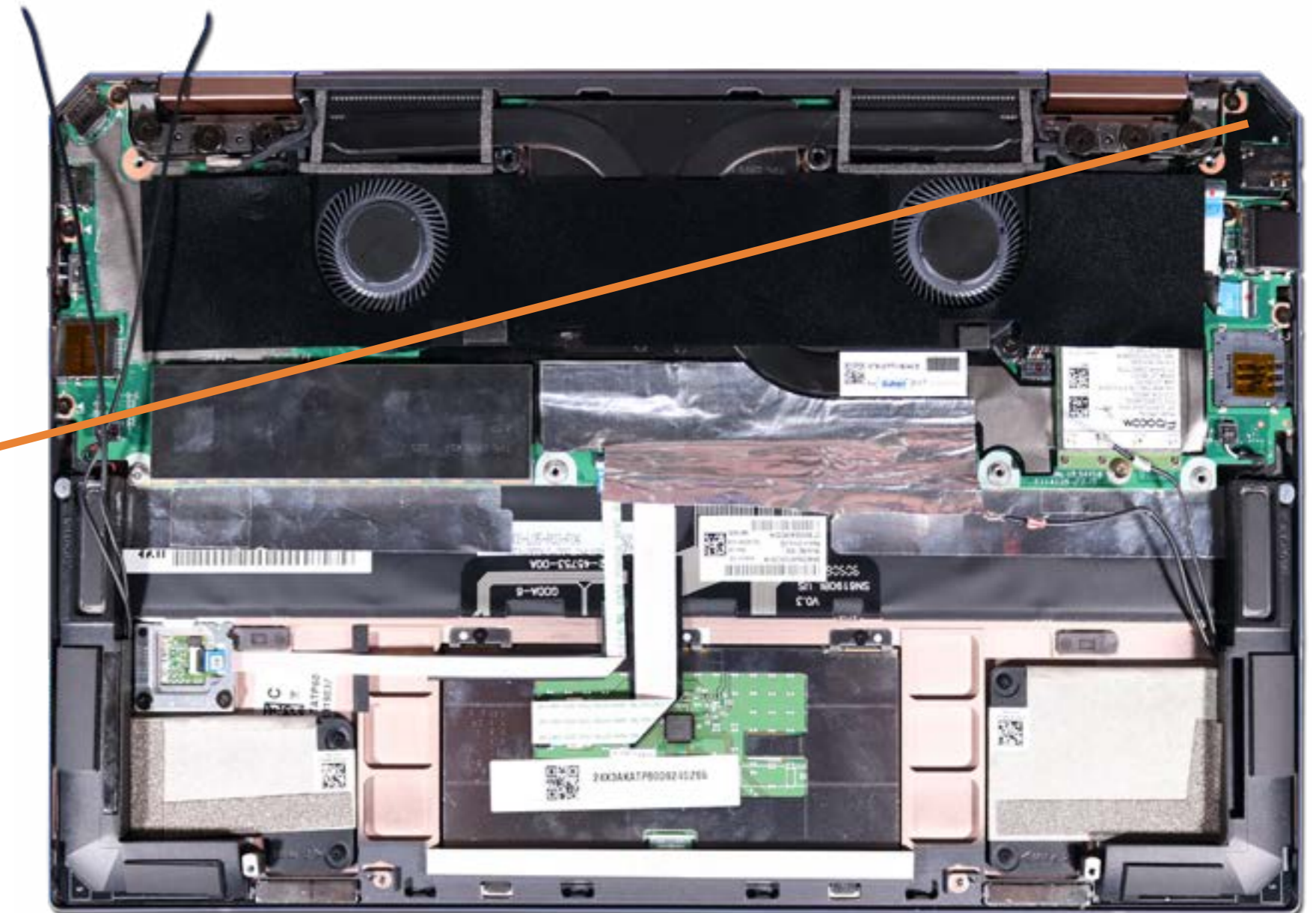
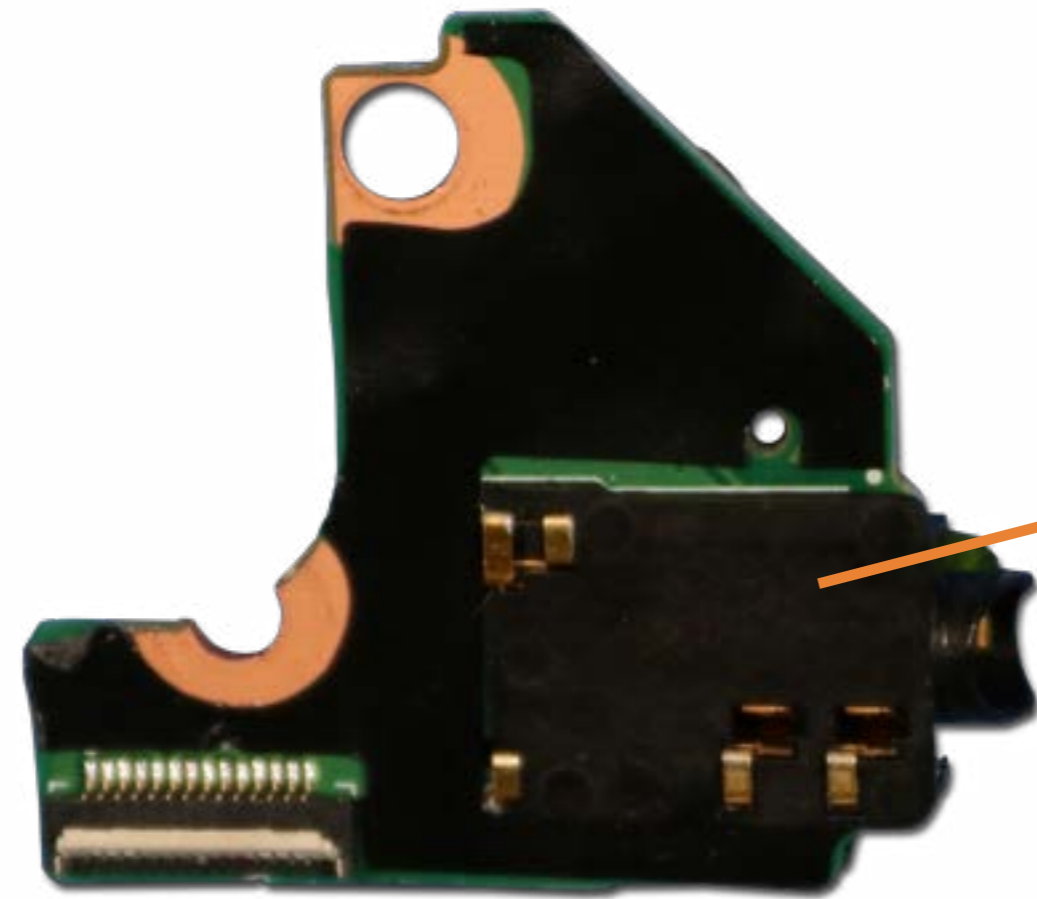

[Go to External Views](#)



# Wireless WAN Antennas

Base Enclosure

Battery

Wireless WAN Module

Wireless WAN SIM Card slot

M.2 Solid State Drive Module

M.2 Solid State Drive Bracket

Left Speaker

Right Speaker

Fingerprint Reader Module

Fingerprint Reader Bracket

Touchpad Module

Audio and Power Button Board

**Wireless WAN Antennas**

Fan and Heat Sink Assembly

System board (top)

System board (bottom)

IR Sensor Board

Display Panel Assembly

Keyboard

Support Brackets

Top Cover

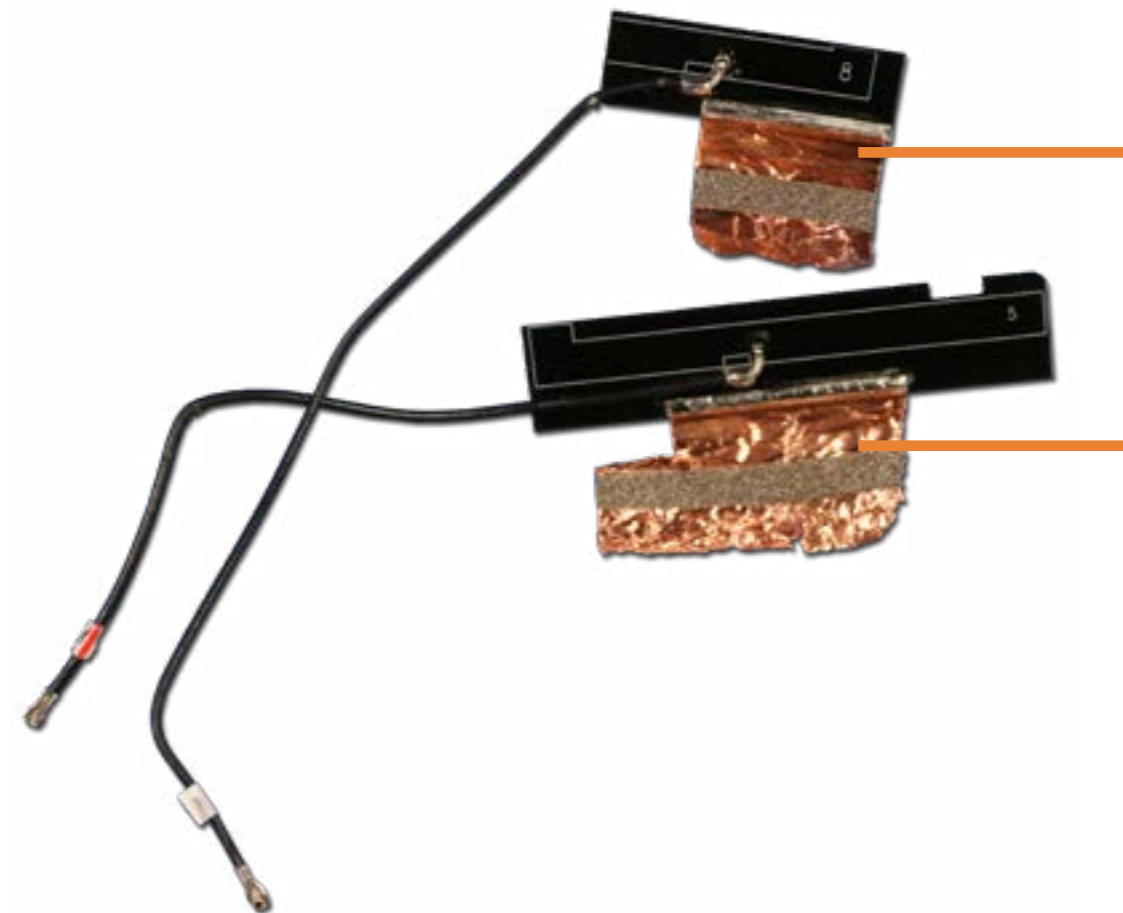

[Go to External Views](#)



# Fan and Heat Sink Assembly

Base Enclosure

Battery

Wireless WAN Module

Wireless WAN SIM Card slot

M.2 Solid State Drive Module

M.2 Solid State Drive Bracket

Left Speaker

Right Speaker

Fingerprint Reader Module

Fingerprint Reader Bracket

Touchpad Module

Audio and Power Button Board

Wireless WAN Antennas

**Fan and Heat Sink Assembly**

System board (top)

System board (bottom)

IR Sensor Board

Display Panel Assembly

Keyboard

Support Brackets

Top Cover

[Go to External Views](#)

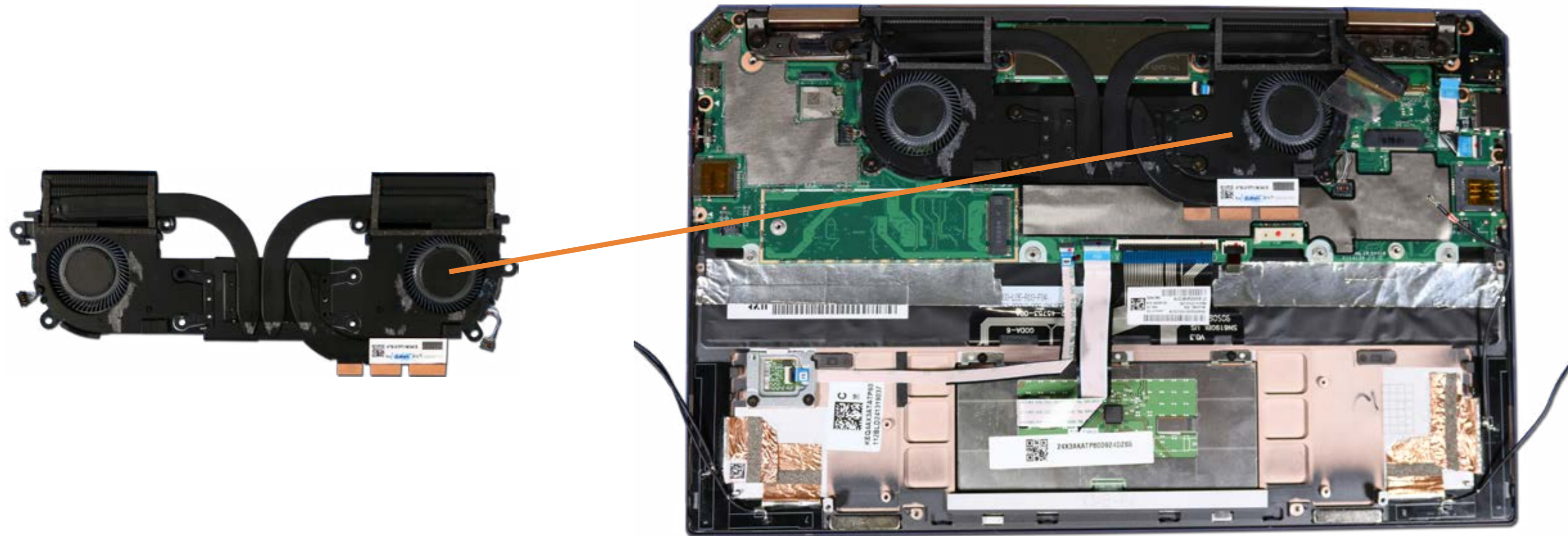



# System board (top)

Base Enclosure

Battery

Wireless WAN Module

Wireless WAN SIM Card slot

M.2 Solid State Drive Module

M.2 Solid State Drive Bracket

Left Speaker

Right Speaker

Fingerprint Reader Module

Fingerprint Reader Bracket

Touchpad Module

Audio and Power Button Board

Wireless WAN Antennas

Fan and Heat Sink Assembly

**System board (top)**

System board (bottom)

IR Sensor Board

Display Panel Assembly

Keyboard

Support Brackets

Top Cover

Go to External Views

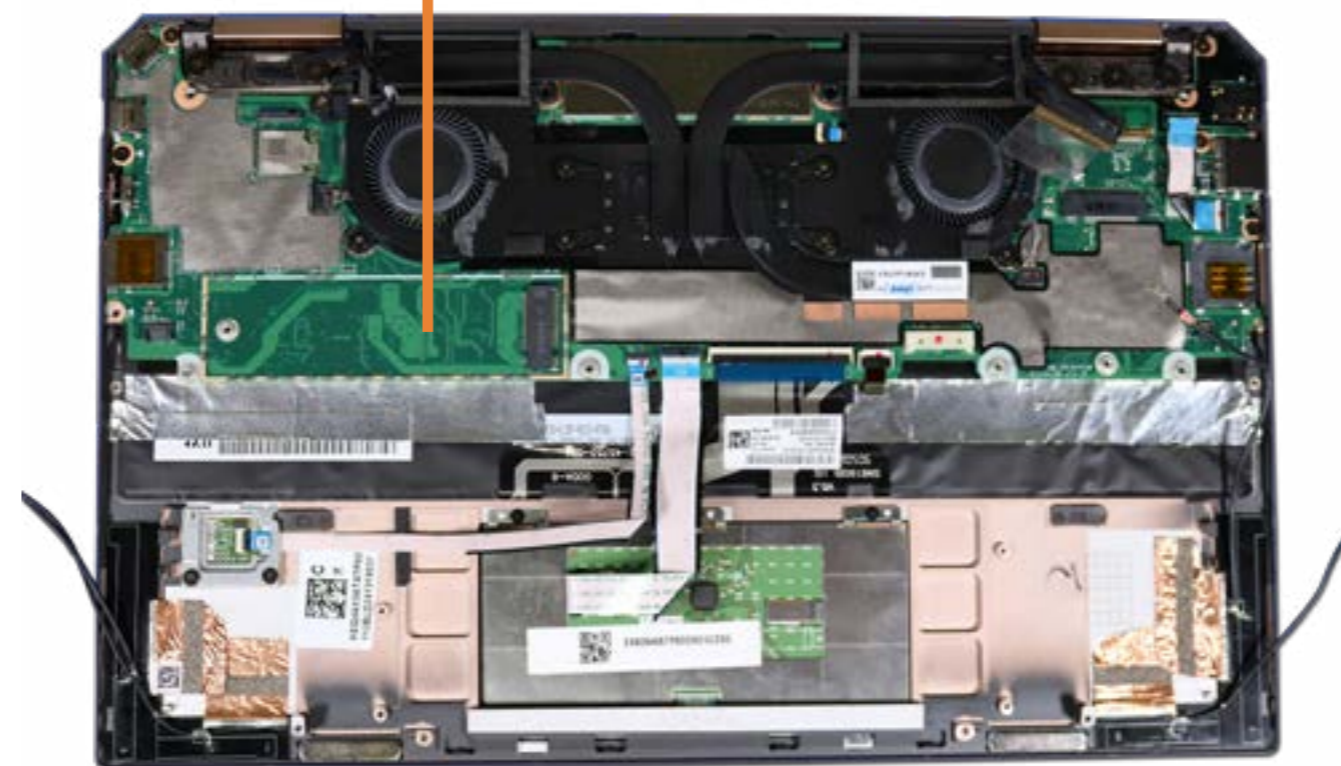
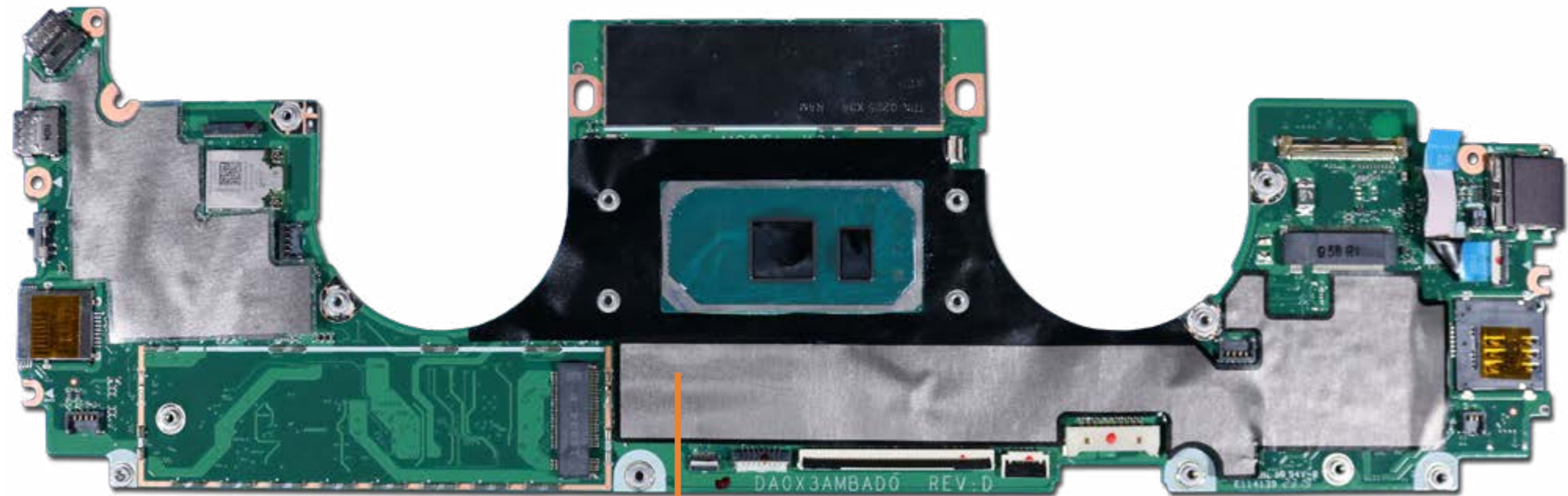



# System board (bottom)

Base Enclosure

Battery

Wireless WAN Module

Wireless WAN SIM Card slot

M.2 Solid State Drive Module

M.2 Solid State Drive Bracket

Left Speaker

Right Speaker

Fingerprint Reader Module

Fingerprint Reader Bracket

Touchpad Module

Audio and Power Button Board

Wireless WAN Antennas

Fan and Heat Sink Assembly

System board (top)

**System board (bottom)**

IR Sensor Board

Display Panel Assembly

Keyboard

Support Brackets

Top Cover

[Go to External Views](#)

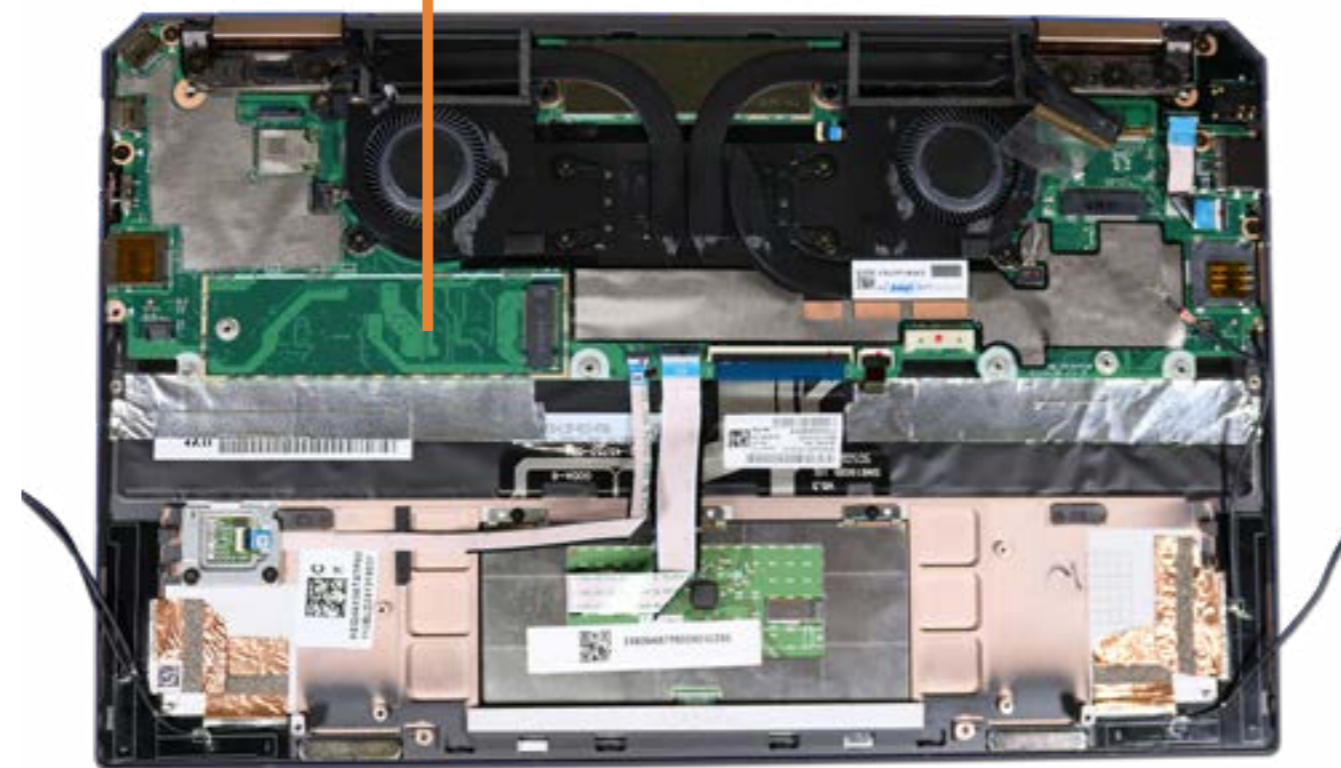
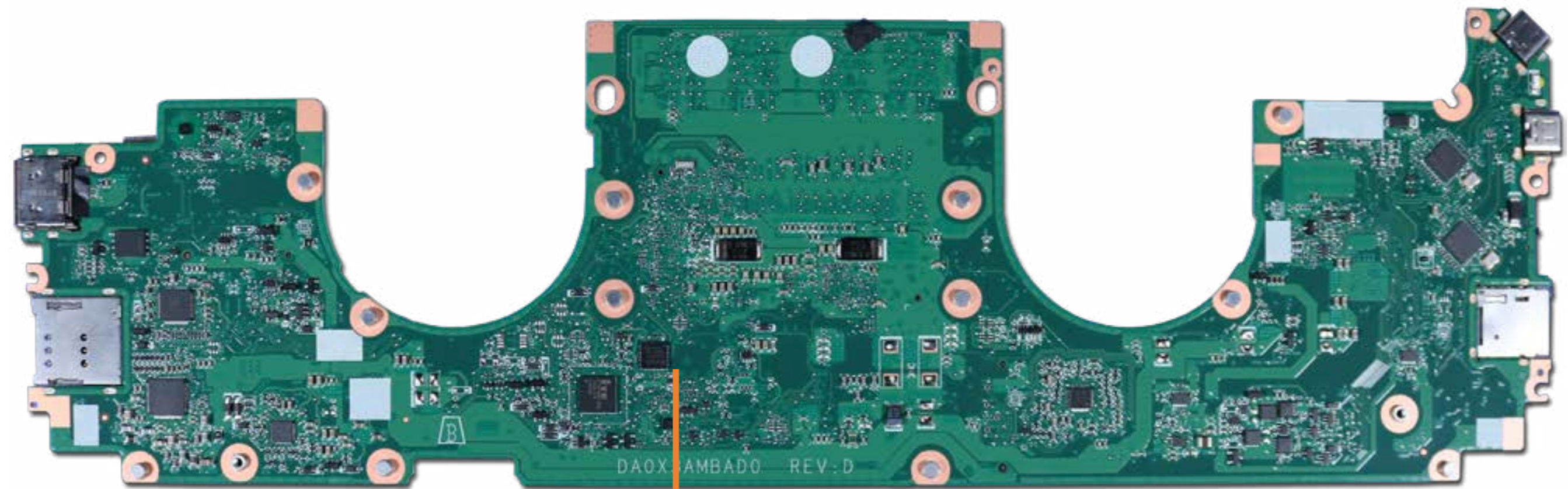



# IR Sensor Board

Base Enclosure

Battery

Wireless WAN Module

Wireless WAN SIM Card slot

M.2 Solid State Drive Module

M.2 Solid State Drive Bracket

Left Speaker

Right Speaker

Fingerprint Reader Module

Fingerprint Reader Bracket

Touchpad Module

Audio and Power Button Board

Wireless WAN Antennas

Fan and Heat Sink Assembly

System board (top)

System board (bottom)

**IR Sensor Board**

Display Panel Assembly

Keyboard

Support Brackets

Top Cover

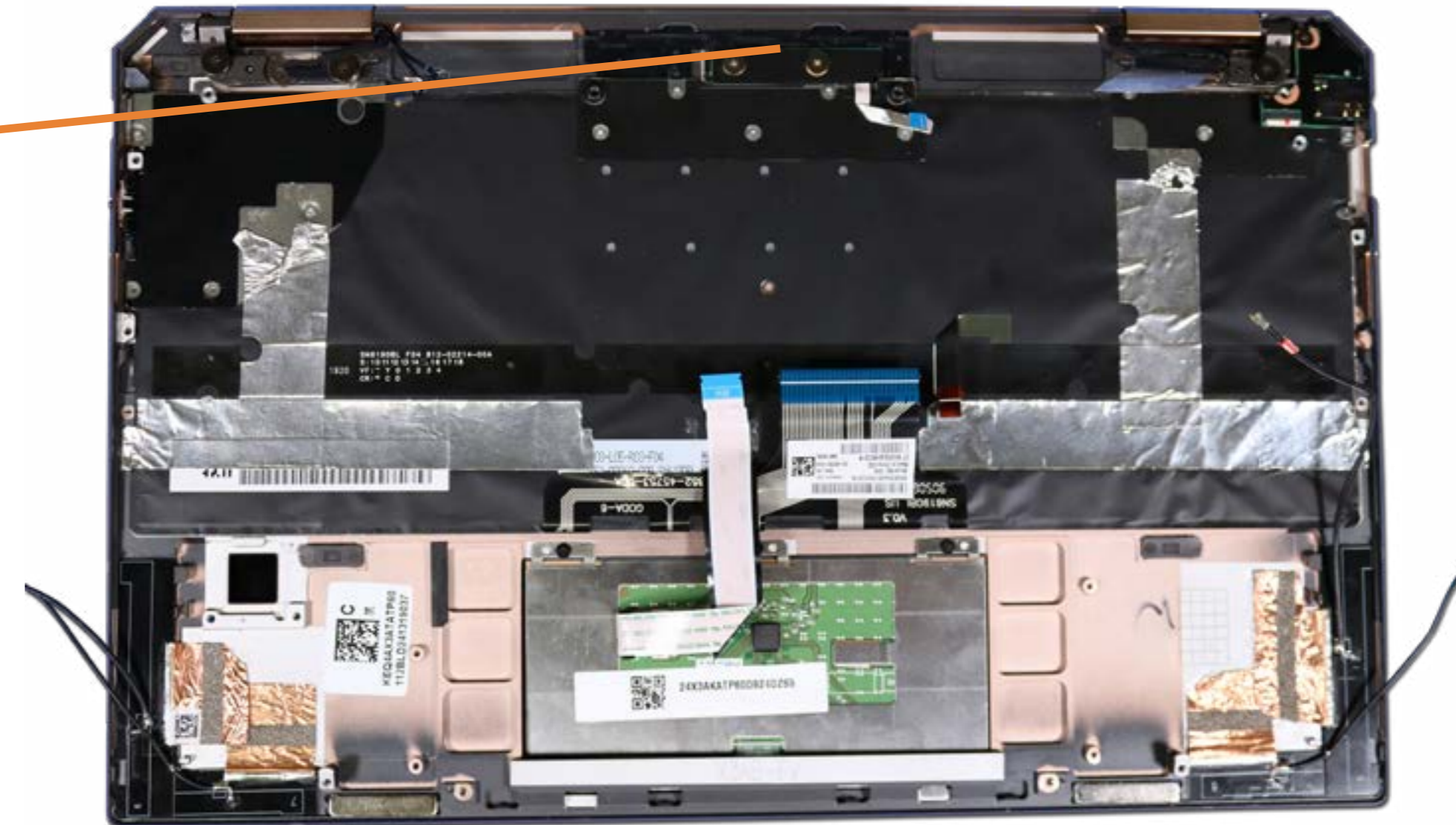
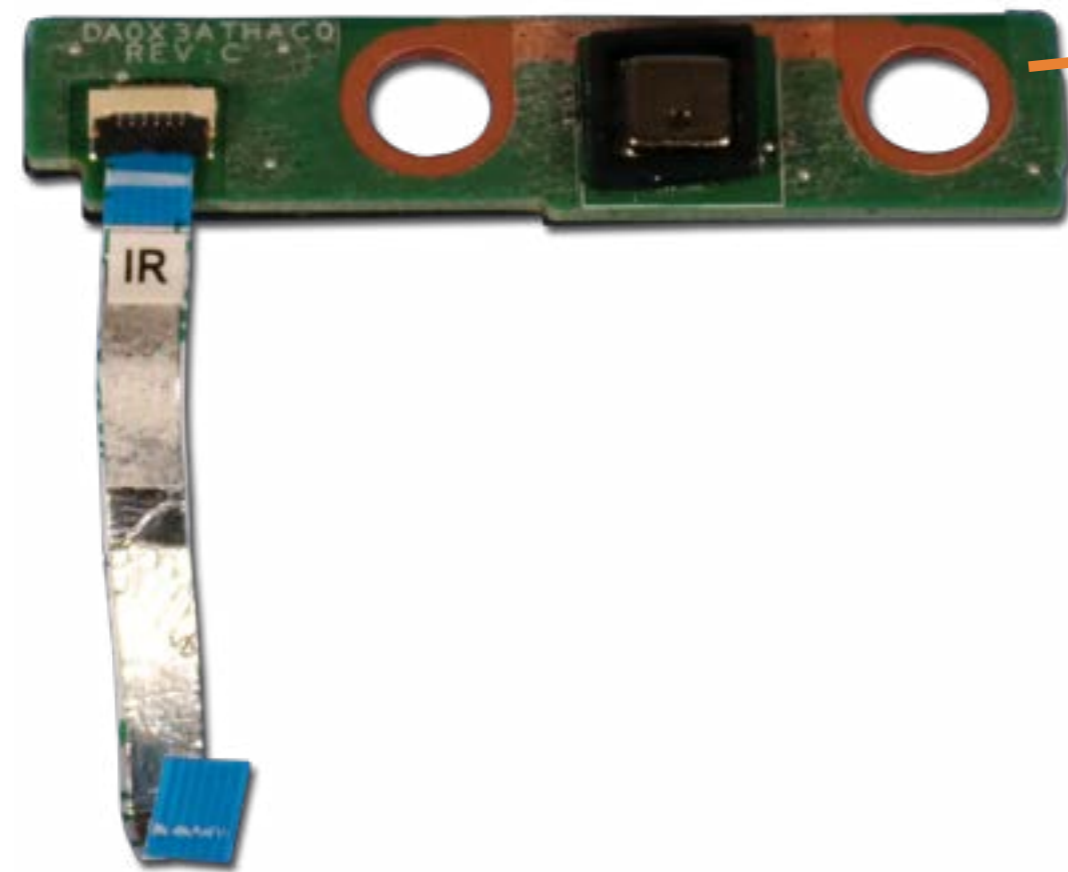

[Go to External Views](#)

# Display Panel Assembly

Base Enclosure

Battery

Wireless WAN Module

Wireless WAN SIM Card slot

M.2 Solid State Drive Module

M.2 Solid State Drive Bracket

Left Speaker

Right Speaker

Fingerprint Reader Module

Fingerprint Reader Bracket

Touchpad Module

Audio and Power Button Board

Wireless WAN Antennas

Fan and Heat Sink Assembly

System board (top)

System board (bottom)

IR Sensor Board

**Display Panel Assembly**

Keyboard

Support Brackets

Top Cover

[Go to External Views](#)





# Keyboard

Base Enclosure

Battery

Wireless WAN Module

Wireless WAN SIM Card slot

M.2 Solid State Drive Module

M.2 Solid State Drive Bracket

Left Speaker

Right Speaker

Fingerprint Reader Module

Fingerprint Reader Bracket

Touchpad Module

Audio and Power Button Board

Wireless WAN Antennas

Fan and Heat Sink Assembly

System board (top)

System board (bottom)

IR Sensor Board

Display Panel Assembly

**Keyboard**

Support Brackets

Top Cover

Go to External Views



# Keyboard Support Brackets

- Base Enclosure
- Battery
- Wireless WAN Module
- Wireless WAN SIM Card slot
- M.2 Solid State Drive Module
- M.2 Solid State Drive Bracket
- Left Speaker
- Right Speaker
- Fingerprint Reader Module
- Fingerprint Reader Bracket
- Touchpad Module
- Audio and Power Button Board
- Wireless WAN Antennas
- Fan and Heat Sink Assembly
- System board (top)
- System board (bottom)
- IR Sensor Board
- Display Panel Assembly
- Keyboard
- Support Brackets**
- Top Cover

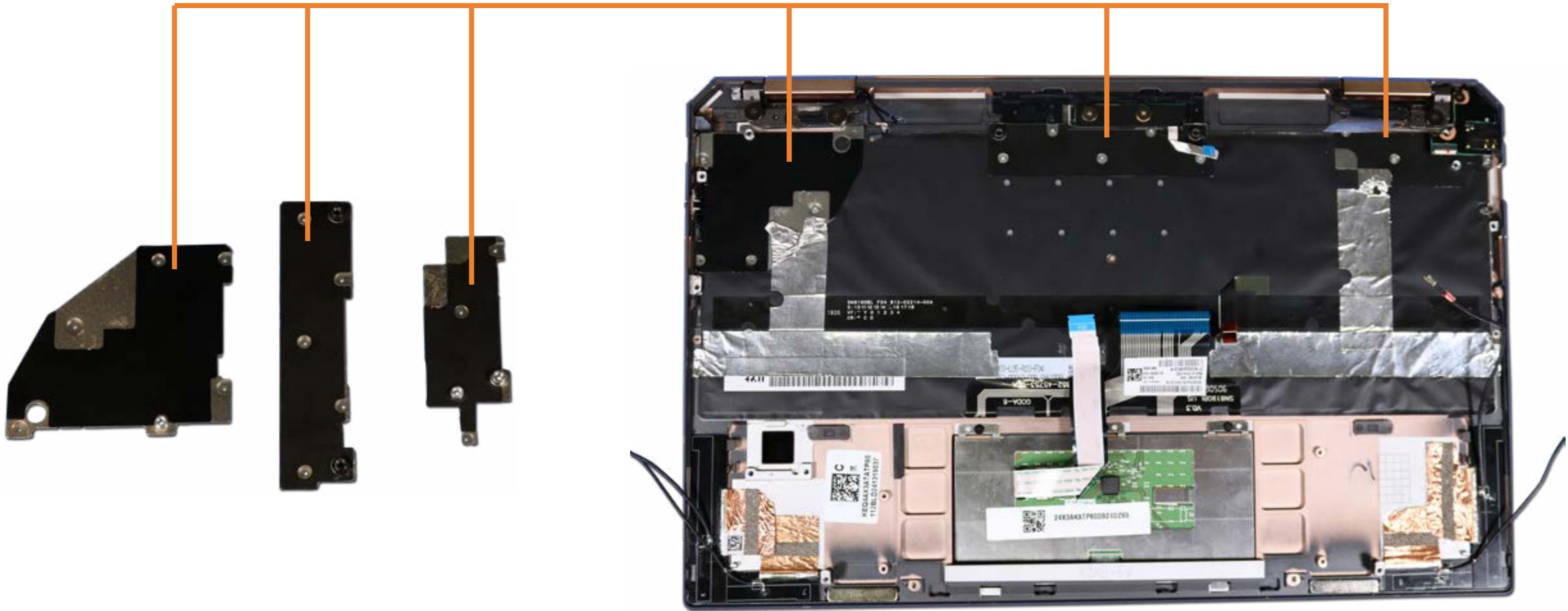

[Go to External Views](#)



# Top Cover

Base Enclosure

Battery

Wireless WAN Module

Wireless WAN SIM Card slot

M.2 Solid State Drive Module

M.2 Solid State Drive Bracket

Left Speaker

Right Speaker

Fingerprint Reader Module

Fingerprint Reader Bracket

Touchpad Module

Audio and Power Button Board

Wireless WAN Antennas

Fan and Heat Sink Assembly

System board (top)

System board (bottom)

IR Sensor Board

Display Panel Assembly

Keyboard

Support Brackets

**Top Cover**



[Go to External Views](#)