

# Interactive Part Locator

## HP ProBook 430 G7 Notebook PC

Welcome to this interactive part locator

### Here's how to use it...

[External Views](#) (Click the link to navigate to the views)

On this page you will find large icons of each of the external views of this product. To view a specific view in greater detail, simply click that view.

[Parts List](#) (Click the link to navigate to the parts)

On this page, you will find a list of all of the replaceable parts for this product. To view a specific part and its location in the product, click the part name in the list.

**That's it! On every page there is a link that brings you back to either the External Views or the Parts List, enabling you to navigate to whatever view or part you wish to review.**

# External Views

[Back to Welcome page](#)



Front



Left



Right



Rear



Display



Top



Bottom



Internal

[Go to Parts List](#)

# Front View

[Back to External Views](#)



[Go to Parts List](#)

# Left View

[Back to External Views](#)

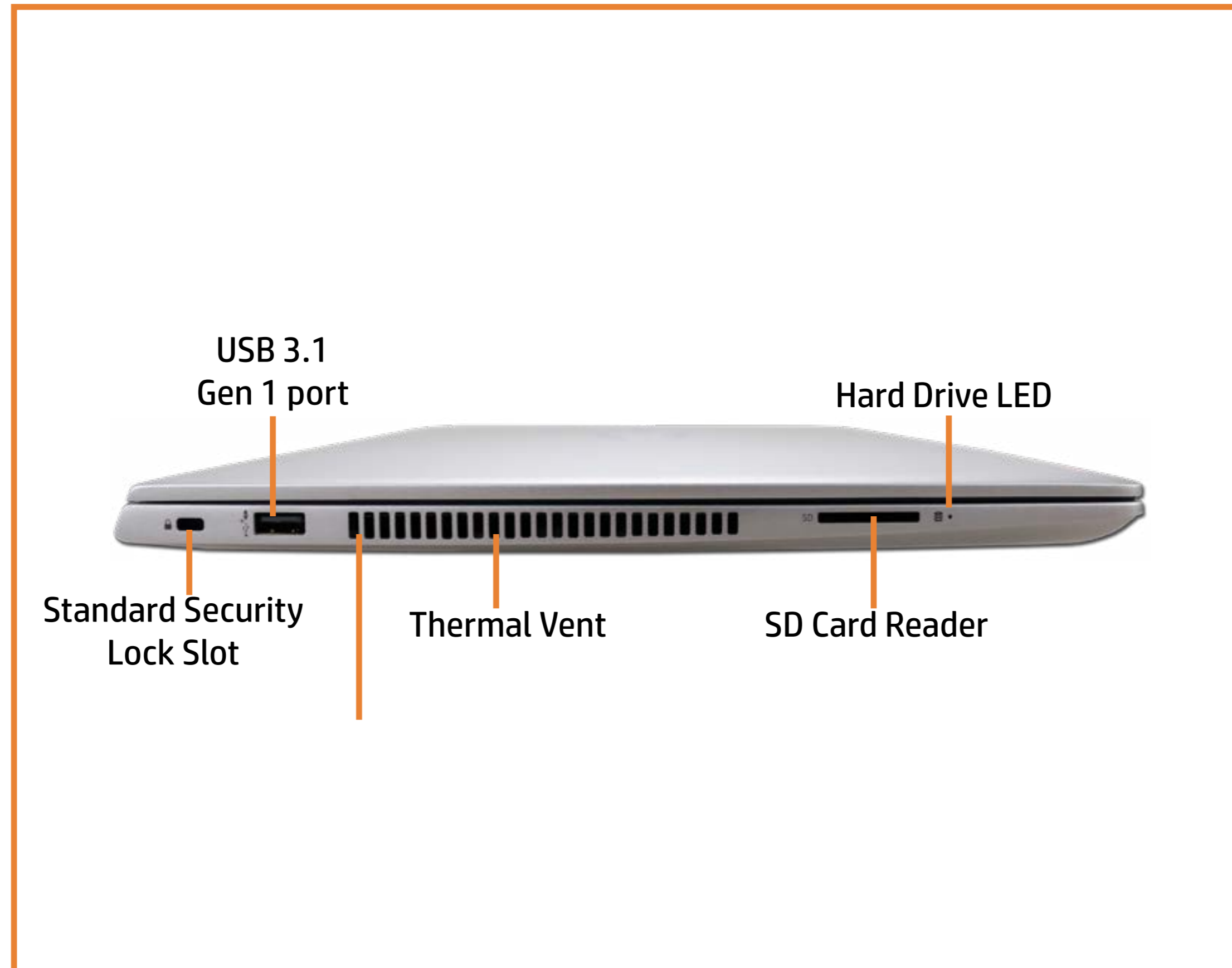

[Go to Parts List](#)

# Right View

[Back to External Views](#)

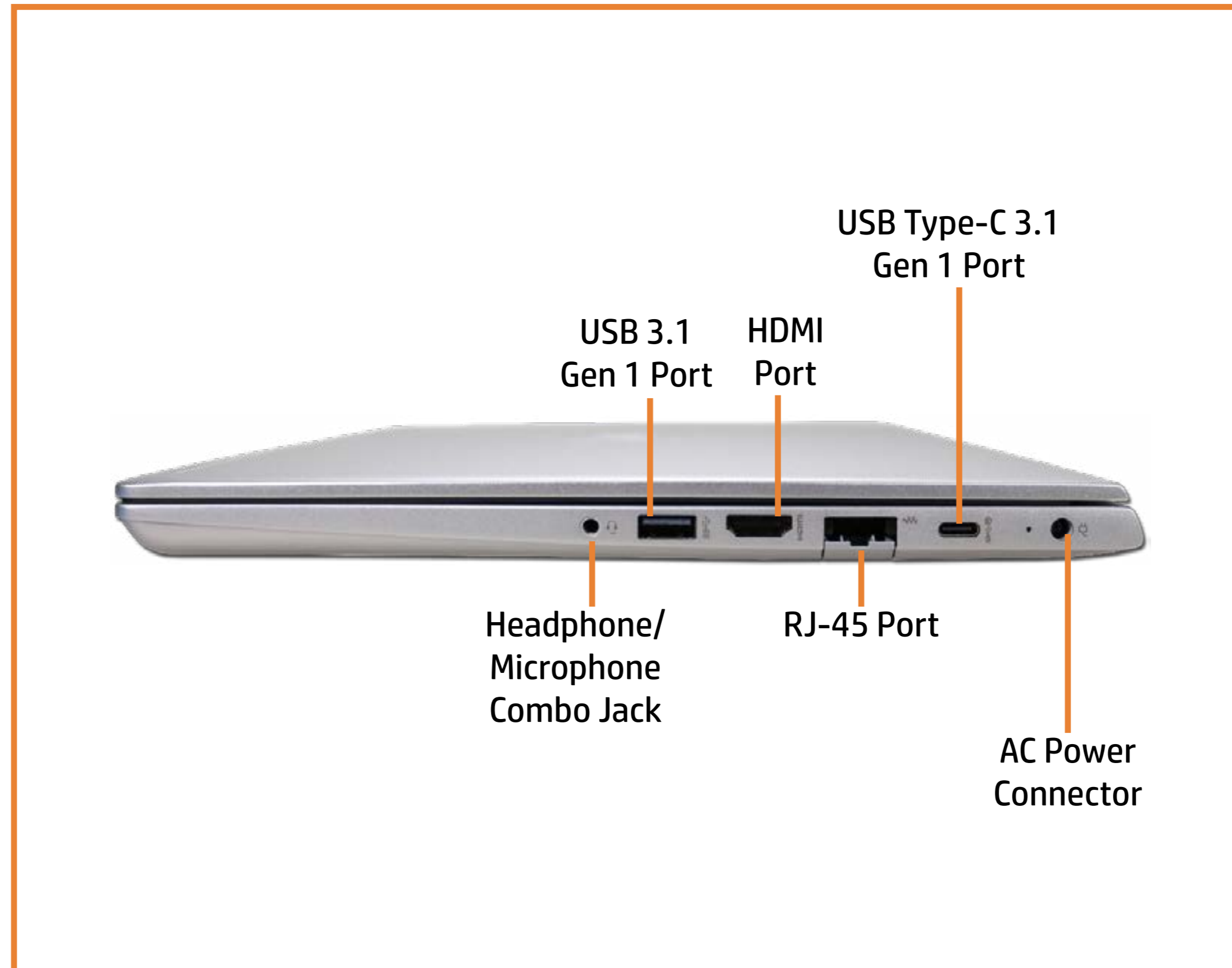

[Go to Parts List](#)

# Rear View

[Back to External Views](#)



Hinge

[Go to Parts List](#)

# Display View

[Back to External Views](#)

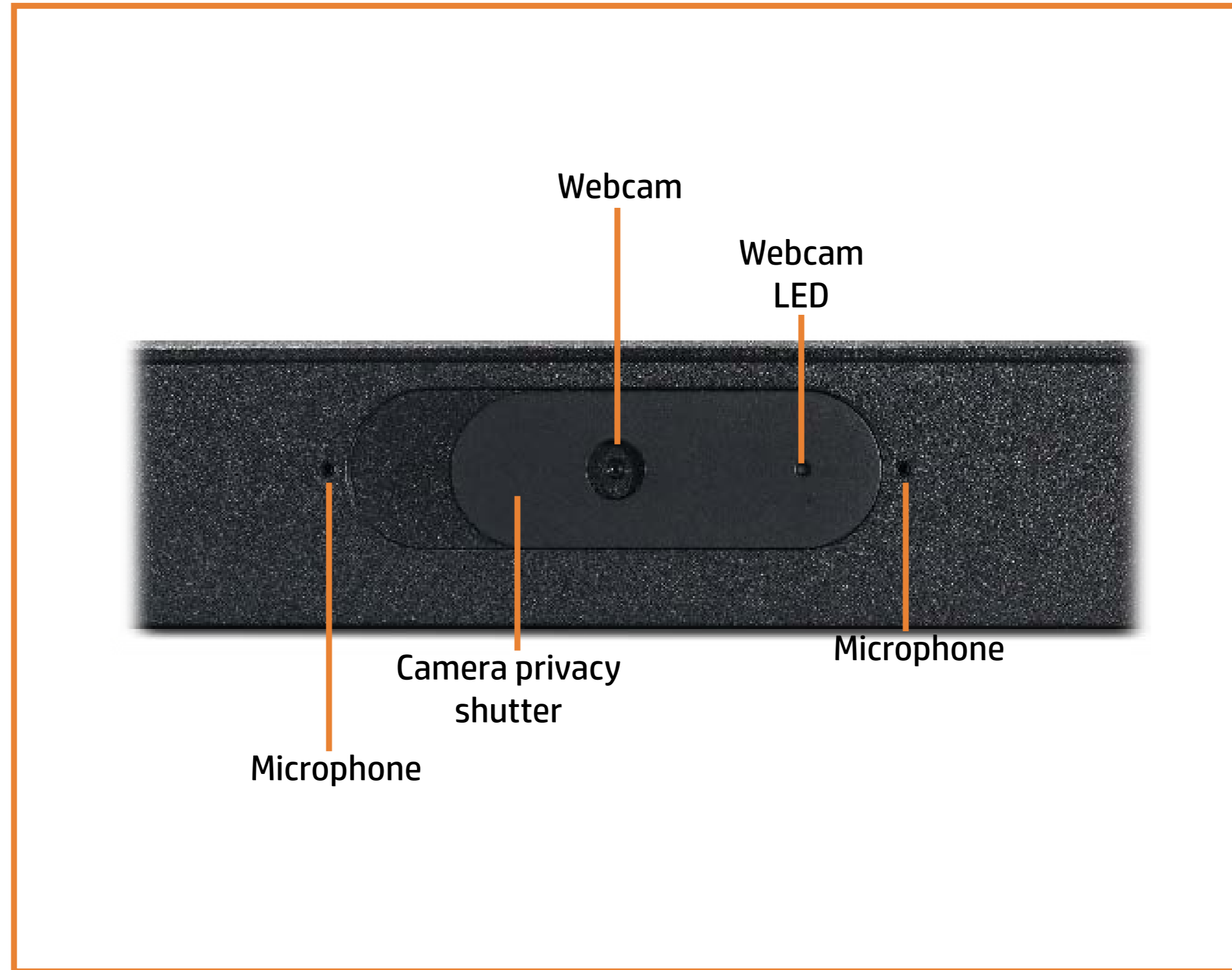

[Go to Parts List](#)



# Top View

[Back to External Views](#)

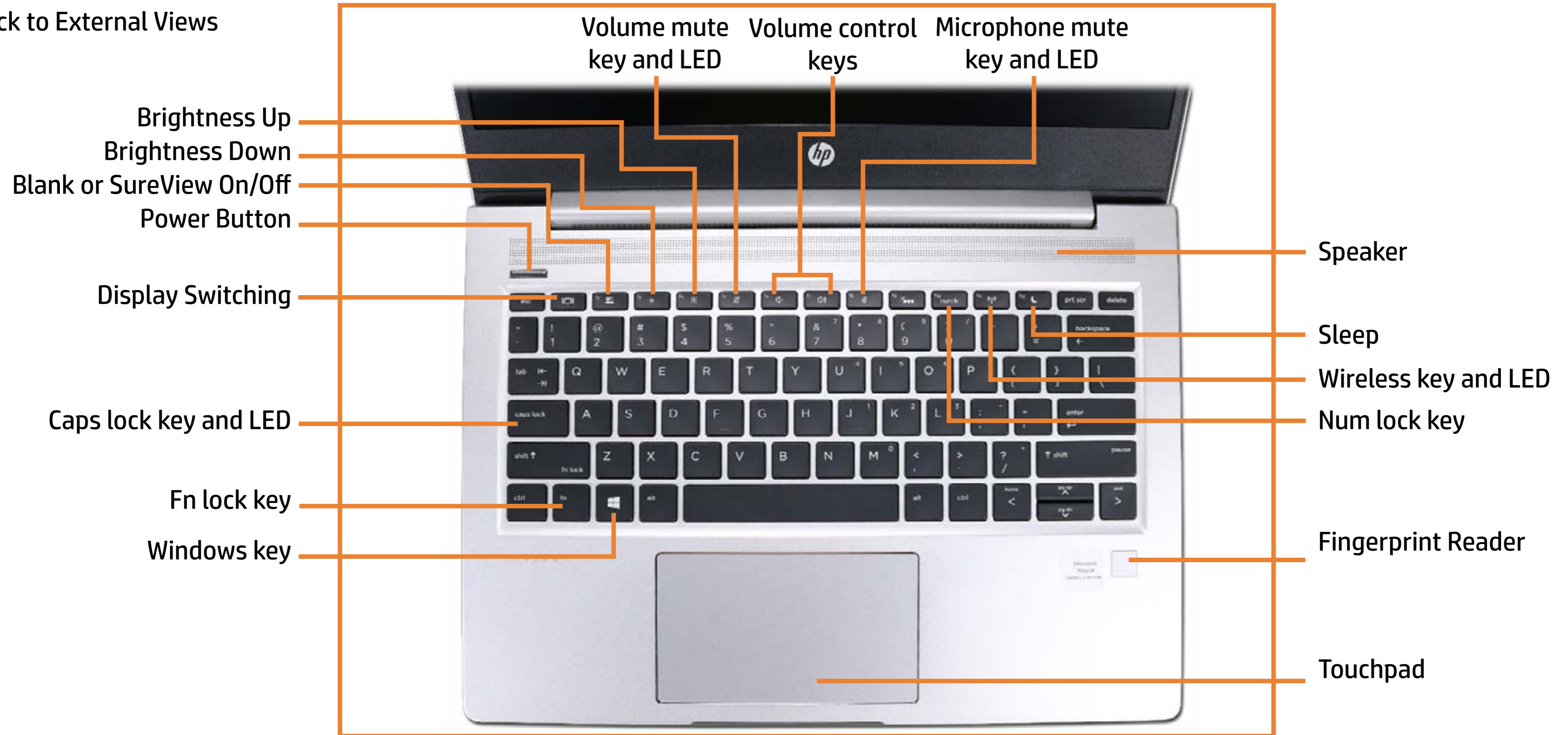

[Go to Parts List](#)



# Bottom View

[Back to External Views](#)

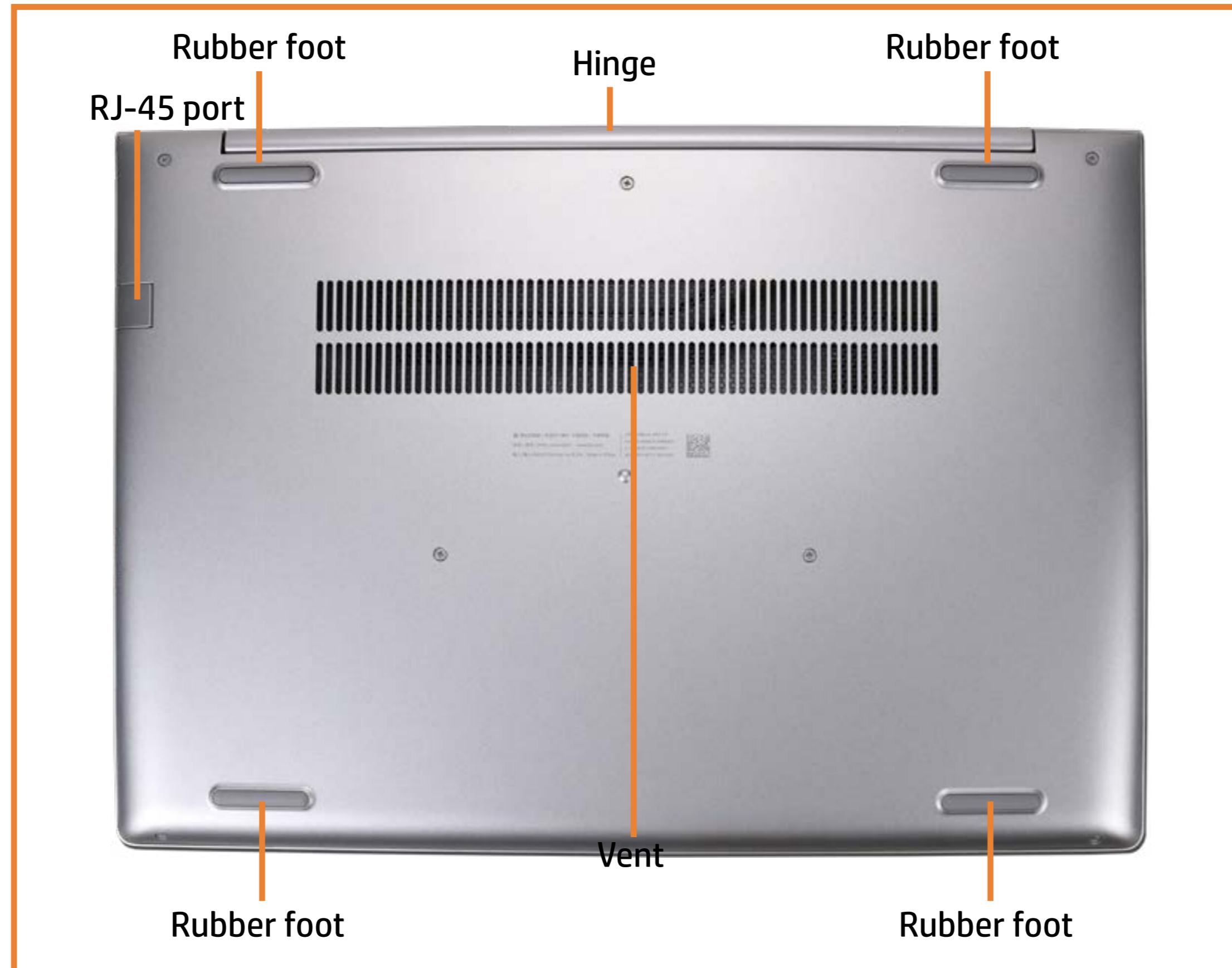

[Go to Parts List](#)

# Internal View

[Back to External Views](#)

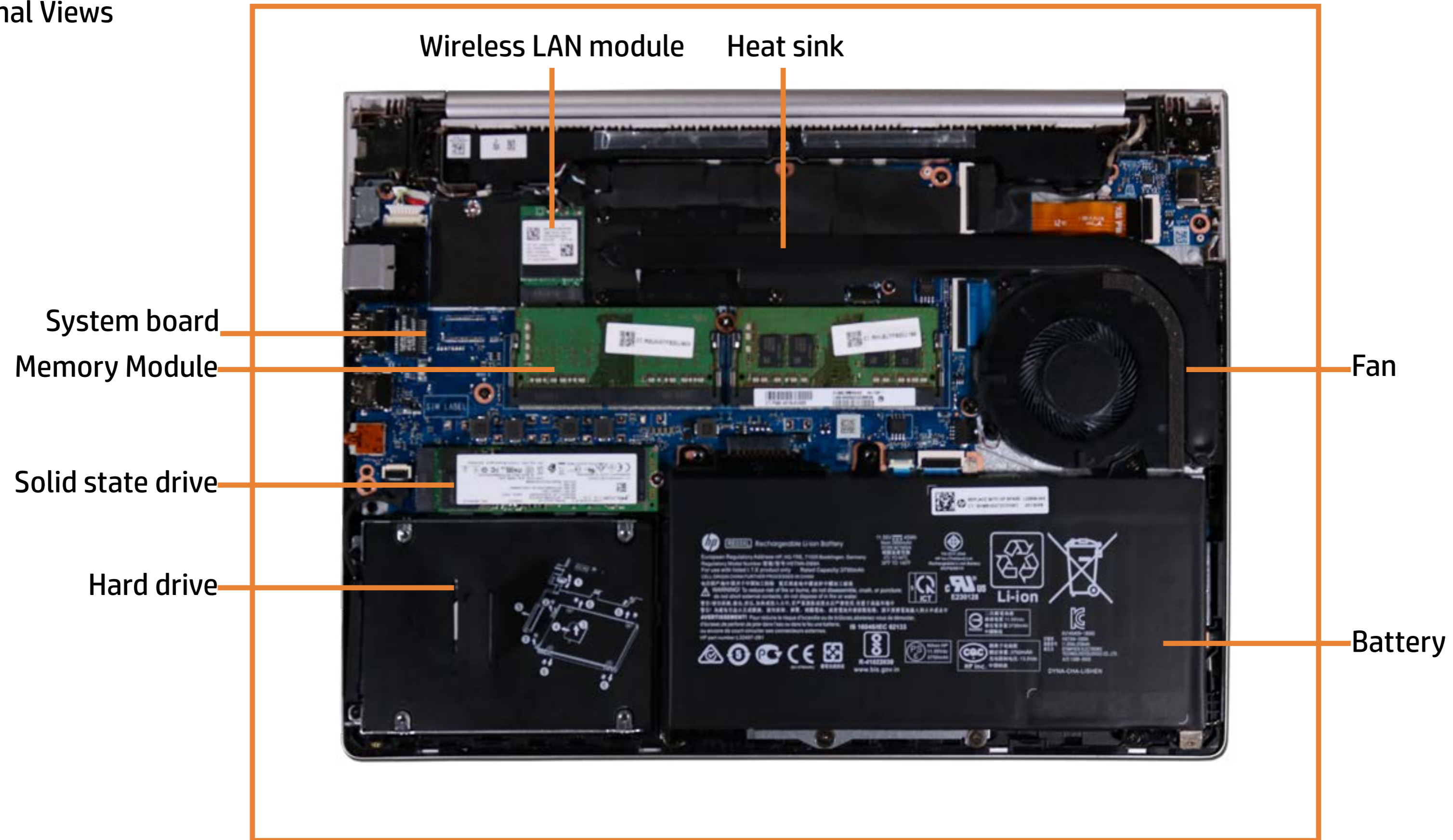

[Go to Parts List](#)



# Battery

## Battery

- Base Enclosure
- Solid State Drive
- Wireless LAN Module
- Memory Modules
- SD Card Reader
- RTC Battery
- Hard Drive
- Fingerprint Reader
- Fingerprint Reader Bracket
- Touchpad
- Speaker
- Fan
- Heat Sink
- USB Board
- Power Connector Cable
- RJ-45 Bracket
- USB-C Bracket
- System Board (top)
- System Board (bottom)
- Top Cover
- Display Panel Assembly
- Camera Privacy Slider
- Display Bezel
- Webcam
- Display Panel
- Display Panel Cable
- Hinges
- Antennas



[Go to External Views](#)

# Base Enclosure

- Battery
- Base Enclosure**
- Solid State Drive
- Wireless LAN Module
- Memory Modules
- SD Card Reader
- RTC Battery
- Hard Drive
- Fingerprint Reader
- Fingerprint Reader Bracket
- Touchpad
- Speaker
- Fan
- Heat Sink
- USB Board
- Power Connector Cable
- RJ-45 Bracket
- USB-C Bracket
- System Board (top)
- System Board (bottom)
- Top Cover
- Display Panel Assembly
- Camera Privacy Slider
- Display Bezel
- Webcam
- Display Panel
- Display Panel Cable
- Hinges
- Antennas

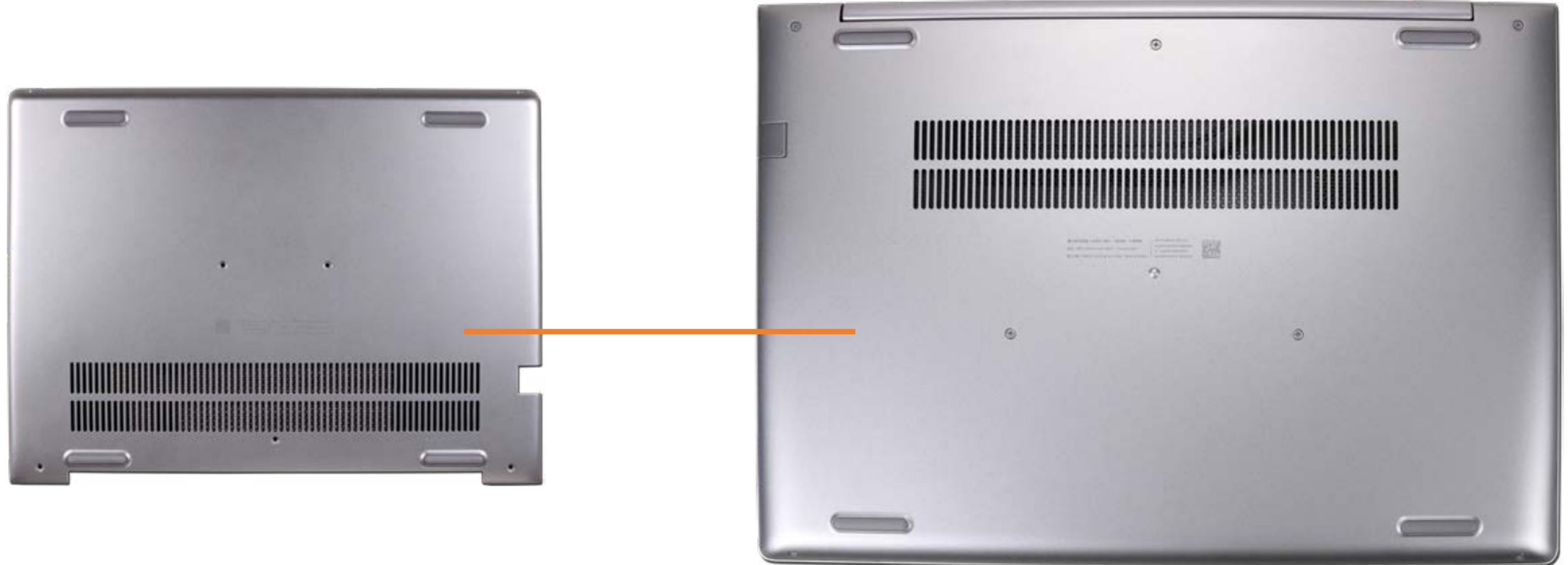

[Go to External Views](#)



# Solid State Drive

- Battery
- Base Enclosure
- Solid State Drive**
- Wireless LAN Module
- Memory Modules
- SD Card Reader
- RTC Battery
- Hard Drive
- Fingerprint Reader
- Fingerprint Reader Bracket
- Touchpad
- Speaker
- Fan
- Heat Sink
- USB Board
- Power Connector Cable
- RJ-45 Bracket
- USB-C Bracket
- System Board (top)
- System Board (bottom)
- Top Cover
- Display Panel Assembly
- Camera Privacy Slider
- Display Bezel
- Webcam
- Display Panel
- Display Panel Cable
- Hinges
- Antennas



[Go to External Views](#)



# Wireless LAN Module

- Battery
- Base Enclosure
- Solid State Drive
- Wireless LAN Module**
- Memory Modules
- SD Card Reader
- RTC Battery
- Hard Drive
- Fingerprint Reader
- Fingerprint Reader Bracket
- Touchpad
- Speaker
- Fan
- Heat Sink
- USB Board
- Power Connector Cable
- RJ-45 Bracket
- USB-C Bracket
- System Board (top)
- System Board (bottom)
- Top Cover
- Display Panel Assembly
- Camera Privacy Slider
- Display Bezel
- Webcam
- Display Panel
- Display Panel Cable
- Hinges
- Antennas



[Go to External Views](#)



# Memory Modules

- Battery
- Base Enclosure
- Solid State Drive
- Wireless LAN Module
- Memory Modules**
- SD Card Reader
- RTC Battery
- Hard Drive
- Fingerprint Reader
- Fingerprint Reader Bracket
- Touchpad
- Speaker
- Fan
- Heat Sink
- USB Board
- Power Connector Cable
- RJ-45 Bracket
- USB-C Bracket
- System Board (top)
- System Board (bottom)
- Top Cover
- Display Panel Assembly
- Camera Privacy Slider
- Display Bezel
- Webcam
- Display Panel
- Display Panel Cable
- Hinges
- Antennas



[Go to External Views](#)



# SD Card Reader

- Battery
- Base Enclosure
- Solid State Drive
- Wireless LAN Module
- Memory Modules
- SD Card Reader**
- RTC Battery
- Hard Drive
- Fingerprint Reader
- Fingerprint Reader Bracket
- Touchpad
- Speaker
- Fan
- Heat Sink
- USB Board
- Power Connector Cable
- RJ-45 Bracket
- USB-C Bracket
- System Board (top)
- System Board (bottom)
- Top Cover
- Display Panel Assembly
- Camera Privacy Slider
- Display Bezel
- Webcam
- Display Panel
- Display Panel Cable
- Hinges
- Antennas

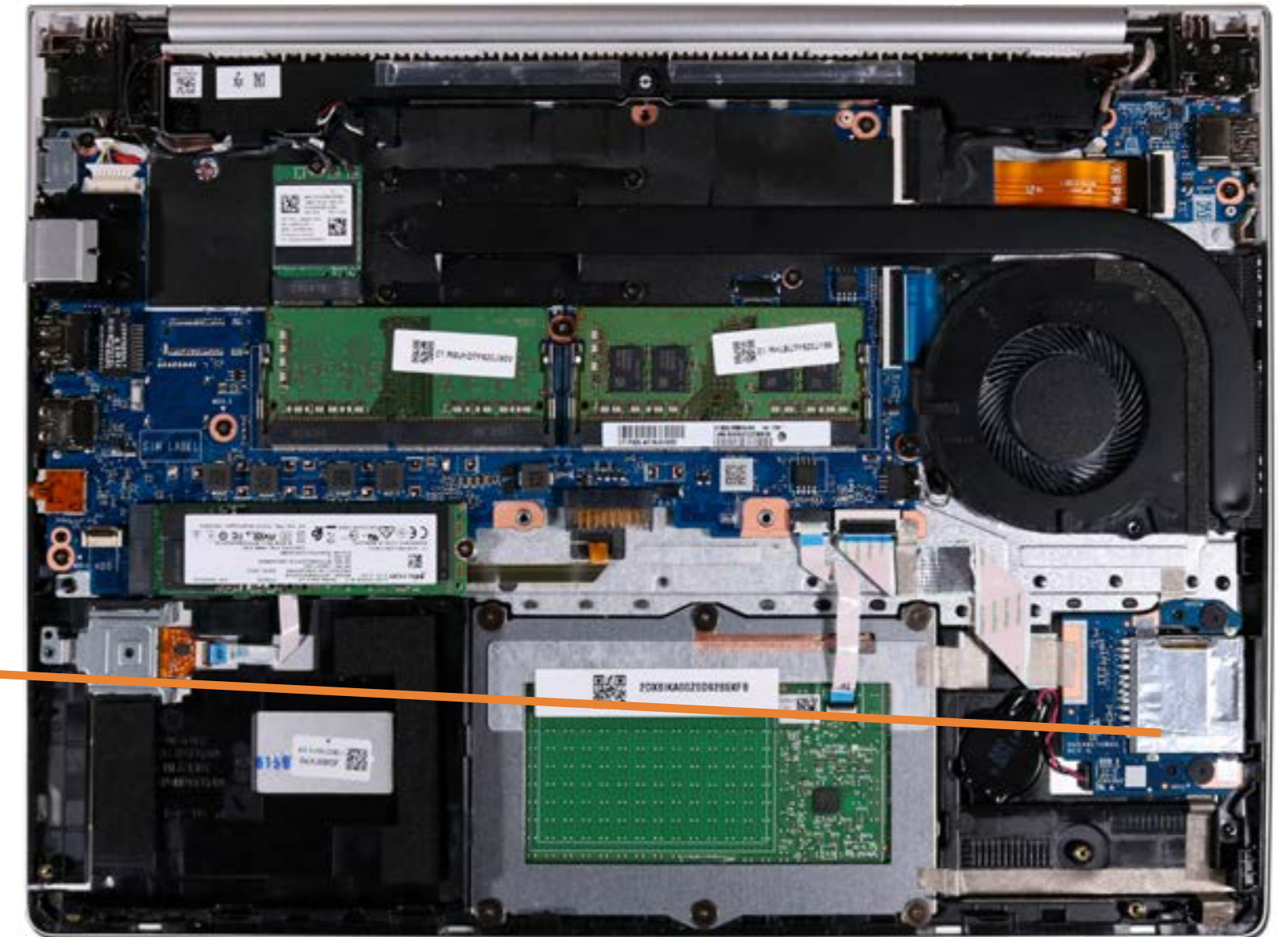
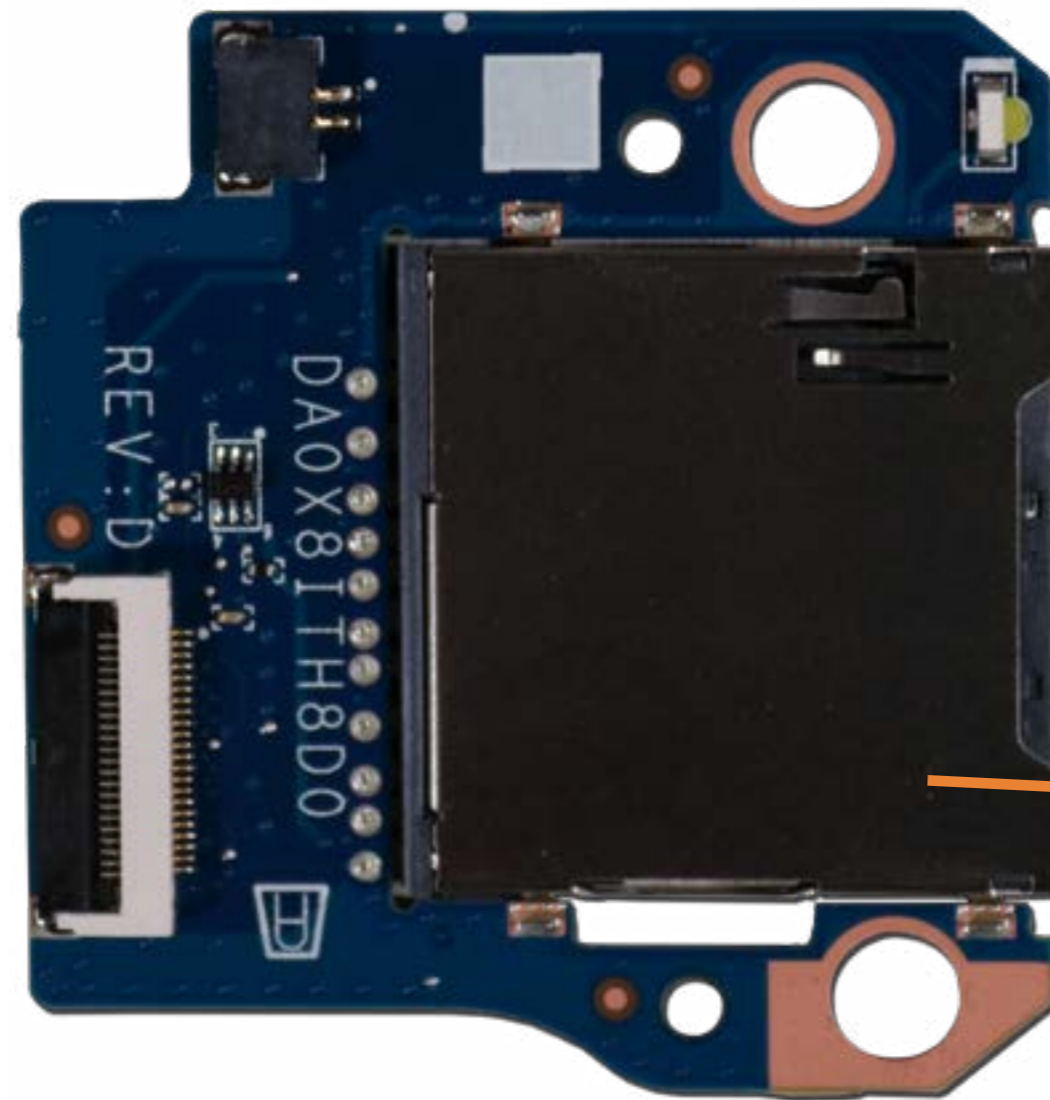

[Go to External Views](#)



# RTC Battery

- Battery
- Base Enclosure
- Solid State Drive
- Wireless LAN Module
- Memory Modules
- SD Card Reader
- RTC Battery**
- Hard Drive
- Fingerprint Reader
- Fingerprint Reader Bracket
- Touchpad
- Speaker
- Fan
- Heat Sink
- USB Board
- Power Connector Cable
- RJ-45 Bracket
- USB-C Bracket
- System Board (top)
- System Board (bottom)
- Top Cover
- Display Panel Assembly
- Camera Privacy Slider
- Display Bezel
- Webcam
- Display Panel
- Display Panel Cable
- Hinges
- Antennas

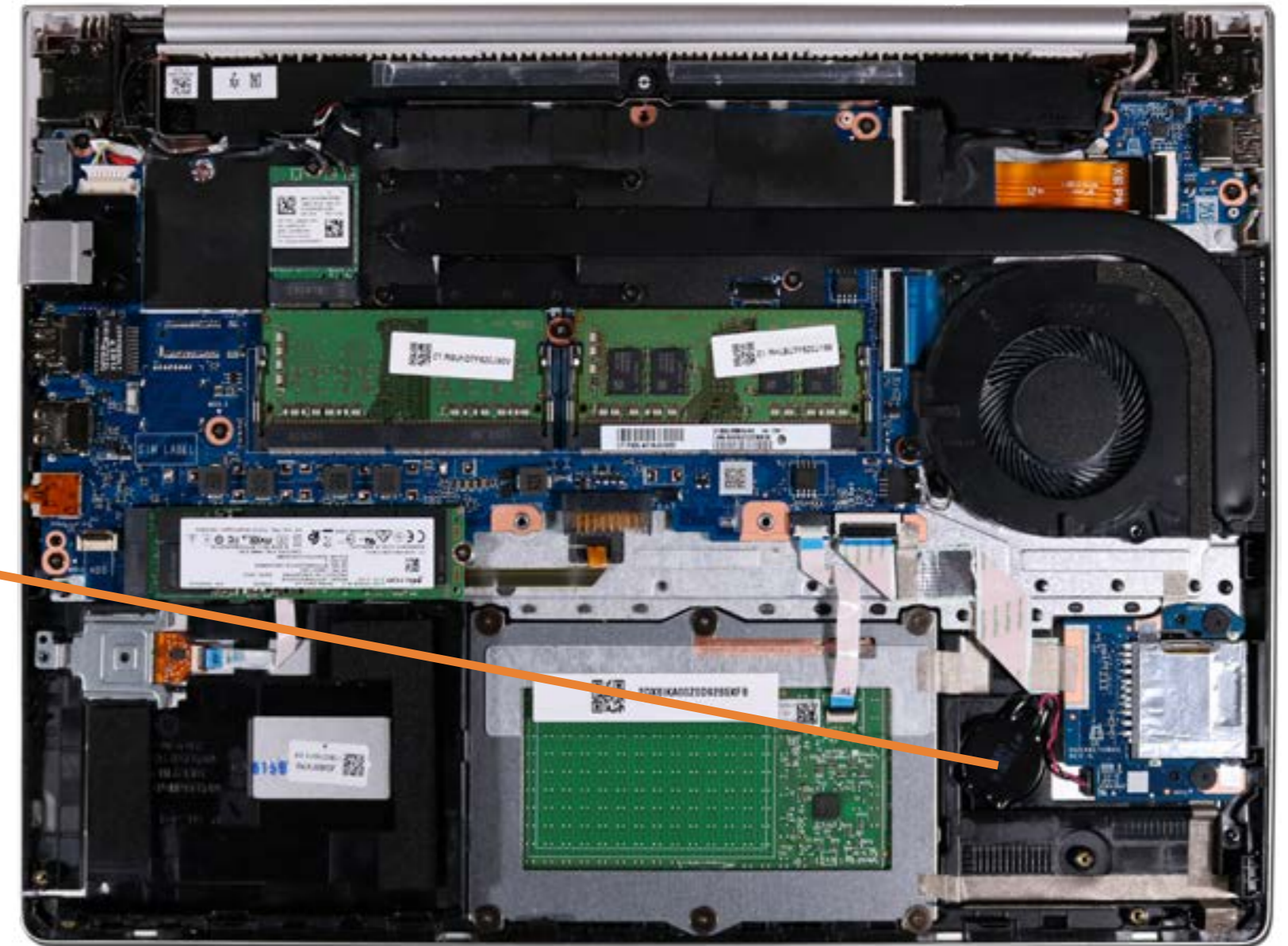

[Go to External Views](#)



# Hard Drive

- Battery
- Base Enclosure
- Solid State Drive
- Wireless LAN Module
- Memory Modules
- SD Card Reader
- RTC Battery
- Hard Drive**
- Fingerprint Reader
- Fingerprint Reader Bracket
- Touchpad
- Speaker
- Fan
- Heat Sink
- USB Board
- Power Connector Cable
- RJ-45 Bracket
- USB-C Bracket
- System Board (top)
- System Board (bottom)
- Top Cover
- Display Panel Assembly
- Camera Privacy Slider
- Display Bezel
- Webcam
- Display Panel
- Display Panel Cable
- Hinges
- Antennas

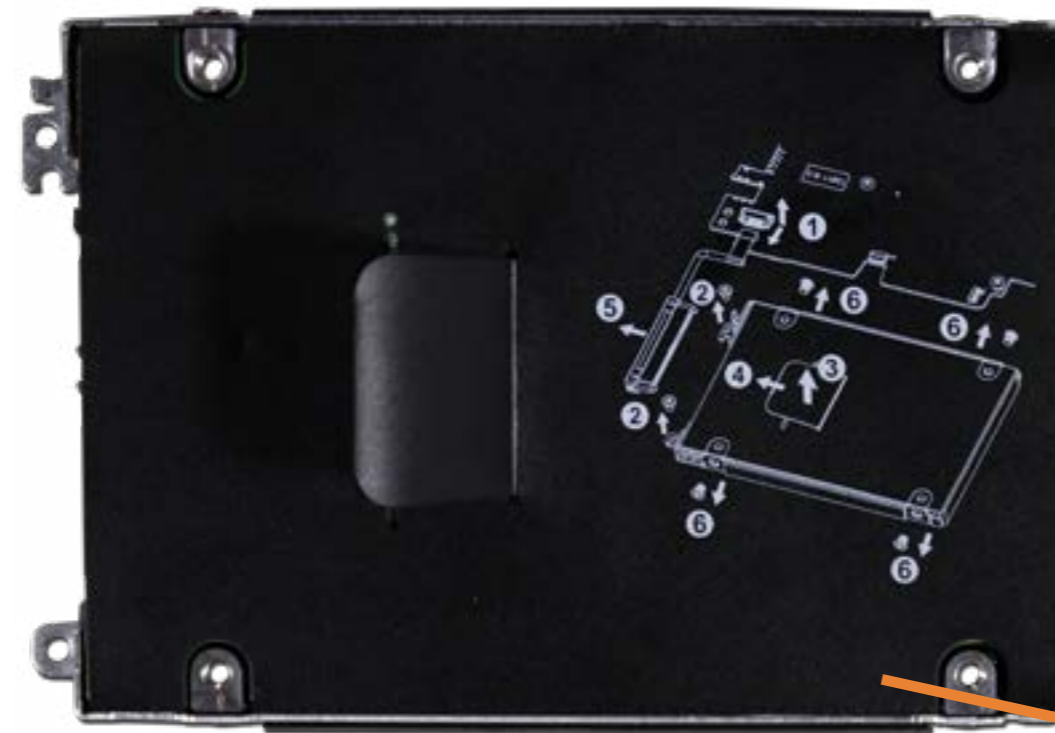

[Go to External Views](#)



# Fingerprint Reader

- Battery
- Base Enclosure
- Solid State Drive
- Wireless LAN Module
- Memory Modules
- SD Card Reader
- RTC Battery
- Hard Drive
- Fingerprint Reader**
- Fingerprint Reader Bracket
- Touchpad
- Speaker
- Fan
- Heat Sink
- USB Board
- Power Connector Cable
- RJ-45 Bracket
- USB-C Bracket
- System Board (top)
- System Board (bottom)
- Top Cover
- Display Panel Assembly
- Camera Privacy Slider
- Display Bezel
- Webcam
- Display Panel
- Display Panel Cable
- Hinges
- Antennas

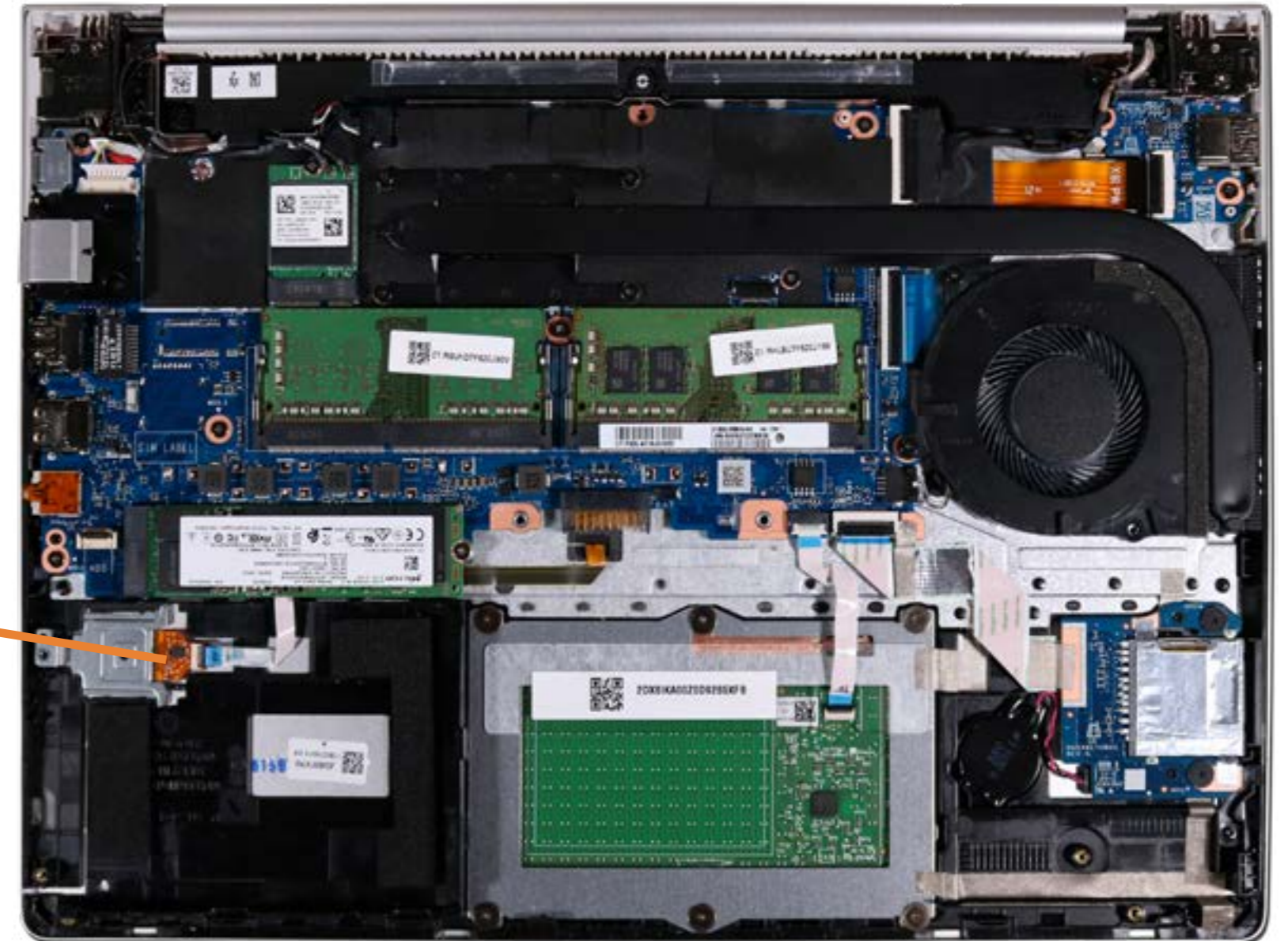

[Go to External Views](#)



# Fingerprint Reader Bracket

- Battery
- Base Enclosure
- Solid State Drive
- Wireless LAN Module
- Memory Modules
- SD Card Reader
- RTC Battery
- Hard Drive
- Fingerprint Reader
- Fingerprint Reader Bracket**
- Touchpad
- Speaker
- Fan
- Heat Sink
- USB Board
- Power Connector Cable
- RJ-45 Bracket
- USB-C Bracket
- System Board (top)
- System Board (bottom)
- Top Cover
- Display Panel Assembly
- Camera Privacy Slider
- Display Bezel
- Webcam
- Display Panel
- Display Panel Cable
- Hinges
- Antennas

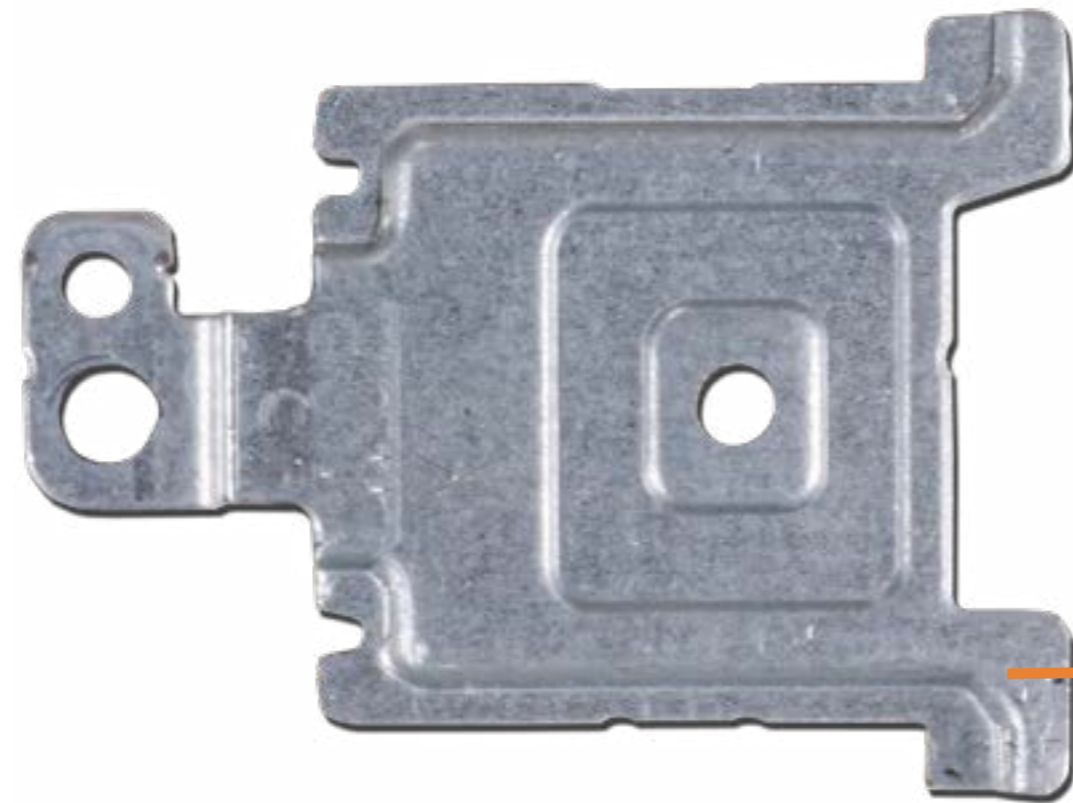

[Go to External Views](#)



# Touchpad

- Battery
- Base Enclosure
- Solid State Drive
- Wireless LAN Module
- Memory Modules
- SD Card Reader
- RTC Battery
- Hard Drive
- Fingerprint Reader
- Fingerprint Reader Bracket

## Touchpad

- Speaker
- Fan
- Heat Sink
- USB Board
- Power Connector Cable
- RJ-45 Bracket
- USB-C Bracket
- System Board (top)
- System Board (bottom)
- Top Cover
- Display Panel Assembly
- Camera Privacy Slider
- Display Bezel
- Webcam
- Display Panel
- Display Panel Cable
- Hinges
- Antennas

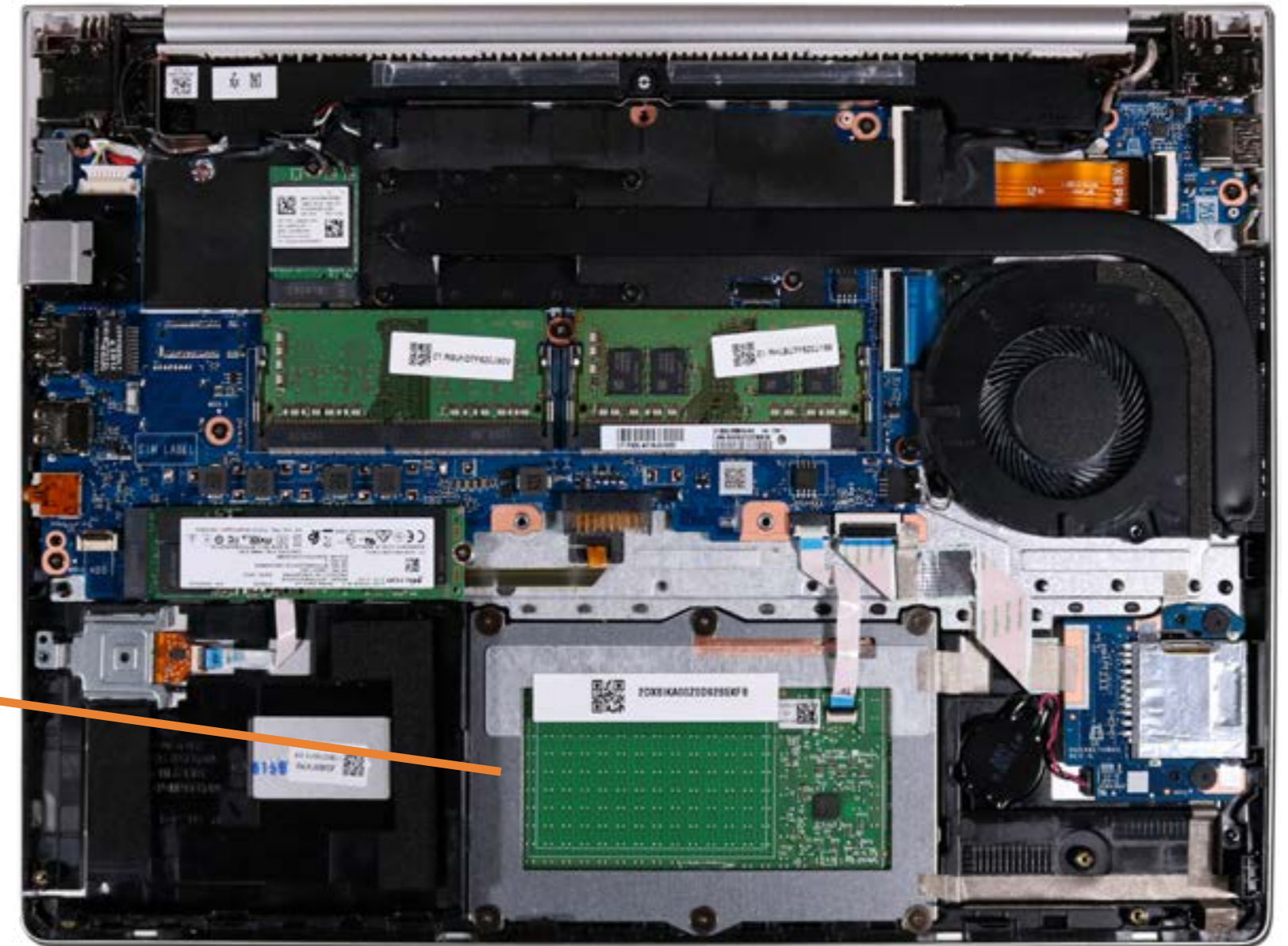
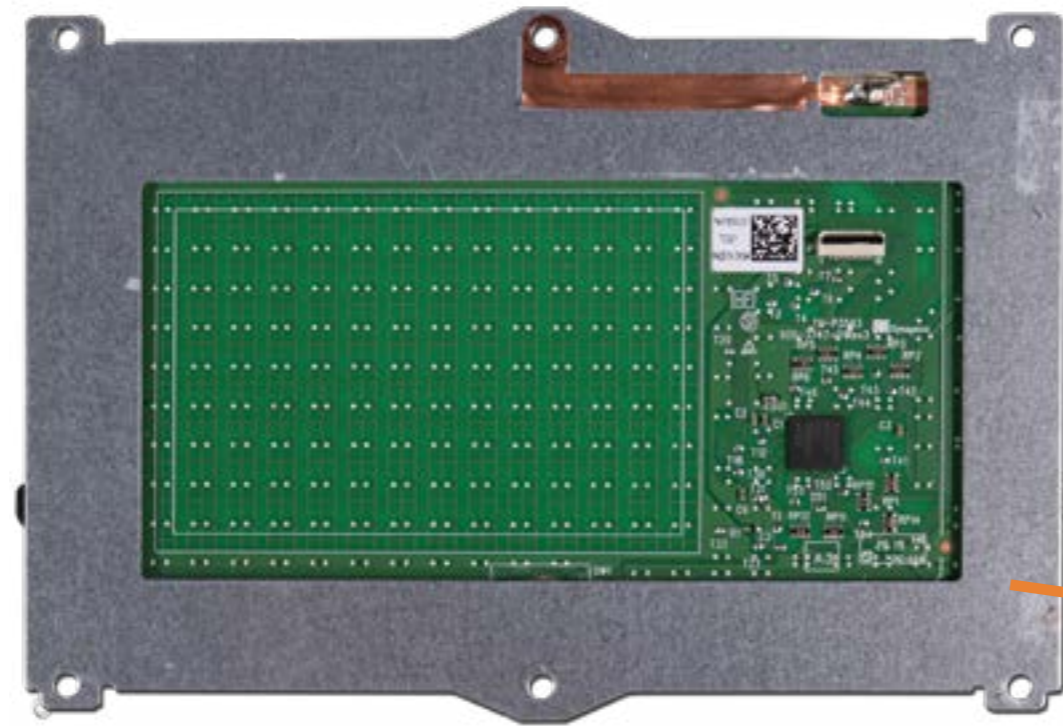

[Go to External Views](#)



# Speaker

- Battery
- Base Enclosure
- Solid State Drive
- Wireless LAN Module
- Memory Modules
- SD Card Reader
- RTC Battery
- Hard Drive
- Fingerprint Reader
- Fingerprint Reader Bracket
- Touchpad
- Speaker**
- Fan
- Heat Sink
- USB Board
- Power Connector Cable
- RJ-45 Bracket
- USB-C Bracket
- System Board (top)
- System Board (bottom)
- Top Cover
- Display Panel Assembly
- Camera Privacy Slider
- Display Bezel
- Webcam
- Display Panel
- Display Panel Cable
- Hinges
- Antennas

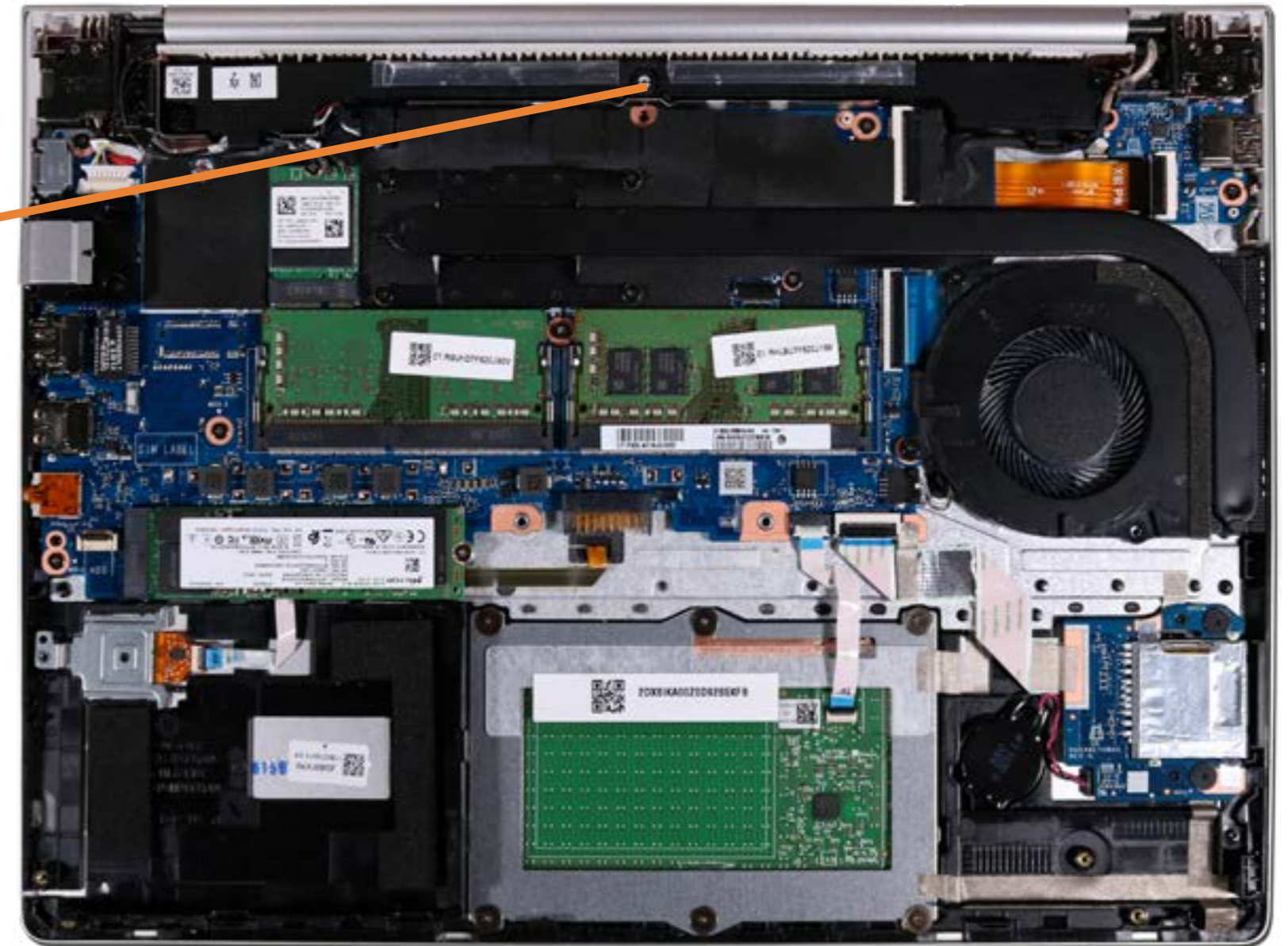

[Go to External Views](#)



# Fan

- Battery
- Base Enclosure
- Solid State Drive
- Wireless LAN Module
- Memory Modules
- SD Card Reader
- RTC Battery
- Hard Drive
- Fingerprint Reader
- Fingerprint Reader Bracket
- Touchpad
- Speaker
- Fan**
- Heat Sink
- USB Board
- Power Connector Cable
- RJ-45 Bracket
- USB-C Bracket
- System Board (top)
- System Board (bottom)
- Top Cover
- Display Panel Assembly
- Camera Privacy Slider
- Display Bezel
- Webcam
- Display Panel
- Display Panel Cable
- Hinges
- Antennas

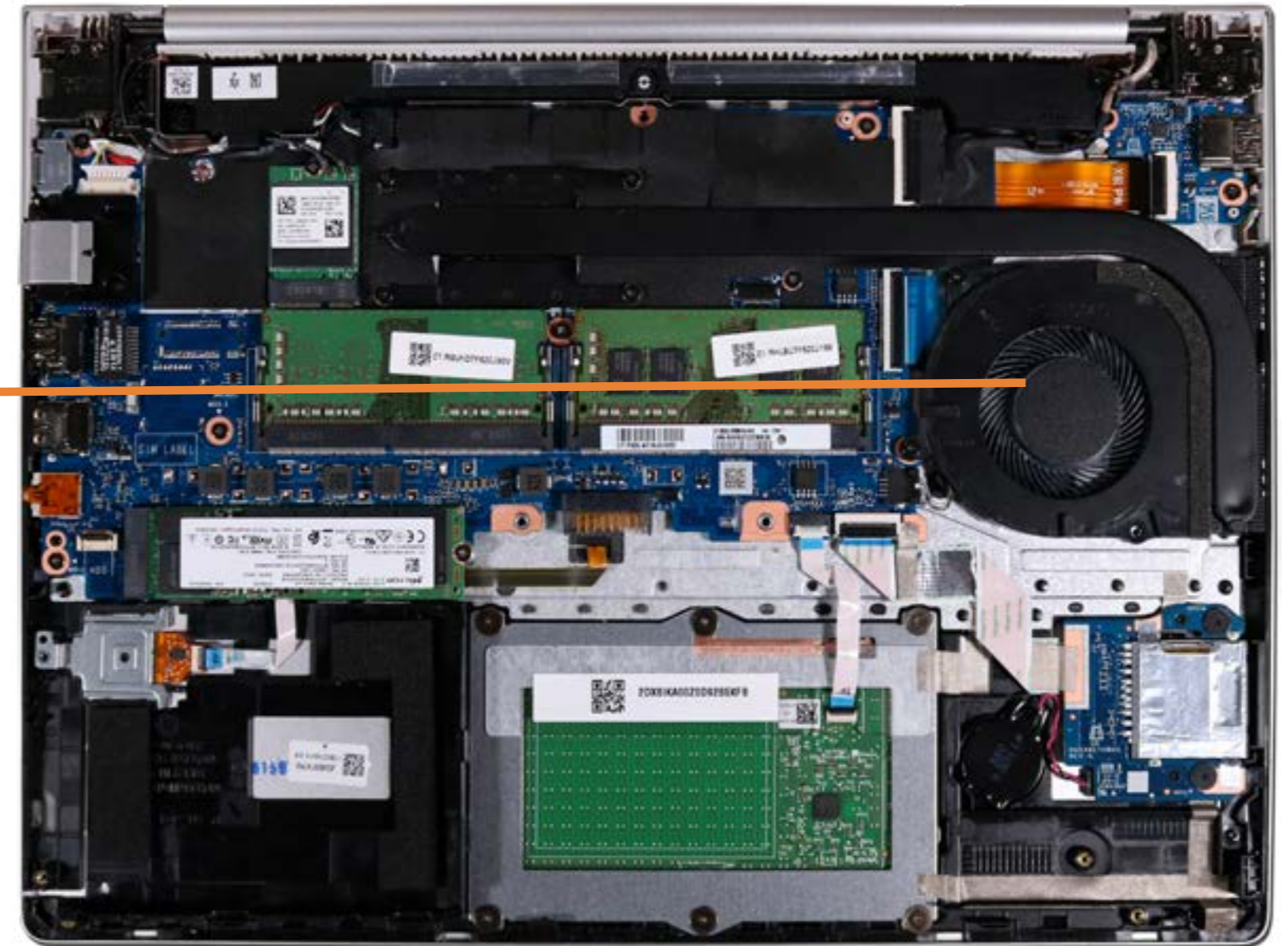

[Go to External Views](#)



# Heat Sink

- Battery
- Base Enclosure
- Solid State Drive
- Wireless LAN Module
- Memory Modules
- SD Card Reader
- RTC Battery
- Hard Drive
- Fingerprint Reader
- Fingerprint Reader Bracket
- Touchpad
- Speaker
- Fan
- Heat Sink**
- USB Board
- Power Connector Cable
- RJ-45 Bracket
- USB-C Bracket
- System Board (top)
- System Board (bottom)
- Top Cover
- Display Panel Assembly
- Camera Privacy Slider
- Display Bezel
- Webcam
- Display Panel
- Display Panel Cable
- Hinges
- Antennas

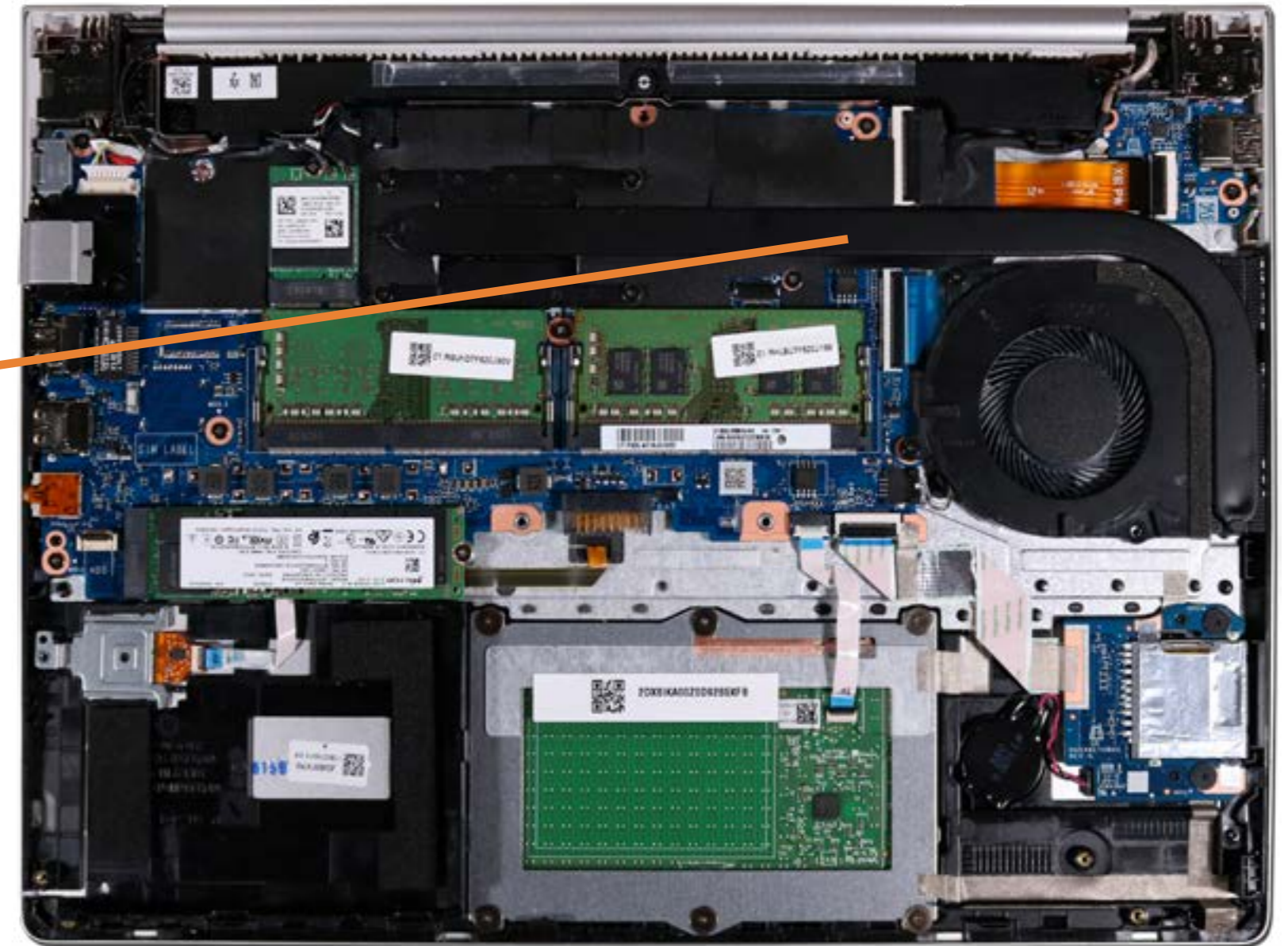

[Go to External Views](#)



# USB Board

- Battery
- Base Enclosure
- Solid State Drive
- Wireless LAN Module
- Memory Modules
- SD Card Reader
- RTC Battery
- Hard Drive
- Fingerprint Reader
- Fingerprint Reader Bracket
- Touchpad
- Speaker
- Fan
- Heat Sink
- USB Board**
- Power Connector Cable
- RJ-45 Bracket
- USB-C Bracket
- System Board (top)
- System Board (bottom)
- Top Cover
- Display Panel Assembly
- Camera Privacy Slider
- Display Bezel
- Webcam
- Display Panel
- Display Panel Cable
- Hinges
- Antennas

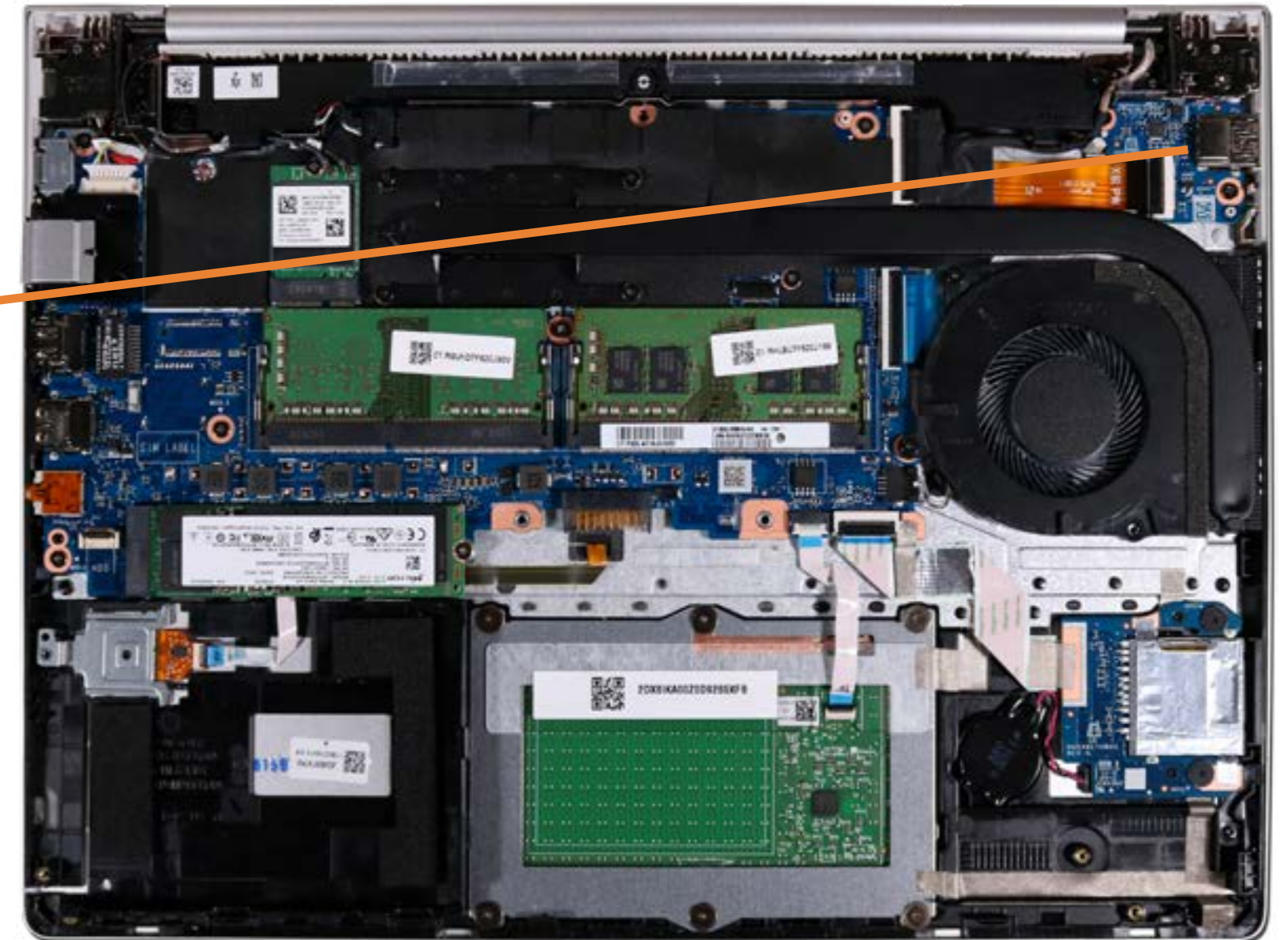
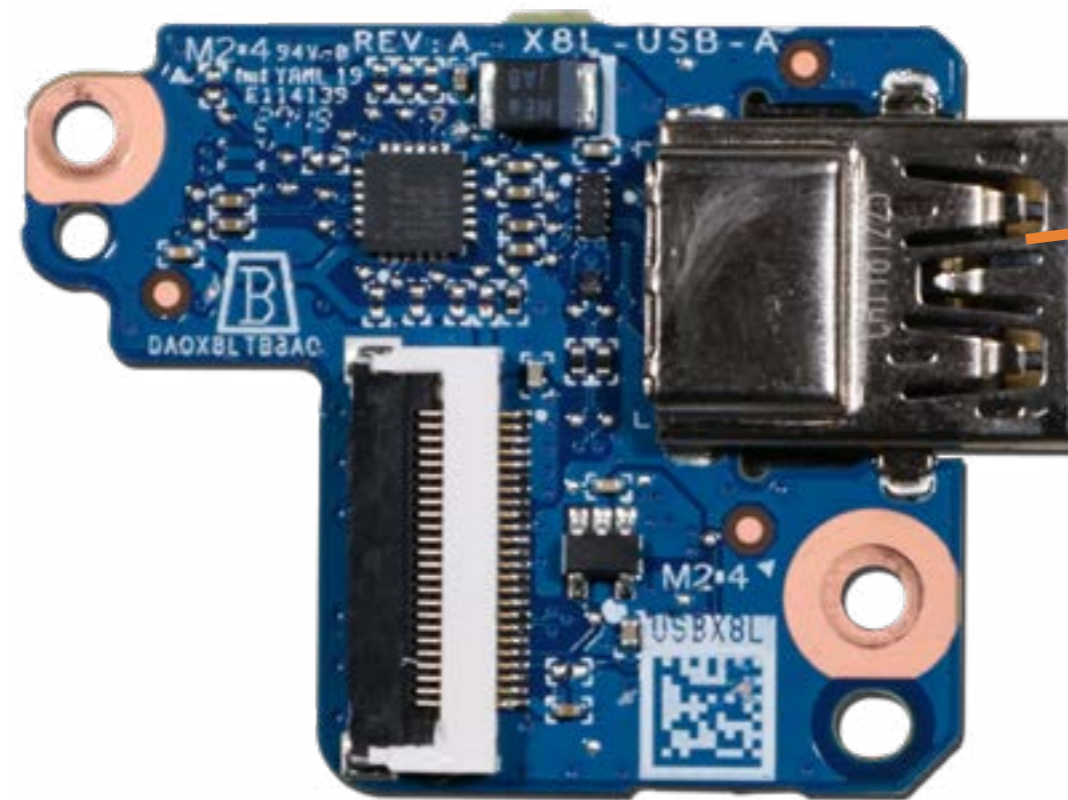

[Go to External Views](#)



# Power Connector Cable

- Battery
- Base Enclosure
- Solid State Drive
- Wireless LAN Module
- Memory Modules
- SD Card Reader
- RTC Battery
- Hard Drive
- Fingerprint Reader
- Fingerprint Reader Bracket
- Touchpad
- Speaker
- Fan
- Heat Sink
- USB Board
- Power Connector Cable**
- RJ-45 Bracket
- USB-C Bracket
- System Board (top)
- System Board (bottom)
- Top Cover
- Display Panel Assembly
- Camera Privacy Slider
- Display Bezel
- Webcam
- Display Panel
- Display Panel Cable
- Hinges
- Antennas



[Go to External Views](#)



# RJ-45 Bracket

- Battery
- Base Enclosure
- Solid State Drive
- Wireless LAN Module
- Memory Modules
- SD Card Reader
- RTC Battery
- Hard Drive
- Fingerprint Reader
- Fingerprint Reader Bracket
- Touchpad
- Speaker
- Fan
- Heat Sink
- USB Board
- Power Connector Cable
- RJ-45 Bracket**
- USB-C Bracket
- System Board (top)
- System Board (bottom)
- Top Cover
- Display Panel Assembly
- Camera Privacy Slider
- Display Bezel
- Webcam
- Display Panel
- Display Panel Cable
- Hinges
- Antennas

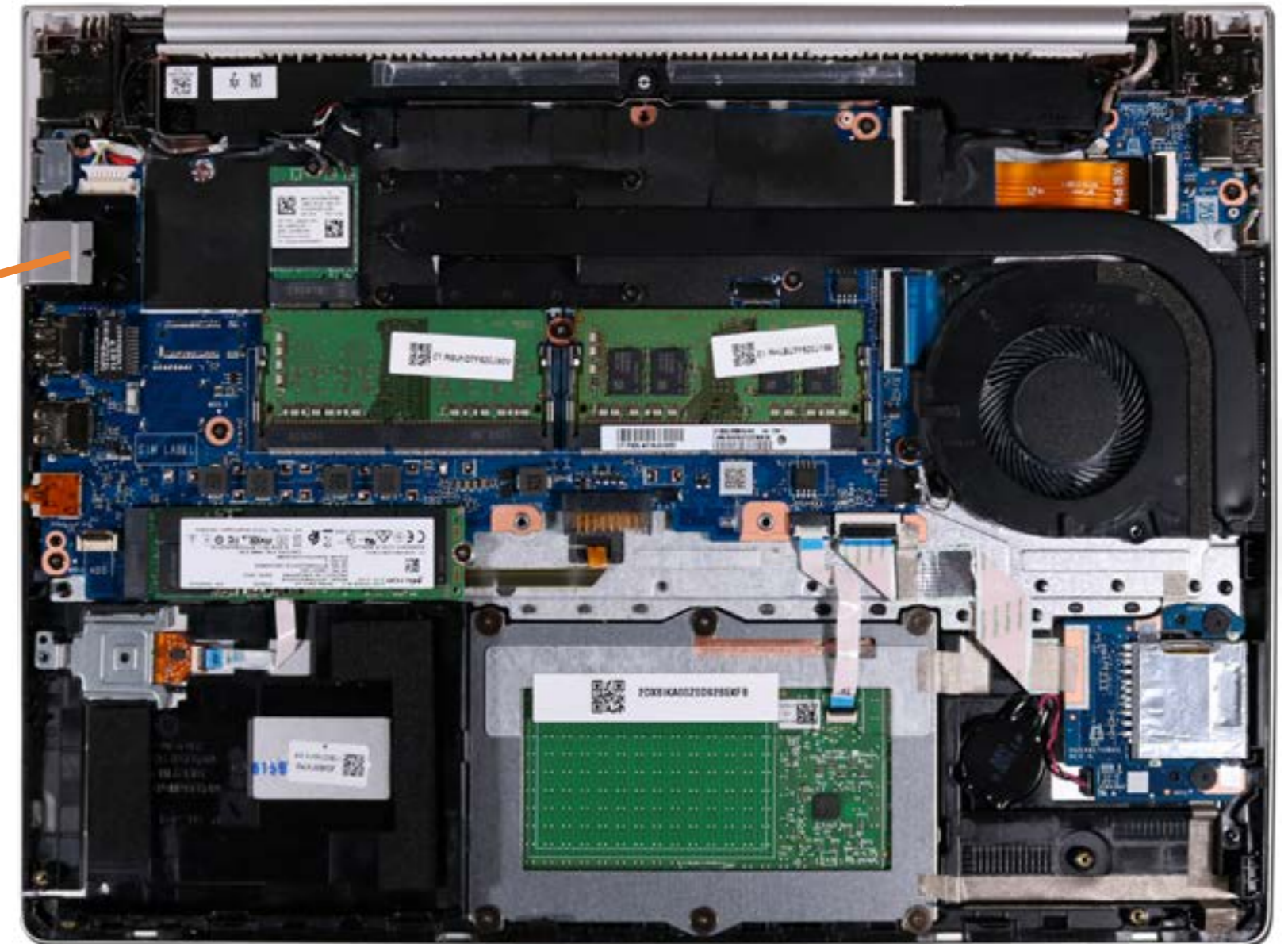

[Go to External Views](#)



# USB-C Bracket

- Battery
- Base Enclosure
- Solid State Drive
- Wireless LAN Module
- Memory Modules
- SD Card Reader
- RTC Battery
- Hard Drive
- Fingerprint Reader
- Fingerprint Reader Bracket
- Touchpad
- Speaker
- Fan
- Heat Sink
- USB Board
- Power Connector Cable
- RJ-45 Bracket
- USB-C Bracket**
- System Board (top)
- System Board (bottom)
- Top Cover
- Display Panel Assembly
- Camera Privacy Slider
- Display Bezel
- Webcam
- Display Panel
- Display Panel Cable
- Hinges
- Antennas

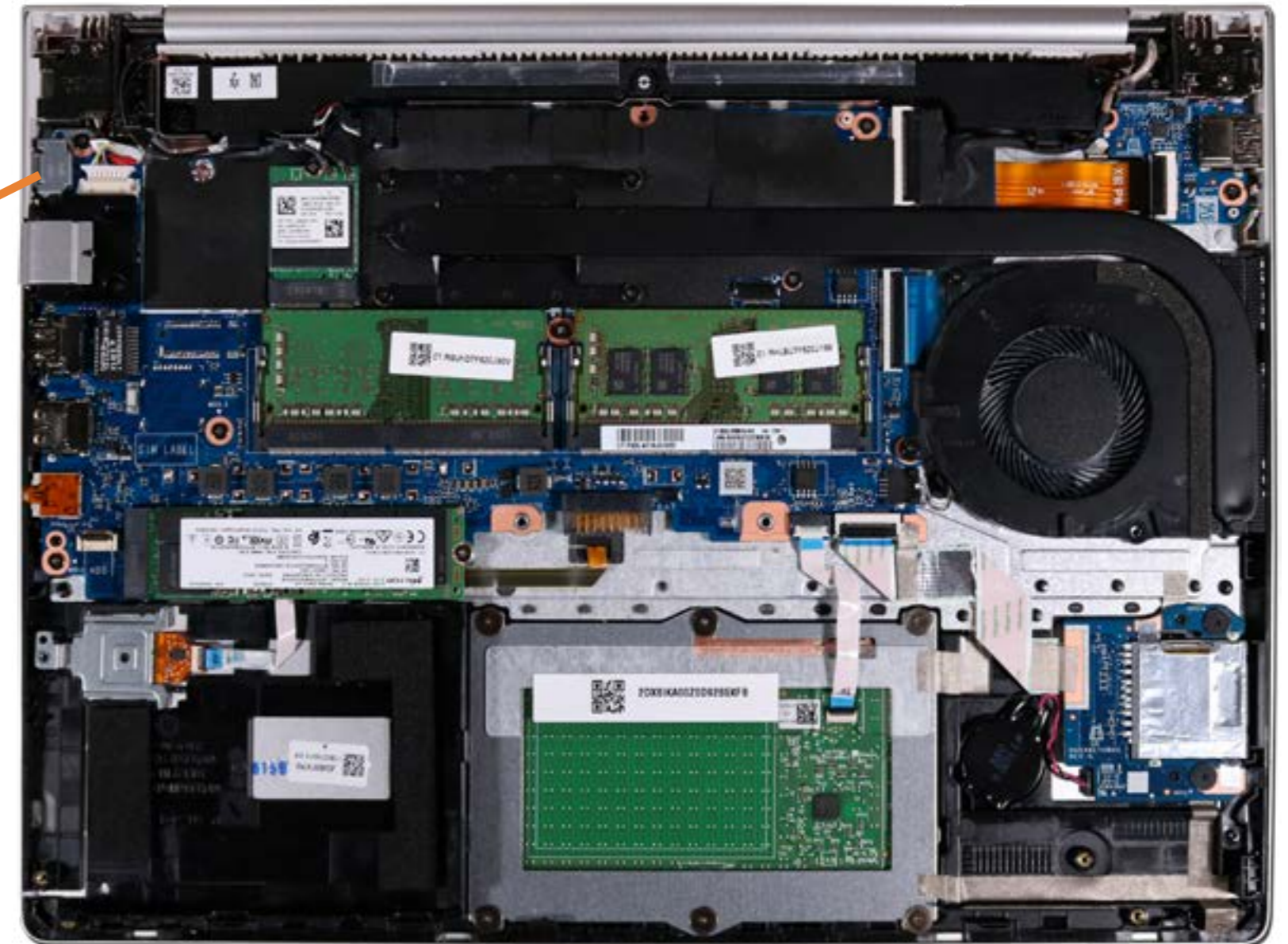

[Go to External Views](#)



# System Board (top)

- Battery
- Base Enclosure
- Solid State Drive
- Wireless LAN Module
- Memory Modules
- SD Card Reader
- RTC Battery
- Hard Drive
- Fingerprint Reader
- Fingerprint Reader Bracket
- Touchpad
- Speaker
- Fan
- Heat Sink
- USB Board
- Power Connector Cable
- RJ-45 Bracket
- USB-C Bracket
- System Board (top)**
- System Board (bottom)
- Top Cover
- Display Panel Assembly
- Camera Privacy Slider
- Display Bezel
- Webcam
- Display Panel
- Display Panel Cable
- Hinges
- Antennas

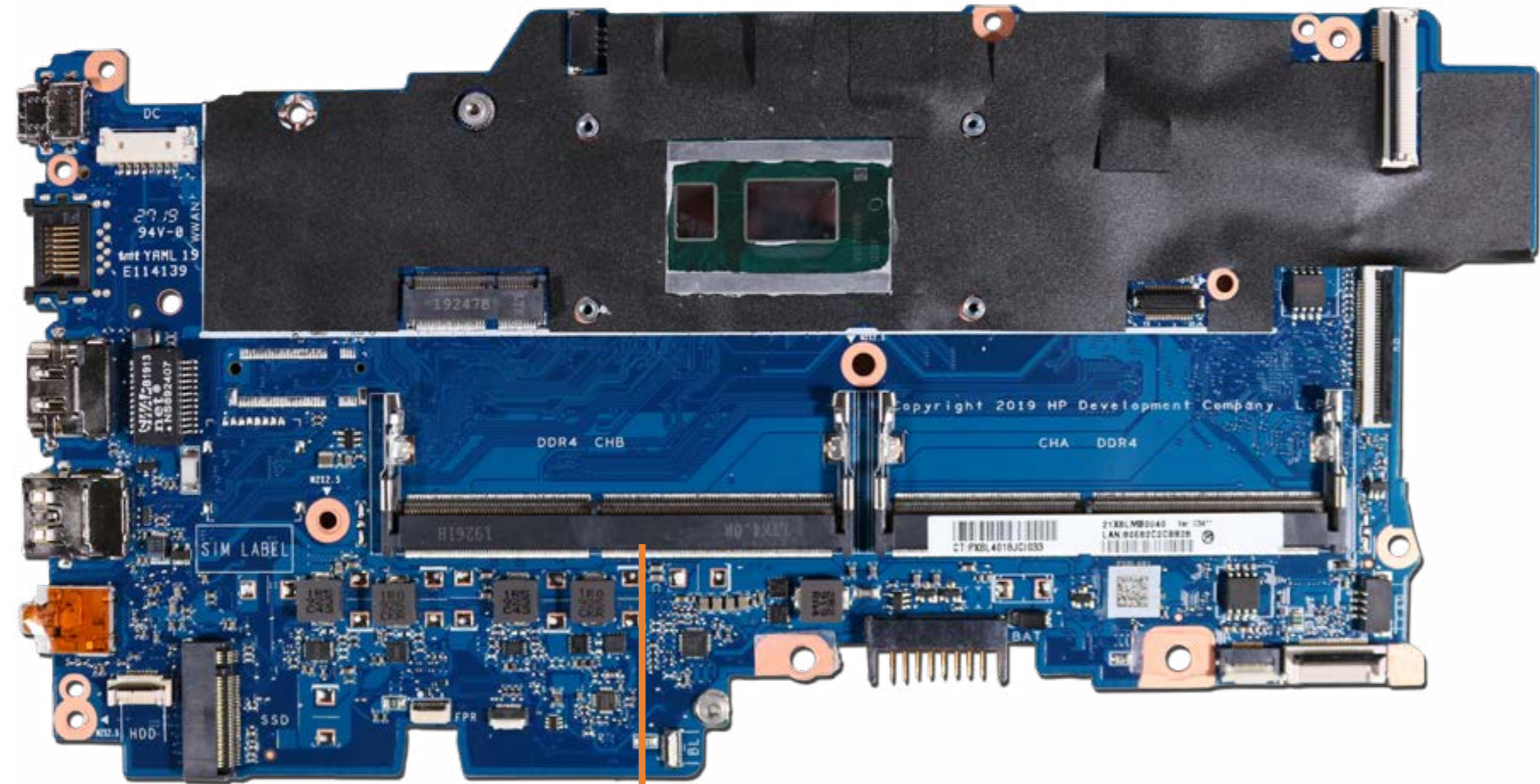

[Go to External Views](#)



# System Board (bottom)

- Battery
- Base Enclosure
- Solid State Drive
- Wireless LAN Module
- Memory Modules
- SD Card Reader
- RTC Battery
- Hard Drive
- Fingerprint Reader
- Fingerprint Reader Bracket
- Touchpad
- Speaker
- Fan
- Heat Sink
- USB Board
- Power Connector Cable
- RJ-45 Bracket
- USB-C Bracket
- System Board (top)
- System Board (bottom)**
- Top Cover
- Display Panel Assembly
- Camera Privacy Slider
- Display Bezel
- Webcam
- Display Panel
- Display Panel Cable
- Hinges
- Antennas

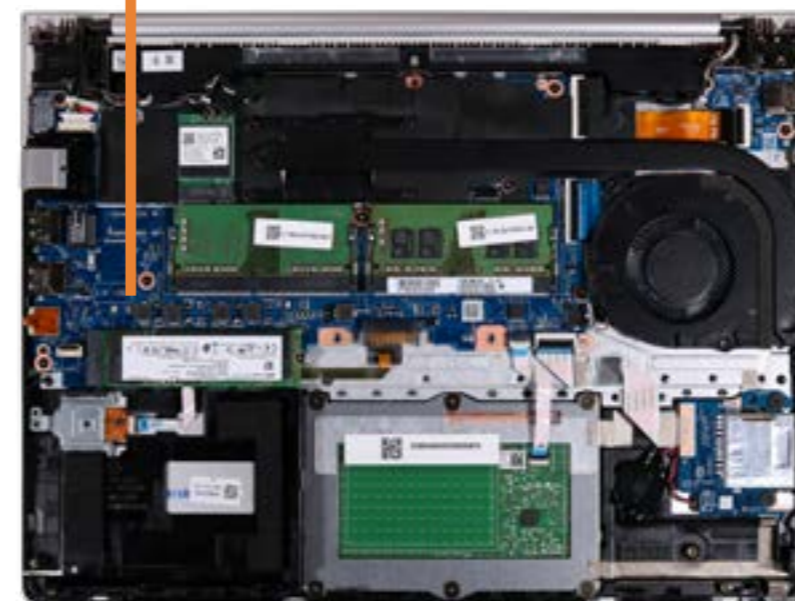
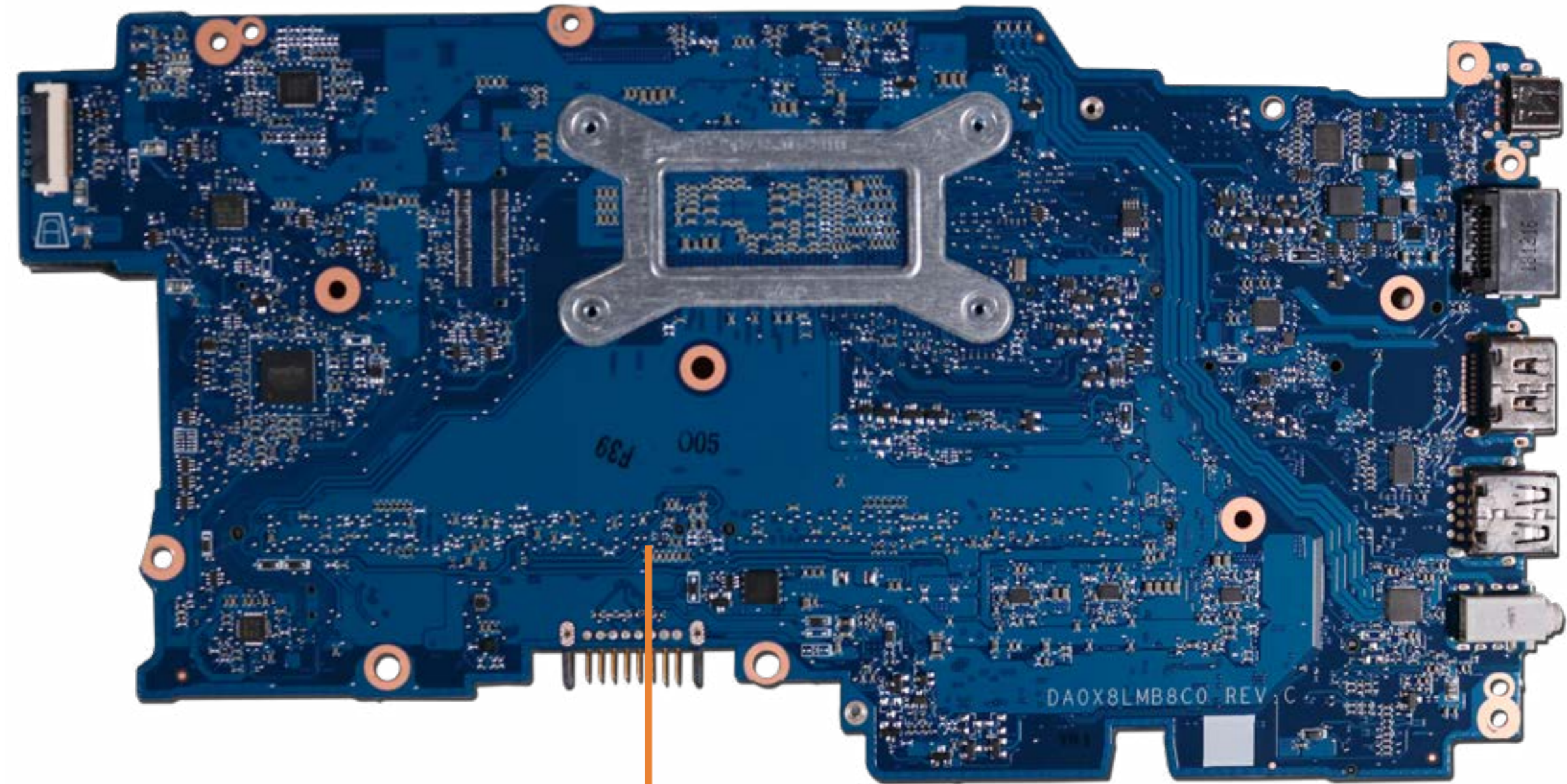

[Go to External Views](#)



# Top Cover

- Battery
- Base Enclosure
- Solid State Drive
- Wireless LAN Module
- Memory Modules
- SD Card Reader
- RTC Battery
- Hard Drive
- Fingerprint Reader
- Fingerprint Reader Bracket
- Touchpad
- Speaker
- Fan
- Heat Sink
- USB Board
- Power Connector Cable
- RJ-45 Bracket
- USB-C Bracket
- System Board (top)
- System Board (bottom)
- Top Cover**
- Display Panel Assembly
- Camera Privacy Slider
- Display Bezel
- Webcam
- Display Panel
- Display Panel Cable
- Hinges
- Antennas



[Go to External Views](#)

# Display Panel Assembly

- Battery
- Base Enclosure
- Solid State Drive
- Wireless LAN Module
- Memory Modules
- SD Card Reader
- RTC Battery
- Hard Drive
- Fingerprint Reader
- Fingerprint Reader Bracket
- Touchpad
- Speaker
- Fan
- Heat Sink
- USB Board
- Power Connector Cable
- RJ-45 Bracket
- USB-C Bracket
- System Board (top)
- System Board (bottom)
- Top Cover
- Display Panel Assembly**
- Camera Privacy Slider
- Display Bezel
- Webcam
- Display Panel
- Display Panel Cable
- Hinges
- Antennas



[Go to External Views](#)

# Camera Privacy Slider

- Battery
- Base Enclosure
- Solid State Drive
- Wireless LAN Module
- Memory Modules
- SD Card Reader
- RTC Battery
- Hard Drive
- Fingerprint Reader
- Fingerprint Reader Bracket
- Touchpad
- Speaker
- Fan
- Heat Sink
- USB Board
- Power Connector Cable
- RJ-45 Bracket
- USB-C Bracket
- System Board (top)
- System Board (bottom)
- Top Cover
- Display Panel Assembly
- Camera Privacy Slider**
- Display Bezel
- Webcam
- Display Panel
- Display Panel Cable
- Hinges
- Antennas



[Go to External Views](#)



# Display Bezel

- Battery
- Base Enclosure
- Solid State Drive
- Wireless LAN Module
- Memory Modules
- SD Card Reader
- RTC Battery
- Hard Drive
- Fingerprint Reader
- Fingerprint Reader Bracket
- Touchpad
- Speaker
- Fan
- Heat Sink
- USB Board
- Power Connector Cable
- RJ-45 Bracket
- USB-C Bracket
- System Board (top)
- System Board (bottom)
- Top Cover
- Display Panel Assembly
- Camera Privacy Slider
- Display Bezel**
- Webcam
- Display Panel
- Display Panel Cable
- Hinges
- Antennas



[Go to External Views](#)

# Webcam

- Battery
- Base Enclosure
- Solid State Drive
- Wireless LAN Module
- Memory Modules
- SD Card Reader
- RTC Battery
- Hard Drive
- Fingerprint Reader
- Fingerprint Reader Bracket
- Touchpad
- Speaker
- Fan
- Heat Sink
- USB Board
- Power Connector Cable
- RJ-45 Bracket
- USB-C Bracket
- System Board (top)
- System Board (bottom)
- Top Cover
- Display Panel Assembly
- Camera Privacy Slider
- Display Bezel
- Webcam**
- Display Panel
- Display Panel Cable
- Hinges
- Antennas



[Go to External Views](#)

# Display Panel

- Battery
- Base Enclosure
- Solid State Drive
- Wireless LAN Module
- Memory Modules
- SD Card Reader
- RTC Battery
- Hard Drive
- Fingerprint Reader
- Fingerprint Reader Bracket
- Touchpad
- Speaker
- Fan
- Heat Sink
- USB Board
- Power Connector Cable
- RJ-45 Bracket
- USB-C Bracket
- System Board (top)
- System Board (bottom)
- Top Cover
- Display Panel Assembly
- Camera Privacy Slider
- Display Bezel
- Webcam
- Display Panel**
- Display Panel Cable
- Hinges
- Antennas



[Go to External Views](#)



# Display Panel Cable

- Battery
- Base Enclosure
- Solid State Drive
- Wireless LAN Module
- Memory Modules
- SD Card Reader
- RTC Battery
- Hard Drive
- Fingerprint Reader
- Fingerprint Reader Bracket
- Touchpad
- Speaker
- Fan
- Heat Sink
- USB Board
- Power Connector Cable
- RJ-45 Bracket
- USB-C Bracket
- System Board (top)
- System Board (bottom)
- Top Cover
- Display Panel Assembly
- Camera Privacy Slider
- Display Bezel
- Webcam
- Display Panel
- Display Panel Cable**
- Hinges
- Antennas

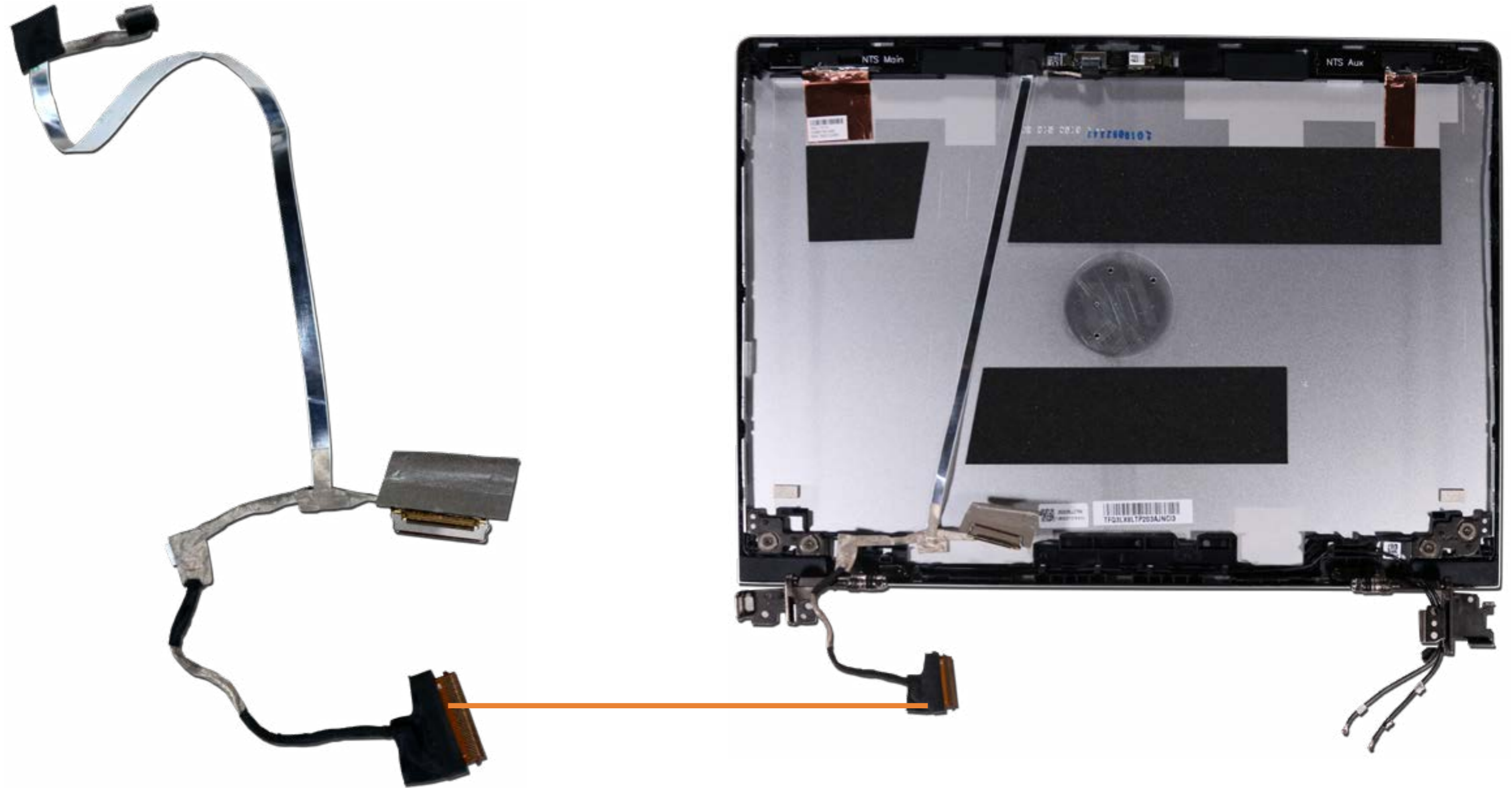

[Go to External Views](#)

# Hinges

- Battery
- Base Enclosure
- Solid State Drive
- Wireless LAN Module
- Memory Modules
- SD Card Reader
- RTC Battery
- Hard Drive
- Fingerprint Reader
- Fingerprint Reader Bracket
- Touchpad
- Speaker
- Fan
- Heat Sink
- USB Board
- Power Connector Cable
- RJ-45 Bracket
- USB-C Bracket
- System Board (top)
- System Board (bottom)
- Top Cover
- Display Panel Assembly
- Camera Privacy Slider
- Display Bezel
- Webcam
- Display Panel
- Display Panel Cable
- Hinges**
- Antennas

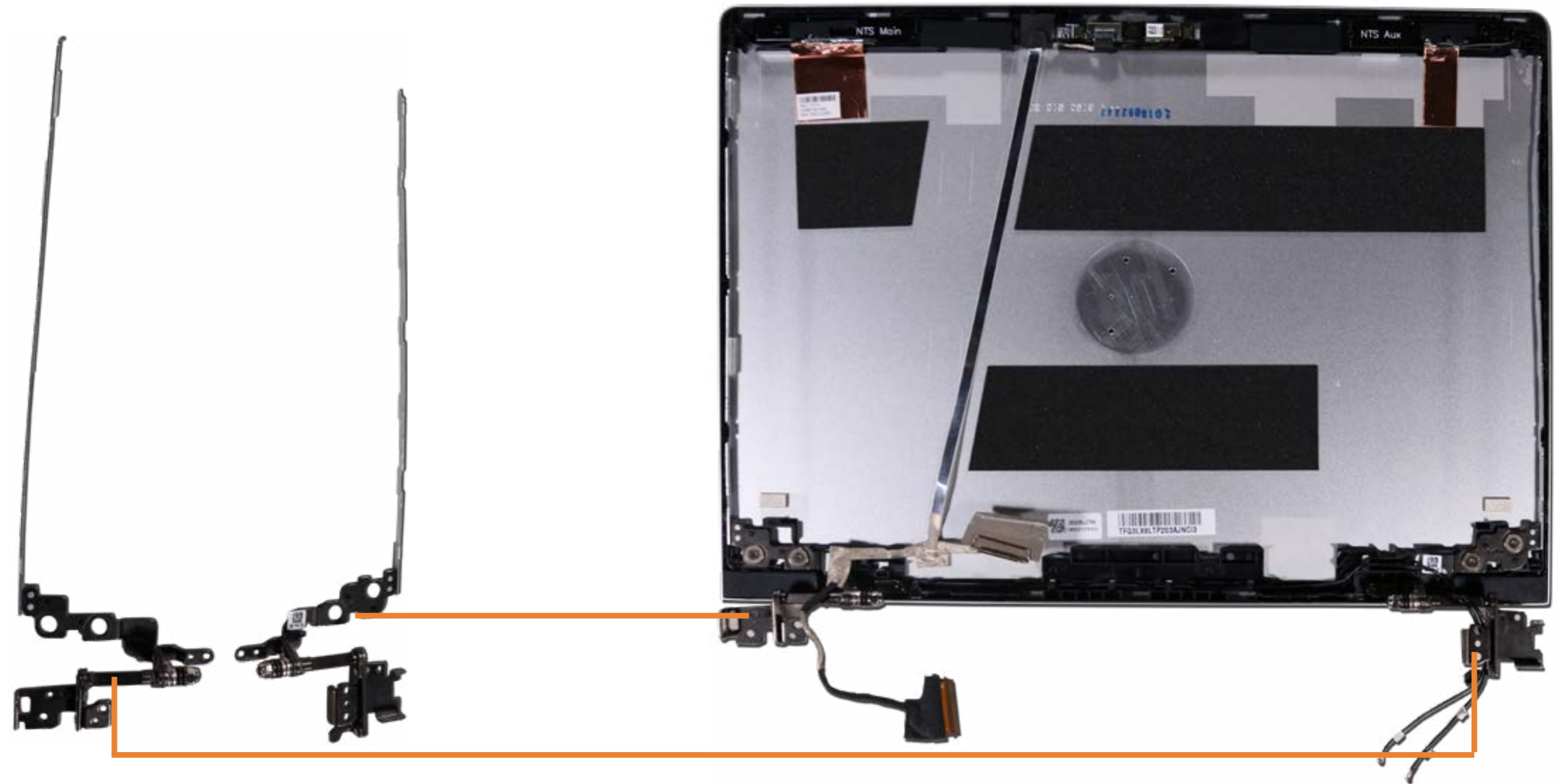

[Go to External Views](#)



# Antennas

- Battery
- Base Enclosure
- Solid State Drive
- Wireless LAN Module
- Memory Modules
- SD Card Reader
- RTC Battery
- Hard Drive
- Fingerprint Reader
- Fingerprint Reader Bracket
- Touchpad
- Speaker
- Fan
- Heat Sink
- USB Board
- Power Connector Cable
- RJ-45 Bracket
- USB-C Bracket
- System Board (top)
- System Board (bottom)
- Top Cover
- Display Panel Assembly
- Camera Privacy Slider
- Display Bezel
- Webcam
- Display Panel
- Display Panel Cable
- Hinges

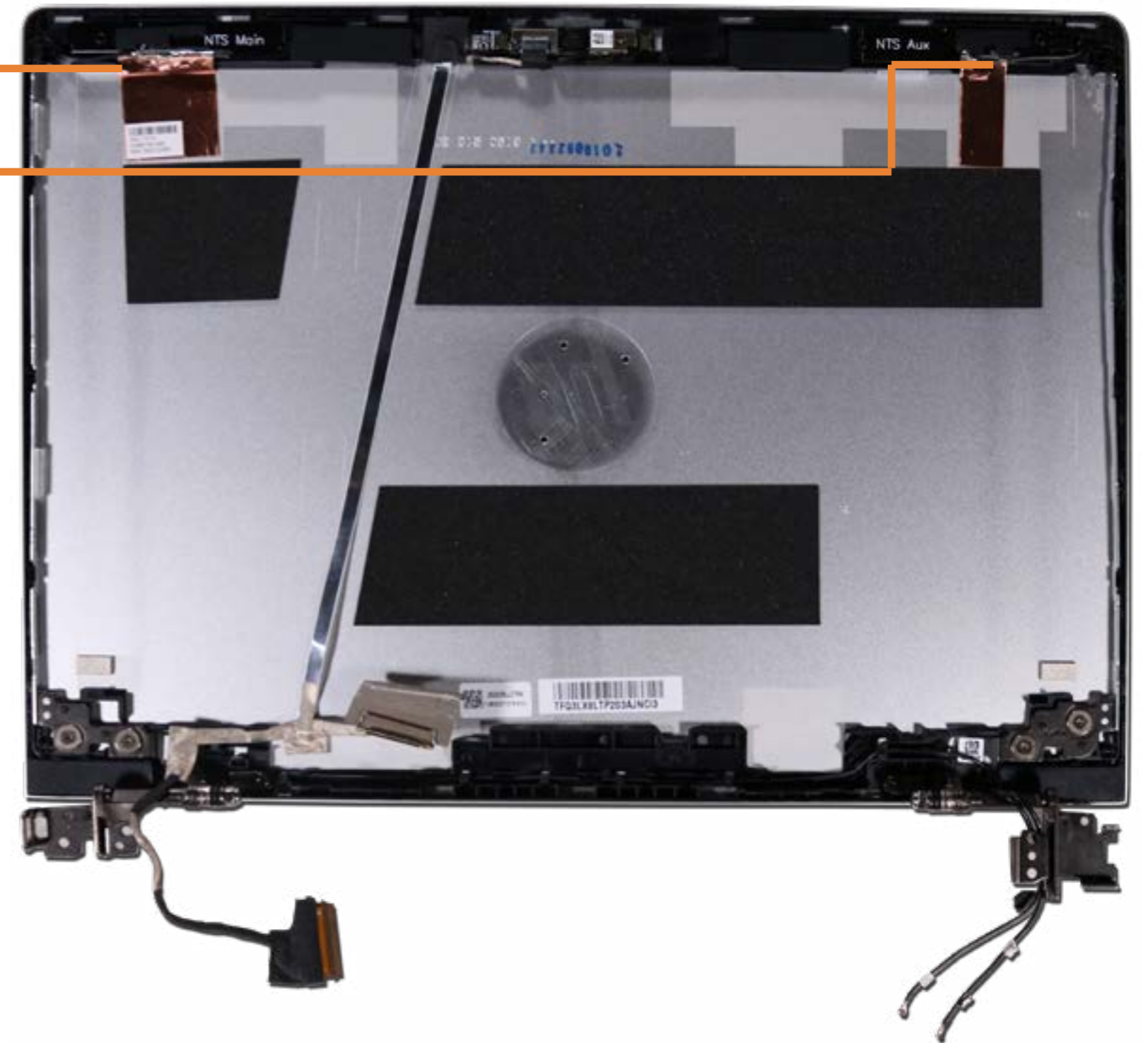
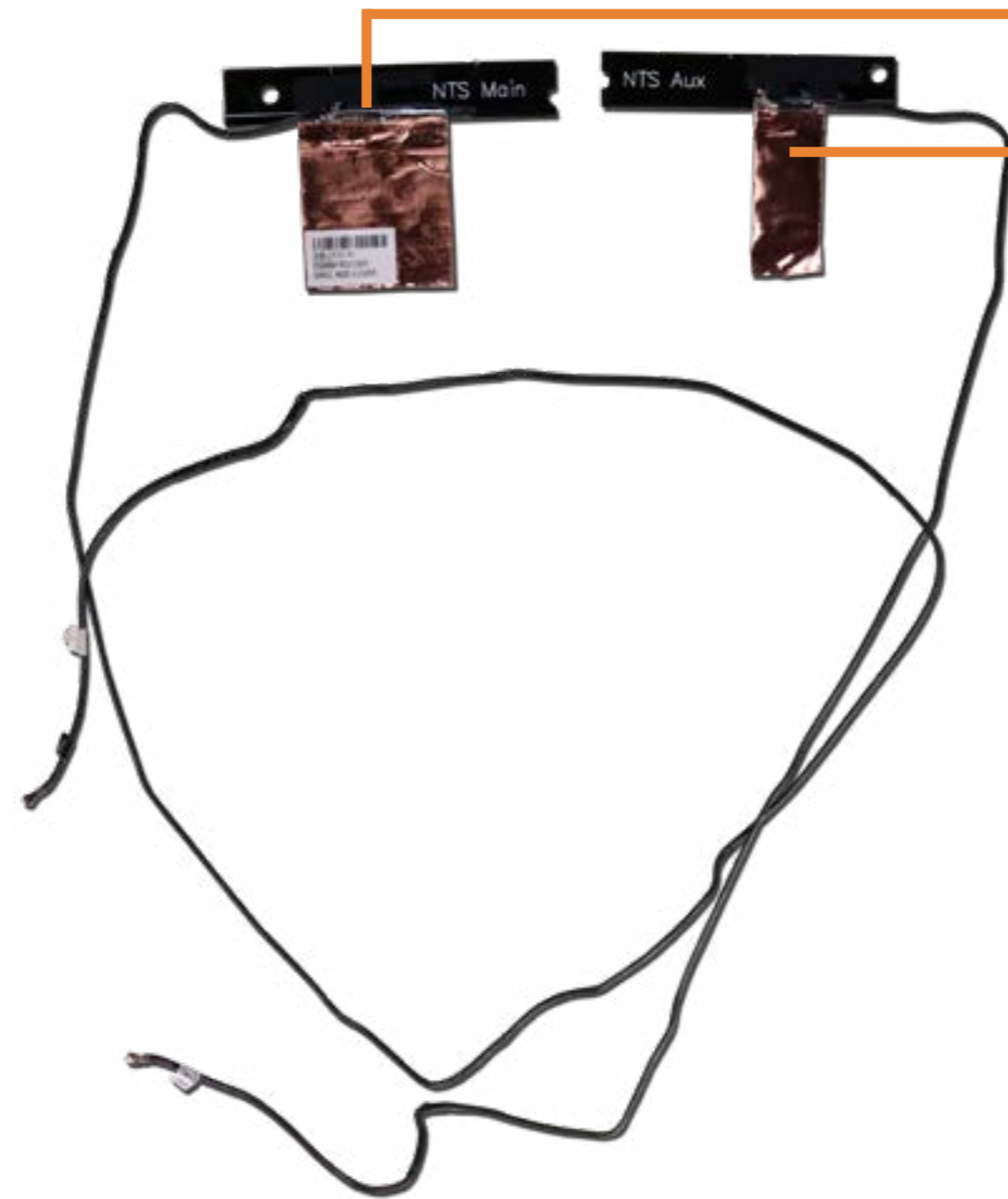

Antennas

[Go to External Views](#)