

Interactive Part Locator

OMEN by HP 873-xxxx Desktop PC

Welcome to this interactive part locator

Here's how to use it...

[External Views](#) (Click the link to navigate to the views)

On this page you will find large icons of each of the external views of this product. To view a specific view in greater detail, simply click that view.

[Parts List](#) (Click the link to navigate to the parts)

On this page, you will find a list of all of the replaceable parts for this product. To view a specific part and its location in the product, click the part name in the list.

That's it! On every page there is a link that brings you back to either the External Views or the Parts List, enabling you to navigate to whatever view or part you wish to review.

External Views

[Back to Welcome page](#)



Front



Left



Right



Rear



Bottom



Internal

[Go to Parts List](#)

Front View

[Back to External Views](#)

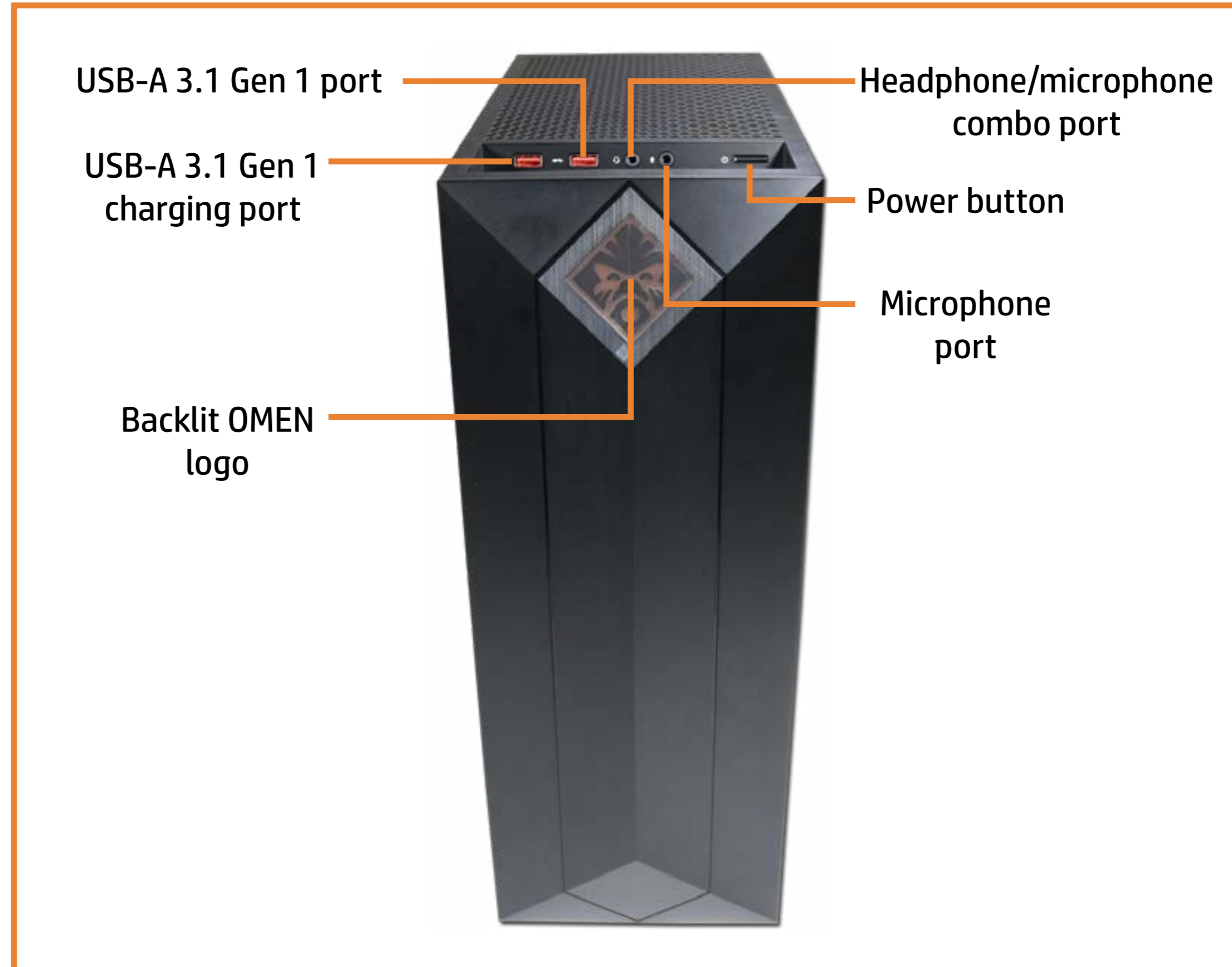

[Go to Parts List](#)

Left View

[Back to External Views](#)



Access panel

[Go to Parts List](#)

Right View

[Back to External Views](#)



Side panel

[Go to Parts List](#)

Rear View

[Back to External Views](#)

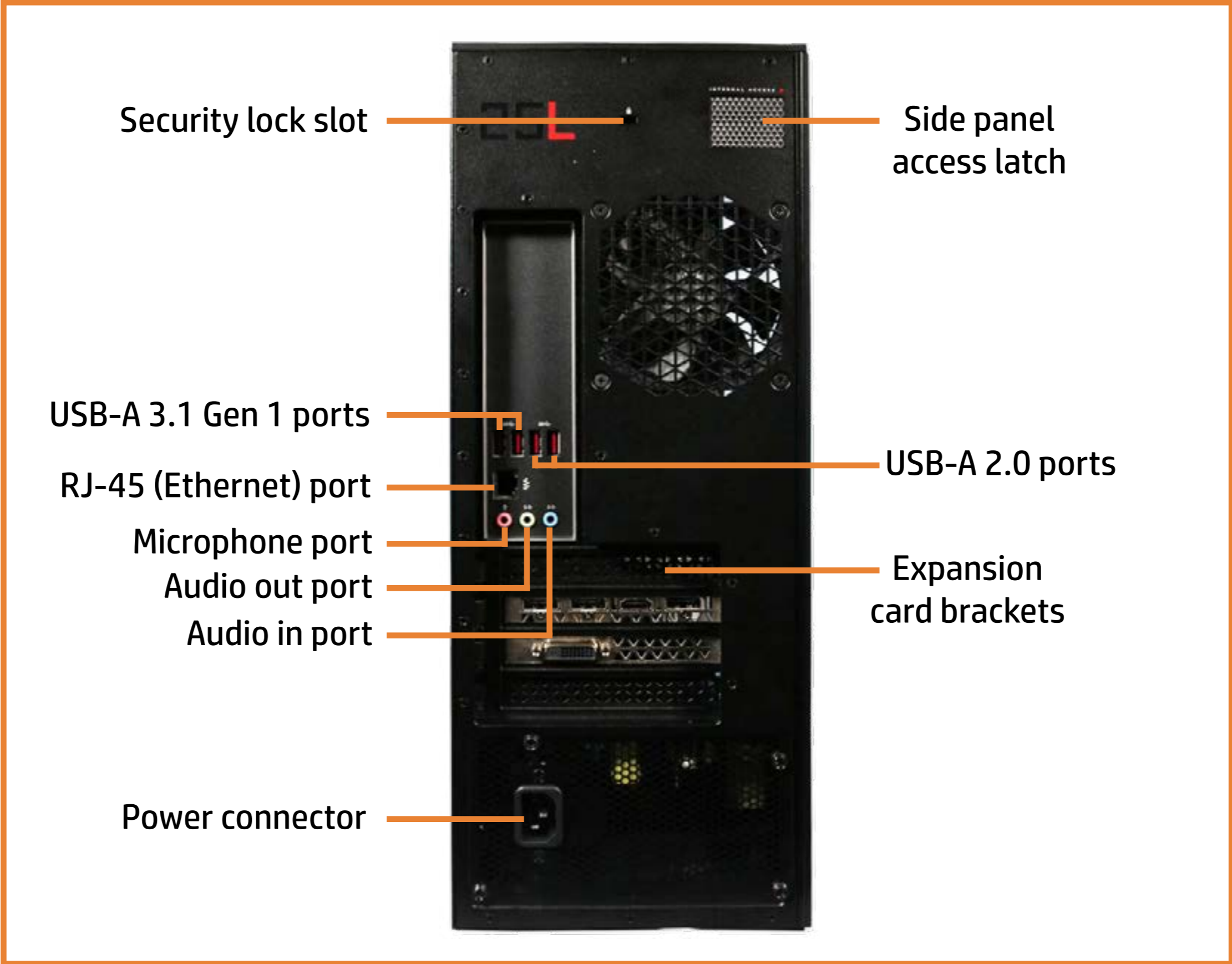

[Go to Parts List](#)

Bottom View

[Back to External Views](#)

Rubber foot



Rubber foot

[Go to Parts List](#)

Internal View

[Back to External Views](#)

Graphics card

Power supply

Wireless LAN module

Rear system fan

System fan

System memory

Motherboard

M.2 SSD or Intel
Optane module

Hard drive

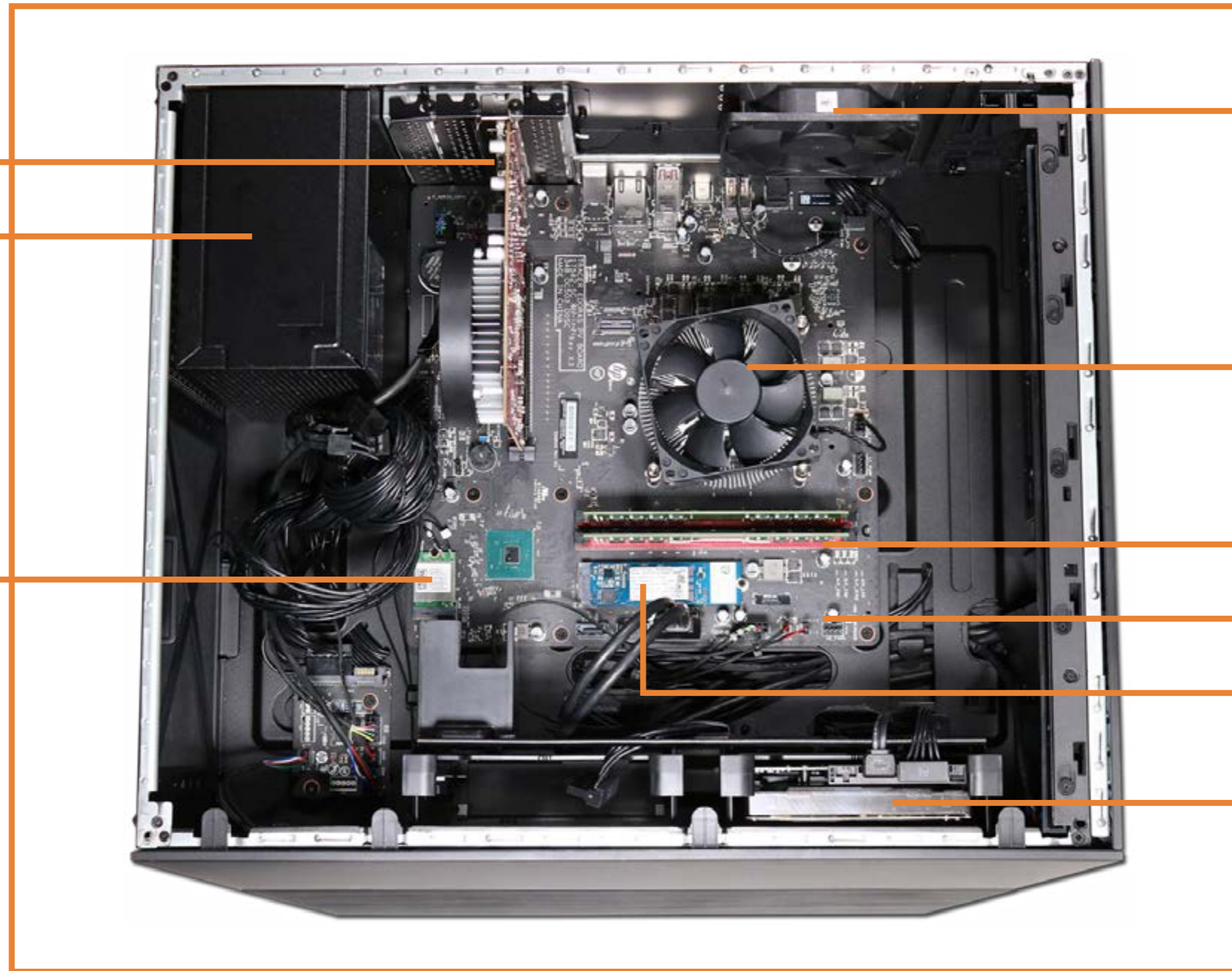

[Go to Parts List](#)

Hard drive

Hard drive

- System memory
- M.2 SSD or Intel Optane module
- Graphics card
- Wireless LAN module
- Rear system fan
- System fan
- Heat sink
- CPU
- Motherboard (top)
- Motherboard (bottom)
- Side panel
- Power supply
- Front bezel
- Front lighting module assembly
- Front lighting module (OMEN logo)
- Top bezel
- Top I/O module
- Wireless LAN antennas



Go to External Views

System memory

- Hard drive
- System memory**
- M.2 SSD or Intel Optane module
- Graphics card
- Wireless LAN module
- Rear system fan
- System fan
- Heat sink
- CPU
- Motherboard (top)
- Motherboard (bottom)
- Side panel
- Power supply
- Front bezel
- Front lighting module assembly
- Front lighting module (OMEN logo)
- Top bezel
- Top I/O module
- Wireless LAN antennas

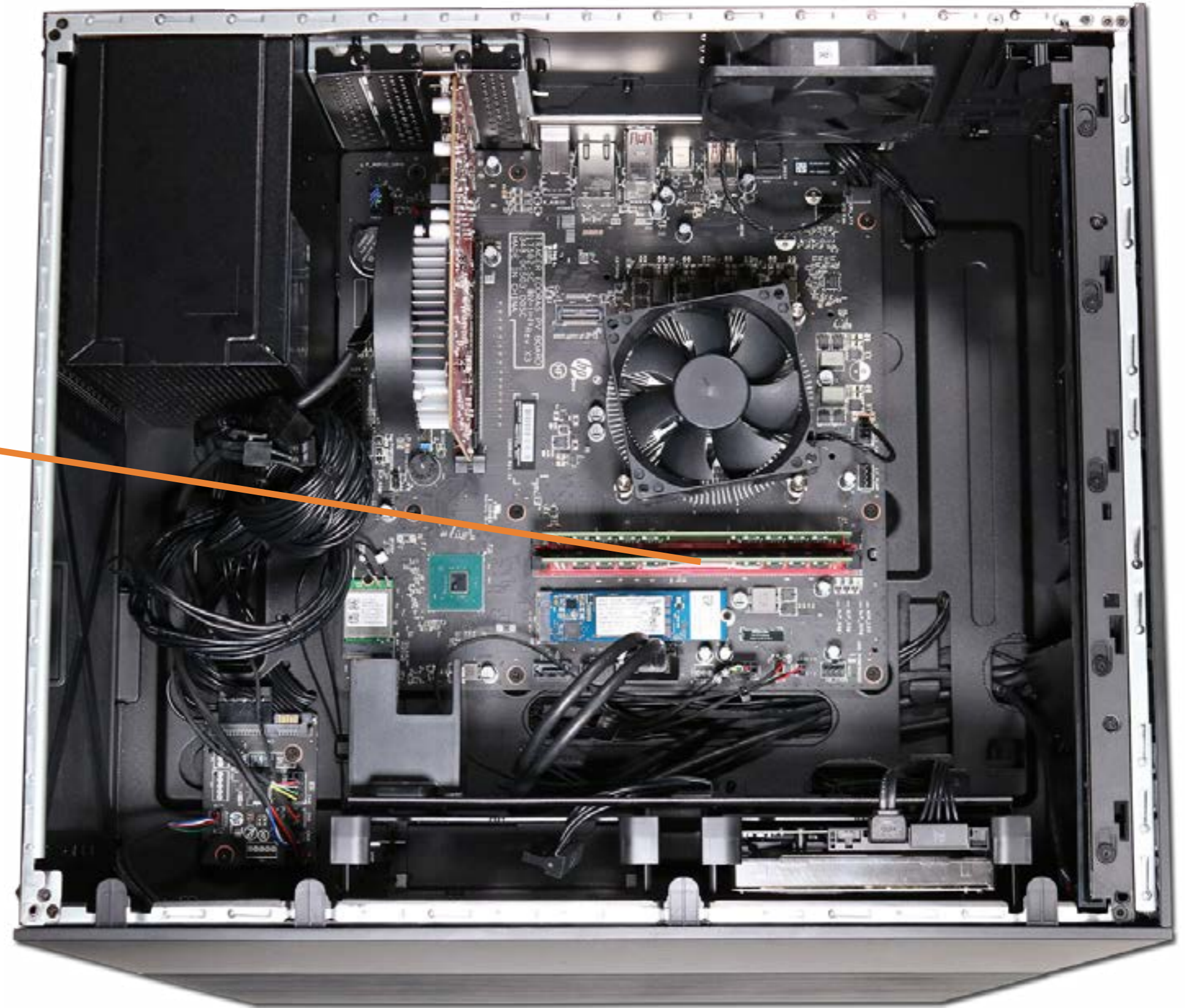

[Go to External Views](#)

M.2 SSD or Intel Optane module

- Hard drive
- System memory
- M.2 SSD or Intel Optane module**
- Graphics card
- Wireless LAN module
- Rear system fan
- System fan
- Heat sink
- CPU
- Motherboard (top)
- Motherboard (bottom)
- Side panel
- Power supply
- Front bezel
- Front lighting module assembly
- Front lighting module (OMEN logo)
- Top bezel
- Top I/O module
- Wireless LAN antennas



[Go to External Views](#)

Graphics card

- Hard drive
- System memory
- M.2 SSD or Intel Optane module
- Graphics card**
- Wireless LAN module
- Rear system fan
- System fan
- Heat sink
- CPU
- Motherboard (top)
- Motherboard (bottom)
- Side panel
- Power supply
- Front bezel
- Front lighting module assembly
- Front lighting module (OMEN logo)
- Top bezel
- Top I/O module
- Wireless LAN antennas

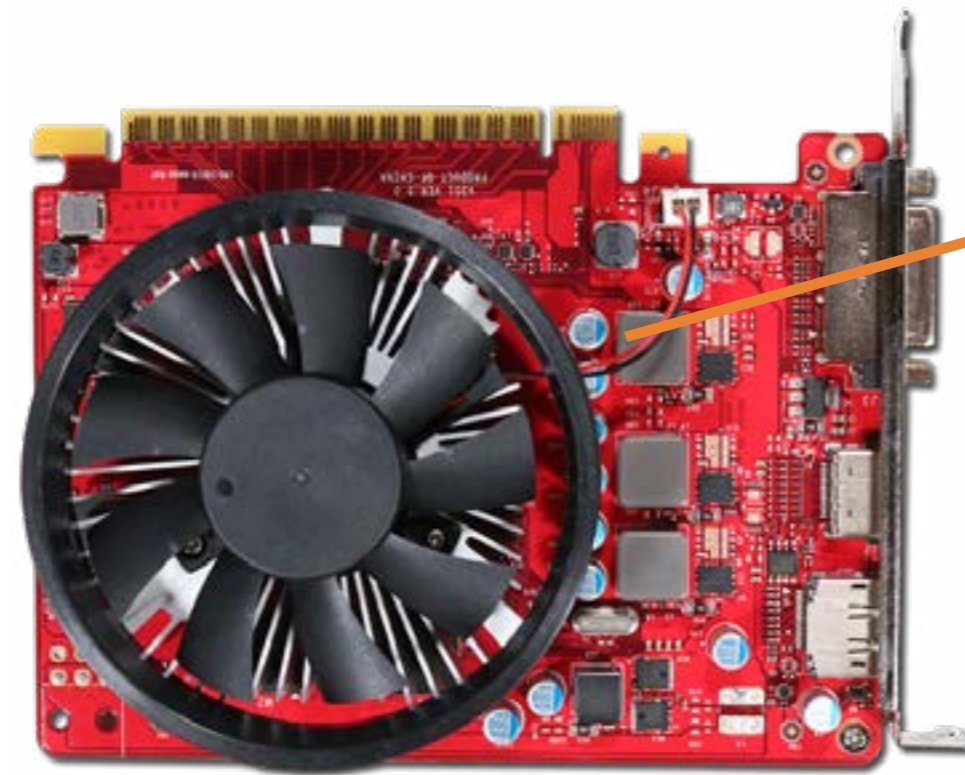

[Go to External Views](#)

Wireless LAN module

- Hard drive
- System memory
- M.2 SSD or Intel Optane module
- Graphics card
- Wireless LAN module**
- Rear system fan
- System fan
- Heat sink
- CPU
- Motherboard (top)
- Motherboard (bottom)
- Side panel
- Power supply
- Front bezel
- Front lighting module assembly
- Front lighting module (OMEN logo)
- Top bezel
- Top I/O module
- Wireless LAN antennas



[Go to External Views](#)

Rear system fan

- Hard drive
- System memory
- M.2 SSD or Intel Optane module
- Graphics card
- Wireless LAN module
- Rear system fan**
- System fan
- Heat sink
- CPU
- Motherboard (top)
- Motherboard (bottom)
- Side panel
- Power supply
- Front bezel
- Front lighting module assembly
- Front lighting module (OMEN logo)
- Top bezel
- Top I/O module
- Wireless LAN antennas



[Go to External Views](#)

System fan

- Hard drive
- System memory
- M.2 SSD or Intel Optane module
- Graphics card
- Wireless LAN module
- Rear system fan
- System fan**
- Heat sink
- CPU
- Motherboard (top)
- Motherboard (bottom)
- Side panel
- Power supply
- Front bezel
- Front lighting module assembly
- Front lighting module (OMEN logo)
- Top bezel
- Top I/O module
- Wireless LAN antennas



[Go to External Views](#)

Heat sink

- Hard drive
- System memory
- M.2 SSD or Intel Optane module
- Graphics card
- Wireless LAN module
- Rear system fan
- System fan
- Heat sink**
- CPU
- Motherboard (top)
- Motherboard (bottom)
- Side panel
- Power supply
- Front bezel
- Front lighting module assembly
- Front lighting module (OMEN logo)
- Top bezel
- Top I/O module
- Wireless LAN antennas



[Go to External Views](#)

CPU

- Hard drive
- System memory
- M.2 SSD or Intel Optane module
- Graphics card
- Wireless LAN module
- Rear system fan
- System fan
- Heat sink
- CPU**
- Motherboard (top)
- Motherboard (bottom)
- Side panel
- Power supply
- Front bezel
- Front lighting module assembly
- Front lighting module (OMEN logo)
- Top bezel
- Top I/O module
- Wireless LAN antennas



[Go to External Views](#)

Motherboard (top)

- Hard drive
- System memory
- M.2 SSD or Intel Optane module
- Graphics card
- Wireless LAN module
- Rear system fan
- System fan
- Heat sink
- CPU
- Motherboard (top)**
- Motherboard (bottom)
- Side panel
- Power supply
- Front bezel
- Front lighting module assembly
- Front lighting module (OMEN logo)
- Top bezel
- Top I/O module
- Wireless LAN antennas



[Go to External Views](#)

Motherboard (bottom)

- Hard drive
- System memory
- M.2 SSD or Intel Optane module
- Graphics card
- Wireless LAN module
- Rear system fan
- System fan
- Heat sink
- CPU
- Motherboard (top)
- Motherboard (bottom)**
- Side panel
- Power supply
- Front bezel
- Front lighting module assembly
- Front lighting module (OMEN logo)
- Top bezel
- Top I/O module
- Wireless LAN antennas

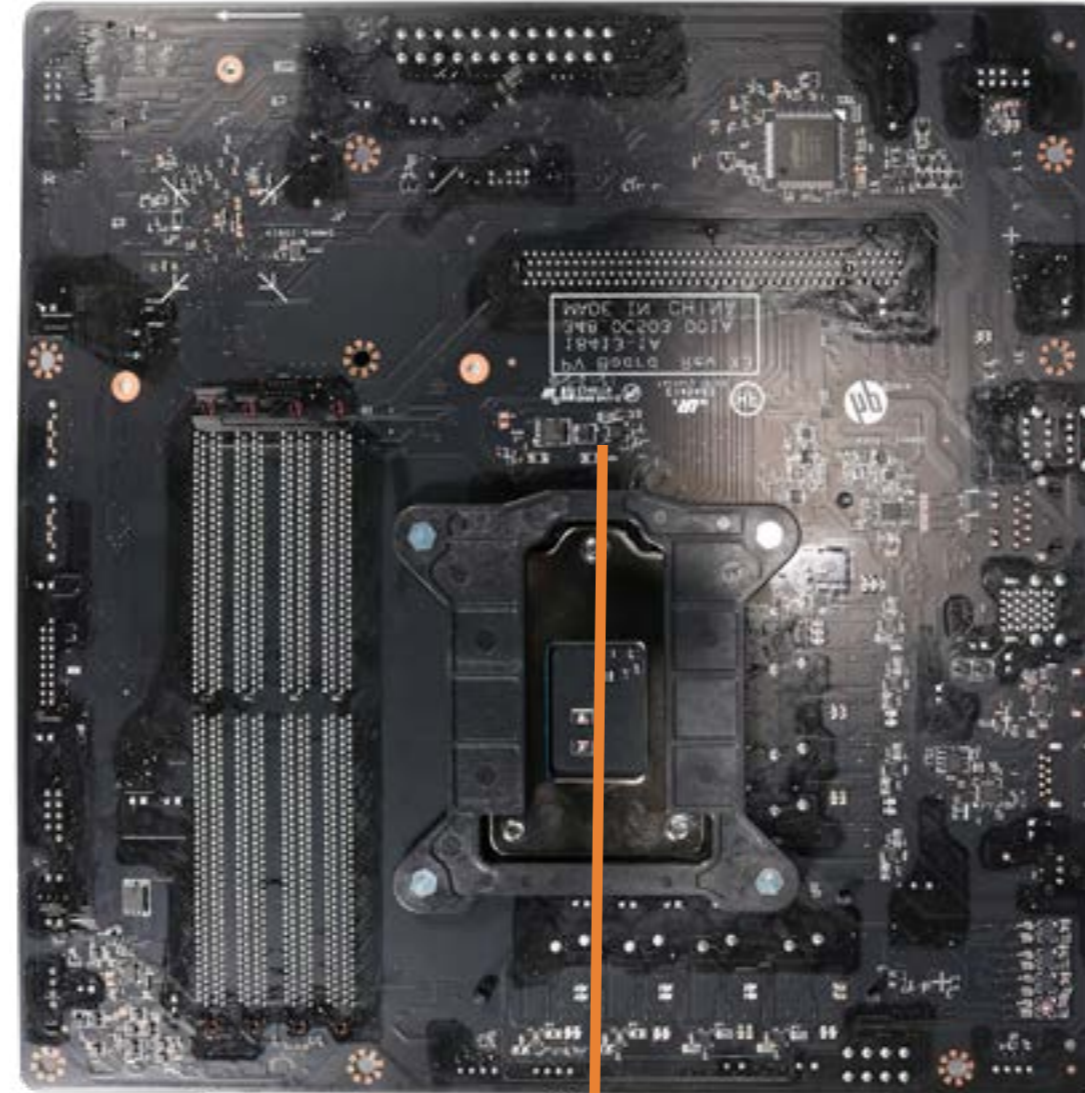

[Go to External Views](#)

Side panel

- Hard drive
- System memory
- M.2 SSD or Intel Optane module
- Graphics card
- Wireless LAN module
- Rear system fan
- System fan
- Heat sink
- CPU
- Motherboard (top)
- Motherboard (bottom)
- Side panel**
- Power supply
- Front bezel
- Front lighting module assembly
- Front lighting module (OMEN logo)
- Top bezel
- Top I/O module
- Wireless LAN antennas



[Go to External Views](#)

Power supply

- Hard drive
- System memory
- M.2 SSD or Intel Optane module
- Graphics card
- Wireless LAN module
- Rear system fan
- System fan
- Heat sink
- CPU
- Motherboard (top)
- Motherboard (bottom)
- Side panel
- Power supply**
- Front bezel
- Front lighting module assembly
- Front lighting module (OMEN logo)
- Top bezel
- Top I/O module
- Wireless LAN antennas



[Go to External Views](#)

Front bezel

- Hard drive
- System memory
- M.2 SSD or Intel Optane module
- Graphics card
- Wireless LAN module
- Rear system fan
- System fan
- Heat sink
- CPU
- Motherboard (top)
- Motherboard (bottom)
- Side panel
- Power supply
- Front bezel**
- Front lighting module assembly
- Front lighting module (OMEN logo)
- Top bezel
- Top I/O module
- Wireless LAN antennas



[Go to External Views](#)

Front lighting module assembly

- Hard drive
- System memory
- M.2 SSD or Intel Optane module
- Graphics card
- Wireless LAN module
- Rear system fan
- System fan
- Heat sink
- CPU
- Motherboard (top)
- Motherboard (bottom)
- Side panel
- Power supply
- Front bezel
- Front lighting module assembly**
- Front lighting module (OMEN logo)
- Top bezel
- Top I/O module
- Wireless LAN antennas



Go to External Views

Front lighting module (OMEN logo)

- Hard drive
- System memory
- M.2 SSD or Intel Optane module
- Graphics card
- Wireless LAN module
- Rear system fan
- System fan
- Heat sink
- CPU
- Motherboard (top)
- Motherboard (bottom)
- Side panel
- Power supply
- Front bezel
- Front lighting module assembly
- Front lighting module (OMEN logo)**
- Top bezel
- Top I/O module
- Wireless LAN antennas

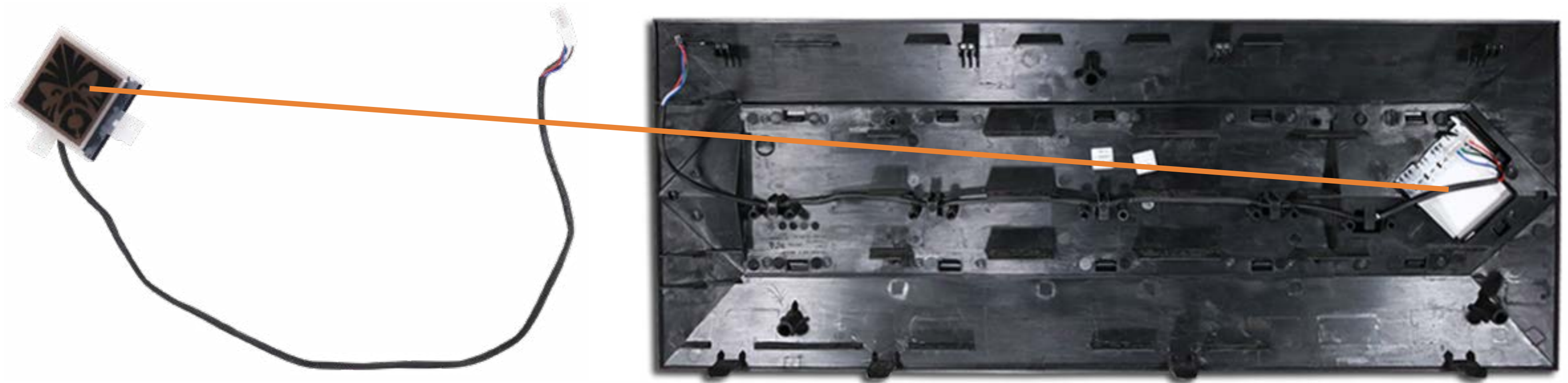

Go to External Views

Top bezel

- Hard drive
- System memory
- M.2 SSD or Intel Optane module
- Graphics card
- Wireless LAN module
- Rear system fan
- System fan
- Heat sink
- CPU
- Motherboard (top)
- Motherboard (bottom)
- Side panel
- Power supply
- Front bezel
- Front lighting module assembly
- Front lighting module (OMEN logo)
- Top bezel**
- Top I/O module
- Wireless LAN antennas



Go to External Views

Top I/O module

- Hard drive
- System memory
- M.2 SSD or Intel Optane module
- Graphics card
- Wireless LAN module
- Rear system fan
- System fan
- Heat sink
- CPU
- Motherboard (top)
- Motherboard (bottom)
- Side panel
- Power supply
- Front bezel
- Front lighting module assembly
- Front lighting module (OMEN logo)
- Top bezel
- Top I/O module**
- Wireless LAN antennas

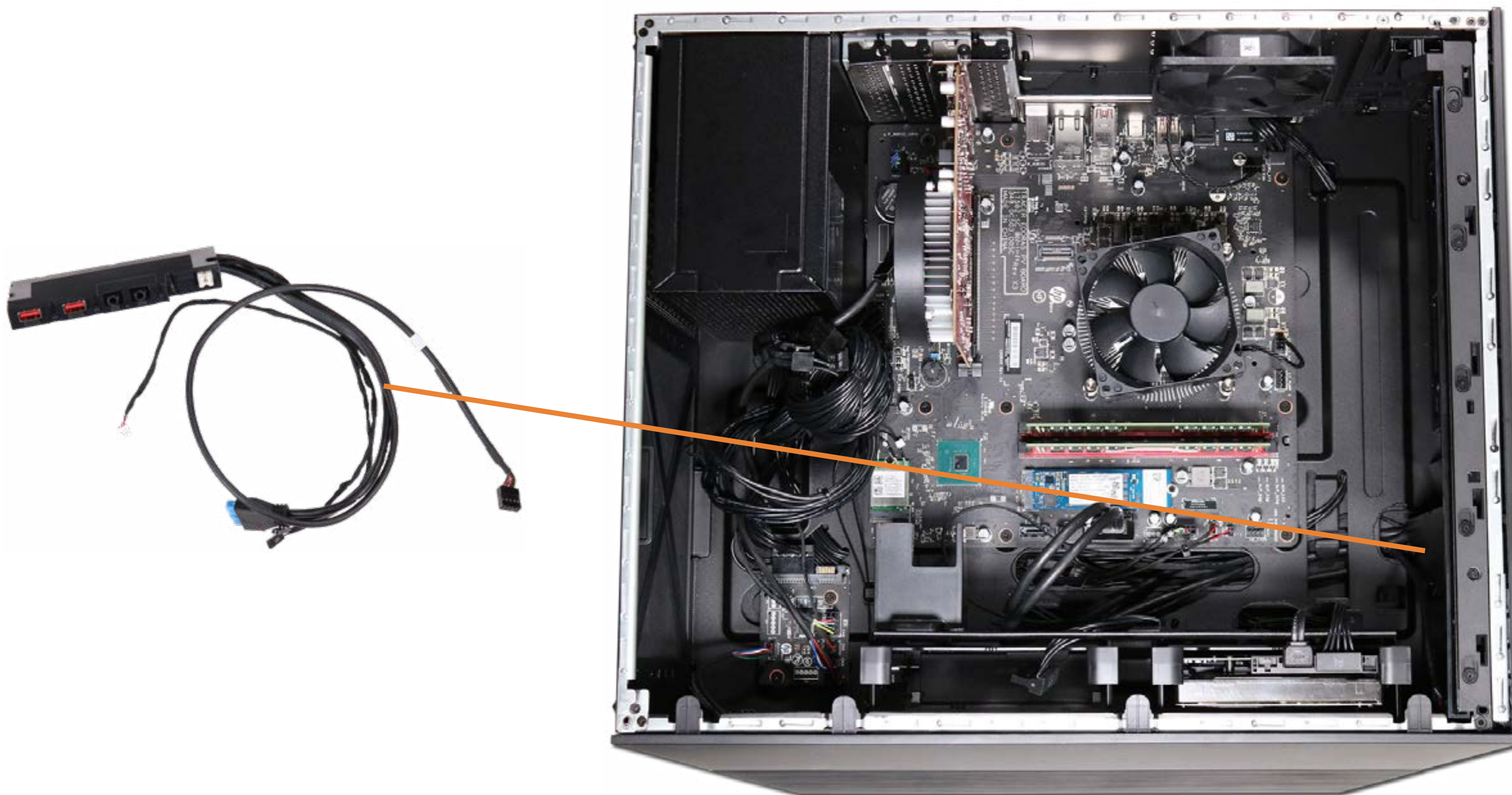

[Go to External Views](#)

Wireless LAN antennas

- Hard drive
- System memory
- M.2 SSD or Intel Optane module
- Graphics card
- Wireless LAN module
- Rear system fan
- System fan
- Heat sink
- CPU
- Motherboard (top)
- Motherboard (bottom)
- Side panel
- Power supply
- Front bezel
- Front lighting module assembly
- Front lighting module (OMEN logo)
- Top bezel
- Top I/O module
- Wireless LAN antennas**

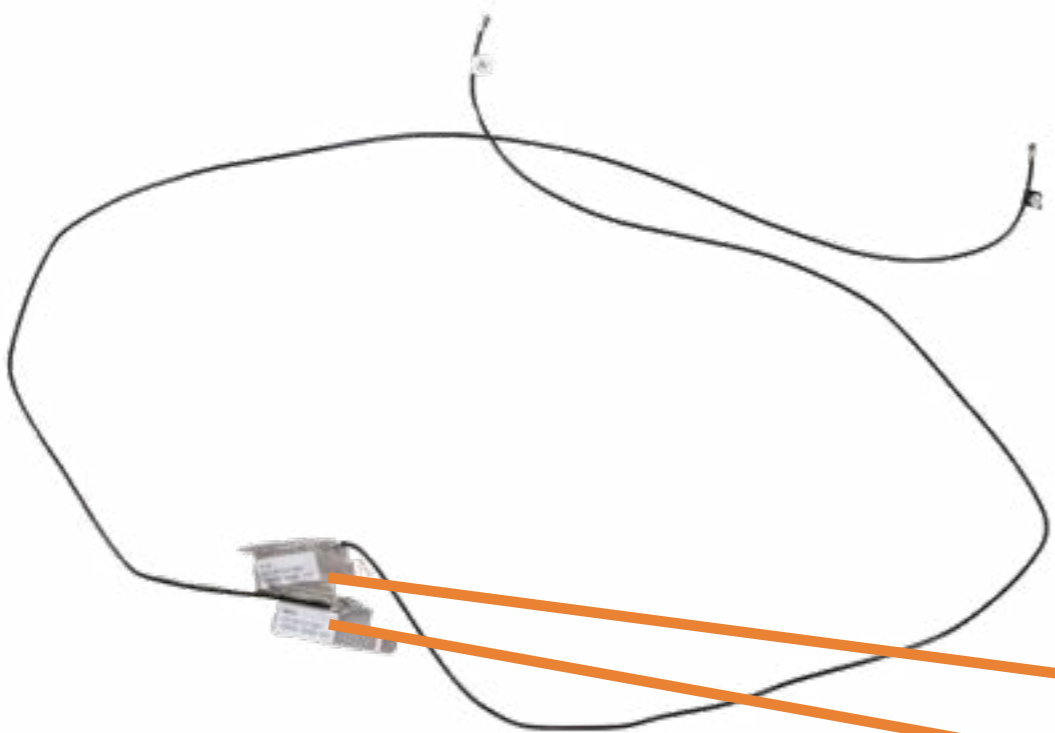

[Go to External Views](#)