

Interactive Part Locator

HP ProDesk 405 G4 SFF

Welcome to the interactive part locator for the
HP ProDesk 405 G4 SFF

Here's how to use it...

[External Views](#) (Click the link to navigate to the views)

On this page you will find thumbnails of each of the external views of this product. To view a specific view in greater detail, simply click that thumbnail.

[Parts List](#) (Click the link to navigate to the parts)

On this page, you will find a list of all of the replaceable parts for this product. To view a specific part and its location in the product, click the part name in the list.

That's it! On every page there is a link that brings you back to either the External Views or the Parts List, enabling you to navigate to whatever view or part you wish to review.

External Views

[Back to Welcome page](#)



Front



Left



Right



Rear



Internal

[Go to Parts List](#)

Front View

[Back to External Views](#)

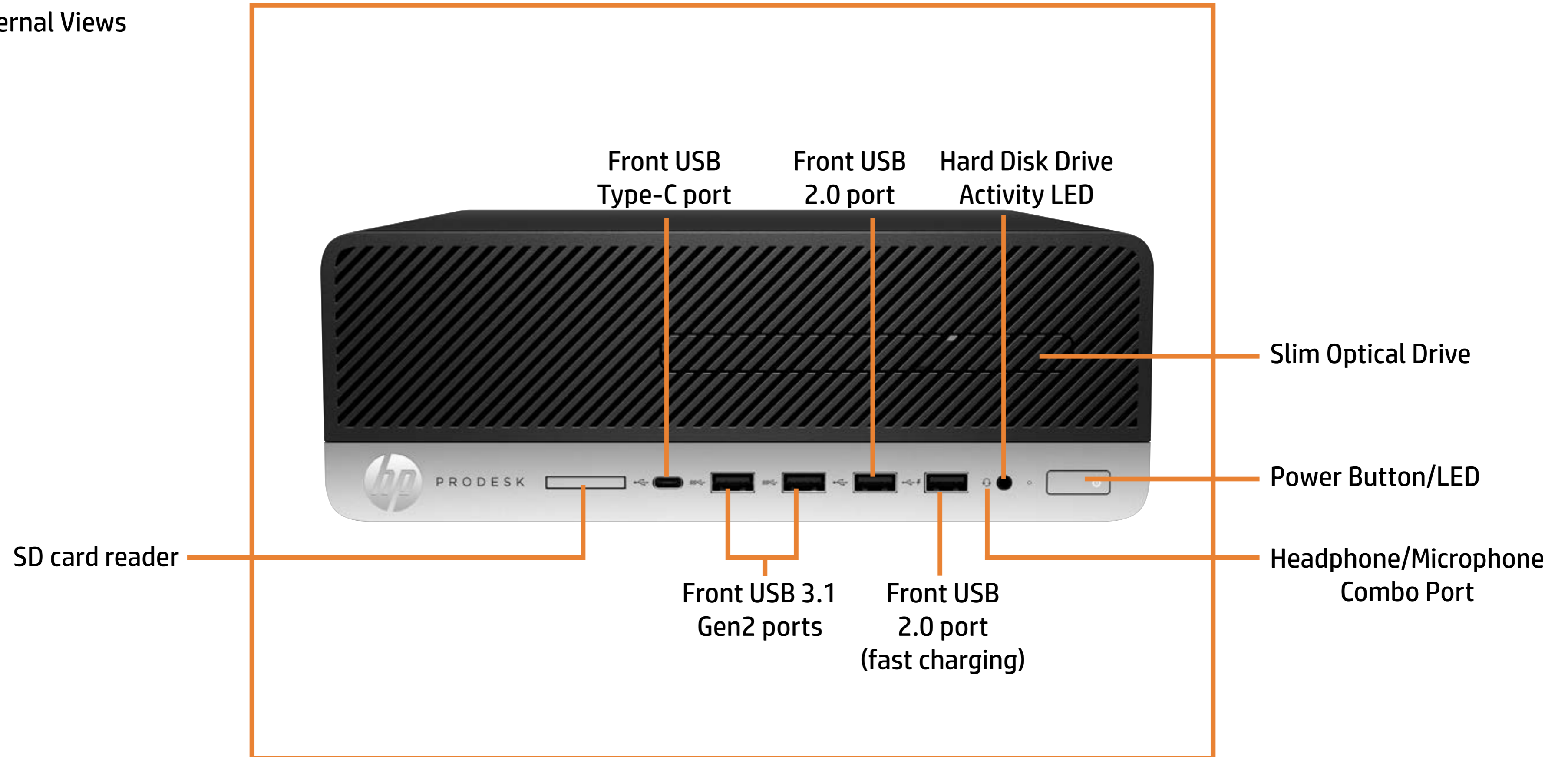

[Go to Parts List](#)

Left View

[Back to External Views](#)



[Go to Parts List](#)

Right View

[Back to External Views](#)



[Go to Parts List](#)

Rear View

[Back to External Views](#)

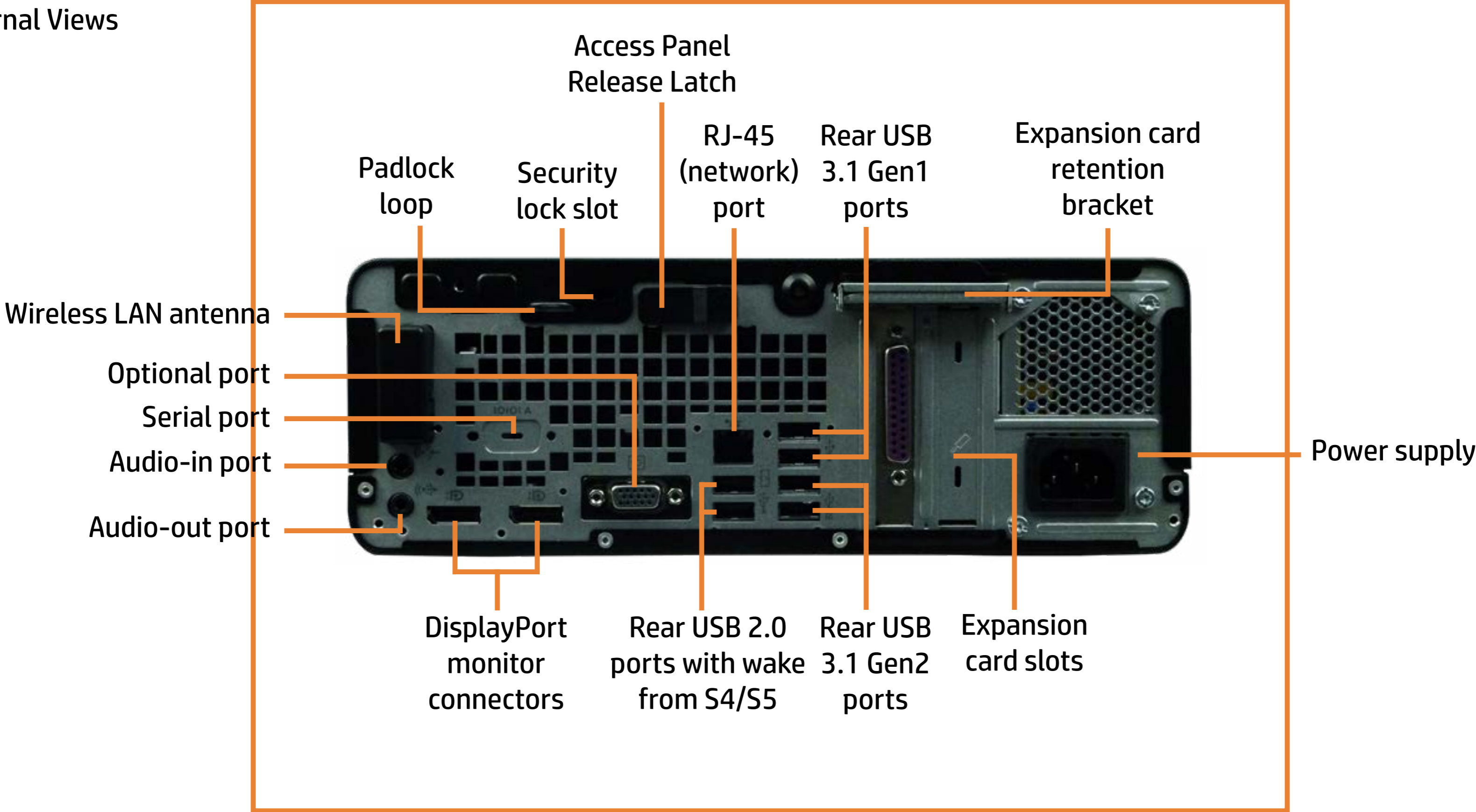

[Go to Parts List](#)

Internal View

[Back to External Views](#)



[Go to Parts List](#)

Front Bezel

- Front Bezel
 - Slim Tray Optical Tray
 - EMI Bracket
 - Wireless LAN Antenna
 - Access Panel
 - Hard Drive
 - Hard Drive Bracket
 - Fan Duct
 - Heat Sink and Fan
 - Hard Drive Cage
 - Expansion Card
 - PCI Parallel Port Card
 - Power Supply
 - SD Card Reader
 - Option Board
 - RTC Battery
 - Wireless LAN Board
 - System Memory
 - Speaker
 - CPU
 - Motherboard
- [Go to External Views](#)



Slim Tray Optical Tray

- Front Bezel
- Slim Tray Optical Tray
- EMI Bracket
- Wireless LAN Antenna
- Access Panel
- Hard Drive
- Hard Drive Bracket
- Fan Duct
- Heat Sink and Fan
- Hard Drive Cage
- Expansion Card
- PCI Parallel Port Card
- Power Supply
- SD Card Reader
- Option Board
- RTC Battery
- Wireless LAN Board
- System Memory
- Speaker
- CPU
- Motherboard
- [Go to External Views](#)



EMI Bracket

- Front Bezel
- Slim Tray Optical Tray
- EMI Bracket
- Wireless LAN Antenna
- Access Panel
- Hard Drive
- Hard Drive Bracket
- Fan Duct
- Heat Sink and Fan
- Hard Drive Cage
- Expansion Card
- PCI Parallel Port Card
- Power Supply
- SD Card Reader
- Option Board
- RTC Battery
- Wireless LAN Board
- System Memory
- Speaker
- CPU
- Motherboard

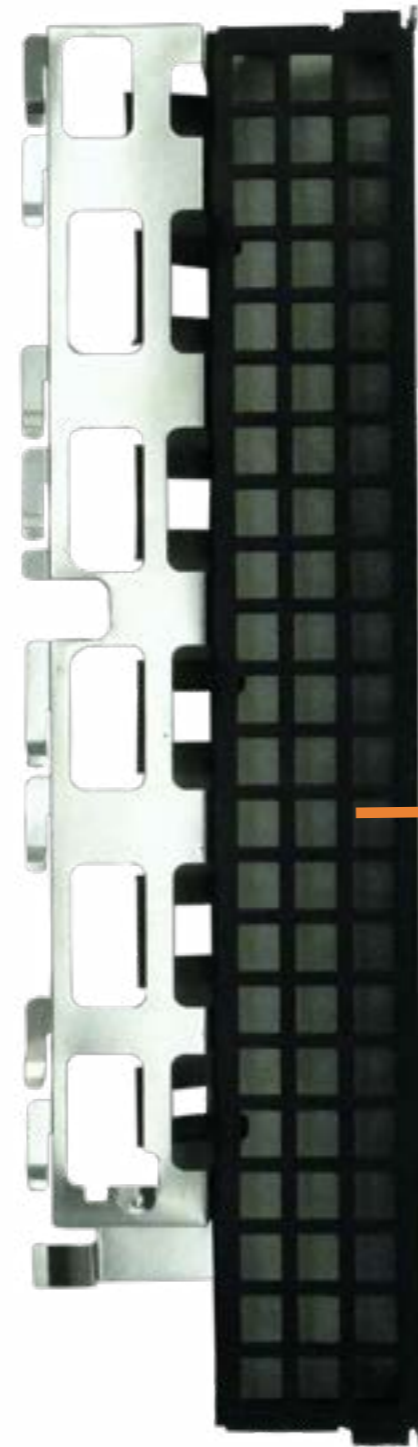

[Go to External Views](#)

Wireless LAN Antenna

- Front Bezel
- Slim Tray Optical Tray
- EMI Bracket
- Wireless LAN Antenna
- Access Panel
- Hard Drive
- Hard Drive Bracket
- Fan Duct
- Heat Sink and Fan
- Hard Drive Cage
- Expansion Card
- PCI Parallel Port Card
- Power Supply
- SD Card Reader
- Option Board
- RTC Battery
- Wireless LAN Board
- System Memory
- Speaker
- CPU
- Motherboard

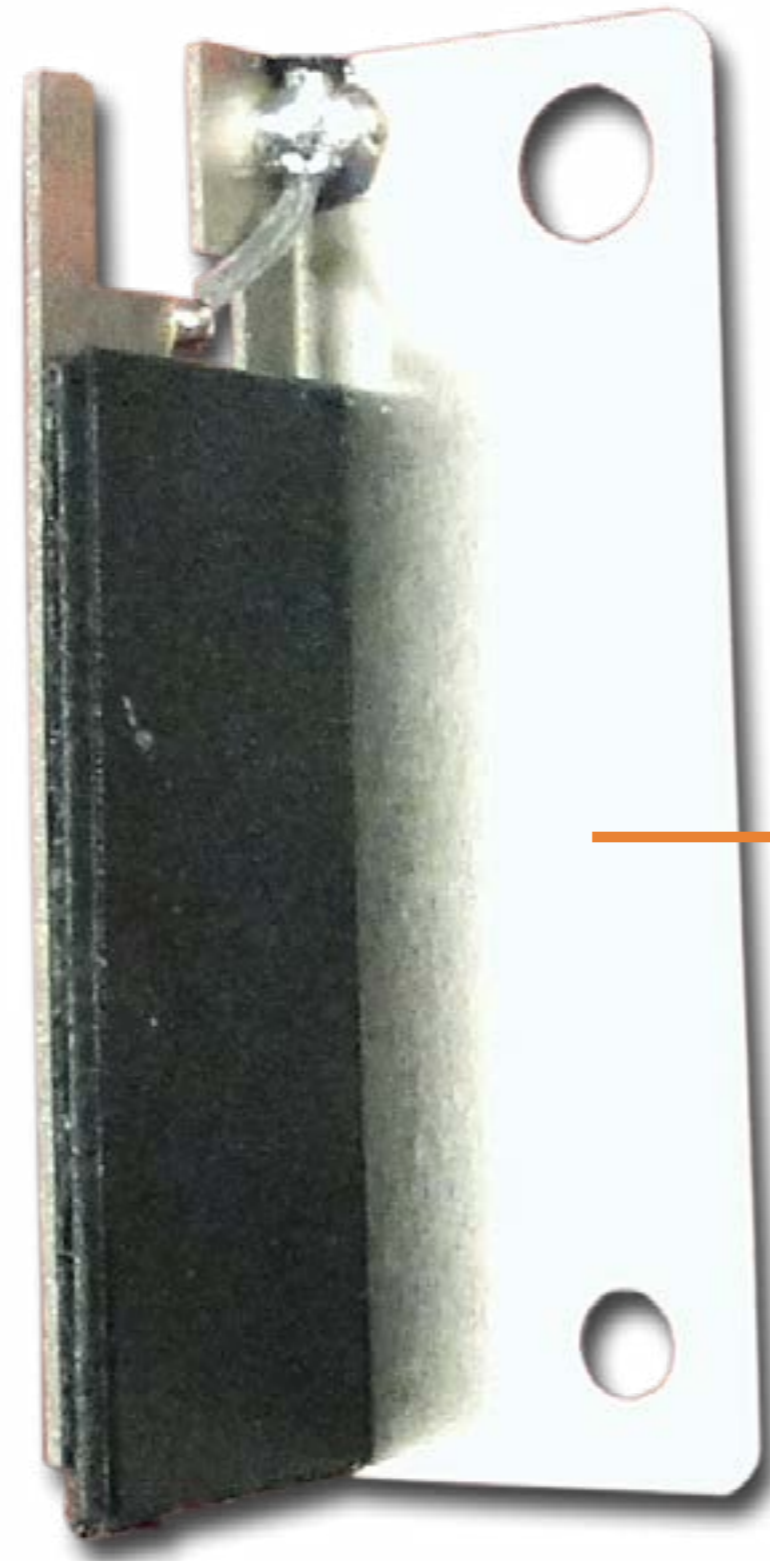

[Go to External Views](#)

Access Panel

- Front Bezel
- Slim Tray Optical Tray
- EMI Bracket
- Wireless LAN Antenna
- Access Panel
- Hard Drive
- Hard Drive Bracket
- Fan Duct
- Heat Sink and Fan
- Hard Drive Cage
- Expansion Card
- PCI Parallel Port Card
- Power Supply
- SD Card Reader
- Option Board
- RTC Battery
- Wireless LAN Board
- System Memory
- Speaker
- CPU
- Motherboard



[Go to External Views](#)

Hard Drive

- Front Bezel
 - Slim Tray Optical Tray
 - EMI Bracket
 - Wireless LAN Antenna
 - Access Panel
 - Hard Drive
 - Hard Drive Bracket
 - Fan Duct
 - Heat Sink and Fan
 - Hard Drive Cage
 - Expansion Card
 - PCI Parallel Port Card
 - Power Supply
 - SD Card Reader
 - Option Board
 - RTC Battery
 - Wireless LAN Board
 - System Memory
 - Speaker
 - CPU
 - Motherboard
- [Go to External Views](#)

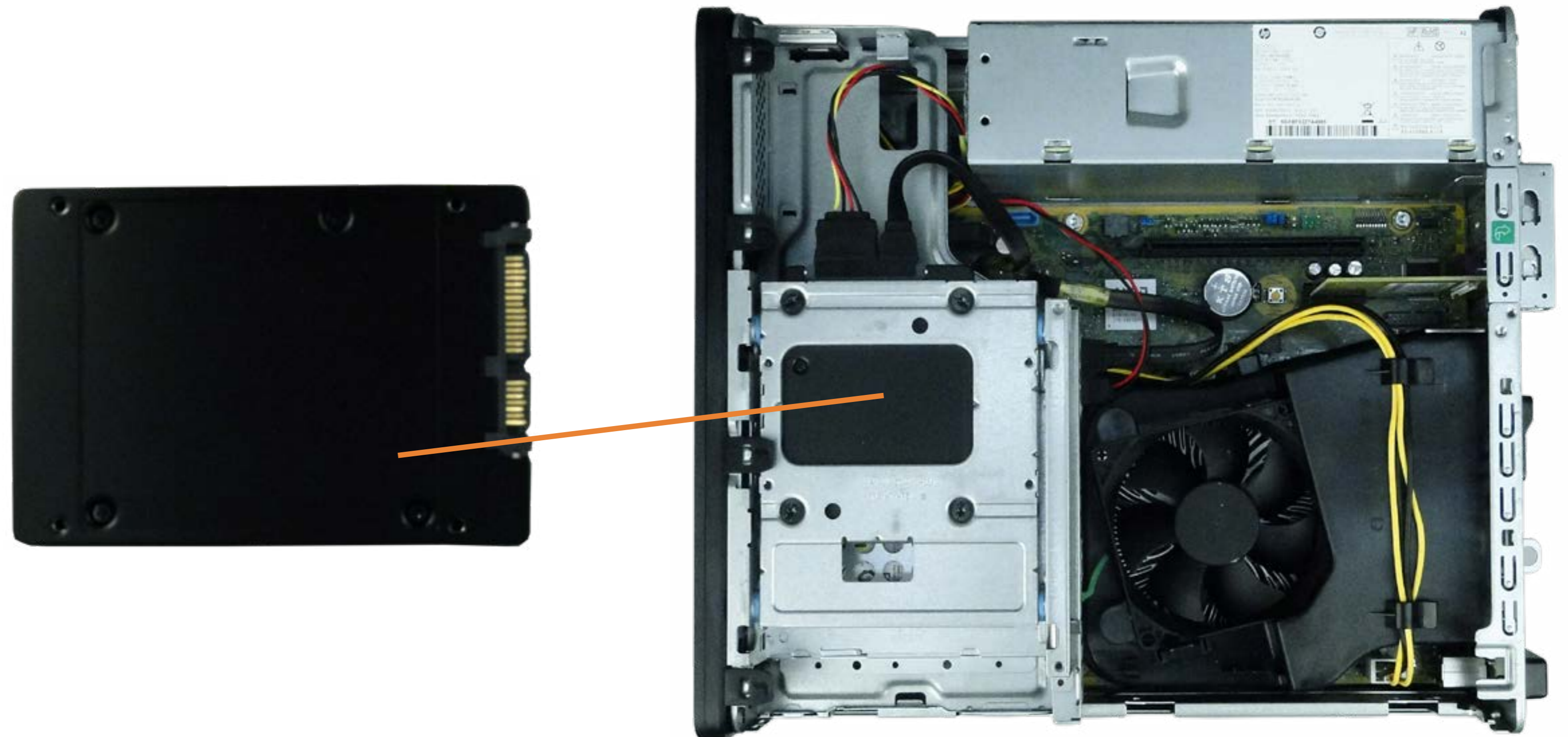

Hard Drive Bracket

- Front Bezel
- Slim Tray Optical Tray
- EMI Bracket
- Wireless LAN Antenna
- Access Panel
- Hard Drive
- Hard Drive Bracket
- Fan Duct
- Heat Sink and Fan
- Hard Drive Cage
- Expansion Card
- PCI Parallel Port Card
- Power Supply
- SD Card Reader
- Option Board
- RTC Battery
- Wireless LAN Board
- System Memory
- Speaker
- CPU
- Motherboard



[Go to External Views](#)

Fan Duct

- Front Bezel
- Slim Tray Optical Tray
- EMI Bracket
- Wireless LAN Antenna
- Access Panel
- Hard Drive
- Hard Drive Bracket
- Fan Duct
- Heat Sink and Fan
- Hard Drive Cage
- Expansion Card
- PCI Parallel Port Card
- Power Supply
- SD Card Reader
- Option Board
- RTC Battery
- Wireless LAN Board
- System Memory
- Speaker
- CPU
- Motherboard

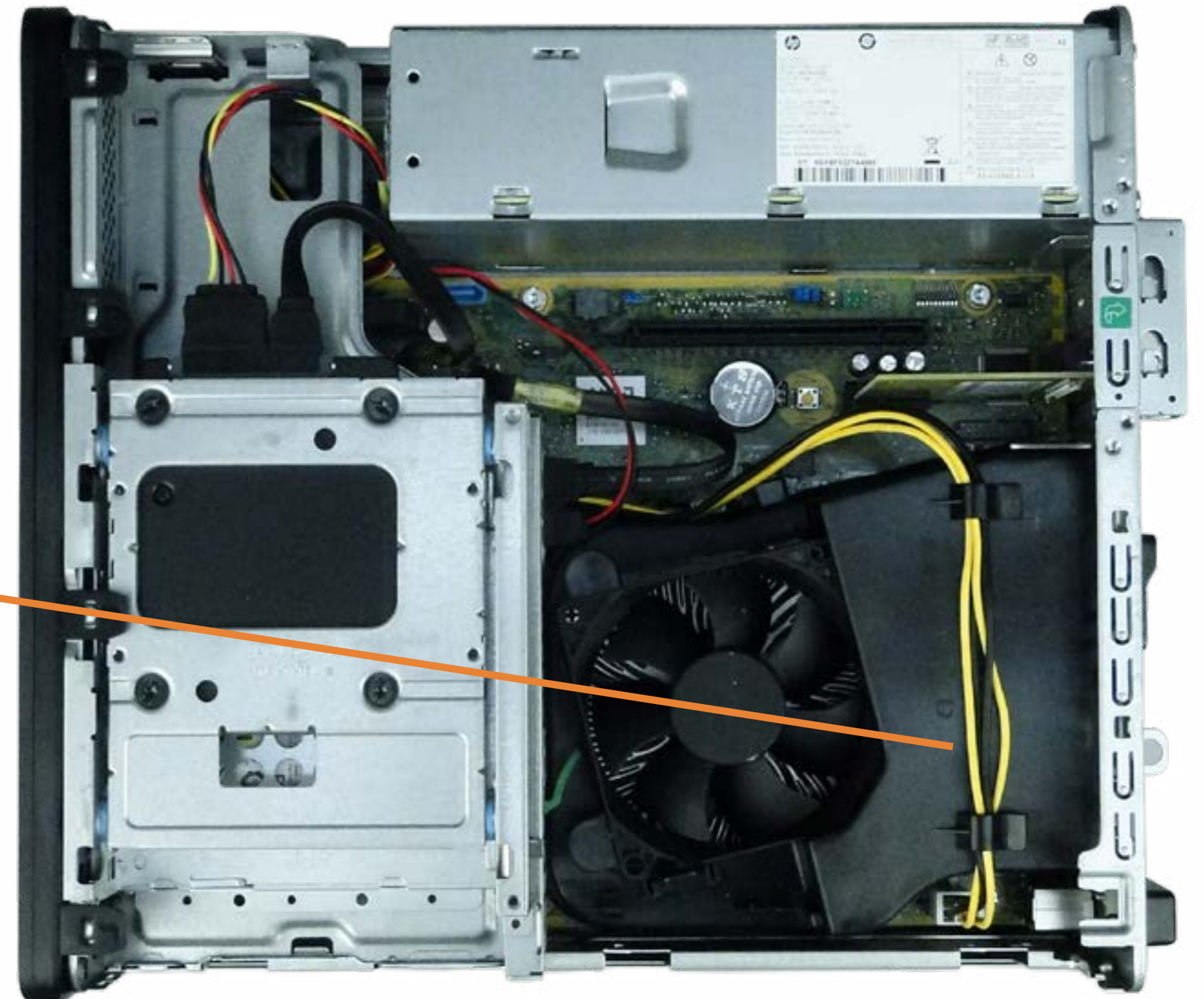

[Go to External Views](#)

Heat Sink and Fan

- Front Bezel
 - Slim Tray Optical Tray
 - EMI Bracket
 - Wireless LAN Antenna
 - Access Panel
 - Hard Drive
 - Hard Drive Bracket
 - Fan Duct
 - Heat Sink and Fan
 - Hard Drive Cage
 - Expansion Card
 - PCI Parallel Port Card
 - Power Supply
 - SD Card Reader
 - Option Board
 - RTC Battery
 - Wireless LAN Board
 - System Memory
 - Speaker
 - CPU
 - Motherboard
- [Go to External Views](#)

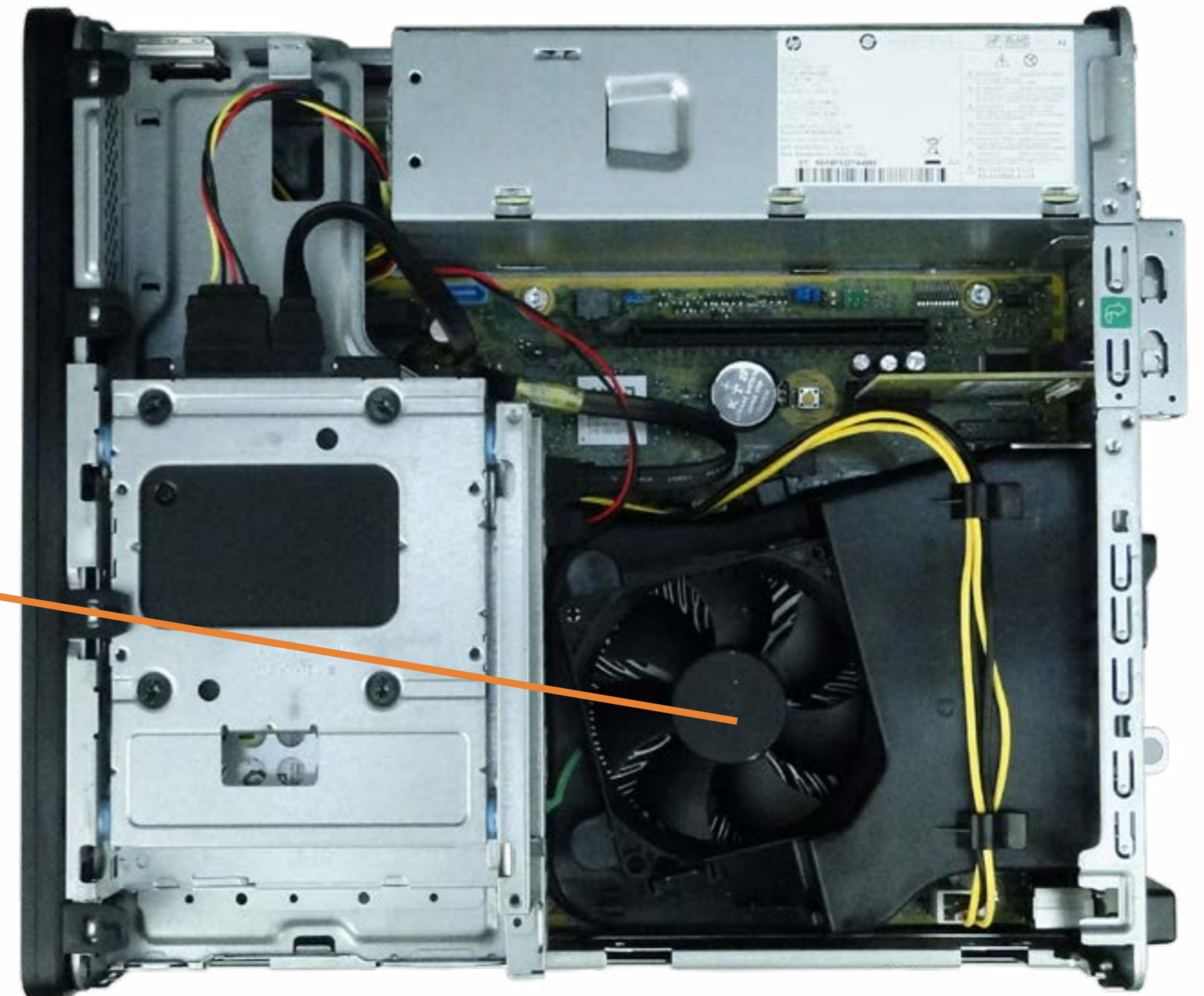

Hard Drive Cage

- Front Bezel
 - Slim Tray Optical Tray
 - EMI Bracket
 - Wireless LAN Antenna
 - Access Panel
 - Hard Drive
 - Hard Drive Bracket
 - Fan Duct
 - Heat Sink and Fan
 - Hard Drive Cage
 - Expansion Card
 - PCI Parallel Port Card
 - Power Supply
 - SD Card Reader
 - Option Board
 - RTC Battery
 - Wireless LAN Board
 - System Memory
 - Speaker
 - CPU
 - Motherboard
- [Go to External Views](#)

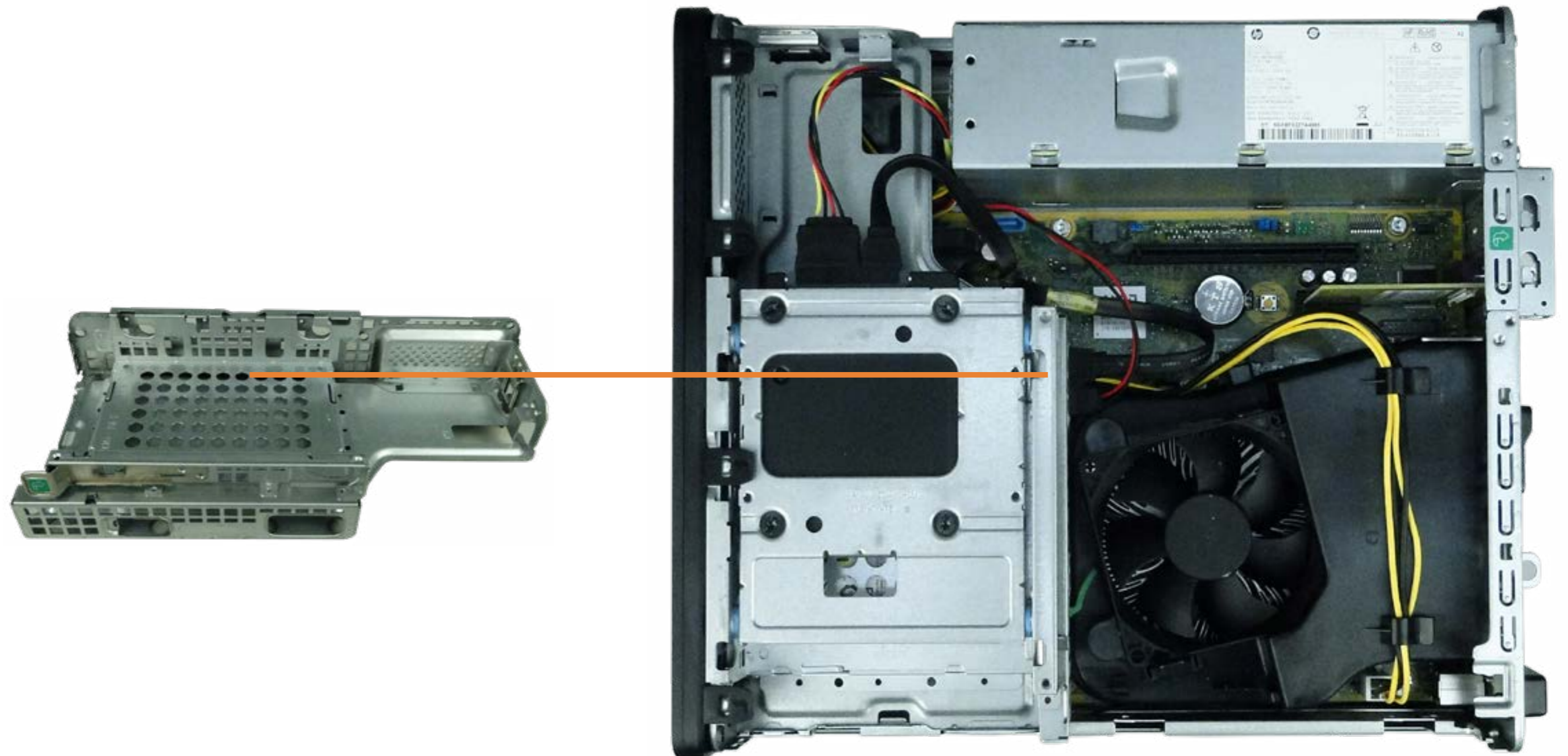

Expansion Card

- Front Bezel
 - Slim Tray Optical Tray
 - EMI Bracket
 - Wireless LAN Antenna
 - Access Panel
 - Hard Drive
 - Hard Drive Bracket
 - Fan Duct
 - Heat Sink and Fan
 - Hard Drive Cage
 - Expansion Card
 - PCI Parallel Port Card
 - Power Supply
 - SD Card Reader
 - Option Board
 - RTC Battery
 - Wireless LAN Board
 - System Memory
 - Speaker
 - CPU
 - Motherboard
- [Go to External Views](#)



PCI Parallel Port Card

- Front Bezel
- Slim Tray Optical Tray
- EMI Bracket
- Wireless LAN Antenna
- Access Panel
- Hard Drive
- Hard Drive Bracket
- Fan Duct
- Heat Sink and Fan
- Hard Drive Cage
- Expansion Card
- PCI Parallel Port Card
- Power Supply
- SD Card Reader
- Option Board
- RTC Battery
- Wireless LAN Board
- System Memory
- Speaker
- CPU
- Motherboard
- [Go to External Views](#)

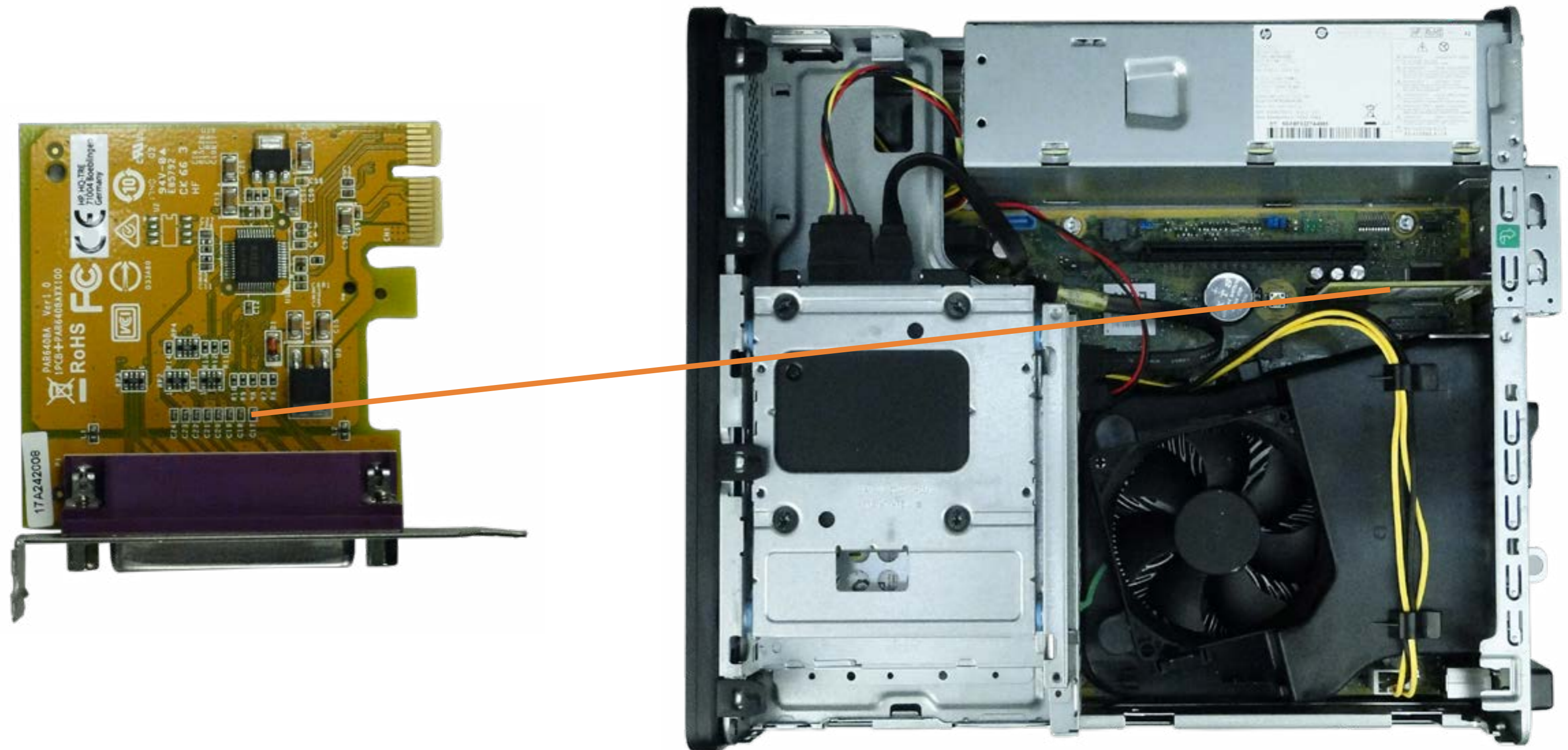

Power Supply

- Front Bezel
- Slim Tray Optical Tray
- EMI Bracket
- Wireless LAN Antenna
- Access Panel
- Hard Drive
- Hard Drive Bracket
- Fan Duct
- Heat Sink and Fan
- Hard Drive Cage
- Expansion Card
- PCI Parallel Port Card
- Power Supply
- SD Card Reader
- Option Board
- RTC Battery
- Wireless LAN Board
- System Memory
- Speaker
- CPU
- Motherboard

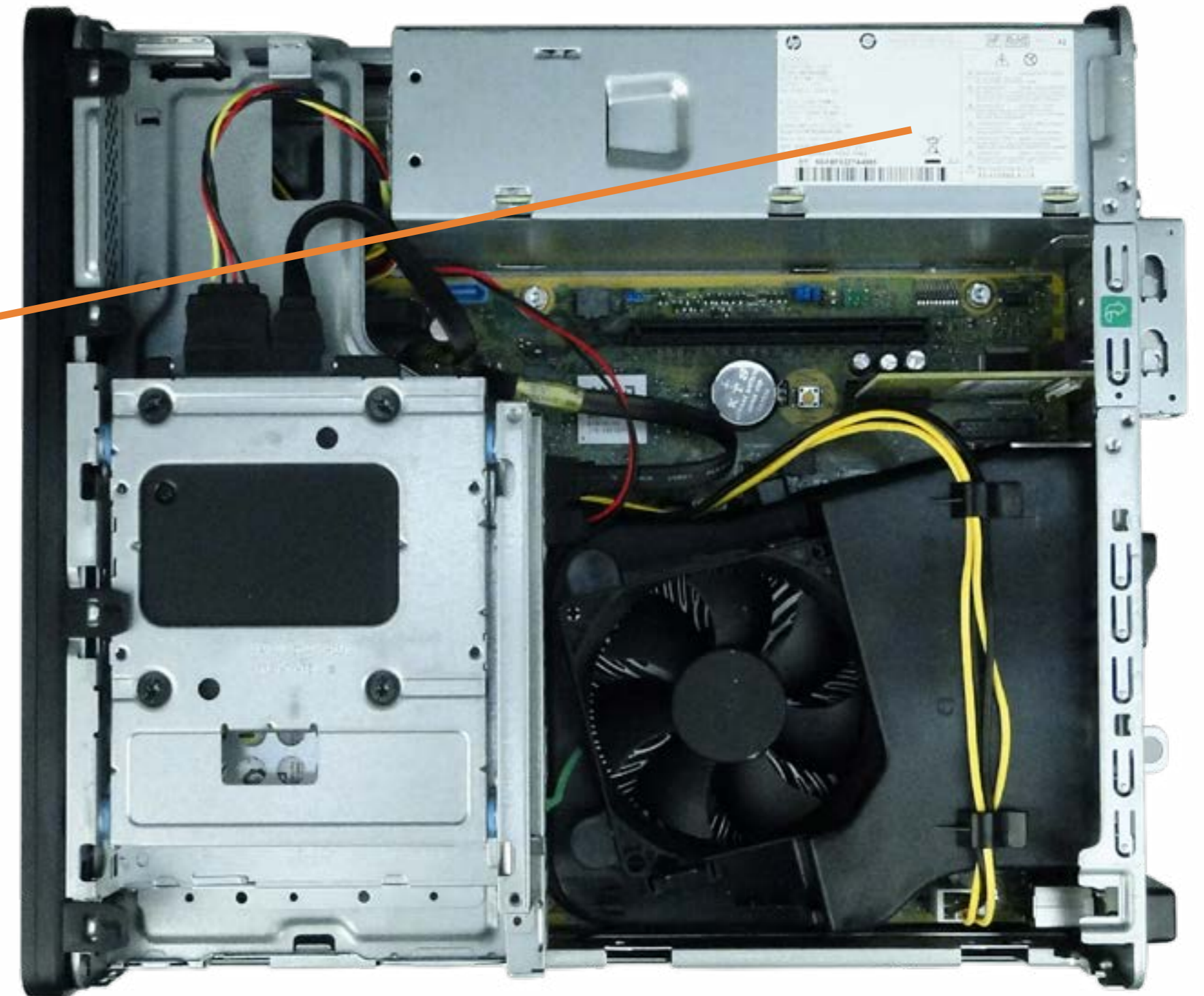

[Go to External Views](#)

SD Card Reader

- Front Bezel
- Slim Tray Optical Tray
- EMI Bracket
- Wireless LAN Antenna
- Access Panel
- Hard Drive
- Hard Drive Bracket
- Fan Duct
- Heat Sink and Fan
- Hard Drive Cage
- Expansion Card
- PCI Parallel Port Card
- Power Supply
- SD Card Reader
- Option Board
- RTC Battery
- Wireless LAN Board
- System Memory
- Speaker
- CPU
- Motherboard

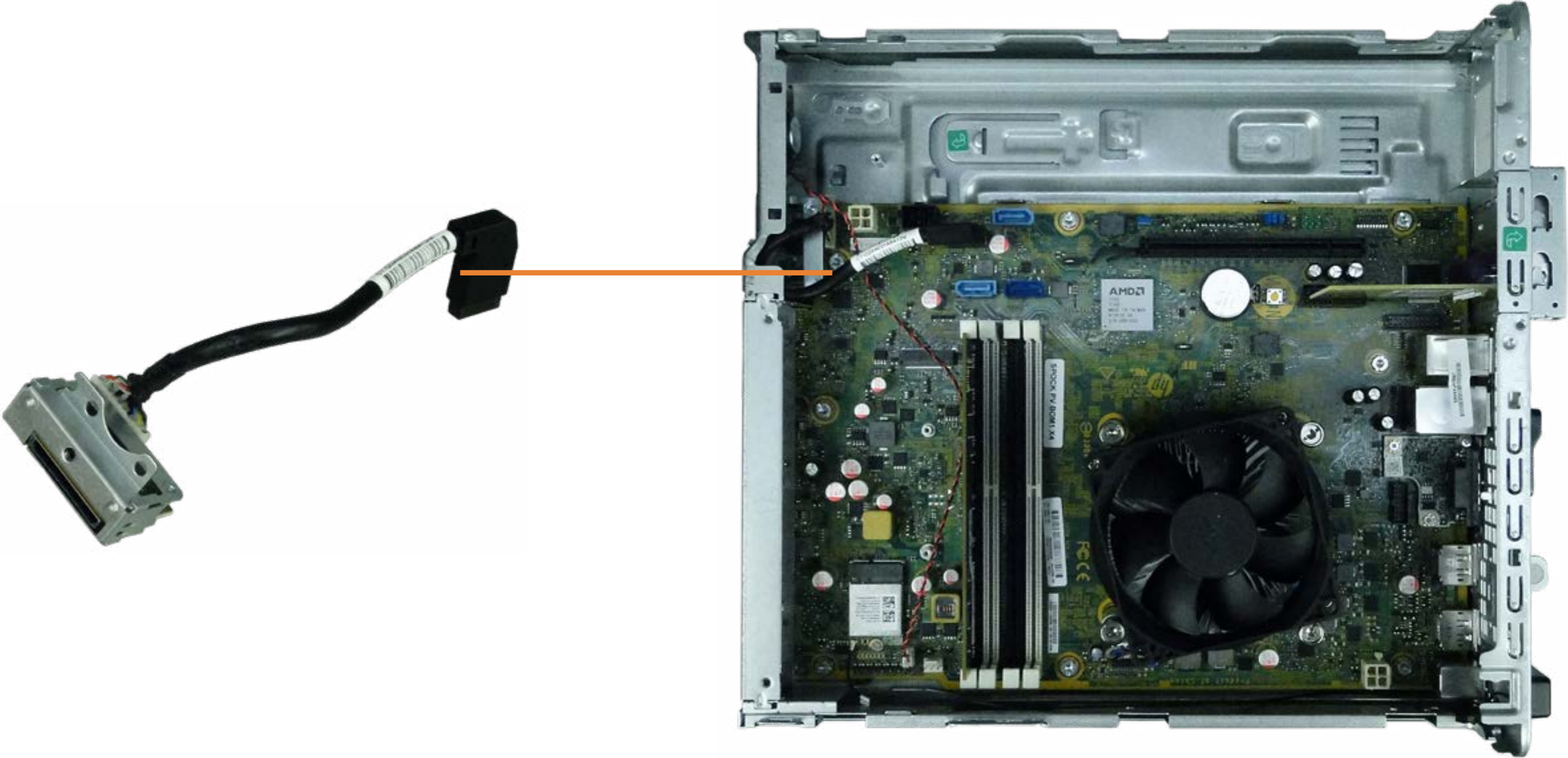

[Go to External Views](#)

Option Board

- Front Bezel
- Slim Tray Optical Tray
- EMI Bracket
- Wireless LAN Antenna
- Access Panel
- Hard Drive
- Hard Drive Bracket
- Fan Duct
- Heat Sink and Fan
- Hard Drive Cage
- Expansion Card
- PCI Parallel Port Card
- Power Supply
- SD Card Reader
- Option Board
- RTC Battery
- Wireless LAN Board
- System Memory
- Speaker
- CPU
- Motherboard

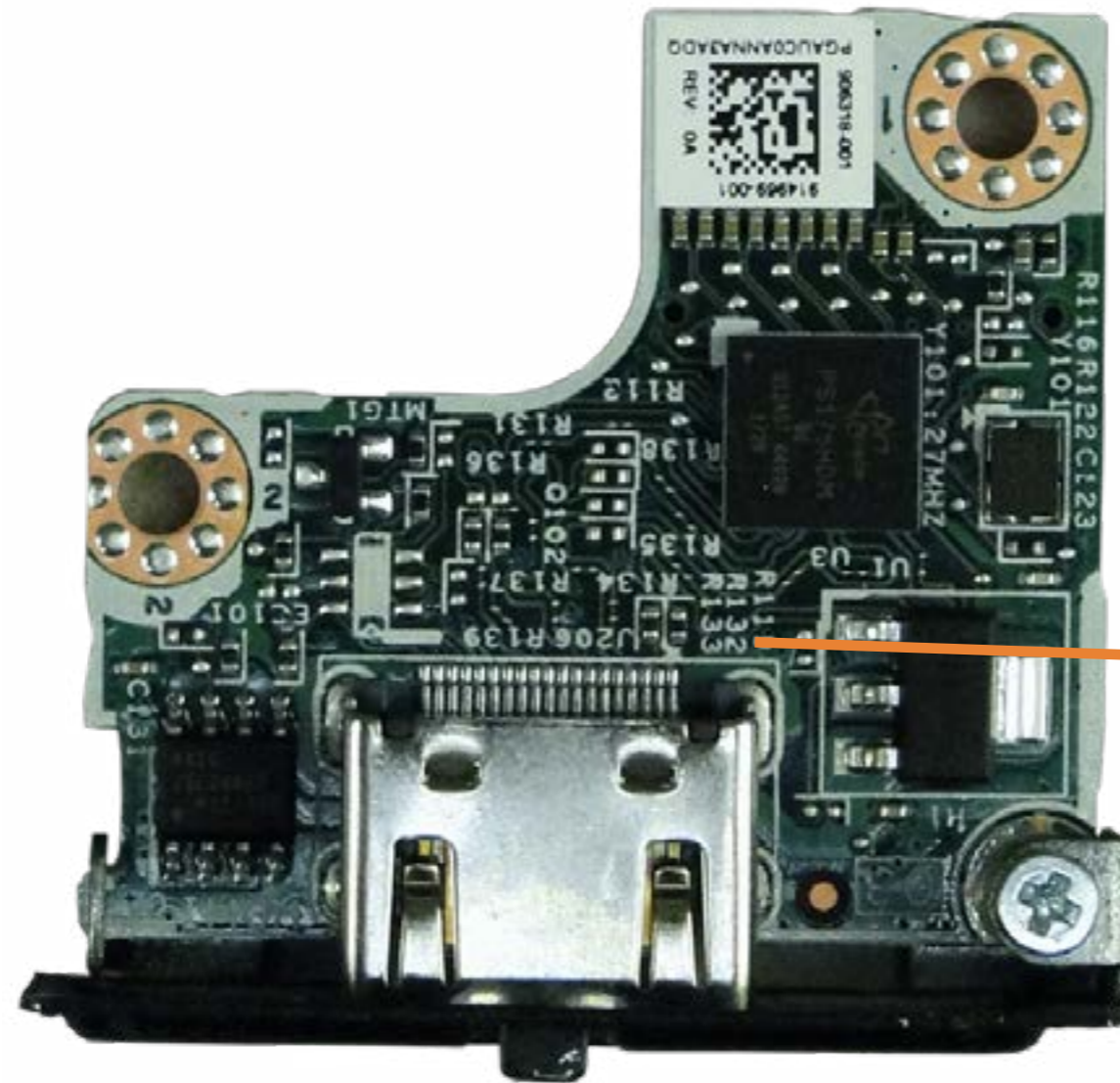

[Go to External Views](#)

RTC Battery

- Front Bezel
- Slim Tray Optical Tray
- EMI Bracket
- Wireless LAN Antenna
- Access Panel
- Hard Drive
- Hard Drive Bracket
- Fan Duct
- Heat Sink and Fan
- Hard Drive Cage
- Expansion Card
- PCI Parallel Port Card
- Power Supply
- SD Card Reader
- Option Board
- RTC Battery
- Wireless LAN Board
- System Memory
- Speaker
- CPU
- Motherboard

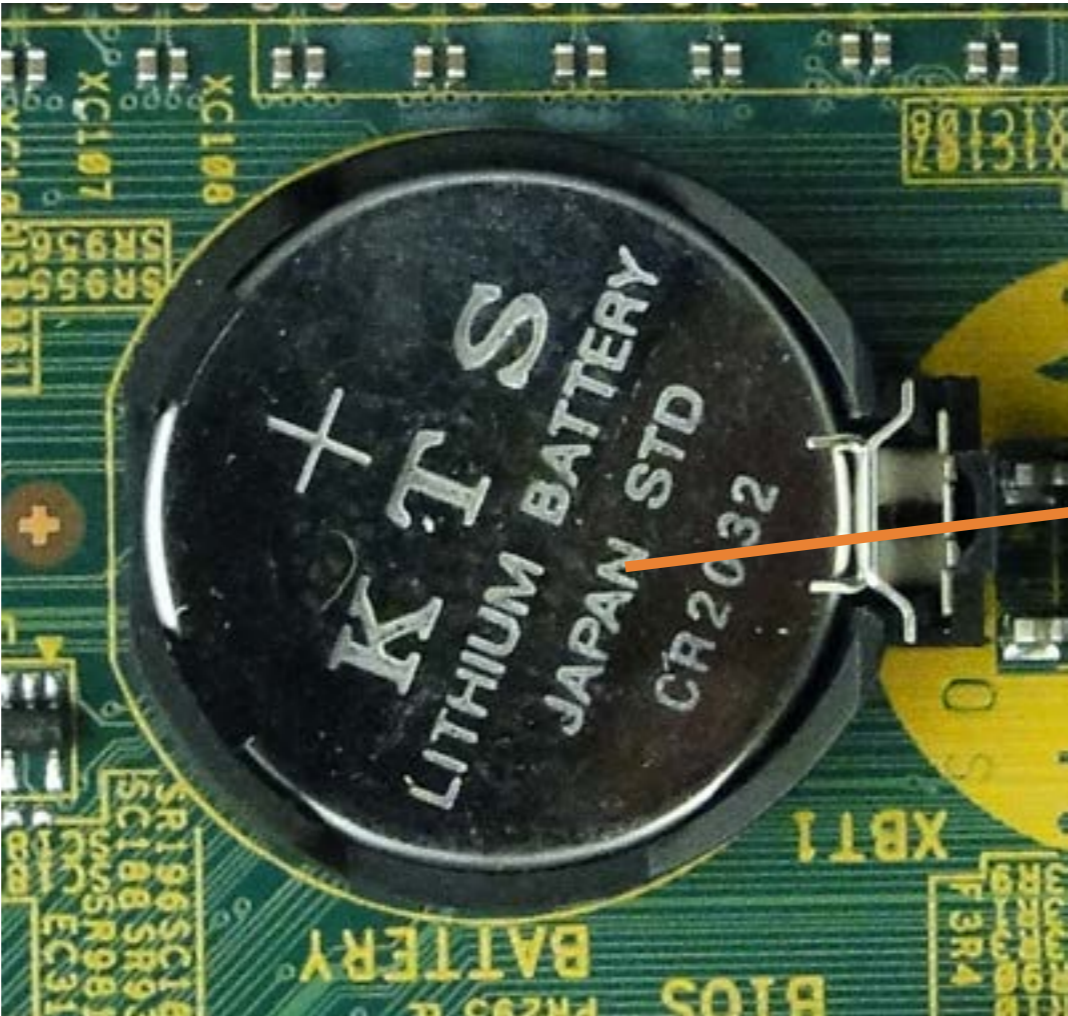

Go to External Views

Wireless LAN Board

- Front Bezel
- Slim Tray Optical Tray
- EMI Bracket
- Wireless LAN Antenna
- Access Panel
- Hard Drive
- Hard Drive Bracket
- Fan Duct
- Heat Sink and Fan
- Hard Drive Cage
- Expansion Card
- PCI Parallel Port Card
- Power Supply
- SD Card Reader
- Option Board
- RTC Battery
- Wireless LAN Board
- System Memory
- Speaker
- CPU
- Motherboard
- [Go to External Views](#)



System Memory

- Front Bezel
- Slim Tray Optical Tray
- EMI Bracket
- Wireless LAN Antenna
- Access Panel
- Hard Drive
- Hard Drive Bracket
- Fan Duct
- Heat Sink and Fan
- Hard Drive Cage
- Expansion Card
- PCI Parallel Port Card
- Power Supply
- SD Card Reader
- Option Board
- RTC Battery
- Wireless LAN Board
- System Memory
- Speaker
- CPU
- Motherboard



[Go to External Views](#)

Speaker

- Front Bezel
- Slim Tray Optical Tray
- EMI Bracket
- Wireless LAN Antenna
- Access Panel
- Hard Drive
- Hard Drive Bracket
- Fan Duct
- Heat Sink and Fan
- Hard Drive Cage
- Expansion Card
- PCI Parallel Port Card
- Power Supply
- SD Card Reader
- Option Board
- RTC Battery
- Wireless LAN Board
- System Memory
- Speaker
- CPU
- Motherboard



[Go to External Views](#)

- Front Bezel
- Slim Tray Optical Tray
- EMI Bracket
- Wireless LAN Antenna
- Access Panel
- Hard Drive
- Hard Drive Bracket
- Fan Duct
- Heat Sink and Fan
- Hard Drive Cage
- Expansion Card
- PCI Parallel Port Card
- Power Supply
- SD Card Reader
- Option Board
- RTC Battery
- Wireless LAN Board
- System Memory
- Speaker
- CPU
- Motherboard
- [Go to External Views](#)

CPU

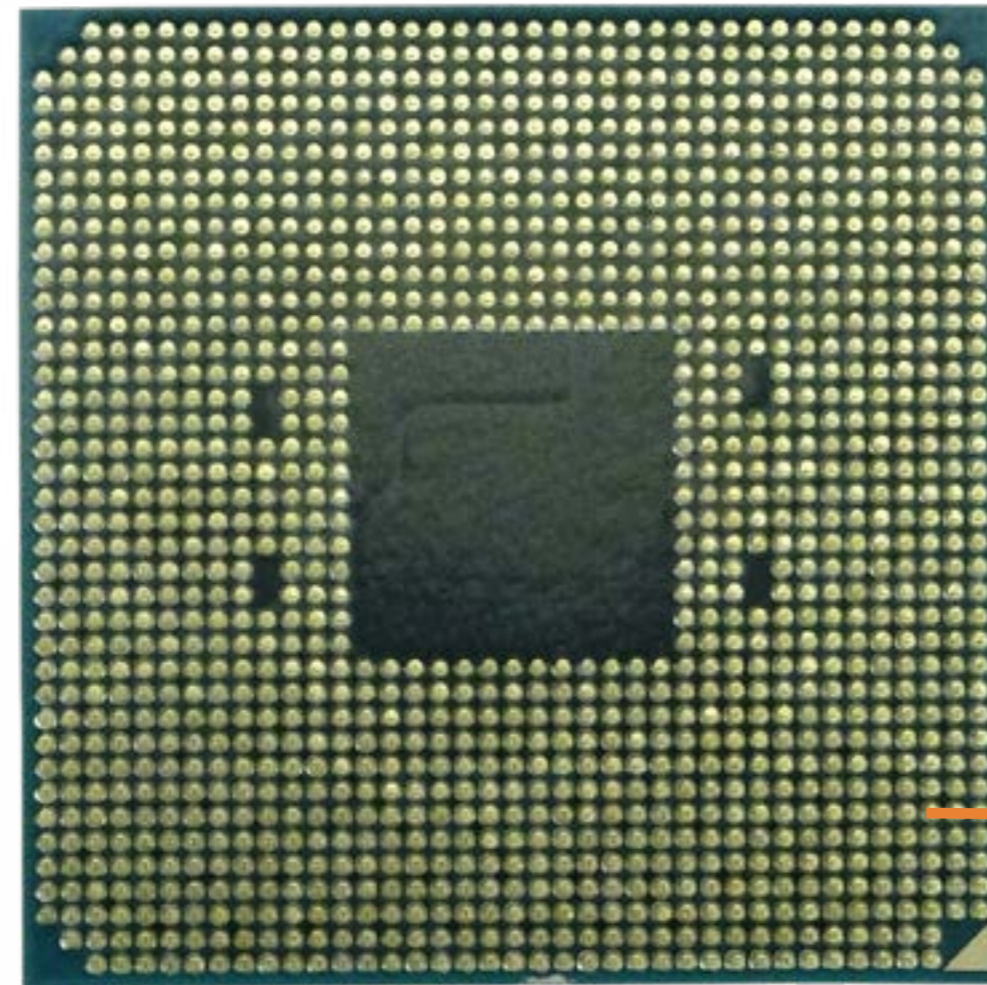

Motherboard

- Front Bezel
- Slim Tray Optical Tray
- EMI Bracket
- Wireless LAN Antenna
- Access Panel
- Hard Drive
- Hard Drive Bracket
- Fan Duct
- Heat Sink and Fan
- Hard Drive Cage
- Expansion Card
- PCI Parallel Port Card
- Power Supply
- SD Card Reader
- Option Board
- RTC Battery
- Wireless LAN Board
- System Memory
- Speaker
- CPU
- Motherboard

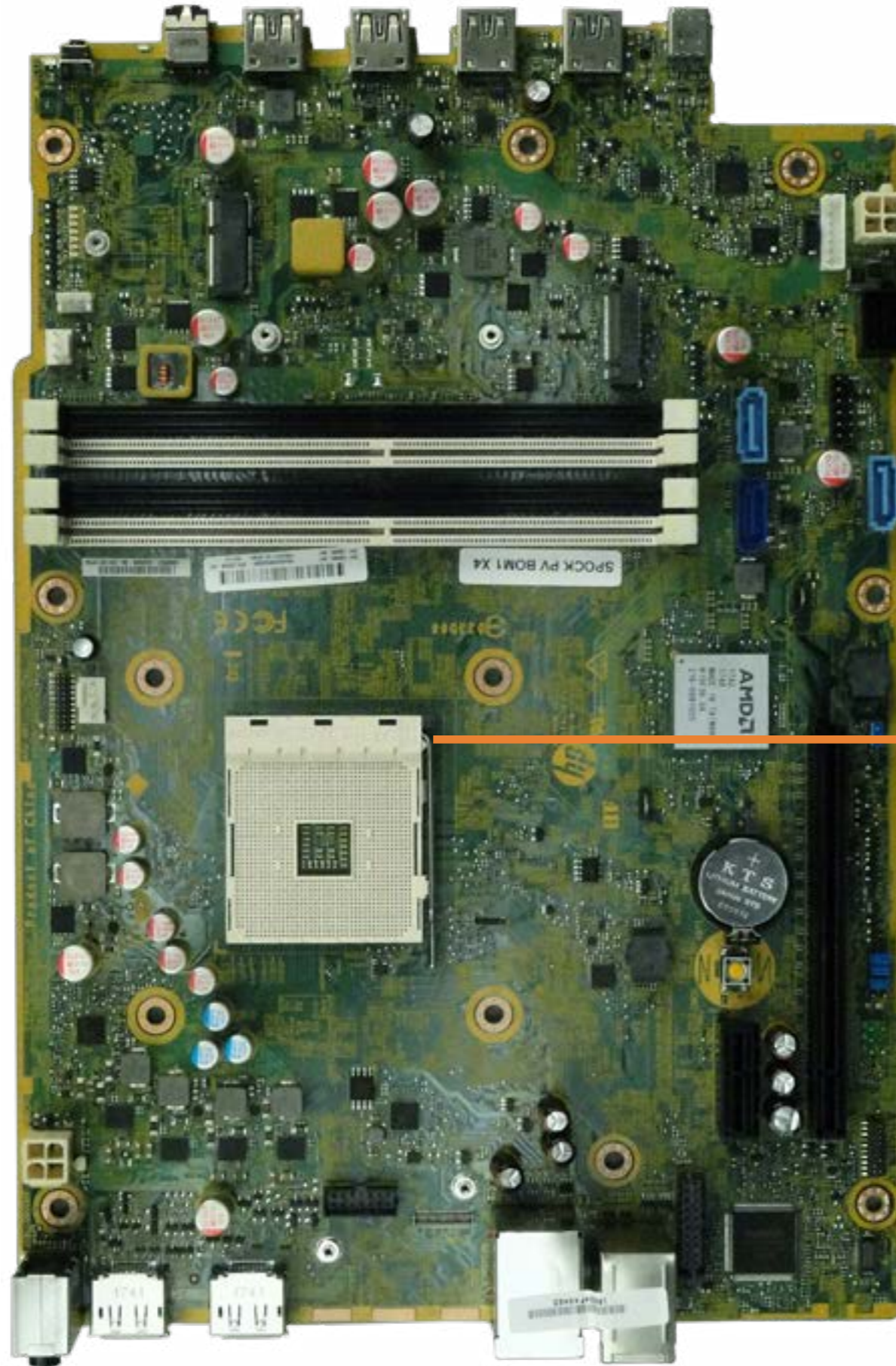

[Go to External Views](#)