



User Guide



HP DeskJet 1200 series

HP company notices

THE INFORMATION CONTAINED HEREIN IS SUBJECT TO CHANGE WITHOUT NOTICE.

ALL RIGHTS RESERVED. REPRODUCTION, ADAPTATION, OR TRANSLATION OF THIS MATERIAL IS PROHIBITED WITHOUT PRIOR WRITTEN PERMISSION OF HP, EXCEPT AS ALLOWED UNDER THE COPYRIGHT LAWS. THE ONLY WARRANTIES FOR HP PRODUCTS AND SERVICES ARE SET FORTH IN THE EXPRESS WARRANTY STATEMENTS ACCOMPANYING SUCH PRODUCTS AND SERVICES. NOTHING HEREIN SHOULD BE CONSTRUED AS CONSTITUTING AN ADDITIONAL WARRANTY. HP SHALL NOT BE LIABLE FOR TECHNICAL OR EDITORIAL ERRORS OR OMISSIONS CONTAINED HEREIN.

© Copyright 2020 HP Development Company, L.P.

Microsoft and Windows are either registered trademarks or trademarks of Microsoft Corporation in the United States and/or other countries.

ENERGY STAR and the ENERGY STAR mark are registered trademarks owned by the U.S. Environmental Protection Agency.

Table of contents

1 Get started	1
Printer parts	2
Power button light	3
Load media	4
Paper basics	8
Open the HP printer software	10
Use the HP Smart app to print and troubleshoot	11
Print using the HP Smart app (Windows 10)	12
Sleep mode	13
Auto-Off	14
2 Print	15
Print documents	16
Print photos	17
Print envelopes	18
Print using the maximum dpi	19
Tips for print success	20
3 Manage ink cartridges	23
Check estimated ink levels	24
Order ink supplies	25
Replace ink cartridges	26
Use single-cartridge mode	28
Cartridge warranty information	29
Tips for working with cartridges	30
4 Connect your printer	31
Connect your printer to your computer with a USB cable (non-network connection)	32
Connect a new printer	33

5 Solve a problem	35
Jams and paper-feed issues	36
Ink cartridge issues	40
Printing issues	42
Printer hardware issues	47
HP support	48
Appendix A Technical information	51
Specifications	52
Regulatory notices	54
Environmental product stewardship program	57
Index	65

1 Get started

- [Printer parts](#)
- [Power button light](#)
- [Load media](#)
- [Paper basics](#)
- [Open the HP printer software](#)
- [Use the HP Smart app to print and troubleshoot](#)
- [Print using the HP Smart app \(Windows 10\)](#)
- [Sleep mode](#)
- [Auto-Off](#)

Printer parts

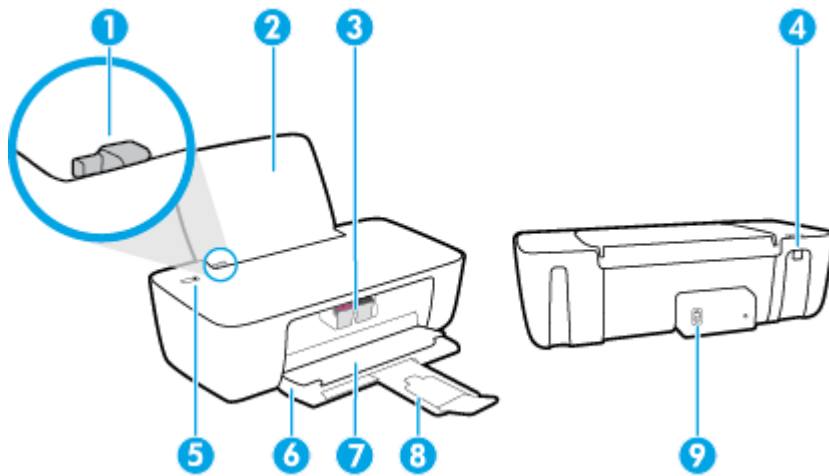

1	Paper-width guide
2	Input tray
3	Ink cartridges
4	USB port
5	Power button
6	Output tray
7	Cartridge access door
8	Output tray extender (also referred to as the tray extender)
9	Power connection

Power button light



Status	Description
Off	The printer is powered off.
Dim	Indicates the printer is in Sleep mode. The printer automatically enters Sleep mode after 5 minutes of inactivity.
Fast blinking	The printer is in an error state that you can resolve by following the on-screen messages from the computer. If you do not see any on-screen messages, try printing a document to generate an on-screen message.
Blinking	The printer is processing a job. To cancel the job, press the Power button (⏻).
On	The printer is on and ready to print.

NOTE: If you cleared a paper jam, the carriage was stalled, or the printer was out of paper, you need to press the **Power** button (⏻) once to resume printing. If you press the **Power** button (⏻) twice within two seconds, the printer turns off.

Load media

Select a paper size to continue.

To load full-size paper

1. Raise the input tray.

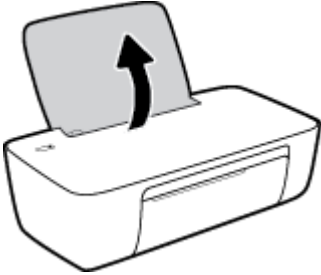

2. Slide the paper-width guide to the left.

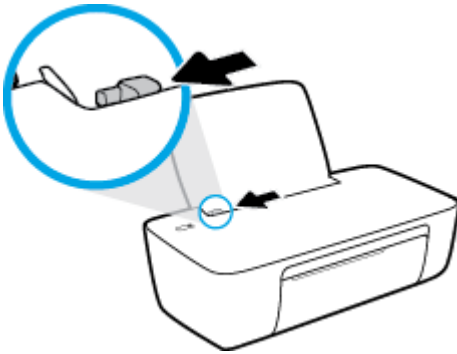

3. Insert a stack of paper into the input tray with the short edge down and the print side up, and slide the stack of paper down until it stops.

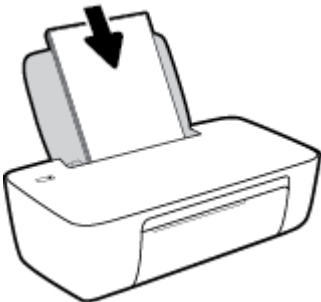

4. Slide the paper-width guide to the right until it stops at the edge of the paper.

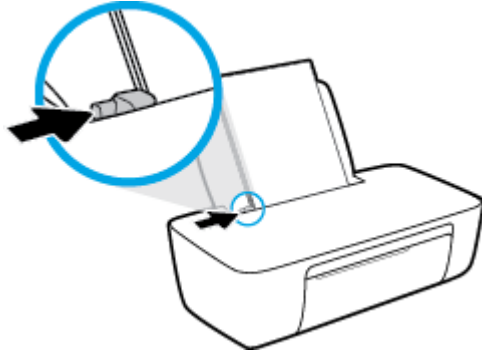

5. Lower the output tray and pull out the output tray extender.



To load small-size paper

1. Raise the input tray.

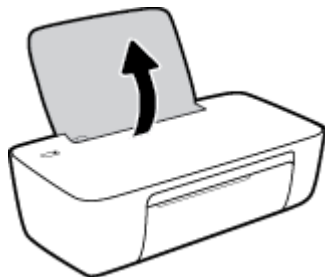

2. Slide the paper-width guide to the left.

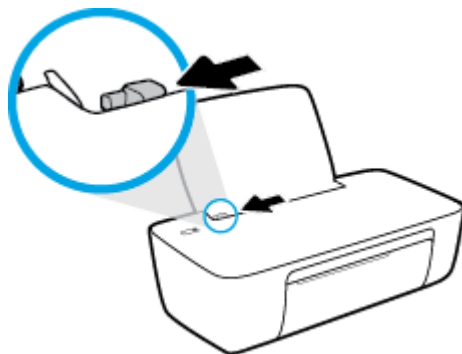

3. Insert a stack of photo paper into the far-right side of the input tray with the short edge down and the print side up, and slide the stack of paper down until it stops.

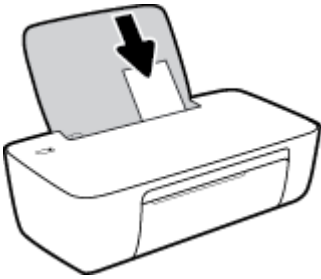

4. Slide the paper-width guide to the right until it stops at the edge of the paper.

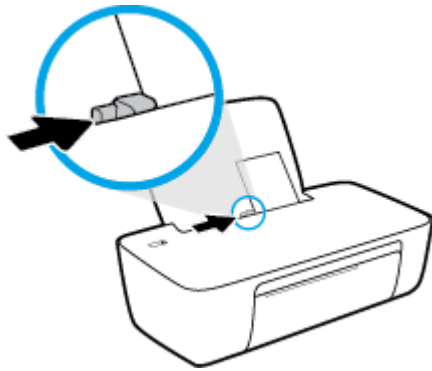

5. Lower the output tray and pull out the output tray extender.



To load envelopes

1. Raise the input tray.

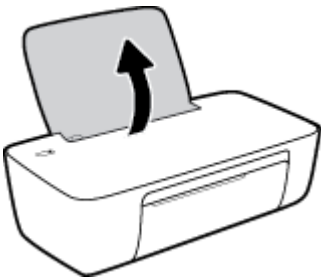

2. Slide the paper-width guide to the left.

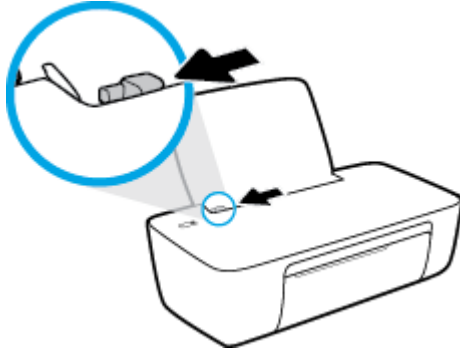

3. Insert one or more envelopes into the far-right side of the input tray and slide the stack of envelopes down until it stops.

The side to be printed on should face up. The flap should be on the left side and facing down.

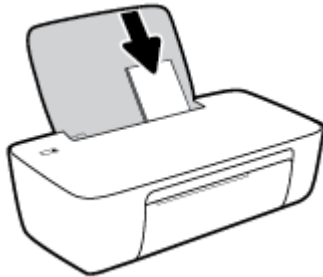

4. Slide the paper-width guide to the right against the stack of envelopes until it stops.

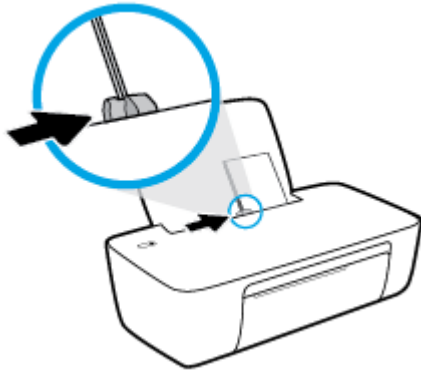

5. Lower the output tray and pull out the output tray extender.



Paper basics

The printer is designed to work well with most types of office paper. It is best to test a variety of print paper types before buying large quantities. Use HP paper for optimum print quality. Visit the HP website at www.hp.com for more information about HP paper.



HP recommends plain papers with the ColorLok logo for printing everyday documents. All papers with the ColorLok logo are independently tested to meet high standards of reliability and print quality, and produce documents with crisp, vivid color, bolder blacks, and that dry faster than ordinary plain papers. Look for papers with the ColorLok logo in a variety of weights and sizes from major paper manufacturers.

This section contains the following topics:

- [Recommended papers for printing](#)
- [Order HP paper supplies](#)

Recommended papers for printing

If you want the best print quality, HP recommends using HP papers that are specifically designed for the type of project you are printing.

Depending on your country/region, some of these papers might not be available.

Photo printing

- **HP Premium Plus Photo Paper**

HP Premium Plus Photo Paper is HP's highest-quality photo paper for your best photos. With HP Premium Plus Photo Paper, you can print beautiful photos that are instant-dry so you can share them right off the printer. It is available in several sizes, including A4, 8.5 x 11 inches, 4 x 6 inches (10 x 15 cm), 5 x 7 inches (13 x 18 cm), and in two finishes - glossy or soft gloss (semi-gloss). Ideal for framing, displaying, or gifting your best photos and special photo projects. HP Premium Plus Photo Paper delivers exceptional results with professional quality and durability.

- **HP Advanced Photo Paper**

This glossy photo paper features an instant-dry finish for easy handling without smudging. It resists water, smears, fingerprints, and humidity. Your prints have a look and feel comparable to a store-processed photo. It is available in several sizes, including A4, 8.5 x 11 inches, 10 x 15 cm (4 x 6 inches), 13 x 18 cm (5 x 7 inches). It is acid-free for longer lasting documents.

- **HP Everyday Photo Paper**

Print colorful, everyday snapshots at a low cost, using paper designed for casual photo printing. This affordable photo paper dries quickly for easy handling. Get sharp, crisp images when you use this paper with any inkjet printer. It is available in glossy finish in several sizes, including A4, 8.5 x 11 inches, 5 x 7 inches, and 4 x 6 inches (10 x 15 cm). It is acid-free for longer lasting documents.

- **HP Photo Value Packs**

HP Photo Value Packs conveniently package original HP ink cartridges and HP Advanced Photo Paper to save you time and take the guesswork out of printing affordable, lab-quality photos with your HP

printer. Original HP inks and HP Advanced Photo Paper have been designed to work together so your photos are long lasting and vivid, print after print. Great for printing out an entire vacation's worth of photos or multiple prints to share.

Business documents

- **HP Premium Presentation Paper 120g Matte or HP Professional Paper 120 Matt**

This paper is a heavy two-sided matte paper perfect for presentation, proposals, reports, and newsletters. It is heavyweight for an impressive look and feel.

- **HP Brochure Paper 180g Glossy or HP Professional Paper 180 Glossy**

These papers are glossy-coated on both sides for two-sided use. They are the perfect choice for near-photographic reproductions and business graphics for report covers, special presentations, brochures, mailers, and calendars.

- **HP Brochure Paper 180g Matte or HP Professional Paper 180 Matte**

These papers are matte-coated on both sides for two-sided use. They are the perfect choice for near-photographic reproductions and business graphics for report covers, special presentations, brochures, mailers, and calendars.

Everyday printing

All the papers listed for everyday printing feature ColorLok Technology for less smearing, bolder blacks, and vivid colors.

- **HP Bright White Inkjet Paper**

HP Bright White Inkjet Paper delivers high-contrast colors and sharp text. It is opaque enough for two-sided color usage with no show-through, which makes it ideal for newsletters, reports, and flyers.

- **HP Printing Paper**

HP Printing Paper is a high-quality multifunction paper. It produces documents that look and feel more substantial than documents printed on standard multipurpose or copy paper. It is acid-free for longer lasting documents.

- **HP Office Paper**

HP Office Paper is a high-quality multifunction paper. It is suitable for copies, drafts, memos, and other everyday documents. It is acid-free for longer lasting documents.

- **HP Office Recycled Paper**

HP Office Recycled Paper is a high-quality multifunction paper made with 30% recycled fiber.

Order HP paper supplies

The printer is designed to work well with most types of office paper. Use HP paper for optimum print quality.

To order HP papers and other supplies, go to www.hp.com. At this time, some portions of the HP website are available in English only.

HP recommends plain papers with the ColorLok logo for printing and copying of everyday documents. All papers with the ColorLok logo are independently tested to meet high standards of reliability and print quality, and produce documents with crisp, vivid color, bolder blacks and shorter dry-time than ordinary plain papers. Look for papers with the ColorLok logo in a variety of weights and sizes from major paper manufacturers.

Open the HP printer software

After completing the hardware setup, visit 123.hp.com on your computer, if you have not installed the HP printer software.



NOTE:

- If you are using the HP Smart app instead of the printer software, see [Use the HP Smart app to print and troubleshoot on page 11](#).
 - Each device must have the app or software installed in order to print.
-

After installing the HP printer software, do one of the following:

- **Windows 10:** From the computer desktop, click **Start**, select **HP** from the app list, and then select the icon with the printer name.
- **Windows 7:** From the computer desktop, click **Start**, select **All Programs**, click **HP**, click the folder for the printer, and then select the icon with the printer name.

Use the HP Smart app to print and troubleshoot

HP Smart helps you to set up, print, share, and manage your HP printer. You can share documents and images through email, text messages, and popular cloud and social media services (such as iCloud, Google Drive, Dropbox, and Facebook). You can also set up new HP printers, as well as monitor and order supplies.



NOTE: The HP Smart app is supported on Windows 10 for the printer. The app might not be available in all languages. Some features might not be available with all printer models.

- For basic instructions on how to print and troubleshoot using HP Smart, see [Print using the HP Smart app \(Windows 10\) on page 12](#). For more information, you can also visit www.hp.com/go/hpsmartwin-help.

To install the HP Smart app on Windows 10 and connect to your printer

1. To get the HP Smart app, visit 123.hp.com or the device app store to download and install the app.
2. After installation, click **Start** from the computer desktop.
3. To connect to your printer make sure your printer and device are turned on and connected.
4. Open the HP Smart app on your device.
5. On the Home screen of HP Smart, click **+** (Plus icon), and then select or add a printer.

Follow the onscreen instructions to complete the connection.

Print using the HP Smart app (Windows 10)

This section provides basic instructions for using the HP Smart app to print from your device. For more information about the app, see [Use the HP Smart app to print and troubleshoot on page 11](#).

To begin using the HP Smart app to print

1. Load paper in the input tray. For more information, see [Load media on page 4](#).
2. Open the HP Smart app on your device.
3. On the Home screen of HP Smart, make sure your printer is selected.

 **TIP:** If a printer is already set up, you can select it from the Home screen of HP Smart by swiping left or right and selecting it.

To use a different printer, click or tap **+** (Plus icon) on the Home screen, and then select a different printer or add a new printer.

To print from a Windows 10 device

1. On the Home screen of HP Smart, do one of the following:
 - Select **Print Photo**, locate a photo you want to print, and then click or tap **Select Photos to Print**.
 - Select **Print Document**, locate a PDF document you want to print, and then click or tap **Print**.
2. Select the appropriate options. To view more settings, click or tap **More settings**.

For more information about printing settings, see [Tips for print success on page 20](#).

3. Click or tap **Print** to begin printing.

Sleep mode

- Power usage is reduced while in Sleep mode.
- After initial setup of printer, the printer will enter Sleep mode after 5 minutes of inactivity.
- The Power button light is dimmed in Sleep mode.
- The time to Sleep mode cannot be changed.

Auto-Off

This feature turns the printer off after 2 hours of inactivity to help reduce energy use. **Auto-Off turns the printer off completely, so you must use the Power button to turn the printer back on.** If your printer supports this energy saving feature, Auto-Off is automatically enabled or disabled depending on printer capabilities and connection options. Even when Auto-Off is disabled, the printer enters Sleep mode after 5 minutes of inactivity to help reduce energy use.

- Auto-Off is enabled when the printer is turned on, if the printer does not have network or fax capability, or is not using these capabilities.
- Auto-Off is disabled when a printer's wireless or Wi-Fi Direct capability is turned on or when a printer with fax, USB, or Ethernet network capability establishes a fax, USB, or Ethernet network connection.

 **TIP:** To conserve battery power, you can enable Auto-Off, even when the printer is connected or wireless is turned on.

2 Print

- [Print documents](#)
- [Print photos](#)
- [Print envelopes](#)
- [Print using the maximum dpi](#)
- [Tips for print success](#)

Print documents

Before printing documents, make sure you have paper loaded in the input tray and the output tray is open. For more information about loading paper, see [Load media on page 4](#).

To print a document (Windows)

1. From your software, select **Print**.
2. Make sure your printer is selected.
3. Click the button that opens the **Properties** dialog box.

Depending on your software application, this button might be called **Properties**, **Options**, **Printer Setup**, **Printer Properties**, **Printer**, or **Preferences**.

4. Select the appropriate options.
 - On the **Layout** tab, select **Portrait** or **Landscape** orientation.
 - On the **Paper/Quality** tab, select the appropriate paper type from the **Media** drop-down list in the **Tray Selection** area, select the appropriate print quality in the **Quality Settings** area, and then select the appropriate color in the **Color** area.
 - Click **Advanced** to select the appropriate paper size from the **Paper Size** drop-down list.
5. Click **OK** to close the **Properties** dialog box.
6. Click **Print** or **OK** to begin printing.

To print on both sides of the page (Windows)

1. From your software, select **Print**.
2. Make sure your printer is selected.
3. Click the button that opens the **Properties** dialog box.

Depending on your software application, this button might be called **Properties**, **Options**, **Printer Setup**, **Printer Properties**, **Printer**, or **Preferences**.

4. Select the appropriate options.
 - On the **Layout** tab, select **Portrait** or **Landscape** orientation.
 - On the **Paper/Quality** tab, select the appropriate paper type from the **Media** drop-down list in the **Tray Selection** area, select the appropriate print quality in the **Quality Settings** area, and then select the appropriate color in the **Color** area.
 - Click **Advanced** to select the appropriate paper size from the **Paper Size** drop-down list.
5. On the **Layout** tab, select an appropriate option from the **Print on Both Sides Manually** drop-down list.
6. After you print the first side, follow the on-screen instructions to reload the paper with the blank side up and top of the page down, and then click **Continue**.
7. Click **OK** to print.

Print photos

Before printing photos, make sure you have photo paper loaded in the input tray and the output tray is open. For more information about loading paper, see [Load media on page 4](#).

To print a photo on photo paper (Windows)

1. From your software, select **Print**.
2. Make sure your printer is selected.
3. Click the button that opens the **Properties** dialog box.

Depending on your software application, this button might be called **Properties**, **Options**, **Printer Setup**, **Printer Properties**, **Printer**, or **Preferences**.

4. Select the appropriate options.
 - On the **Layout** tab, select **Portrait** or **Landscape** orientation.
 - On the **Paper/Quality** tab, select the appropriate paper type from the **Media** drop-down list in the **Tray Selection** area, select the appropriate print quality in the **Quality Settings** area, and then select the appropriate color in the **Color** area.
 - Click **Advanced** to select the appropriate photo size from the **Paper Size** drop-down list.
5. Click **OK** to return to the **Properties** dialog box.
6. Click **OK**, and then click **Print** or **OK** in the **Print** dialog box.



NOTE: After the printing is finished, remove unused photo paper from the input tray. Store the photo paper so it does not start to curl, which could reduce the quality of your printout.

Print envelopes

Before printing envelopes, make sure you have envelopes loaded in the input tray and the output tray is open. You can load one or more envelopes into the input tray. Do not use shiny or embossed envelopes or envelopes that have clasps or windows. For more information about loading envelopes, see [Load media on page 4](#).



NOTE: For specific details on how to format text for printing on envelopes, consult the help files in your word application.

To print an envelope (Windows)

1. From your software, select **Print**.
2. Make sure your printer is selected.
3. Click the button that opens the **Properties** dialog box.

Depending on your software application, this button might be called **Properties**, **Options**, **Printer Setup**, **Printer Properties**, **Printer**, or **Preferences**.

4. Select the appropriate options.
 - On the **Layout** tab, select **Portrait** or **Landscape** orientation.
 - On the **Paper/Quality** tab, select the appropriate paper type from the **Media** drop-down list in the **Tray Selection** area, select the appropriate print quality in the **Quality Settings** area, and then select the appropriate color in the **Color** area.
 - Click **Advanced** to select the appropriate envelope size from the **Paper Size** drop-down list.
5. Click **OK**, and then click **Print** or **OK** in the **Print** dialog box.

Print using the maximum dpi

Use maximum dots per inch (dpi) to print high-quality, sharp images on photo paper.

Printing in maximum dpi takes longer than printing with other settings and requires a large amount of disk space.

For a list of supported print resolutions, visit www.support.hp.com.

To print in maximum dpi mode (Windows)

1. From your software, select **Print**.
2. Make sure your printer is selected.
3. Click the button that opens the **Properties** dialog box.
Depending on your software application, this button might be called **Properties, Options, Printer Setup, Printer Properties, Printer, or Preferences**.
4. Click the **Paper/Quality** tab.
5. From the **Media** drop-down list, select an appropriate paper type.
6. Click the **Advanced** button.
7. In the **Printer Features** area, select **Yes** from the **Print in Max DPI** drop-down list.
8. Select the appropriate paper size from the **Paper Size** drop-down list.
9. Click **OK** to close the advanced options.
10. Confirm **Orientation** on the **Layout** tab, and then click **OK** to print.

Tips for print success

To print successfully, the HP ink cartridges should be functioning properly with sufficient ink, the paper should be loaded correctly, and the printer should have the appropriate settings.

Ink tips

- Use original HP ink cartridges.
- Install both the black and tri-color cartridges correctly.

For more information, see [Replace ink cartridges on page 26](#).

- Check the estimated ink levels in the ink cartridges to make sure there is sufficient ink.
For more information, see [Check estimated ink levels on page 24](#).
- If the print quality is not acceptable, see [Printing issues on page 42](#) for more information.

Paper loading tips

- Load a stack of paper (not just one page). All of the paper in the stack should be in the same size and type to avoid a paper jam.
- Load the paper with side to be printed on facing up.
- Ensure that paper loaded in the input tray lays flat, and the edges are not bent or torn.
- Adjust the paper-width guide in the input tray to fit snugly against all paper. Make sure the paper-width guide does not bend the paper in the input tray.

For more information, see [Load media on page 4](#).

Printer settings tips (Windows)

- To change default print settings, open the HP printer software, click **Print**, and then click **Set Preferences**. For information how to open the printer software, see [Open the HP printer software on page 10](#).
- To select the number of pages to print per sheet, on the **Layout** tab, select the appropriate option from the **Pages per Sheet** drop-down list.
- To view more printing settings, on the **Layout** or **Paper/Quality** tab, click the **Advanced** button to open the **Advanced Options** dialog box.
 - **Print in Grayscale:** Allows you to print a black and white document using the black ink only. Select **Black Ink Only**, and then click **OK**. It also allows you to print a high quality black and white image. Select **High Quality Grayscale**, and then click **OK**.
 - **Pages per Sheet Layout:** Helps you specify the order of the pages if you print the document with more than two pages per sheet.



NOTE: The preview on the **Layout** tab cannot reflect what you select from the **Pages per Sheet Layout** drop-down list.

- **HP Real Life Technologies:** This feature smooths and sharpens images and graphics for improved print quality.

- **Booklet:** Allows you to print a multiple-page document as a booklet. It places two pages on each side of a sheet that can then be folded into a booklet in half size of the paper. Select a binding method from the drop-down list, and then click **OK**.
 - **Booklet-LeftBinding:** The binding side after folded into a booklet appears at the left side. Select the option if your reading habit is from left to right.
 - **Booklet-RightBinding:** The binding side after folded into a booklet appears at the right side. Select the option if your reading habit is from right to left.



NOTE: The preview on the **Layout** tab cannot reflect what you select from the **Booklet** drop-down list.

- **Pages to Print:** Allows you to print the odd pages only, print the even pages only, or print all pages.
- **Page Borders:** Allows you to add borders to the pages if you print the document with two or more pages per sheet.



NOTE: The preview on the **Layout** tab cannot reflect what you select from the **Page Borders** drop-down list.

- You can use printing shortcut to save time setting printing preferences. A printing shortcut stores the setting values that are appropriate for a particular kind of job, so that you can set all the options with a single click. To use it, go to the **Printing Shortcut** tab, select one printing shortcut, and then click **OK**.

To add a new printing shortcut, after making settings on the **Layout** or **Paper/Quality** tab, click the **Printing Shortcut** tab, click **Save As** and enter a name, and then click **OK**.

To delete a printing shortcut, select it, and then click **Delete**.



NOTE: You cannot delete the default printing shortcuts.

Notes

- Original HP ink cartridges are designed and tested with HP printers and papers to help you easily produce great results, time after time.



NOTE: HP cannot guarantee the quality or reliability of non-HP supplies. Product service or repairs required as a result of using a non-HP supply will not be covered under warranty.

If you believe the purchased original HP ink cartridges, go to:

www.hp.com/go/anticounterfeit

- Ink level warnings and indicators provide estimates for planning purposes only.



NOTE: When you receive a low-ink warning message, consider having a replacement ink cartridge available to avoid possible printing delays. You do not need to replace the ink cartridges until the print quality becomes unacceptable.

- You can print your document on both sides of the paper manually.

3 Manage ink cartridges

This section contains the following topics:

- [Check estimated ink levels](#)
- [Order ink supplies](#)
- [Replace ink cartridges](#)
- [Use single-cartridge mode](#)
- [Cartridge warranty information](#)
- [Tips for working with cartridges](#)

Check estimated ink levels

You can easily check the ink supply level to determine how soon you might need to replace an ink cartridge. The ink supply level shows an estimate of the amount of ink remaining in the ink cartridges.

To check the ink levels from the HP printer software (Windows)

1. Open the HP printer software. For more information, see [Open the HP printer software on page 10](#).
2. In the printer software, click the **Estimated Ink Levels** tab.

 **NOTE:** If you have installed a refilled or remanufactured ink cartridge, or an ink cartridge that has been used in another printer, the ink level indicator might be inaccurate or unavailable.

 **NOTE:** Ink level warnings and indicators provide estimates for planning purposes only. When you receive a low-ink warning message, consider having a replacement ink cartridge available to avoid possible printing delays. You do not have to replace the ink cartridges until the print quality is unacceptable.

 **NOTE:** Ink from the ink cartridges is used in the printing process in a number of different ways, including in the initialization process, which prepares the printer and cartridges for printing, and in printhead servicing, which keeps print nozzles clear and ink flowing smoothly. In addition, some residual ink is left in the ink cartridge after it is used. For more information, see www.hp.com/go/inkusage.

Order ink supplies

Before ordering cartridges, locate the correct cartridge number.

To locate the cartridge number on the printer

- The cartridge number is located inside the cartridge access door.



To locate the cartridge number from the printer software (Windows)

1. Open the HP printer software. For more information, see [Open the HP printer software on page 10](#).
2. In the printer software, click **Shop**, click **Shop For Supplies Online**, and then follow the on-screen instructions.

To order original HP supplies for the printer, go to www.hp.com/buy/supplies. If prompted, choose your country/region, and then follow the prompts to find the right cartridges for your printer.

 **NOTE:** Ordering ink cartridges online is not supported in all countries/regions. If it is not available in your country/region, you may still view supplies information and print a list for reference when shopping at a local HP reseller.

Replace ink cartridges

To replace the ink cartridges

1. Check that power is on.
2. Remove the ink cartridge.
 - a. Open the cartridge access door and wait for the print carriage to move to the center of the printer.

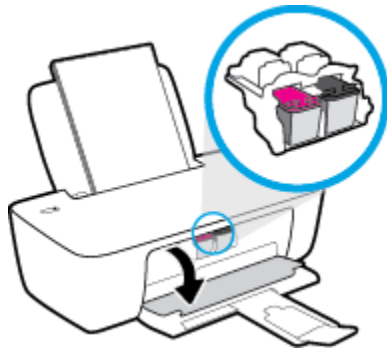

- b. Press down to release the ink cartridge, and then remove it from the slot.

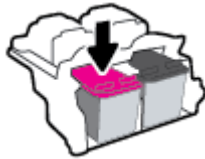

3. Insert a new ink cartridge.
 - a. Remove the ink cartridge from the packaging.

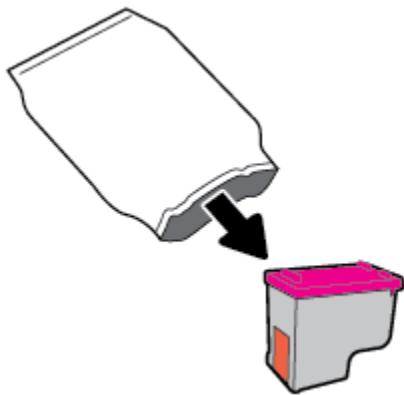

- b. Remove the plastic tape using the pull tab.

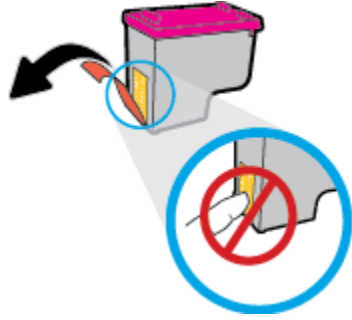

 **NOTE:** Do not touch the electrical contacts on the ink cartridge.

- c. Slide the ink cartridge into the slot until it clicks into place.

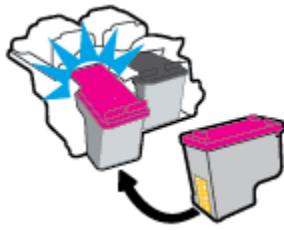

- d. Close the cartridge access door.



 **NOTE:** The HP printer software prompts you to align the ink cartridges when you print a document after installing the new ink cartridge.

Use single-cartridge mode

Use the single-cartridge mode to operate the printer with only one ink cartridge. The single-cartridge mode is initiated when an ink cartridge is removed from the ink cartridge carriage.



NOTE: When the printer operates in single-cartridge mode, a message is displayed on the computer screen. If the message is displayed and two ink cartridges are installed in the printer, verify that the protective piece of plastic tape has been removed from each ink cartridge. When the plastic tape covers the ink cartridge contacts, the printer cannot detect that the ink cartridge is installed. If there is no plastic tape on the cartridges, try cleaning the cartridge contacts. For information about cleaning ink cartridge contacts, see [Ink cartridge issues on page 40](#).

To exit the single-cartridge mode

- Install both the black and tri-color ink cartridges in the printer.

Cartridge warranty information

The HP cartridge warranty is applicable when the cartridge is used in its designated HP printing device. This warranty does not cover HP ink cartridges that have been refilled, remanufactured, refurbished, misused, or tampered with.

During the warranty period, the cartridge is covered as long as the HP ink is not depleted and the end of warranty date has not been reached. The end of warranty date, in YYYY/MM/DD format, may be found on the cartridge as indicated:

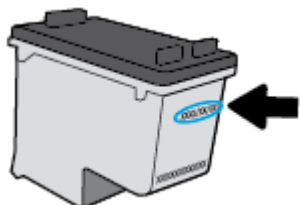

For a copy of the HP Limited Warranty Statement, see the printed documentation that came with the printer.

Tips for working with cartridges

Use the following tips to work with cartridges:

- To protect the cartridges from drying out, always turn the printer off using the **Power** button, and wait until the **Power** button light goes out.
- Do not open or untape cartridges until you are ready to install them. Leaving tape on the cartridges reduces ink evaporation.
- Insert the cartridges into the correct slots. Match the color and icon of each cartridge to the color and icon for each slot. Make sure the cartridges snap into place.
- Align the printer for best print quality. See [Printing issues on page 42](#) for more information.
- When the Estimated Ink Levels screen shows one or both cartridges in a low state, consider getting replacement cartridges to avoid possible printing delays. You do not need to replace the cartridges until print quality becomes unacceptable. See [Replace ink cartridges on page 26](#) for more information.
- If you remove a cartridge from the printer for any reason, try to replace it again as soon as possible. Outside of the printer, if unprotected, cartridges begin to dry out.

4 Connect your printer

- [Connect your printer to your computer with a USB cable \(non-network connection\)](#)
- [Connect a new printer](#)

Connect your printer to your computer with a USB cable (non-network connection)

The printer supports a rear USB 2.0 High Speed port for connection to a computer.

If the HP printer software has been installed, the printer will operate as a plug-and-play device. If the software has not been installed, follow the steps below to connect the printer with the USB cable.

To connect the printer with a USB cable using the HP printer software

1. Enter 123.hp.com in a web browser on your computer to download and install the HP printer software. You can also use the HP printer software CD (if provided), or download the software from www.hp.com/support.



NOTE: Do not connect the USB cable to the printer until you are prompted to do so.

2. Follow the on-screen instructions. When you are prompted, connect the printer to the computer by selecting **USB** on the **Connection Options** screen.
3. Follow the onscreen instructions.

To connect the printer with the USB cable

1. Enter 123.hp.com in a web browser on your computer to download and install the HP printer software. You can also use the HP printer software CD (if provided), or download the software from www.hp.com/support.



NOTE: Do not connect the USB cable to the printer until you are prompted to do so.

2. Follow the onscreen instructions. When you are prompted, connect the printer to the computer by selecting **USB** on the **Connection Options** screen.
3. Follow the onscreen instructions.

To connect the printer with a USB cable using the HP Smart app

1. Connect the USB cable to the printer from your device.
2. Open the HP Smart app on your device. For information, see [Use the HP Smart app to print and troubleshoot on page 11](#).
3. On the Home screen of HP Smart, click or tap **+** (Plus icon), and then select your printer.

Connect a new printer

If you have not connected the printer to your computer, or you want to connect another new printer of the same model to your computer, you can use the following instructions to set up the connection.



NOTE: Use this method if you have already installed the printer software.

To connect a new printer (Windows)

1. Open the printer software. For more information, see [Open the HP printer software on page 10](#).
2. In the printer software, click **Utilities**.
3. Select **Printer Setup & Software**.
4. Select **Connect a new printer**. Follow the onscreen instructions.

5 Solve a problem

This section contains the following topics:

- [Jams and paper-feed issues](#)
- [Ink cartridge issues](#)
- [Printing issues](#)
- [Printer hardware issues](#)
- [HP support](#)

Jams and paper-feed issues

What do you want to do?

Clear a paper jam

Solve paper jam issues.	Use an HP online troubleshooting wizard
	Instructions for clearing paper jams and resolving issues with paper or the paper feed.

 **NOTE:** The HP online troubleshooting wizards may not be available in all languages.

Read general instructions in the Help for clearing paper jams

Paper jams can occur in several locations.

To clear a paper jam from the input tray

1. Pull the paper gently out of the input tray.

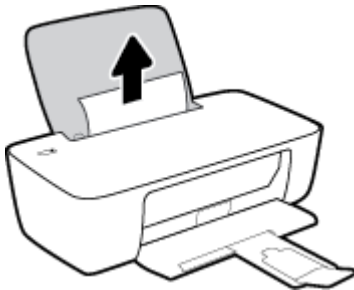

2. Make sure there is no foreign object in the paper path, and then reload paper.

 **NOTE:** The input tray shield can prevent foreign debris from falling into the paper path and causing serious paper jams. Do not take down the input tray shield.

3. Press the **Power** button () to continue the current job.

To clear a paper jam from the output tray

1. Pull the paper gently out of the output tray.



2. Press the **Power** button () to continue the current job.

To clear a paper jam from the cartridge access area

1. Remove the jammed paper.
 - a. Press the **Power** button (⏻) to turn off the printer.
 - b. Open the cartridge access door.
 - c. If the print carriage is in the center of the printer, slide it to the right.

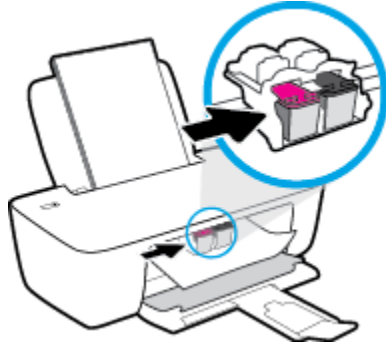

- d. Remove the jammed paper.



- e. Close the cartridge access door.

2. Press the **Power** button (⏻) to turn on the printer.

To clear a paper jam inside of the printer

1. Press the **Power** button (⏻) to turn off the printer.
2. Turn the printer over, locate the cleanout door on the bottom of the printer, and then pull both tabs on the cleanout door to open it.

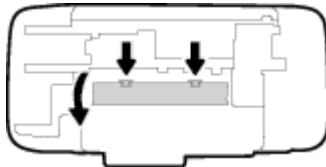

3. Remove the jammed paper.

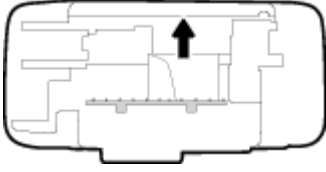

4. Close the cleanout door. Gently push the door towards the printer until both latches snap into place.



5. Turn the printer over, and then press the **Power** button (⏻) to turn on the printer.

Clear a print carriage jam

[Resolve a print carriage jam.](#)

Use an HP online troubleshooting wizard

If something is blocking the print carriage or it does not move easily, get step-by-step instructions.



NOTE: The HP online troubleshooting wizards may not be available in all languages.

Read general instructions in the Help for clearing a print carriage jams

- ▲ Remove any objects, such as paper, that are blocking the print carriage.



NOTE: Do not use any tools or other devices to remove jammed paper. Always use caution when removing jammed paper from inside the printer.

Learn how to avoid paper jams

To help avoid paper jams, follow these guidelines.

- Do not overfill the input tray.
- Remove printed papers from the output tray frequently.
- Ensure that paper loaded in the input tray lays flat, and the edges are not bent or torn.
- Do not combine different paper types and paper sizes in the input tray; the entire stack of paper in the input tray must be the same size and type.
- Adjust the paper-width guide in the input tray to fit snugly against all paper. Make sure the paper-width guide does not bend the paper in the input tray.
- Do not force paper too far down in the input tray.
- Do not add paper while the printer is printing. If the printer is about to run out of paper, wait until the out of paper message appears before adding paper.

Solve paper-feed problems

What kind of problem are you having?

- **Paper is not picked up from the input tray**
 - Make sure paper is loaded in the input tray. For more information, see [Load media on page 4](#).
 - Adjust the paper-width guide in the input tray to fit snugly against all paper. Make sure the paper-width guide does not bend the paper in the input tray.
 - Make sure paper in the input tray is not curled. Uncurl paper by bending it in the opposite direction of the curl.
- **Pages are skewing**
 - Make sure the paper is loaded in the far-right side of the input tray and the paper-width guide is fit against the left side of the paper.
 - Load paper into the printer only when it is not printing.
- **Multiple pages are being picked up**
 - Adjust the paper-width guide in the input tray to fit snugly against all paper. Make sure the paper-width guide does not bend the paper in the input tray.
 - Make sure the input tray is not overloaded with paper.
 - Make sure the pieces of the loaded paper are not sticking together.
 - Use HP paper for optimum performance and efficiency.

Ink cartridge issues

Identify whether an ink cartridge has a problem

If you get an ink cartridge problem message from the printer software that states at least one of the cartridges has a problem, do the following to identify whether a cartridge has a problem.

1. Remove the black cartridge and then close the cartridge access door.
 - If the **Power** button light blinks quickly, the tri-color cartridge has a problem.
 - If the **Power** button light does not blink, the tri-color cartridge does not have a problem.
2. Install the black cartridge back in the printer, remove tri-color cartridge, and then close the cartridge access door.
 - If the **Power** button light blinks quickly, the black cartridge has a problem.
 - If the **Power** button light does not blink, the black cartridge does not have a problem.

Fix ink cartridge problems

If an error occurs after a cartridge is installed, or if a message indicates a cartridge problem, try removing the ink cartridges, verifying the protective piece of plastic tape has been removed from each ink cartridge, and then reinserting the ink cartridges. If this does not work, clean the cartridge contacts. If the problem is still not resolved, replace the ink cartridges. For information about replacing ink cartridges, see [Replace ink cartridges on page 26](#).

To clean cartridge contacts

⚠ CAUTION: The cleaning procedure should take only a few minutes. Make sure that the ink cartridges are reinstalled in the printer as soon as possible. It is not recommended to leave the ink cartridges outside of the printer longer than 30 minutes. This could result in damage to the printhead or the ink cartridges.

1. Check that power is on.
2. Open the cartridge access door and wait for the print carriage to move to the center of the printer.

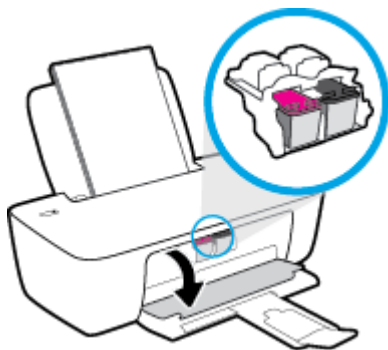

3. Remove the ink cartridge indicated in the error message.

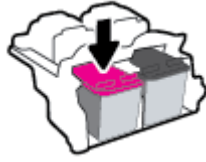

4. Clean the cartridge contacts and printer contacts.

- a. Hold the ink cartridge by its sides with the bottom pointing up and locate the electrical contacts on the ink cartridge.

The electrical contacts are the small gold-colored dots on the ink cartridge.

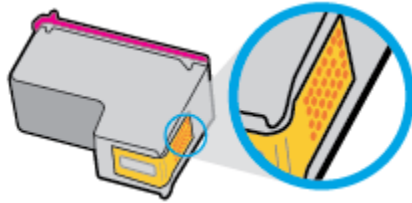

- b. Wipe only the contacts with a dry swab or lint-free cloth.

⚠ CAUTION: Be careful to wipe only the contacts, and do not smear any of the ink or other debris elsewhere on the ink cartridge.

- c. On the inside of the printer, locate the contacts for the cartridge.

The printer contacts are the set of gold-colored bumps positioned to meet the contacts on the ink cartridge.

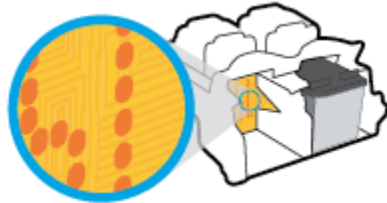

- d. Use a dry swab or lint-free cloth to wipe the contacts.

5. Reinstall the ink cartridge.
6. Close the cartridge access door.
7. Check if the error message has gone away. If you still receive the error message, turn the printer off, and then on.

📝 NOTE: If one ink cartridge is causing problems, you can remove it and use the single-cartridge mode to operate the printer with only one ink cartridge.

Fix ink cartridge incompatible issues

The ink cartridge is not compatible with your printer. Replace it with a new ink cartridge. For more information, see [Replace ink cartridges on page 26](#).

Printing issues

Fix problems with page not printing (unable to print)

HP Print and Scan Doctor	The HP Print and Scan Doctor is a utility that will try to diagnose and fix the issue automatically. NOTE: This utility is only available for Windows operation system.
Troubleshoot problems with print jobs not printing.	Use an HP online troubleshooting wizard Get step-by-step instructions if the printer is not responding or printing.



NOTE: The HP Print and Scan Doctor and the HP online troubleshooting wizards may not be available in all languages.

Read general instructions in the Help for unable to print issues

To resolve print issues (Windows)

Make sure that the printer is turned on and that there is paper in the input tray. If you are still unable to print, try the following in order:

1. Check for error messages from the printer software and resolve them by following the on-screen instructions.
2. If your computer is connected to the printer with a USB cable, disconnect and reconnect the USB cable.
3. Verify that the printer is not paused or offline.

To verify that the printer is not paused or offline

- a. Depending upon your operating system, do one of the following:
 - **Windows 10:** From the Windows **Start** menu, select **Windows System** from the app list, select **Control Panel**, and then click **View devices and printers** under **Hardware and Sound**.
 - **Windows 7:** From the Windows **Start** menu, click **Devices and Printers**.
 - b. Either double-click or right-click the icon for your printer and select **See what's printing** to open the print queue.
 - c. On the **Printer** menu, make sure there are no check marks next to **Pause Printing** or **Use Printer Offline**.
 - d. If you made any changes, try to print again.
4. Verify that the printer is set as the default printer.

To verify that the printer is set as the default printer

- a. Depending upon your operating system, do one of the following:

- **Windows 10:** From the Windows **Start** menu, select **Windows System** from the app list, select **Control Panel**, and then click **View devices and printers** under **Hardware and Sound**.
 - **Windows 7:** From the Windows **Start** menu, click **Devices and Printers**.
- b. Make sure the correct printer is set as the default printer.
- The default printer has a check mark in a black or green circle next to it.
- c. If the wrong printer is set as the default printer, right-click the correct printer and select **Set as Default Printer**.
- d. Try using your printer again.
5. Restart the print spooler.

To restart the print spooler

- a. Depending upon your operating system, do one of the following:
- **Windows 10 :** From the Windows **Start** menu, click **Windows System**, and then click **Control Panel**.
 - **Windows 7:** From the Windows **Start** menu, click **Control Panel**.
- b. Click **System and Security**, and then click **Administrative Tools**.
- c. Double-click **Services**.
- d. Right-click the **Print Spooler**, and then click **Properties**.
- e. On the **General** tab, make sure **Automatic** is selected from the **Startup type** drop-down list.
- f. Under **Service status**, check the status.
- If the service is not running, click **Start**.
 - If the service is running, click **Stop**, and then click **Start** to restart the service.
- Then click **OK**.
6. Restart the computer.
7. Clear the print queue.

To clear the print queue

- a. Depending upon your operating system, do one of the following:
- **Windows 10:** From the Windows **Start** menu, click **Windows System**, and then click **Control Panel**. Under **Hardware and Sound**, click **View devices and printers**.
 - **Windows 7:** From the Windows **Start** menu, click **Devices and Printers**.
- b. Right-click the printer, and then select the option to see what is printing.
- c. On the **Printer** menu, click **Cancel all documents** or **Purge Print Document**, and then click **Yes** to confirm.

- d. If there are still documents in the queue, restart the computer and try printing again after the computer has restarted.
- e. Check the print queue again to make sure it is clear, and then try to print again.

Fix print quality issues

[Step-by-step instructions for resolving most print quality issues.](#)

[Troubleshoot print quality issues online](#)

Read general instructions in the Help for resolving print quality issues



NOTE:

- To protect the cartridges from drying out, always turn the printer off using the **Power** button, and wait until the **Power** button light goes out.
 - To improve the print quality, you can also align or clean ink cartridges, or print a diagnostic page using the HP printer software or HP Smart app. For more information about the app, see [Use the HP Smart app to print and troubleshoot on page 11](#).
-

To improve print quality (Windows)

1. Make sure you are using original HP ink cartridges.
2. Check the printer software to make sure you have selected the appropriate paper type from the **Media** drop-down list and print quality from the **Quality Settings** drop-down list.

In the printer software, click **Print** and then click **Set Preferences** to access the print properties.

3. Check the estimated ink levels to determine if the ink cartridges are low on ink.

For more information, see [Check estimated ink levels on page 24](#). If the ink cartridges are low on ink consider replacing them.

4. Check the paper type.

For best print quality, use high quality HP paper, or papers that adhere to the ColorLok® standard. For more information, see [Paper basics on page 8](#).

Always make sure the paper you are printing on is flat. For best results when printing images, use HP Advanced Photo Paper.

Store specialty paper in its original packaging inside a resealable plastic bag on a flat surface in a cool, dry place. When you are ready to print, remove only the paper you plan to use immediately. When you have finished printing, return any unused photo paper to the plastic bag. This prevents the photo paper from curling.

5. Align the ink cartridges.

To align the ink cartridges

- a. Load letter or A4 unused plain white paper into the input tray.
- b. Open the printer software. For more information, see [Open the HP printer software on page 10](#).

- c. In the printer software, click **Print** and then click **Maintain Your Printer** to access the printer toolbox.
The printer toolbox appears.
 - d. Click **Align Ink Cartridges** on the **Device Services** tab.
The printer prints an alignment page.
 - e. Follow the on-screen instructions in the printer software to complete the alignment.
6. Print a diagnostics page if the ink cartridges are not low on ink.

To print a diagnostics page

- a. Load letter or A4 unused plain white paper into the input tray.
- b. Open the printer software. For more information, see [Open the HP printer software on page 10](#).
- c. In the printer software, click **Print** and then click **Maintain Your Printer** to access the printer toolbox.
- d. Click **Print Diagnostic Information** on the **Device Reports** tab to print a diagnostics page.
- e. Review the blue, magenta, yellow, and black boxes on the diagnostics page.



- 7. Clean the ink cartridges, if the diagnostic page shows steaks or missing portions of the color and black boxes.

To clean the ink cartridges

- a. Load letter or A4 unused plain white paper into the input tray.
- b. Open the printer software. For more information, see [Open the HP printer software on page 10](#).
- c. In the printer software, click **Print** and then click **Maintain Your Printer** to access the **Printer Toolbox**.
- d. Click **Clean Ink Cartridges** on the **Device Services** tab. Follow the on-screen instructions.

Printer hardware issues

Close cartridge access door

- Cartridge door must be closed to begin printing.



The printer shuts down unexpectedly

- Check the power and power connections.
- Make sure the printer's power cord is connected firmly to a functioning power outlet.



NOTE: When Auto-Off is enabled, the printer will automatically turn off after 2 hours of inactivity to help reduce energy use. For more information, see [Auto-Off on page 14](#).

Resolve printer failure

- Turn the printer off, then on. If that does not resolve the problem, contact HP.

HP support

For the latest product updates and support information, visit www.support.hp.com. HP online support provides a variety of options for help with your printer:



Drivers & downloads: Download software drivers and updates, as well as product manuals and documentation that came in the box with your printer.



HP support forums: Visit HP Support Forums for answers to common questions and issues. You can view questions posted by other HP customers, or sign in and post your own questions and comments.



Troubleshooting: Use HP online tools to detect your printer and find recommended solutions.

Contact HP

If you need help from an HP technical support representative to solve a problem, visit the [Contact Support website](#). The following contact options are available at no cost for in-warranty customers (HP agent-assisted support for out-of-warranty customers may require a fee):



Chat with an HP support agent online.



Call an HP support agent.

When contacting HP support, be prepared to provide the following information:

- Product name (located on the printer)
- Product number (located inside the cartridge access door)



- Serial number (located on the back or bottom of the printer)

Register printer

By taking just a few quick minutes to register, you can enjoy quicker service, more efficient support, and product support alerts. If you did not register your printer while installing the software, you can register now at <http://www.register.hp.com>.

Additional warranty options

Extended service plans are available for the printer at additional costs. Go to www.support.hp.com, select your country/region and language, then explore the extended warranty options available for your printer.

A Technical information

The information contained herein is subject to change without notice. Some statements might not be applicable for your printer or all countries/regions.

This section contains the following topics:

- [Specifications](#)
- [Regulatory notices](#)
- [Environmental product stewardship program](#)

Specifications

For more information, visit www.support.hp.com.

System requirements

- For information about future operating system releases and support, visit www.support.hp.com.

Environmental specifications

- Recommended operating temperature range: 15°C to 30°C (59°F to 86°F)
- Allowable operating temperature range: 5°C to 40°C (41°F to 104°F)
- Humidity: 15% to 80% RH non-condensing; 28°C maximum dewpoint
- Nonoperating (Storage) temperature range: -40°C to 60°C (-40°F to 140°F)
- In the presence of high electromagnetic fields, it is possible the output from the printer may be slightly distorted
- HP recommends using a USB cable less than or equal to 3 m (10 feet) in length to minimize injected noise due to potential high electromagnetic fields

Input tray capacity

- Plain paper sheets (80 g/m² [20lb]): Up to 60
- Envelopes: Up to 5
- Index cards: Up to 20
- Photo paper sheets: Up to 20

Output tray capacity

- Plain paper sheets (80 g/m² [20lb]): Up to 25
- Envelopes: Up to 5
- Index cards: Up to 10
- Photo paper sheets: Up to 10

Paper size

- For a complete list of supported media sizes, see the printer software.

Paper weights

- Plain Paper: 64 to 90 g/m² (16 to 24 lb)
- Envelopes: 75 to 90 g/m² (20 to 24 lb)
- Cards: Up to 200 g/m² (110-lb index maximum)
- Photo Paper: Up to 280 g/m² (75 lb)

Print specifications

- Print speeds vary according to the complexity of the document
- Method: drop-on-demand thermal inkjet
- Language: PCL3 GUI

Print resolution

- For a list of supported print resolutions, visit www.support.hp.com.

Cartridge yield

- Visit www.hp.com/go/learnaboutsupplies for more information on estimated cartridge yields.

Acoustic information

- If you have Internet access, you can access acoustic information from the [HP website](#).

Regulatory notices

The HP DeskJet 1200 series meets product requirements from regulatory agencies in your country/region.

This section contains the following topics:

- [Regulatory model number](#)
- [FCC statement](#)
- [Power cord instructions](#)
- [Notice to users in Korea](#)
- [VCCI \(Class B\) compliance statement for users in Japan](#)
- [Notice to users in Japan about the power cord](#)
- [Visual display workplaces statement for Germany](#)
- [Noise emission statement for Germany](#)
- [European Union Regulatory Notice](#)
- [Declaration of conformity](#)

Regulatory model number

For regulatory identification purposes, your product is assigned with a Regulatory Model Number. The regulatory model number should not be confused with the marketing names or product numbers.

FCC statement

The United States Federal Communications Commission (in 47 CFR 15.105) has specified that the following notice be brought to the attention of users of this product.

This equipment has been tested and found to comply with the limits for a Class B digital device, pursuant to Part 15 of the FCC Rules. These limits are designed to provide reasonable protection against harmful interference in a residential installation. This equipment generates, uses and can radiate radio frequency energy and, if not installed and used in accordance with the instructions, may cause harmful interference to radio communications. However, there is no guarantee that interference will not occur in a particular installation. If this equipment does cause harmful interference to radio or television reception, which can be determined by turning the equipment off and on, the user is encouraged to try to correct the interference by one or more of the following measures:

- Reorient or relocate the receiving antenna.
- Increase the separation between the equipment and the receiver.
- Connect the equipment into an outlet on a circuit different from that to which the receiver is connected.
- Consult the dealer or an experienced radio/TV technician for help.

 **NOTE:** If the product has an Ethernet / LAN port with metallic casing then use of a shielded interface cable is required to comply with the Class B limits of Part 15 of FCC rules.

Modifications (part 15.21)

Any changes or modifications made to this device that are not expressly approved by HP may void the user's authority to operate the equipment.

For further information, contact: Manager of Corporate Product Regulations, HP Inc. 1501 Page Mill Road, Palo Alto, CA 94304, U.S.A.

This device complies with Part 15 of the FCC Rules. Operation is subject to the following two conditions: (1) this device may not cause harmful interference, and (2) this device must accept any interference received, including interference that may cause undesired operation.

Power cord instructions

Make sure your power source is adequate for the product voltage rating. The voltage rating is on the product. The product uses either 100-240 Vac or 200-240 Vac and 50/60 Hz.

⚠ CAUTION: To prevent damage to the product, use only the power cord that is provided with the product.

Notice to users in Korea

해당 무선설비는 운용 중 전파혼신 가능성이 있음으로 인명안전과 관련된 서비스는 할 수 없음.

B급 기기

(가정용 방송통신기자재)

이 기기는 가정용(B급) 전자파적합기기로서 주로 가정에서 사용하는 것을 목적으로 하며, 모든 지역에서 사용할 수 있습니다.

VCCI (Class B) compliance statement for users in Japan

この装置は、クラスB機器です。この装置は、住宅環境で使用することを目的としていますが、この装置がラジオやテレビジョン受信機に近接して使用されると、受信障害を引き起こすことがあります。取扱説明書に従って正しい取り扱いをして下さい。

VCCI-B

Notice to users in Japan about the power cord

製品には、同梱された電源コードをお使い下さい。

同梱された電源コードは、他の製品では使用出来ません。

Visual display workplaces statement for Germany

GS-Erklärung (Deutschland)

Das Gerät ist nicht für die Benutzung im unmittelbaren Gesichtsfeld am Bildschirmarbeitsplatz vorgesehen. Um störende Reflexionen am Bildschirmarbeitsplatz zu vermeiden, darf dieses Produkt nicht im unmittelbaren Gesichtsfeld platziert werden.

Noise emission statement for Germany

Geräuschemission

LpA < 70 dB am Arbeitsplatz im Normalbetrieb nach DIN 45635 T. 19

European Union Regulatory Notice



Products bearing the CE marking comply to applicable EU Directives and related European Harmonised Standards. The full Declaration of Conformity can be found at the following website:

www.hp.eu/certificates (Search with the product model name or its Regulatory Model Number (RMN), which may be found on the regulatory label.)

The point of contact for regulatory matters is HP Deutschland GmbH, HQ-TRE, 71025, Boeblingen, Germany.

Declaration of conformity

Declaration of conformity can be found at www.hp.eu/certificates.

Environmental product stewardship program

HP is committed to providing quality products in an environmentally sound manner. Design for recycling has been incorporated into this product. The number of materials has been kept to a minimum while ensuring proper functionality and reliability. Dissimilar materials have been designed to separate easily. Fasteners and other connections are easy to locate, access, and remove using common tools. High priority parts have been designed to access quickly for efficient disassembly and repair.

For more information, visit HP's Commitment to the Environment Web site at:

www.hp.com/hpinfo/globalcitizenship/environment

- [Eco-Tips](#)
- [European Union Commission Regulation 1275/2008](#)
- [Paper](#)
- [Plastics](#)
- [Material safety data sheets](#)
- [Recycling program](#)
- [HP inkjet supplies recycling program](#)
- [Power consumption](#)
- [Disposal of waste equipment by users](#)
- [Waste disposal for Brazil](#)
- [Chemical substances](#)
- [The Table of Hazardous Substances/Elements and their Content \(China\)](#)
- [Declaration of the Presence Condition of the Restricted Substances Marking \(Taiwan\)](#)
- [Restriction of hazardous substance \(India\)](#)
- [Regulation on the Control of Waste Electrical and Electronic Equipment \(Turkey\)](#)
- [EPEAT](#)
- [SEPA Ecolabel User Information \(China\)](#)
- [California Perchlorate Material Notice](#)
- [China Energy Label for Printer, Fax and Copier](#)

Eco-Tips

HP is committed to helping customers reduce their environmental footprint. Please visit the HP Eco Solutions website for more information on HP's environmental initiatives.

www.hp.com/sustainableimpact

European Union Commission Regulation 1275/2008

For product power data, including the power consumption of the product in networked standby if all wired network ports are connected and all wireless network ports are activated, please refer to section P15 'Additional Information' of the product IT ECO Declaration at www.hp.com/hpinfo/globalcitizenship/environment/productdata/itecodesktop-pc.html.

Paper

This product is suited for the use of recycled paper according to DIN 19309 and EN 12281:2002.

Plastics

Plastic parts over 25 grams are marked according to international standards that enhance the ability to identify plastics for recycling purposes at the end of product life.

Material safety data sheets

Material safety data sheets (MSDS) can be obtained from the HP website at:

www.hp.com/go/msds

Recycling program

HP offers an increasing number of product return and recycling programs in many countries/regions, and partners with some of the largest electronic recycling centers throughout the world. HP conserves resources by reselling some of its most popular products. For more information regarding recycling of HP products, please visit:

www.hp.com/recycle/

HP inkjet supplies recycling program

HP is committed to protecting the environment. The HP Inkjet Supplies Recycling Program is available in many countries/regions, and lets you recycle used print cartridges and ink cartridges free of charge. For more information, go to the following website:

www.hp.com/recycle/

Power consumption

HP printing and imaging equipment marked with the ENERGY STAR® logo is certified by the U.S. Environmental Protection Agency. The following mark will appear on ENERGY STAR certified imaging products:



Additional ENERGY STAR certified imaging product model information is listed at: www.hp.com/go/energystar

Disposal of waste equipment by users



This symbol means do not dispose of your product with your other household waste. Instead, you should protect human health and the environment by handing over your waste equipment to a designated collection point for the recycling of waste electrical and electronic equipment. For more information, please contact your household waste disposal service, or go to <http://www.hp.com/recycle>.

Waste disposal for Brazil



Não descarte o produto eletrônico em lixo comum

Este produto eletrônico e seus componentes não devem ser descartados no lixo comum, pois embora estejam em conformidade com padrões mundiais de restrição a substâncias nocivas, podem conter, ainda que em quantidades mínimas, substâncias impactantes ao meio ambiente. Ao final da vida útil deste produto, o usuário deverá entregá-lo à HP. A não observância dessa orientação sujeitará o infrator às sanções previstas em lei.

Após o uso, as pilhas e/ou baterias dos produtos HP deverão ser entregues ao estabelecimento comercial ou rede de assistência técnica autorizada pela HP.

Para maiores informações, inclusive sobre os pontos de recebimento, acesse:

www.hp.com.br/reciclar

Chemical substances

HP is committed to providing our customers with information about the chemical substances in our products as needed to comply with legal requirements such as REACH (*Regulation EC No 1907/2006 of the European Parliament and the Council*). A chemical information report for this product can be found at: www.hp.com/go/reach.

The Table of Hazardous Substances/Elements and their Content (China)

产品中有有害物质或元素的名称及含量

根据中国《电器电子产品有害物质限制使用管理办法》



部件名称	有害物质					
	铅 (Pb)	汞 (Hg)	镉 (Cd)	六价铬 (Cr(VI))	多溴联苯 (PBB)	多溴二苯醚 (PBDE)
外壳和托盘	○	○	○	○	○	○
电线	○	○	○	○	○	○
印刷电路板	X	○	○	○	○	○
打印系统	X	○	○	○	○	○

部件名称	有害物质					
	铅 (Pb)	汞 (Hg)	镉 (Cd)	六价铬 (Cr(VI))	多溴联苯 (PBB)	多溴二苯醚 (PBDE)
显示器	X	○	○	○	○	○
喷墨打印机墨盒	○	○	○	○	○	○
驱动光盘	X	○	○	○	○	○
扫描仪	X	○	○	○	○	○
网络配件	X	○	○	○	○	○
电池板	X	○	○	○	○	○
自动双面打印系统	○	○	○	○	○	○
外部电源	X	○	○	○	○	○

本表格依据 SJ/T 11364 的规定编制。

○: 表示该有害物质在该部件所有均质材料中的含量均在 GB/T 26572 规定的限量要求以下。

X: 表示该有害物质至少在该部件的某一均质材料中的含量超出 GB/T 26572 规定的限量要求。

此表中所有名称中含“X”的部件均符合中国 RoHS 达标管理目录限用物质应用例外清单的豁免。

此表中所有名称中含“X”的部件均符合欧盟 RoHS 立法。

注: 环保使用期限的参考标识取决于产品正常工作的温度和湿度等条件。

Declaration of the Presence Condition of the Restricted Substances Marking (Taiwan)

台灣 限用物質含有情況標示聲明書

Taiwan Declaration of the Presence Condition of the Restricted Substances Marking

單元 Unit	限用物質及其化學符號					
	Restricted substances and their chemical symbols					
	鉛 (Pb)	汞 (Hg)	鎘 (Cd)	六價鉻 (Cr ⁺⁶)	多溴聯苯 (PBB)	多溴二苯醚 (PBDE)
列印引擎 Print engine	—	○	○	○	○	○
外殼和紙匣 External Casing and Trays	○	○	○	○	○	○
電源供應器 Power Supply	—	○	○	○	○	○
電線 Cables	○	○	○	○	○	○

單元 Unit	限用物質及其化學符號					
	Restricted substances and their chemical symbols					
	鉛 (Pb)	汞 (Hg)	鎘 (Cd)	六價鉻 (Cr ⁶⁺)	多溴聯苯 (PBB)	多溴二苯醚 (PBDE)
印刷電路板 Print printed circuit board	—	○	○	○	○	○
控制面板 Control panel	—	○	○	○	○	○
墨水匣 Cartridge	○	○	○	○	○	○

備考 1. “超出 0.1 wt %” 及 “超出 0.01 wt %” 係指限用物質之百分比含量超出百分比含量基準值。
Note 1: “Exceeding 0.1 wt %” and “exceeding 0.01 wt %” indicate that the percentage content of the restricted substance exceeds the reference percentage value of presence condition.

備考 2. “○” 係指該項限用物質之百分比含量未超出百分比含量基準值。
Note 2: “○” indicates that the percentage content of the restricted substance does not exceed the percentage of reference value of presence.

備考 3. “—” 係指該項限用物質為排除項目。
Note 3: “—” indicates that the restricted substance corresponds to the exemption.

若要存取產品的最新使用指南或手冊，請前往 www.support.hp.com。選取**搜尋您的產品**，然後依照畫面上的指示繼續執行。

To access the latest user guides or manuals for your product, go to www.support.hp.com. Select **Find your product**, and then follow the onscreen instructions.

Restriction of hazardous substance (India)

This product, as well as its related consumables and spares, complies with the reduction in hazardous substances provisions of the "India E-waste (Management and Handling) Rule 2016." It does not contain lead, mercury, hexavalent chromium, polybrominated biphenyls or polybrominated diphenyl ethers in concentrations exceeding 0.1 weight % and 0.01 weight % for cadmium, except for where allowed pursuant to the exemptions set in Schedule 2 of the Rule.

Regulation on the Control of Waste Electrical and Electronic Equipment (Turkey)

Türkiye Cumhuriyeti: AEEE Yönetmeliğine uygundur

EPEAT

Most HP products are designed to meet EPEAT. EPEAT is a comprehensive environmental rating that helps identify greener electronics equipment. For more information on EPEAT go to www.epeat.net. For information on HP's EPEAT registered products go to www.hp.com/hpinfo/globalcitizenship/environment/pdf/epeat_printers.pdf.

SEPA Ecolabel User Information (China)

中国环境标识认证产品用户说明

噪声大于 63.0 dB(A) 的办公设备不宜放置于办公室内，请在独立的隔离区域使用。

如需长时间使用本产品或打印大量文件，请确保在通风良好的房间内使用。

如您需要确认本产品处于零能耗状态，请按电源关闭按钮，并将插头从电源插座断开。

您可以使用再生纸，以减少资源耗费。

California Perchlorate Material Notice

Perchlorate material - special handling may apply. See: www.dtsc.ca.gov/hazardouswaste/perchlorate

This product's real-time clock battery or coin cell battery may contain perchlorate and may require special handling when recycled or disposed of in California.

China Energy Label for Printer, Fax and Copier

复印机、打印机和传真机能源效率标识实施规则

依据“复印机、打印机和传真机能源效率标识实施规则”，该打印机具有中国能效标识。标识上显示的能效等级和操作模式值根据“复印机、打印机和传真机能效限定值及能效等级”标准（“GB 21521”）来确定和计算。

1. 能效等级

产品能效等级分 3 级，其中 1 级能效最高。能效限定值根据产品类型和打印速度由标准确定。能效等级则根据基本功耗水平以及网络接口和内存等附加组件和功能的功率因子之和来计算。

2. 能效信息

喷墨打印机

— 操作模式功率

睡眠状态的能耗按照 GB 21521 的标准来衡量和计算。该数据以瓦特 (W) 表示。

— 待机功率

待机状态是产品连接到电网电源上功率最低的状态。该状态可以延续无限长时间，且使用者无法改变此状态下产品的功率。对于“成像设备”产品，“待机”状态通常相当于“关闭”状态，但也可能相当于“准备”状态或者“睡眠”状态。该数据以瓦特 (W) 表示。

— 睡眠状态预设延迟时间

出厂前由制造商设置的时间决定了该产品在完成主功能后进入低耗模式（例如睡眠、自动关机）的时间。该数据以分钟表示。

— 附加功能功率因子之和

网络接口和内存等附加功能的功率因子之和。该数据以瓦特 (W) 表示。

标识上显示的能耗数据是根据典型配置测量得出的数据，此类配置包含登记备案的打印机依据复印机、打印机和传真机能源效率标识实施规则所选的所有配置。因此，该特定产品型号的实际能耗可能与标识上显示的数据有所不同。

要了解规范的更多详情，请参考最新版的 GB 21521 标准。

Index

C

- carriage
 - clear carriage jams 38
- customer support
 - warranty 49

E

- environment
 - Environmental product stewardship program 57
 - environmental specifications 52

J

- jams
 - clear 36

M

- multi-feeds, troubleshoot 39

O

- On button 3
- operating systems supported 52

P

- paper
 - clear jams 36
 - HP, order 9
 - skewed pages 39
 - troubleshoot feeding 39
- paper-feed problems, troubleshoot 39
- power
 - troubleshoot 47
- print
 - specifications 53
 - troubleshoot 47
- printer software (Windows)
 - opening 10

R

- recycle
 - ink cartridges 58
- regulatory notices 54
 - regulatory model identification number 54

S

- skew, troubleshoot
 - print 39
- specifications
 - system requirements 52
- system requirements 52

T

- technical information
 - environmental specifications 52
 - print specifications 53
- trays
 - clear paper jams 36
 - troubleshoot feeding 39
- troubleshoot
 - multiple pages are picked 39
 - paper not picked up from tray 39
 - paper-feed problems 39
 - power 47
 - print 47
 - skewed pages 39

W

- warranty 49
- Windows
 - system requirements 52

