



# Maintenance and Service Guide

## **SUMMARY**

This guide provides information about spare parts, removal and replacement of parts, security, backing up, and more.

© Copyright 2020 HP Development Company, L.P.

Bluetooth is a trademark owned by its proprietor and used by HP Inc. under license. Chrome is a trademark of Google LLC. Intel, Celeron, Core, Optane, Pentium, Thunderbolt, and vPro are trademarks of Intel Corporation or its subsidiaries in the U.S. and/or other countries. Microsoft and Windows are either registered trademarks or trademarks of Microsoft Corporation in the United States and/or other countries. USB Type-C and USB-C are registered trademarks of USB Implementers Forum. DisplayPort and the DisplayPort logo are trademarks owned by the Video Electronics Standards Association (VESA) in the United States and other countries.

The information contained herein is subject to change without notice. The only warranties for HP products and services are set forth in the express warranty statements accompanying such products and services. Nothing herein should be construed as constituting an additional warranty. HP shall not be liable for technical or editorial errors or omissions contained herein.

First Edition: July 2020

Document Part Number: M05539-001

## Product notice

This guide describes features that are common to most models. Some features may not be available on your computer.

Not all features are available in all editions or versions of Windows. Systems may require upgraded and/or separately purchased hardware, drivers, software or BIOS update to take full advantage of Windows functionality. Windows 10 is automatically updated, which is always enabled. ISP fees may apply and additional requirements may apply over time for updates. Go to <http://www.microsoft.com> for details.

To access the latest user guides, go to <http://www.hp.com/support>, and follow the instructions to find your product. Then select **Manuals**.

## Software terms

By installing, copying, downloading, or otherwise using any software product preinstalled on this computer, you agree to be bound by the terms of the HP End User License Agreement (EULA). If you do not accept these license terms, your sole remedy is to return the entire unused product (hardware and software) within 14 days for a full refund subject to the refund policy of your seller.

For any further information or to request a full refund of the price of the computer, please contact your seller.

Not all features are available in all editions of Windows. This computer may require upgraded and/or separately purchased hardware, drivers and/or software to take full advantage of Windows functionality. Go to <http://www.microsoft.com> for details.

## Safety warning notice

Reduce the possibility of heat-related injuries or of overheating the computer by following the practices described.

---

 **WARNING!** To reduce the possibility of heat-related injuries or of overheating the computer, do not place the computer directly on your lap or obstruct the computer air vents. Use the computer only on a hard, flat surface. Do not allow another hard surface, such as an adjoining optional printer, or a soft surface, such as pillows or rugs or clothing, to block airflow. Also, do not allow the AC adapter to come into contact with the skin or a soft surface, such as pillows or rugs or clothing, during operation. The computer and the AC adapter comply with the user-accessible surface temperature limits defined by applicable safety standards.

---



---

# Table of contents

<b>1 Product features</b>	<b>1</b>
Standard configuration features	1
Front panel components	1
Rear panel components	2
Serial number location	2
<b>2 Illustrated parts catalog</b>	<b>3</b>
Computer major components	3
Mass storage devices	6
Miscellaneous parts	7
<b>3 Routine care, SATA drive guidelines, and disassembly preparation</b>	<b>9</b>
Electrostatic discharge information	9
Generating static electricity	9
Preventing electrostatic damage to equipment	10
Personal grounding methods and equipment	10
Grounding the work area	11
Recommended materials and equipment	11
Operating guidelines	11
Routine care	12
General cleaning safety precautions	12
Cleaning the computer case	12
Cleaning the keyboard	13
Cleaning the monitor	13
Cleaning the mouse	13
Service considerations	13
Tools and software requirements	14
Screws	14
Cables and connectors	14
Hard drives	14
Lithium coin cell battery	15
SATA hard drives	15
Cable management	15
<b>4 Removal and replacement procedures</b>	<b>17</b>
Preparation for disassembly	17

Access panel .....	17
Front bezel .....	18
Memory modules (SODIMMs) .....	19
Fan .....	22
Hard drive and drive cage .....	23
Solid-state drive .....	24
WLAN module .....	25
Battery .....	27
Speaker .....	28
Ambient (thermal) sensor .....	29
Flex I/O connector board #1 .....	30
Flex I/O connector board #2 .....	31
Heat sink .....	31
Processor .....	33
System board .....	34
System board callouts .....	36
Wireless antennas and cables .....	36

**5 Troubleshooting without diagnostics ..... 39**

Before you call for technical support .....	39
Helpful hints .....	40
Solving general problems .....	40
Cannot access the Computer Setup (F10) Utility when booting the computer .....	40
Computer appears locked up and will not turn off when the power button is pressed .....	41
Computer will not respond to keyboard or mouse .....	41
Computer date and time display is incorrect .....	41
There is no sound or sound volume is too low .....	41
Cannot remove computer cover or access panel .....	42
Poor performance .....	42
Computer powered off automatically and the power light blinks red four times and then white two times .....	43
System does not turn on and the lights on the front of the computer are not blinking .....	43
Solving power problems .....	44
Power supply shuts down intermittently .....	44
Computer turned off automatically, power light blinks red two times followed by a two- second pause, and the computer beeps two times (Beeps stop after fifth iteration but lights continue blinking) .....	44
Power light blinks red four times followed by a two-second pause and the computer beeps four times (Beeps stop after fifth iteration but lights continue blinking) .....	44
Solving hard drive problems .....	45
Hard drive error occurs .....	45

Disk transaction problem .....	45
Drive not found (identified) .....	45
Nonsystem disk/NTLDR missing message .....	46
Computer will not boot from hard drive .....	46
Computer seems to be locked up .....	47
Solving audio problems .....	47
Sound cuts in and out .....	47
Sound does not come out of the speaker or headphones .....	47
Computer appears to be locked up while recording audio .....	48
Line-in jack is not functioning properly .....	48
Solving printer problems .....	48
Printer will not print .....	48
Printer will not turn on .....	49
Printer prints garbled information .....	49
Printer will not print .....	49
Solving keyboard and mouse problems .....	49
Keyboard commands and typing are not recognized by the computer .....	49
Mouse does not respond to movement or is too slow .....	50
Solving hardware installation problems .....	50
A new device is not recognized as part of the system .....	51
Computer will not start .....	51
Power light blinks red three times and then white two times .....	51
Solving network problems .....	52
Network driver does not detect network controller .....	52
Network status link light never blinks .....	52
Diagnostics reports a failure .....	53
Diagnostics passes, but the computer does not communicate with the network .....	53
Network controller stopped working when an expansion board was added to the computer .....	53
Network controller stops working without apparent cause .....	53
Cannot connect to network server when attempting remote system installation .....	54
System setup utility reports unprogrammed EEPROM .....	54
Solving memory problems .....	54
System will not boot or does not function properly after installing additional memory modules .....	54
Out of memory error .....	55
Memory count during POST is wrong .....	55
Insufficient memory error during operation. ....	55
Power light blinks red five times followed by a two-second pause and the computer beeps five times (Beeps stop after fifth iteration but lights continue blinking) .....	55
Solving USB flash drive problems .....	56
USB flash drive is not seen as a drive letter in Windows .....	56

USB flash drive not found (identified) .....	56
System will not boot from USB flash drive .....	56
The computer boots to DOS after making a bootable flash drive .....	56
Solving internet access problems .....	57
Unable to connect to the internet .....	57
Cannot automatically launch internet programs .....	57
Solving software problems .....	57
Computer will not start up and the HP logo does not appear .....	58
“Illegal Operation has Occurred” error message is displayed .....	58
<b>6 Computer Setup (F10) Utility .....</b>	<b>59</b>
Using Computer Setup (F10) Utilities .....	59
Computer Setup—Main .....	60
Computer Setup—Security .....	62
Computer Setup—Advanced .....	66
<b>7 POST error messages .....</b>	<b>73</b>
POST numeric codes and text messages .....	73
Interpreting POST diagnostic front panel lights and audible codes .....	77
<b>8 Password security and resetting CMOS .....</b>	<b>79</b>
Changing a setup or power-on password .....	79
Deleting a setup or power-on password .....	79
<b>9 Backing up, restoring, and recovering .....</b>	<b>81</b>
Backing up information and creating recovery media .....	81
Using Windows tools for backing up .....	81
Using the HP Cloud Recovery Download Tool to create recovery media (select products only) .....	81
Restoring and recovering your system .....	81
Creating a system restore .....	82
Restoring and recovery methods .....	82
Recovering using HP Recovery media .....	82
Changing the computer boot order .....	82
Using HP Sure Recover (select products only) .....	83
<b>10 Using HP PC Hardware Diagnostics .....</b>	<b>85</b>
Downloading the HP PC Hardware Diagnostics Windows from the Microsoft Store .....	85
Customizing Remote HP PC Hardware Diagnostics UEFI settings .....	85



<b>11 Statement of memory volatility .....</b>	<b>87</b>
Current BIOS steps .....	87
Nonvolatile memory usage .....	89
Questions and answers .....	91
Using HP Sure Start (select products only) .....	92
<b>12 Power cord set requirements .....</b>	<b>93</b>
General requirements .....	93
Japanese power cord requirements .....	93
Country-specific requirements .....	93
<b>13 Specifications .....</b>	<b>95</b>
<b>Index .....</b>	<b>97</b>



# 1 Product features

This chapter provides you with an overview of your computer's features.

## Standard configuration features

To identify a typical computer configuration, read this section. Features vary depending on the model. For support assistance and to learn more about the hardware and software installed on your computer model, run the HP Support Assistant utility.







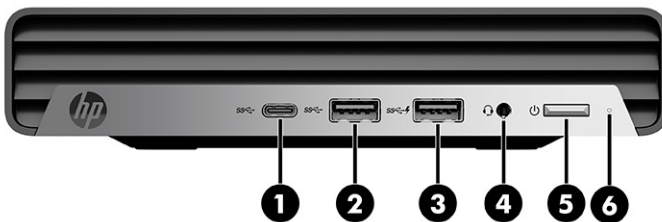

## Front panel components

To identify the front panel components, use this illustration and table.



**Table 1-1** Identifying the front panel components

Front panel components					
1		USB Type-C® SuperSpeed Plus port with HP Sleep and Charge	4		Audio-out (headphone)/Audio-in (microphone) combo jack
2		USB Type-A SuperSpeed port	5		Power button
3		USB port with HP Sleep and Charge	6		Drive light



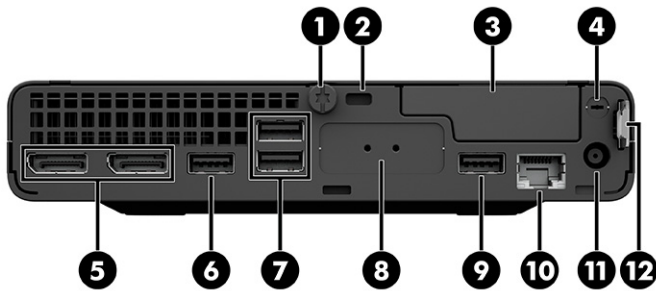

**NOTE:** The combo jack supports headphones, line output devices, microphones, line input devices, or CTIA-style headsets.

## Rear panel components

To identify the rear panel components, use this illustration and table.



**Table 1-2 Identifying the rear panel components**

Rear panel components			
1	Thumbscrew	7	 USB Type-A ports (bottom port is SuperSpeed)
2	Security cable slot	8	Optional port
3	Optional port	9	 USB Type-A SuperSpeed port
4	External antenna	10	 RJ-45 (network) jack
5	 DisplayPort™ connectors (2)	11	Power connector
6	 USB Type-A SuperSpeed port	12	Padlock loop

**NOTE:** Your model might have additional ports available from HP.

## Serial number location

Each computer has a unique serial number and a product ID number that are located on the exterior of the computer. Keep these numbers available when contacting customer service for assistance.



## 2 Illustrated parts catalog

Use this information to determine the spare parts that are available for the computer.

 **NOTE:** HP continually improves and changes product parts. For complete and current information about supported parts for your computer, go to <http://partsurfer.hp.com>, select your country or region, and then follow the on-screen instructions.

### Computer major components

To identify the computer major components, use this illustration and table.

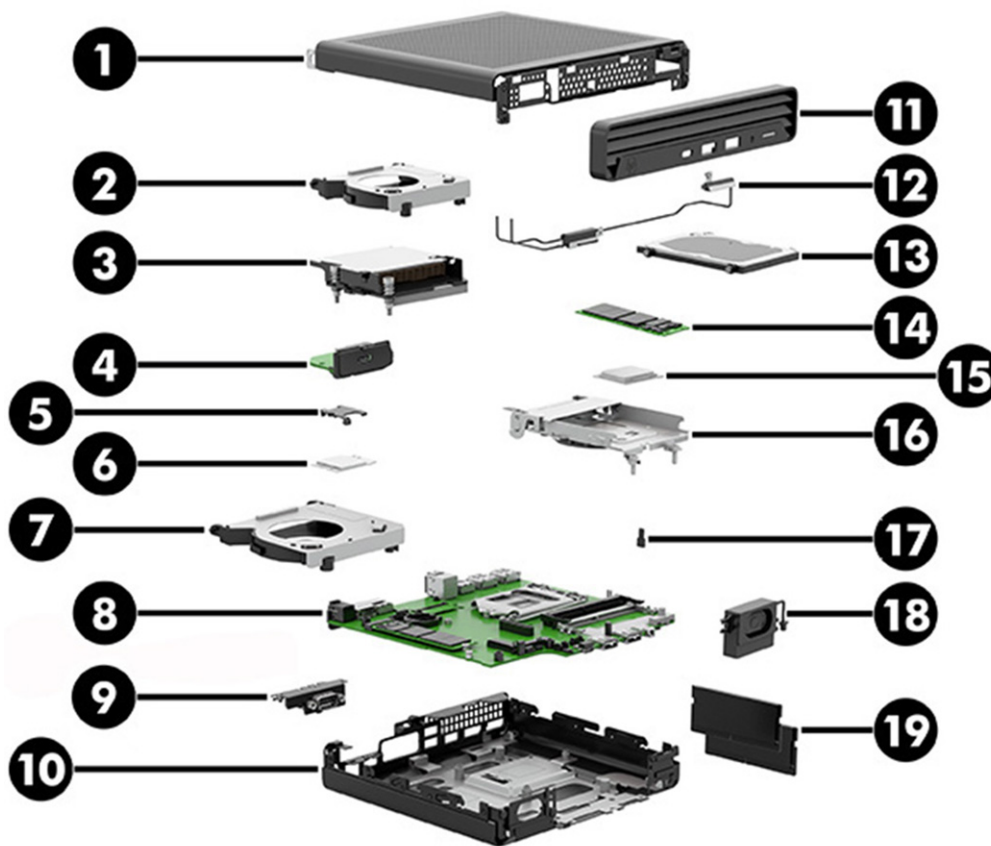

**Table 2-1 Computer major components and their descriptions**

Item	Description
(1)	Access panel
(2)	System fan
(3)	Heat sink
	For use in 65 W models
	For use in 35 W models

**Table 2-1 Computer major components and their descriptions (continued)**

<b>Item</b>	<b>Description</b>
<b>(4)</b>	<b>Flex I/O connector board #1</b>
	DisplayPort 1.2
	DisplayPort
	VGA
	USB 3.1 Gen 2 Type-C, alt DisplayPort, PD 100 W-in
<b>(5)</b>	<b>Hard drive connector</b>
<b>(6)</b>	<b>WLAN module</b>
	Intel® Wi-Fi 6 AX201 (2 × 2) and Bluetooth® M.2 Combo Card, non-vPro™
	Intel Wi-Fi 6 AX201 (2 × 2) and Bluetooth M.2 Combo Card, vPro™
	Realtek RTL8822CE Wi-Fi 5 (2 × 2) and Bluetooth M.2 Combo Card
	Realtek RTL8821CE Wi-Fi 5 (1 × 1) and Bluetooth M.2 Combo Card
<b>(7)</b>	<b>Hard drive fan</b>
<b>(8)</b>	<b>System board</b> (includes replacement thermal material)
<b>(9)</b>	<b>Flex I/O connector board #2</b>
	Serial port
	(2) USB 2.0
<b>(10)</b>	<b>System chassis</b>
<b>(11)</b>	<b>Front bezel</b>
<b>(12)</b>	<b>Wireless antennas</b>
<b>(13)</b>	<b>Hard drive</b>
	2 TB, 5400 rpm
	1 TB, 7200 rpm
	1 TB, 5400 rpm
	500 GB, 7200 rpm
	500 GB, 7200 rpm, self-encrypting drive (SED)
	500 GB, 7200 rpm, FIPS
	<b>Hard drive cable</b> (not illustrated)
<b>(14)</b>	<b>Solid-state drive</b> (M.2 2280, PCIe)
	2 TB, TLC
	1 TB, TLC
	512 GB, TLC
	512 GB, TLC, self-encrypting drive (SED)
	512 GB, value

**Table 2-1 Computer major components and their descriptions (continued)**

<b>Item</b>	<b>Description</b>
	512 GB + 32 GB Optane® memory
	256 GB, TLC
	256 GB, TLC, self-encrypting drive (SED)
	256 GB, value
	256 GB + 16 GB Optane memory
	128 GB, TLC
	16 GB Optane memory module
<b>(15)</b>	<b>Processor</b> (includes replacement thermal material)
	Intel Core® i7-10700 (2.9 GHz, 16 MB Intel Smart Cache, 8 core, 65 W)
	Intel Core i7-10700T (2.0 GHz, 16 MB Intel Smart Cache, 8 core, 35 W)
	Intel Core i5-10600 (3.3 GHz, 12 MB Intel Smart Cache, 6 core, 65 W)
	Intel Core i5-10600T (2.4 GHz, 12 MB Intel Smart Cache, 6 core, 35 W)
	Intel Core i5-10500 (3.1 GHz, 12 MB Intel Smart Cache, 6 core, 65 W)
	Intel Core i5-10500T (2.3 GHz, 12 MB Intel Smart Cache, 6 core, 35 W)
	Intel Core i5-10400 (2.9 GHz, 12 MB Intel Smart Cache, 6 core, 65 W)
	Intel Core i5-10400T (2.0 GHz, 12 MB Intel Smart Cache, 6 core, 35 W)
	Intel Core i3-10320 (3.8 GHz, 8 MB Intel Smart Cache, 4 core, 65 W)
	Intel Core i3-10300 (3.7 GHz, 8 MB Intel Smart Cache, 4 core, 65 W)
	Intel Core i3-10300T (3.0 GHz, 8 MB Intel Smart Cache, 4 core, 35 W)
	Intel Core i3-10100 (3.6 GHz, 6 MB Intel Smart Cache, 4 core, 65 W)
	Intel Core i3-10100T (3.0 GHz, 6 MB Intel Smart Cache, 4 core, 35 W)
	Intel Pentium® Gold G6600 (4.2 GHz, 4 MB Intel Smart Cache, 2 core, 58 W)
	Intel Pentium Gold G6500 (4.1 GHz, 4 MB Intel Smart Cache, 2 core, 58 W)
	Intel Pentium Gold G6500T (3.5 GHz, 4 MB Intel Smart Cache, 2 core, 35 W)
	Intel Pentium Gold G6400 (4.0 GHz, 4 MB Intel Smart Cache, 2 core, 58 W)
	Intel Pentium Gold G6400T (3.4 GHz, 4 MB Intel Smart Cache, 2 core, 35 W)
	Intel Celeron® G5920 (3.5 GHz, 2 MB Intel Smart Cache, 2 core, 58 W)
	Intel Celeron G5900 (3.4 GHz, 2 MB Intel Smart Cache, 2 core, 58 W)
	Intel Celeron G5900T (3.2 GHz, 2 MB Intel Smart Cache, 2 core, 35 W)
<b>(16)</b>	<b>Hard drive cage</b>
<b>(17)</b>	<b>Ambient (thermal) sensor</b>
<b>(18)</b>	<b>Speaker</b>
<b>(19)</b>	<b>Memory modules (PC4-2666)</b>

**Table 2-1 Computer major components and their descriptions (continued)**

Item	Description
	32 GB
	16 GB
	8 GB
	4 GB
	<b>Memory modules (PC4-3200)</b>
	16 GB

## Mass storage devices

To identify the available hard drives and solid-state drives, use this table.

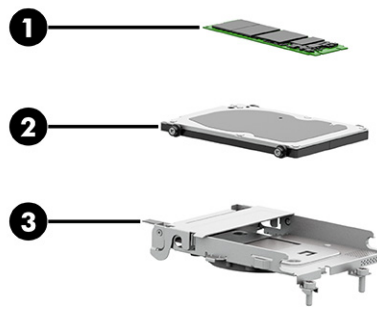

**Table 2-2 Mass storage devices and their descriptions**

Item	Description
<b>(1)</b>	<b>Solid-state drive (M.2 2280, PCIe)</b>
	2 TB, TLC
	1 TB, TLC
	512 GB, TLC
	512 GB, TLC, self-encrypting drive (SED)
	512 GB, value
	512 GB + 32 GB Optane memory
	256 GB, TLC
	256 GB, TLC, self-encrypting drive (SED)
	256 GB, value
	256 GB + 16 GB Optane memory
	128 GB, TLC
	16 GB Optane memory module
<b>(2)</b>	<b>Hard drive</b>



**Table 2-2 Mass storage devices and their descriptions (continued)**

Item	Description
	2 TB, 5400 rpm
	1 TB, 7200 rpm
	1 TB, 5400 rpm
	500 GB, 7200 rpm
	500 GB, 7200 rpm, self-encrypting drive (SED)
	500 GB, 7200 rpm, FIPS
<b>(3)</b>	<b>Hard drive cage</b>

## Miscellaneous parts

To identify the various computer parts, use this table.

**Table 2-3 Miscellaneous parts and their descriptions**

Description
<b>B300 PC Mounting Bracket</b>
<b>Port cover</b>
<b>Screw Kit</b>
<b>Adapter</b>
DisplayPort-to-VGA
DisplayPort-to-DVI
DisplayPort-to-HDMI 2.0
DisplayPort-to-DisplayPort 1.2
USB-to-serial
<b>Cable</b>
USB Type-A to USB Type-B sleeve
USB Type-A to USB Type-B sleeve (short)
<b>Sleeve</b>
I/O
Optical drive
HP Speaker Phone Security Sleeve
Dual VESA sleeve
<b>Quick Release 2 docking base</b>
<b>Mouse</b>
USB, laser
USB, optical

**Table 2-3 Miscellaneous parts and their descriptions (continued)**

<b>Description</b>
USB/PS2, washable
USB, antimicrobial
USB, hardened
USB, premium
USB, fingerprint
USB
<b>Keyboard</b>
USB
Wireless + cable adapter + mouse
USB/PS2, washable
USB, unbranded
USB, smartcard
USB, antimicrobial
USB, premium
Wireless, premium, keyboard and mouse
<b>Power cord (C5)</b>
<b>AC adapter (7.4 mm, SC)</b>
90 W, PFC
65 W, nPFC
65 W, nPFC, EM

# 3 Routine care, SATA drive guidelines, and disassembly preparation

This information provides general service information for the computer. Adherence to the procedures and precautions is essential for proper service.

 **IMPORTANT:** When the computer is plugged into an AC power source, voltage is always applied to the system board. You must disconnect the power cord from the power source before opening the computer to prevent system board or component damage.

## Electrostatic discharge information

A sudden discharge of static electricity from your finger or other conductor can destroy static-sensitive devices or microcircuitry. Often the spark is neither felt nor heard, but damage occurs.

An electronic device exposed to electrostatic discharge (ESD) might not appear to be affected at all and can work perfectly throughout a normal cycle. The device might function normally for a while, but it has been degraded in the internal layers, reducing its life expectancy.

Networks built into many integrated circuits provide some protection, but in many cases, the discharge contains enough power to alter device parameters or melt silicon junctions.

 **IMPORTANT:** To prevent damage to the device when you are removing or installing internal components, observe these precautions:

Keep components in their electrostatic-safe containers until you are ready to install them.

Before touching an electronic component, discharge static electricity by using the guidelines described in this section.

Avoid touching pins, leads, and circuitry. Handle electronic components as little as possible.

If you remove a component, place it in an electrostatic-safe container.

## Generating static electricity

This table shows how humidity affects the electrostatic voltage levels generated by different activities. A product can be degraded by 700 V.

- Different activities generate different amounts of static electricity.
- Static electricity increases as humidity decreases.

**Table 3-1 Static electricity occurrence based on activity and humidity**

Event	Relative humidity		
	55%	40%	10%
Walking across carpet	7,500 V	15,000 V	35,000 V
Walking across vinyl floor	3,000 V	5,000 V	12,000 V
Motions of bench worker	400 V	800 V	6,000 V

**Table 3-1 Static electricity occurrence based on activity and humidity (continued)**

	Relative humidity		
	400 V	700 V	2,000 V
Removing DIPs (dual in-line packages) from plastic tube	400 V	700 V	2,000 V
Removing DIPs from vinyl tray	2,000 V	4,000 V	11,500 V
Removing DIPs from polystyrene foam	3,500 V	5,000 V	14,500 V
Removing bubble pack from PCB (printed circuit board)	7,000 V	20,000 V	26,500 V
Packing PCBs in foam-lined box	5,000 V	11,000 V	21,000 V

Multiple electric components can be packaged together in plastic tubes, trays, or polystyrene foam.

## Preventing electrostatic damage to equipment

Many electronic components are sensitive to ESD. Circuitry design and structure determine the degree of sensitivity. The following packaging and grounding precautions are necessary to prevent static electricity damage to electronic components.

- To avoid hand contact, transport products in static-safe containers such as tubes, bags, or boxes.
- Protect all electrostatic parts and assemblies with conductive or approved containers or packaging.
- Keep electrostatic-sensitive parts in their containers until they arrive at static-free stations.
- Place items on a grounded surface before removing them from their container.
- Always be properly grounded when touching a sensitive component or assembly.
- Avoid contact with pins, leads, or circuitry.
- Place reusable electrostatic-sensitive parts from assemblies in protective packaging or conductive foam.

## Personal grounding methods and equipment

Use this equipment to prevent static electricity damage to electronic components.

- **Wrist straps** are flexible straps with a maximum of  $1\text{ M}\Omega \pm 10\%$  resistance in the ground cords. To provide proper ground, a strap must be worn snug against bare skin. The ground cord must be connected and fit snugly into the banana plug connector on the grounding mat or workstation.
- **Heel straps/Toe straps/Boot straps** can be used at standing workstations and are compatible with most types of shoes or boots. On conductive floors or dissipative floor mats, use them on both feet with a maximum of  $1\text{ M}\Omega \pm 10\%$  resistance between the operator and ground.

**Table 3-2 Static shielding protection levels**

Static shielding protection levels	
Method	Voltage
Antistatic plastic	1,500
Carbon-loaded plastic	7,500
Metallized laminate	15,000

## Grounding the work area

To prevent static damage at the work area, use these precautions.

- Cover the work surface with approved static-dissipative material. Provide a wrist strap connected to the work surface and properly grounded tools and equipment.
- Use static-dissipative mats, foot straps, or air ionizers to give added protection.
- Handle electrostatic sensitive components, parts, and assemblies by the case or PCB laminate. Handle them only at static-free work areas.
- Turn off power and input signals before inserting and removing connectors or test equipment.
- Use fixtures made of static-safe materials when fixtures must directly contact dissipative surfaces.
- Keep work area free of nonconductive materials such as ordinary plastic assembly aids and polystyrene foam.
- Use field service tools, such as cutters, screwdrivers, and vacuums, that are conductive.

## Recommended materials and equipment

HP recommends the these materials and equipment to prevent static electricity.

- Antistatic tape
- Antistatic smocks, aprons, or sleeve protectors
- Conductive bins and other assembly or soldering aids
- Conductive foam
- Conductive tabletop workstations with ground cord of  $1\text{ M}\Omega \pm 10\%$  resistance
- Static-dissipative table or floor mats with hard tie to ground
- Field service kits
- Static awareness labels
- Wrist straps and footwear straps providing  $1\text{ M}\Omega \pm 10\%$  resistance
- Material handling packages
- Conductive plastic bags
- Conductive plastic tubes
- Conductive tote boxes
- Opaque shielding bags
- Transparent metallized shielding bags
- Transparent shielding tubes

## Operating guidelines

This information details how to prevent overheating and to help prolong the life of the computer.

- Keep the computer away from excessive moisture, direct sunlight, and extremes of heat and cold.
- Operate the computer on a sturdy, level surface. Leave a 10.2 cm (4 inch) clearance on all vented sides of the computer and above the monitor to permit the required airflow.
- Never restrict the airflow into the computer by blocking any vents or air intakes. Do not place the keyboard, with the keyboard feet down, directly against the front of the desktop unit as this also restricts airflow.
- Occasionally clean the air vents on all vented sides of the computer. Lint, dust, and other foreign matter can block the vents and limit the airflow. Be sure to unplug the computer before cleaning the air vents.
- Never operate the computer with the cover or side panel removed.
- Do not stack computers on top of each other or place computers so near each other that they are subject to each other's recirculated or preheated air.
- If the computer is to be operated within a separate enclosure, intake and exhaust ventilation must be provided on the enclosure, and the same operating guidelines listed previously still apply.
- Keep liquids away from the computer and keyboard.
- Never cover the ventilation slots on the monitor with any type of material.
- Install or enable power management functions of the operating system or other software, including Sleep states.

## Routine care

Use this information to properly care for your computer.

### General cleaning safety precautions

Use this information to safely clean your computer.

1. Never use solvents or flammable solutions to clean the computer.
2. Never immerse any parts in water or cleaning solutions; apply any liquids to a clean cloth and then use the cloth on the component.
3. Always unplug the computer when cleaning with liquids or damp cloths.
4. Always unplug the computer before cleaning the keyboard, mouse, or air vents.
5. Disconnect the keyboard before cleaning it.
6. Wear safety glasses equipped with side shields when cleaning the keyboard.

### Cleaning the computer case

Follow all safety precautions before cleaning the computer case.

To clean the computer case, follow these procedures:

- To remove light stains or dirt, use plain water with a clean, lint-free cloth or swab.
- For stronger stains, use a mild dishwashing liquid diluted with water. Rinse well by wiping it with a cloth or swab dampened with clear water.
- For stubborn stains, use isopropyl (rubbing) alcohol. No rinsing is needed because the alcohol evaporates quickly and does not leave a residue.

- After cleaning, always wipe the unit with a clean, lint-free cloth.
- Occasionally clean the air vents on the computer. Lint and other foreign matter can block the vents and limit the airflow.

## Cleaning the keyboard

Use this information to properly clean the keyboard. Follow all safety precautions before cleaning the keyboard.

To clean the tops of the keys or the keyboard body, follow the procedures described in [Cleaning the computer case on page 12](#).

When cleaning debris from under the keys, review all rules in [General cleaning safety precautions on page 12](#) before following these procedures.

---

 **CAUTION:** Use safety glasses equipped with side shields before attempting to clean debris from under the keys.

---

- You can remove visible debris underneath or between the keys by vacuuming or shaking.
- You can use canned, pressurized air to clean debris from under the keys. Use caution because too much air pressure can dislodge lubricants applied under the wide keys.
- If you remove a key, use a specially designed key puller to prevent damage to the keys. This tool is available through many electronic supply outlets.

---

 **IMPORTANT:** Never remove a wide leveled key (like the space bar) from the keyboard. If these keys are improperly removed or installed, the keyboard might not function properly.

---

- You can clean under a key with a swab moistened with isopropyl alcohol and squeezed out. Be careful not to wipe away lubricants necessary for proper key functions. Use tweezers to remove any fibers or dirt in confined areas. Allow the parts to air dry before reassembly.

## Cleaning the monitor

Use this information to properly clean the monitor.

- Wipe the monitor screen with a clean cloth moistened with water or with a towelette designed for cleaning monitors. Do not use sprays or aerosols directly on the screen; the liquid can seep into the housing and damage a component. Never use solvents or flammable liquids on the monitor.
- To clean the monitor body, follow the procedures in [Cleaning the computer case on page 12](#).

## Cleaning the mouse

Use this information to properly clean the mouse.

Before cleaning the mouse, be sure that the power to the computer is turned off.

- Clean the mouse ball by first removing the retaining plate and the ball from the housing. Pull out any debris from the ball socket and wipe the ball with a clean, dry cloth before reassembly.
- To clean the mouse body, follow the procedures in [Cleaning the computer case on page 12](#).

## Service considerations

Keep these considerations in mind during the disassembly and assembly of the computer.

## Tools and software requirements

Servicing the computer requires these tools.

- Torx T-15 screwdriver
- Flat-bladed screwdriver (can sometimes be used in place of the Torx screwdriver)
- Phillips P1 screwdriver
- Nonconductive, nonmarking pry tool
- Diagnostics software

## Screws

The screws used in the computer are not interchangeable. They could have standard or metric threads and might be of different lengths.

If you use an incorrect screw during the reassembly process, it can damage the unit. HP strongly recommends that you keep all screws that you remove during disassembly with the removed part and then return them to their proper locations.



---

**IMPORTANT:** As you remove each subassembly from the computer, place it away from the work area to prevent damage.

---

## Cables and connectors

Use this information properly handle cables.

Apply only the tension required to seat or unseat the cables during insertion or removal from the connector. Handle cables by the connector whenever possible. In all cases, avoid bending or twisting the cables, and route the cables so that they cannot be caught or snagged by parts being removed or replaced.



---

**IMPORTANT:** When servicing this computer, be sure to place cables in their proper location during the reassembly process. Improper cable placement can damage the computer.

---

## Hard drives

Handle hard drives as delicate, precision components, avoiding all physical shock and vibration. This advice applies to failed drives as well as replacement spares.

- If a drive must be mailed, place the drive in a bubble-pack mailer or other suitable protective packaging and label the package “Fragile: Handle With Care.”
- Do not remove hard drives from the shipping package for storage. Keep hard drives in their protective packaging until they are actually mounted in the computer.
- Avoid dropping drives from any height onto any surface.
- If you are inserting or removing a hard drive, turn off the computer. Do not remove a hard drive while the computer is on or in standby mode.
- Before handling a drive, ensure that you are discharged of static electricity. While handling a drive, avoid touching the connector.
- Do not use excessive force when inserting a drive.
- Avoid exposing a hard drive to liquids, temperature extremes, or products that have magnetic fields such as monitors or speakers.



## Lithium coin cell battery

The battery that comes with the computer provides power to the real-time clock and has a minimum lifetime of approximately three years.

See the appropriate removal and replacement chapter for the chassis that you are working on for instructions on the replacement procedures.

**⚠ WARNING!** This computer contains a lithium battery. There is a risk of fire and chemical burn if the battery is handled improperly. Do not disassemble, crush, puncture, short external contacts, dispose of in water or fire, or expose it to temperatures higher than 140°F (60°C). Do not attempt to recharge the battery.

**📄 NOTE:** Do not dispose of batteries, battery packs, and accumulators with general household waste. To forward them to recycling centers or proper disposal, use the public collection system or return them to HP, their authorized partners, or their agents.

## SATA hard drives

The Self Monitoring Analysis and Recording Technology (SMART) ATA drives for the HP Personal Computers have built-in drive failure prediction that warns the user or network administrator of an impending failure or crash of the hard drive.

The SMART drive tracks fault prediction and failure indication parameters such as reallocated sector count, spin retry count, and calibration retry count. If the drive determines that a failure is imminent, it generates a fault alert.

**Table 3-3 SATA hard drive characteristics**

Serial ATA hard drive characteristics	
Number of pins/conductors in data cable	7/7
Number of pins in power cable	15
Maximum data cable length	100 cm (39.37 in)
Data interface voltage differential	400 mV–700 mV
Drive voltages	3.3 V, 5 V, 12 V
Jumpers for configuring drive	N/A
Data transfer rate	6.0 Gbps

Always use an HP-approved SATA 6.0 Gbps cable because it is fully backwards compatible with the SATA 1.5 Gbps drives. Current HP desktop products ship with SATA 6.0 Gbps hard drives.

SATA data cables are susceptible to damage if overflexed. Never crease a SATA data cable and never bend it tighter than a 30 mm (1.18 in) radius.

The SATA data cable is a thin, seven-pin cable designed to transmit data for only a single drive.

## Cable management

Always follow good cable management practices when working inside the computer.

- Keep cables away from major heat sources like the heat sink.
- Keep cables clear of sliding or moveable parts to prevent them from being cut or crimped when the parts are moved.
- When folding a flat ribbon cable, never fold to a sharp crease. Sharp creases can damage the wires.
- Do not bend any cable sharply. A sharp bend can break the internal wires.
- Never bend a SATA data cable tighter than a 30 mm (1.18 in) radius.
- Never crease a SATA data cable.

---

## 4 Removal and replacement procedures

Adherence to these procedures and precautions is essential for proper service. After completing all necessary removal and replacement procedures, run the Diagnostics utility to verify that all components operate properly.

---

 **NOTE:** Not all features listed in this guide are available on all computers.

 **NOTE:** HP continually improves and changes product parts. For complete and current information about supported parts for your computer, go to <http://partsurfer.hp.com>, select your country or region, and then follow the on-screen instructions.

---

### Preparation for disassembly

Use this information to properly prepare to disassemble and reassemble the computer.

See [Routine care, SATA drive guidelines, and disassembly preparation on page 9](#) for initial safety procedures.

1. Turn off the computer. If you are unsure whether the computer is off or in Hibernation, turn the computer on, and then shut it down through the operating system.

---

 **IMPORTANT:** Turn off the computer before disconnecting any cables.

Regardless of the power state, voltage is always present on the system board as long as the system is plugged into an active AC outlet. In some systems, the cooling fan is on even when the computer is in the Standby or Suspend modes. Always disconnect the power cord before servicing a unit.

---

2. Disconnect the power from the computer by unplugging the power cord from the computer.
3. Disconnect all external devices from the computer
4. If the computer is on a stand, remove the computer from the stand.

---

 **CAUTION:** Beware of sharp edges inside the chassis.

 **NOTE:** During disassembly, label each cable as you remove it, and note its position and routing. Keep all screws with the removed components.

---

### Access panel

To remove the access panel, use these procedures.

Before removing the access panel, follow these steps:

- ▲ Prepare the computer for disassembly ([Preparation for disassembly on page 17](#)).

Remove the access panel:

- ▲ Loosen the thumbscrew on the rear of the computer **(1)**, slide the panel forward, and lift it off the computer **(2)**.

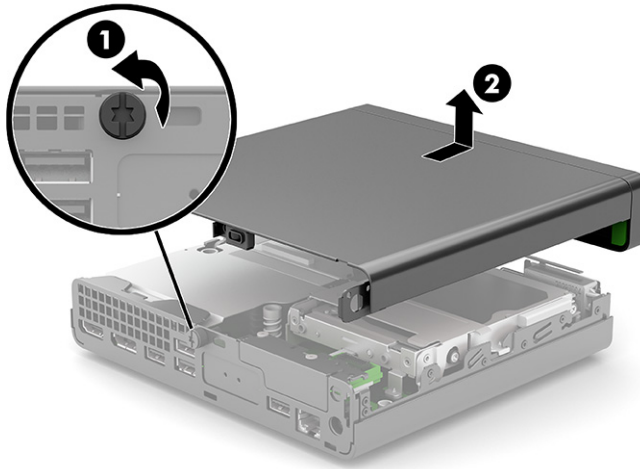

To install the access panel, reverse the removal procedure.

## Front bezel

To remove the front bezel, use these procedures.

Before removing the front bezel, follow these steps:

1. Prepare the computer for disassembly ([Preparation for disassembly on page 17](#)).
2. Remove the access panel ([Access panel on page 17](#)).

Remove the front bezel:

1. Position the access panel upside-down so that you can access the inside of the bezel.
2. Remove the two Phillips screws (1) that secure the bezel to the access panel.
3. Simultaneously press the two top tabs (not the four bottom tabs) to disengage the bezel (2).
4. Rotate the top of the bezel downward (3), and then remove it from the access panel (4).

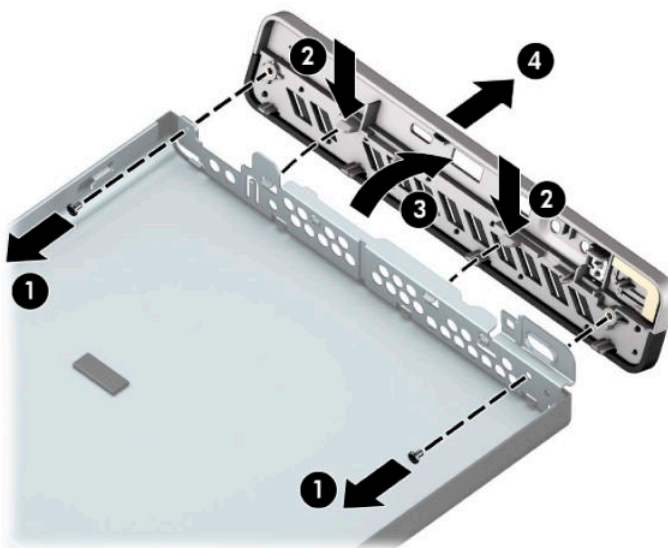

To install the front bezel, reverse the removal procedure.

## Memory modules (SODIMMs)

To remove the memory modules, use this information and procedures.

**Table 4-1 Memory module descriptions**

Description
<b>Memory modules (PC4-2666)</b>
32 GB
16 GB
8 GB
4 GB
<b>Memory modules (PC4-3200)</b>

The memory sockets on the system board can be populated with up to two industry-standard SODIMMs. These memory sockets are populated with at least one preinstalled SODIMM. To achieve the maximum memory support, you can populate the system board with up to 64 GB of memory.

**Table 4-2 Memory module specifications**

Component	Specification
Memory modules	1.2 volt DDR4-SDRAM memory modules
Compliance	Unbuffered non-ECC PC4-17000 DDR4-2666 MHz-compliant
Pins	Industry-standard 260-pin containing the mandatory Joint Electronic Device Engineering Council (JEDEC) specification
Support	CAS latency 17 DDR4 2400 MHz (17-17-17 timing)
Slots	2
Maximum memory	64 GB
Supported	2 Gbit, 4 Gbit, 8 Gbit, and 16 Gbit non-ECC memory technologies single-sided and double-sided memory modules

**NOTE:** The system does not operate properly if you install unsupported memory modules. Memory modules constructed with ×8 and ×16 DDR devices are supported; memory modules constructed with ×4 SDRAM are not supported.

Use this information to correctly populate SODIMM sockets:

There are two SODIMM sockets on the system board, with one socket per channel. The sockets are labeled DIMM1 and DIMM3. The DIMM1 socket operates in memory channel B. The DIMM3 socket operates in memory channel A.

The computer comes with double data rate 3 synchronous dynamic random access memory (DDR4-SDRAM) small outline dual inline memory modules (SODIMMs).

 **IMPORTANT:** You must disconnect the power cord and wait approximately 30 seconds for the power to drain before adding or removing memory modules. Regardless of the power state, voltage is always supplied to the memory modules as long as the computer is plugged into an active AC outlet. Adding or removing memory modules while voltage is present can cause irreparable damage to the memory modules or system board.

**IMPORTANT:** When handling a memory module, be careful not to touch any of the contacts. Doing so can damage the module.

The memory module sockets have gold-plated metal contacts. When upgrading the memory, use memory modules with gold-plated metal contacts to prevent corrosion, oxidation, or both, resulting from having incompatible metals in contact with each other.

Static electricity can damage the electronic components of the computer or optional cards. Before beginning these procedures, be sure that you are discharged of static electricity by briefly touching a grounded metal object.

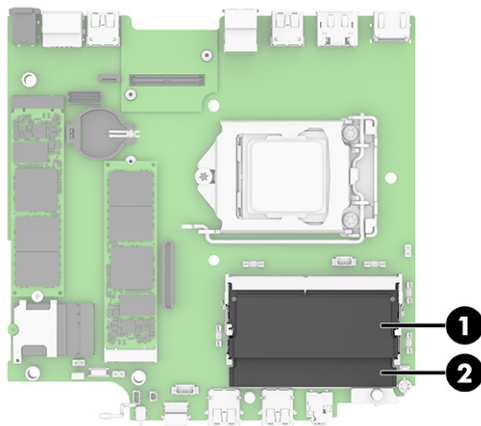

**Table 4-3** Memory module socket locations

Item	Description	System Board Label	Socket Color
1	SODIMM1 socket, channel B	DIMM1	Black
2	SODIMM3 socket, channel A	DIMM3	Black

The system automatically operates in single-channel mode, dual-channel mode, or flex mode, depending on how the SODIMMs are installed.

- The system operates in single-channel mode if the SODIMM sockets are populated in one channel only.
- The system operates in a higher-performing dual-channel mode if the memory capacity of the SODIMM in channel A is equal to the memory capacity of the SODIMM in channel B.
- The system operates in flex mode if the memory capacity of the SODIMM in channel A is not equal to the memory capacity of the SODIMM in channel B. In flex mode, the channel populated with the least amount of memory describes the total amount of memory assigned to dual channel and the remainder is assigned to single channel. If one channel has more memory than the other, assign the larger amount to channel A.
- In any mode, the maximum operational speed is determined by the slowest SODIMM in the system.

Before replacing the memory modules, follow these steps:

1. Prepare the computer for disassembly ([Preparation for disassembly on page 17](#)).
2. Remove the access panel ([Access panel on page 17](#)).

Replace a memory module:

1. Tilt the fan up using the front tab and leave it in the up position.

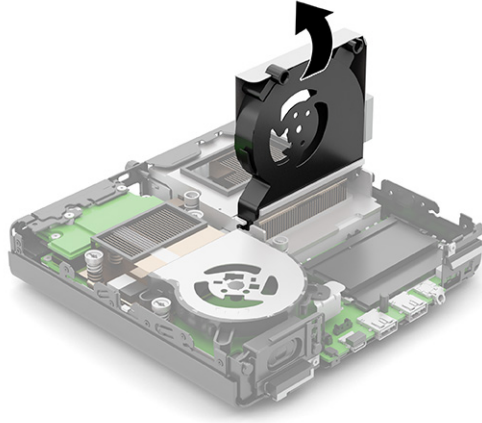

2. To remove a SODIMM, press outward on the two latches on each side of the SODIMM **(1)**, and then pull the SODIMM out of the socket **(2)**.

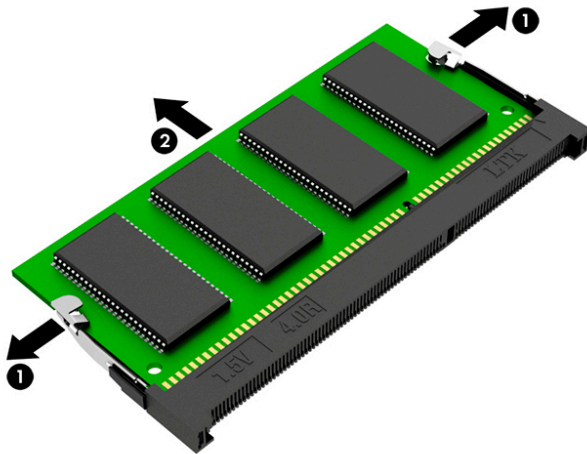

3. Slide the new SODIMM into the socket at approximately a 30° angle **(1)**, and then press the SODIMM down **(2)** so that the latches lock it in place.

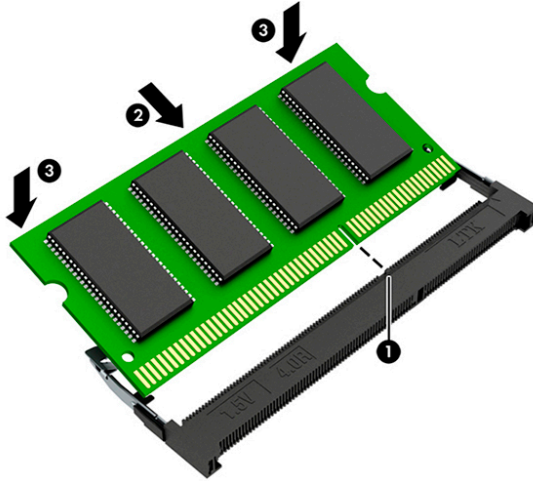

 **NOTE:** A memory module can be installed in only one way. Match the notch on the module with the tab on the memory socket.

The computer automatically recognizes the additional memory when you turn on the computer.

## Fan

To remove the fan, use these procedures.

Before removing the fan, follow these steps:

1. Prepare the computer for disassembly ([Preparation for disassembly on page 17](#)).
2. Remove the access panel ([Access panel on page 17](#)).

Remove the fan:

1. Disconnect the fan cable from the system board connector **(1)**.
2. Remove the cable from its routing around the heat sink screw post **(2)**.
3. Lift fan up to about 45° **(3)**, and then pull it away from the heat sink **(4)**.

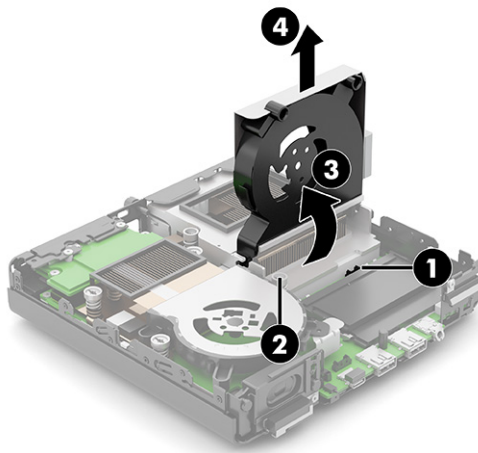



To install the fan, reverse the removal procedure.

## Hard drive and drive cage

To remove the hard drive and drive cage, use these procedures.

**Table 4-4** Hard drive descriptions

Description
<b>Hard drives, 2.5 inch</b>
2 TB, 5400 rpm
1 TB, 7200 rpm
1 TB, 5400 rpm
500 GB, 7200 rpm
500 GB, 7200 rpm, self-encrypting drive (SED)
500 GB, 7200 rpm, FIPS

 **NOTE:** Before you remove the old hard drive, be sure to back up the data from the old hard drive so that you can transfer the data to the new hard drive.

Before removing the hard drive, follow these steps:

1. Prepare the computer for disassembly ([Preparation for disassembly on page 17](#)).
2. Remove the access panel ([Access panel on page 17](#)).

Remove the hard drive and drive cage:

1. Rotate the hard drive latch up **(1)** to disengage the hard drive from the connector. Slide the drive away from the connector until it stops, and then lift the hard drive up and out of the cage **(2)**.

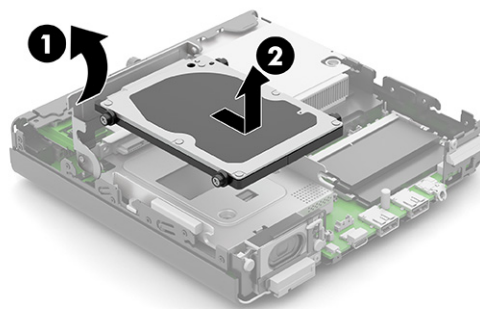

2. Lift the connector latch on the system board, and then pull the tab **(1)** to disconnect the hard drive cable **(2)**.
3. Remove the two Torx T15 screws **(3)** that secure the hard drive cage to the chassis.

- Slide the hard drive cage back, and then lift it out of the chassis (4).

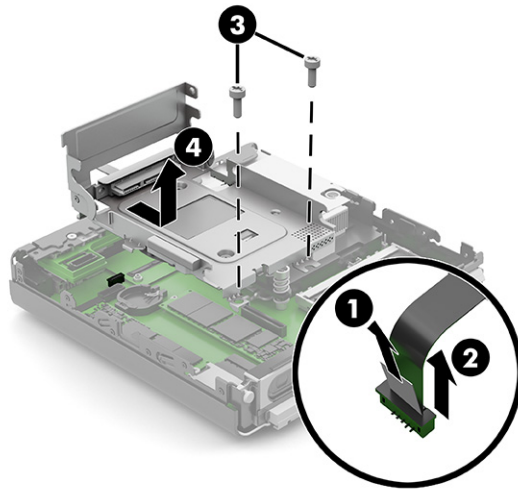

## Solid-state drive

To remove the solid-state drive module, use these procedures. The solid-state drive is located under the hard drive and drive cage.

**Table 4-5 Solid-state drive module descriptions**

Description
<b>Solid-state drive</b> (M.2 2280, PCIe)
2 TB, TLC
1 TB, TLC
512 GB, TLC
512 GB, TLC, self-encrypting drive (SED)
512 GB, value
512 GB + 32 GB Optane memory
256 GB, TLC
256 GB, TLC, self-encrypting drive (SED)
256 GB, value
256 GB + 16 GB Optane memory
128 GB, TLC
16 GB Optane memory module

Before removing the solid-state drive module, follow these steps:

- Prepare the computer for disassembly ([Preparation for disassembly on page 17](#)).
- Remove the access panel ([Access panel on page 17](#)).

Remove the solid-state drive module:

1. Locate the solid-state drives on the system board.

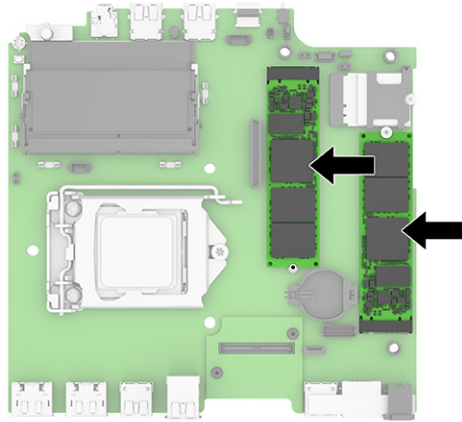

2. Remove the screw that secures the drive (1).
3. Pull the drive out of the system board connector (2).

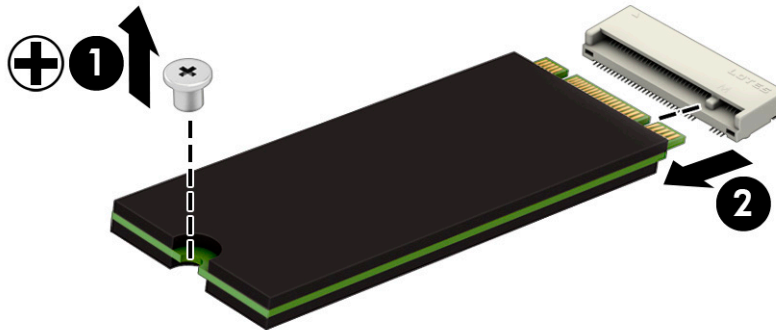

To install the solid-state drive module, reverse the removal procedure.

## WLAN module

To remove the WLAN module, use these procedures.

The WLAN module is located under the hard drive and drive cage.

Before removing the WLAN module, follow these steps:

1. Prepare the computer for disassembly ([Preparation for disassembly on page 17](#)).
2. Remove the access panel ([Access panel on page 17](#)).
3. Remove the hard drive and drive cage ([Hard drive and drive cage on page 23](#)).

Remove the WLAN module:

1. Locate the WLAN module on the system board.

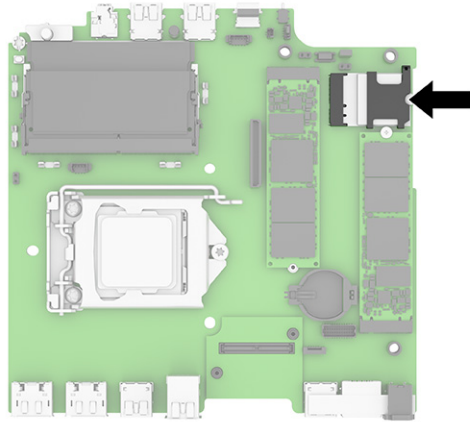

2. Disconnect the antenna cables from the module (1).



**NOTE:** The WLAN antenna cable labeled 1/MAIN connects to the WLAN module Main terminal. The WLAN antenna cable labeled 2/AUX connects to the WLAN module Aux terminal.

3. Remove the screw (2) that secures the module to the computer.
4. Pull the module to remove it from the socket (3).

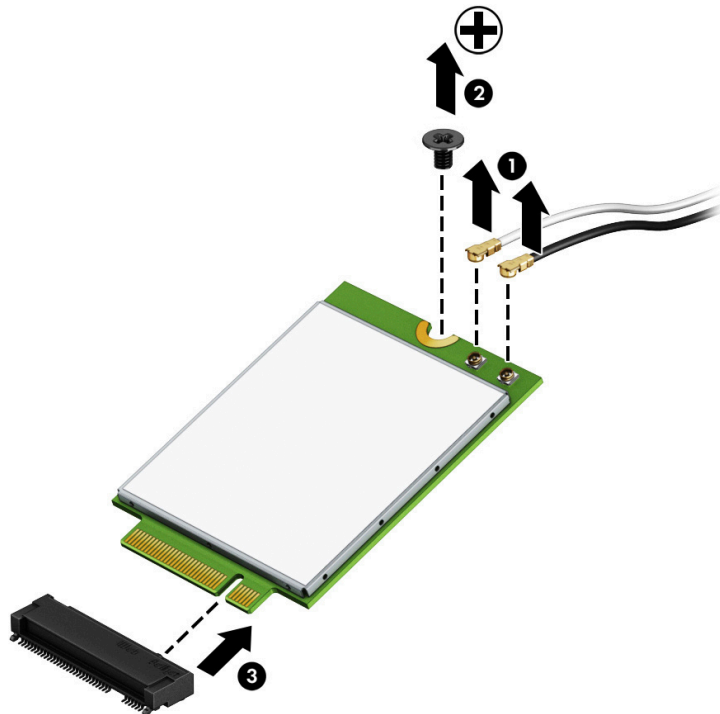

5. If the WLAN antenna is not connected to the terminal on the WLAN module, a protective sleeve must be installed on the antenna connector, as shown in the following illustration.

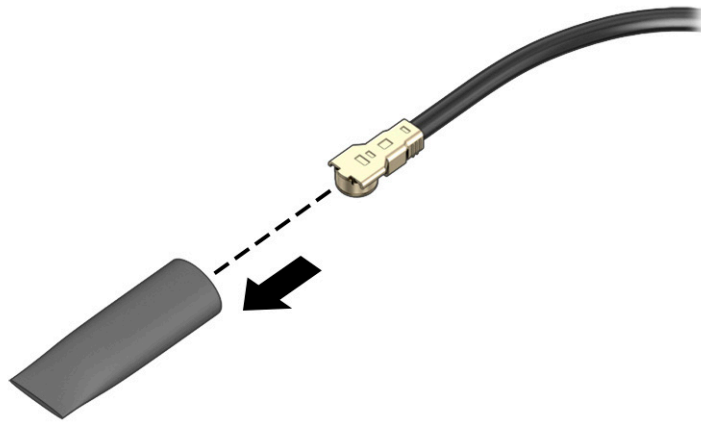

To install the WLAN module, reverse the removal procedure.

---

 **NOTE:** WLAN modules are designed with a notch to prevent incorrect insertion.

---

## Battery

To remove the battery, use these procedures. The battery that comes with the computer provides power to the real-time clock. When replacing the battery, use a battery equivalent to the battery originally installed in the computer. The computer comes with a 3 V lithium coin cell battery.

---

 **WARNING!** The computer contains an internal lithium manganese dioxide battery. There is a risk of fire and burns if the battery is not handled properly. To reduce the risk of personal injury:

Do not attempt to recharge the battery.

Do not expose to temperatures higher than 60°C (149°F).

Do not disassemble, crush, puncture, short external contacts, or dispose of in fire or water.

Replace the battery only with the HP spare part that is designated for this product.

 **IMPORTANT:** Before replacing the battery, back up the computer CMOS settings. When the battery is removed or replaced, the CMOS settings are cleared.

Static electricity can damage the electronic components of the computer or optional equipment. Before beginning these procedures, be sure that you are discharged of static electricity by briefly touching a grounded metal object.

 **NOTE:** You can extend the lifetime of the lithium battery by plugging the computer into an AC outlet. The lithium battery is used only when the computer is not connected to AC power.

HP encourages customers to recycle used electronic hardware, HP original print cartridges, and rechargeable batteries. For more information about recycling programs, go to <http://www.hp.com/recycle>.

---

Before removing the battery, follow these steps:

1. Prepare the computer for disassembly ([Preparation for disassembly on page 17](#)).
2. Remove the access panel ([Access panel on page 17](#)).
3. Remove the hard drive and drive cage ([Hard drive and drive cage on page 23](#)).

Remove the battery:

1. Locate the battery and battery holder on the system board.

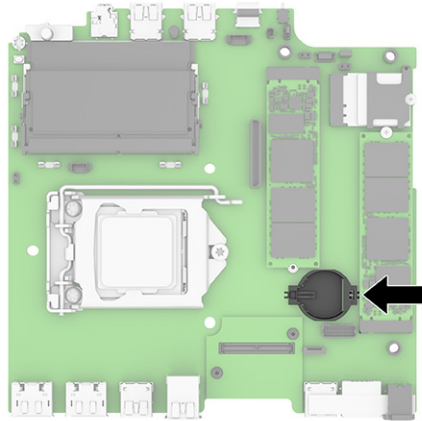

2. To release the battery from its holder, squeeze the metal clamp that extends above one edge of the battery (1). When the battery pops up, lift it out (2).



3. Slide the replacement battery into position, positive side up. The battery holder automatically secures the battery in the proper position.

## Speaker

To remove the speaker, use these procedures.

Before removing the speaker, follow these steps:

1. Prepare the computer for disassembly ([Preparation for disassembly on page 17](#)).
2. Remove the access panel ([Access panel on page 17](#)).
3. Remove the hard drive and drive cage ([Hard drive and drive cage on page 23](#)).

Remove the speaker:

1. Disconnect the speaker cable from the system board connector **(1)**.
2. From the outside-front, press the rubber grommets and the speaker into the chassis **(2)**.
3. Remove the speaker from the computer **(3)**.

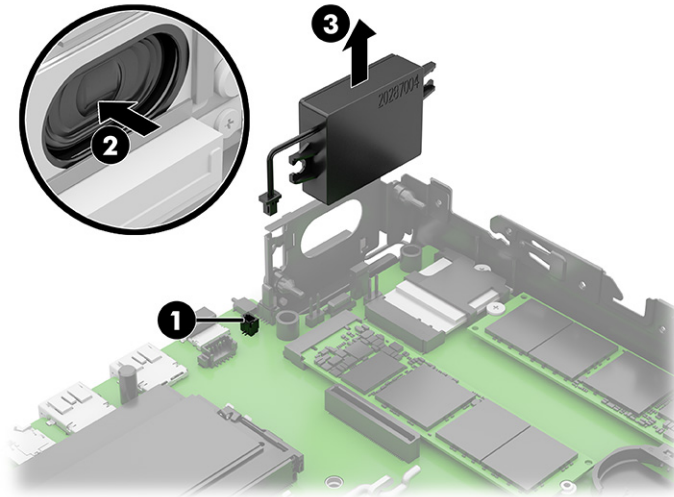

To install the speaker, reverse the removal procedures.

## Ambient (thermal) sensor

To remove the ambient sensor, use these procedures.

Before removing the ambient sensor, follow these steps:

1. Prepare the computer for disassembly ([Preparation for disassembly on page 17](#)).
2. Remove the access panel ([Access panel on page 17](#)).
3. Remove the hard drive and drive cage ([Hard drive and drive cage on page 23](#)).

Remove the ambient sensor:

- ▲ Pull straight up to disconnect the ambient sensor from the system board.

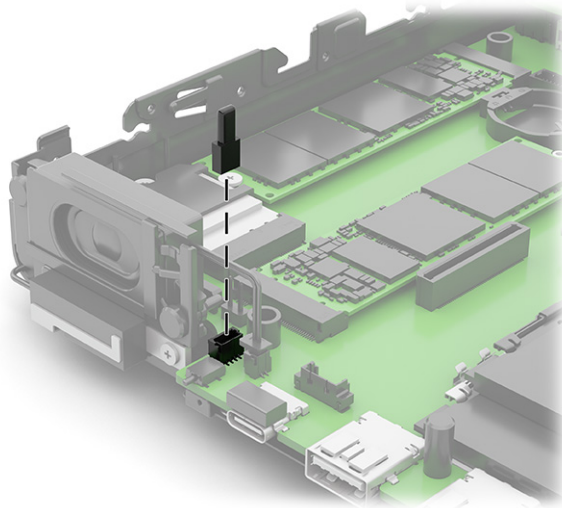

To install the ambient sensor, reverse the removal procedure.

## Flex I/O connector board #1

To remove flex I/O connector board #1, use these procedures.

Before removing flex I/O connector board #1, follow these steps:

1. Prepare the computer for disassembly ([Preparation for disassembly on page 17](#)).
2. Remove the access panel ([Access panel on page 17](#)).
3. Remove the hard drive and drive cage ([Hard drive and drive cage on page 23](#)).

Remove flex I/O connector board #1:

- ▲ Remove the two Phillips screws that secure the board to the computer **(1)**, and then lift the board to disconnect it from the connector on the system board **(2)**.

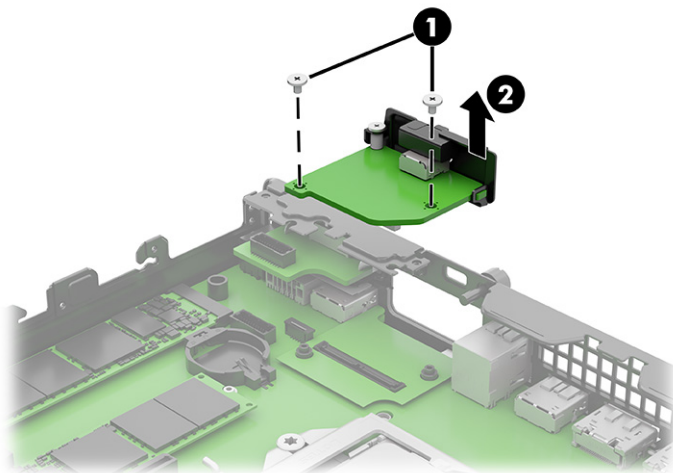

To install flex I/O connector board #1, reverse the removal procedure.



## Flex I/O connector board #2

To remove flex I/O connector board #2, use these procedures.

Before removing flex I/O connector board #2, follow these steps:

1. Prepare the computer for disassembly ([Preparation for disassembly on page 17](#)).
2. Remove the access panel ([Access panel on page 17](#)).
3. Remove the hard drive and drive cage ([Hard drive and drive cage on page 23](#)).

Remove flex I/O connector board #2:

1. Disconnect the cable from the system board (1).
2. Remove the two Phillips screws that secure the board to the computer (2).
3. Remove the board from the computer (3).

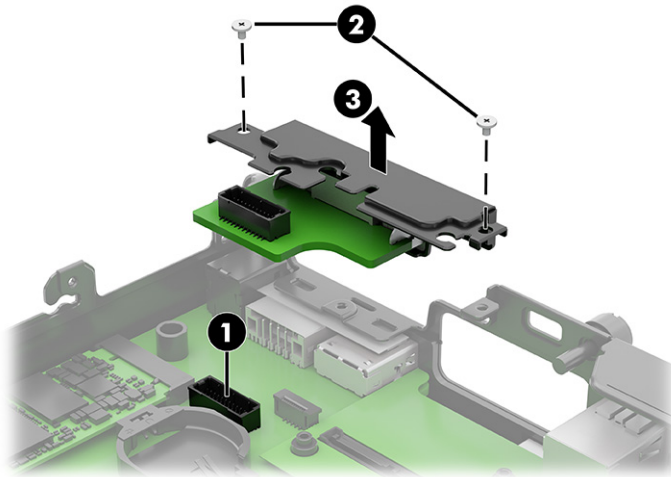

To install flex I/O connector board #2, reverse the removal procedure.

## Heat sink

To remove the heat sink, use these procedures.

 **IMPORTANT:** The bond between the heat sink and the processor can be very tight.

If the computer will turn on, before removing the heat sink, turn on the computer until it warms the heat sink. Warming the heat sink loosens the bond between the heat sink and the processor, thereby making it easier to separate them.

Make sure not to pull the processor out of the socket when you lift the heat sink, especially if you cannot warm the heat sink before removal. Inadvertently removing the processor can damage the pins.

Before removing the heat sink, follow these steps:

1. Prepare the computer for disassembly ([Preparation for disassembly on page 17](#)).
2. Remove the access panel ([Access panel on page 17](#)).
3. Remove the fan ([Fan on page 22](#)).

Remove the heat sink:

1. In the order indicated on the heat sink, loosen the three captive Torx screws **(1)**.
2. Lift the back of the heat sink upward **(2)**, and then remove the heat sink from the computer **(3)**.

 **IMPORTANT:** Be sure to loosen the screws in the order indicated by the numbers stamped on the heat sink.

**IMPORTANT:** For optimum thermal performance, be sure not to touch the thermal grease on the surface of the processor or the heat sink.

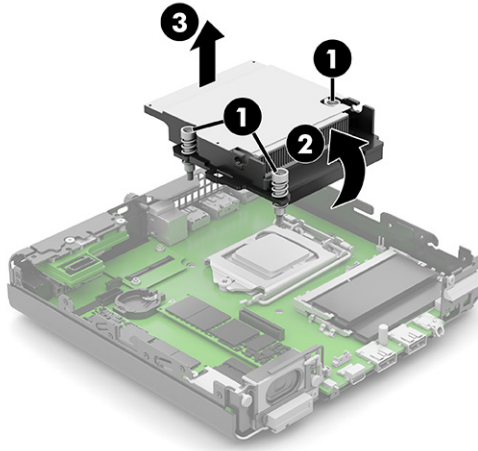

3. Thoroughly clean the thermal material from the surfaces of the heat sink and the system board components each time the heat sink is removed. Replacement thermal material is included with the heat sink and system board spare part kits. The following illustration shows the replacement thermal material locations.

Thermal paste is used on the processor **(1)** and on the heat sink **(2)**. Thermal pads are used on specific system board components **(3)** and associated locations on the heat sink **(4)**.

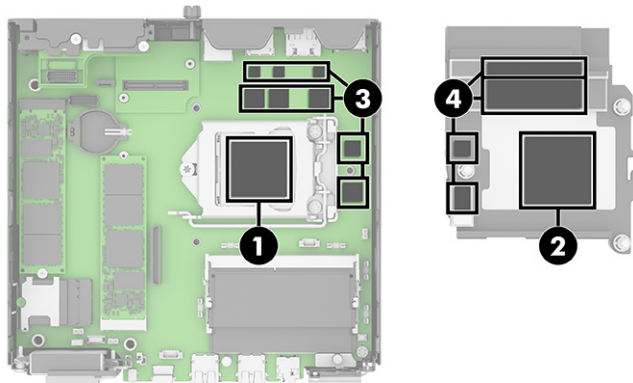

 **IMPORTANT:** Tighten heat sink retaining screws in diagonally opposite pairs (as in an X) to evenly seat the heat sink on the processor to avoid damage that could require replacing the system board.

To replace the heat sink, reverse the removal procedures.

# Processor

To remove the processor, use these procedures.

**Table 4-6 Processor descriptions**

Description
Intel® Core® i7-10700 (2.9 GHz, 16 MB Intel Smart Cache, 8 core, 65 W)
Intel Core i7-10700T (2.0 GHz, 16 MB Intel Smart Cache, 8 core, 35 W)
Intel Core i5-10600 (3.3 GHz, 12 MB Intel Smart Cache, 6 core, 65 W)
Intel Core i5-10600T (2.4 GHz, 12 MB Intel Smart Cache, 6 core, 35 W)
Intel Core i5-10500 (3.1 GHz, 12 MB Intel Smart Cache, 6 core, 65 W)
Intel Core i5-10500T (2.3 GHz, 12 MB Intel Smart Cache, 6 core, 35 W)
Intel Core i5-10400 (2.9 GHz, 12 MB Intel Smart Cache, 6 core, 65 W)
Intel Core i5-10400T (2.0 GHz, 12 MB Intel Smart Cache, 6 core, 35 W)
Intel Core i3-10320 (3.8 GHz, 8 MB Intel Smart Cache, 4 core, 65 W)
Intel Core i3-10300 (3.7 GHz, 8 MB Intel Smart Cache, 4 core, 65 W)
Intel Core i3-10300T (3.0 GHz, 8 MB Intel Smart Cache, 4 core, 35 W)
Intel Core i3-10100 (3.6 GHz, 6 MB Intel Smart Cache, 4 core, 65 W)
Intel Core i3-10100T (3.0 GHz, 6 MB Intel Smart Cache, 4 core, 35 W)
Intel Pentium Gold G6600 (4.2 GHz, 4 MB Intel Smart Cache, 2 core, 58 W)
Intel Pentium Gold G6500 (4.1 GHz, 4 MB Intel Smart Cache, 2 core, 58 W)
Intel Pentium Gold G6500T (3.5 GHz, 4 MB Intel Smart Cache, 2 core, 35 W)
Intel Pentium Gold G6400 (4.0 GHz, 4 MB Intel Smart Cache, 2 core, 58 W)
Intel Pentium Gold G6400T (3.4 GHz, 4 MB Intel Smart Cache, 2 core, 35 W)
Intel Celeron G5920 (3.5 GHz, 2 MB Intel Smart Cache, 2 core, 58 W)
Intel Celeron G5900 (3.4 GHz, 2 MB Intel Smart Cache, 2 core, 58 W)
Intel Celeron G5900T (3.2 GHz, 2 MB Intel Smart Cache, 2 core, 35 W)

Before removing the processor, follow these steps:

1. Prepare the computer for disassembly ([Preparation for disassembly on page 17](#)).
2. Remove the access panel ([Access panel on page 17](#)).
3. Remove the heat sink ([Heat sink on page 31](#)).
4. Remove the fan ([Fan on page 22](#)).

Remove the processor:

1. Pull the locking lever away from the processor **(1)**, and then rotate the lever to its full open position **(2)**.
2. Raise and rotate the microprocessor retainer to its fully open position **(3)**.

3. Carefully lift the processor from the socket (4).

 **IMPORTANT:** Do not handle the pins in the processor socket. These pins are fragile, and handling them could cause irreparable damage. If pins are damaged, you might have to replace the system board.

The heat sink must be installed within 24 hours of installing the processor to prevent damage to the processor's solder connections.

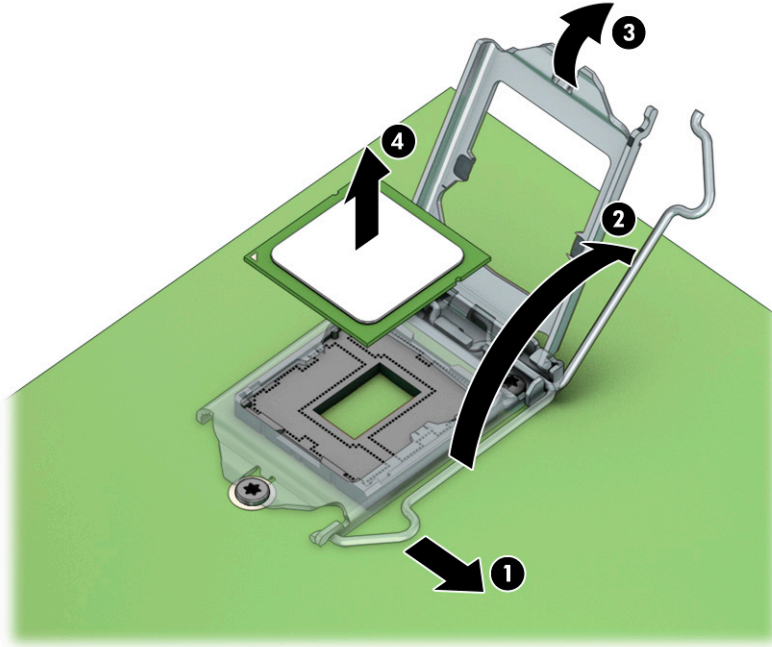

To replace the processor, reverse the removal procedures.

 **NOTE:** After installing a new processor onto the system board, always update the system ROM to ensure that the latest version of the BIOS is being used on the computer. For more information, see: <https://support.hp.com/us-en/document/c06366640>.

## System board

To remove the system board, use these procedures.

 **NOTE:** All system board spare part kits include replacement thermal material.

Before removing the system board, follow these steps:

1. Prepare the computer for disassembly ([Preparation for disassembly on page 17](#)).
2. Remove the access panel ([Access panel on page 17](#)).
3. Remove the memory modules ([Memory modules \(SODIMMs\) on page 19](#)).
4. Remove the fan ([Fan on page 22](#)).
5. If applicable, remove the hard drive and drive cage ([Hard drive and drive cage on page 23](#)).
6. If applicable, remove flex I/O connector board #1 ([Flex I/O connector board #1 on page 30](#)).
7. If applicable, remove flex I/O connector board #2 ([Flex I/O connector board #2 on page 31](#)).

8. Remove the heat sink ([Heat sink on page 31](#)).
9. Remove the processor ([Processor on page 33](#)).

Remove the system board:

1. Disconnect the speaker cable from the system board (1).
2. Disconnect the antenna cables from the WLAN module (2). If replacing the system board, be sure to remove the WLAN module from the old board and install the module on the new board.
3. Remove the two longer Torx screws (3) and the two shorter Torx screws (4) that secure the system board to the computer.

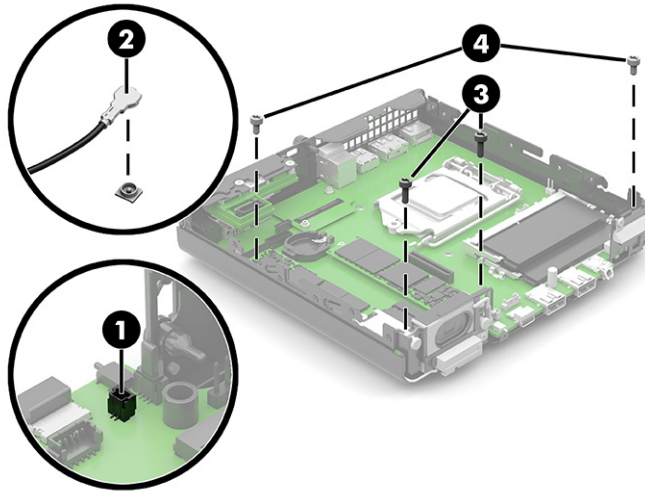

4. Lift the side of the system board (1), and then remove it from the computer (2).

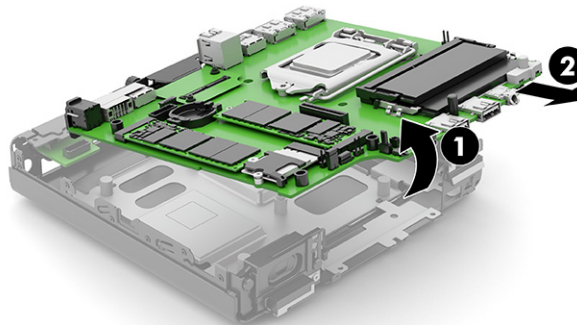

To install the system board, reverse the removal procedures.

 **NOTE:** When replacing the system board, you must change the chassis serial number in the BIOS.

When replacing the system board, you must reprogram the SMBIOS information about the affected computer. Failure to reprogram the board will result in eventual failure, such as an activation failure (when you would have to reactivate the computer) or a system recovery failure.

Update the SMBIOS information in Computer Setup.

## System board callouts

Use this illustration and table to determine system board callout locations.

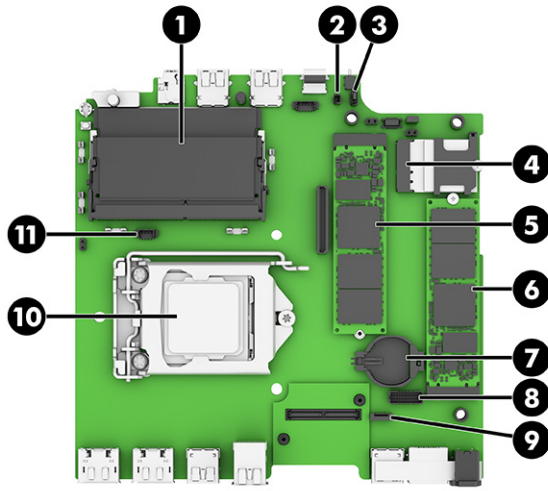

**Table 4-7 System board callouts**

Item	Component	Item	Component
(1)	Memory modules	(7)	RTC battery
(2)	Ambient sensor	(8)	Flex I/O board #2
(3)	Speaker	(9)	Flex I/O board #1
(4)	WLAN module	(10)	Processor
(5)	Solid-state drive	(11)	System fan
(6)	Solid-state drive		

## Wireless antennas and cables

To remove the wireless antennas and cables, use these procedures. The cables route from the WLAN module to the antennas mounted on the front of the computer.

Before removing the wireless antennas and cables, follow these steps:

1. Prepare the computer for disassembly ([Preparation for disassembly on page 17](#)).
2. Remove the access panel ([Access panel on page 17](#)).
3. Remove the fan ([Fan on page 22](#)).
4. If applicable, remove the hard drive and drive cage ([Hard drive and drive cage on page 23](#)).
5. Remove the WLAN module ([WLAN module on page 25](#)).
6. If applicable, remove flex I/O connector board #1 ([Flex I/O connector board #1 on page 30](#)).
7. If applicable, remove flex I/O connector board #2 ([Flex I/O connector board #2 on page 31](#)).
8. Remove the system board ([System board on page 34](#)).

Remove the wireless antennas:

1. From the inside of the chassis, remove the antenna cables from the clips **(1)**.
2. From the front of the chassis, remove the Phillips screw from each antenna **(2)**.
3. Pull the antennas and cables out of the front of the chassis **(3)**.

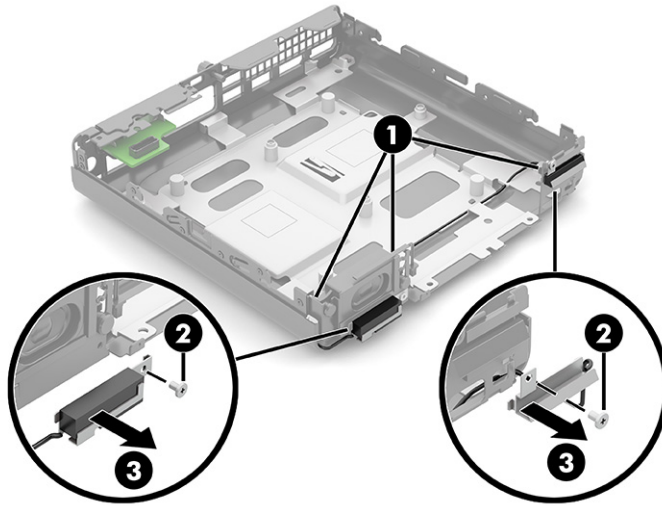





---

# 5 Troubleshooting without diagnostics

Use these sections to identify and correct minor problems.

**⚠ CAUTION:** Misuse of the computer or failure to establish a safe and comfortable work environment may result in discomfort or serious injury. See the *Safety & Comfort Guide* at <http://www.hp.com/ergo> for more information about choosing a workspace and creating a safe and comfortable work environment. For more information, see the *Safety & Regulatory Information* guide.

---

## Before you call for technical support

If you are having problems with the computer, try these solutions to isolate the exact problem before calling for technical support.

- Run the HP diagnostic tool.
- Run the hard drive self-test in Computer Setup.
- Check the power light on the front of the computer to see if it is blinking red. The blinking lights are error codes that will help you diagnose the problem.
- If you are working on a network, plug another computer with a different cable into the network connection. There might be a problem with the network plug or cable.
- If you recently added new hardware, remove the hardware and see if the computer functions properly.
- If you recently installed new software, uninstall the software and see if the computer functions properly.
- Boot the computer to the Safe Mode to see if it will boot without all of the drivers loaded. When booting the operating system, use “Last Known Configuration.”
- See the comprehensive online technical support at <http://www.hp.com/support>.

To assist you in resolving problems online, HP Instant Support Professional Edition provides you with self-solve diagnostics. If you need to contact HP support, use HP Instant Support Professional Edition's online chat feature. Access HP Instant Support Professional Edition at: <http://www.hp.com/go/ispe>.

Access the Business Support Center (BSC) at <http://www.hp.com/go/bizsupport> for the latest online support information, software and drivers, proactive notification, and worldwide community of peers and HP experts.

If it becomes necessary to call for technical assistance, be prepared to do the following tasks to ensure that your service call is handled properly:

- Be in front of your computer when you call.
- Before you call, write down the computer serial number and product ID number.
- Spend time troubleshooting the problem with the service technician.
- Remove any hardware that was recently added to your system.
- Remove any software that was recently installed.
- Restore the system from the Recovery Disc Set that you created or restore the system to its original factory condition in System Software Requirement Disks (SSRD).



---

**IMPORTANT:** Restoring the system will erase all data on the hard drive. Be sure to back up all data files before running the restore process.



**NOTE:** For sales information and warranty upgrades (Care Packs), call your local authorized service provider or dealer.

---

## Helpful hints

If you encounter problems with the computer or software, see this list of general suggestions before taking further action.

- Check that the computer is plugged into a working electrical outlet.
- Check that the computer is turned on and the white power light is on.
- Check the power light on the front of the computer to see if it is blinking red. The blinking lights are error codes that help you diagnose the problem.
- Press and hold any key if the system beeps. Then the keyboard should be operating correctly.
- Check all cable connections for loose connections or incorrect connections.
- Wake the computer by pressing any key on the keyboard or pressing the power button. If the system remains in suspend mode, shut down the computer by pressing and holding the power button for at least four seconds, and then press the power button again to restart the computer. If the system will not shut down, unplug the power cord, wait a few seconds, and then plug it in again. The computer will restart if it is set to turn on automatically as soon as power is restored in Computer Setup. If it does not restart, press the power button to start the computer.
- Be sure that all the needed device drivers have been installed. For example, if you are using a printer, you need a driver for that model printer.
- Remove all bootable media (such as a USB device) from the system before turning it on.
- If you have installed an operating system other than the factory-installed operating system, check to be sure that it is supported on the system.

---

**NOTICE:** When the computer is plugged into an AC power source, there is always voltage applied to the system board. You must disconnect the power cord from the power source before opening the computer to prevent system board or component damage.

---

## Solving general problems

You might be able to easily resolve the general problems described in this section. If a problem persists and you cannot resolve it yourself or if you feel uncomfortable about performing the operation, contact an authorized dealer or reseller.



---

**CAUTION:** When the computer is plugged into an AC power source, voltage is always applied to the system board. To reduce the risk of personal injury from electrical shock, hot surfaces, or both, be sure to disconnect the power cord from the AC outlet and allow the internal system components to cool before touching.

---

## Cannot access the Computer Setup (F10) Utility when booting the computer

Use this information to troubleshoot the computer.

Cause	Solution
<b>The Computer Setup (F10) Utility is set to Fast Boot causing the F10 access screen to display too briefly when booting the computer.</b>	Before turning on the computer, press and hold <b>F10</b> . Turn on the computer and continue to hold <b>F10</b> until the Computer Setup (F10) Utility is displayed. - or - Follow the Windows® instructions for rebooting the computer into the Computer Setup (F10) Utility.

## Computer appears locked up and will not turn off when the power button is pressed

Use this information to troubleshoot the computer.

Cause	Solution
<b>Software control of the power switch is not functional.</b>	<ol style="list-style-type: none"> <li>1. Press and hold the power button for at least 4 s until the computer turns off.</li> <li>2. Disconnect the power cord from the electrical outlet.</li> </ol>

## Computer will not respond to keyboard or mouse

Use this information to troubleshoot the computer.

Cause	Solution
<b>Computer is in Sleep state.</b>	To resume from Sleep state, press the power button. When attempting to resume from Sleep state, do not hold down the power button for more than 4 s. Otherwise, the computer shuts down and you lose any unsaved data.
<b>System has locked up.</b>	Restart computer.
<b>USB cables may not be seated properly.</b>	Disconnect, and then reconnect USB cables to keyboard and mouse.

## Computer date and time display is incorrect

Use this information to troubleshoot the computer.

Cause	Solution
<b>RTC (real-time clock) battery may need to be replaced.</b>	Reset the date and time under <b>Control Panel</b> . (Computer Setup can also be used to update the RTC date and time.) If the problem persists, replace the RTC battery. See the Removal and Replacement section for instructions on installing a new battery, or contact an authorized dealer or reseller for RTC battery replacement. To access Control Panel in Windows 10, type <code>control panel</code> in the taskbar search box, and then select Control Panel.

## There is no sound or sound volume is too low

Use this information to troubleshoot the computer.

Cause	Solution
<b>System volume might be set low or muted.</b>	<ol style="list-style-type: none"> <li>1. Check the front panel to see if an amber light indicates the system has been muted. Tap the touch-sensitive button to toggle the mute on and off.</li> <li>2. Check the Computer Setup settings to be sure that the internal system speaker is not muted. This setting does not affect the external speakers.</li> <li>3. Be sure that the external speakers are properly connected and powered on and that the speakers' volume control is set correctly.</li> <li>4. Use the system volume control available in the operating system to be sure that the speakers are not muted or to increase the volume.</li> </ol>

## Cannot remove computer cover or access panel

Use this information to troubleshoot the computer.

Cause	Solution
<b>Smart Cover Lock, featured on some computers, is locked.</b>	Unlock the Smart Cover Lock using Computer Setup. In case of forgotten password, power loss, or computer malfunction, you must manually disable the Smart Cover lock. A key to unlock the Smart Cover Lock is not available from HP. Keys are typically available from a hardware store.

## Poor performance

Use this information to troubleshoot the computer.

Cause	Solution
<b>Processor is too hot.</b>	<ol style="list-style-type: none"> <li>1. Be sure that airflow to the computer is not blocked. Leave a 10.2 cm (4 inch) clearance on all vented sides of the computer to permit the required airflow.</li> <li>2. Be sure that fans are connected and working properly (some fans only operate when needed).</li> <li>3. Be sure that the processor heat sink is installed properly.</li> </ol>
<b>Hard drive is full.</b>	Transfer data from the hard drive to create more space on the hard drive.
<b>Low on memory.</b>	Add more memory.
<b>Hard drive fragmented.</b>	Defragment hard drive.
<b>Program previously accessed did not release reserved memory back to the system.</b>	Restart the computer.
<b>Virus resident on the hard drive.</b>	Run virus protection program.
<b>Too many applications running.</b>	<ol style="list-style-type: none"> <li>1. Close unnecessary applications to free memory.</li> <li>2. Add more memory.</li> </ol>

Cause	Solution
	<ol style="list-style-type: none"> <li>3. Some applications run in the background and can be closed by right-clicking their corresponding icons in the task tray.</li> </ol>
<b>Some software applications, especially games, are stressful on the graphics subsystem.</b>	<ol style="list-style-type: none"> <li>1. Lower the display resolution for the current application or consult the documentation that came with the application for suggestions on how to improve performance by adjusting parameters in the application.</li> <li>2. Add more memory.</li> <li>3. Upgrade the graphics solution.</li> </ol>
<b>Cause unknown.</b>	Restart the computer.

## Computer powered off automatically and the power light blinks red four times and then white two times

Use this information to troubleshoot the computer.

Cause	Solution
<b>Processor thermal protection activated. A fan might be blocked or not turning, or the heat sink is not properly attached to the processor.</b>	<ol style="list-style-type: none"> <li>1. Be sure that the computer air vents are not blocked and the processor cooling fan is running.</li> <li>2. Open the access panel, press the power button, and see if the processor fan (or other system fan) spins. If the fan does not spin, be sure that the fan cable is plugged onto the system board header.</li> <li>3. If fan a plugged in and not spinning, replace it.</li> </ol>

## System does not turn on and the lights on the front of the computer are not blinking

Use this information to troubleshoot the computer.

Cause	Solution
<b>System unable to power on.</b>	<p>Press and hold the power button for less than 4 s. If the hard drive light turns white, then:</p> <ol style="list-style-type: none"> <li>1. If the computer has a voltage selector, check that the voltage selector (located on the rear of the power supply) is set to the appropriate voltage. Proper voltage setting depends on your region.</li> <li>2. Remove the expansion cards one at a time until the 5V_aux light on the system board turns on.</li> <li>3. Replace the system board.</li> </ol> <p>OR</p> <p>Press and hold the power button for less than 4 s. If the hard drive light does not turn white, then:</p> <ol style="list-style-type: none"> <li>1. Check whether the unit is plugged into a working AC outlet.</li> <li>2. Open the access panel and check that the power button cable is properly connected to the system board.</li> </ol>

Cause	Solution
	<ol style="list-style-type: none"> <li>Check that the power supply cables are properly connected to the system board.</li> <li>Check to see if the 5V_aux light on the system board is turned on. If it is turned on, then replace the power button assembly.</li> <li>If the 5V_aux light on the system board is off, then replace the power supply.</li> <li>Replace the system board.</li> </ol>

## Solving power problems

These tables provide common causes and solutions for power problems.

### Power supply shuts down intermittently

Use this information to troubleshoot the computer.

Cause	Solution
<b>If the computer has a voltage selector, voltage selector switch on rear of computer chassis (some models) not switched to correct line voltage (115 V or 230 V).</b>	Select the proper AC voltage using the selector switch.
<b>Power supply will not turn on because of internal power supply fault.</b>	Replace the power supply.

### Computer turned off automatically, power light blinks red two times followed by a two-second pause, and the computer beeps two times (Beeps stop after fifth iteration but lights continue blinking)

Use this information to troubleshoot the computer.

Cause	Solution
<b>Processor thermal protection activated. A fan might be blocked or not turning, or the heat sink is not properly attached to the processor.</b>	<ol style="list-style-type: none"> <li>Be sure that the computer air vents are not blocked and the processor cooling fan is running.</li> <li>Open the access panel, press the power button, and see if the processor fan (or other system fan) spins. If the fan does not spin, be sure that the fan cable is plugged onto the system board header.</li> <li>If the fan is plugged in and not spinning, replace it.</li> </ol>

### Power light blinks red four times followed by a two-second pause and the computer beeps four times (Beeps stop after fifth iteration but lights continue blinking)

Use this information to troubleshoot the computer.

Cause	Solution
<b>Power failure (power supply is overloaded).</b>	<ol style="list-style-type: none"> <li>1. If the computer has a voltage selector, check that the voltage selector, located on the rear of the power supply (some models), is set to the appropriate voltage. Proper voltage setting depends on your region.</li> <li>2. Open the access panel, and be sure that the power supply cable is seated into the connector on the system board.</li> <li>3. Check whether a device is causing the problem by removing all attached devices (such as hard drives or optical drives and expansion cards). Turn on the system. If the system enters POST, then power off and replace one device at a time and repeat this procedure until failure occurs. Replace the device that is causing the failure. Continue adding devices one at a time to ensure all devices are functioning properly.</li> <li>4. Replace the power supply.</li> <li>5. Replace the system board.</li> </ol>

## Solving hard drive problems

These tables provide common causes and solutions for hard drive problems.

### Hard drive error occurs

Use this information to troubleshoot the computer.

Cause	Solution
<b>Hard disk has bad sectors or has failed.</b>	<ol style="list-style-type: none"> <li>1. In Windows 10, type <i>file</i> in the taskbar search box, and then select <b>File Explorer</b> from the list of applications. In the left column, expand <b>This PC</b>, right-click a drive, select <b>Properties</b>, and then select the <b>Tools</b> tab. Under <b>Error checking</b>, click <b>Check</b>.</li> <li>2. Use a utility to locate and block usage of bad sectors. If necessary, reformat the hard disk.</li> </ol>

### Disk transaction problem

Use this information to troubleshoot the computer.

Cause	Solution
<b>Either the directory structure is bad or there is a problem with a file.</b>	In Windows 10, type <i>file</i> in the taskbar search box, and then select <b>File Explorer</b> from the list of applications. In the left column, expand <b>This PC</b> , right-click a drive, select <b>Properties</b> , and then select the <b>Tools</b> tab. Under <b>Error checking</b> , click <b>Check</b> .

### Drive not found (identified)

Use this information to troubleshoot the computer.

Cause	Solution
<b>Cable could be loose.</b>	Check cable connections.
<b>The system might not have automatically recognized a newly installed device.</b>	See reconfiguration directions in the <a href="#">Solving hardware installation problems on page 50</a> section. If the system still does not recognize the new device, check to see if the device is listed in Computer Setup. If it is listed, the probable cause is a driver problem. If it is not listed, the probable cause is a hardware problem. If this is a newly installed drive, run the Computer Setup utility, and add a POST delay under <b>Advanced &gt; Boot Options</b> .
<b>The device is attached to a SATA port that has been hidden in Computer Setup.</b>	Run the Computer Setup utility and be sure that <b>Device Available</b> is selected for the device's SATA port in <b>Advanced &gt; Port Options</b> .
<b>Drive responds slowly immediately after startup.</b>	Run Computer Setup and increase the POST Delay in <b>Advanced &gt; Boot Options</b> .

## Nonsystem disk/NTLDR missing message

Use this information to troubleshoot the computer.

Cause	Solution
<b>The system is trying to start from the hard drive, but the hard drive might have been damaged.</b>	▲ Perform Drive Protection System (DPS) testing in system ROM.
<b>System files missing or not properly installed.</b>	<ol style="list-style-type: none"> <li>1. Insert bootable media and restart the computer.</li> <li>2. Boot to the windows installation media, and select the recovery option. If only a restore kit is available, then select the <b>File Backup Program</b> option, and then restore the system.</li> <li>3. Install system files for the appropriate operating system.</li> </ol>
<b>Hard drive boot has been disabled in Computer Setup.</b>	Run the Computer Setup utility, and enable the hard drive entry in the <b>Advanced &gt; Boot Options</b> list.
<b>Bootable hard drive is not attached as first in a multiple hard drive configuration.</b>	If attempting to boot from a hard drive, be sure that it is attached to the system board dark blue SATA connector.
<b>Bootable hard drive is not listed first in the Boot Order.</b>	Run the Computer Setup utility, and select <b>Advanced &gt; Boot Options</b> , and be sure that the bootable hard drive is listed immediately under the <b>Hard Drive</b> entry.

## Computer will not boot from hard drive

Use this information to troubleshoot the computer.

Cause	Solution
<b>The device is attached to a SATA port that has been hidden in Computer Setup.</b>	<ol style="list-style-type: none"> <li>1. Check SATA cable connections.</li> <li>2. Run the Computer Setup utility, and be sure that <b>Device Available</b> is selected for the device's SATA port in <b>Advanced &gt; Port Options</b>.</li> </ol>



Cause	Solution
<b>Boot order is not correct.</b>	Run the Computer Setup utility, and change boot sequence in <b>Advanced &gt; Boot Options</b> .
<b>Hard drive is damaged.</b>	Observe whether the front panel power light is blinking red and whether any beeps are heard. See the Worldwide Limited Warranty for terms and conditions.

## Computer seems to be locked up

Use this information to troubleshoot the computer.

Cause	Solution
<b>Program in use has stopped responding to commands.</b>	<ol style="list-style-type: none"> <li>1. Use the task manager to close programs that do not respond.</li> <li>2. Attempt the normal Windows shut down procedure. If this fails, press the power button for four or more seconds to turn off the power. To restart the computer, press the power button again.</li> </ol>

## Solving audio problems

If the computer has audio features and you encounter audio problems, see the common causes and solutions listed in these tables.

### Sound cuts in and out

Use this information to troubleshoot the computer.

Cause	Solution
<b>Processor resources are being used by other open applications.</b>	Shut down all open processor-intensive applications.

### Sound does not come out of the speaker or headphones

Use this information to troubleshoot the computer.

Cause	Solution
<b>Software volume control is turned down or muted.</b>	Double-click the <b>Speaker</b> icon on the taskbar, be sure that <b>Mute</b> is not selected, and use the volume slider to adjust the volume. You can perform this action with the touch-sensitive buttons on the front of the computer.
<b>Audio is hidden in Computer Setup.</b>	Enable the audio in Computer Setup: <b>Advanced &gt; Built-in Device Options</b> .
<b>The external speakers are not turned on.</b>	Turn on the external speakers.
<b>Headphones or devices connected to the line-out connector mute the internal speaker.</b>	Turn on and use headphones or external speakers, if connected, or disconnect headphones or external speakers.

Cause	Solution
<b>Computer is in the Sleep state.</b>	Press the power button to resume from the Sleep state. When attempting to resume from the Sleep state, do not hold down the power button for more than 4 seconds. Otherwise, the computer will shut down, and you will lose any unsaved data.
<b>Internal speaker is disabled in Computer Setup.</b>	Enable the internal speaker in Computer Setup. Select <b>Advanced &gt; Built-in Device Options</b> .
<b>Some applications can select which audio output device is used.</b>	Be sure that the application has selected the correct audio device.
<b>The operating system controls might be set to use a different audio device as the default output device than what is expected.</b>	Set the operating system to use the correct audio device.

## Computer appears to be locked up while recording audio

Use this information to troubleshoot the computer.

Cause	Solution
<b>The hard disk might be full.</b>	Before recording, be sure that there is enough free space on the hard disk. You can also try recording the audio file in a compressed format.

## Line-in jack is not functioning properly

Use this information to troubleshoot the computer.

Cause	Solution
<b>Jack has been reconfigured in the audio driver or application software.</b>	In the audio driver or application software, reconfigure the jack or set the jack to its default value.

## Solving printer problems

If you encounter printer problems, see the documentation that came with the printer and the common causes and solutions listed in these tables.

### Printer will not print

Use this information to troubleshoot the computer.

Cause	Solution
<b>Printer is not turned on and online.</b>	Turn the printer on and be sure that it is online.
<b>The correct printer drivers for the application are not installed.</b>	<ol style="list-style-type: none"> <li>1. Install the correct printer driver for the application.</li> <li>2. Try printing using the MS-DOS command: <p>DIR C:\ &gt; [printer port] where [printer port] is the address of the printer being used. If the printer works, reload</p> </li> </ol>

Cause	Solution
	the printer driver. To run MS-DOS commands, press the Windows key + r, type <code>cmd</code> in the <b>Open</b> box, and then select <b>OK</b> .
<b>If you are on a network, you might not have made the connection to the printer.</b>	Make the proper network connections to the printer.
<b>Printer might have failed.</b>	Run printer self-test.

## Printer will not turn on

Use this information to troubleshoot the computer.

Cause	Solution
<b>The cables might not be connected properly.</b>	Reconnect all cables, and check the power cord and electrical outlet.

## Printer prints garbled information

Use this information to troubleshoot the computer.

Cause	Solution
<b>The correct printer driver for the application is not installed.</b>	Install the correct printer driver for the application.
<b>The cables might not be connected properly.</b>	Reconnect all cables.
<b>Printer memory might be overloaded.</b>	Reset the printer by turning it off for 1 min, and then turn it back on.

## Printer will not print

Use this information to troubleshoot the computer.

Cause	Solution
<b>The printer might be out of paper.</b>	Check the paper tray, and refill it if it is empty.

## Solving keyboard and mouse problems

If you encounter keyboard or mouse problems, see the documentation that came with the equipment and the common causes and solutions listed in these tables.

### Keyboard commands and typing are not recognized by the computer

Use this information to troubleshoot the computer.

Cause	Solution
<b>Keyboard connector is not properly connected.</b>	Shut down the computer, reconnect the keyboard, and then restart the computer.

Cause	Solution
<b>Program in use has stopped responding to commands.</b>	Shut down your computer using the mouse, and then restart the computer.
<b>Keyboard needs repairs.</b>	See the Worldwide Limited Warranty for terms and conditions.
<b>Computer is in the Sleep state.</b>	Press the power button to resume from the Sleep state. When attempting to resume from the Sleep state, do not hold down the power button for more than 4 seconds. Otherwise, the computer will shut down, and you will lose any unsaved data.

## Mouse does not respond to movement or is too slow

Use this information to troubleshoot the computer.

Cause	Solution
<b>Mouse connector is not properly plugged into the back of the computer.</b>	Shut down the computer using the keyboard. <ol style="list-style-type: none"> <li>1. Press the <b>ctrl</b> and <b>esc</b> keys at the same time (or press the <b>Windows logo</b> key) to display the <b>Start</b> menu.</li> <li>2. Use the <b>arrow</b> keys to scroll to and select the power icon at the top right on the menu, and then press <b>enter</b>.</li> <li>3. Use the <b>arrow</b> keys to select <b>Shut Down</b>, and then press <b>enter</b>.</li> <li>4. After the shutdown is complete, plug the mouse connector into the back of the computer (or the keyboard) and restart.</li> </ol>
<b>Program in use has stopped responding to commands.</b>	Shut down the computer using the keyboard, and then restart the computer.
<b>Mouse might need repair.</b>	See the Worldwide Limited Warranty for terms and conditions.
<b>Computer is in the Sleep state.</b>	Press the power button to resume from the Sleep state. When attempting to resume from the Sleep state, do not hold down the power button for more than 4 seconds. Otherwise, the computer will shut down, and you will lose any unsaved data.
<b>If using a wireless mouse, you might need to resynchronize the mouse with the computer.</b>	Follow the instructions that came with the mouse.

## Solving hardware installation problems

You might need to reconfigure the computer when you add or remove hardware, such as an additional drive or expansion card.

If you install a plug and play device, Windows automatically recognizes the device and configures the computer. If you install a non-plug and play device, you must reconfigure the computer after completing installation of the new hardware. In Windows, use the **Add Hardware Wizard**, and follow the instructions that appear on the screen.

To open the Add Hardware Wizard, open a command prompt and type .

**⚠ WARNING!** When the computer is plugged into an AC power source, voltage is always applied to the system board. To reduce the risk of personal injury from electrical shock, hot surfaces, or both, be sure to disconnect the power cord from the AC outlet and allow the internal system components to cool before touching.

## A new device is not recognized as part of the system

Use this information to troubleshoot the computer.

Cause	Solution
<b>Cables of new external device are loose or power cables are unplugged.</b>	Be sure that all cables are properly and securely connected and that pins in the cable or connector are not bent down.
<b>Power switch of new external device is not turned on.</b>	Turn off the computer, turn on the external device, and then turn on the computer to integrate the device with the computer system.
<b>When the system advised you of changes to the configuration, you did not accept them.</b>	Reboot the computer and follow the instructions for accepting the changes.
<b>A plug and play board might not automatically configure when added if the default configuration conflicts with other devices.</b>	Use Windows Device Manager to clear the automatic settings for the board, and choose a basic configuration that does not cause a resource conflict. You can also use Computer Setup to reconfigure or disable devices to resolve the resource conflict. To access Device Manager in Windows 10, type <code>device manager</code> in the taskbar search box, and then select <b>Device Manager</b> from the list of applications.
<b>USB ports on the computer are disabled in Computer Setup.</b>	Run the Computer Setup utility and ensure that <b>Device available</b> is selected for appropriate USB ports under <b>Advanced &gt; Port Options</b> .

## Computer will not start

Use this information to troubleshoot the computer.

Cause	Solution
<b>Wrong memory modules were used in the upgrade, or memory modules were installed in the wrong location.</b>	<ol style="list-style-type: none"><li>1. Review the documentation that came with the system to determine if you are using the correct memory modules and to verify the proper installation. <b>NOTE:</b> DIMM1 or XMM1 must always be installed. DIMM1 must be installed before DIMM3.</li><li>2. Observe the beeps and lights on the front of the computer. Beeps and blinking lights are codes for specific problems.</li><li>3. If you still cannot resolve the issue, contact Customer Support.</li></ol>

## Power light blinks red three times and then white two times

Use this information to troubleshoot the computer.

Cause	Solution
<b>Memory is installed incorrectly or is bad.</b>	To avoid damage to the DIMMs or the system board, you must unplug the computer power cord before attempting to reseat, install, or remove a DIMM module. <ol style="list-style-type: none"><li>1. Reseat DIMMs. Turn on the system.</li><li>2. Replace DIMMs one at a time to isolate the faulty module.</li></ol>

Cause	Solution
	<p><b>NOTE:</b> DIMM1 or XMM1 must always be installed. DIMM1 must be installed before DIMM3.</p> <ol style="list-style-type: none"> <li>3. Replace third-party memory with HP memory.</li> <li>4. Replace the system board.</li> </ol>

## Solving network problems

Some common causes and solutions for network problems are listed in these tables. The guidelines do not discuss the process of debugging the network cabling.

### Network driver does not detect network controller

Use this information to troubleshoot the computer.

Cause	Solution
<b>Network controller is disabled.</b>	<ol style="list-style-type: none"> <li>1. Run Computer Setup and enable network controller.</li> <li>2. Enable the network controller in the operating system using Device Manager.  To access Device Manager in Windows 10, type <code>device manager</code> in the taskbar search box, and then select <b>Device Manager</b> from the list of applications.</li> </ol>
<b>Incorrect network driver.</b>	Check the network controller documentation for the correct driver or obtain the latest driver from the manufacturer's website.

### Network status link light never blinks

Use this information to troubleshoot the computer.



**NOTE:** The network status light is supposed to blink when there is network activity.

Cause	Solution
<b>No active network is detected.</b>	Check cabling and network equipment for proper connection.
<b>Network controller is not set up properly.</b>	Check for the device status within Windows, such as Device Manager for driver load and the Network Connections applet within Windows for link status. To access Device Manager in Windows 10, type <code>device manager</code> in the taskbar search box, and then select <b>Device Manager</b> from the list of applications.
<b>Network controller is disabled.</b>	<ol style="list-style-type: none"> <li>1. Run Computer Setup and enable network controller.</li> <li>2. Enable the network controller in the operating system using Device Manager.  To access Device Manager in Windows 10, type <code>device manager</code> in the taskbar search box, and then select <b>Device Manager</b> from the list of applications.</li> </ol>

Cause	Solution
Network driver is not properly loaded.	Reinstall network drivers.
System cannot autosense the network.	Disable autosensing capabilities, and force the system into the correct operating mode.

## Diagnostics reports a failure

Use this information to troubleshoot the computer.

Cause	Solution
The cable is not securely connected.	Be sure that the cable is securely attached to the network connector and that the other end of the cable is securely attached to the correct device.
The cable is attached to the incorrect connector.	Be sure that the cable is attached to the correct connector.
There is a problem with the cable or a device at the other end of the cable.	Be sure that the cable and device at the other end are operating correctly.
The network controller is defective.	Contact an authorized service provider.

## Diagnostics passes, but the computer does not communicate with the network

Use this information to troubleshoot the computer.

Cause	Solution
Network drivers are not loaded, or driver parameters do not match current configuration.	Be sure that the network drivers are loaded and that the driver parameters match the configuration of the network controller. Be sure that the correct network client and protocol is installed.
The network controller is not configured for this computer.	Select the <b>Network and Sharing Center</b> icon in the <b>Control Panel</b> , and configure the network controller. To access Control Panel in Windows 10, type <code>control panel</code> in the taskbar search box, and then select <b>Control Panel</b> from the list of applications.

## Network controller stopped working when an expansion board was added to the computer

Use this information to troubleshoot the computer.

Cause	Solution
The network controller requires drivers.	Verify that the drivers were not accidentally deleted when the drivers for a new expansion board were installed.

## Network controller stops working without apparent cause

Use this information to troubleshoot the computer.

Cause	Solution
<b>The cable is not securely connected.</b>	Be sure that the cable is securely attached to the network connector, and that the other end of the cable is securely attached to the correct device.
<b>The network controller is defective.</b>	Contact an authorized service provider.

## Cannot connect to network server when attempting remote system installation

Use this information to troubleshoot the computer.

Cause	Solution
<b>The network controller is not configured properly.</b>	Verify network connectivity, that a DHCP Server is present, and that the Remote System Installation Server contains the network interface card (NIC) drivers for your NIC.

## System setup utility reports unprogrammed EEPROM

Use this information to troubleshoot the computer.

Cause	Solution
<b>Unprogrammed EEPROM.</b>	Contact an authorized service provider.

## Solving memory problems

If you encounter memory problems, some common causes and solutions are listed in these tables.

 **IMPORTANT:** Power can still be supplied to the DIMMs when the computer is turned off (depending on the Management Engine (ME) settings). To avoid damage to the DIMMs or the system board, you must unplug the computer power cord before attempting to reseal, install, or remove a memory module.

For those systems that support ECC memory, HP does not support mixing ECC and non-ECC memory. Otherwise, the computer will not boot the operating system.

 **NOTE:** The memory count will be affected by configurations with the Management Engine (ME) enabled. The ME uses 8 MB of system memory in single-channel mode or 16 MB of memory in dual-channel mode to download, decompress, and execute the ME firmware for Out-of-Band (OOB), third-party data storage, and other management functions.

## System will not boot or does not function properly after installing additional memory modules

Use this information to troubleshoot the computer.



Cause	Solution
<b>A memory module is not installed in the DIMM1 or XMM1 socket.</b>	Verify that a memory module is installed in the DIMM1 or XMM1 socket on the system board. This socket must be populated with a memory module.
<b>Memory module is not the correct type or speed grade for the system, or the new memory module is not seated properly.</b>	Replace module with the correct industry-standard device for the computer. On some models, ECC and non-ECC memory modules cannot be mixed.

## Out of memory error

Use this information to troubleshoot the computer.

Cause	Solution
<b>You have run out of memory to run the application.</b>	Check the application documentation to determine the memory requirements.

## Memory count during POST is wrong

Use this information to troubleshoot the computer.

Cause	Solution
<b>The memory modules might not be installed correctly.</b>	Check that the memory modules have been installed correctly and that proper modules are used.
<b>Integrated graphics might use system memory.</b>	No action required.

## Insufficient memory error during operation.

Use this information to troubleshoot the computer.

Cause	Solution
<b>Too many Terminate and Stay Resident programs (TSRs) are installed.</b>	Delete any TSRs that you do not need.
<b>You have run out of memory for the application.</b>	Check the memory requirements for the application or add more memory to the computer.

## Power light blinks red five times followed by a two-second pause and the computer beeps five times (Beeps stop after fifth iteration but lights continue blinking)

Use this information to troubleshoot the computer.

Cause	Solution
<b>Memory is installed incorrectly or is bad.</b>	<ol style="list-style-type: none"> <li>1. Reseat DIMMs. Turn on the system.</li> <li>2. Replace DIMMs one at a time to isolate the faulty module.</li> <li>3. Replace third-party memory with HP memory.</li> </ol>

Cause	Solution
	4. Replace the system board.

## Solving USB flash drive problems

If you encounter USB flash drive problems, common causes and solutions are listed in these tables.

### USB flash drive is not seen as a drive letter in Windows

Use this information to troubleshoot the computer.

Cause	Solution
<b>The drive letter after the last physical drive is not available.</b>	Change the default drive letter for the flash drive in Windows.

### USB flash drive not found (identified)

Use this information to troubleshoot the computer.

Cause	Solution
<b>The device is attached to a USB port that has been hidden in Computer Setup.</b>	Run the Computer Setup utility and enable USB ports in <b>Advanced &gt; Port Options</b> .
<b>The device was not properly seated before startup.</b>	Be sure that the device is fully inserted into the USB port before applying power to the system

### System will not boot from USB flash drive

Use this information to troubleshoot the computer.

Cause	Solution
<b>Boot order is not correct.</b>	Run the Computer Setup utility, and change boot sequence in <b>Advanced &gt; Boot Options</b> .
<b>Removable Media Boot is disabled in the Computer Setup utility.</b>	Run the Computer Setup utility, and enable booting to removable media in <b>Advanced &gt; Boot Options</b> . Be sure that USB is enabled in <b>Storage &gt; Boot Order</b> .

### The computer boots to DOS after making a bootable flash drive

Use this information to troubleshoot the computer.

Cause	Solution
<b>Flash drive is bootable.</b>	Install the flash drive only after the operating system boots.
<b>Flash drive is defective.</b>	Try a different flash drive.

# Solving internet access problems

If you encounter internet access problems, consult your internet service provider (ISP), or see the common causes and solutions listed in these tables.

## Unable to connect to the internet

Use this information to troubleshoot the computer.

Cause	Solution
<b>Internet Service Provider (ISP) account is not set up properly.</b>	Verify Internet settings, or contact your ISP for assistance.
<b>Web browser is not set up properly.</b>	Verify that the web browser is installed, and set up to work with your ISP.
<b>Cable/DSL modem is not plugged in.</b>	Plug in cable/DSL modem. You should see a power light on the front of the cable/DSL modem.
<b>Cable/DSL service is not available or has been interrupted due to bad weather.</b>	Try connecting to the internet at a later time or contact your ISP. (If the cable/DSL service is connected, the cable light on the front of the cable/DSL modem will be on.)
<b>The CAT5 UTP cable is disconnected.</b>	Connect the CAT5 UTP cable between the cable modem and the computer's RJ-45 connector. (If the connection is good, the PC light on the front of the cable/DSL modem will be on.)
<b>IP address is not configured properly.</b>	Contact your ISP for the correct IP address.
<b>Cookies are corrupted. (A "cookie" is a small piece of information that a web server can store temporarily with the web browser. This is useful for having the browser remember some specific information that the Web server can later retrieve.)</b>	<ol style="list-style-type: none"><li>1. Type <code>control panel</code> in the taskbar search box, and then select <b>Control Panel</b> from the list of applications.</li><li>2. Click <b>Internet Options</b>.</li><li>3. In the <b>Browsing history</b> section, click the <b>Delete</b> button.</li><li>4. Select the <b>Cookies and website data</b> check box, and click the <b>Delete</b> button.</li></ol>

## Cannot automatically launch internet programs

Use this information to troubleshoot the computer.

Cause	Solution
<b>You must log on to your ISP before some programs will start.</b>	Log on to your ISP and launch the program.

# Solving software problems

Most software problems occur as a result of these situations.

- The application was not installed or configured correctly.
- There is insufficient memory available to run the application.
- There is a conflict between applications.

- All the necessary device drivers might not have been installed.
- If you have installed an operating system other than the factory-installed operating system, it might not be supported on the system.

If you encounter software problems, see the applicable solutions listed in the following table.

## Computer will not start up and the HP logo does not appear

Use this information to troubleshoot the computer.

Cause	Solution
<b>ROM issue - POST error has occurred.</b>	Observe the beeps and lights on the front of the computer. See the Worldwide Limited Warranty for terms and conditions.

## “Illegal Operation has Occurred” error message is displayed

Use this information to troubleshoot the computer.

Cause	Solution
<b>Software being used is not Microsoft-certified for your version of Windows.</b>	Verify that the software is certified by Microsoft for your version of Windows (see program packaging for this information).
<b>Configuration files are corrupt.</b>	If possible, save all data, close all programs, and restart the computer.

---

## 6 Computer Setup (F10) Utility

This information provides details of the Computer Setup Utility.

- Change settings from the defaults or restore the settings to default values.
- View the system configuration, including settings for processor, graphics, memory, audio, storage, communications, and input devices.
- Modify the boot order of bootable devices such as hard drives or USB flash media devices.
- Enter the Asset Tag or property identification number assigned by the company to this computer.
- Enable the power-on password prompt during system restarts (warm boots) as well as during startup.
- Establish an administrator password that controls access to the Computer Setup (F10) Utility and the settings described in this section.
- Establish minimum requirements for valid passwords, including length and required types of characters.
- Secure integrated I/O functionality, including the serial, USB, or audio, or embedded NIC, so that they cannot be used until they are unsecured.
- Enable or disable different types of boot sources.
- Configure features such as Secure Boot, power management, virtualization support, and language and keyboard type used in Setup and POST.
- Replicate the system setup by saving system configuration information about a USB device and restoring it on one or more computers.
- Enable or disable DriveLock security or securely erase a hard drive (when supported by drive).

### Using Computer Setup (F10) Utilities

You can access Computer Setup only by turning the computer on or restarting the system.

To access the Computer Setup Utilities menu, complete these steps:

1. Turn on or restart the computer.
2. Repeatedly press **f10** when the power button light turns white to access the utility.

You can also press **esc** to see a menu that allows you to access different options available at startup, including the Computer Setup utility.

A choice of four headings appears in the Computer Setup Utilities menu: Main, Security, Advanced, and UEFI Drivers.

---

 **NOTE:** If you do not press **f10** at the appropriate time, you must restart the computer and again repeatedly press **f10** when the power button light turns white to access the utility.

 **NOTE:** Selecting UEFI Drivers restarts the computer into the third-party option ROM management application. You can access this application directly by pressing **f3** during startup.

---

3. Use the arrow (left and right) keys to select the appropriate heading. Use the arrow (up and down) keys to select the option you want, and then press **enter**. To return to the Computer Setup Utilities menu, press **esc**.
4. To apply and save changes, select **Main > Save Changes and Exit**.
  - If you have made changes that you do not want applied, select **Ignore Changes and Exit**.
  - To restore settings from the Advanced and Main menus to original values, select **Apply Factory Defaults and Exit**.
  - To restore settings from the Advanced and Main menus to those previously saved by **Save Custom Defaults**, select **Apply Custom Defaults and Exit**. If no custom defaults have been saved, then factory defaults are used.

---

 **NOTE:** You cannot modify settings in the Security menu by selecting **Apply Defaults**. You reset those values by selecting **Restore Security Settings to Factory Defaults** at the bottom of the **Security** menu.

 **NOTE:** Not all settings shown in the following sections are available for all models.

---

 **IMPORTANT:** Do not turn computer power off while the BIOS is saving the Computer Setup (F10) changes because the settings could become corrupted. It is safe to turn off the computer only after exiting the F10 Setup screen.

---

## Computer Setup—Main

This table provides information about the Computer Setup Main menu.

 **NOTE:** Support for specific Computer Setup options can vary, depending on the hardware configuration.

---

**Table 6-1 Computer Setup—Main**

Option	Description
<b>System Information</b>	Lists all information in following list if <b>Advanced System Information</b> is selected. Lists smaller subset if <b>Basic System Information</b> is selected. <ul style="list-style-type: none"> <li>• Product name</li> <li>• Installed memory size</li> <li>• Processor type</li> <li>• Processor cache size (L1/L2/L3)</li> <li>• Processor speed</li> <li>• MicroCode revision</li> <li>• Processor stepping</li> <li>• Memory speed</li> <li>• DIMM size (for each installed module)</li> <li>• System BIOS version</li> <li>• ME Firmware version (Intel only)</li> <li>• Video BIOS version</li> <li>• Reference code revision</li> <li>• Super I/O firmware version</li> <li>• USB Type-C controller firmware version</li> </ul>

**Table 6-1 Computer Setup—Main (continued)**

Option	Description
	<ul style="list-style-type: none"> <li>• Born on date</li> <li>• Serial number</li> <li>• SKU number</li> <li>• UUID (Universally Unique Identifier)</li> <li>• Asset tracking number</li> <li>• Feature byte</li> <li>• Build ID</li> <li>• Product family</li> <li>• System board ID</li> <li>• System board CT number</li> <li>• Panel type</li> <li>• Panel serial number</li> <li>• Integrated MAC Address</li> </ul>
<b>System Diagnostics</b>	<p>If the hard drive has the HP Advanced Diagnostics installed, the application launches. If HP Advanced Diagnostics is not installed, then a basic version that is built into the BIOS provides the capability to perform the following functions:</p> <ul style="list-style-type: none"> <li>• Memory Test</li> <li>• Hard Drive Check</li> <li>• Language</li> </ul>
<b>Update System BIOS</b>	<p>Lets you update the system BIOS from <a href="http://www.hp.com">www.hp.com</a> or another network server, from a removable USB drive, or from a file located on the hard drive.</p> <ul style="list-style-type: none"> <li>• Check [current selection] for BIOS Updates <ul style="list-style-type: none"> <li>The string that appears here depends on the setting in <b>BIOS Update Preferences</b>.</li> </ul> </li> <li>• Lock BIOS Version <ul style="list-style-type: none"> <li>If this option is selected, the system is locked to the current BIOS version and, updates are not allowed.</li> </ul> </li> <li>• BIOS Rollback Policy <ul style="list-style-type: none"> <li>■ Unrestricted Rollback to older BIOS—Lets you roll back to any previous version of BIOS.</li> <li>■ Restricted Rollback to older BIOS—If selected, <b>Minimum BIOS Version</b> becomes active, which lets you manually enter the minimum BIOS version that you can roll back to.</li> </ul> </li> <li>• Allow BIOS Updates Using a Network</li> <li>• BIOS Update Preferences <ul style="list-style-type: none"> <li>■ Check for Update on Next Reboot—Default is disabled.</li> <li>■ BIOS Source—Lets you select either <a href="http://HP.com">HP.com</a> or a custom URL. If <b>Custom URL</b> is selected, <b>Edit Custom URL</b> becomes active. HP recommends using a custom URL only for a managed IT environment.</li> <li>■ Automatic BIOS Update Setting <ul style="list-style-type: none"> <li>Allows configuration of a periodic check for updates:</li> </ul> </li> </ul> </li> </ul>

**Table 6-1 Computer Setup—Main (continued)**

Option	Description
	<p><b>NOTE:</b> If Microsoft Windows BitLocker Drive Encryption (BDE) is enabled, it must be temporarily suspended before the BIOS is flashed.</p> <ul style="list-style-type: none"> <li>■ Do not update</li> <li>■ Checking for updates and prompt the user to accept or reject the update at that time</li> <li>■ Checking for updates and install all new versions</li> <li>■ Checking for updates and install only new versions marked important</li> <li>■ BIOS Update Frequency <ul style="list-style-type: none"> <li>■ Daily</li> <li>■ Weekly</li> <li>■ Monthly (default)</li> </ul> </li> <li>● Network Configuration Settings</li> <li>● Update BIOS Using Local Media</li> </ul> <p>Lets you access files on either USB storage or the hard drive. The HP BIOS Update and Recovery application included in BIOS Softpaqs at <a href="http://www.hp.com">www.hp.com</a> copies the BIOS file to the correct location on the hard drive or USB device.</p>
<b>Change date and time</b>	Lets you update system date and time.
<b>Set machine unique data</b>	Allows you to set or view data that is unique to each machine, such as feature byte, build ID, serial number, SKU number, product family, system board CT number, and product name.
<b>System IDs</b>	Lets you set the following values: <ul style="list-style-type: none"> <li>● Asset Tracking Number</li> <li>● Ownership Tag</li> </ul>
<b>Replicated Setup</b>	<p><b>Backup current settings to USB device</b></p> <p>Saves system configuration to a formatted USB flash media device.</p> <p><b>Restore current settings from USB device</b></p> <p>Restores system configuration from a USB flash media device.</p>
<b>Save Custom Defaults</b>	Saves the current system configuration settings as the custom default set.
<b>Apply Custom Defaults and Exit</b>	Applies the custom default settings to the computer after rebooting. Does not apply to options in the <b>Security</b> menu.
<b>Apply Factory Defaults and Exit</b>	Restores the factory system configuration settings to the computer after rebooting. Does not apply to options in the <b>Security</b> menu.
<b>Ignore Changes and Exit</b>	Exits Computer Setup without applying or saving any changes.
<b>Save Changes and Exit</b>	Saves changes to current system configuration, exits Computer Setup, and reboots.
<b>Suppress POST errors</b>	Select to turn off any errors generated by Power On Self Test (POST) during boot up.

## Computer Setup—Security

This table provides information about the Computer Setup Security menu.



**NOTE:** Support for specific Computer Setup options can vary, depending on the hardware configuration.



**Table 6-2 Computer Setup—Security**

Option	Description
<b>Create BIOS Administrator Password</b>	<p>Lets you set and enable a BIOS administrator password, which controls access to the following features:</p> <ul style="list-style-type: none"> <li>• Setup Menu (F10)</li> <li>• Third Party Option ROM Management (F3)</li> <li>• Update system ROM</li> <li>• WMI commands that change system settings</li> <li>• BIOS Configuration Utility (BCU)</li> <li>• Alternative power-on password</li> </ul> <p><b>NOTE:</b> Creating a BIOS user disables the Fast Boot option.</p> <p><b>NOTE:</b> If the password is set, you must change Computer Setup options, update the BIOS, and make changes to certain plug and play settings under Windows.</p>
<b>Change BIOS Administrator Password</b> (This selection is active only if a BIOS administrator password is set.)	<p>Lets you change the BIOS administrator password.</p> <p>You must know the current password to be able to change it.</p>
<b>Create POST Power-On Password</b>	<p>The power-on password prompt appears after a power cycle or reboot. If the user does not enter the correct power-on password, the unit will not boot.</p>
<b>Change POST Power-On Password</b> (This selection is active only if a BIOS administrator password is set.)	<p>Lets you change the POST power-on password.</p> <p>You must know the current password to be able to change it.</p>
<b>Password Policies</b>	<p>Let you set the guidelines for a valid password. Options include:</p> <ul style="list-style-type: none"> <li>• Password minimum length</li> <li>• Requires at least one symbol</li> <li>• Requires at least one number</li> <li>• Requires at least one uppercase character</li> <li>• Requires at least one lowercase character</li> <li>• Allow spaces</li> </ul> <p><b>Clear Password Jumper</b></p> <p>Select <b>Honor</b> to allow or <b>Ignore</b> to not allow the absence of the password jumper to clear the passwords at boot up. Default is <b>Honor</b>.</p>
<b>Security Configuration</b>	<p><b>TPM Embedded Security</b></p> <ul style="list-style-type: none"> <li>• <b>TPM Specification Version</b> Displays the current TPM version.</li> <li>• <b>TPM Device</b> Lets you set the Trusted Platform Module as available or hidden.</li> <li>• <b>TPM State</b> Select to enable the TPM.</li> <li>• <b>ClearTPM</b></li> </ul>

**Table 6-2 Computer Setup—Security (continued)**

Option	Description
	<p>Select to reset the TPM to an unowned state. After the TPM is cleared, it is also turned off. To temporarily suspend TPM operations, turn the TPM off instead of clearing it.</p> <p><b>IMPORTANT:</b> Clearing the TPM resets it to factory defaults and turns it off. You will lose all created keys and data protected by those keys.</p> <ul style="list-style-type: none"> <li>● <b>TPM Activation Policy</b> <ul style="list-style-type: none"> <li>○ F1 to boot</li> <li>○ Allow user to reject</li> <li>○ No prompts</li> </ul> </li> </ul> <p><b>BIOS SureStart</b></p> <ul style="list-style-type: none"> <li>● Verify Boot Block on every boot—Select to enable HP SureStart.</li> <li>● BIOS Data Recovery Policy—Select Automatic or Manual to determine data recovery process. Manual recovery is intended only for situations when you want forensic analysis before HP SureStart recovery. When this policy is set to manual, HP SureStart will not correct any issues that are found until the local user enters the manual recovery key sequence. This can result in a computer that cannot boot until the manual recovery key sequence is entered.</li> <li>● Dynamic Runtime Scanning of Boot Block—Verifies the integrity of the BIOS boot block region several times each hour while the computer is running. Default is Enabled.</li> <li>● Sure Start BIOS Settings Protection—When enabled, HP Sure Start locks all critical BIOS settings and provides enhanced protection for these settings using nonvolatile (flash) memory. <ul style="list-style-type: none"> <li><b>NOTE:</b> An administrator password must be set to activate this setting.</li> </ul> </li> <li>● Enhanced HP Firmware Runtime Intrusion Prevention and Detection—Enables monitoring of HP system firmware executing out of main memory while the operating system is running. Any anomalies detected in HP system firmware that is active while the operating system is running will result in a Sure Start security event being generated.</li> <li>● Sure Start Security Event Policy—Controls HP Sure Start behavior upon identifying a critical security event (any modification to HP firmware) while the operating system is running. <ul style="list-style-type: none"> <li>– Log Event Only—HP Sure Start will log all critical security events in the HP Sure Start audio log within the HP Sure Start nonvolatile (flash) memory.</li> <li>– Log Event and notify user—In addition to logging all critical security events, HP Sure Start will notify the user within the operating system that a critical event has occurred.</li> <li>– Log Event and power off system—In addition to logging all critical security events, HP Sure Start turns off the computer upon detecting a HP Sure Start Security Event. Because of the potential for data loss, HP recommends this setting only in situations where security integrity of the system is a higher priority than the risk of potential data loss.</li> </ul> </li> </ul> <p><b>Smart Cover</b></p> <ul style="list-style-type: none"> <li>● Cover Removal Sensor (Disabled/Notify user/Administrator password)</li> </ul> <p>Lets you disable the cover sensor or configure what action is taken if the computer cover is removed. Default is Disabled.</p> <p><b>NOTE:</b> <b>Notify user</b> alerts the user with a POST error on the first boot after the sensor detects removal of the cover. If the password is set, <b>Administrator Password</b> requires that the password be entered to boot the computer if the sensor detects that the cover has been removed.</p> <p><b>Intel Software Guard Extensions (SGX)</b></p> <p>Intel SGX is a set of processor code instructions from that allows user-level code to allocate private regions of memory, that unlike normal process memory is also protected from processes running at higher privilege levels.</p>

**Table 6-2 Computer Setup—Security (continued)**

Option	Description
	<ul style="list-style-type: none"> <li>• Software control</li> <li>• Disable</li> <li>• Enable</li> </ul>
<b>Utilities</b>	<b>Hard Drive Utilities</b>
	<ul style="list-style-type: none"> <li>• <b>Save/Restore MBR of System Hard Drive</b> <p><b>NOTE:</b> Windows 10 systems are generally not formatted to include an Master Boot Record (MBR). Instead they use GUID Partition Table (GPT) format, which better supports large hard drives.</p> <p>Enabling this feature will save the MBR of the system hard drive. If the MBR gets changed, the user will be prompted to restore the MBR. Default is disabled.</p> <p>The MBR contains information needed to successfully boot from a disk and to access the data stored on the disk. Master Boot Record Security can prevent unintentional or malicious changes to the MBR, such as those caused by some viruses or by the incorrect use of certain disk utilities. It also allows you to recover the "last known good" MBR, should changes to the MBR be detected when the system is restarted.</p> <p><b>NOTE:</b> Most operating systems control access to the MBR of the current bootable disk; the BIOS cannot prevent changes that may occur while the operating system is running.</p> <p>Restores the backup Master Boot Record to the current bootable disk. Default is disabled.</p> <p>Only appears if all of the following conditions are true:</p> <ul style="list-style-type: none"> <li>– MBR security is enabled.</li> <li>– A backup copy of the MBR has been previously saved.</li> <li>– The current bootable disk is the same disk from which the backup copy was saved.</li> </ul> <p><b>IMPORTANT:</b> If you restoring a previously saved MBR after a disk utility or operating system modified the MBR, the data on the disk might become inaccessible. Only restore a previously saved MBR if you are confident that the current bootable disk's MBR has been corrupted or infected with a virus.</p> </li> <li>• <b>Save/Restore GPT of System Hard Drive</b> <p>Enabling this feature saves the GUID Partition Table (GPT) of the system hard drive. If the GPT is subsequently changed, the user is prompted to choose whether to restore GPT.</p> </li> <li>• <b>DriveLock/Automatic DriveLock</b> <p>Allows you to assign or modify a master or user password for hard drives. When this feature is enabled, the user is prompted to provide one of the DriveLock passwords during POST. If neither is successfully entered, the hard drive remains inaccessible until one of the passwords is successfully provided during a subsequent cold-boot sequence.</p> <p><b>NOTE:</b> This selection appears only when at least one drive that supports the DriveLock feature is attached to the system.</p> <p><b>IMPORTANT:</b> Be aware that these settings take place immediately. It is not necessary to save.</p> <p><b>IMPORTANT:</b> Be sure to document the DriveLock password. Losing a DriveLock password will render a drive permanently locked.</p> <p>After you select a drive, the following options are available:</p> <ul style="list-style-type: none"> <li>- <b>Set DriveLock Master Password.</b> Sets the drive's master password but does not enable DriveLock.</li> <li>- <b>Enable DriveLock.</b> Sets the drive's user password and enables DriveLock.</li> </ul> </li> <li>• <b>Secure Erase</b> <p>Lets you select a hard drive to completely erase.</p> </li> </ul>

**Table 6-2 Computer Setup—Security (continued)**

Option	Description
	<p>After you erase a hard drive with a program that uses Secure Erase firmware commands, no file recovery program, partition recovery program, or other data recovery method can extract data from the drive.</p> <ul style="list-style-type: none"> <li>• <b>Allow OPAL Hard Drive SED Authentication</b></li> </ul> <p>Default is disabled.</p>
<b>System Management Command</b>	Allows authorized personnel to reset security settings during a service event. Default is enabled.
<b>Restore Security Settings to Default</b>	This action resets security devices, clears BIOS passwords (not including DriveLock), and restores settings in the <b>Security menu</b> to factory defaults.

## Computer Setup—Advanced

This table provides information about the Computer Setup Advanced menu.



**NOTE:** Support for specific Computer Setup options can vary, depending on the hardware configuration.

**Table 6-3 Computer Setup—Advanced (for advanced users)**

Option	Heading
<b>Display Language</b>	Lets you select the language of the menus in F10 Setup and the keyboard layout.
<b>Scheduled Power-On</b>	This feature wakes the system when it is off at a specified date and time.
<b>Boot Options</b>	<p>Select the devices that the computer can boot from, as well as other options, including:</p> <ul style="list-style-type: none"> <li>• Startup Delay (sec). Enabling this feature adds a user-specified delay to the POST process. One purpose for the delay is to provide additional time to activate hotkeys such as <b>esc</b> for the Startup Menu or <b>f10</b> for Computer Setup.</li> <li>• Fast Boot—Default is enabled.</li> <li>• USB Storage Boot—Default is enabled.</li> <li>• Network (PXE) Boot—Default is enabled.</li> <li>• After Power Loss—Default is Power Off. <ul style="list-style-type: none"> <li>■ Power off—Causes the computer to remain off when power is restored.</li> <li>■ Power on—Causes the computer to turn on automatically as soon as power is restored.</li> <li>■ Previous state—Causes the computer to turn on automatically as soon as power is restored, if it was on when power was lost.</li> </ul> </li> </ul> <p><b>NOTE:</b> If the system is configured to Power On from Keyboard Ports (see Power Management Options), then this setting is forced to Power On.</p> <ul style="list-style-type: none"> <li>• Prompt on Memory Size Change. Default is enabled.</li> <li>• Prompt on Fixed Storage Change. Default is disabled.</li> <li>• Audio Alerts During Boot. Default is enabled. When disabled, most audible beeps from errors, warnings, and password prompts during boot up are suppressed.</li> <li>• UEFI Boot Order.</li> </ul> <p>Default is enabled. Specify the order in which UEFI boot sources (such as a internal hard drive, USB hard drive, USB optical drive, or internal optical drive) are checked for a bootable operating system image.</p>

**Table 6-3 Computer Setup—Advanced (for advanced users) (continued)**

Option	Heading
	<p>UEFI boot sources always have precedence over legacy boot sources.</p> <ul style="list-style-type: none"><li>• Legacy Boot Order</li></ul> <p>Specify the order in which legacy boot sources (such as a network interface card, internal hard drive, USB optical drive, or internal optical drive) are checked for a bootable operating system image.</p> <p>Specify the order of attached hard drives. The first hard drive in the order will have priority in the boot sequence and will be recognized as drive C (if any devices are attached).</p> <p><b>NOTE:</b> To drag a device to a preferred place, press <b>enter</b>.</p> <p><b>NOTE:</b> MS-DOS drive lettering assignments might not apply after a non-MS-DOS operating system has started.</p> <p><b>Shortcut to Temporarily Override Boot Order</b></p> <p>To boot <b>one time</b> from a device other than the default device specified in Boot Order, restart the computer and press <b>esc</b> (to access the Startup menu) and then <b>f9</b> (Boot Menu), or only <b>f9</b> (skipping the Startup menu) when the power button light turns white. After POST is completed, a list of bootable devices is displayed. Use the arrow keys to select the preferred bootable device and press <b>enter</b>. The computer then boots from the selected non-default device for this one time.</p>
<b>Secure Boot Configuration</b>	<p><b>Configure Legacy Support and Secure Boot</b></p> <p>Lets you turn off all legacy support on the computer, including booting to DOS, running legacy graphics cards, booting to legacy devices, and so on.</p> <p>Lets you be sure that an operating system is legitimate before booting to it, making Windows resistant to malicious modification from preboot to full operating system booting, preventing firmware attacks. UEFI and Windows Secure Boot only allow code signed by preapproved digital certificates to run during the firmware and OS boot process.</p> <ul style="list-style-type: none"><li>• Legacy Support Enable and Secure Boot Disable</li><li>• Legacy Support Disable and Secure Boot Enable</li><li>• Legacy Support Disable and Secure Boot Disable</li></ul> <p>Default is Legacy Support Disable and Secure Boot Disable.</p> <p><b>Secure Boot Key Management</b></p> <p>Lets you manage the custom key settings.</p> <p><b>Import Custom Secure Boot keys</b></p> <p>Default is disabled.</p> <p><b>Clear Secure Boot Keys</b></p> <p>Lets you delete any previously loaded custom boot keys. Clearing keys will disable secure boot. Default is disabled.</p> <p><b>Reset Secure Boot keys to factory defaults</b></p> <p>Default is disabled.</p> <p><b>Enable MS UEFI CA key</b></p> <p>Disabling this setting alters the Secure Boot key list to further restrict the allowed software components. Set this option to disable to support Device Guard.</p> <p><b>Ready BIOS for Device Guard Use</b></p> <p>Requires BIOS Administrator password to be configured and Secure Boot to be enabled.</p>
<b>System Options</b>	<b>Configure storage controller for Intel Optane</b>

**Table 6-3 Computer Setup—Advanced (for advanced users) (continued)**

Option	Heading
	<p>Enables the Intel® Optane™ memory module.</p> <p><b>Hyperthreading</b></p> <p>Lets you control processor capability. Default is enabled.</p> <p><b>Multi-processor</b></p> <p>Use this option to disable multi-processor support under the operating system. Default is enabled.</p> <p><b>Virtualization Technology (VTx) (Intel only)</b></p> <p>Controls the virtualization features of the processor. Changing this setting requires turning the computer off and then back on. Default is disabled.</p> <p><b>Virtualization Technology for Directed I/O (VTd) (Intel only)</b></p> <p>Controls virtualization DMA remapping features of the chipset. Changing this setting requires turning the computer off and then back on. Default is disabled.</p> <p><b>M.2 SSD</b></p> <p>Lets you disable the M.2 solid-state drive slot. Default is enabled.</p> <p><b>M.2 WLAN/BT</b></p> <p>Lets you disable the wireless module slot. Default is enabled.</p> <p><b>Allow PCIe/PCI SERR# Interrupt (enable/disable)</b></p> <p>Allows PCI devices to report PCI/PCIe System Error signals, such as address parity errors, data parity errors, and critical errors other than parity. Default is enabled.</p> <p><b>Power Button Override (disable/4 sec/15 sec)</b></p> <p>Lets you disable or enable and select the number of seconds you have to hold down the power button for it to force the system to turn off. Default is 4 sec.</p>
<b>Built-In Device Options</b>	<p><b>Embedded LAN Controller</b></p> <p>Select to show the device in the operating system. Default is enabled.</p> <p><b>Wake On LAN</b></p> <p>Lets you either disable the Wake On LAN feature or configure where the computer boots, including the network or hard drive. Default is Boot to Network.</p> <p><b>Allow No Panel configuration</b></p> <p>When enabled, POST blink and beep codes and error messages are not generated. Default is disabled.</p> <p><b>Video memory size</b></p> <p>Use this option to manage graphics memory allocation. The value you choose is allocated permanently to graphics and is unavailable to the operating system.</p> <p><b>Integrated Camera</b></p> <p>Clear to disable the integrated camera. Default is enabled.</p> <p><b>Audio Device</b></p> <p>Select to show the device in the operating system. Default is enabled.</p> <p><b>Integrated Microphone</b></p> <p>Clear to disable the integrated microphone. This does not affect devices plugged into audio jacks. Default is enabled.</p> <p><b>Internal Speakers (does not affect external speakers)</b></p>

**Table 6-3 Computer Setup—Advanced (for advanced users) (continued)**

Option	Heading
	<p>Clear to disable the chassis speaker or speakers. This function is applicable to normal audio playback in the operating system and does not affect the error or warning beeps during POST. Default is enabled.</p> <p><b>Headphone Output</b></p> <p>Clear to disable the headphone jack. Default is enabled.</p> <p><b>Collaboration Buttons</b></p> <p>Clear to disable the collaboration buttons. Default is enabled.</p> <p><b>Button Sensitivity</b></p> <p>Select from low, medium, or high. Default is low.</p> <p><b>LAN/WLAN auto switching</b></p> <p>Select to enable auto switching between a wired and wireless connection. Default is disabled.</p> <p><b>Wake on WLAN</b></p> <p>Select to enable wake on WLAN. Default is disabled.</p> <p><b>M.2 USB/Bluetooth</b></p> <p>Select to enable the M.2 controller. Default is enabled.</p> <p><b>Increase Idle Fan Speed(%)</b></p> <p>Sets idle fan speed percentage. This setting only changes the minimum fan speed. The fan is still automatically controlled.</p>
<b>Port Options</b>	<p><b>SATA0</b></p> <p>Lets you disable the connector. Default is enabled.</p> <p><b>SATA1</b></p> <p>Lets you disable the connector. Default is enabled.</p> <p><b>Rear USB ports</b></p> <p>Lets you disable the ports. Default is enabled.</p> <p><b>Right USB ports</b></p> <p>Lets you disable the ports. Default is enabled.</p> <p><b>USB Legacy Port Charging</b></p> <p>Lets you enable USB charging port capability when the computer is in hibernate or shutdown mode. Default is enabled.</p> <p><b>USB Type-C Downstream Charging</b></p> <p>Lets you enable USB charging port capability when the computer is in hibernate on or off. Default is enabled.</p> <p><b>Restrict USB Devices</b></p> <p>Specify the following categories of USB devices to enable:</p> <ul style="list-style-type: none"><li>• Allow all USB devices (default)</li><li>• Allow only keyboard and mouse</li><li>• Allow all but storage devices and hubs.</li></ul> <p>When some devices are restricted, the system will disable USB ports that do not meet the allowed criteria. This feature is usually combined with similar policies within the operating system because USB</p>

**Table 6-3 Computer Setup—Advanced (for advanced users) (continued)**

Option	Heading
	<p>devices can be moved to different ports. The ports disabled by the BIOS remain disabled until the system is restarted.</p> <p><b>USB Type-C Controller Firmware Update</b></p> <p>Default is enabled.</p>
<b>Option ROM Launch Policy</b>	<p>These policies control whether Legacy Option ROMs or UEFI drivers are loaded. Default is All UEFI.</p> <p><b>Configure Option ROM Launch Policy</b></p> <ul style="list-style-type: none"> <li>• All legacy</li> <li>• All UEFI</li> <li>• All UEFI except video</li> </ul>
<b>Power Management Options</b>	<p><b>Runtime Power Management</b> (enable/disable)</p> <p>Allows certain operating systems to reduce processor voltage and frequency when the current software load does not require the full capabilities of the processor. Default is enabled.</p> <p><b>Extended Idle Power States</b> (enable/disable)</p> <p>Allows certain operating systems to decrease the processors power consumption when the processor is idle. Default is enabled.</p> <p><b>S5 Maximum Power Savings</b> (enable/disable)</p> <p>Enabling this feature reduces the power of the system as much as possible in the S5 state. Power is removed from the wake up circuitry, the expansion slots, and any management features while in S5. Default is disabled.</p> <p><b>SATA Power Management</b> (enable/disable)</p> <p>Enables or disables SATA bus, device power management, or both. Default is enabled.</p> <p><b>PCI Express Power Management</b> (enable/disable)</p> <p>Enabling this option permits the PCI Express links to use Active Power State Management (ASPM) to enter lower power states while not in use. Default is enabled.</p> <p><b>Power On from Keyboard Ports</b> (enable/disable)</p> <p>When enabled, this feature allows a key press to turn on the system when it is off (S5 state). If using a USB keyboard, you must plug it into one of the rear ports labeled with the keyboard icon. Default is disabled.</p> <p><b>Unique Sleep State Blink Rates</b> (enable/disable)</p> <p>This feature is designed to provide a visual indication of what Sleep state the system is in. Each Sleep state has a unique blink pattern. Default is disabled.</p> <p><b>NOTE:</b> A normal shutdown goes to the S4 state for Windows 8 or later.</p> <p>S0 (On) = solid white light.</p> <p>S3 (Stand By) = 3 blinks at 1 Hz (50% duty cycle) followed by a pause of 2 seconds (white light), repeated cycles of 3 blinks and a pause.</p> <p>S4 (Hibernation) = 4 blinks at 1 Hz (50% duty cycle) followed by a pause of 2 seconds (white light), repeated cycles of 4 blinks and a pause.</p> <p>S5 (Soft Off) = Light is off.</p>
<b>Electronic labels</b>	<p>Displays system labels.</p>
<b>Remote Management Options</b>	<p><b>Active Management (AMT)</b> (Intel only) (enable/disable). Default is enabled.</p> <p>Allows you to discover, repair, and protect networked computing devices.</p>



**Table 6-3 Computer Setup—Advanced (for advanced users) (continued)**

Option	Heading
	<b>USB Key Provisioning Support</b> (enable/disable) Default is disabled.
	<b>USB Redirection Support</b> (enable/disable). Default is enabled.
	USB redirection allows USB devices plugged into a client computer to be transparently redirected to the guest operating system.
	<b>Unconfigure AMT on next boot</b> (Do Not Apply/Apply). Default is Do Not Apply.
	<b>SOL Terminal Emulation Mode</b> (ANSI / VT100). Default is ANSI.
	SOL (serial-over-LAN) terminal emulation mode is only activated during remote AMT (Active Management Technology) redirection operations. The emulation options allow administrators to select which mode works best with their console.
	<b>Show Unconfigure ME Confirmation Prompt</b> (enable/disable). Default is enabled.
	<b>Verbose Boot Messages</b> (enable/disable). Default is enabled.
	Verbose boot shows additional logging information during startup, which is mainly for debugging if something goes wrong during bootup.
	<b>Watchdog Timer</b> (enable/disable). Default is enabled.
	Allows you to set amount of time for a operating system and BIOS watchdog alert to be sent if the timers are not deactivated. BIOS watchdog is deactivated by BIOS and would indicate that a halt occurred during execution if the alert is sent to the management console. An operating system alert is deactivated by the operating system image and would indicate that a hang occurred during its initialization.
	<ul style="list-style-type: none"><li>• OS Watchdog Timer (min.) – (5/10/15/20/25). Default is 5 min.</li><li>• BIOS Watchdog Timer (min.) – (5/10/15/20/25). Default is 5 min.</li></ul>
	<b>CIRA Timeout (min.)</b> (1/2/3/4/Never)
	CIRA is Customer Initiated Remote Assistance, an Intel service to help users employing Active Management Technology (AMT).



# 7 POST error messages

This section lists the error codes, error messages, and the various indicator light and audible sequences that you may encounter during Power-On Self-Test (POST) or computer restart, the probable source of the problem, and steps you can take to resolve the error condition.

POST Message Disabled suppresses most system messages during POST, such as memory count and non-error text messages. If a POST error occurs, the screen will display the error message. To manually switch to the POST Messages Enabled mode during POST, press any key (except **f10**, **f11**, or **f12**). The default mode is POST Message Disabled.

The POST mode selection determines the speed at which the computer loads the operating system and the extent to which it is tested.

Quick Boot is a fast startup process that does not run all of the system level tests, such as the memory test. Full Boot runs all of the ROM-based system tests and takes longer to complete.

You can enable Full Boot to run every 1 to 30 days on a regularly scheduled basis. To establish the schedule, reconfigure the computer to the Full Boot Every x Days mode, using Computer Setup.

 **NOTE:** For more information about Computer Setup, see [Computer Setup \(F10\) Utility on page 59](#).

## POST numeric codes and text messages

This section identifies those POST errors that have numeric codes associated with them. The section also includes some text messages that you might encounter during POST.

 **NOTE:** The computer beeps once after a POST text message is displayed on the screen.

**Table 7-1 POST numeric codes and text messages**

Control panel message	Description	Recommended action
101-Option ROM Checksum Error	System ROM or expansion board option ROM checksum.	<ol style="list-style-type: none"><li>1. Verify the correct ROM.</li><li>2. Flash the ROM if needed.</li><li>3. If an expansion board was recently added, remove it to see if the problem remains.</li><li>4. Clear CMOS.</li><li>5. If the message disappears, there might be a problem with the expansion card.</li><li>6. Replace the system board.</li></ol>
103-System Board Failure	DMA or timers.	<ol style="list-style-type: none"><li>1. Clear CMOS.</li><li>2. Replace the system board.</li></ol>
162-System Options Not Set	Configuration incorrect. RTC (real-time clock) battery might need to be replaced.	Run Computer Setup and check the configuration in <b>Advanced &gt; Onboard Devices</b> .

**Table 7-1 POST numeric codes and text messages (continued)**

Control panel message	Description	Recommended action
		Reset the date and time under <b>Control Panel</b> . If the problem persists, replace the RTC battery.
163-Time & Date Not Set	Invalid time or date in configuration memory.  RTC (real-time clock) battery may need to be replaced.	Reset the date and time under <b>Control Panel</b> (You can also use Computer Setup). If the problem persists, replace the RTC battery. See the Removal and Replacement section for instructions on installing a new battery, or contact an authorized dealer or reseller for RTC battery replacement.
163-Time & Date Not Set	CMOS jumper might not be properly installed.	Check for proper placement of the CMOS jumper if applicable.
164-MemorySize Error	Memory amount has changed since the last boot (memory added or removed).	Press the <b>F1</b> key to save the memory changes.
164-MemorySize Error	Memory configuration incorrect.	<ol style="list-style-type: none"> <li>1. Run Computer Setup or Windows utilities.</li> <li>2. Be sure the memory modules are installed properly.</li> <li>3. If third-party memory has been added, test using HP-only memory.</li> <li>4. Verify proper memory module type.</li> </ol>
201-Memory Error	RAM failure.	<ol style="list-style-type: none"> <li>1. Be sure that memory modules are correctly installed.</li> <li>2. Verify proper memory module type.</li> <li>3. Remove and replace the identified faulty memory modules.</li> <li>4. If the error persists after replacing memory modules, replace the system board.</li> </ol>
213-Incompatible Memory Module in Memory Socket(s) X, X, ...	A memory module in memory socket identified in the error message is missing critical SPD information, or is incompatible with the chipset.	<ol style="list-style-type: none"> <li>1. Verify proper memory module type.</li> <li>2. Try another memory socket.</li> <li>3. Replace DIMM with a module conforming to the SPD standard.</li> </ol>
214-DIMM Configuration Warning	Populated DIMM Configuration is not optimized.	Rearrange the DIMMs so that each channel has the same amount of memory.
219-ECC Memory Module Detected ECC Modules not supported on this Platform	Recently added memory modules support ECC memory error correction.	<ol style="list-style-type: none"> <li>1. If additional memory was recently added, remove it to see if the problem remains.</li> <li>2. Check product documentation for memory support information.</li> </ol>
301-Keyboard Error	Keyboard failure.	<ol style="list-style-type: none"> <li>1. Reconnect keyboard with computer turned off.</li> <li>2. Check connector for bent or missing pins.</li> <li>3. Be sure that none of the keys are depressed.</li> </ol>

**Table 7-1 POST numeric codes and text messages (continued)**

Control panel message	Description	Recommended action
		4. Replace keyboard.
303-Keyboard Controller Error	I/O board keyboard controller.	1. Reconnect keyboard with computer turned off. 2. Replace the system board.
304-Keyboard or System Unit Error	Keyboard failure.	1. Reconnect the keyboard with computer turned off. 2. Be sure that none of the keys are depressed. 3. Replace the keyboard. 4. Replace the system board.
501-Display Adapter Failure	Graphics display controller.	1. Clear CMOS. 2. Verify that the monitor is attached and turned on.
510-Flash Screen Image Corrupted	Flash Screen image has errors.	Reflash the system ROM with the latest BIOS image.
512-Chassis, Rear Chassis, or Front Chassis Fan not Detected	Fan is not connected or might have malfunctioned.	1. Reseat fan. 2. Reseat fan cable. 3. Replace fan.
514-CPU or Chassis Fan not Detected	Fan is not connected or might have malfunctioned.	1. Reseat fan. 2. Reseat fan cable. 3. Replace fan.
660-Display cache is detected unreliable	Integrated graphics controller display cache is not working properly and will be disabled.	Replace system board if minimal graphics degrading is an issue.
1720-SMART Hard Drive Detects Imminent Failure	Hard drive will soon fail. (Some hard drives have a hard drive firmware patch that will fix an erroneous error message.)	1. Determine if hard drive is giving correct error message. Run the Drive Protection System test under <b>Using F2 Diagnostics</b> when booting the computer. 2. Apply hard drive firmware patch if applicable. (Available at <a href="http://www.hp.com/support">http://www.hp.com/support</a> .) 3. Back up contents and replace hard drive.
2212-USB Key Provisioning failure writing to device	USB device used for USB key provisioning will not allow BIOS to update provision file properly.	1. Try a different USB key device for provisioning. 2. If the error persists, update to the latest BIOS version and ME firmware version. 3. If the error still persists, replace the system board.
2217-ME Firmware Version request failure	ME firmware does not properly respond to BIOS query for version information.	1. Reboot the computer.

**Table 7-1 POST numeric codes and text messages (continued)**

Control panel message	Description	Recommended action
		<ol style="list-style-type: none"><li></li><li>2. If the error persists, update to the latest BIOS version and ME firmware version.</li><li>3. If the error still persists, replace the system board.</li></ol>
2218-ME Firmware Version should be updated	ME firmware must be updated to match current functionality contained in the system BIOS.	<ol style="list-style-type: none"><li>1. Update to the latest ME firmware version.</li><li>2. If the error persists and system BIOS has been recently updated, restore previous system BIOS version.</li><li>3. If the error still persists, replace the system board.</li></ol>
2219-USB Key Provisioning file has invalid header identifier	Provisioning file contained on the USB key has been corrupted or is not a valid version for the current ME firmware.	<ol style="list-style-type: none"><li>1. Recreate the provisioning file using third-party management console software.</li><li>2. If the error persists and system BIOS has been recently updated, restore previous system BIOS version. Otherwise, update the ME firmware version.</li><li>3. If the error still persists, replace the system board.</li></ol>
2220-USB Key Provisioning file has mismatch version	Provisioning file contained on the USB key is not a valid version for the current ME firmware.	<ol style="list-style-type: none"><li>1. Reboot the computer.</li><li>2. If the error persists and system BIOS has been recently updated, restore previous system BIOS version. Otherwise, update the ME firmware version.</li><li>3. If the error still persists, replace the system board.</li></ol>
Invalid Electronic Serial Number	Electronic serial number is missing.	Enter the correct serial number in Computer Setup.
Network Server Mode Active and No Keyboard Attached	Keyboard failure while Network Server Mode enabled.	<ol style="list-style-type: none"><li>1. Reconnect keyboard with computer turned off.</li><li>2. Check connector for bent or missing pins.</li><li>3. Be sure that none of the keys are depressed.</li><li>4. Replace keyboard.</li></ol>
Parity Check 2	Parity RAM failure.	Run Computer Setup and Diagnostic utilities.

# Interpreting POST diagnostic front panel lights and audible codes

This section identifies the front panel light codes as well as the audible codes that can occur before or during POST that might not have an error code or text message associated with them.

**CAUTION:** When the computer is plugged into an AC power source, voltage is always applied to the system board. To reduce the risk of personal injury from electrical shock and/or hot surfaces, be sure to disconnect the power cord from the AC outlet and allow the internal system components to cool before touching.

**NOTE:** If you see blinking lights on a PS/2 keyboard, look for blinking lights on the front panel of the computer and see the following table to determine the front panel light codes.

Recommended actions in the following table are listed in the order in which they should be performed.

Not all diagnostic lights and audible codes are available on all models.

**Table 7-2 Interpreting POST diagnostic front panel lights and audible codes**

Activity	Beeps	Possible cause	Recommended action
White power light on.	None	Computer on.	None
White power light blinks every two seconds.	None	Computer in Suspend to RAM mode (some models only) or normal Suspend mode.	None required. Press any key or move the mouse to wake the computer.
Red power light blinks two times, once every second, followed by a two-second pause. Beeps stop after fifth iteration, but lights continue until problem is solved.	2	Processor thermal protection activated:  A fan might be blocked or not turning.  OR  The heat sink and fan assembly is not properly attached to the processor.	<ol style="list-style-type: none"> <li>1. Be sure that the computer air vents are not blocked and that the cooling fan is running.</li> <li>2. Open hood, press power button, and see if the fan spins. If the processor fan is not spinning, be sure the fan's cable is plugged onto the system board header.</li> <li>3. If fan is plugged in but is not spinning, then replace fan.</li> <li>4. Contact an authorized reseller or service provider.</li> </ol>
Red power light blinks four times, once every second, followed by a two-second pause. Beeps stop after fifth iteration, but lights continue until problem is solved.	4	Power failure (power supply is overloaded).	<ol style="list-style-type: none"> <li>1. Check if a device is causing the problem by removing all attached devices. Power on the system. If the system enters the POST, then power off and replace one device at a time and repeat this procedure until failure occurs. Replace the device that is causing the failure. Continue adding devices one at a time to ensure all devices are functioning properly.</li> <li>2. Replace the power supply.</li> <li>3. Replace the system board.</li> </ol>
Red power light blinks five times, once every second, followed by a two-second pause. Beeps stop after fifth iteration, but lights continue until problem is solved.	5	Pre-video memory error.	<p><b>IMPORTANT:</b> To avoid damage to the DIMMs or the system board, you must unplug the computer power cord before attempting to reseat, install, or remove a DIMM module.</p> <ol style="list-style-type: none"> <li>1. Reseat DIMMs.</li> <li>2. Replace DIMMs one at a time to isolate the faulty module.</li> <li>3. Replace third-party memory with HP memory.</li> </ol>

**Table 7-2 Interpreting POST diagnostic front panel lights and audible codes (continued)**

Activity	Beeps	Possible cause	Recommended action
			4. Replace the system board.
Red power light blinks six times, once every second, followed by a two-second pause. Beeps stop after fifth iteration, but lights continue until problem is solved.	6	Pre-video graphics error.	Replace the system board.
Red power light blinks seven times, once every second, followed by a two-second pause. Beeps stop after fifth iteration, but lights continue until problem is solved.	7	System board failure (ROM detected failure prior to video).	Replace the system board.
Red power light blinks eight times, once every second, followed by a two-second pause. Beeps stop after fifth iteration, but lights continue until problem is solved.	8	Invalid ROM based on bad checksum.	<ol style="list-style-type: none"> <li>1. Reflash the system ROM with the latest BIOS image.</li> <li>2. Replace the system board.</li> </ol>
Red power light blinks nine times, once every second, followed by a two-second pause. Beeps stop after fifth iteration, but lights continue until problem is solved.	9	System turn on but cannot boot.	<ol style="list-style-type: none"> <li>1. Unplug the power cord from the computer, wait 30 s, then plug the power cord back in to the computer.</li> <li>2. Replace the system board.</li> </ol>
System does not turn on and lights are not blinking.	None	System cannot start.	<p>Press and hold the power button for less than 4 seconds. If the hard drive light turns white, the power button is working correctly.</p> <p>▲ Replace the system board.</p> <p>OR</p> <p>Press and hold the power button for less than 4 seconds. If the hard drive light does not turn on white then:</p> <ol style="list-style-type: none"> <li>1. Be sure that the unit is plugged into a working AC outlet.</li> <li>2. Replace the power supply.</li> </ol>



## 8 Password security and resetting CMOS

This computer supports two security password features that you can establish through the Computer Setup Utilities menu: administrator password and power-on password.

When you establish only an administrator password, any user can access all the information on the computer except Computer Setup. When you establish only a power-on password, the power-on password is required to access Computer Setup and any other information on the computer. When you establish both passwords, only the administrator password will give you access to Computer Setup.

When both passwords are set, you can use the administrator password in place of the power-on password as an override to log in to the computer. This feature is useful for a network administrator.



**IMPORTANT:** Back up the BIOS settings or save them as custom defaults in case you need them later. You can back up in Computer Setup or with the BiosConfigUtility tool available from [www.hp.com](http://www.hp.com). See [Computer Setup \(F10\) Utility on page 59](#) for information about backing up the BIOS settings.

### Changing a setup or power-on password

Use this procedure to change a password.

To change the power-on or setup password, complete the following steps:

1. Turn on or restart the computer.

To change the setup password, go to step 2.

To change the power-on password, go to step 3.

2. To change the setup password, as soon as the computer turns on:

- Press **esc** while the “Press the ESC key for Startup Menu” message is displayed.

- Press **f10** to enter Computer Setup.

3. When the key icon appears, type your current password, a slash (/) or alternate delimiter character, your new password, another slash (/) or alternate delimiter character, and your new password again as shown:

*current password/new password/new password*



**NOTE:** Type the new password carefully because the characters do not appear on the screen.

4. Press **enter**.

The new password will take effect the next time the computer is restarted.

### Deleting a setup or power-on password

Use this procedure to delete a password.

To delete the power-on or setup password, complete the following steps:

1. Turn on or restart the computer.

To delete the Setup password, go to step 2.

To delete the Power-on password, go to step 3.

2. To delete the Setup password, as soon as the computer turns on:
  - Press `esc` while the “Press the ESC key for Startup Menu” message is displayed.
  - Press `f10` to enter Computer Setup.
3. When the key icon appears, type your current password, a slash (/) or alternate delimiter character, your new password, another slash (/) or alternate delimiter character, and your new password again as shown:  
*current password/*
4. Press `enter`.

---

## 9 Backing up, restoring, and recovering

You can use Windows tools or HP software to back up your information, create a restore point, reset your computer, create recovery media, or restore your computer to its factory state. Performing these standard procedures can return your computer to a working state faster.

---

 **IMPORTANT:** If you will be performing recovery procedures on a tablet, the tablet battery must be at least 70% charged before you start the recovery process.

**IMPORTANT:** For a tablet with a detachable keyboard, connect the tablet to the keyboard base before beginning any recovery process.

---

### Backing up information and creating recovery media

These methods of creating recovery media and backups are available on select products only.

#### Using Windows tools for backing up

HP recommends that you back up your information immediately after initial setup. You can do this task either using Windows Backup locally with an external USB drive or using online tools.

---

 **IMPORTANT:** Windows is the only option that allows you to back up your personal information. Schedule regular backups to avoid information loss.

 **NOTE:** If computer storage is 32 GB or less, Microsoft System Restore is disabled by default.

---

#### Using the HP Cloud Recovery Download Tool to create recovery media (select products only)

You can use the HP Cloud Recovery Download Tool to create HP Recovery media on a bootable USB flash drive.

For details:

- ▲ Go to <http://www.hp.com/support>, search for HP Cloud Recovery, and then select the result that matches the type of computer that you have.

---

 **NOTE:** If you cannot create recovery media yourself, contact support to obtain recovery discs. Go to <http://www.hp.com/support>, select your country or region, and then follow the on-screen instructions.

 **IMPORTANT:** HP recommends that you follow the [Restoring and recovery methods on page 82](#) to restore your computer before you obtain and use the HP recovery discs. Using a recent backup can return your machine to a working state sooner than using the HP recovery discs. After the system is restored, reinstalling all the operating system software released since your initial purchase can be a lengthy process.

---

### Restoring and recovering your system

You have several tools available to recover your system both within and outside of Windows if the desktop cannot load.

HP recommends that you attempt to restore your system using the [Restoring and recovery methods on page 82](#).

## Creating a system restore

System Restore is available in Windows. The System Restore software can automatically or manually create restore points, or snapshots, of the system files and settings on the computer at a particular point.

When you use System Restore, it returns your computer to its state at the time you made the restore point. Your personal files and documents should not be affected.

## Restoring and recovery methods

After you run the first method, test to see whether the issue still exists before you proceed to the next method, which might now be unnecessary.

1. Run a Microsoft System Restore.
2. Run Reset this PC.
3. Recover using HP Recovery media. For more information, see [Recovering using HP Recovery media on page 82](#).

For more information about the first two methods, see the Get Help app:

Select the **Start** button, select the **Get Help** app, and then enter the task you want to perform.



---

**NOTE:** You must be connected to the internet to access the Get Help app.

---

## Recovering using HP Recovery media

You can use HP Recovery media to recover the original operating system and software programs that were installed at the factory. On select products, it can be created on a bootable USB flash drive using the HP Cloud Recovery Download Tool.

For details, see [Using the HP Cloud Recovery Download Tool to create recovery media \(select products only\) on page 81](#).



---

**NOTE:** If you cannot create recovery media yourself, contact support to obtain recovery discs. Go to <http://www.hp.com/support>, select your country or region, and then follow the on-screen instructions.

---

To recover your system:

- ▲ Insert the HP Recovery media, and then restart the computer.



---

**NOTE:** HP recommends that you follow the [Restoring and recovery methods on page 82](#) to restore your computer before you obtain and use the HP recovery discs. Using a recent backup can return your machine to a working state sooner than using the HP recovery discs. After the system is restored, reinstalling all the operating system software released since your initial purchase can be a lengthy process.

---

## Changing the computer boot order

If your computer does not restart using the HP Recovery media, you can change the computer boot order, the order of devices listed in BIOS for startup information. You can select an optical drive or a USB flash drive, depending on the location of your HP Recovery media.



---

**IMPORTANT:** For a tablet with a detachable keyboard, connect the tablet to the keyboard base before beginning these steps.

---

To change the boot order:

1. Insert the HP Recovery media.
2. Access the system **Startup** menu.
  - For computers or tablets with keyboards attached, turn on or restart the computer or tablet, quickly press **esc**, and then press **f9** for boot options.
  - For tablets without keyboards, turn on or restart the tablet, quickly press and hold the volume up button, and then select **f9**.  
– or –  
Turn on or restart the tablet, quickly press and hold the volume down button, and then select **f9**.
3. Select the optical drive or USB flash drive from which you want to boot, and then follow the on-screen instructions.

## Using HP Sure Recover (select products only)

Select computer models are configured with HP Sure Recover, a PC OS recovery solution built into the hardware and software. HP Sure Recover can fully restore the HP OS image without installed recovery software.

Using HP Sure Recover, an administrator or user can restore the system and install:

- Latest version of the operating system
- Platform-specific device drivers
- Software applications, in the case of a custom image

To access the latest documentation for HP Sure Recover, go to <http://www.hp.com/support>. Follow the on-screen instructions to find your product and locate your documentation.



---

# 10 Using HP PC Hardware Diagnostics

You can use the HP PC Hardware Diagnostics utility to determine whether your computer hardware is running properly. The three versions are HP PC Hardware Diagnostics Windows, HP PC Hardware Diagnostics UEFI (Unified Extensible Firmware Interface), and (for select products only) Remote HP PC Hardware Diagnostics UEFI, a firmware feature.

## Downloading the HP PC Hardware Diagnostics Windows from the Microsoft Store

You can download the HP PC Hardware Diagnostics Windows from the Microsoft Store.

1. Select the Microsoft Store app on your desktop or enter `Microsoft Store` in the taskbar search box.
2. Enter `HP PC Hardware Diagnostics Windows` in the **Microsoft Store** search box.
3. Follow the on-screen directions.

The tool downloads to the selected location.

## Customizing Remote HP PC Hardware Diagnostics UEFI settings

Using the Remote HP PC Hardware Diagnostics setting in Computer Setup (BIOS), you can perform several customizations.

- Set a schedule for running diagnostics unattended. You can also start diagnostics immediately in interactive mode by selecting **Execute Remote HP PC Hardware Diagnostics**.
- Set the location for downloading the diagnostic tools. This feature provides access to the tools from the HP website or from a server that has been preconfigured for use. Your computer does not require the traditional local storage (such as a hard drive or USB flash drive) to run remote diagnostics.
- Set a location for storing the test results. You can also set the user name and password that you use for uploads.
- Display status information about the diagnostics run previously.

To customize Remote HP PC Hardware Diagnostics UEFI settings, follow these steps:

1. Turn on or restart the computer, and when the HP logo appears, press **f10** to enter Computer Setup.
2. Select **Advanced**, and then select **Settings**.
3. Make your customization selections.
4. Select **Main**, and then **Save Changes and Exit** to save your settings.

Your changes take effect when the computer restarts.





# 11 Statement of memory volatility

For general information regarding nonvolatile memory in HP Business computers, and to restore nonvolatile memory that can contain personal data after the system has been turned off and the hard drive has been removed, use these instructions.

HP Business computer products that use Intel®-based or AMD®-based system boards contain volatile DDR memory. The amount of nonvolatile memory present in the system depends upon the system configuration. Intel-based and AMD-based system boards contain nonvolatile memory subcomponents as originally shipped from HP, with the following assumptions:

- No subsequent modifications were made to the system.
- No applications, features, or functionality were added to or installed on the system.

Following system shutdown and removal of all power sources from an HP Business computer system, personal data can remain on volatile system memory (DIMMs) for a finite period of time and also remains in nonvolatile memory. Use the following steps to remove personal data from the computer, including the nonvolatile memory found in Intel-based and AMD-based system boards.

---

 **NOTE:** If your tablet has a keyboard base, connect to the keyboard base before beginning steps in this chapter.

---

## Current BIOS steps

Use these instructions to restore nonvolatile memory.

1. Follow these steps to restore the nonvolatile memory that can contain personal data. Restoring or reprogramming nonvolatile memory that does not store personal data is neither necessary nor recommended.
  - a. Turn on or restart the computer, and then quickly press **esc**.

---

 **NOTE:** If the system has a BIOS administrator password, enter the password at the prompt.
  - b. Select **Main**, select **Apply Factory Defaults and Exit**, and then select **Yes** to load defaults. The computer restarts.
  - c. During the restart, press **esc** while the "Press the ESC key for Startup Menu" message is displayed at the bottom of the screen.

---

 **NOTE:** If the system has a BIOS administrator password, enter the password at the prompt.
  - d. Select the **Security** menu, select **Restore Security Settings to Factory Defaults**, and then select **Yes** to restore security level defaults. The computer reboots.
  - e. During the reboot, press **esc** while the "Press the ESC key for Startup Menu" message is displayed at the bottom of the screen.

---

 **NOTE:** If the system has a BIOS administrator password, enter the password at the prompt.
  - f. If an asset or ownership tag is set, select the **Security** menu and scroll down to the **Utilities** menu. Select **System IDs**, and then select **Asset Tracking Number**. Clear the tag, and then make the selection to return to the prior menu.

- g. If a DriveLock password is set, select the **Security** menu, and scroll down to **Hard Drive Utilities** under the **Utilities** menu. Select **Hard Drive Utilities**, select **DriveLock**, and then clear the check box for **DriveLock password on restart**. Select **OK** to proceed.
- h. Select the **Main** menu, and then select **Reset BIOS Security to factory default**. Click **Yes** at the warning message. The computer reboots.
- i. During the reboot, press **esc** while the "Press the ESC key for Startup Menu" message is displayed at the bottom of the screen.



---

**NOTE:** If the system has a BIOS administrator password, enter the password at the prompt.

---

- j. Select the **Main** menu, select **Apply Factory Defaults and Exit**, select **Yes** to save changes and exit, and then select **Shutdown**.
  - k. Reboot the system. If the system has a Trusted Platform Module (TPM), fingerprint reader, or both, one or two prompts will appear—one to clear the TPM and the other to Reset Fingerprint Sensor. Press or tap **f1** to accept or **f2** to reject.
  - l. Remove all power and system batteries for at least 24 hours.
2. Complete one of the following:
- Remove and retain the storage drive.  
– or –
  - Clear the drive contents by using a third-party utility designed to erase data from an SSD.  
– or –
  - Clear the contents of the drive by using the following BIOS Setup Secure Erase command option steps:

If you clear data using Secure Erase, you cannot recover it.

- a. Turn on or restart the computer, and then quickly press **esc**.
- b. Select the **Security** menu and scroll down to the **esc** menu.
- c. Select **Hard Drive Utilities**.
- d. Under **Utilities**, select **Secure Erase**, select the hard drive storing the data you want to clear, and then follow the on-screen instructions to continue.

– or –

Clear the contents of the drive using the following Disk Sanitizer commands steps:

- i. Turn on or restart the computer, and then quickly press **esc**.
- ii. Select the **Security** menu and scroll down to the **Utilities** menu.
- iii. Select **Hard Drive Utilities**.
- iv. Under **Utilities**, select **Disk Sanitizer**, select the hard drive with the data that you want to clear, and then follow the on-screen instructions to continue.



---

**NOTE:** The amount of time it takes for Disk Sanitizer to run can take several hours. Plug the computer into an AC outlet before starting.

---

# Nonvolatile memory usage

Use this table to troubleshooting nonvolatile memory usage.

**Table 11-1 Troubleshooting steps for nonvolatile memory usage**

Nonvolatile memory type	Amount (Size)	Does this memory store customer data?	Does this memory retain data when power is removed?	What is the purpose of this memory?	How is data entered into this memory?	How is this memory write-protected?
HP Sure Start flash (select models only)	8 MB	No	Yes	Provides protected backup of critical System BIOS code, EC firmware, and critical computer configuration data for select platforms that support HP Sure Start.  For more information, see <a href="#">Using HP Sure Start (select products only)</a> on page 92.	Data cannot be written to this device via the host processor. The content is managed solely by the HP Sure Start Embedded Controller.	This memory is protected by the HP Sure Start Embedded Controller.
Real Time Clock (RTC) battery backed-up CMOS configuration memory	256 bytes	No	Yes	Stores system date and time and noncritical data.	RTC battery backed-up CMOS is programmed using Computer Setup (BIOS), or by changing the Windows date & time.	This memory is not write-protected.
Controller (NIC) EEPROM	64 KB (not customer accessible)	No	Yes	Stores NIC configuration and NIC firmware.	NIC EEPROM is programmed using a utility from the NIC vendor that can be run from DOS.	A utility must be used to write data to this memory and is available from the NIC vendor. Writing data to this ROM in an inappropriate manner will render the NIC non-functional.
DIMM Serial Presence Detect (SPD) configuration data	256 bytes per memory module, 128 bytes programmable (not customer accessible)	No	Yes	Stores memory module information.	DIMM SPD is programmed by the memory vendor.	Data cannot be written to this memory when the module is installed in a computer. The specific write-protection method varies by memory vendor.
System BIOS	9 MB	Yes	Yes	Stores system BIOS code and computer configuration data.	System BIOS code is programmed at the factory. Code is updated when the system BIOS is updated. Configuration data and settings are entered using the Computer Setup (BIOS) or a custom utility.	<b>NOTE:</b> Writing data to this ROM in an inappropriate manner can render the computer non-functional.  A utility must be used for writing data to this memory and is available

**Table 11-1 Troubleshooting steps for nonvolatile memory usage (continued)**

Nonvolatile memory type	Amount (Size)	Does this memory store customer data?	Does this memory retain data when power is removed?	What is the purpose of this memory?	How is data entered into this memory?	How is this memory write-protected?
Intel Management Engine Firmware (present only in select Elite or Z models. For more information, go to <a href="http://www.hp.com/support">http://www.hp.com/support</a> . Select <b>Identify your product for manuals and specific product information</b> , and then follow the on-screen instructions.)	1.5 MB or 7 MB	Yes	Yes	Stores Management Engine Code, Settings, Provisioning Data and iAMT third-party data store.	Management Engine Code is programmed at the factory. Code is updated via Intel secure firmware update utility. Unique Provisioning Data can be entered at the factory or by an administrator using the Management Engine (MEBx) setup utility. The third-party data store contents can be populated by a remote management console or local applications that have been registered by an administrator to have access to the space.	on the HP website; go to <a href="http://www.hp.com/support">http://www.hp.com/support</a> . Select <b>Find your product</b> , and then follow the on-screen instructions.
Bluetooth flash (select products only)	2 megabits	No	Yes	Stores Bluetooth configuration and firmware.	Bluetooth flash is programmed at the factory. Tools for writing data to this memory are not publicly available but can be obtained from the silicon vendor.	A utility must be used for writing data to this memory and is made available through newer versions of the driver whenever the flash requires an upgrade.
802.11 WLAN EEPROM	4 kilobits to 8 kilobits	No	Yes	Stores configuration and calibration data.	802.11 WLAN EEPROM is programmed at the factory. Tools for writing data to this memory are not made public.	A utility must be used for writing data to this memory and is typically not made available to the public unless a firmware upgrade is necessary to address a unique issue.
Camera (select products only)	64 kilobits	No	Yes	Stores camera configuration and firmware.	Camera memory is programmed using a utility from the device manufacturer that can be run from Windows.	A utility must be used for writing data to this memory and is typically not made available to the public unless a firmware upgrade is necessary to address a unique issue.
Fingerprint reader (select products only)	512 KB flash	Yes	Yes	Stores fingerprint templates.	Fingerprint reader memory is programmed by user enrollment in HP ProtectTools Security Manager.	Only a digitally signed application can make the call to write to the flash.

# Questions and answers

Use this section to answer your questions about nonvolatile memory.

## 1. How can the BIOS settings be restored (returned to factory settings)?



**IMPORTANT:** The restore defaults feature does not securely erase any data on your hard drive. See question and answer 6 for steps to securely erase data.

The restore defaults feature does not reset the Custom Secure Boot keys. See question and answer 7 for information about resetting the keys.

- a. Turn on or restart the computer, and then quickly press `esc`.
- b. Select **Main**, and then select **Apply Factory Defaults and Exit**.
- c. Follow the on-screen instructions.
- d. Select **Main**, select **Save Changes and Exit**, and then follow the on-screen instructions.

## 2. What is a UEFI BIOS, and how is it different from a legacy BIOS?

The Unified Extensible Firmware Interface (UEFI) BIOS is an industry-standard software interface between the platform firmware and an operating system (OS). It replaces the older BIOS architecture but supports much of the legacy BIOS functionality.

Like the legacy BIOS, the UEFI BIOS provides an interface to display the system information and configuration settings and to change the configuration of your computer before an OS is loaded. BIOS provides a secure runtime environment that supports a Graphic User Interface (GUI). In this environment, you can use either a pointing device (touch screen, touchpad, pointing stick, or USB mouse) or the keyboard to navigate and make menu and configuration selections. The UEFI BIOS also contains basic system diagnostics.

The UEFI BIOS provides functionality beyond that of the legacy BIOS. In addition, the UEFI BIOS works to initialize the computer's hardware before loading and executing the OS; the runtime environment allows the loading and execution of software programs from storage devices to provide more functionality, such as advanced hardware diagnostics (with the ability to display more detailed system information) and advanced firmware management and recovery software.

HP has provided options in Computer Setup (BIOS) to allow you to run in legacy BIOS, if required by the operating system. Examples of this requirement would be if you upgrade or downgrade the OS.

## 3. Where is the UEFI BIOS located?

The UEFI BIOS is located on a flash memory chip. You must use a utility to write to the chip.

## 4. What kind of configuration data is stored on the DIMM Serial Presence Detect (SPD) memory module? How would this data be written?

The DIMM SPD memory contains information about the memory module, such as size, serial number, data width, speed and timing, voltage, and thermal information. This information is written by the module manufacturer and stored on an EEPROM. You cannot write to this EEPROM when the memory module is installed in a computer. Third-party tools do exist that can write to the EEPROM when the memory module is not installed in a computer. Various third-party tools are available to read SPD memory.

## 5. What is meant by “Restore the nonvolatile memory found in Intel-based system boards”?

This message relates to clearing the Real Time Clock (RTC) CMOS memory that contains computer configuration data.

## 6. How can the BIOS security be reset to factory defaults and erase the data?

---

 **IMPORTANT:** Resetting results in the loss of information.

These steps do not reset Custom Secure Boot Keys. See question and answer 7 for information about resetting the keys.

---

- a. Turn on or restart the computer, and then quickly press `esc`.
- b. Select **Main**, and then select **Reset Security to Factory Defaults**.
- c. Follow the on-screen instructions.
- d. Select **Main**, select **Save Changes and Exit**, and then follow the on-screen instructions.

#### 7. How can the Custom Secure Boot Keys be reset?

Secure Boot is a feature to ensure that only authenticated code can start on a platform. If you enabled Secure Boot and created Custom Secure Boot Keys, disabling Secure Boot does not clear the keys. You must also select to clear the Custom Secure Boot Keys. Use the same Secure Boot access procedure that you used to create the Custom Secure Boot Keys, but select to clear or delete all Secure Boot Keys.

- a. Turn on or restart the computer, and then quickly press `esc`.
- b. Select the **Security** menu, select **Secure Boot Configuration**, and then follow the on-screen instructions.
- c. At the **Secure Boot Configuration** window, select **Secure Boot**, select **Clear Secure Boot Keys**, and then follow the on-screen instructions to continue.

## Using HP Sure Start (select products only)

Select computer models are configured with HP Sure Start, a technology that continuously monitors your computer's BIOS for attacks or corruption.

If the BIOS becomes corrupted or is attacked, HP Sure Start restores the BIOS to its previously safe state, without user intervention. Those select computer models ship with HP Sure Start configured and enabled. HP Sure Start is configured and already enabled so that most users can use the HP Sure Start default configuration. Advanced users can customize the default configuration.

To access the latest documentation on HP Sure Start, go to <http://www.hp.com/support>.

# 12 Power cord set requirements

The power supplies on some computers have external power switches.

The voltage select switch feature on the computer permits it to operate from any line voltage of 100 V ac–120 V ac or 220 V ac–240 V ac. Power supplies on those computers that do not have external power switches are equipped with internal switches that sense the incoming voltage and automatically switch to the proper voltage.

The power cord set received with the computer meets the requirements for use in the country where you purchased the equipment.

Power cord sets for use in other countries must meet the requirements of the country where you use the computer.

## General requirements

These requirements are applicable to all countries.

1. The power cord must be approved by an acceptable accredited agency responsible for evaluation in the country where the power cord set will be installed.
2. The power cord set must have a minimum current capacity of 10A (7A Japan only) and a nominal voltage rating of 125 V ac or 250 V ac, as required by each country's power system.
3. The diameter of the wire must be a minimum of 0.75 mm<sup>2</sup> or 18AWG, and the length of the cord must be between 1.8 m (6 ft) and 3.6 m (12 ft).

The power cord should be routed so that it is not likely to be walked on or pinched by items placed upon it or against it. Particular attention should be paid to the plug, electrical outlet, and the point where the cord exits from the product.

 **WARNING!** Do not operate this product with a damaged power cord set. If the power cord set is damaged in any manner, replace it immediately.

## Japanese power cord requirements

For use in Japan, use only the power cord received with this product.

 **IMPORTANT:** Do not use the power cord received with this product on any other products.

## Country-specific requirements

This information provides additional requirements specific to a country.

**Table 12-1 Power cord country-specific requirements**

Country	Accrediting Agency	Country	Accrediting Agency
Australia (1)	EANSW	Italy (1)	IMQ
Austria (1)	OVE	Japan (3)	METI
Belgium (1)	CEBC	Norway (1)	NEMKO

**Table 12-1 Power cord country-specific requirements (continued)**

<b>Country</b>	<b>Accrediting Agency</b>	<b>Country</b>	<b>Accrediting Agency</b>
Canada (2)	CSA	Sweden (1)	SEMKO
Denmark (1)	DEMKO	Switzerland (1)	SEV
Finland (1)	SETI	United Kingdom (1)	BSI
France (1)	UTE	United States (2)	UL
Germany (1)	VDE		

1. The flexible cord must be Type H05VV-F, 3-conductor, 0.75mm<sup>2</sup> conductor size. Power cord set fittings (appliance coupler and plug) must bear the certification mark of the agency responsible for evaluation in the country where it will be used.
2. The flexible cord must be Type SVT or equivalent, No. 18 AWG, 3 conductor. The plug must be a 2-pole grounding type with a NEMA 5-15P (15 A, 125 V) or NEMA 6-15P (15 A, 250 V) configuration.
3. Appliance coupler, flexible cord, and plug must bear a T mark and registration number in accordance with the Japanese Dentori Law. Flexible cord must be Type VCT or VCTF, 3-conductor, 0.75 mm<sup>2</sup> conductor size. Plug must be a 2-pole grounding type with a Japanese Industrial Standard C8303 (7 A, 125 V) configuration.



# 13 Specifications

This section provides specifications for your computer.

**Table 13-1 Specifications**

	<b>Metric</b>	<b>U.S.</b>
<b>Dimensions</b>		
Height	175 mm	6.9 in
Width	177 mm	7.0 in
Depth	34 mm	1.3 in
<b>Approximate weight</b>	1.45 kg	3.2 lb
<b>Temperature range</b>		
Operating	10°C to 35°C	50°C to 95°F
Nonoperating	-30°F to 60°C	-22°F to 140°F
<b>NOTE:</b> Operating temperature is derated 1.0°C per 300 m (1000 ft) to 3000 m (10,000 ft) above sea level; no direct sustained sunlight. Maximum rate of change is 10° C/Hr. The upper limit might be limited by the type and number of options installed.		
<b>Maximum altitude (unpressurized)</b>		
Operating	3,048 m	10,000 ft
Nonoperating	9,144 m	30,000 ft
<b>Relative humidity (noncondensing)</b>		
Operating	10% to 90%	
Nonoperating (38.7°C max wet bulb)	5% to 95%	
<b>Power supply</b>		
Operating voltage range	90 V ac to 264 V ac	
Rated voltage range <sup>1</sup>	100 V ac to 240 V ac	
Rated line frequency	50 Hz to 60 Hz	
Operating line frequency	47 Hz to 63 Hz	
<b>Standard efficiency</b>	65 W, 87% efficient	

<sup>1</sup> This system uses an active power factor-corrected power supply. This allows the system to pass the CE mark requirements for use in the countries of the European Union. The active power factor-corrected power supply also has the added benefit of not requiring an input-voltage range select switch.



# Index

## A

- access panel
  - illustrated 3
  - locked 40
  - removal and replacement 17
- Advanced menu, Computer Setup 66
- ambient sensor
  - removal and replacement 29
- audible codes 77
- audio problems 47

## B

- backup, creating 81
- backups 81
- battery
  - disposal 9, 13, 15
  - replacement 27
- beep codes 77
- blinking lights 77
- boot order, changing 82
- booting options
  - Full Boot 73
  - Quick Boot 73

## C

- cable management 9, 15
- cable pinouts, SATA data 9, 15
- changing a Power-On password 79
- changing a Setup password 79
- cleaning
  - computer 9, 12
  - mouse 9, 12, 13
  - safety precautions 9, 12
- CMOS
  - clearing and resetting 79
- computer cleaning 9, 12
- Computer Setup
  - access problem 40
  - Advanced menu 66
  - Main menu 60
  - Security menu 62
- Computer Setup Utility 59
- country power cord set requirements 93

Customer Support 39

## D

- deleting a Power-On password 79
- deleting a Setup password 79

## E

- electrostatic discharge (ESD) 9
  - preventing damage 9, 10
- error
  - codes 73, 77
- error messages 73

## F

- F10 Setup 59
  - access problem 40
- fan
  - illustrated 3
  - removal and replacement 22
- flash drive problems 56
- flex I/O connector board #1
  - removal and replacement 30
- flex I/O connector board #2
  - removal and replacement 31
- front bezel
  - illustrated 3
  - removal and replacement 18
- front panel components 1

## G

- general problems 40
- grounding methods 9, 10

## H

- hard drive
  - proper handling 9, 13, 14
  - removal 23
  - SATA characteristics 9, 15
- hard drive cage
  - removal 23
- hard drive problems 45
- hard drives 6
- hardware installation problems 50
- heat sink
  - removal and replacement 31

- heat sink with fan
  - illustrated 3
- helpful hints 40
- HP PC Hardware Diagnostics Windows
  - downloading 85
- HP Recovery media
  - recovery 82
- HP Sure Recover 83
- HP Sure Start 87, 92

## I

- illustrated parts catalog 3
- installing
  - battery 27
  - memory 19
- internet access problems 57

## K

- keyboard
  - cleaning 9, 12, 13
- keyboard problems 49

## L

- lights
  - blinking PS/2 keyboard 77

## M

- Main menu, Computer Setup 60
- mass storage devices 6
- memory
  - nonvolatile 87
  - problems 54
  - removal and replacement 19
  - socket population 19
  - specifications 19
  - volatile 87
- memory module
  - illustrated 3
  - installation 19
- miscellaneous parts 7
- mouse
  - cleaning 9, 12, 13
  - problems 49

- N**
- network problems 52
- nonvolatile memory 87
- numeric error codes 73
- O**
- operating guidelines 9, 11
- overheating, prevention 9, 11
- P**
- password
  - Power-On 79
  - security 79
  - Setup 79
- POST error messages 73
- power cord set requirements
  - country specific 93
- power problems 44
- power supply
  - illustrated 3
  - operating voltage range 95
- Power-On password 79
- printer problems 48
- problems
  - audio 47
  - Computer Setup 40
  - F10 Setup 40
  - flash drive 56
  - general 40
  - hard drive 45
  - hardware installation 50
  - internet access 57
  - keyboard 49
  - memory 54
  - mouse 49
  - network 52
  - power 44
  - printer 48
  - software 57
- processor
  - illustrated 3
  - removal and replacement 33
- product features 1
- product ID location 2
- R**
- rear panel components 2
- recovery 81
  - discs 82
  - media 82
  - USB flash drive 82
- recovery media 81
  - creating using HP Cloud Recovery Download Tool 81
  - creating using Windows tools 81
- Remote HP PC Hardware Diagnostics
  - UEFI settings
    - customizing 85
- removal and replacement
  - ambient sensor 29
  - fan 22
  - flex I/O connector board #1 30
  - flex I/O connector board #2 31
  - front bezel 17, 18
  - heat sink 31
  - memory 19
  - processor 33
  - solid-state drive 24
  - speaker 28
  - system board 34
  - wireless antennas 36
  - WLAN module 25
- removing
  - battery 27
  - hard drive 23
  - hard drive cage 23
- removing personal data from volatile system memory 87
- restoring 81
- S**
- safety precautions
  - cleaning 9, 12
- SATA
  - connectors on system board 9, 15
  - data cable pinouts 9, 15
  - hard drive characteristics 9, 15
- screws, correct size 9, 13, 14
- Security menu, Computer Setup 62
- serial number location 2
- service considerations 9, 13
- Setup password 79
- software
  - problems 57
  - servicing computer 9, 13, 14
- solid-state drive module
  - removal and replacement 24
- solid-state drives 6
- speaker
  - illustrated 3
  - removal and replacement 28
- specifications
  - computer 95
  - memory 19
- static electricity 9
- system board
  - illustrated 3
  - removal and replacement 34
  - SATA connectors 9, 15
- system board callouts 36
- system memory, removing personal data from volatile 87
- system restore 82
- system restore point, creating 81
- T**
- temperature control 9, 11
- tools, servicing 9, 13, 14
- Torx T15 screwdriver 9, 13, 14
- troubleshooting without diagnostics 39
- U**
- using Computer Setup Utilities 59
- V**
- ventilation, proper 9, 11
- W**
- Windows
  - backup 81
  - recovery media 81
  - system restore point 81
- Windows tools, using 81
- wireless antennas
  - removal and replacement 36
- WLAN module
  - removal and replacement 25