

Interactive Part Locator

HP ZBook Fury 15 G7 Mobile Workstation

Welcome to the interactive part locator
for the HP ZBook Fury 15 G7 Mobile Workstation

Here's how to use it...

[External Views](#) (Click the link to navigate to the views)

On this page you will find large icons of each of the external views of this product. To view a specific view in greater detail, simply click that view.

[Parts List](#) (Click the link to navigate to the parts)

On this page, you will find a list of all of the replaceable parts for this product. To view a specific part and its location in the product, click the part name in the list.

That's it! On every page there is a link that brings you back to either the External Views or the Parts List, enabling you to navigate to whatever view or part you wish to review.

External Views

[Back to Welcome page](#)



Front



Left



Right



Rear



Display



Top



Internal



Bottom

[Go to Parts List](#)

Front View

[Back to External Views](#)



[Go to Parts List](#)

Left View

[Back to External Views](#)

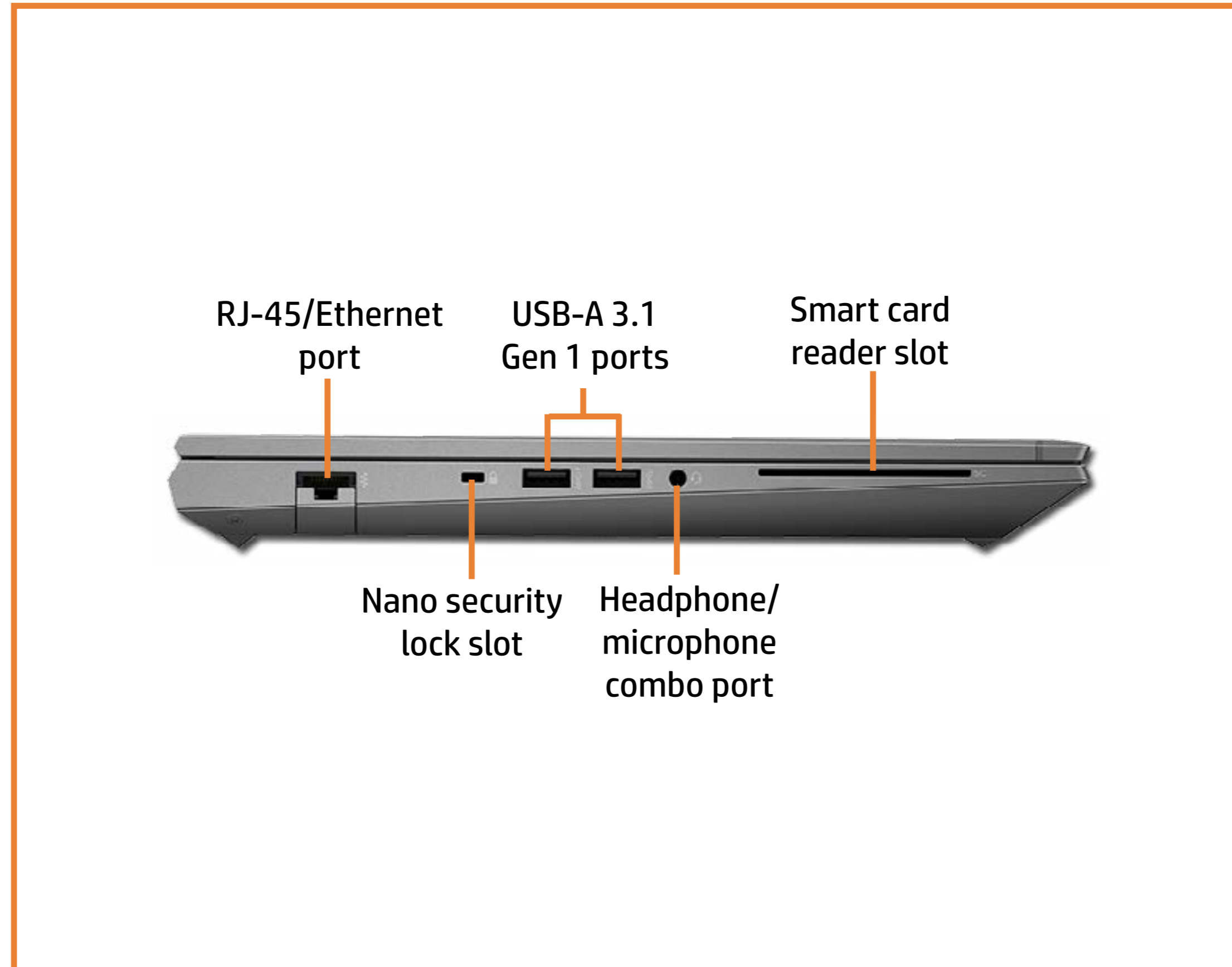

[Go to Parts List](#)

Right View

[Back to External Views](#)

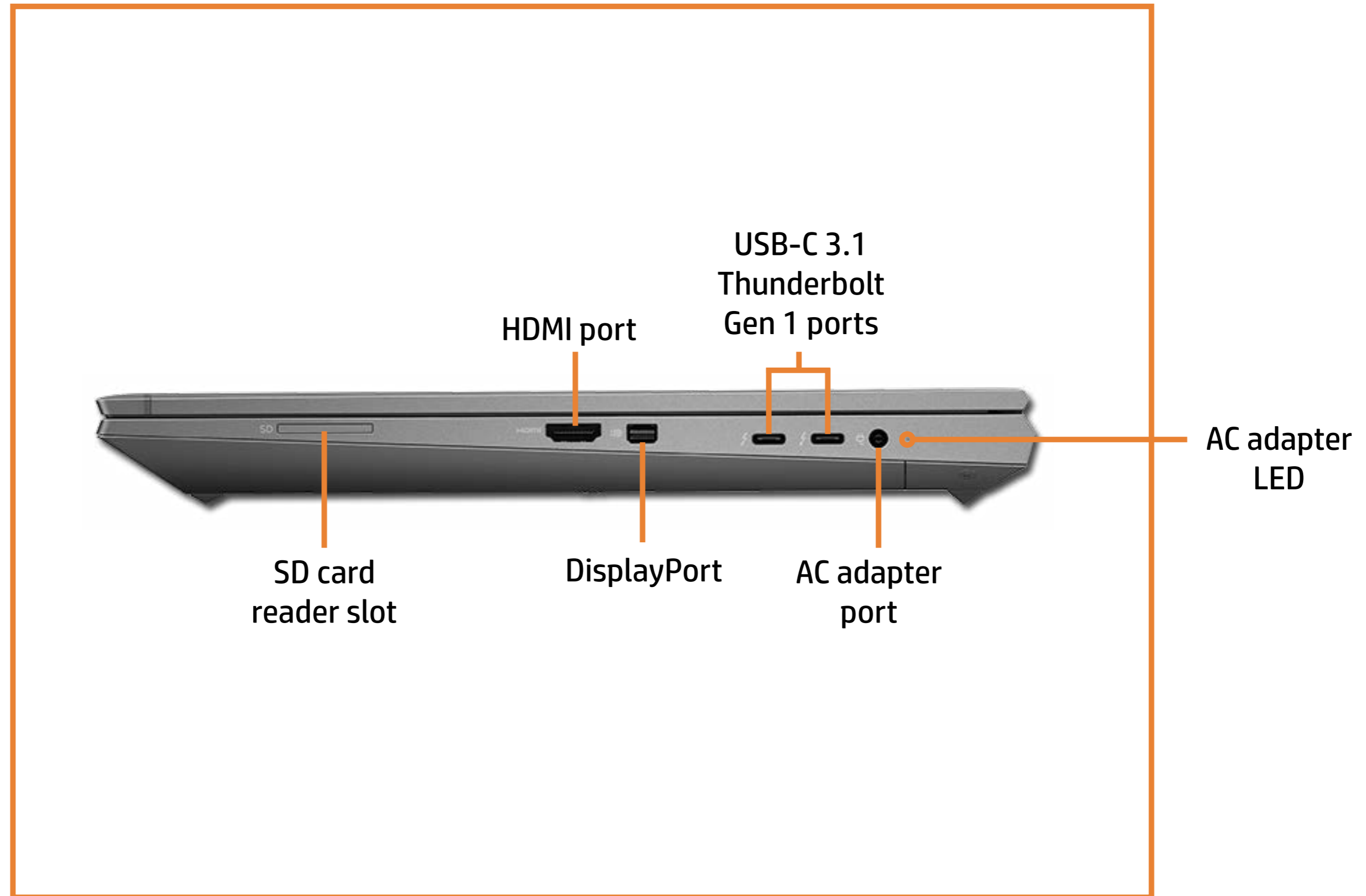

[Go to Parts List](#)

Rear View

[Back to External Views](#)

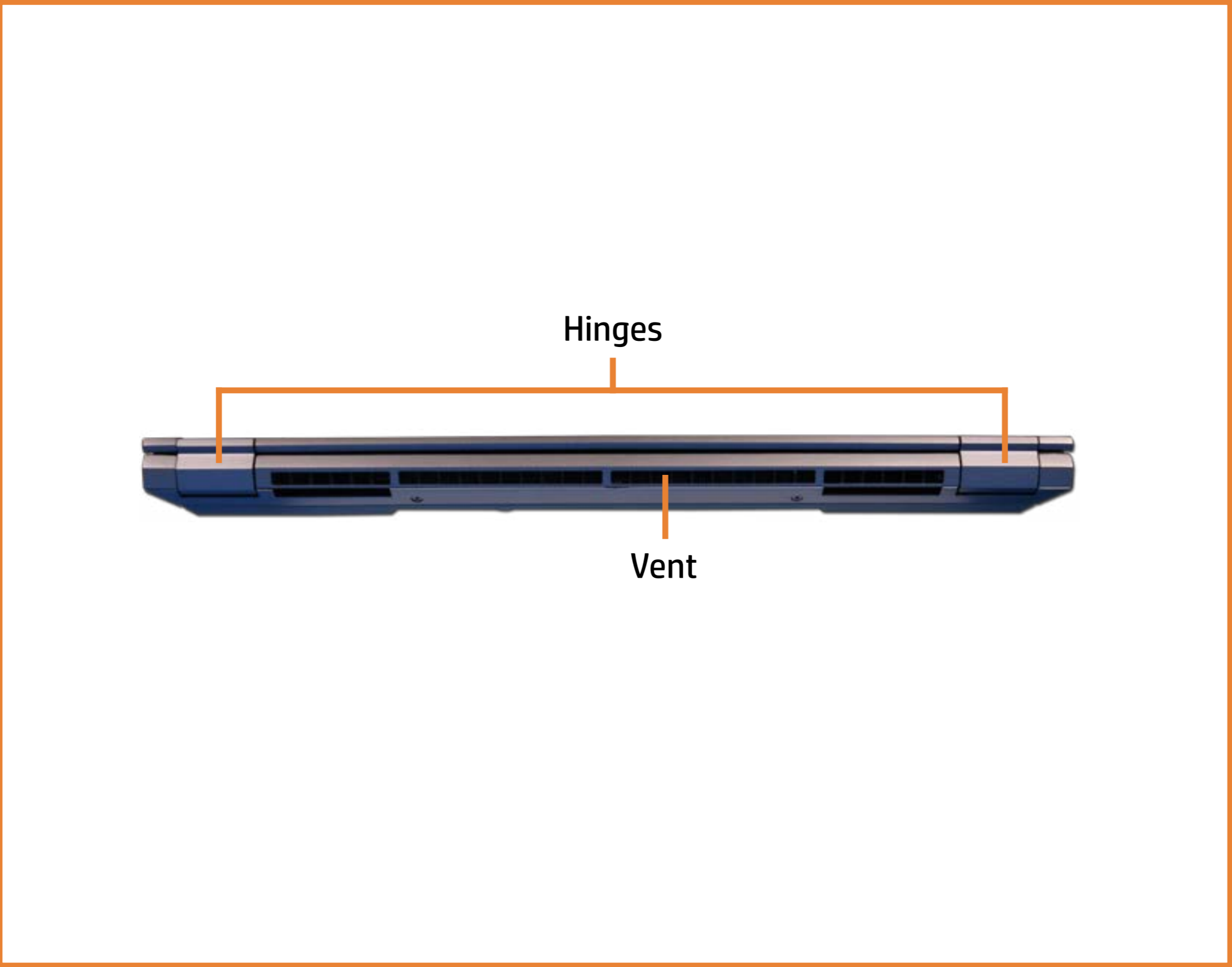

[Go to Parts List](#)

Top View

[Back to External Views](#)

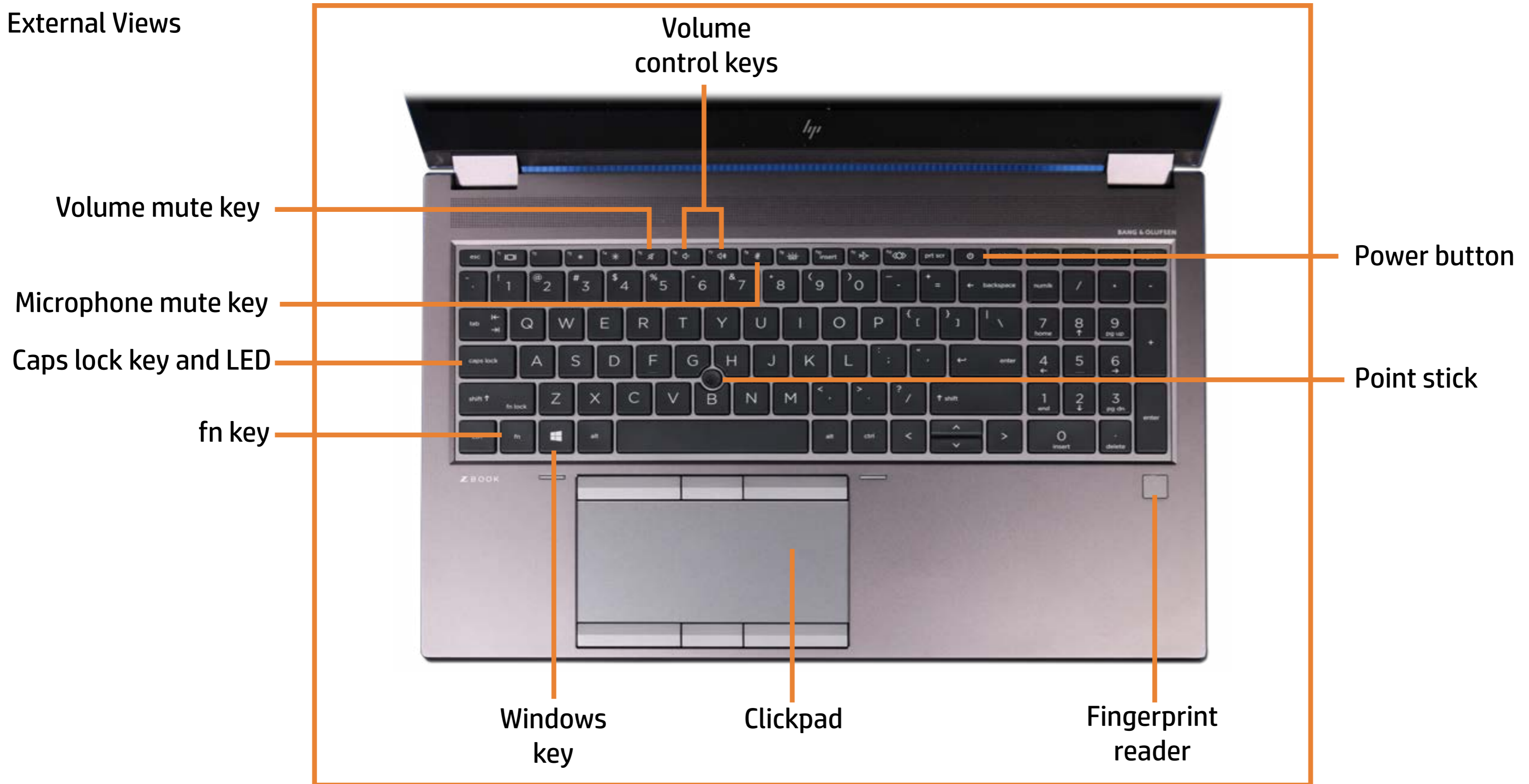

[Go to Parts List](#)

Display View

[Back to External Views](#)

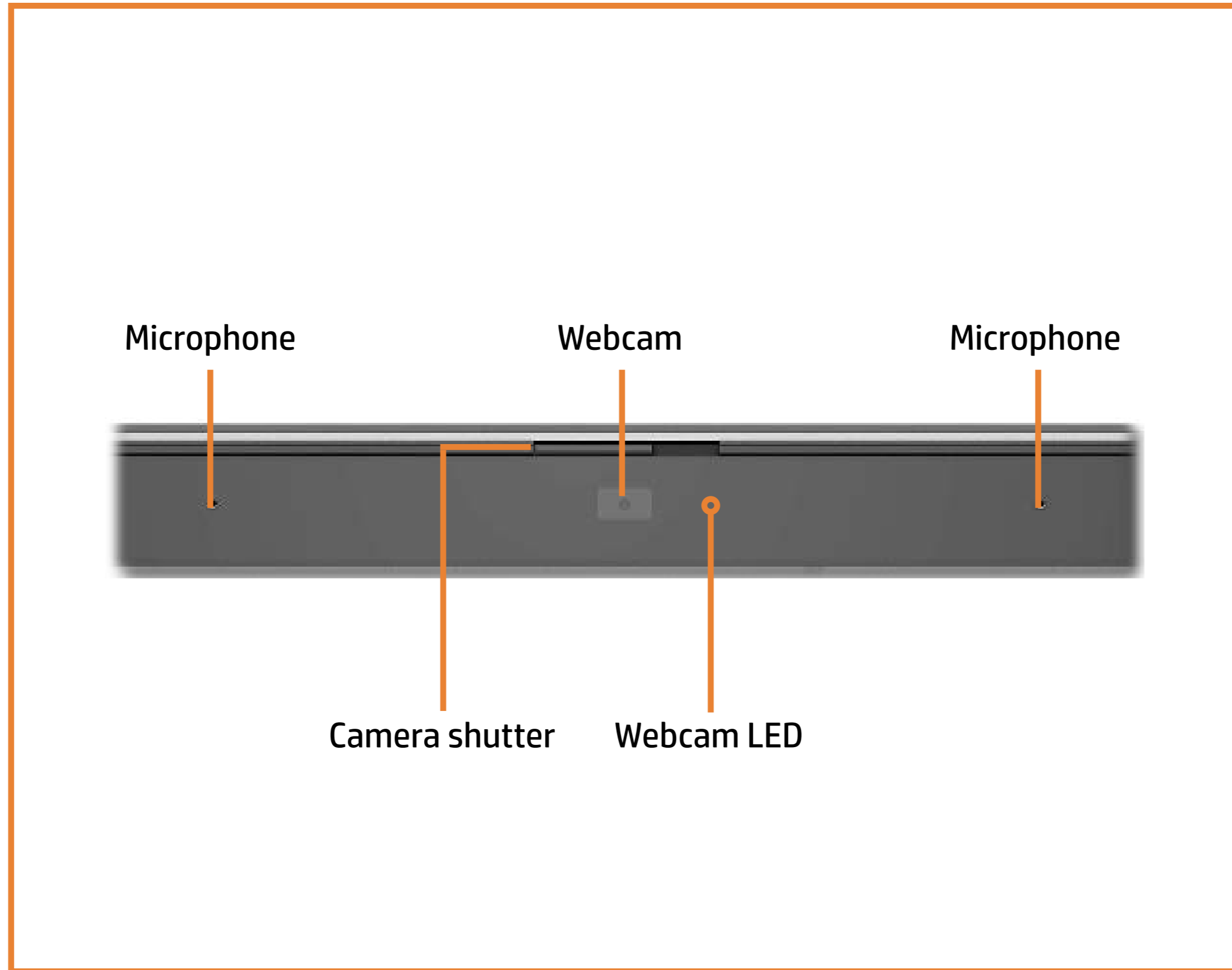

[Go to Parts List](#)

Internal View

[Back to External Views](#)

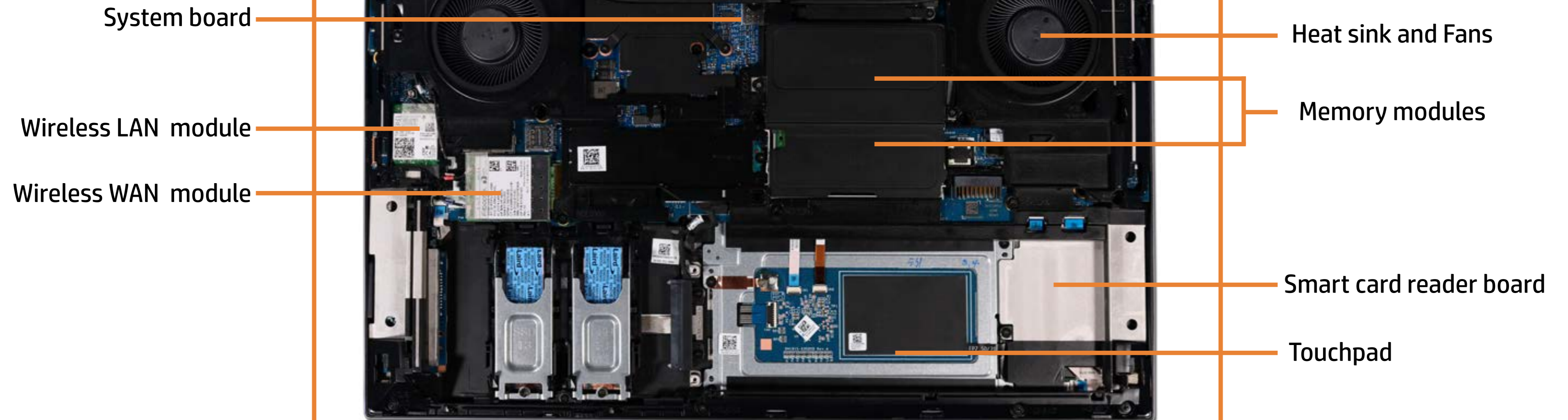

[Go to Parts List](#)

Bottom View

[Back to External Views](#)

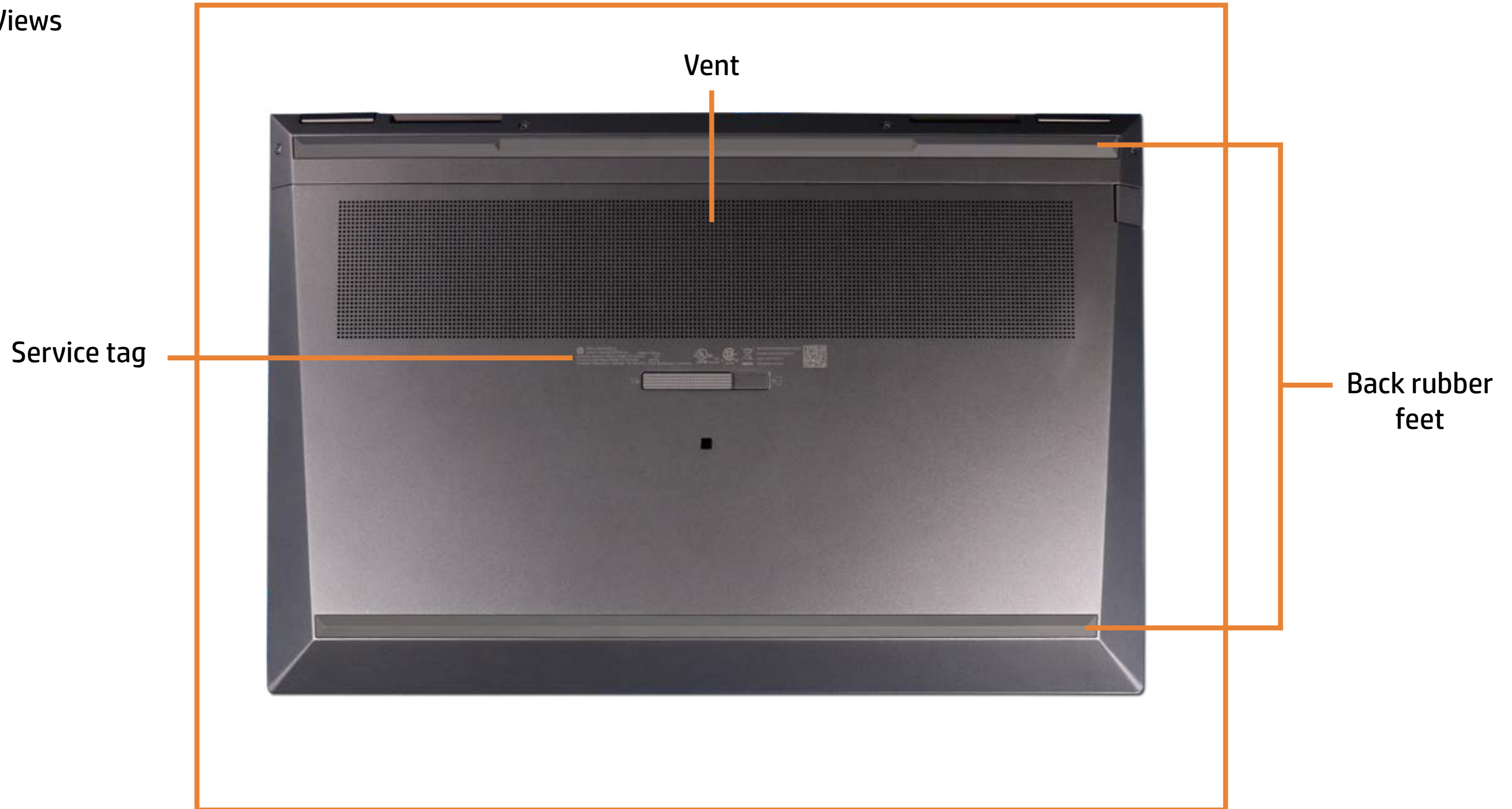

[Go to Parts List](#)

Service Door

Service Door

- Battery
- Hard Drive
- Secondary Memory Modules
- Secondary M.2 Solid State Drive
- Wireless LAN Module
- Keyboard
- Wireless WAN Module
- Wireless WAN Antennas (D cover)
- Primary Memory Modules
- Primary M.2 Solid State Drive
- Base Enclosure
- Fingerprint Reader
- SD Card Reader Board
- Smart Card Reader
- NFC Module
- Touchpad
- Heat Sink With Fans
- Graphics Card
- Beam Connector
- System Board (Top)
- System Board (Bottom)
- I/O Board
- Speakers
- Top Cover
- Display Panel Assembly



[Go to External Views](#)

Battery

Service Door

Battery

Hard Drive

Secondary Memory Modules

Secondary M.2 Solid State Drive

Wireless LAN Module

Keyboard

Wireless WAN Module

Wireless WAN Antennas (D cover)

Primary Memory Modules

Primary M.2 Solid State Drive

Base Enclosure

Fingerprint Reader

SD Card Reader Board

Smart Card Reader

NFC Module

Touchpad

Heat Sink With Fans

Graphics Card

Beam Connector

System Board (Top)

System Board (Bottom)

I/O Board

Speakers

Top Cover

Display Panel Assembly



[Go to External Views](#)

Hard Drive

- Service Door
- Battery
- Hard Drive**
- Secondary Memory Modules
- Secondary M.2 Solid State Drive
- Wireless LAN Module
- Keyboard
- Wireless WAN Module
- Wireless WAN Antennas (D cover)
- Primary Memory Modules
- Primary M.2 Solid State Drive
- Base Enclosure
- Fingerprint Reader
- SD Card Reader
- SD Card Reader Board
- NFC Module
- Touchpad
- Heat Sink With Fans
- Graphics Card
- Beam Connector
- System Board (Top)
- System Board (Bottom)
- I/O Board
- Speakers
- Top Cover
- Display Panel Assembly

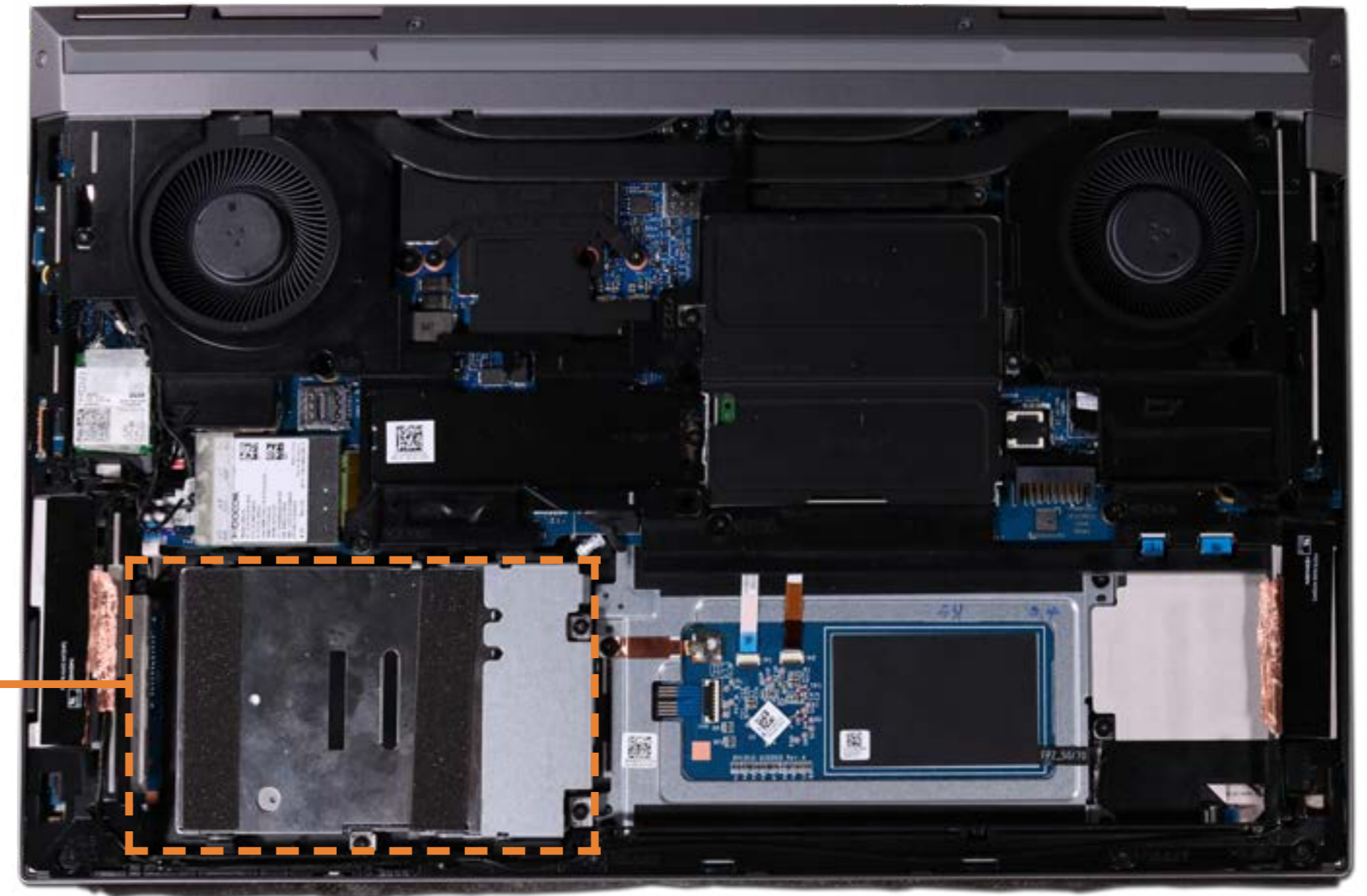

Go to External Views

Secondary Memory Modules

- Service Door
- Battery
- Hard Drive
- Secondary Memory Modules**
- Secondary M.2 Solid State Drive
- Wireless LAN Module
- Keyboard
- Wireless WAN Module
- Wireless WAN Antennas (D cover)
- Primary Memory Modules
- Primary M.2 Solid State Drive
- Base Enclosure
- Fingerprint Reader
- SD Card Reader Board
- Smart Card Reader
- NFC Module
- Touchpad
- Heat Sink With Fans
- Graphics Card
- Beam Connector
- System Board (Top)
- System Board (Bottom)
- I/O Board
- Speakers
- Top Cover
- Display Panel Assembly

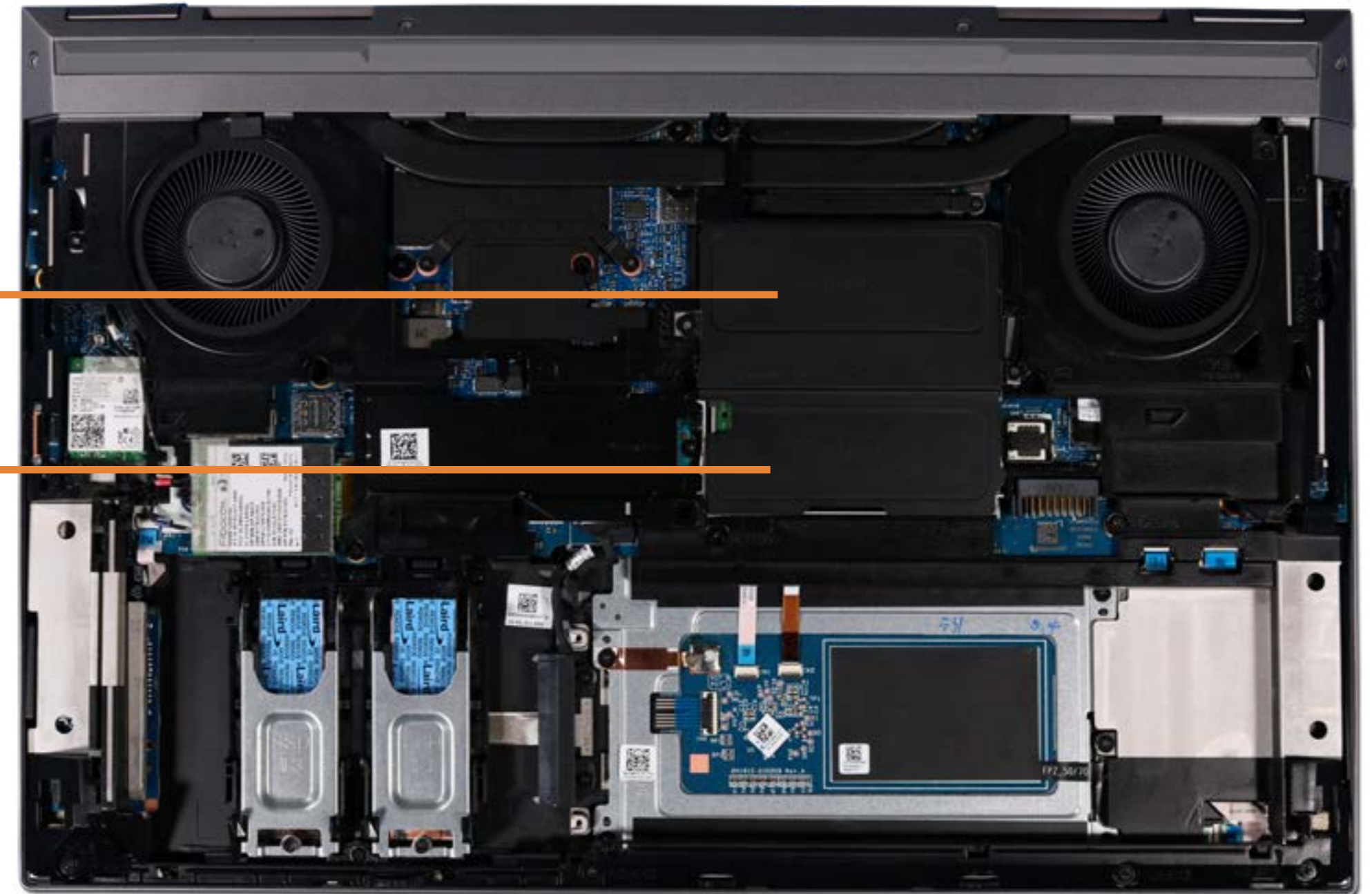

[Go to External Views](#)

Secondary M.2 Solid State Drive

- Service Door
- Battery
- Hard Drive
- Secondary Memory Modules
- Secondary M.2 Solid State Drive**
- Wireless LAN Module
- Keyboard
- Wireless WAN Module
- Wireless WAN Antennas (D cover)
- Primary Memory Modules
- Primary M.2 Solid State Drive
- Base Enclosure
- Fingerprint Reader
- SD Card Reader Board
- Smart Card Reader
- NFC Module
- Touchpad
- Heat Sink With Fans
- Graphics Card
- Beam Connector
- System Board (Top)
- System Board (Bottom)
- I/O Board
- Speakers
- Top Cover
- Display Panel Assembly



[Go to External Views](#)

Wireless LAN Module

- Service Door
- Battery
- Hard Drive
- Secondary Memory Modules
- Secondary M.2 Solid State Drive
- Wireless LAN Module**
- Keyboard
- Wireless WAN Module
- Wireless WAN Antennas (D cover)
- Primary Memory Modules
- Primary M.2 Solid State Drive
- Base Enclosure
- Fingerprint Reader
- SD Card Reader Board
- Smart Card Reader
- NFC Module
- Touchpad
- Heat Sink With Fans
- Graphics Card
- Beam Connector
- System Board (Top)
- System Board (Bottom)
- I/O Board
- Speakers
- Top Cover
- Display Panel Assembly



Go to External Views

Keyboard

- Service Door
- Battery
- Hard Drive
- Secondary Memory Modules
- Secondary M.2 Solid State Drive
- Wireless LAN Module
- Keyboard**
- Wireless WAN Module
- Wireless WAN Antennas (D cover)
- Primary Memory Modules
- Primary M.2 Solid State Drive
- Base Enclosure
- Fingerprint Reader
- SD Card Reader Board
- Smart Card Reader
- NFC Module
- Touchpad
- Heat Sink With Fans
- Graphics Card
- Beam Connector
- System Board (Top)
- System Board (Bottom)
- I/O Board
- Speakers
- Top Cover
- Display Panel Assembly



Go to External Views

Wireless WAN Module

- Service Door
- Battery
- Hard Drive
- Secondary Memory Modules
- Secondary M.2 Solid State Drive
- Wireless LAN Module
- Keyboard
- Wireless WAN Module**
- Wireless WAN Antennas (D cover)
- Primary Memory Modules
- Primary M.2 Solid State Drive
- Base Enclosure
- Fingerprint Reader
- SD Card Reader Board
- Smart Card Reader
- NFC Module
- Touchpad
- Heat Sink With Fans
- Graphics Card
- Beam Connector
- System Board (Top)
- System Board (Bottom)
- I/O Board
- Speakers
- Top Cover
- Display Panel Assembly



[Go to External Views](#)

Wireless WAN Antennas (D cover)

- Service Door
- Battery
- Hard Drive
- Secondary Memory Modules
- Secondary M.2 Solid State Drive
- Wireless LAN Module
- Keyboard
- Wireless WAN Module
- Wireless WAN Antennas (D cover)**
- Primary Memory Modules
- Primary M.2 Solid State Drive
- Base Enclosure
- Fingerprint Reader
- SD Card Reader Board
- Smart Card Reader
- NFC Module
- Touchpad
- Heat Sink With Fans
- Graphics Card
- Beam Connector
- System Board (Top)
- System Board (Bottom)
- I/O Board
- Speakers
- Top Cover
- Display Panel Assembly

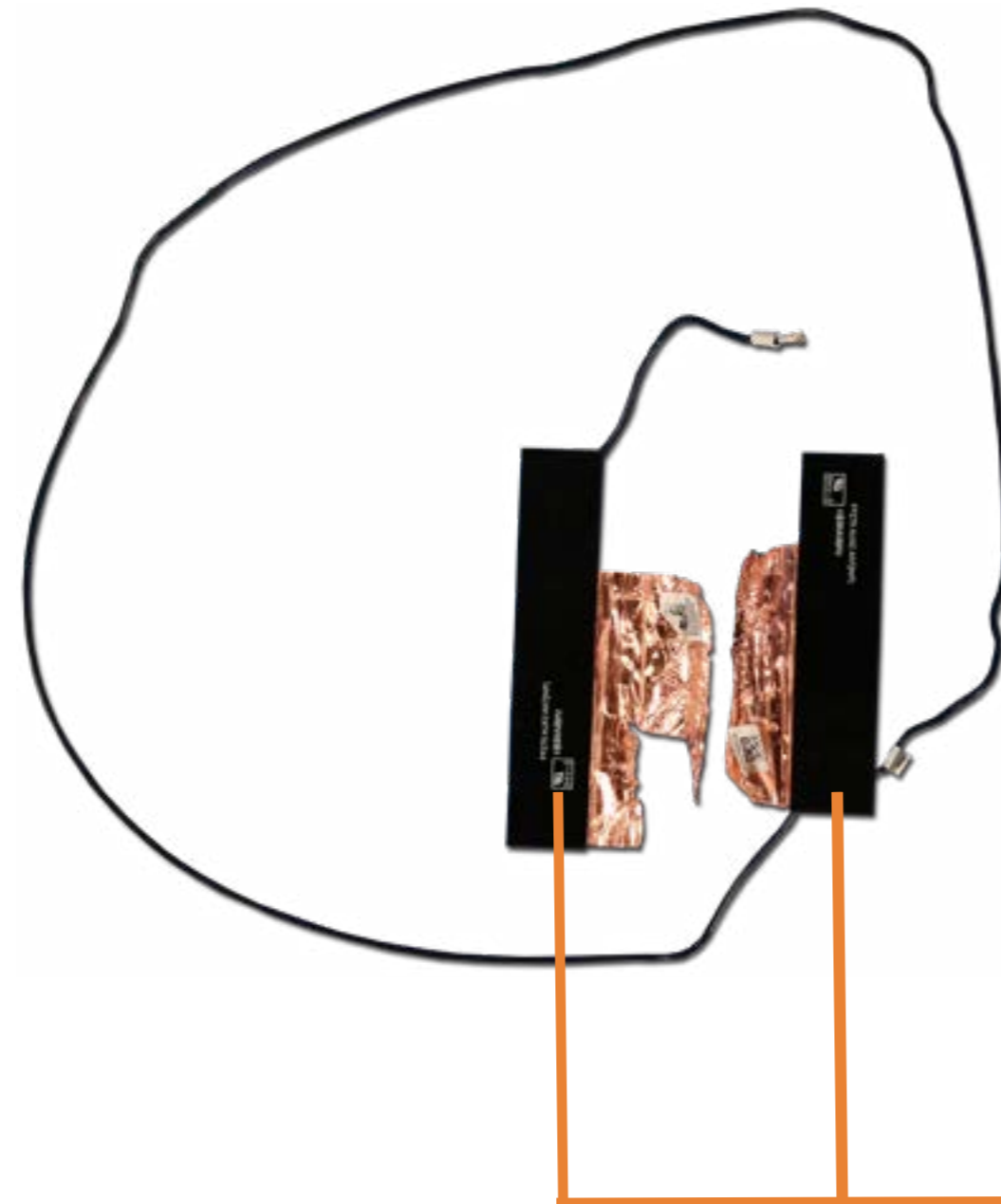

[Go to External Views](#)

Primary Memory Modules

- Service Door
- Battery
- Hard Drive
- Secondary Memory Modules
- Secondary M.2 Solid State Drive
- Wireless LAN Module
- Keyboard
- Wireless WAN Module
- Wireless WAN Antennas (D cover)
- Primary Memory Modules**
- Primary M.2 Solid State Drive
- Base Enclosure
- Fingerprint Reader
- SD Card Reader Board
- Smart Card Reader
- NFC Module
- Touchpad
- Heat Sink With Fans
- Graphics Card
- Beam Connector
- System Board (Top)
- System Board (Bottom)
- I/O Board
- Speakers
- Top Cover
- Display Panel Assembly

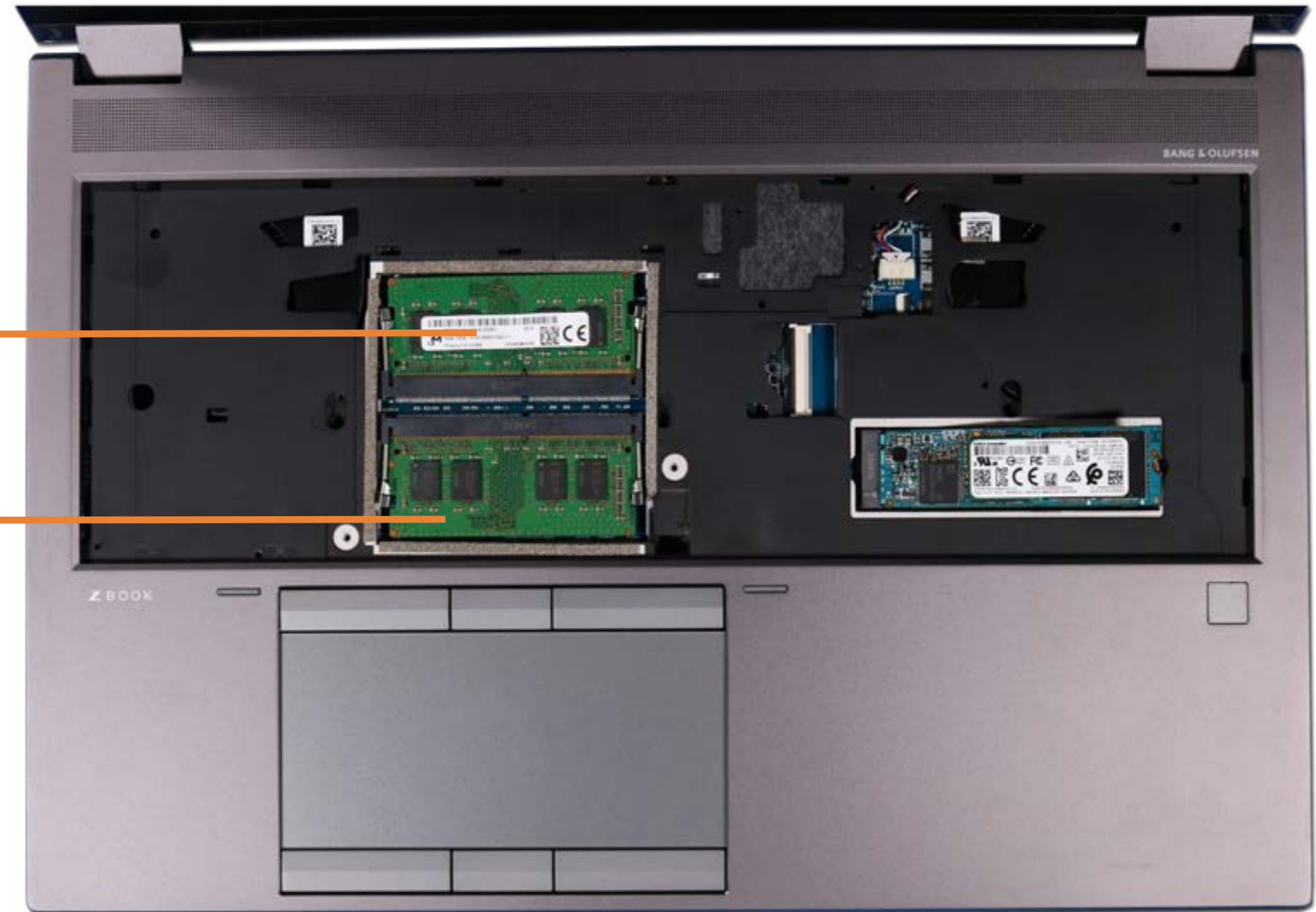

Go to External Views

Primary M.2 Solid State Drive

- Service Door
- Battery
- Hard Drive
- Secondary Memory Modules
- Secondary M.2 Solid State Drive
- Wireless LAN Module
- Keyboard
- Wireless WAN Module
- Wireless WAN Antennas (D cover)
- Primary Memory Modules
- Primary M.2 Solid State Drive**
- Base Enclosure
- Fingerprint Reader
- SD Card Reader Board
- Smart Card Reader
- NFC Module
- Touchpad
- Heat Sink With Fans
- Graphics Card
- Beam Connector
- System Board (Top)
- System Board (Bottom)
- I/O Board
- Speakers
- Top Cover
- Display Panel Assembly



[Go to External Views](#)

Base Enclosure

- Service Door
- Battery
- Hard Drive
- Secondary Memory Modules
- Secondary M.2 Solid State Drive
- Wireless LAN Module
- Keyboard
- Wireless WAN Module
- Wireless WAN Antennas (D cover)
- Primary Memory Modules
- Primary M.2 Solid State Drive
- Base Enclosure**
- Fingerprint Reader
- SD Card Reader Board
- Smart Card Reader
- NFC Module
- Touchpad
- Heat Sink With Fans
- Graphics Card
- Beam Connector
- System Board (Top)
- System Board (Bottom)
- I/O Board
- Speakers
- Top Cover
- Display Panel Assembly

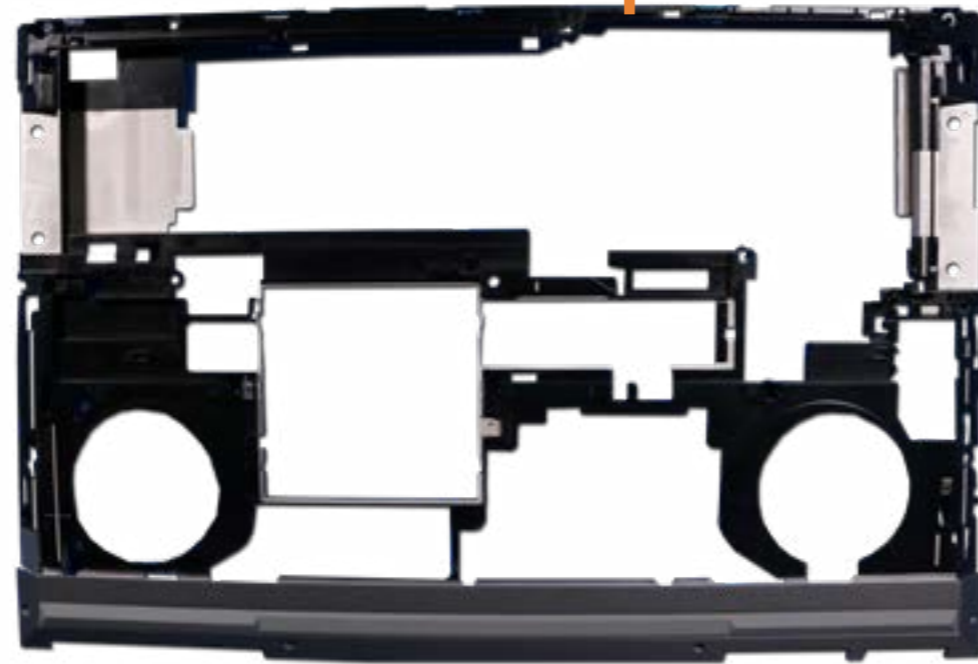

[Go to External Views](#)

Fingerprint Reader

- Service Door
- Battery
- Hard Drive
- Secondary Memory Modules
- Secondary M.2 Solid State Drive
- Wireless LAN Module
- Keyboard
- Wireless WAN Module
- Wireless WAN Antennas (D cover)
- Primary Memory Modules
- Primary M.2 Solid State Drive
- Base Enclosure
- Fingerprint Reader**
- SD Card Reader Board
- Smart Card Reader
- NFC Module
- Touchpad
- Heat Sink With Fans
- Graphics Card
- Beam Connector
- System Board (Top)
- System Board (Bottom)
- I/O Board
- Speakers
- Top Cover
- Display Panel Assembly

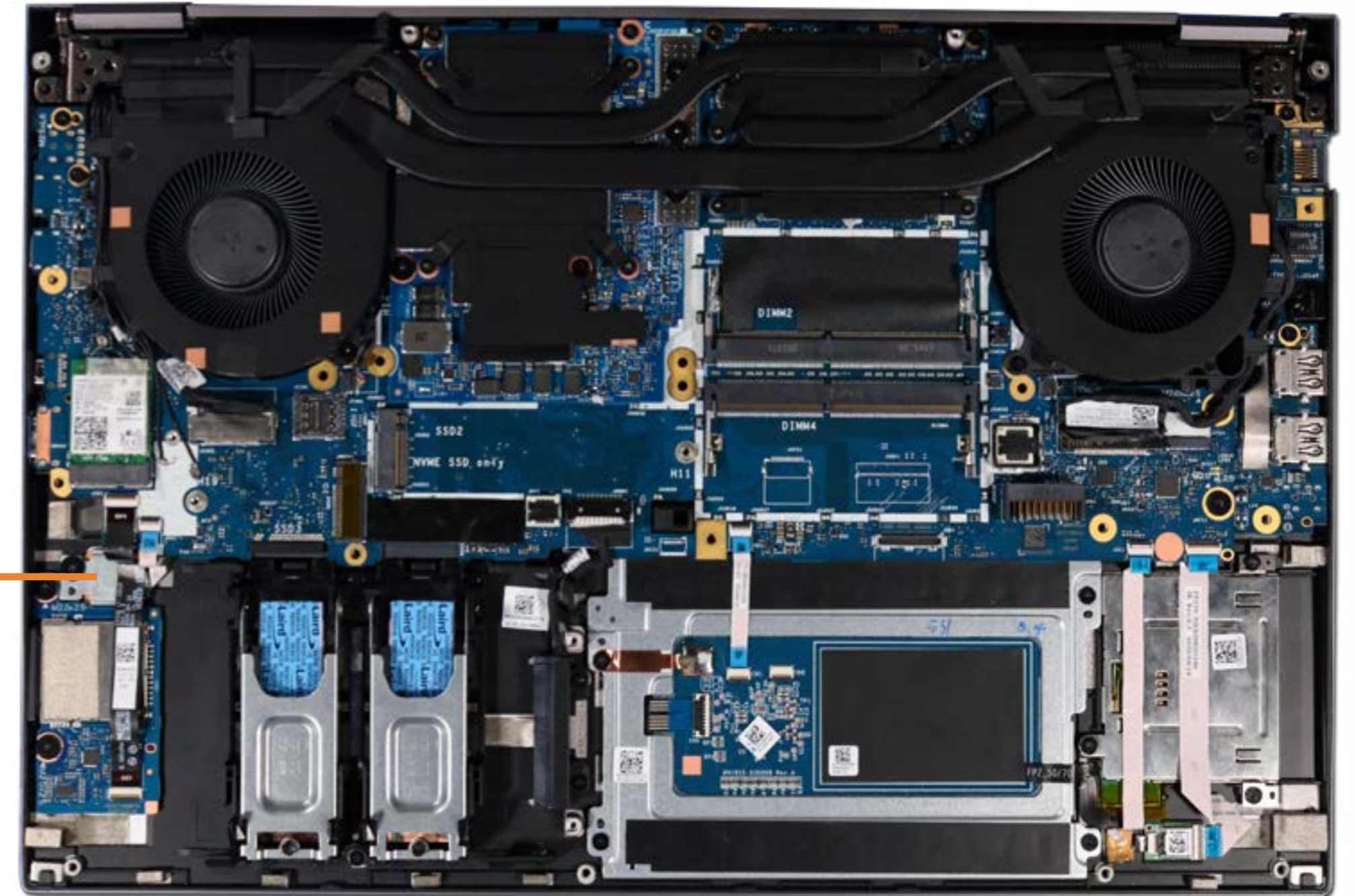

[Go to External Views](#)

SD Card Reader Board

- Service Door
- Battery
- Hard Drive
- Secondary Memory Modules
- Secondary M.2 Solid State Drive
- Wireless LAN Module
- Keyboard
- Wireless WAN Module
- Wireless WAN Antennas (D cover)
- Primary Memory Modules
- Primary M.2 Solid State Drive
- Base Enclosure
- Fingerprint Reader
- SD Card Reader Board**
- Smart Card Reader
- NFC Module
- Touchpad
- Heat Sink With Fans
- Graphics Card
- Beam Connector
- System Board (Top)
- System Board (Bottom)
- I/O Board
- Speakers
- Top Cover
- Display Panel Assembly

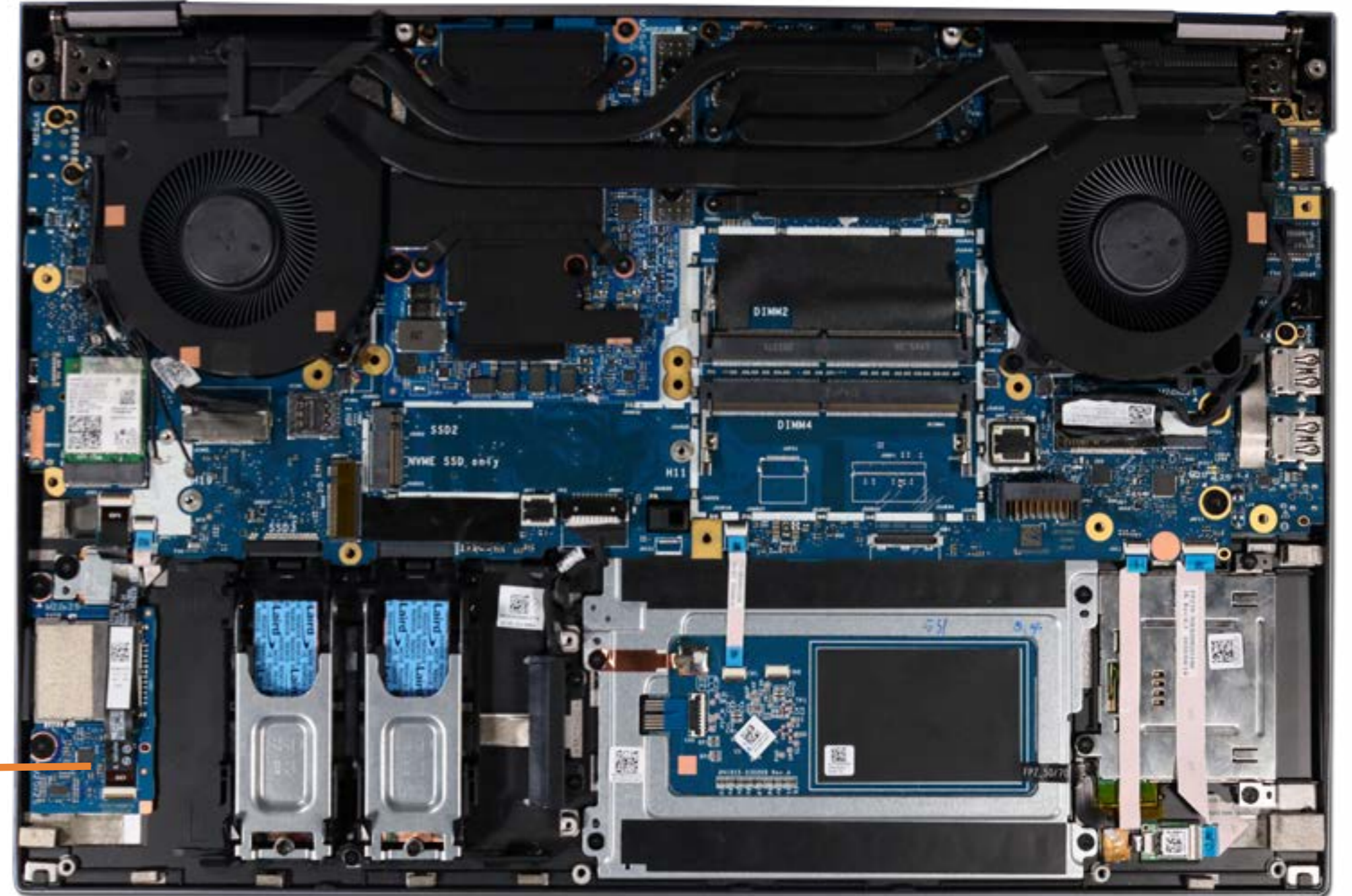

[Go to External Views](#)

Smart Card Reader

- Service Door
- Battery
- Hard Drive
- Secondary Memory Modules
- Secondary M.2 Solid State Drive
- Wireless LAN Module
- Keyboard
- Wireless WAN Module
- Wireless WAN Antennas (D cover)
- Primary Memory Modules
- Primary M.2 Solid State Drive
- Base Enclosure
- Fingerprint Reader
- SD Card Reader Board
- Smart Card Reader**
- NFC Module
- Touchpad
- Heat Sink With Fans
- Graphics Card
- Beam Connector
- System Board (Top)
- System Board (Bottom)
- I/O Board
- Speakers
- Top Cover
- Display Panel Assembly

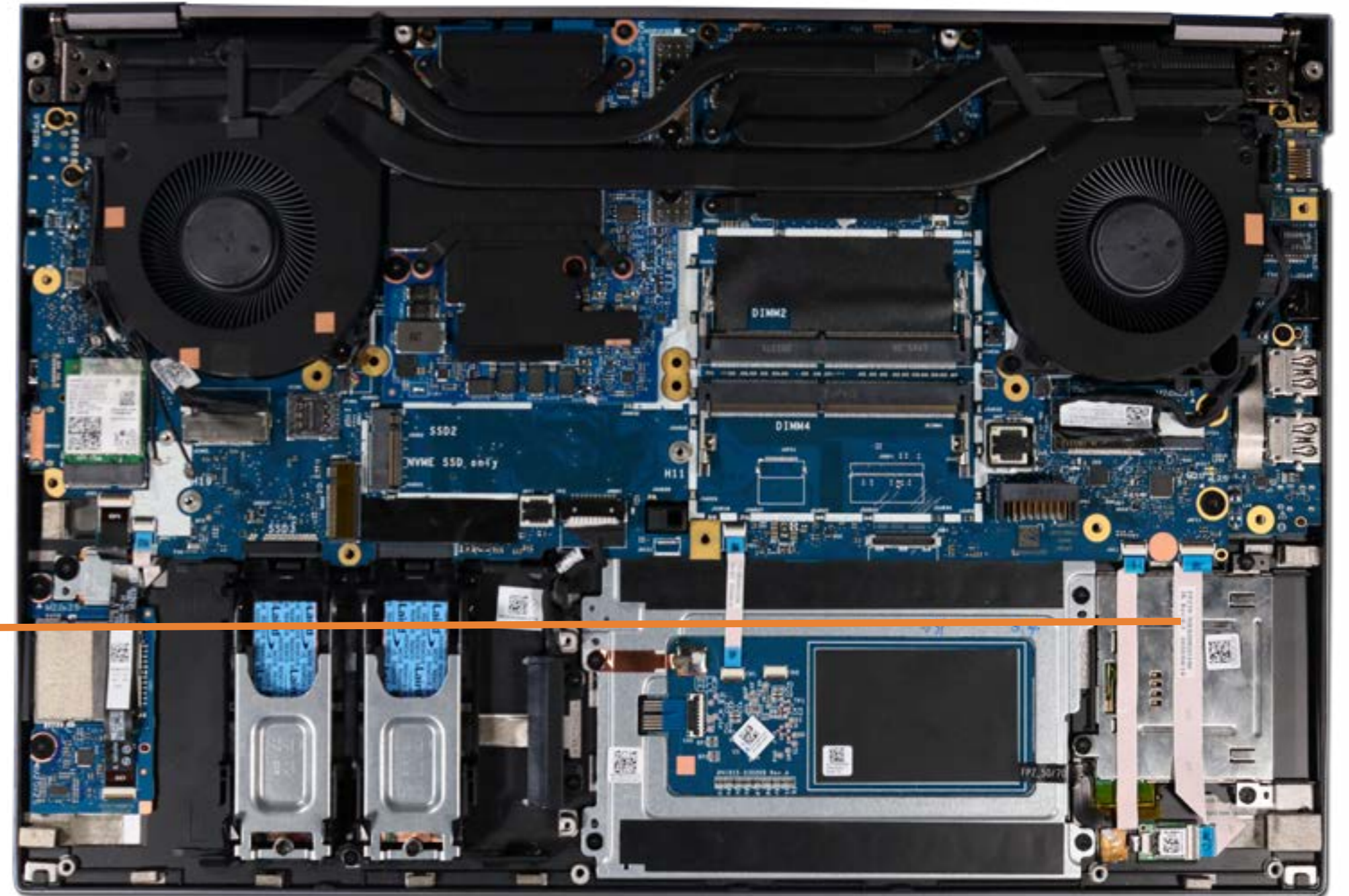
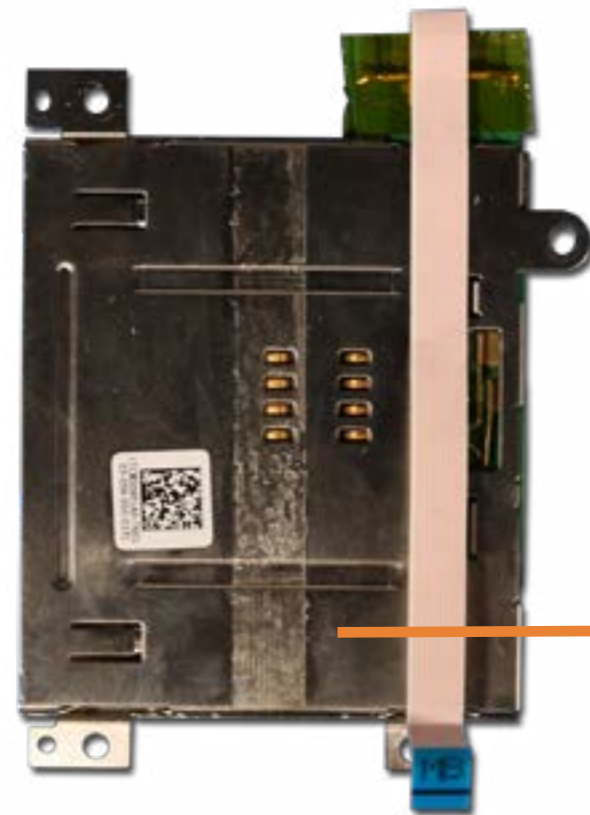

[Go to External Views](#)

NFC Module

- Service Door
- Battery
- Hard Drive
- Secondary Memory Modules
- Secondary M.2 Solid State Drive
- Wireless LAN Module
- Keyboard
- Wireless WAN Module
- Wireless WAN Antennas (D cover)
- Primary Memory Modules
- Primary M.2 Solid State Drive
- Base Enclosure
- Fingerprint Reader
- SD Card Reader Board
- Smart Card Reader
- NFC Module**
- Touchpad
- Heat Sink With Fans
- Graphics Card
- Beam Connector
- System Board (Top)
- System Board (Bottom)
- I/O Board
- Speakers
- Top Cover
- Display Panel Assembly

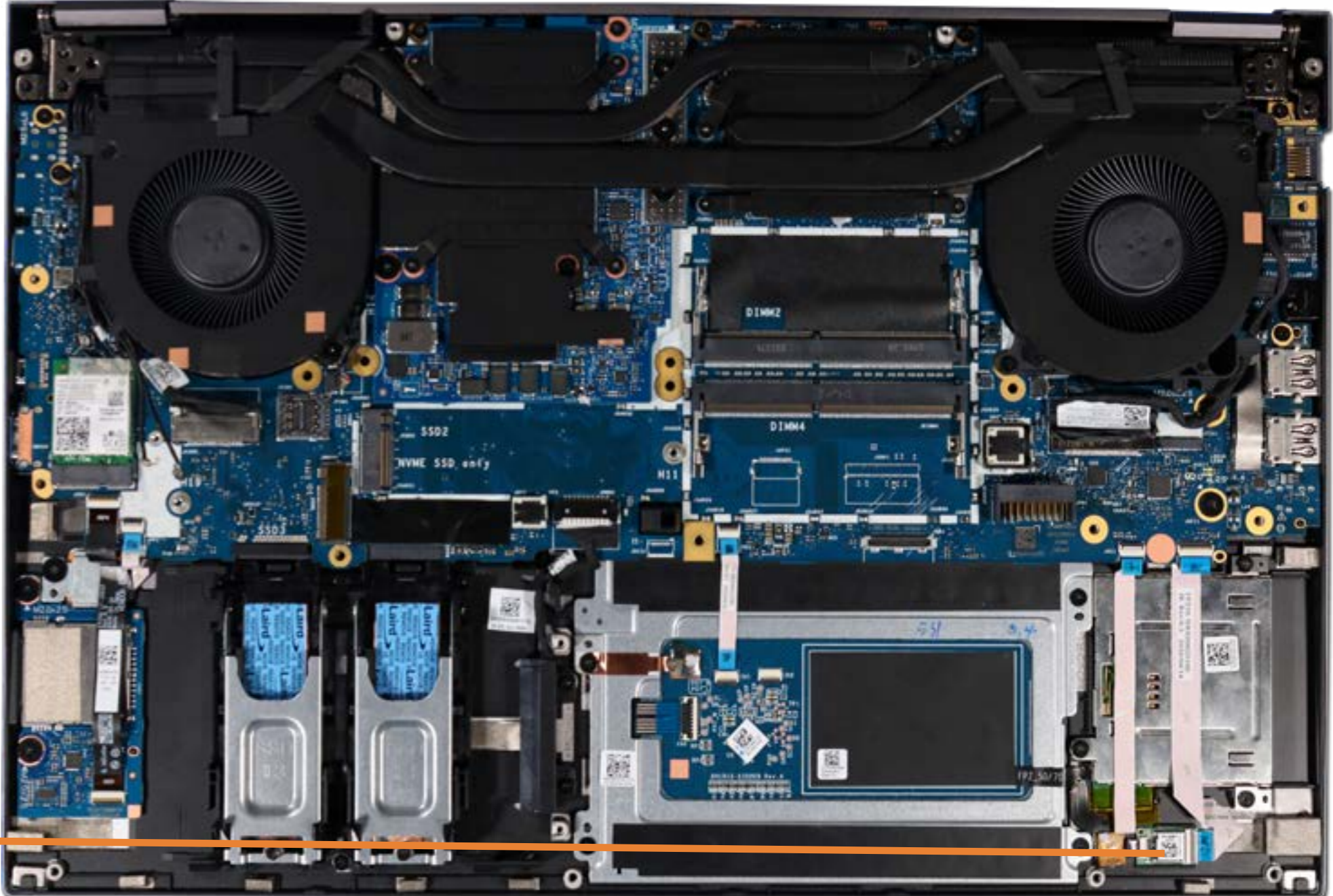

Go to External Views

Touchpad

- Service Door
- Battery
- Hard Drive
- Secondary Memory Modules
- Secondary M.2 Solid State Drive
- Wireless LAN Module
- Keyboard
- Wireless WAN Module
- Wireless WAN Antennas (D cover)
- Primary Memory Modules
- Primary M.2 Solid State Drive
- Base Enclosure
- Fingerprint Reader
- SD Card Reader Board
- Smart Card Reader
- NFC Module
- Touchpad**
- Heat Sink With Fans
- Graphics Card
- Beam Connector
- System Board (Top)
- System Board (Bottom)
- I/O Board
- Speakers
- Top Cover
- Display Panel Assembly

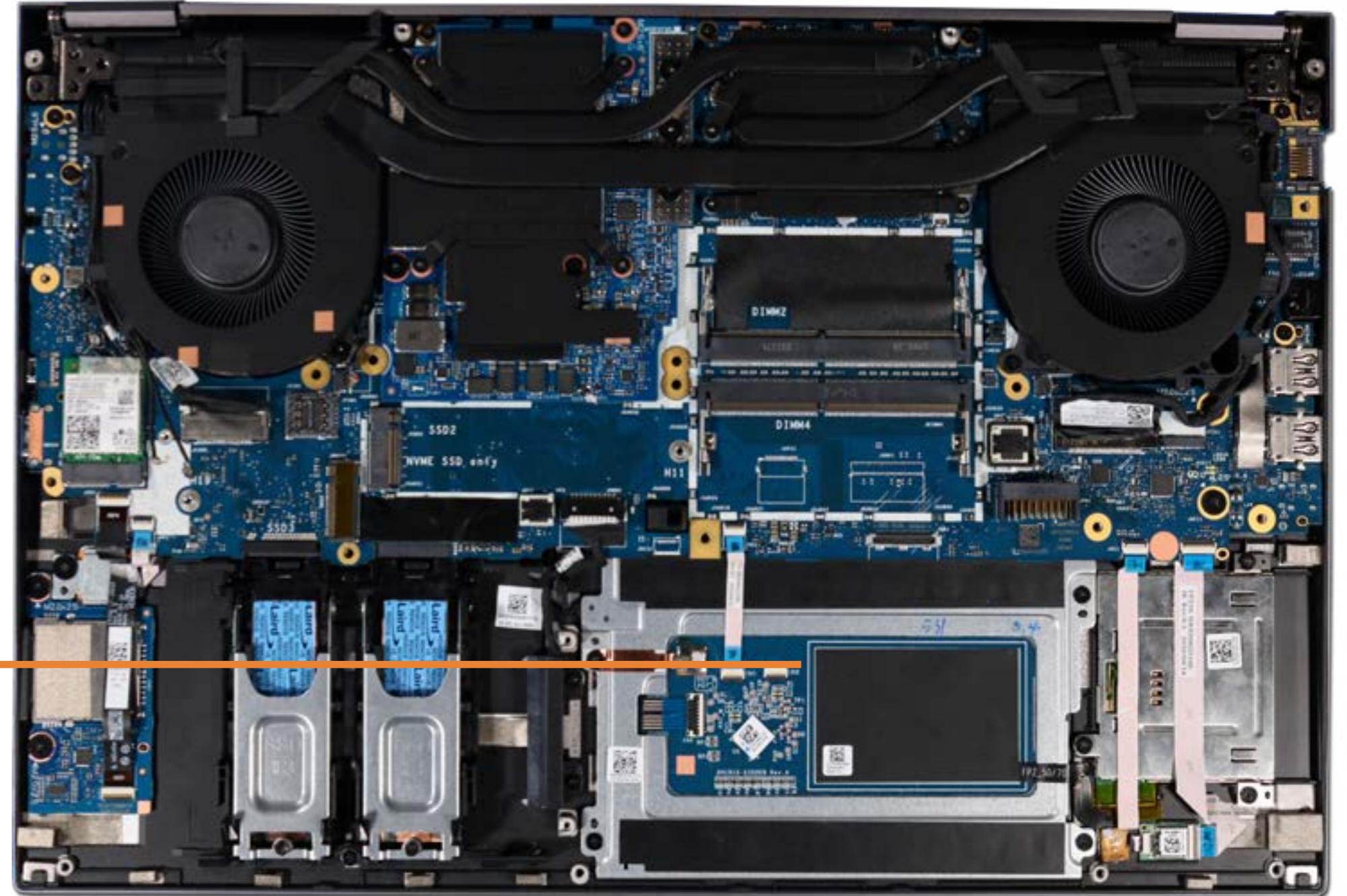

[Go to External Views](#)

Heat Sink with Fans

- Service Door
- Battery
- Hard Drive
- Secondary Memory Modules
- Secondary M.2 Solid State Drive
- Wireless LAN Module
- Keyboard
- Wireless WAN Module
- Wireless WAN Antennas (D cover)
- Primary Memory Modules
- Primary M.2 Solid State Drive
- Base Enclosure
- Fingerprint Reader
- SD Card Reader Board
- Smart Card Reader
- NFC Module
- Touchpad
- Heat Sink With Fans**
- Graphics Card
- Beam Connector
- System Board (Top)
- System Board (Bottom)
- I/O Board
- Speakers
- Top Cover
- Display Panel Assembly

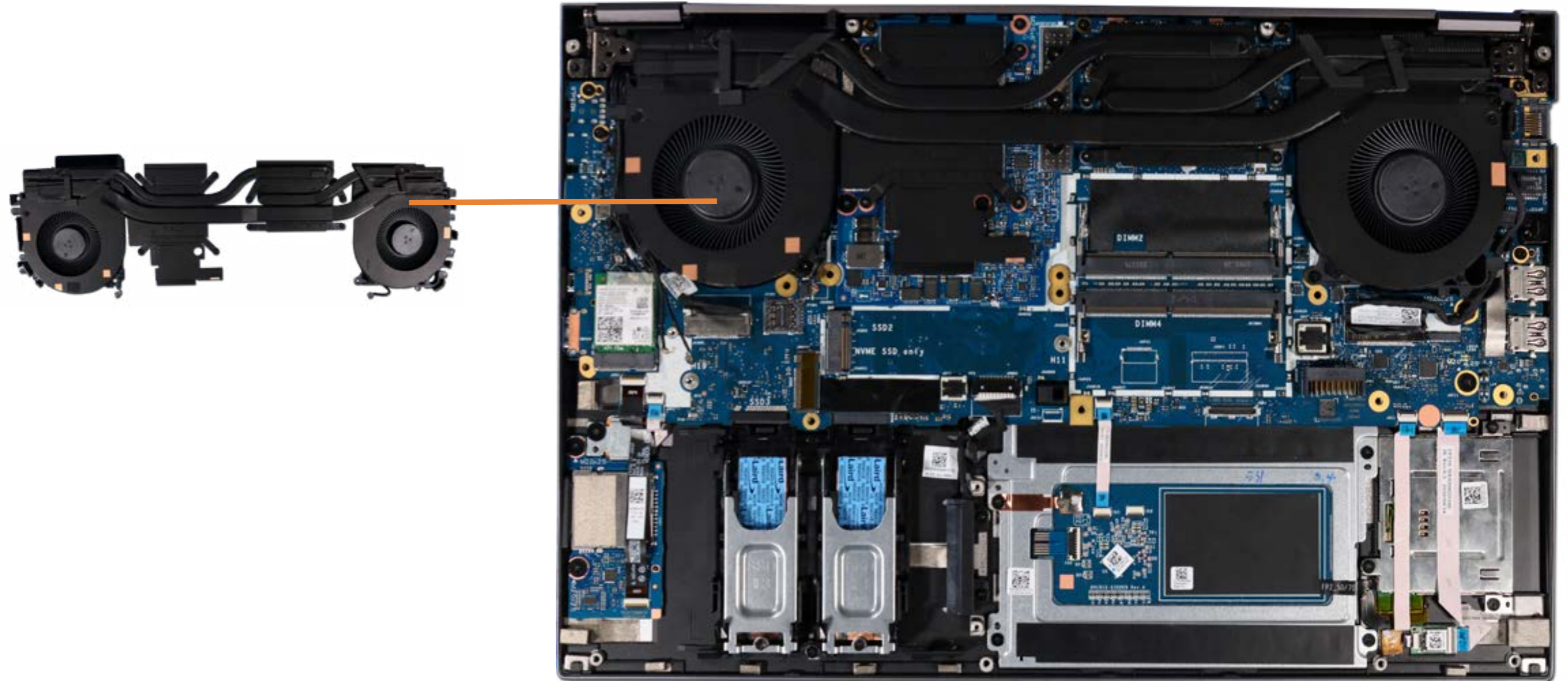

[Go to External Views](#)

Graphics Card

- Service Door
- Battery
- Hard Drive
- Secondary Memory Modules
- Secondary M.2 Solid State Drive
- Wireless LAN Module
- Keyboard
- Wireless WAN Module
- Wireless WAN Antennas (D cover)
- Primary Memory Modules
- Primary M.2 Solid State Drive
- Base Enclosure
- Fingerprint Reader
- SD Card Reader Board
- Smart Card Reader
- NFC Module
- Touchpad
- Heat Sink With Fans
- Graphics Card**
- Beam Connector
- System Board (Top)
- System Board (Bottom)
- I/O Board
- Speakers
- Top Cover
- Display Panel Assembly

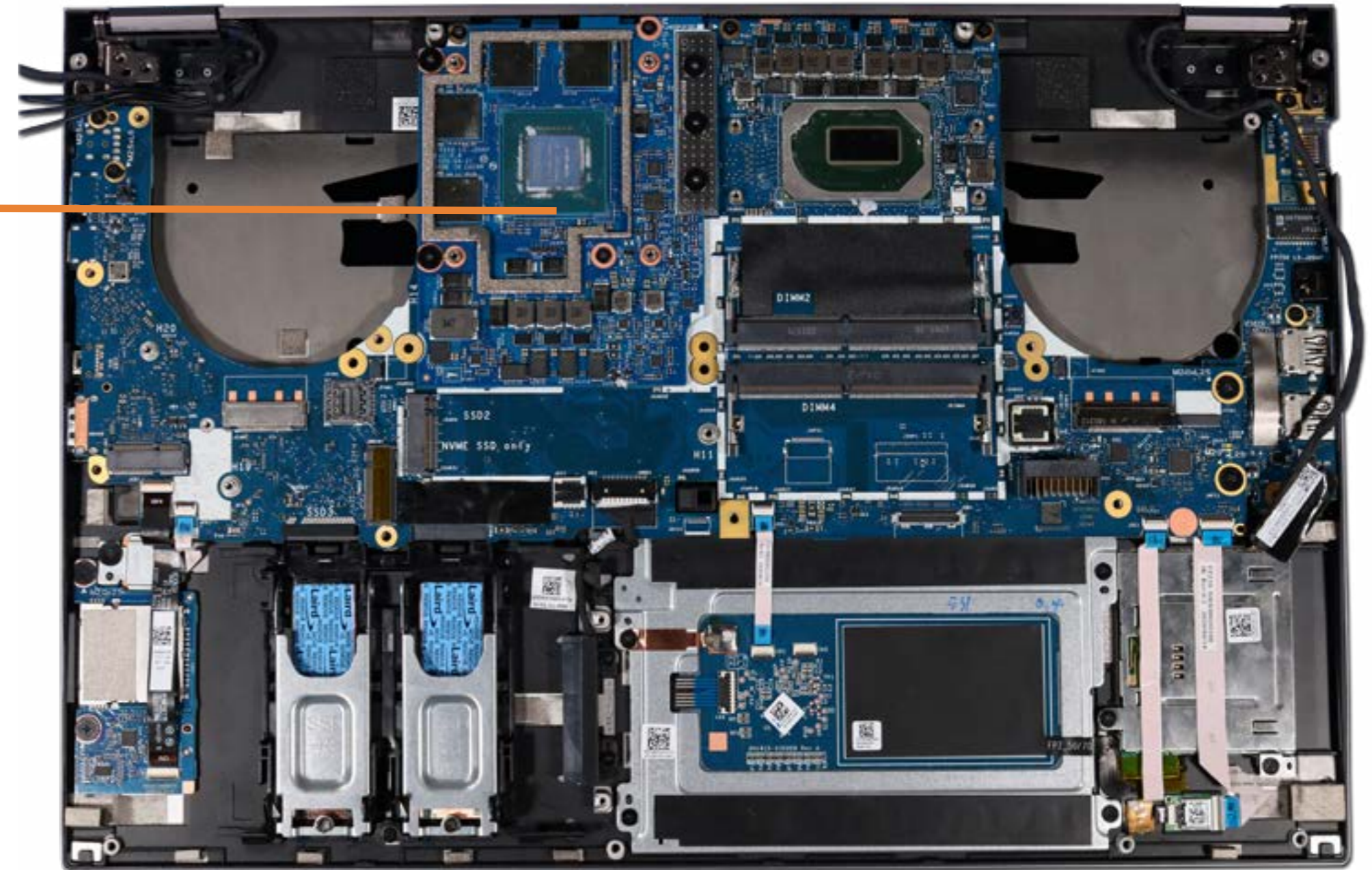
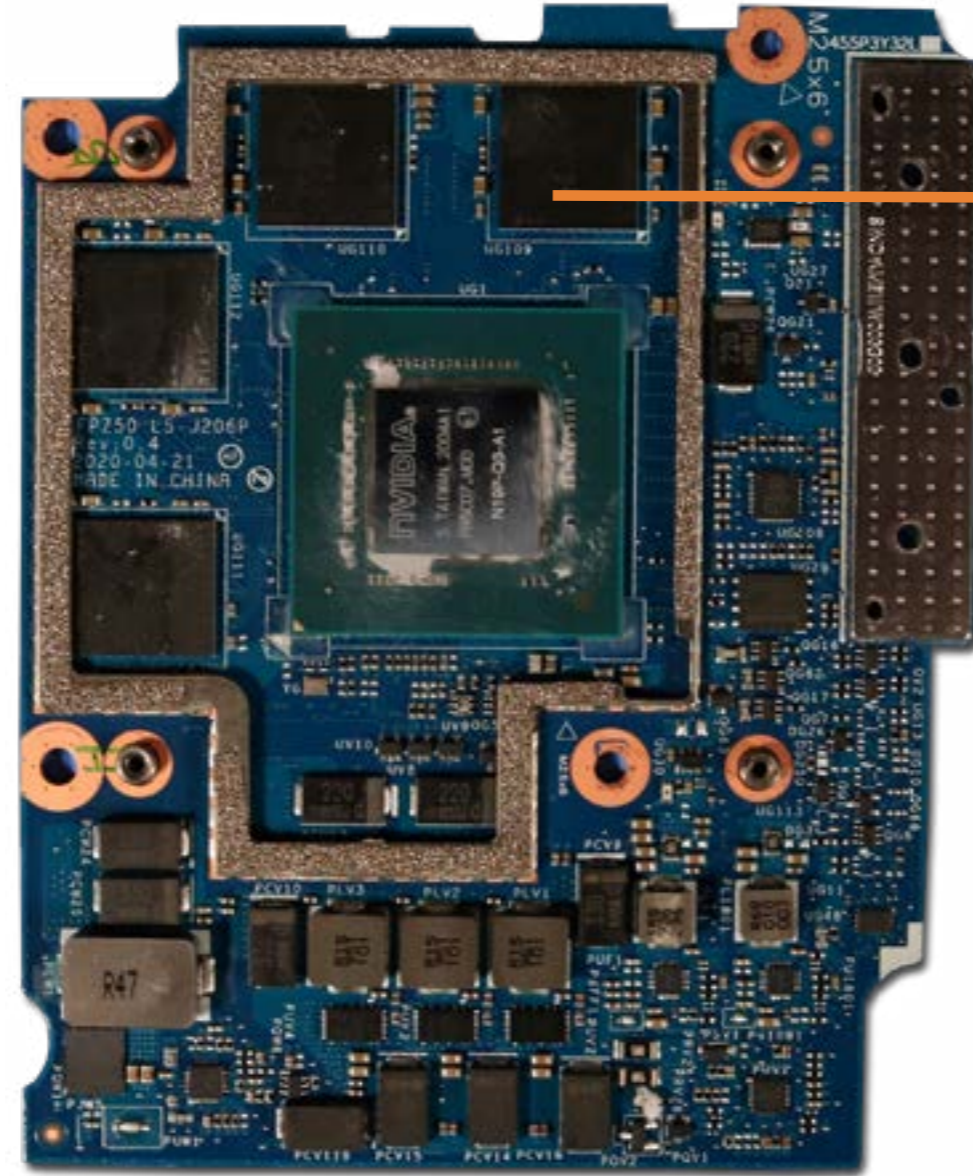

[Go to External Views](#)

Beam Connector

- Service Door
- Battery
- Hard Drive
- Secondary Memory Modules
- Secondary M.2 Solid State Drive
- Wireless LAN Module
- Keyboard
- Wireless WAN Module
- Wireless WAN Antennas (D cover)
- Primary Memory Modules
- Primary M.2 Solid State Drive
- Base Enclosure
- Fingerprint Reader
- SD Card Reader Board
- Smart Card Reader
- NFC Module
- Touchpad
- Heat Sink With Fans
- Graphics Card
- Beam Connector**
- System Board (Top)
- System Board (Bottom)
- I/O Board
- Speakers
- Top Cover
- Display Panel Assembly

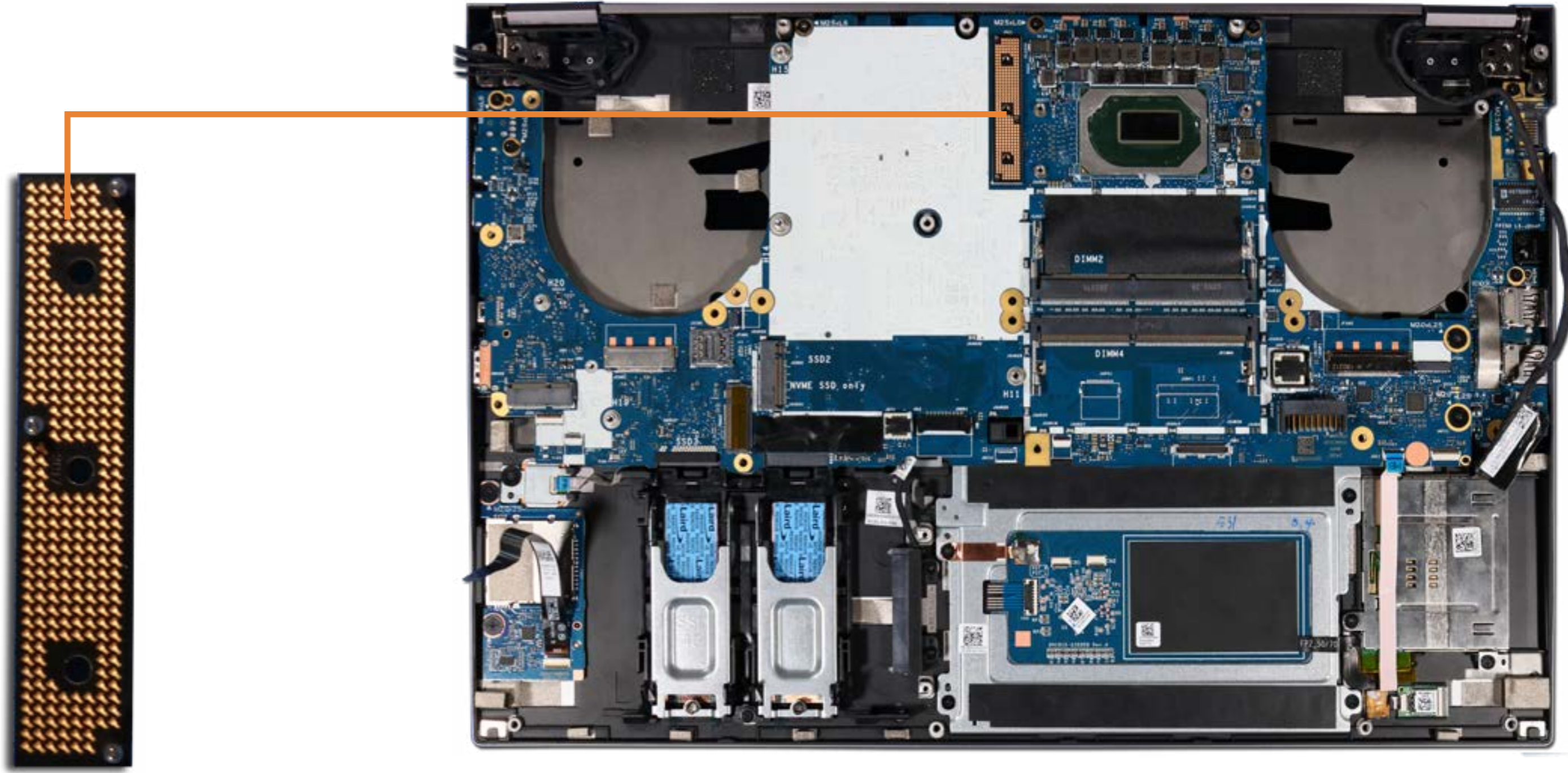

[Go to External Views](#)

System Board (Top)

- Service Door
- Battery
- Hard Drive
- Secondary Memory Modules
- Secondary M.2 Solid State Drive
- Wireless LAN Module
- Keyboard
- Wireless WAN Module
- Wireless WAN Antennas (D cover)
- Primary Memory Modules
- Primary M.2 Solid State Drive
- Base Enclosure
- Fingerprint Reader
- SD Card Reader Board
- Smart Card Reader
- NFC Module
- Touchpad
- Heat Sink With Fans
- Graphics Card
- Beam Connector
- System Board (Top)**
- System Board (Bottom)
- I/O Board
- Speakers
- Top Cover
- Display Panel Assembly

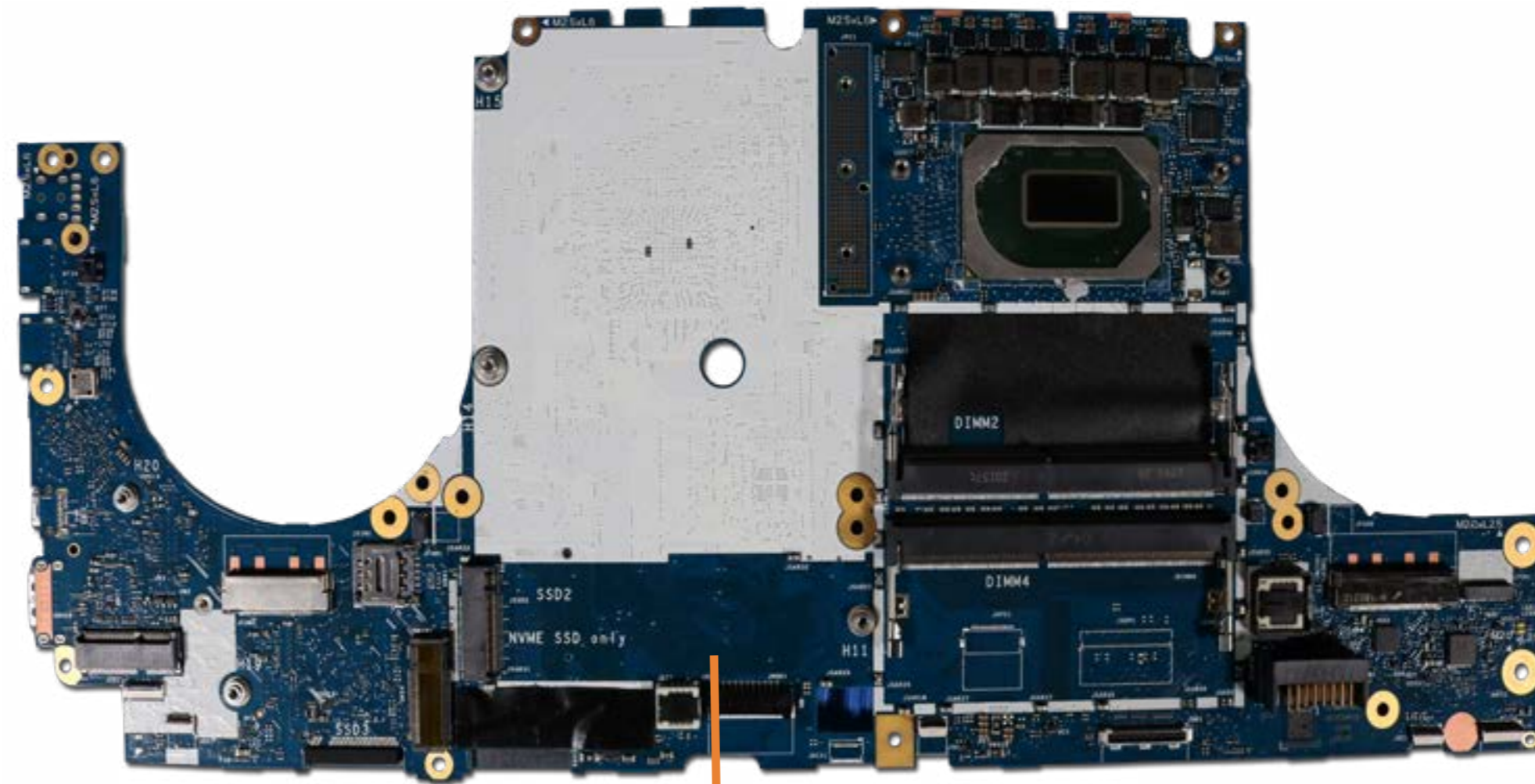

[Go to External Views](#)

System Board (Bottom)

- Service Door
- Battery
- Hard Drive
- Secondary Memory Modules
- Secondary M.2 Solid State Drive
- Wireless LAN Module
- Keyboard
- Wireless WAN Module
- Wireless WAN Antennas (D cover)
- Primary Memory Modules
- Primary M.2 Solid State Drive
- Base Enclosure
- Fingerprint Reader
- SD Card Reader Board
- Smart Card Reader
- NFC Module
- Touchpad
- Heat Sink With Fans
- Graphics Card
- Beam Connector
- System Board (Top)
- System Board (Bottom)**
- I/O Board
- Speakers
- Top Cover
- Display Panel Assembly

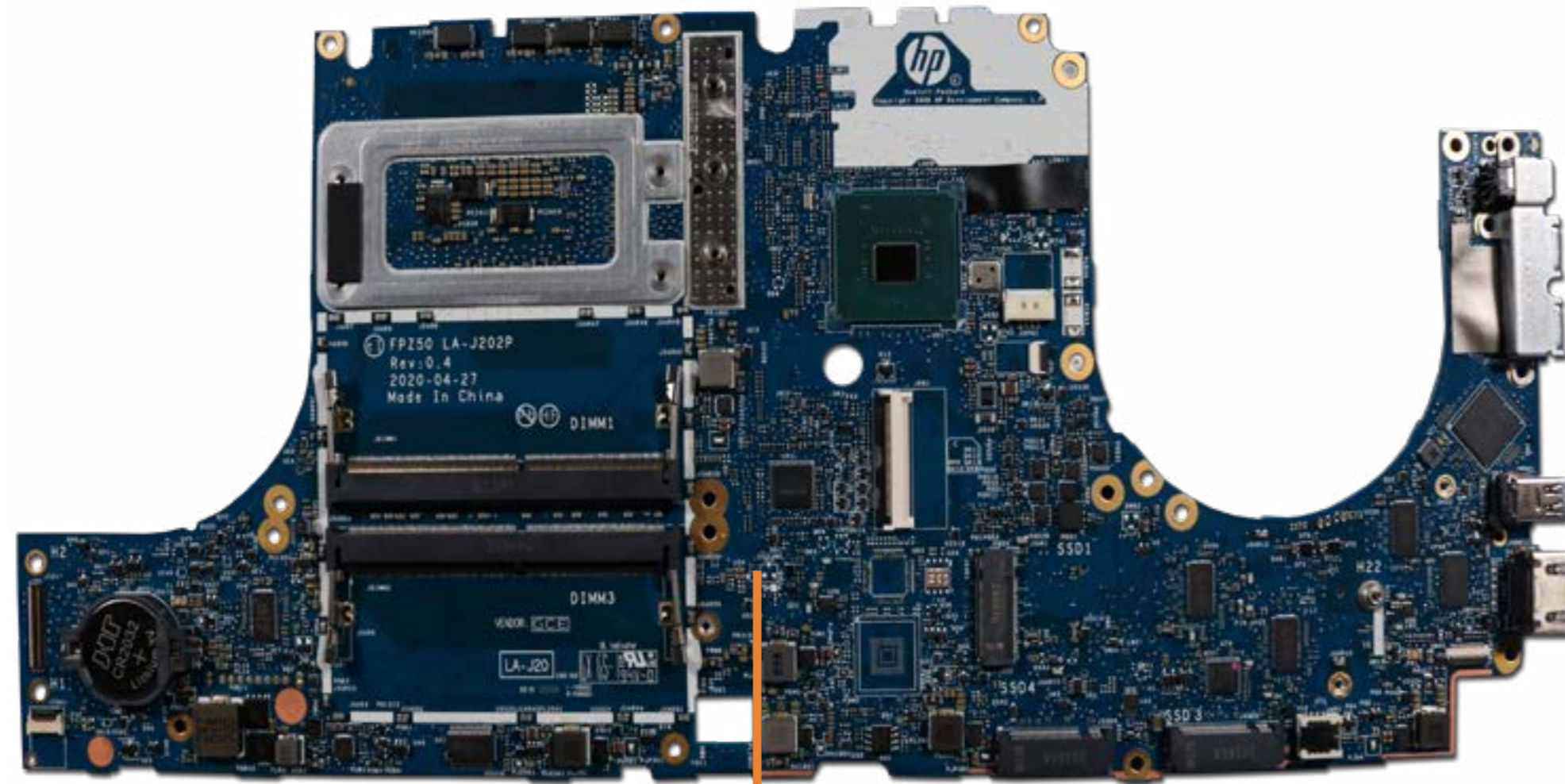

[Go to External Views](#)

I/O Board

- Service Door
- Battery
- Hard Drive
- Secondary Memory Modules
- Secondary M.2 Solid State Drive
- Wireless LAN Module
- Keyboard
- Wireless WAN Module
- Wireless WAN Antennas (D cover)
- Primary Memory Modules
- Primary M.2 Solid State Drive
- Base Enclosure
- Fingerprint Reader
- SD Card Reader Board
- Smart Card Reader
- NFC Module
- Touchpad
- Heat Sink With Fans
- Graphics Card
- Beam Connector
- System Board (Top)
- System Board (Bottom)
- I/O Board**
- Speakers
- Top Cover
- Display Panel Assembly

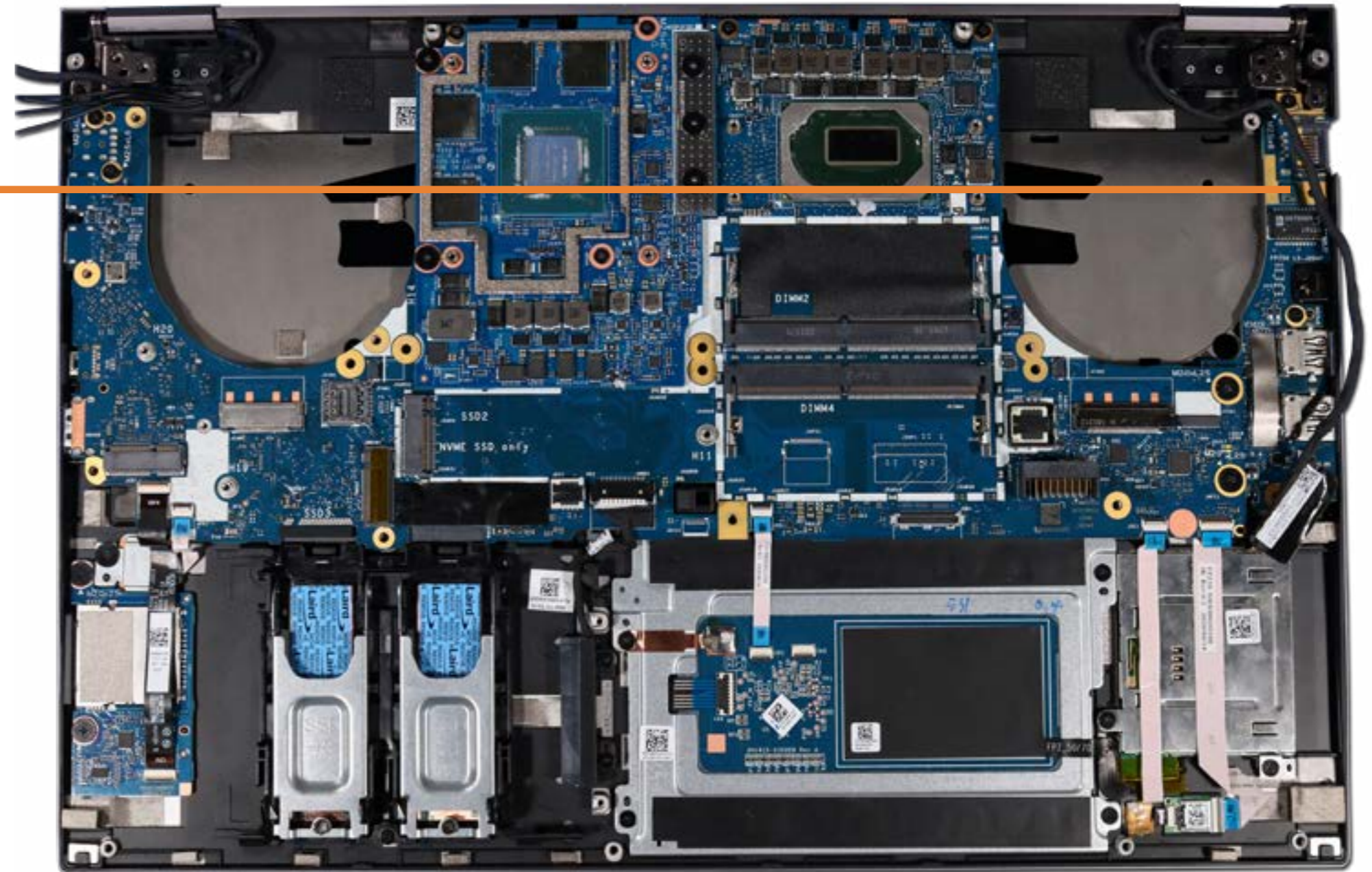
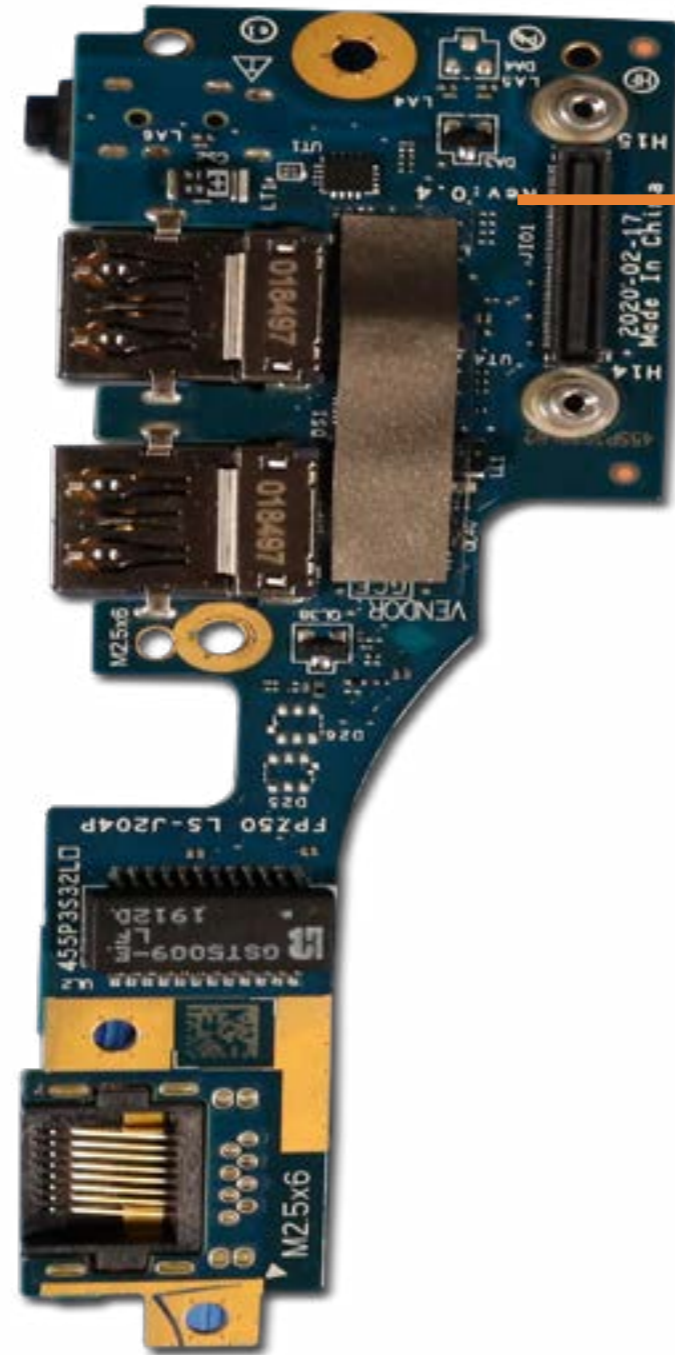

[Go to External Views](#)

Speakers

- Service Door
- Battery
- Hard Drive
- Secondary Memory Modules
- Secondary M.2 Solid State Drive
- Wireless LAN Module
- Keyboard
- Wireless WAN Module
- Wireless WAN Antennas (D cover)
- Primary Memory Modules
- Primary M.2 Solid State Drive
- Base Enclosure
- Fingerprint Reader
- SD Card Reader Board
- Smart Card Reader
- NFC Module
- Touchpad
- Heat Sink With Fans
- Graphics Card
- Beam Connector
- System Board (Top)
- System Board (Bottom)
- I/O Board
- Speakers**
- Top Cover
- Display Panel Assembly

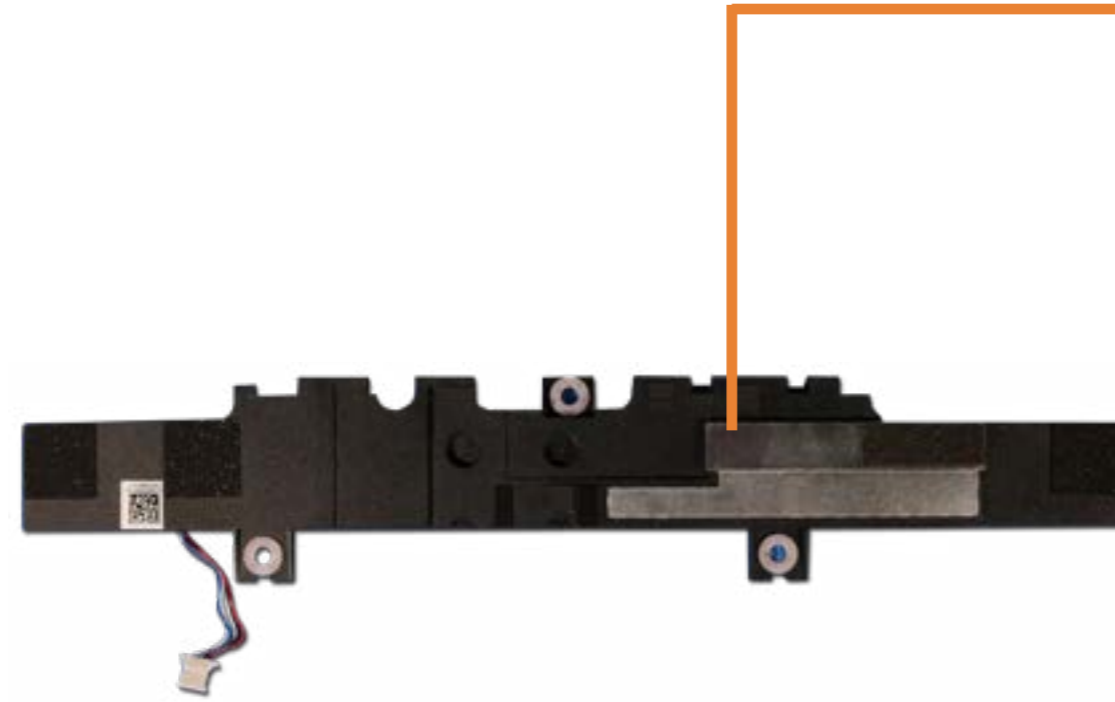

[Go to External Views](#)

Top Cover

- Service Door
- Battery
- Hard Drive
- Secondary Memory Modules
- Secondary M.2 Solid State Drive
- Wireless LAN Module
- Keyboard
- Wireless WAN Module
- Wireless WAN Antennas (D cover)
- Primary Memory Modules
- Primary M.2 Solid State Drive
- Base Enclosure
- Fingerprint Reader
- SD Card Reader Board
- Smart Card Reader
- NFC Module
- Touchpad
- Heat Sink With Fans
- Graphics Card
- Beam Connector
- System Board (Top)
- System Board (Bottom)
- I/O Board
- Speakers
- Top Cover**
- Display Panel Assembly



Go to External Views

Display Panel Assembly

- Service Door
- Battery
- Hard Drive
- Secondary Memory Modules
- Secondary M.2 Solid State Drive
- Wireless LAN Module
- Keyboard
- Wireless WAN Module
- Wireless WAN Antennas (D cover)
- Primary Memory Modules
- Primary M.2 Solid State Drive
- Base Enclosure
- Fingerprint Reader
- SD Card Reader Board
- Smart Card Reader
- NFC Module
- Touchpad
- Heat Sink With Fans
- Graphics Card
- Beam Connector
- System Board (Top)
- System Board (Bottom)
- I/O Board
- Speakers
- Top Cover
- Display Panel Assembly**



[Go to External Views](#)