



Maintenance and Service Guide

27xq model

SUMMARY

This guide provides information about spare parts, removal and replacement of parts, diagnostic tests, problem troubleshooting, and more.

© Copyright 2021 HP Development Company, L.P.

AMD is a trademark of Advanced Micro Devices, Inc. Bluetooth is a trademark owned by its proprietor and used by HP Inc. under license. NVIDIA is a trademark and/or registered trademark of NVIDIA Corporation in the U.S. and other countries. USB Type-C and USB-C are registered trademarks of USB Implementers Forum. DisplayPort and the DisplayPort logo are trademarks owned by the Video Electronics Standards Association (VESA) in the United States and other countries.

The information contained herein is subject to change without notice. The only warranties for HP products and services are set forth in the express warranty statements accompanying such products and services. Nothing herein should be construed as constituting an additional warranty. HP shall not be liable for technical or editorial errors or omissions contained herein.

Second Edition: April 2021

Document Part Number:

L26091-27xq-MSG-V2

Assembly part number: L26091-001

Product notice

Only trained service personnel familiar with this product should service it. Before performing any maintenance or service, be sure to read "Important Safety Information".

Table of Contents

Getting started	2
Important safety information	2
RoHS (2002/95/EC) requirements.....	3
General descriptions.....	3
Before return to receiver:	3
Monitor features	4
Features	4
Front components.....	5
Rear components	6
Locating the serial number and product number	7
Illustrated parts catalog.....	8
How to order parts.....	9
Removal and replacement procedures	10
Preparation for disassembly	10
Power board replacement.....	14
Power board- Capacitor repair C707, C708 and C709.....	15
Main board- Connector repair (Audio, HDMI and DisplayPort)	18
Audio Connector repair- M590.....	19
HDMI Connector repair- J5.....	20
DP Connector repair- J3.....	21
Stick Gasket on the Shielding	22
Function Test:.....	23
Support and Troubleshooting	24
Index.....	25

Getting started

Read this chapter to learn about safety information and where to find additional HP resources.

Important safety information

It is important to note that this manual contains various CAUTIONS and NOTICES which should be carefully read in order to minimize the risk of personal injury to service personnel. Proper service and repair are important to the safe, reliable operation equipment.

The possibility exists that improper service methods may damage the equipment. It is also important to understand that these CAUTIONS and NOTICES ARE NOT EXHAUSTIVE.

The service procedures recommended and described in this service manual with effective methods of performing service operations. It is recommended that service engineers should have repairing knowledge, experience as well as appropriate product training per new model before performing the service procedures.

- Be sure your working environment is dry and clean and meets all government safety requirements.
- Be sure that other persons are safe while you are servicing the product.
- Do not perform any action that can cause a hazard to the customer or make the product unsafe.
- Use proper safety devices to ensure your personal safety.
- Always use approved tools and test equipment for servicing.
- Never assume the product's power is disconnected from the main power supply. Check that it is disconnected before opening the product's cabinet.
- Modules containing electrical components are sensitive to electrostatic discharge (ESD). Follow ESD safety procedures while handling these parts.
- Some products contain more than one battery. Do not disassemble or expose a battery to high temperatures, such as throwing into fire, or the battery may explode.
- Refer to government requirements for battery recycling or disposal.

This information provides general service information for the monitor. Adherence to the procedures and precautions is essential for proper service.

IMPORTANT:

Only trained service personnel who are familiar with this HP Product shall perform service or maintenance to it. Before performing any maintenance or service, the engineer **MUST** read the "Safety Note".

You must disconnect the power cord from the power source before opening the monitor to prevent component damage.

RoHS (2002/95/EC) requirements

Applied to all countries that require RoHS.

The RoHS (Restriction of Hazardous Substance in Electrical and Electronic Equipment Directive) is a legal requirement by the EU (European Union) for the global electronics industry sold in the EU and other countries. Any electrical and electronics products launched in the market after June 2006 should meet this RoHS requirement. Products launched in the market before June 2006 are not required to be compliant with RoHS parts. If the original parts are not RoHS compliant, the replacement parts can be non-ROHS compliant. If the original parts are RoHS compliant, the replacement parts **MUST** be RoHS compliant.

If product service or maintenance requires replacing parts, confirm the RoHS requirement before replacement.

General descriptions

This manual contains general information. There are two levels of service:

Level 1: Cosmetic/appearance/alignment service

Level 2: Circuit board or standard parts replacement

Before return to receiver:

- Please always perform an AC leakage current check on the exposed metallic parts to be sure the set is safe to operate without damage of electrical shock.
- Do not use a line Isolation Transformer during this check.
- In case any measurement is out of the limits specified, there is possibility of shock hazard and the set must be checked and repaired before it is returned to the customer.

Monitor features

This chapter provides an overview of the monitor's features.

Features

Depending on the model, your monitor might include the following features:

- 68.58 cm (27-inch) diagonal viewable screen area with 2560 x 1440 resolution, plus full screen support for lower resolutions; includes custom scaling for maximum image size while preserving original aspect ratio
- Anti-glare screen with an LED backlight
- Wide viewing angle to allow viewing from a sitting or standing position, or moving from side to side
- Tilt capability
- Pivot capability to rotate the display head from landscape to portrait mode
- Swivel and height adjustment capabilities
- Removable stand for flexible display head mounting solutions
- DP (DisplayPort) video input
- HDMI (High-Definition Multimedia Interface) video input
- Audio headphone/variable line-out jack
- Plug-and-play capability if supported by your operating system
- Security cable slot provision on rear of monitor for optional security cable
- On-Screen Display (OSD) adjustments in several languages for easy setup and screen optimization
- HDCP (High-Bandwidth Digital Content Protection) copy protection on all digital inputs
- Energy saver feature to meet requirements for reduced power consumption

NOTE: For safety and regulatory information, refer to the Product Notices provided in your documentation kit. To locate updates to the user guide for your product, go to <http://www.hp.com/support> to download the latest versions of HP programs and drivers

Front components

To identify the components on the front of the monitor, use this illustration and table.

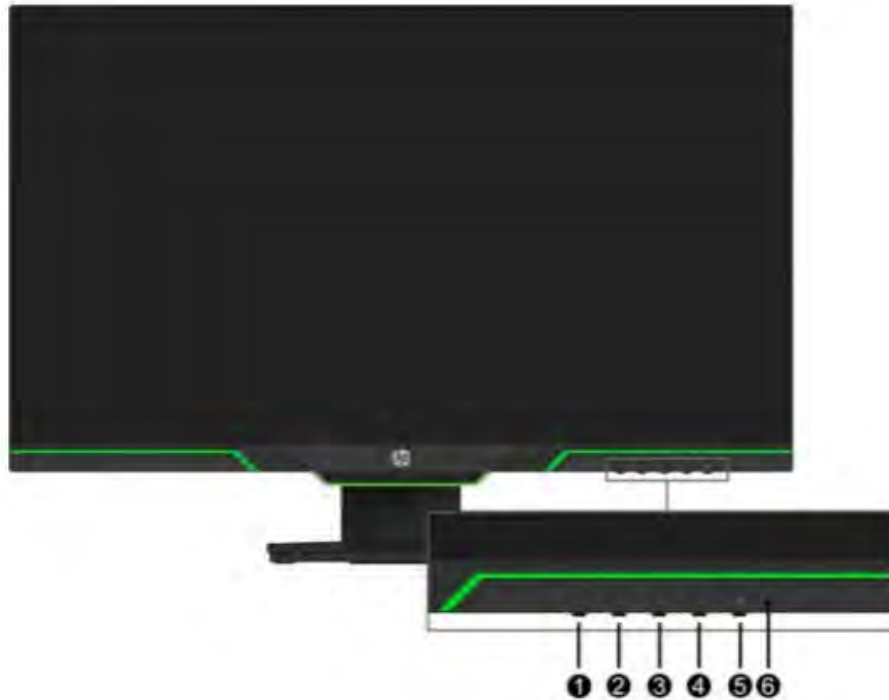

Table 1-1: Front components and their descriptions

Component	Function
1 Menu button	Press to open the OSD menu, select a menu item from the OSD, or close the OSD menu.
2-4 Function buttons	Use these buttons to navigate through the OSD menu based on the indicators next to the buttons that are activated while the OSD menu is open. You can reconfigure the function buttons in the OSD menu to quickly select the most commonly used operations.
5 Power button	Turns the monitor on or off.
6 Power light	Green: The monitor is on. Orange: The monitor is in standby mode.

Rear components

To identify the components on the rear of the monitor, use this illustration and table.

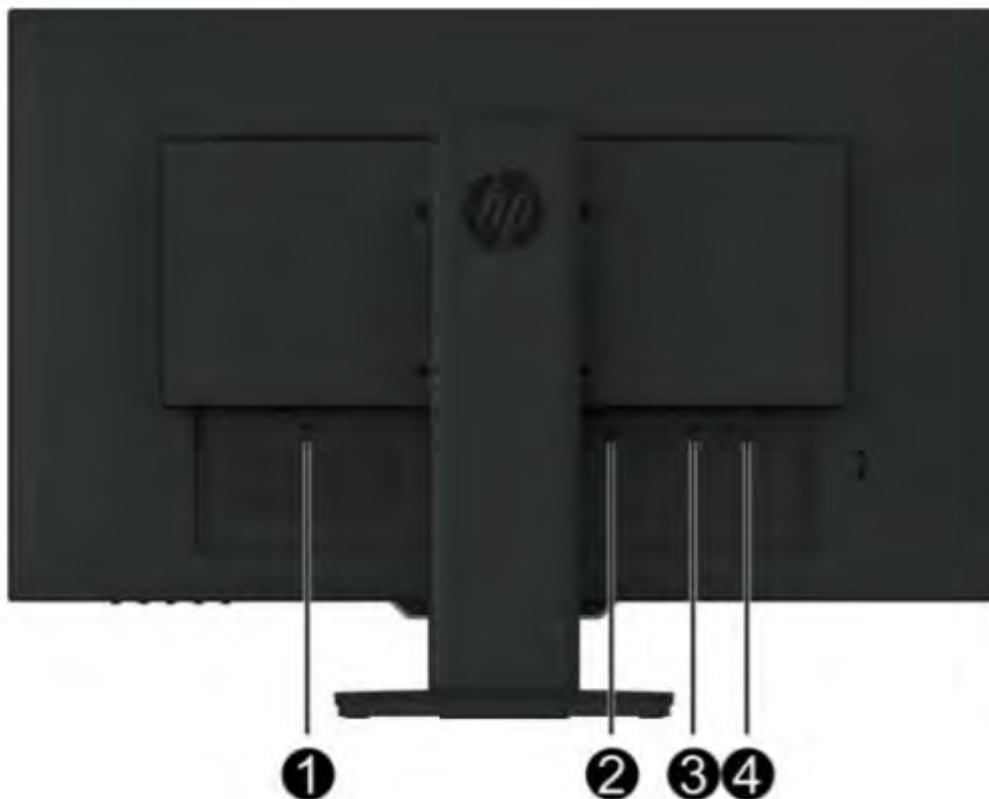

Table 1-2: Rear components and their descriptions

Component	Function
1 Power connector	Connects the power cable to monitor
2 Audio-out (headphone) jack	Connects headphone to the monitor. To reduce the risk of personal injury, adjust the volume before using headphones, earbuds, or a headset. For additional safety information, refer to the Product Notice provided in your documentation kit.
3 HDMI connector	Connects the HDMI cable to the monitor.
4 DP connector	Connects the DP cable to the monitor.

Locating the serial number and product number

The serial number and product number are located on a label on the back of display. You may need these numbers when contacting HP about the monitor model.

Note: You may need to partially pivot the display head to read the label.



Illustrated parts catalog

To identify the monitor major components, use this illustration and table.

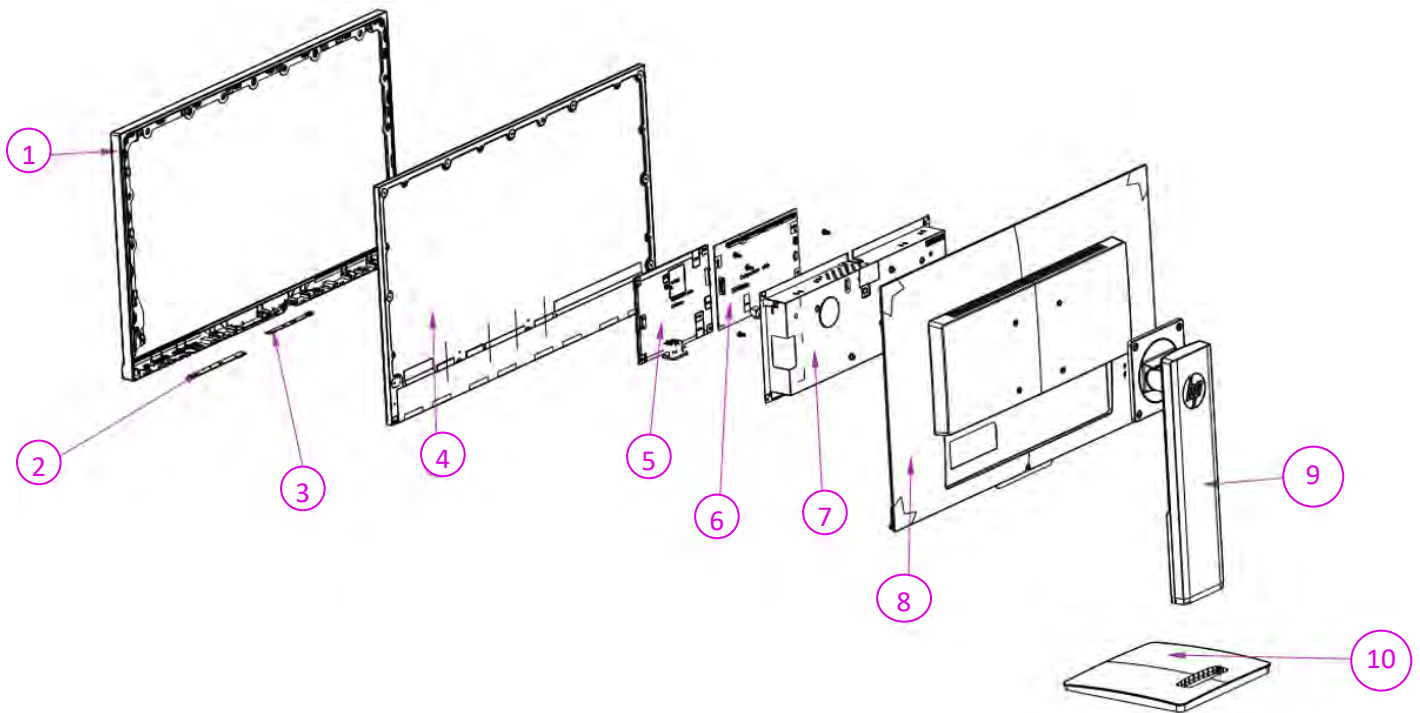

Table 2-1: Monitor major components and their descriptions

Item	Description	Qty
1	ASSY MF 27XQ	1
2	PCBA CTRL BD 27XQ	1
3	PCBA LENS BD SMD 27XQ	1
4	PANEL	1
5	PCBA IF BD	1
6	PCBA SPS BD	1
7	SHIELDING	1
8	ASSY RC 27XQ	1
9	ASSY COLUMN 27XQ	1
10	ASSY BASE 27XQ	1

How to order parts

The HP authorized repair center can purchase power board from HP.

Power board:

Description	HP Spares Part Number	Manufacturer Part Number
PSU 27xq 5E.45202.001	M81289-001	5E.45202.001
PSU 27xq IEC62368 5E.45202.002	M81289-002	5E.45202.002

Capacitors and connectors available for purchase from EU distributor

- Farnell: [Farnell UK - Electronic Components Distributor](#)
- RS Component: [Capacitors | RS Components \(rs-online.com\)](#)

Capacitors by Distributor:

Component Description	Location	Component Distributor	Distributor Part Number
Capacitor 470 µF 10*12.5 10K	C707 C708	Farnell	25ZLH470MEFC10X12.5
Capacitor 470 µF 10*12.5 10K	C709	RS	25ZLH470MEFC10X12.5

Connectors by Distributor:

Component Description	Location Identifier	Component Distributor	Part number of Manufacturer/ Distributor
DisplayPort (DP)	J3	Farnell RS	Molex SD-47272-0024
HDMI	J5	Farnell RS	Molex 2086581001
Audio	M590	Farnell	STX-3120-5B

Gasket by Distributor:

Component Description	Location Identifier	Component Distributor	Part number of Manufacturer/ Distributor
Gasket for DP and HDMI	SHD	Farnell	3021717
Specification: Gasket, EMI Shielding, 17 mm Width, 17 mm Height, 1 m Length, 80 dB			

To replace DP or HDMI, must need a gasket stick on shielding.

Cables can be purchased from the HP Part Store

<https://partsurfer.hp.com/Search.aspx>

Removal and replacement procedures

Adherence to these procedures and precautions is essential for proper service.

Preparation for disassembly



Use this information to properly prepare to disassemble and reassemble the monitor.

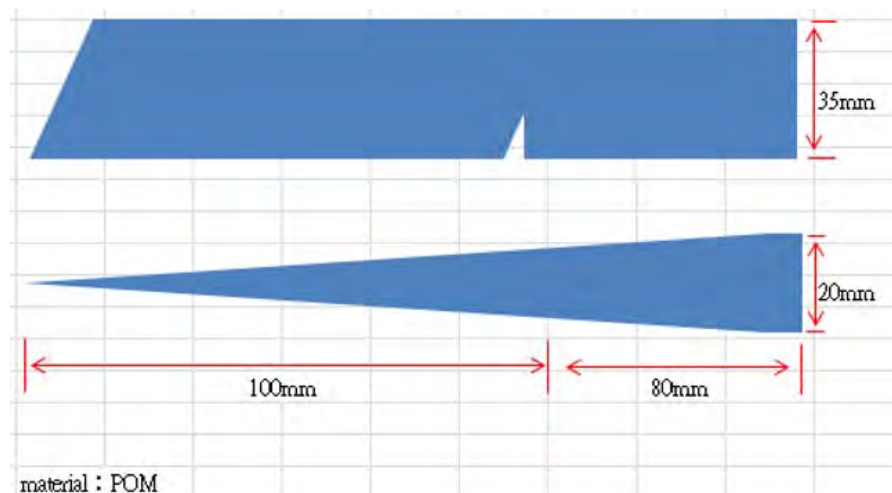

Use this information to properly prepare to disassemble and reassemble the monitor.

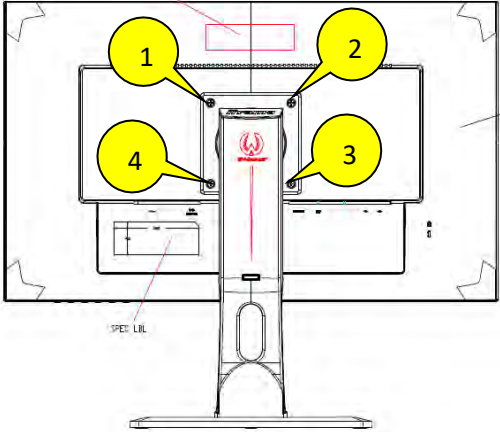

- 1) Clean the room for disassembly.
- 2) Identify the disassembly area.
- 3) Check the position that the monitors are to be placed along with the number of monitors. Prepare the area for material flow according to the disassembly layout.
- 4) Be sure to have the following equipment and materials:
 - Press fixture
 - Working table
 - Screwdriver
 - Knife
 - Gloves
 - Cleaning cloth
 - ESD protection
 - Scraper bar in the following dimensions:

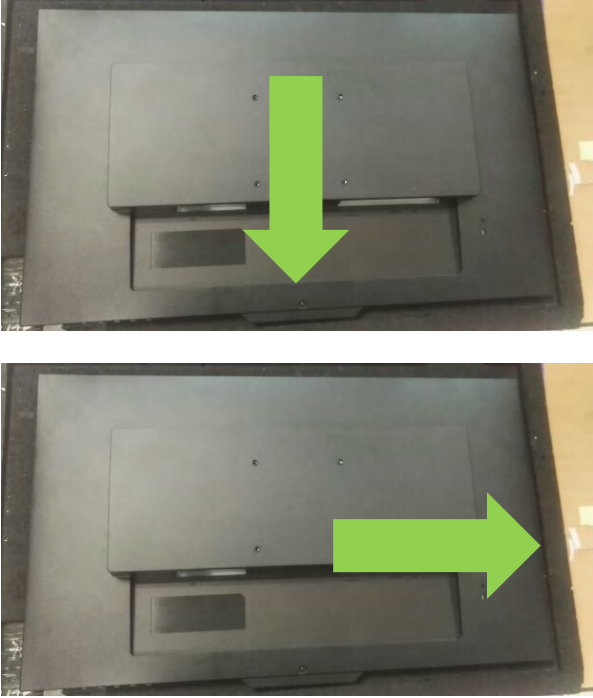

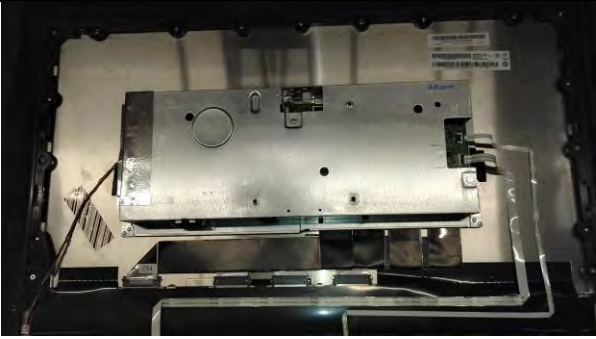
Disassembly procedure

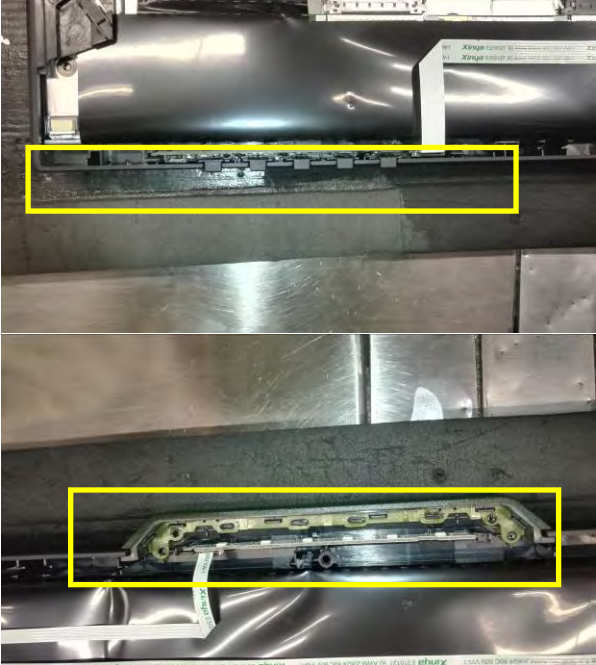
item	Picture	Operation	Tool	Notes
1		1.Unlock 4 pcs screws	Screw-driver	11±1.0Kgf
2		1.Unlock 1 pcs RC screws	Screw-driver	5.0±1.0Kgf
		Disassemble the RC from the monitor, notice the disassembly order: 1.Disassemble the Bottom part 2.Disassemble the Right part 3. Remove RC from middle frame.		

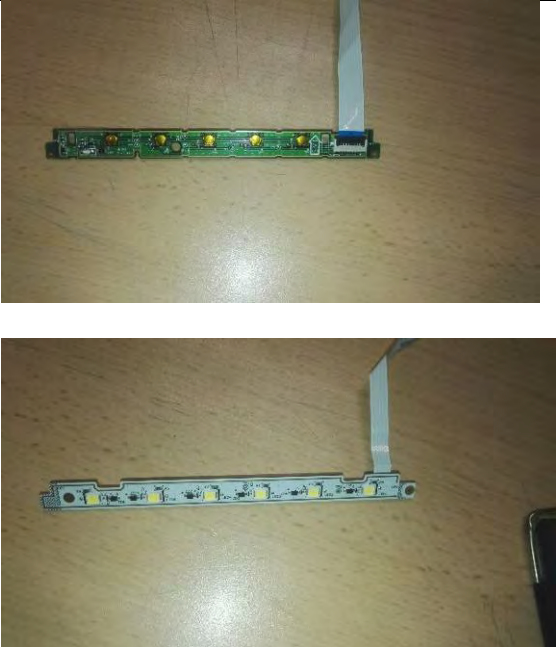
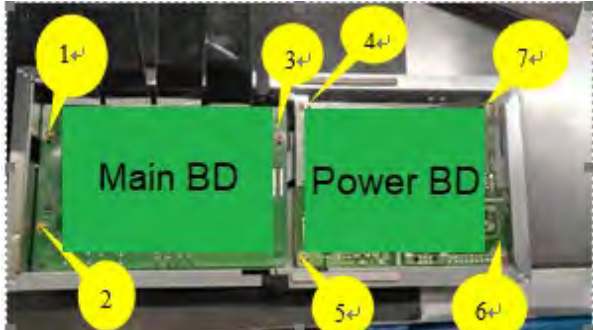
				
3		<ol style="list-style-type: none"> 1. Remove the CTR cable and LENS cable 2. Remove the 1 pcs AL tapes and 3 tapes. 3. Remove the lamp wire and 4 LVDS cable. 4. Remove the SHD. 		
4		<ol style="list-style-type: none"> 1. Disassemble the CTR cable and CTR BD from Panel. 2. Disassemble the LENS cable and LENS BD from Panel 		

5		<ol style="list-style-type: none"> 1. Unlock 9 pcs screws 2. Remove middle frame from panel. 3. Remove 2 mylar from the panel 	Screw-driver	6.5-7.5Kgf
6		<ol style="list-style-type: none"> 1. Disassemble the CTR BD and remove CTR cable. 2. Disassemble the LENS BD and remove LENS cable. 		
7		<ol style="list-style-type: none"> 1. Unlock the 7 pcs screws 	Screw-driver	7±1Kgf
8		<ol style="list-style-type: none"> 1. Disassemble Power BD and IF BD. 2. Disassemble the SPS wire 3. Disassemble FFC cable 		

Power board replacement

- The power board part number is 5E.45202.002. This board is a direct replacement for 5E.45202.002
- Locate PN on the red frame as follow image.

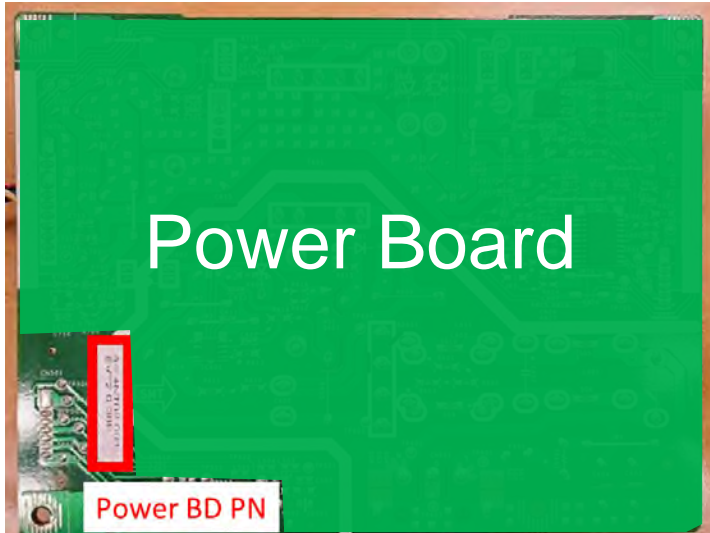

IMPORTANT:

- Repairing must operate by professional repairers in HP repair center, not applicable for end user
- The primary side is the high voltage area, please take care when repair (Front and Back view)

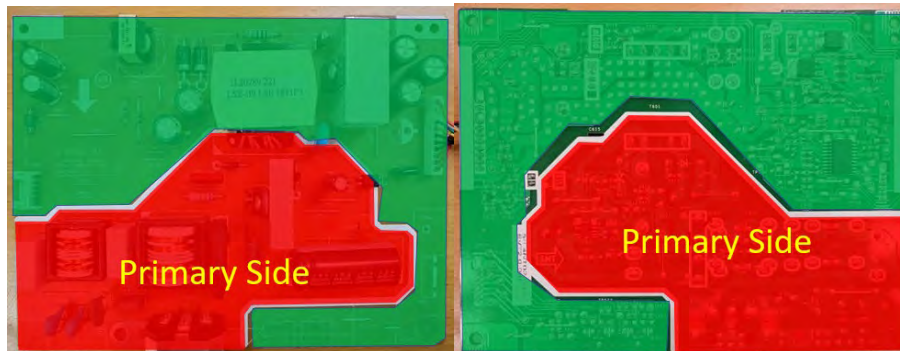

- After repaired, must check PSU function is ordinary

Power board- Capacitor repair C707, C708 and C709

Repair Condition: Capacitor repair is only for the monitor that has been out of warranty period.

IMPORTANT:

- Repairing must operate by professional repairers (Note) in repair center, not applicable for end user
- The primary side is the high voltage area, please take care when repair (Front and Back view)

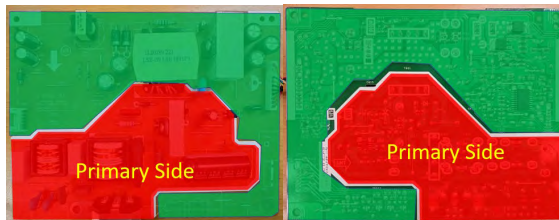

- Electrostatic protection is required when component replacement is required.
- The monitor meets ROHS, please use Lead-free solder wire for soldering.
- If capacitor need change, please check polarity match PCB print.
- If capacitor need to replace, must check specification and part number whether match the BOM and location.
- If capacitor need to replace, please insert new parts carefully because the near pin may cause short circuit by inappropriate operate.
- DO NOT allow any liquid on the board. Water and moisture may cause short-circuit to the electronic components and lead to malfunctions.
- The fusion point of Lead-Free solder is requested. Repairing with conventional lead wire may cause damage.
- Work quickly to avoid overheating the circuit board as soon as you confirm the steady soldering condition.
- Keep the soldering iron tip clean and well tinned and when replacing parts.
- A close inspection of the circuit board revealed look in good condition.
- After repaired, must do function test to check PSU function is ordinary.

Note: (The requirement of professional repairers' regulation by ERP lot5)

- (1) The professional repairer has the technical competence to repair electronic displays and complies with the applicable regulations for repairers of electrical equipment in the Member States where it operates. Reference to an official registration system as professional repairer, where such system exists in the Member States concerned, shall be accepted as proof of compliance with this point.

- (2) The professional repairer is covered by insurance covering liabilities resulting from its activity, regardless of whether this is required by the Member State.

Repair Process:

When EL capacitors damage or explode, it may lose function and cause product no work.

The C707, C708 and C709 locations are identified below:

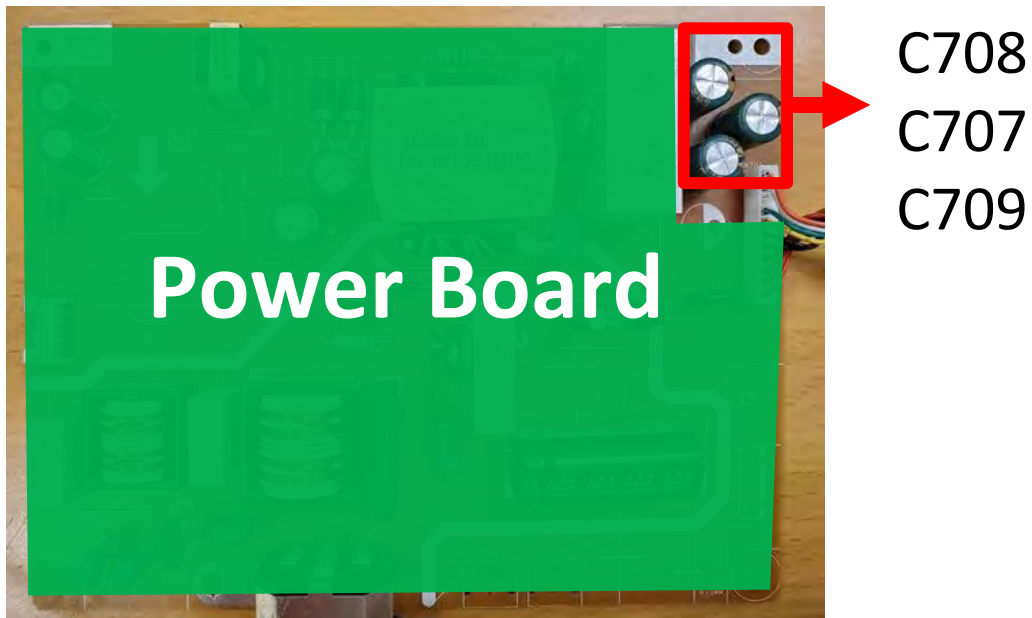

- 1) You must disconnect the power cord from the power source before opening the monitor to prevent component damage.
- 2) Use Multimeter measure whether EL capacitors still have charge. Before repairing must discharging it.

C605/ C801/ C703/ C708/C707/C709 in following picture need to discharging.

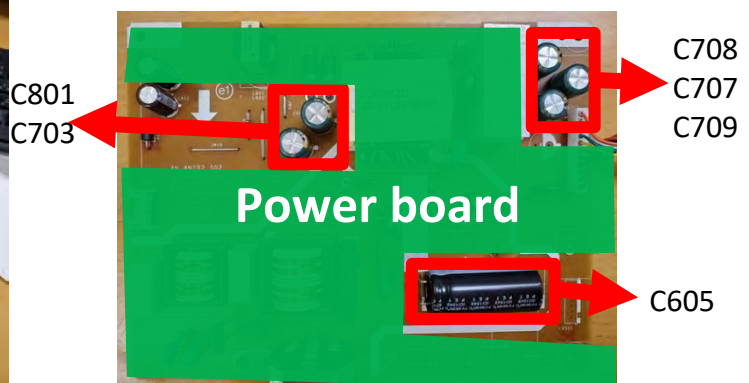

3) Lift capacitors from the PCB.

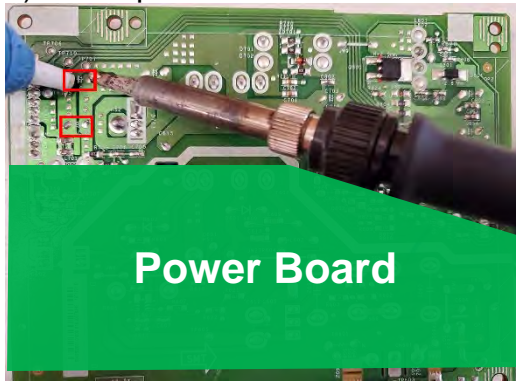

4) Place new component on the location, and must check polarity match PCB print.

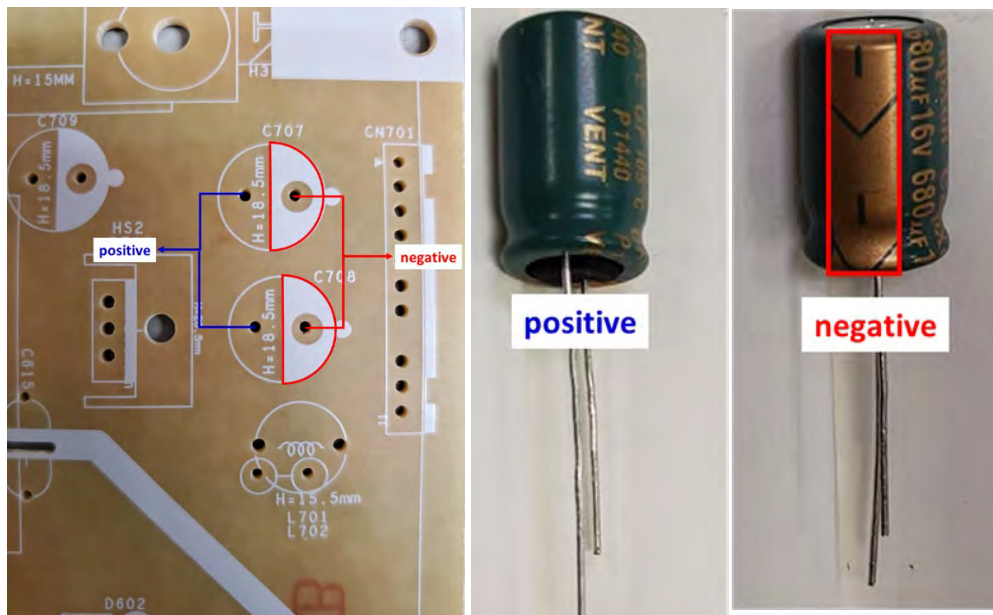
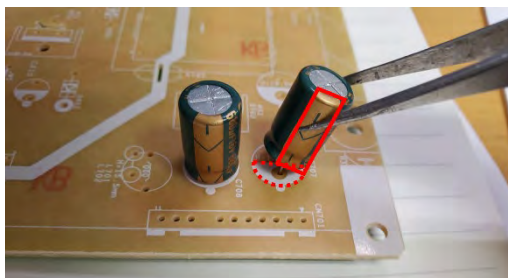

5) After repaired, please double check whether polarity match PCB print, solder empty and unnecessary solder after soldering must remove.

Main board- Connector repair (Audio, HDMI and DisplayPort)

Repair Condition: Connector repair is only for the monitor that has been out of warranty period.

- The repair procedure is for Audio, HDMI and DisplayPort connectors.
- The connectors are on the main board (IF board part number 5E.45201.011).
- Please refer to the location to repair the correct parts:

Connector	Location
Audio	M590
HDMI	J5
DisplayPort	J3

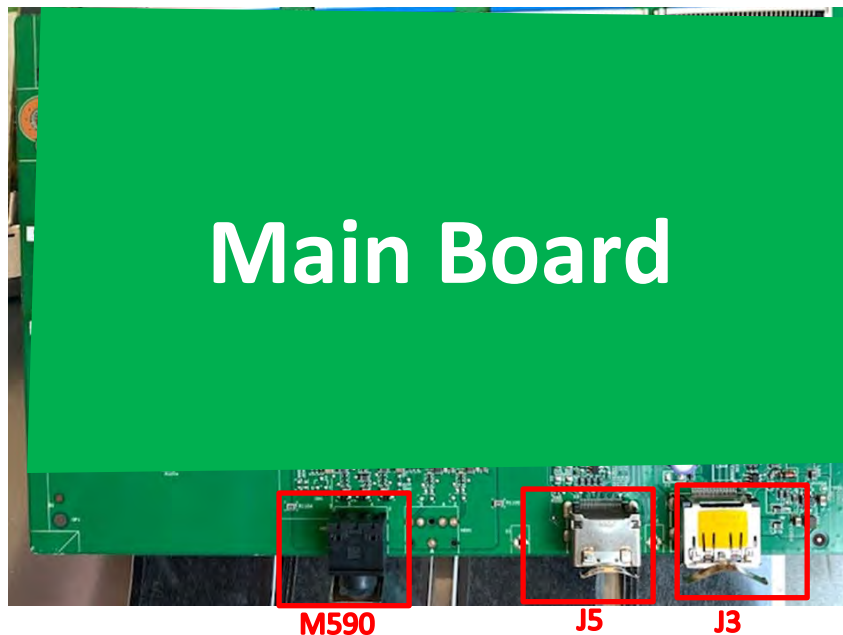

IMPORTANT:

- **Repair Condition: Connector repair is only for out of warranty.**
- **Repairing must operate by professional repairers (Note) in repair center, not applicable for end user.**
- **Electrostatic protection is required when component replacement is required.**
- **The monitor meets ROHS, please use Lead-free solder wire for soldering.**
- **If Connector need to replace, must check specification and part number whether match the BOM and location.**
- **If connector need to replace, please insert new parts carefully because the near pin may cause short circuit by inappropriate operate.**

- **DO NOT allow any liquid on the board. Water and moisture may cause short-circuit to the electronic components and lead to malfunctions.**
- **The fusion point of Lead-Free solder is requested. Repairing with conventional lead wire may cause damage.**
- **Work quickly to avoid overheating the circuit board as soon as you confirm the steady soldering condition.**
- **Keep the soldering iron tip clean and well tinned and when replacing parts.**
- **A close inspection of the circuit board revealed look in good condition.**
- **After repaired, must connect source to each port to check Main board function is ordinary.**

Note: (The requirement of professional repairers' regulation by ERP lot5)

- (1) The professional repairer has the technical competence to repair electronic displays and complies with the applicable regulations for repairers of electrical equipment in the Member States where it operates. Reference to an official registration system as professional repairer, where such system exists in the Member States concerned, shall be accepted as proof of compliance with this point.
- (2) The professional repairer is covered by insurance covering liabilities resulting from its activity, regardless of whether this is required by the Member State.

Audio Connector repair- M590

- 1) Use a hot air gun to melt the solder on the pins Pin solder with soldering iron and absorber.

You can gently push down with the soldering iron once everything is molten to move the M1 out of the through holes

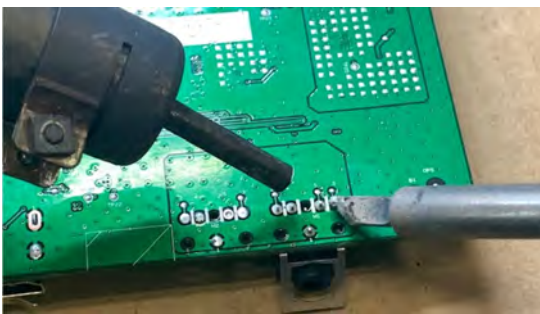

- 2). Lift M1 from the PCB
- 3). Place new component on the location, and must check it can match PCB footprint
- 4). Soldering the new component by solder iron

HDMI Connector repair- J5

- 1) Use a soldering iron and a de-soldering pump to remove as much solder as possible from one of the pins.

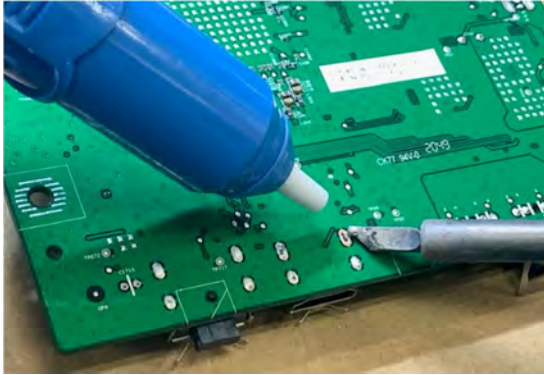

- 2) Use a hot air gun to melt the solder on the pins

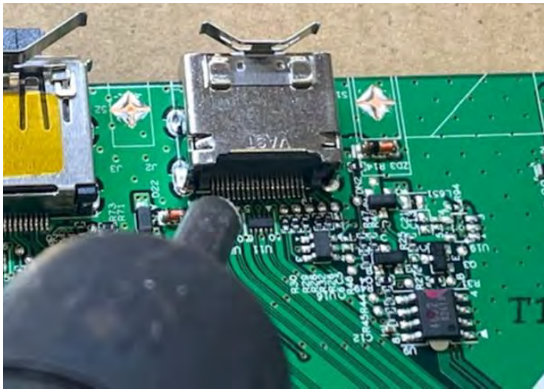

- 3). Lift J2 from the PCB
- 4). Place new component on the location, and must check it can match PCB footprint
- 5). Soldering the new component by solder iron
- 6). Please must stick a gasket on the Shielding. Find the procedure on page 22.

DP Connector repair- J3

- 1) Use a soldering iron and a de-soldering pump to remove as much solder as possible from one of the pin.

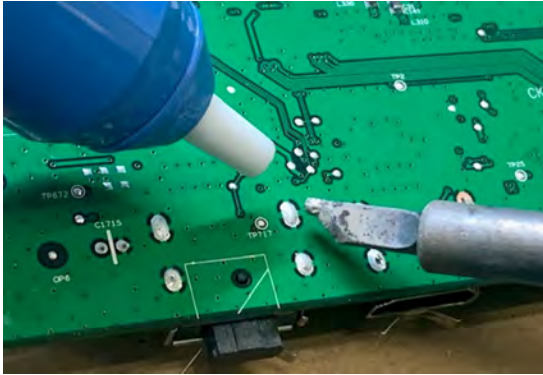

- 2) Use a hot air gun to melt the solder on the pins

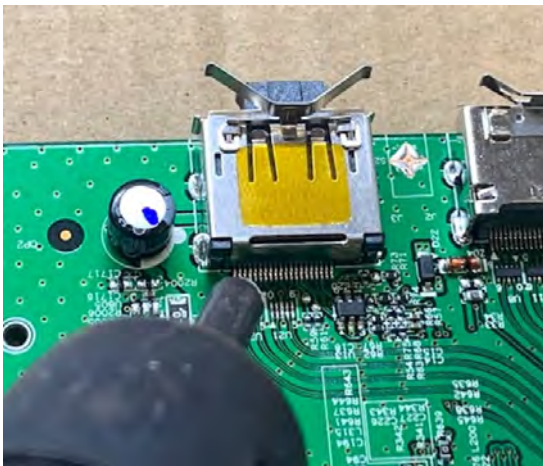

- 3) Lift J3 from the PCB
- 4) Place new component on the location, and must check it can match PCB footprint
- 5) Soldering the new component by solder iron
- 6) Tear off the yellow tape on the DP connector, so that it can contact to the gasket, EMI will be effective.

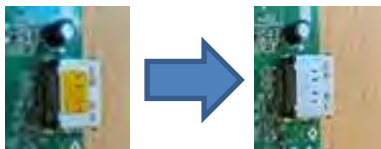

- 7). Please must stick a gasket on the Shielding. Find the procedure on page 22.

Stick Gasket on the Shielding

- 1) Use scissors to cut the length of gasket 3021717 in 20mm.

Gasket Size: W 17mm x H 17mm x L 20mm

(The Length of gasket should not be less than 20mm)

- 2) Remove the tape on the gasket and align the gasket to the right side of the HDMI or DP.

(Alignment refers to the arrow in the image below)

- 3) Press the gasket to the end of shielding with your fingers and confirm that it will not fall.

If the gasket falls on the inner boards, it will cause a short circuit and damage the Monitor.

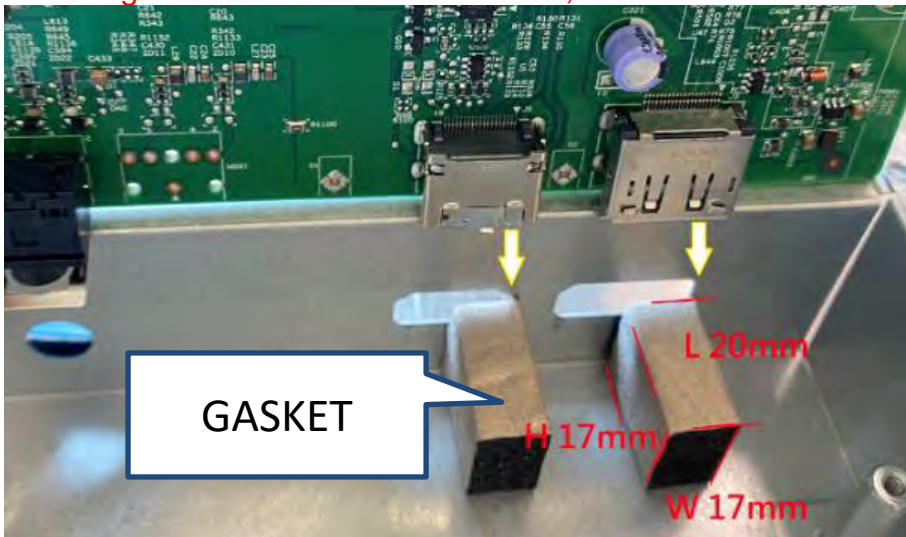

- 4) After assembly, check from the appearance whether the connector is indeed fixed with the gasket.



Function Test:

After repairing, please do the function test to check all functions are working.

Test Item	OPERATION DESCRIPTIONS	EQUIP.OR TOOL USED
HDMI test	Check if the image and sound can be played normally on monitor. No noise volume and balance is correct.	PC or DVD Player
DP test	Check if the image and sound can be played normally on monitor. No noise volume and balance is correct.	PC or DVD Player
Audio test	Change sound volume and balance if the volume sound smoothly and loud enough.	Speaker

Support and Troubleshooting

Solving common problems

The following table lists possible problems, the possible cause of each problem, and the recommended solutions.

Problem	Possible Cause	Solution
Screen is blank or video is flashing.	Power cord is disconnected.	Connect the power cord.
	Monitor is off.	Press the Power button. NOTE: If pressing the Power button has no effect, press and hold the power button for 10 seconds to disable the Power button lockout feature.
	Video cable is improperly connected.	Connect the video cable properly. See Connecting the cables on page 5 for more information.
	System is in sleep mode.	Press any key on the keyboard or move the mouse to exit sleep mode.
	Video card is incompatible.	Open the OSD menu and select the Input Control menu. Set Auto-Switch Input to Off and manually select the input.
Image appears blurred, indistinct, or too dark.	Brightness is too low.	Open the OSD menu and select Brightness to adjust the brightness scale as needed.
Check Video Cable is displayed on screen.	Monitor video cable is disconnected.	Connect the appropriate video signal cable between the computer and monitor. Be sure that the computer power is off while you connect the video cable.
Input Signal Out of Range is displayed on screen.	Video resolution and/or refresh rate are set higher than what the monitor supports.	Change the settings to a supported setting. See Preset display resolutions on page 17 for more information.
The monitor is off but it did not seem to enter into sleep mode.	The monitor's power saving control is disabled.	Open the OSD menu and select Power Control > Auto-Sleep Mode and set auto-sleep to On .
On-Screen Menus are Locked is displayed.	The monitor's OSD lock function is enabled.	Press and hold the Menu button on the front bezel for 10 seconds to disable the OSD lockout function.
Power Button is Locked is displayed.	The monitor's power button is locked.	Press and hold the power button for 10 seconds to disable the power button lock function.

Index

components

front, 3

rear, 4

DisplayPort connector location, 4

features, 2

front components, 3

function button locations, 3

HDMI connector location, 4

illustrated parts catalog, 7

menu button location, 3

parts, 7

power board removal, 12

power button location, 3

power connector location, 4

power light location, 3

preparation for disassembly, 9

RC removal, 9

rear components, 4

removal

power board, 12

RC, 9

xxxx, 14

removal and replacement procedures, 9

RoHS (2002/95/EC) requirements, 1

safety information, 1

serial number location, 5

spare parts, 7

USB port location, 4

USB upstream port location, 4

VGA connector location, 4

xxxx removal, 14