

---

# HP Notebook PC

---

## Startup Guide

---

## Notice

This manual and any examples contained herein are provided “as is” and are subject to change without notice. Hewlett-Packard Company makes no warranty of any kind with regard to this manual, including, but not limited to, the implied warranties of merchantability and fitness for a particular purpose. Hewlett-Packard Co. shall not be liable for any errors or for incidental or consequential damages in connection with the furnishing, performance, or use of this manual or the examples herein.

Consumer transactions in Australia and the United Kingdom: The above disclaimers and limitations shall not apply to Consumer transactions in Australia and the United Kingdom and shall not affect the statutory rights of Consumers.

© Copyright Hewlett-Packard Company 2002. All rights reserved. Reproduction, adaptation, or translation of this manual is prohibited without prior written permission of Hewlett-Packard Company, except as allowed under the copyright laws.

The programs that control this product are copyrighted and all rights are reserved. Reproduction, adaptation, or translation of those programs without prior written permission of Hewlett-Packard Co. is also prohibited.

Portions of the programs that control this product may also be copyrighted by Microsoft Corporation, Phoenix Technologies, Ltd., ATI Technologies Inc., Intel Corporation, and Adobe Systems Incorporated. See the individual programs for additional copyright notices.

This product incorporates copyright protection technology that is protected by method claims of certain U.S. patents and other intellectual property rights owned by Macrovision Corporation and other rights owners. Use of this copyright protection technology must be authorized by Macrovision Corporation and is intended for home and other limited viewing uses only unless otherwise authorized by Macrovision Corporation. Reverse engineering or disassembly is prohibited.

Microsoft®, MS-DOS®, and Windows® are U.S. registered trademarks of Microsoft Corporation. Pentium® and the Intel Inside logo are U.S. registered trademarks and Celeron™ and SpeedStep™ are U.S. trademarks of Intel Corporation. Adobe® and Acrobat® are trademarks of Adobe Systems Incorporated.

**Hewlett-Packard Company**  
**HP Notebook Customer Care**  
**1000 NE Circle Blvd., MS 425E**  
**Corvallis, OR 97330**

---

## Important Safety Information

---

### CAUTION

**To reduce the risk of fire, use only No. 26 AWG or larger telecommunications line cord to connect a modem to the telephone wall jack. In Australia, the computer must be connected to the Telecommunication Network through a line cord that meets the requirements of ACA Technical Standard TS008.**

When using your computer with a telephone connection, always follow basic safety precautions to reduce the risk of fire, electric shock, and injury to persons:

- Do not use this product with a telephone connection near water (for example, near a bathtub, sink, swimming pool, or in a wet basement).
- Avoid using a telephone connection (other than a cordless type) during an electrical storm. There may be a remote risk of electric shock from lightning.
- Do not use a telephone connection to report a gas leak in the vicinity of the leak.
- Use only the power cord and batteries indicated in this manual. Do not dispose of batteries in a fire. They may explode. Check with local codes for possible special disposal instructions.

---

## HP Software Product License Agreement

Your HP product contains software programs. CAREFULLY READ THIS LICENSE AGREEMENT BEFORE PROCEEDING TO OPERATE THIS EQUIPMENT. RIGHTS IN THE SOFTWARE ARE OFFERED ONLY ON THE CONDITION THAT THE CUSTOMER AGREES TO ALL TERMS AND CONDITIONS OF THE LICENSE AGREEMENT. PROCEEDING TO OPERATE THE EQUIPMENT INDICATES YOUR ACCEPTANCE OF THESE TERMS AND CONDITIONS. IF YOU DO NOT AGREE WITH THE TERMS OF THE LICENSE AGREEMENT, YOU MUST NOW EITHER REMOVE THE SOFTWARE FROM YOUR HARD DISK DRIVE AND DESTROY THE MASTER DISKETTES, OR RETURN THE COMPLETE HP PRODUCT AND SOFTWARE FOR A FULL REFUND. PROCEEDING WITH CONFIGURATION SIGNIFIES YOUR ACCEPTANCE OF THE LICENSE TERMS.

UNLESS OTHERWISE STATED BELOW, THIS HP SOFTWARE LICENSE AGREEMENT SHALL GOVERN THE USE OF ALL SOFTWARE THAT IS PROVIDED TO YOU AS PART OF THE HP PRODUCT AND SHALL SUPERSEDE ANY OTHER SOFTWARE WARRANTY STATEMENT THAT MAY BE INCLUDED IN THIS HP PRODUCT OR MAY BE FOUND ONLINE.

Operating system and software applications by Microsoft are licensed to you under the Microsoft License Agreement contained in the Microsoft documentation or displayed on your screen when Microsoft Software Products are launched.

For a PC supplied with a Microsoft operating system: When you start the PC and accept the Microsoft End-user License Agreement (“EULA”), your license rights are valid only if a Certificate of Authenticity (“COA”) label corresponding to your Microsoft operating system is provided with your PC. The COA label can usually be found on the bottom of the computer. If the COA label does not correspond to your Microsoft operating system or is missing, contact your HP reseller for details.

Other non-HP Software and Operating Systems are covered by the appropriate vendor license. The following License Terms govern the use of the HP software:

**USE.** Customer may use the software on any one HP product. Customer may not network the software or otherwise use it on more than one HP product. Customer may not reverse assemble or decompile the software unless authorized by law.

**COPIES AND ADAPTATIONS.** Customer may make copies or adaptations of the software a) for archival purposes or (b) when copying or adaptation is an essential step in the use of the software with an HP product so long as the copies and adaptations are used in no other manner.

**OWNERSHIP.** Customer agrees that he/she does not have any title or ownership of the software, other than ownership of the physical media. Customer acknowledges and agrees that the software is copyrighted and protected under the copyright laws. Customer acknowledges and agrees that the software may have been developed by a third party software supplier named in the copyright notices included with the software, who shall be authorized to hold the Customer responsible for any copyright infringement or violation of this Agreement.

**PRODUCT RECOVERY CD-ROM or DVD.** If your HP product was shipped with a product recovery CD-ROM or DVD: (i) The product recovery CD-ROM or DVD and/or support utility software may only be used for restoring the hard disk of the HP product with which the product recovery CD-ROM or DVD was originally provided. (ii) The use of any operating system software by Microsoft contained in any such product recovery CD-ROM or DVD shall be governed by the Microsoft License Agreement.

**TRANSFER OF RIGHTS IN SOFTWARE.** Customer may transfer rights in the software to a third party only as part of the transfer of all rights and only if Customer obtains the prior agreement of the third party to be bound by the terms of this License Agreement. Upon such a transfer, Customer agrees that his/her rights in the software are terminated and that he/she will either destroy his/her copies and adaptations or deliver them to the third party.

**SUBLICENSING AND DISTRIBUTION.** Customer may not lease, sublicense the software or distribute copies or adaptations of the software to the public in physical media or by telecommunication without the prior written consent of Hewlett-Packard.

**TERMINATION.** Hewlett-Packard may terminate this software license for failure to comply with any of these terms provided Hewlett-Packard has requested Customer to cure the failure and Customer has failed to do so within thirty (30) days of such notice.

**UPDATES AND UPGRADES.** Customer agrees that the software does not include updates and upgrades which may be available from Hewlett-Packard under a separate support agreement.

EXPORT CLAUSE. Customer agrees not to export or re-export the software or any copy or adaptation in violation of the U.S. Export Administration regulations or other applicable regulation.

U.S. GOVERNMENT RESTRICTED RIGHTS. Use, duplication, or disclosure is subject to HP standard commercial license terms and for non-DOD Departments and Agencies of the U.S. Government, the restrictions set forth in FAR 52.227-19(c)(1-2) (June 1987) Hewlett-Packard Company, 3000 Hanover Street, Palo Alto, CA 94304 U.S.A. Copyright (c) 2000 Hewlett-Packard Company. All Rights Reserved. Customer further agrees that Software is delivered and licensed as “Commercial computer software” as defined in DFARS 252-227-7014 (June 1995) or as a “commercial item” as defined in FAR 2.101(a), or as “Restricted computer software” as defined in FAR 52.227-19 (or any equivalent agency regulation or contract clause), whichever is applicable. The Customer agrees that it has only those rights provided for such Software by the applicable FAR or DFARS clause or the HP standard software agreement for the product involved.

Support Policy for Microsoft Operating Systems Service Pack. HP will provide end user support for HP PCs that use Microsoft Operating Systems, including its latest service packs. This support will be available 30 days after the service pack being released by Microsoft.

---

## Edition History

Edition 1 (KA, KB) ..... July 2002



This manual is printed on recycled paper.



---

## Contents

<b>Getting Started with Your HP Notebook .....</b>	<b>9</b>
Taking Inventory.....	10
What's in the box? .....	10
To find more information.....	11
Identifying Parts of the Computer.....	12
Front View .....	12
Back View .....	13
Bottom View .....	14
Status Lights.....	15
Setting Up Your Computer .....	17
Step 1: Install the battery .....	17
Step 2: Connect AC power.....	19
Step 3: Connect a phone line.....	20
Step 4: Turn on the computer.....	21
Step 5: Set up Windows .....	21
Step 6: Register your notebook.....	22
To connect to the Internet .....	22
What to do next.....	22
<b>Basic Operation .....</b>	<b>23</b>
Operating Your Computer .....	24
To turn the computer on and off .....	24
To reset the computer.....	25
To change the boot device.....	25
To use the touch pad .....	26
To use the Fn hot keys .....	28
To play DVD movies .....	29
Working in Comfort with a Notebook PC .....	30
<b>Batteries and Power Management .....</b>	<b>33</b>
Using Battery Power.....	34
To check battery status.....	34
To respond to a low-battery warning .....	35
To recharge the battery .....	35
<b>Add-On Devices .....</b>	<b>37</b>
Installing Additional RAM .....	38
To install a RAM expansion module .....	38
Replacing the Hard Disk Drive.....	39
To replace the hard disk drive.....	39

<b>Troubleshooting and Maintenance .....</b>	<b>41</b>
Troubleshooting Your Computer .....	42
Display Problems .....	42
Hard Disk Drive Problems .....	43
Keyboard and Pointing Device Problems .....	43
Performance Problems .....	44
Power and Battery Problems .....	44
Startup Problems .....	45
Testing the Hardware .....	46
To run the e-Diagtools diagnostic test .....	46
Configuring the Computer .....	48
To run the BIOS Setup utility .....	48
Reinstalling and Updating Software .....	49
To recover the factory installation of your hard disk .....	49
<b>HP Support and Service .....</b>	<b>51</b>
Getting Assistance for Your Computer .....	52
To get help from the Web .....	52
To contact HP for support or service .....	52
To receive repair service .....	54
To prepare your computer for shipment .....	55
Hewlett-Packard Limited Warranty Statement .....	56
<b>Reference Information .....</b>	<b>59</b>
Hardware Specifications .....	60
Safety Information .....	64
Power Cords .....	64
Ergonomics .....	65
Battery Safety .....	65
Laser Safety .....	66
LED Safety .....	66
Mercury Safety .....	67
Exposure to Radio Frequency Radiation .....	67
Regulatory Information .....	68
U.S.A. .....	68
Canada .....	69
European Union .....	70
Japan .....	71
Russia .....	72
International .....	72
<b>Index .....</b>	<b>75</b>



---

## Getting Started with Your HP Notebook

---

## Taking Inventory

Congratulations! Your notebook computer sets a new standard in personal computing. Although compact and easy to carry, your computer is made with the quality and attention to detail that are the hallmark of Hewlett-Packard.

This manual shows how to set up and operate your computer, as well as what to do if you run into trouble.

---

### What's in the box?

- HP notebook PC.
- Battery (installed).
- AC adapter and power cord.
- Quick Start sheet.
- *Startup Guide*.
- *Recovery CD or DVD*, for restoring Windows and all software included with your computer.
- Microsoft Windows manual.
- CD with special software (for models with certain types of drives).

In addition, your HP notebook includes preinstalled software. (The exact software installed depends on your particular notebook model.)

---

## To find more information

The following table lists other sources of information about your computer and related products.

<b>Source</b>	<b>Description and Location</b>
<i>Startup Guide</i>	This printed manual introduces your computer. It also contains setup instructions, basic operation guidelines, troubleshooting information, and warranty information.
<i>Online Reference Guide</i>	The full <i>Reference Guide</i> is shipped on the computer's hard drive, and provides a complete source for operating and maintaining the computer. Look in the online HP Library, or on the <i>Recovery CD</i> or <i>DVD</i> in \hp\Library. The HP Library is in the Help and Support Center.
Online HP Notes	For late-breaking information available after the manuals were completed, see the HP Notes in the online HP Library, or on the <i>Recovery CD</i> or <i>DVD</i> in \hp\Library.
Microsoft Windows manual	This is shipped with your computer and contains information about using the version of Microsoft Windows shipped with your computer.
HP Notebook Web Site	<a href="http://www.hp.com/notebooks">www.hp.com/notebooks</a> <a href="http://www.europe.hp.com/notebooks">www.europe.hp.com/notebooks</a> (European mirror). To select another language, see <a href="http://www.hp.com">www.hp.com</a> .
HP Business Support Web Site	<a href="http://www.hp.com/go/bizsupport">www.hp.com/go/bizsupport</a>

---

## Identifying Parts of the Computer

---

### Front View

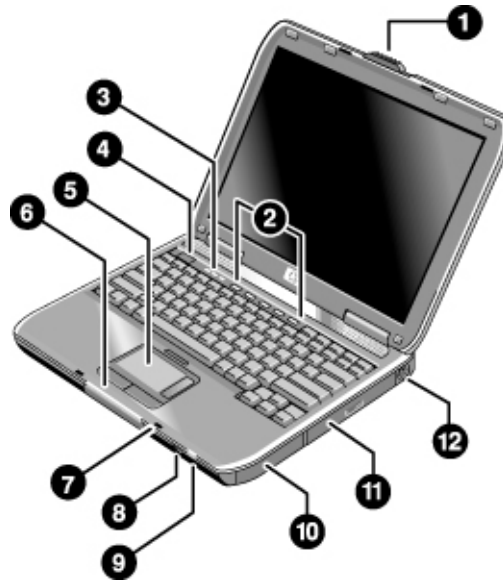

- |   |  |
|---|--|
| 1. Computer open/close latch.   | 7. Built-in microphone*.                                   |
| 2. One-Touch buttons.   | 8. Infrared port*.   |
| 3. Keyboard status lights.  | 9. Wireless on-off button and indicator light*.            |
| 4. Power button. Turns the computer on and off.                                 | 10. Battery.   |
| 5. Touch pad, scroll pad, click buttons, plus on-off button.                    | 11. CD-ROM, DVD, or other drive.                           |
| 6. Main status lights (left to right): power mode, battery, hard disk activity. | 12. PS/2 keyboard or PS/2 mouse port (supports Y adapter). |
- \* on certain models

---

## Back View

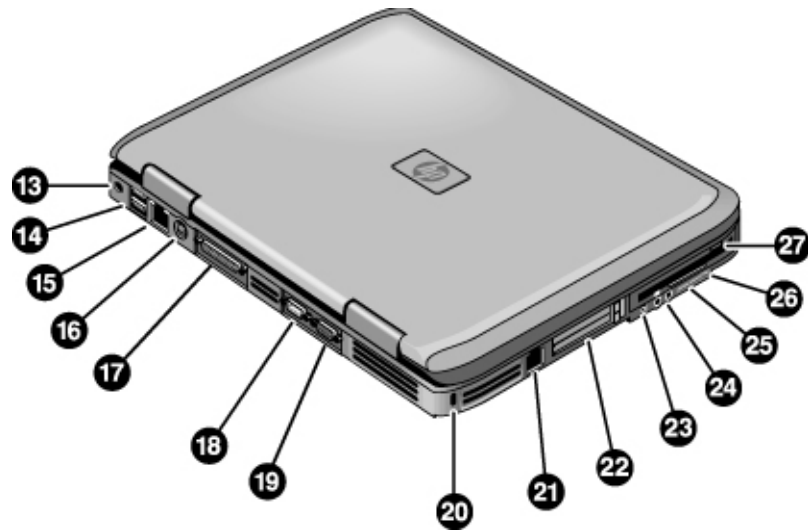

- |   |  |
|---|--|
| 13. AC adapter jack.  | 21. Modem port*.   |
| 14. Two universal serial bus ports (USB).   | 22. PC Card and CardBus slot and button (certain models have two slots and two buttons). |
| 15. LAN port*.  | 23. IEEE 1394 port*.   |
| 16. S-video port*.  | 24. Audio jacks (left to right): external microphone, audio out (headphones).            |
| 17. Parallel port (LPT1). Use this port for a parallel printer or other parallel device.          | 25. Volume control*.   |
| 18. Serial port (COM1). Use this port for a serial mouse, modem, printer, or other serial device. | 26. Audio mute button and audio mute light*.   |
| 19. External monitor port.  | 27. Floppy disk drive*.  |
| 20. Kensington lock slot (security connector).  | * on certain models  |

Getting Started with Your HP Notebook  
**Identifying Parts of the Computer**

---

Bottom View

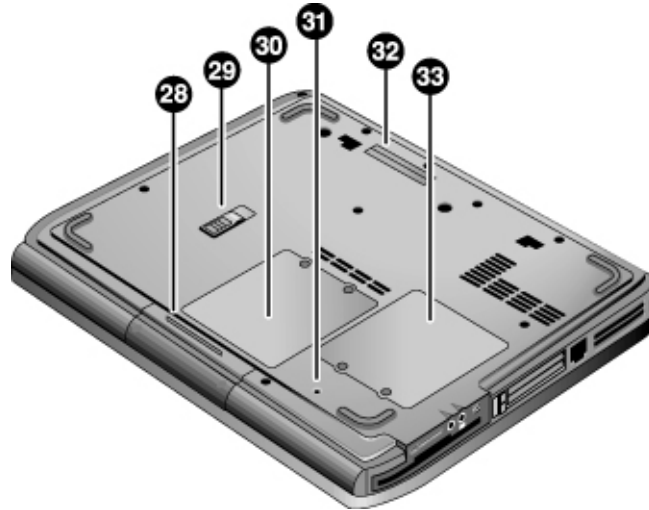

- 28. Hard disk drive.
- 29. Battery latch.
- 30. RAM cover.

- 31. Reset button.
  - 32. Docking port\*.
  - 33. Mini-PCI cover (no user parts inside).
- \* on certain models

---

## Status Lights

The computer includes a number of status lights that report power and battery status, drive activity, and keyboard functions such as Caps Lock and Num Lock.

The following diagram shows the main status lights on the front of the computer.

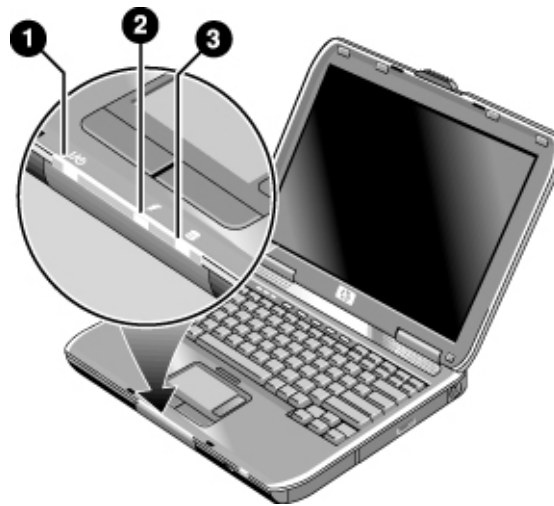

**1. Power mode.**

- On: the computer is on (even if the display is off).
- Blinking: the computer is in Standby mode.
- Off: the computer is off or in Hibernate mode.

**2. Hard disk drive activity.**

- On: computer is accessing the hard disk drive.

**3. Battery status.**

- Green: the AC adapter is connected and the battery is fully charged.
- Amber: the AC adapter is connected and the battery is charging.
- Blinking: the AC adapter is connected and the battery is missing or has a fault.
- Off: the AC adapter is not connected.

## Getting Started with Your HP Notebook Identifying Parts of the Computer

The keyboard status lights, located above the keyboard, indicate the states of the keyboard locks.

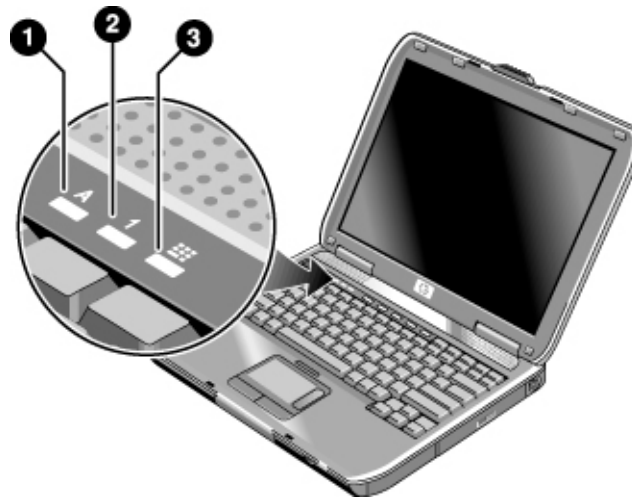

1. **Caps Lock.** Caps Lock is active.
2. **Num Lock.** Num Lock is active. (The Keypad Lock must also be on to use the embedded keypad.)
3. **Keypad Lock.** The embedded keypad is active (Fn+F8). Num Lock must also be on for the numeric keys—otherwise, cursor control is active (as marked on an external keyboard).



---

## Setting Up Your Computer

---

### WARNING

Improper use of keyboards and other input devices has been associated with ergonomic injury. For information about reducing your risk, see *Working in Comfort* in the online HP Library, or visit our ergonomics Web site, [www.hp.com/ergo](http://www.hp.com/ergo). For a summary about working with a notebook computer, see “Working in Comfort with a Notebook PC” on page 30.

If you are using your notebook computer as your primary computer, or using it for extended periods, you should use it with a full-size keyboard, monitor, and mouse. HP docking accessories offer quick, easy connections to these devices. This can reduce the risk of ergonomic injury. See *Working in Comfort* in the online HP Library.

---

When you set up your computer for the first time, you’ll install and charge the battery, connect the AC adapter, turn on the computer, and run the Windows setup program.

---

### Step 1: Install the battery

---

### WARNING

**Do not mutilate or puncture batteries. Do not dispose of batteries in fire, or they can burst or explode, releasing hazardous chemicals. Rechargeable batteries must be recycled or disposed of properly.**

---

Your computer is shipped with the battery installed. If the battery has been removed, you should install it:

1. Turn the computer upside down.
2. Insert the connector end of the battery into the battery compartment and slide it in until it latches.

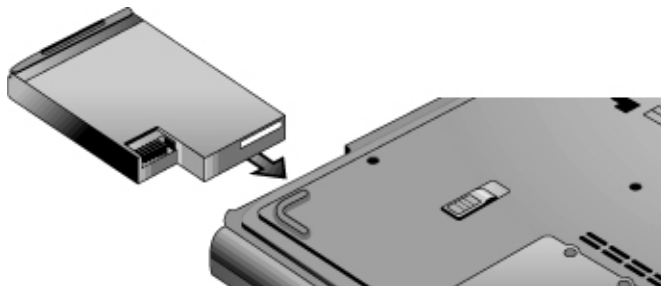

Getting Started with Your HP Notebook  
**Setting Up Your Computer**

**To remove the battery**

1. Before removing the battery, do one of the following:
  - Shut down the computer or put it into Hibernate mode, or
  - Plug in the AC adapter.
2. Slide the battery's release latch, and then slide the battery out of its compartment.

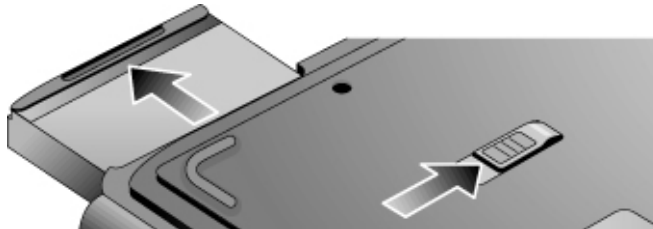

---

## Step 2: Connect AC power

---

### CAUTION

Use only the HP AC adapter included with your computer (or other approved adapter that meets the power requirements of the computer).

If “75W” is printed below the AC adapter socket on the computer, do not use a 60-watt, 3.16-amp adapter, such as HP F1454A or F1781A, and do not use DC adapter accessories F1455A and F2297A.

Using the wrong AC adapter could damage the computer or adapter and may void your warranty (see "Hewlett-Packard Limited Warranty Statement" on page 56).

- Plug the AC adapter into the computer and connect the power cord to the AC adapter, then plug the power cord into a wall outlet. The computer's battery then starts charging.

---

### Important

When unplugging the power cord, unplug it from the outlet before unplugging it from the AC adapter.

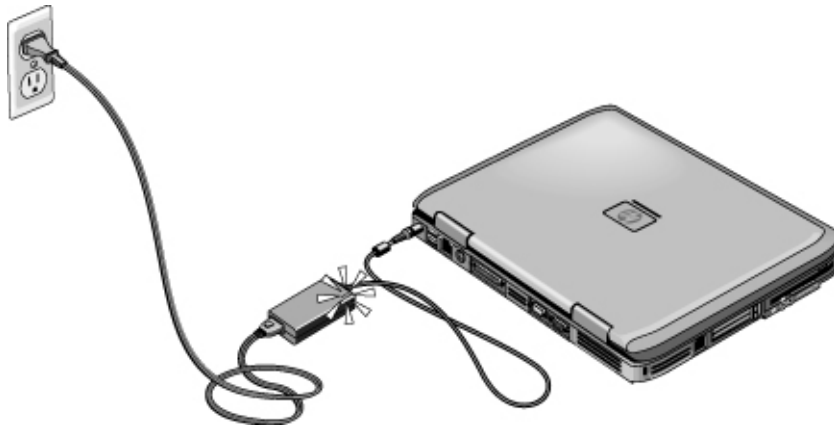

While the battery is charging, you can continue with step 3.

## Getting Started with Your HP Notebook Setting Up Your Computer

---

### Step 3: Connect a phone line

If your computer does not include a built-in modem, you can skip this step. Also, if you prefer, you can instead connect to a PC Card modem or an external modem.

1. Make sure the telephone line is an analog line, sometimes called a data line. (You must not use a digital line.)
2. Connect the telephone cord into a telephone jack. If the plug on the phone cord doesn't fit the jack, you may need to use an adapter.
3. Plug the other end of the phone cord into the built-in modem.

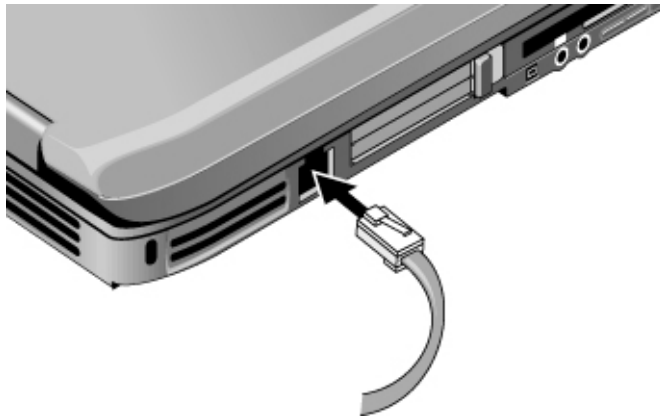

For details about using the modem, including AT commands, see the online *Reference Guide*.

---

## Step 4: Turn on the computer

- Press the power button above the left side of the keyboard. The computer then boots up, and Windows starts automatically.



---

### Hint

If your computer does not turn on when operating on battery power, the battery may be out of power. Plug in the AC adapter and press the power button again. Leave the AC adapter plugged in for at least an hour—or 2–3 hours to charge it fully.

---

## Step 5: Set up Windows

Your notebook computer has Microsoft Windows preinstalled on its hard disk drive. The first time you turn on your computer, the Windows Setup program runs automatically so you can customize your setup.

1. Follow the Setup program's instructions as they appear on the screen. If the program prompts you to enter the Product ID code, you will find this code on the bottom of the computer.
2. If your computer has a modem, check the modem's country or region settings: click Start, Control Panel, Printers and Other Hardware, Phone and Modem Options, and then click Edit on the Dialing Rules tab.

## Step 6: Register your notebook

Be sure to register your computer. Registering is free and fast, and ensures you will receive quicker, more personalized support. The information you provide during registration allows us to provide you with better products and services.

Registering your computer does the following:

- Records your ownership of the computer with Hewlett-Packard and provides access to service, support, and information.
- Records your ownership of the Windows XP operating system with Microsoft.

If you decide not to register during Windows setup, choose the option to print the registration form, and then fax it to HP at the fax number on the form. Or you can register by calling HP Customer Care—see “To contact HP for support or service” on page 52 to find the phone number.

---

## To connect to the Internet

If you are connected to a wired or wireless LAN with Internet access or your computer has a modem (built-in, PC Card, or external), you can connect to the Internet. For details, see the online *Reference Guide*—click Start, Help and Support, HP Library.

---

## What to do next

- If you're not familiar with Windows XP, click Start, Tour Windows XP, or check the Windows manual to discover what's new.
- See the online *Reference Guide* to learn more about using and maintaining your computer—click Start, Help and Support, HP Library.

---

## Basic Operation

---

## Operating Your Computer

You can start and stop your computer using its power button. However, at certain times you may want to use other methods to start or stop the computer—depending on power considerations, types of active connections, and start-up time.

For information on caring for and protecting your computer, see “Operating Your Computer” in the online *Reference Guide*.

For information about connecting your modem or LAN (depending on the model), or about connecting PC Cards or external devices, see the online *Reference Guide*. See the same online manual for modem AT commands.

---

### To turn the computer on and off

<b>Power mode</b>	<b>To enter this mode</b>
<b>On mode</b> Power mode status light is on.	Press the power button.
<b>Standby mode</b> Saves significant power. Turns off the display and other components. Maintains current session in RAM. Restarts quickly. Restores network connections. Power mode status light is blinking.	Press the power button –or– click Start, Turn Off Computer, Stand By –or– allow timeout.
<b>Hibernate mode</b> Saves maximum power. Saves current session to disk, then shuts down. Restores network connections. Power mode status light is off.	Press Fn+F12 –or– allow timeout.
<b>Shut down (off)</b> Saves maximum power. Turns off without saving current session. At startup, resets everything, starts a new session, and restores network connections. Power mode status light is off.	Click Start, Turn Off Computer, Turn Off –or– press the power button for 4 seconds (only if the Start menu procedure doesn't work).
<b>To turn on:</b> Press the power button to restart, or to resume your session from Standby or Hibernate mode.	

You can also customize the way these power modes work. See the chapter titled “Batteries and Power Management” in the online *Reference Guide*.



## To reset the computer

Occasionally, you may find that Windows or the computer has stopped responding, and will not let you turn the computer off. If this happens, try the following in the order listed.

- If possible, shut down Windows: press CTRL+ALT+DEL, and then click Shut Down, Restart.  
–or, if this fails–
- Press the power button for 4 seconds until the display shuts down, and then press the power button again to restart.  
–or, if this fails–
- Insert the tip of a ballpoint pen into the reset button on the bottom of the computer, and then press the power button to restart.

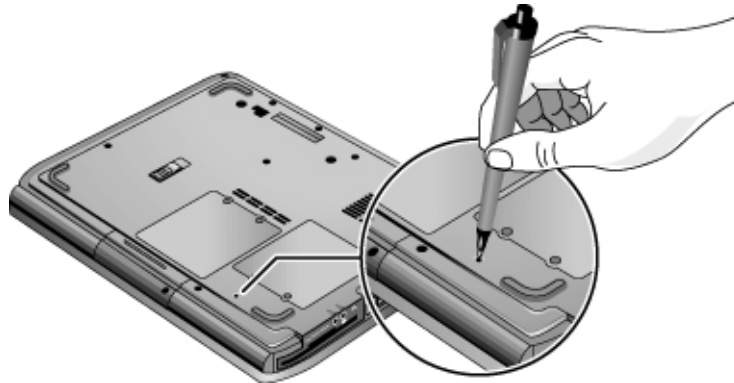

---

## To change the boot device

The computer normally boots from its internal hard disk. You can also boot the computer from a floppy disk drive, a CD-ROM drive, or an internal network interface card.

1. Click Start, Turn Off Computer, Restart.
2. When the HP logo appears, press ESC to display the Boot menu.
3. Use the arrow keys to select the boot device, and press ENTER.

## Basic Operation

### Operating Your Computer

If you want to boot from a specific device whenever it is present, change the boot order using the BIOS Setup utility—see “To run the BIOS Setup utility” on page 48.

---

### To use the touch pad

The touch pad includes an on-off button so you can turn off the touch pad to avoid moving the pointer accidentally, such as by touching the pad while typing. The indicator light turns off when you turn off the touch pad.

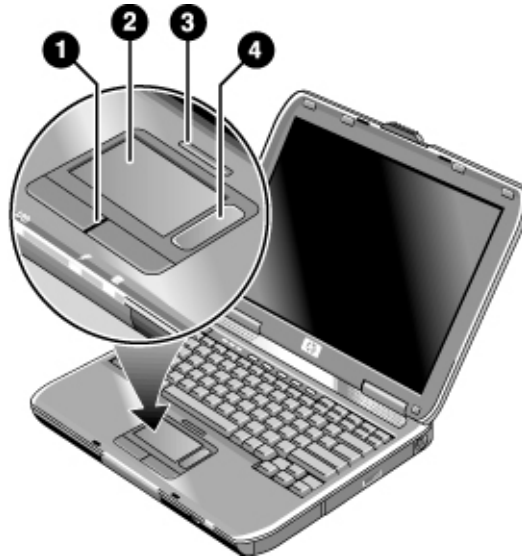

1. Click buttons. The click buttons work like the left and right buttons on a standard mouse.
2. Touch pad (touch-sensitive pointing device).
3. Touch pad on-off button and indicator light.
4. Scroll pad. The scroll pad scrolls the contents of the active window.

### **Moving and selecting**

1. Place your hands in a normal typing position.
2. Move a thumb or finger across the touch pad in the direction you want the pointer to move.
3. Use the left and right click buttons, which function like the left and right buttons on a mouse, to make your selection:
  - To open an application, move the pointer over the icon and double-click the left button.
  - To make menu selections, move the pointer to the menu item and click the left button.
  - To open the shortcut menu for an item, move the pointer over the item and click the right button.
  - To drag an item, move the pointer over the item. Then press *and hold* the left button while you move the pointer to the new location, and release the button.

In addition, you can tap the touch pad to select items and use other advanced touch pad features. For more information, double-click the touch pad icon in the taskbar, and then click Help in the tab for a particular feature.

You can use Mouse in Control Panel or the touch pad icon in the taskbar to customize the operation of your computer's pointing devices (touch pad and external mouse): you can change the left, right, and scroll pad actions, double-click speed, pointer speed, and more.

### **Scrolling with the scroll pad**

- Move your finger down the scroll pad to scroll down through the contents of a window. Move your finger up the scroll pad to scroll up.

## To use the Fn hot keys



The combination of the Fn key plus another key creates a *hot key*—a shortcut key sequence—for various system controls. To use a hot key, press *and hold* Fn, press the appropriate second key, and then release both keys.

### **This hot key**

Fn+F1

Fn+F2

Fn+F5

Fn+F8

Fn+F12

Fn+NumLock

Fn+Page Up

Fn+Page Down

Fn+Backspace

### **Does this**

Decreases the display brightness.

Increases the display brightness.

Toggles among the built-in display, an external display, and simultaneous display on both.

Toggles the built-in keypad on and off. Does not affect an external keyboard. If Num Lock is on, then the numeric functions are active; otherwise, cursor control is active (as marked on an external keyboard).

Enters Hibernate mode.

Toggles Scroll Lock on and off.

Increases the audio volume and cancels the mute setting.

Decreases the audio volume.

Mutes the audio output.

---

## To play DVD movies

If your computer came with a DVD drive, it also includes DVD player software that lets you play DVD movies.

- Click Start, All Programs, Multimedia, DVD Player, InterVideo WinDVD.

You can also use Windows Media Player to play DVD movies.

---

### **Important**

DVDs can have regional codes embedded in the disc data. These codes prevent DVD movies from being played outside the region of the world in which they are sold. If you get a region code error, you are trying to play a DVD intended for a different region.

Most DVD drives let you change the region code only a limited number of times (usually no more than four). When you reach this limit, your last change to the region code will be hard-coded on the DVD drive, and will be permanent. Your HP warranty does not cover the expense of correcting this situation. Refer to the help for your DVD player software for details about setting region codes.

---

---

## Working in Comfort with a Notebook PC

---

### **WARNING**

**Improper use of keyboards and other input devices has been associated with ergonomic injury. For more information about reducing your risk, visit our ergonomics Web site at [www.hp.com/ergo](http://www.hp.com/ergo)—or see *Working in Comfort in the online HP Library*.**

You can use your HP notebook computer virtually anywhere, anytime. The following recommendations should help you work more comfortably.

---

### **Note**

If you are using your portable computer as your primary computer, or using it for extended periods, you should use it with a full-size keyboard, monitor, and mouse. This will give your portable computer the adjustability and comfort features of a desktop unit. HP docking accessories offer quick, easy connections to these devices. More information on how to prepare your workspace environment and set up your HP equipment is available in *Working in Comfort*, which is preloaded on the hard disk in the HP Library, and also available at [www.hp.com/ergo](http://www.hp.com/ergo).

---

### **Your Mobile Work Environment**

- Use a chair that provides good support for your lower back. If an adjustable chair is not available, you can use a pillow or rolled-up towel to provide lower back support.
- Try to keep your thighs parallel to the floor and your feet flat on the floor. In a mobile environment, you can do this by using a phone book or briefcase to support your feet.
- Adjust the height of either your work surface or chair to keep your arms in a neutral position. Your arms should be relaxed and loose, elbows at your sides, with the forearms and hands parallel with the floor.
- Position your notebook computer display to minimize glare and reflection. For example, on an airplane, lower the window shade, or in a hotel room, draw the curtains. You also should maintain a comfortable viewing distance—approximately 40 to 60 cm (16 to 24 inches). Adjust the angle of your display to help keep your head angled slightly downward in a comfortable position.

### **Using Your Mobile Computer**

- Position the computer so your wrists and hands are in a neutral position. Your wrists should be as straight as possible and should not have to bend sideways or more than 10 degrees up or down. If your notebook computer does not have a built-in palm rest, you can use a rolled-up towel.
- Try to type as lightly as possible. The notebook keyboard requires little force to activate.
- Take frequent, short rest breaks—this is especially important in a mobile computing environment.
- Portable computers weigh between approximately 1.4 and 3.7 kilos (3 and 8 pounds). When traveling, be sure to carry your computer properly to minimize strain on your body. Shift the bag containing your notebook equipment frequently between your left and right hands and shoulders.





---

## Batteries and Power Management

---

## Using Battery Power

For information about how your computer regulates its power consumption, and how you can manually reduce power consumption and extend the life of the computer's battery, see the chapter titled "Batteries and Power Management" in the online *Reference Guide*.

---

### To check battery status

#### **From the battery status light**

Your computer has a battery status light—see "Status Lights" on page 15.

#### **From the Windows taskbar**

The Windows taskbar can display a power icon that provides detailed battery status information (see Windows Help for details). The icon looks like a battery when AC is not connected.

- Place the pointer over the power icon to display the remaining battery charge. This value is shown as either a percentage of charge remaining, or as time remaining.
- Double-click the power icon to open the Battery Meter window.

#### **From the Windows Control Panel**

- Click Start, Control Panel, Performance and Maintenance, Power Options, and then click the Power Meter tab to see the battery status. The Alarms and Advanced tabs provide additional Windows' power-information options.

#### **On the battery**

1. Remove the battery from the computer—see "Step 1: Install the battery" on page 17.
2. Press the contact pad on the side of the battery. The number of lights that turn on indicates the remaining charge (each light represents 20% of a full charge).

---

## To respond to a low-battery warning

The computer automatically alerts you when the battery power drops to a critically low level. The computer first emits a high-pitched beep or displays a warning message. Then, if you do not restore power within a short time, the computer goes into Hibernate mode.

Once the computer enters Hibernate mode in this way, you won't be able to turn it on again until you restore power by doing one of the following:

- Replace the battery with a charged one. See “Step 1: Install the battery” on page 17.
- Plug in the AC adapter. See “Step 2: Connect AC power” on page 19.

---

**Note**

---

If you plug in the AC adapter, you can continue to work while your battery recharges.

---

## To recharge the battery

---

**CAUTION**

---

**The AC adapter is normally warm whenever plugged into an AC outlet. The computer is normally warm while recharging. Don't recharge the computer in a briefcase or other confined space, or its battery could overheat.**

- Plug the AC adapter into the computer.

To get the longest operating time, wait until the battery's charge is below 50% before recharging, and then charge it fully (100%). Charging can take up to approximately 2 hours. If you continue working while the battery charges, the charging time may increase to 3 hours.

A fully charged battery can operate the computer for up to 2 to 3 hours, depending on your computer's model, power management settings, and level of use.



---

## Add-On Devices

---

## Installing Additional RAM

The computer has no memory (RAM) built in but has two slots that hold two RAM modules. At least one slot contains a RAM module installed at the factory. You can use both slots to expand your RAM.

---

### To install a RAM expansion module

Use HP PC2100 DDR-266 or higher RAM only.

You'll need a small Phillips screwdriver for these steps.

---

#### CAUTION

**Your computer's chips are extremely sensitive to static electricity, and can be permanently damaged by it. Handle the RAM module only by its edges. Before installing the memory module, discharge your body's static electricity by touching the metal shielding around the connectors on the back of the computer.**

1. Click Start, Turn Off Computer, Turn Off.
2. **Important:** unplug the AC adapter, if present, and remove the battery.
3. Turn the unit bottom-side up, loosen the screws holding the RAM cover, and remove the cover.
4. Insert the RAM board into the connector at about a 30° angle until it is fully inserted. Then press down at both sides until both latches snap closed.

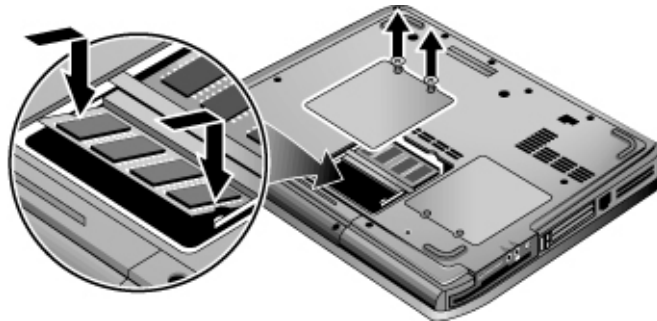

5. Replace the cover.
6. Insert the battery.

To remove the RAM module, release the two latches at the sides of the module.

---

## Replacing the Hard Disk Drive

---

### To replace the hard disk drive

You'll need a small Phillips screwdriver for this procedure.

1. Unplug the AC adapter if you're using one, and remove the battery.
2. Turn the unit bottom side up.
3. Use a pointed tool to remove the plugs from the two screw holes, and then remove the two screws.
4. Gently pull the hard drive out of the computer.

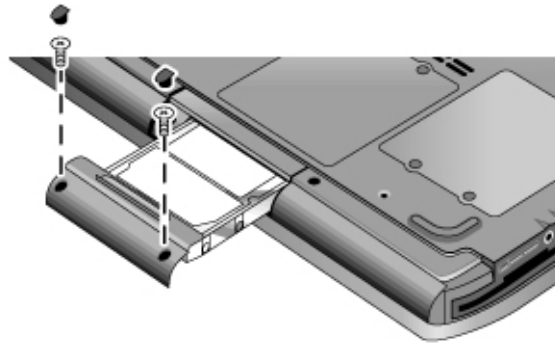

5. Gently slide the new drive into the hard drive compartment. Press firmly to make sure the connector seats properly.
6. Reinstall the hard drive screws and plugs.

---

#### **Important**

If you are installing a new hard disk drive, you should create a Utility partition on the drive before loading any software. See “To recover the factory installation of your hard disk” on page 49.

To install the holder on a new hard disk drive or prepare a new hard disk for use, see “Replacing the Hard Disk Drive” in the online *Reference Guide*.





---

## Troubleshooting and Maintenance

## Troubleshooting Your Computer

This section contains solutions to a few basic problems you might have with your computer. Try the solutions one at a time, in the order in which they are presented.

Here are some other sources of information for troubleshooting:

- See the troubleshooting chapter in the online *Reference Guide* for a more complete list of troubleshooting suggestions.
- Open the HP Web-based troubleshooting tool: click Start, All Programs, HP Instant Support. Search or browse the troubleshooting database for the information related to your problem.
- Click Start, Help and Support, Fixing a Problem, and use the Windows troubleshooters.
- See the Microsoft Windows manual shipped with the computer.
- See the HP Notes in the online HP Library for updated information.
- Find technical tips and software updates for the computer at the HP Business Support Web site ([www.hp.com/go/bizsupport](http://www.hp.com/go/bizsupport)).
- Test your computer by running the e-Diagtools test program. See “Testing the Hardware” on page 46.
- Contact your dealer or Hewlett-Packard—see “To contact HP for support or service” on page 52. Please have your computer with you when you call.

---

### Display Problems

#### **If the computer is on, but the screen is blank**

- Move the mouse or tap the touch pad. This will wake the display if it is in Display-off mode.
- Press Fn+F5 in case the internal display was disabled. (Do this three times to return to the state you started from.)
- If the computer is cold, allow it to warm up.

**If the screen is difficult to read**

- Try setting the display resolution to its default setting of 1024×768 or higher, depending on your model: click Start, Control Panel, Appearance and Themes, Display.

---

## Hard Disk Drive Problems

**If the computer's hard drive doesn't spin**

- Make sure the computer has power. If necessary, connect the AC adapter, and make sure it is fully plugged into a power source and into the back of the computer.
- Remove and reinsert the hard drive. See “Replacing the Hard Disk Drive” on page 39.

**If files are corrupted**

- Open My Computer, select the disk you want to scan, click File, Properties, and use the Tools tab.
- Run the virus-scanning program. See the chapter titled “Basic Operation” in the online *Reference Guide*.
- Test the hard disk drive with the e-Diagtools diagnostics. See “Testing the Hardware” on page 46.
- If necessary, you can format the hard disk and reinstall the original factory software. See “To recover the factory installation of your hard disk” on page 49.

---

## Keyboard and Pointing Device Problems

Use these suggestions for built-in or external devices.

**If the pointer is difficult to control**

- Adjust the pointer controls: click Start, Control Panel, Printers and Other Hardware, Mouse.

**If the touch pad doesn't work**

- Press the touch pad on-off button so the light turns on.

## Troubleshooting and Maintenance

### Troubleshooting Your Computer

- Don't touch the touch pad while the computer is rebooting or resuming from Standby mode. If this happens, try the following: press a key on the keyboard to restore normal operation, or suspend and resume operation using the power button.
- If an external mouse is connected, the built-in pointing devices are normally disabled. You can change this setting with the BIOS Setup utility—see “To run the BIOS Setup utility” on page 48.
- Restart the computer: click Start, Turn Off Computer, Restart.

---

## Performance Problems

For best performance, your computer should have at least 128 MB of memory (RAM).

### **If the computer stops responding**

- Press CTRL+ALT+DEL and use Task Manager to end the application that is not responding.
- Press the power button for at least 4 seconds to turn off and reset the computer. Then press the power button again to turn the computer back on.
- If nothing happens, insert the tip of a ballpoint pen into the reset button on the bottom of the computer. Then press the power button to turn the computer back on.

---

## Power and Battery Problems

### **If the computer turns off immediately after it turns on**

- Battery power is probably extremely low. Plug in the AC adapter or insert a charged battery.

### **If the computer keeps beeping**

- The computer beeps repeatedly or displays a warning when battery power is low. Save your work, shut down Windows immediately, and insert a charged battery or plug in the AC adapter.

### **If the battery doesn't charge**

- Make sure the AC adapter is fully plugged into the power source and the computer, and that the light on the adapter is on.

- If you're using a power strip, remove the AC adapter from the power strip and plug it directly into a wall outlet.
- Make sure the battery is fully installed and locked in place.
- Make sure you're using only the HP AC adapter included with your computer (or other approved adapter that meets the power requirements of the computer). If "75W" is printed below the AC adapter socket on the computer, do *not* use a 60-watt, 3.16-amp adapter, such as HP F1454 or F1781.
- Move the computer away from any nearby heat source. Unplug the AC adapter and allow the battery to cool down. If the battery gets too hot, it will not charge properly.
- If available, try another battery and AC adapter.

---

## Startup Problems

### **If the computer doesn't respond when you turn it on**

- Connect the AC adapter.
- Press the power button to try turning on the unit.
- Reset the computer by inserting the tip of a ballpoint pen into the reset button on the bottom of the computer. Then press the power button to turn it on.
- If the computer still doesn't respond, remove the battery and AC adapter, remove any PC cards, and undock the computer if docked. Then plug in the AC adapter again, and reset the computer using the reset button.

### **If the computer won't boot from battery power**

- Make sure the battery is properly inserted and fully charged. Check the battery's charge by removing it and pressing the pad on the side of the battery. The lights show the charge level.
- If available, try another battery.

---

## Testing the Hardware

The e-Diagtools hardware diagnostic program included with your computer provides two levels of testing:

- Automated testing using its basic hardware test.
- Advanced testing using individual hardware tests.

The tests are designed to run after the system reboots. This ensures that the computer will be in a predictable state, so the diagnostic program can properly test the hardware components. The tests are non-destructive and are intended to preserve the state of the computer. The computer reboots when you exit the program so drivers can be loaded.

---

### To run the e-Diagtools diagnostic test

1. Click Start, Turn Off Computer, Restart.
2. When the HP logo appears, press F10 to start the diagnostic test.  
The first time you run the program, you are prompted to select the language for the program.
3. When the menu appears, press F2 to run e-Diagtools.
4. When the Configuration Description appears, check the list of detected hardware.
5. **Run the basic test.** Press F2 to start the basic hardware test. The results appear when the test is complete.
6. If you intend to exit without running the advanced tests, press F4 to view the Support Ticket. Press F3 to exit e-Diagtools.
7. **Optional: run the advanced tests.** Press F2 to open the advanced test screen.
8. Use the arrow keys and ENTER to select the test you want to run. Tests are listed only for detected hardware.
9. Press F2 to run the selected tests and add the results to the Support Ticket.
10. After each run, press F2 to return to the advanced test screen, or press F4 to view the Support Ticket.
11. **Exit.** Press F3 and then any key to exit and reboot.

12. **Optional: open the Support Ticket.** In Windows, click Start, All Programs, Hewlett-Packard, Notebook, HP e-Diagtools, e-Diagtools for Windows.
13. Click View to display the Support Ticket.
14. To add information about your problem, click Comments, type the information, and then click OK.

To save or print the Support Ticket, click Save As or Print.

To e-mail the Support Ticket to your support agent, click e-Mail. The first time you make an e-mail connection from this program, click Change Settings in the Connect window and enter the settings recommended by your support agent.

e-Diagtools for Windows can also update the version of e-Diagtools on your computer's hard disk. In e-Diagtools for Windows, use the e-Diagtools menu.

If you have trouble running e-Diagtools diagnostics from the hard disk, you can also run it from the *Recovery CD* or *DVD*. Boot from the CD or DVD and select the diagnostics option.

---

## Configuring the Computer

---

### To run the BIOS Setup utility

The BIOS (Basic Input and Output System) Setup utility enables you to make changes to the computer's system configuration, and to tailor the operation of your computer to your individual work needs.

The settings made in BIOS Setup generally control the computer's hardware, and so greatly affect how the computer operates.

1. Click Start, Turn Off Computer, Restart.
2. When the HP logo appears, press F2 to enter BIOS Setup.
3. The pointing devices are not active in BIOS Setup, so you will need to use the keyboard to navigate:
  - Press the LEFT and RIGHT arrow keys to move among menus.
  - Press the UP and DOWN arrow keys to move among parameters in a menu.
  - Press + or – to move through values for the current parameter, or press ENTER to change a setting.
4. After you select the options you want, press F10 or use the Exit menu to exit BIOS Setup.
5. If the settings cause a conflict between devices during reboot, the system prompts you to run BIOS Setup, and marks the conflicting settings.

For a complete list of BIOS Setup menus, settings, and options, see the online *Reference Guide*.



---

## Reinstalling and Updating Software

You can use the *Recovery CD* or *DVD* to recover the original software build for your computer.

The *Recovery CD* or *DVD* also provides Windows drivers specific to your computer to configure a custom system. You can find drivers in these locations:

- On your computer's hard drive under C:\hp\Drivers.
- On the *Recovery CD* or *DVD* under \hp\Drivers.
- On the HP Business Support Web site ([www.hp.com/go/bizsupport](http://www.hp.com/go/bizsupport)). This Web site contains the latest updates of software drivers for different operating systems.

---

### To recover the factory installation of your hard disk

You can use the *Recovery CD* or *DVD* to reinstall the original factory software on your computer's hard disk. You can also use the same process to create a Utility partition on a new hard disk. The hidden Utility partition contains the e-Diagtools diagnostic tests.

---

#### CAUTION

**This procedure formats the computer's hard disk drive and erases all data on the disk. After the hard disk is formatted, you'll need to reinstall your applications.**

**Do not interrupt the following process or unplug the AC adapter until the process is complete.**

1. **Important.** Back up all data from your hard disk. The following steps delete all data from the disk.
2. Plug in the AC adapter.
3. Insert the *Recovery CD* or *DVD* in the CD-ROM or DVD drive. To open the drive when the computer is turned off, insert a straightened paper clip into the hole on the front of the drive.
4. Turn on or restart the computer. If the computer is running, click Start, Turn Off Computer, Restart.
5. When you see the HP logo, press ESC.
6. Select the CD or DVD drive as the boot device.

## Troubleshooting and Maintenance

### Reinstalling and Updating Software

7. When the *Recovery CD or DVD* dialog box appears, follow the displayed instructions. To perform a standard recovery, press 2, 1, 1. If prompted, accept the recommended partition size. If you install the factory software, the recovery process can take 15 to 45 minutes.

If you want to create the Utility partition without installing the factory software, click Advanced and select the option to not install the operating system.

8. When prompted to reboot the computer, press CTRL+ALT+DEL and follow any instructions that appear onscreen.

---

## HP Support and Service

---

## Getting Assistance for Your Computer

---

### To get help from the Web

HP has several Web sites on the Internet dedicated to providing information to HP notebook computer users. The following sites are especially useful for helping you get support for your computer:

- **HP Business Support Web site.** Get e-mail and telephone support information, technical information, and software updates.  
[www.hp.com/go/bizsupport](http://www.hp.com/go/bizsupport)
- **HP Notebook Computer Web site.** Get the latest information about technical support, plus information about warranty and support programs.  
[www.hp.com/notebooks](http://www.hp.com/notebooks)

---

### To contact HP for support or service

HP Customer Care Centers will assist you free of charge during the term of the warranty (you are responsible for the telephone charges).

**During the free assistance period, HP will assist with questions about:**

- Included applications and operating systems.
- HP-described operation environments and conditions.
- HP accessories, HP upgrades, and basic operation and troubleshooting.

**HP will not be able to help with questions about:**

- Non-HP hardware, software, operating systems, or usage not intended for or included (by HP) with the product.
- How to repair the product yourself.
- Product development, custom installations.
- Consulting.

To contact the HP Customer Care Center by e-mail, visit the HP Business Support Web site ([www.hp.com/go/bizsupport](http://www.hp.com/go/bizsupport)) under “Contact HP”.

To call the Customer Care Center, check the HP Business Support Web site ([www.hp.com/go/bizsupport](http://www.hp.com/go/bizsupport)) under “Contact HP” for the most complete and current list of phone numbers. If your HP notebook product is not normally sold by HP in the country of use, you must call a Customer Care Center that supports your notebook model. Currently, service and support assistance is provided only in the following countries and regions:

**Pavilion models**

United States: (208) 323-2551.

United Kingdom: +44 (0)207-512-52-02

France: +33 (0)1-43-62-34-34

Mexico:

    Mexico City: 52-58-9922

    outside Mexico City: 01-800-472-6684

Australia: 61-3-8877-8000

For best service, make sure you have as much of the following available when you call:

- Your computer’s model and serial number.
- Your computer’s operating system.
- Any messages displayed when the problem occurred.
- Were there any changes to the computer, software, related hardware, or accessories before this occurred? Can the problem be re-created?

## To receive repair service

If the HP notebook product is not normally sold by HP in the country of use, it must be returned for service to a country in which it is sold and supported.

---

**Note**

HP Pavilion notebooks have regional support and service in selected countries. Currently, HP Pavilion notebook PCs are supported only in the country in which they are purchased and marketed. If you are outside the country of purchase, you must cover the cost of shipping your notebook to the appropriate HP authorized repair site.

If you are uncertain about the support available for your notebook, please contact HP Customer Care—see “To contact HP for support or service” on page 52.

---

**If your computer is under warranty.** To receive warranty repair service, contact an HP-authorized reseller, or contact the HP Customer Care Center—see “To contact HP for support or service” on page 52. The support technician will help qualify your unit for warranty repair based on the warranty applicable to your unit and original purchase date, and will provide you with repair processes. Warranty service may include the cost of shipping, handling, duties, taxes, freight, or fees to or from the service location.

**If your computer is no longer under warranty.** Contact an HP-authorized reseller or the HP Customer Care Center (see “To contact HP for support or service” on page 52). The support provider will let you know about repair charges and processes.

---

**Note**

You are financially responsible for any repairs to your notebook that are not covered by the HP warranty—see the warranty statement on the next page. This includes any repairs required if you damage your notebook—for example, by spilling liquid onto it, dropping it, or breaking the display.

In addition, most DVD drives let you change the region code only a limited number of times (usually no more than four) to allow you to set the proper region code for your area. When you reach this limit, your last change to the region code will be hard-coded on the DVD drive, and will be permanent. Your HP warranty does not cover the expense of correcting this situation.

---

---

## To prepare your computer for shipment

See “To receive repair service” above to determine if your computer must be sent in for service. If so, prepare your computer for shipment as follows.

---

**Note**

If you have questions about packaging requirements when returning your notebook for repair, contact HP Service and Support—see “To contact HP for support or service” on page 52. If your notebook is not packaged properly, you will be responsible for any damages to it that occur during shipping.

1. **Important.** Back up your hard disk drive. The hard disk may need to be replaced or reformatted while your computer is being repaired.
2. Hewlett-Packard cannot guarantee the return of removable components. Please remove the following prior to sending your computer in for service:
  - PC cards.
  - AC adapter and power cord.
  - Any removable media, such as CDs, DVDs, or floppy disks.
  - Any hardware not involved in the problem and not requested for repair.
3. When sending your notebook to Hewlett-Packard, please use the original product packaging or other substantial packaging to avoid damage to the unit in transit. Make sure that at least three inches of suitable packing material surround the unit.

Your notebook will be returned to you in new packaging.

---

**Note**

If the hard disk drive is defective, you will receive a replacement drive that is either unformatted or loaded with software for verification. You should restore the computer’s original software using your *Recovery CD* or *DVD* (see “To recover the factory installation of your hard disk” on page 49) or other recovery method.

---

---

## Hewlett-Packard Limited Warranty Statement

1. HP warrants to you, the end-user customer, that HP hardware, accessories and supplies will be free from defects in materials and workmanship after the date of purchase, for the period specified in the Warranty Duration table below. If HP receives notice of such defects during the warranty period, HP will, at its option, either repair or replace products which prove to be defective. Replacement products may be either new or equivalent in performance to new.
2. HP warrants to you that HP software will not fail to execute its programming instructions after the date of purchase, for the period specified in the Warranty Duration table below, due to defects in material and workmanship when properly installed and used. If HP receives notice of such defects during the warranty period, HP will replace software which does not execute its programming instructions due to such defects.
3. HP does not warrant that the operation of HP products will be uninterrupted or error free. If HP is unable, within a reasonable time, to repair or replace any product to a condition as warranted, you will be entitled to a refund of the purchase price upon prompt return of the product.
4. HP's limited warranty is valid in any country or locality where HP has a support presence for this product and where HP has marketed this product. The level of warranty service you receive may vary according to local standards. HP will not alter form, fit or function of the product to make it operate in a country for which it was never intended to function for legal or regulatory reasons.
5. Warranty does not apply to defects resulting from (a) improper or inadequate maintenance or calibration, (b) software, interfacing, parts or supplies not supplied by HP, (c) unauthorized modification or misuse, (d) operation outside of the published environmental specifications for the product, or (e) improper site preparation or maintenance.
6. **TO THE EXTENT ALLOWED BY LOCAL LAW, THE ABOVE WARRANTIES ARE EXCLUSIVE AND NO OTHER WARRANTY OR CONDITION, WHETHER WRITTEN OR ORAL, IS EXPRESSED OR IMPLIED AND HP SPECIFICALLY DISCLAIMS ANY IMPLIED WARRANTIES OR CONDITIONS OF MERCHANTABILITY, SATISFACTORY QUALITY, AND FITNESS FOR A PARTICULAR PURPOSE.** Some countries, states or provinces do not allow limitations on the duration of an implied warranty, so the above limitation or exclusion might not apply to you. This warranty gives you specific legal rights and you might also have other rights that vary from country to country, state to state, or province to province.



7. TO THE EXTENT ALLOWED BY LOCAL LAW, THE REMEDIES IN THIS WARRANTY STATEMENT ARE YOUR SOLE AND EXCLUSIVE REMEDIES. EXCEPT AS INDICATED ABOVE, IN NO EVENT WILL HP OR ITS SUPPLIERS BE LIABLE FOR LOSS OF DATA OR FOR DIRECT, SPECIAL, INCIDENTAL, CONSEQUENTIAL (INCLUDING LOST PROFIT OR DATA), OR OTHER DAMAGE, WHETHER BASED IN CONTRACT, TORT, OR OTHERWISE. Some countries, states or provinces do not allow the exclusion or limitation of incidental or consequential damages, so the above limitation or exclusion may not apply to you.

THE WARRANTY TERMS CONTAINED IN THIS STATEMENT, EXCEPT TO THE EXTENT LAWFULLY PERMITTED, DO NOT EXCLUDE, RESTRICT OR MODIFY AND ARE IN ADDITION TO THE MANDATORY STATUTORY RIGHTS APPLICABLE TO THE SALE OF THIS PRODUCT TO YOU.

<b>Product</b>	<b>Duration of Limited Warranty</b>
HP Notebook with "1YR", "3YR", or similar mark on serial-number label	1 year, 3 years, or number of years marked.
HP Notebook with "90D" or similar mark on serial-number label	90 days or number of days marked.
HP Notebook accessories and batteries	1 year
Non-HP accessories	Not warranted by HP. Refer to manufacturer's warranty.
HP Software, Microsoft Software	90 days



---

## Reference Information

Reference Information  
**Hardware Specifications**

---

## Hardware Specifications

---

### Technology Codes

Each HP notebook computer has a two-letter technology code. The technology code is shown on the serial-number label on the bottom of the computer, and it is also included in the BIOS version number.

Because we are constantly improving our products, the specifications shown below are subject to change. For the latest specifications, see the HP Notebook Web site ([www.hp.com/notebooks](http://www.hp.com/notebooks)).

<b>Physical Attributes</b>	Size (14-inch display): 328 × 272 × 33 mm (12.9 × 10.7 × 1.3 in). Size (15-inch display): 328 × 272 × 35 mm (12.9 × 10.7 × 1.4 in). Weight: 2.9 kg (6.5 lb) minimum, depending on configuration.
<b>Processor and Bus Architecture</b>	<b>Models with Technology Code KA:</b> AMD Athlon 1600+ to 1900+ (1.3- to 1.6-GHz) or 1.3-GHz Duron processor with PowerNow. <b>Models with Technology Code KB:</b> 1.6- to 2.0-GHz Intel Mobile Pentium 4 processor-M with Intel Speed Step technology. 512-KB L2 cache. 1.2- to 1.3-V core low-power processor with 400-MHz processor system bus.
<b>Video</b>	14.1-inch XGA (1024 × 768), or 15.0-inch XGA (1024 × 768) or SXGA+ (1400 × 1050) active-matrix (TFT) LCD display. Hardware 3D acceleration, hardware DVD acceleration. <b>Models with Technology Code KA:</b> External monitors up to 1600 × 1200 resolution, 16M colors, and at least 85 Hz refresh rate. Refresh rate and clarity may vary depending on monitor, resolution, and color depth. ATI U1 graphics with 16- to 64-MB video RAM shared with system RAM, 4x AGP graphics capability. Dual display capability (depends on operating system support). <b>Models with Technology Code KB:</b> External monitors up to 1600 × 1200 resolution, 16M colors, and at least 85 Hz refresh rate (only 60 Hz at 1400 × 1050). Refresh rate and clarity may vary depending on monitor, resolution, and color depth. ATI Mobility Radeon graphics accelerator with 16- or 32-MB DDR graphics memory, 4x AGP graphics capability. Dual display capability (depends on operating system support).

<b>Power</b>	<p>Rechargeable lithium-ion (14.8 Vdc) battery with LED charge-level gauge.          Battery life: up to 3 hours typical (varies with model, usage, and power settings).          Fast battery recharge: 2 hours when system is off, 3 hours when system is on.          Low-battery warning.          Suspend/resume capability.          Universal AC adapter: 100–240 Vac (50/60 Hz) input, 19 Vdc output, 75 W.</p>
<b>Mass Storage</b>	<p>20- to 60-GB removable hard drive with Ultra-DMA 100 interface.          1.44-MB floppy drive module (certain models).          24x CD-ROM, or 8x DVD, or CD-RW, or CD-RW/DVD drive (or higher).</p>
<b>RAM</b>	<p>At least 128 MB RAM preinstalled.  <b>Models with Technology Code KA:</b>          Two slots for PC2100 DDR-266 RAM modules.          Up to 1 GB (1024 MB) RAM.  <b>Models with Technology Code KB:</b>          Two slots for PC2100 DDR-266 RAM modules.          Up to 1 GB (1024 MB) RAM using 512-MB modules, future support for 2 GB RAM maximum.</p>
<b>Audio System</b>	<p>Stereo sound via two built-in speakers.          3D-enhanced audio.          Volume and mute buttons (certain models).          Built-in microphone (certain models).          Headphone-out and microphone-in.</p>
<b>Keyboard and Pointing Devices</b>	<p>87/88-key touch-type QWERTY keyboard with 101/102 key emulation.          Embedded numeric keypad.          12 function (Fn) keys.          5 user-programmable One-Touch buttons.          Touch pad with integrated scroll pad, on-off button and indicator.          Left and right click buttons.</p>
<b>LAN</b> (certain models)	<p>Ethernet 10Base-T (10 Mbps) and 100Base-TX (100 Mbps) support.          Supports wake-on-LAN, fast IP, DMI, dRMON.          MBA (Managed Boot Agent) support for PXE/BINL, NCP/IPX, DHCP.</p>
<b>Modem</b> (certain models)	<p>Software-based modem.          Data speed: 56 Kbps (V.92) maximum.          Fax speed: 14.4 Kbps, Class 1 and 2.          Modulation: V.21, V.22, V.22bis, V.23, V.32, V.32bis, V.34, V.90, V.92, X2, Bell 103, Bell 212A.          Synchronous transfer: V.80.          Compression: V.42bis, MNP5.          Error correction: V.42, MNP2-4.          Fax: Group 3 fax, Class 1. V.17, V.27ter, V.29, V.21.</p>

Reference Information  
**Hardware Specifications**

<b>Wireless LAN</b> (certain models)	Radio: IEEE 802.11b, WECA Wi-Fi compliant, direct-sequence spread-spectrum. Operating frequency: 2.4-GHz ISM band, exact frequencies and channels depend on country. Raw data rate: 1, 2, 5.5, or 11 Mbps. Transmitter output: 15 dBm typical (approx. 30 mW), 16 dBm max (approx. 40 mW). Receiver sensitivity: –84 dBm typical. Range: up to 100 m (300 ft) or more, depending on environment and conditions. On-off button and indicator. Mini-PCI interface.
<b>Bluetooth PAN</b> (certain models)	Radio: Bluetooth 1.1 compliant, frequency-hopping spread-spectrum. Operating frequency: 2.4-GHz ISM band. Raw data rate: 721 kbps Transmitter output: 1 dBm typical. Receiver sensitivity: –82 dBm typical. Range: up to 10 m (30 ft), depending on environment and conditions. On-off button and indicator. Internal USB interface.
<b>Input/Output</b>	9-pin, 115,200-bps serial. 25-pin bi-directional ECP/EPP parallel. 15-pin VGA video-out with DDC support. S-video TV out (certain models). PS/2 keyboard/mouse. 4-Mbps IrDA-compliant infrared port (certain models). IEEE-1394 (certain models). Universal serial bus (USB 1.1), two ports.
<b>Expandability</b>	One or two 16-/32-bit PC Card slots, Type II or III, CardBus enabled. Optional port replicator (certain models).
<b>Security Features</b>	User and administrator passwords. System password. PC identification displayed at boot. DMI-accessible electronic serial number. Kensington MicroSaver lock slot.
<b>Environmental Limits</b>	Operating temperature: 5 to 35 °C (41 to 95 °F). Operating humidity: 20 to 90 percent RH (5 to 35 °C). Operating altitude: up to 3000 m (10,000 ft) at 25 °C (77 °F). Storage temperature: –20 to 50 °C (–4 to 122 °F).

<b>Major ICs</b>	<p><b>Models with Technology Code KA:</b> CPU: AMD Athlon or Duron processor. Core logic: ATI U1 / ALI 1535+ chipset. Display controller: ATI M6 integrated in core logic. Audio/Modem controller: Conexant Smart AMC CX20468-21. CardBus controller: O2Micro 6912. Keyboard/embedded controller: National PC87570. Super I/O: integrated in core logic. IEEE 1394: TI TSB43AB22. LAN: National NS83815. 802.11b wireless LAN: Ambit with Intersil Prism 2.5 chipset. Bluetooth: Ambit with muRata/CSR BlueCore2.</p> <p><b>Models with Technology Code KB:</b> CPU: Intel Mobile Pentium 4 processor-M. Core logic: ALI 1671 / 1535+ chipset. Display controller: ATI Mobility Radeon M6-C/P. Audio/Modem controller: Conexant Smart AMC CX20468-21. CardBus controller: TI PC1520. Keyboard/embedded controller: National PC87570. Super I/O: integrated in core logic. IEEE 1394: TI TSB43AB22. LAN: National NS83815. 802.11b wireless LAN: Ambit with Intersil Prism 2.5 chipset. Bluetooth: Ambit with muRata/CSR BlueCore2.</p>
------------------	--

---

## Safety Information

---

---

### Power Cords

The power cord supplied with the computer's AC adapter should match the plug and voltage requirements for your local area. Regulatory approval for the AC adapter has been obtained using the power cord for the local area. However, if you travel to a different area or need to connect to a different outlet or voltage, you should use one of the power cords listed below. To purchase a power cord (including one for an area not listed below) or a replacement AC adapter, contact your local Hewlett-Packard dealer or Sales and Service office. For any power cord with a fused plug, if you have to replace the fuse, be sure to install an approved fuse.

<b>Country or Region</b>	<b>Rated Voltage and Current</b>	<b>HP Part Number</b>
Canada Mexico Philippines Taiwan United States	125 Vac (3 A)	8120-6313
East and West Europe Egypt Saudi Arabia	250 Vac (2.5 A)	8120-6314
Hong Kong Singapore United Kingdom	250 Vac (2.5 A)	8120-8699
Australia New Zealand	250 Vac (2.5 A)	8120-6312
Japan	125 Vac (3 A)	8120-6316
India	250 Vac (2.5 A)	8121-0702
South Africa	250 Vac (2.5 A)	8120-6317
Argentina	250 Vac (2.5 A)	8120-8367
Chile	250 Vac (2.5 A)	8120-8452
China	250 Vac (2.5 A)	8120-8373
South Korea	250 Vac (2.5 A)	8120-8441



---

## Ergonomics

---

### WARNING

**Improper use of keyboards and other input devices has been associated with ergonomic injury. For information about reducing your risk, see *Working in Comfort* in the online HP Library or visit our ergonomics Web site, [www.hp.com/ergo](http://www.hp.com/ergo).**

---

## Battery Safety

---

### Note

The following batteries are compatible only with HP notebook computers:

- HP: F4809 and F4812
- Sanyo: 4UR18650F-2-QC-KT
- Simplo: 916-2150
- Panasonic: CGR-B/862AE

- To avoid risk of fire, burns, or damage to your battery pack, do not allow a metal object to touch the battery contacts.
- Do not disassemble the battery. There are no serviceable parts inside. Do not dispose of the battery pack in fire or water.
- Handle a damaged or leaking battery with extreme care. If you come in contact with the electrolyte, wash the exposed area with soap and water. If it contacts the eye, flush the eye with water for 15 minutes and seek medical attention.
- Do not expose the battery pack to storage temperatures above 60 °C (140 °F).
- When discarding a battery pack, contact your local waste disposal provider regarding local restrictions on the disposal or recycling of batteries.
- To obtain a replacement battery, contact your local dealer or HP sales office.
- Do not charge the battery pack if the ambient temperature exceeds 45 °C (113 °F).
- Replace only with the same or equivalent type battery pack recommended by the manufacturer.
- This product contains a lithium-ion or nickel-metal-hydride battery, and may require special handling at end-of-life.

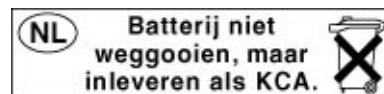

## Laser Safety

The CD-ROM and DVD drives used with the computer are certified as a Class 1 laser devices according to the U.S. Department of Health and Human Services (DHHS) Radiation Performance Standard and International Standards IEC 825 / IEC 825-1 (EN60825 / EN60825-1). These devices are not considered harmful, but the following precautions are recommended:

- Ensure proper use by reading and following the instructions carefully.
- If the unit requires service, contact an authorized HP service center—see “To contact HP for support or service” on page 52.
- Do not attempt to make any adjustment of the unit.
- Avoid direct exposure to the laser beam—do not open the unit.

CLASS 1 LASER PRODUCT LASER KLASSE 1
---

---

## LED Safety

The infrared port located on the front of certain models is classified as a Class 1 LED (light-emitting diode) device according to International Standard IEC 825-1 (EN60825-1). This device is not considered harmful, but the following precautions are recommended:

- If the unit requires service, contact an authorized HP service center—see “To contact HP for support or service” on page 52.
- Do not attempt to make any adjustment of the unit.
- Avoid direct eye exposure to the infrared LED beam. Be aware that the beam is invisible light and cannot be seen.
- Do not attempt to view the infrared LED beam with any type of optical device.

CLASS 1 LED PRODUCT LEDSCHÜTZKLASSE 1 PRODUKT
--

---

## Mercury Safety

This product contains mercury in the fluorescent lamp of the liquid-crystal display, and may require special handling at end-of-life.

---

## Exposure to Radio Frequency Radiation

The radiated output power of the IEEE 802.11 and Bluetooth internal wireless radio is far below the FCC radio frequency exposure limits. Nevertheless, the wireless radio shall be used in such a manner that the potential for human contact during normal operation is minimized.

The internal wireless radio operates within guidelines found in radio frequency safety standards and recommendations, which reflect the consensus of the scientific community. HP therefore believes the internal wireless radio is safe for use by consumers. The level of energy emitted is far less than the electromagnetic energy emitted by wireless devices such as mobile phones. However, the use of wireless radios may be restricted in some situations or environments, such as aboard airplanes. If you are unsure of restrictions, you are encouraged to ask for authorization before turning on the wireless radio.

---

## Regulatory Information

This section presents information that shows how your computer complies with regulations in certain regions. Any modifications to your computer not expressly approved by Hewlett-Packard could void the authority to operate the computer in these regions.

---

### U.S.A.

This computer has been tested and found to comply with the limits for a Class B digital device, pursuant to Part 15 of the FCC Rules. These limits are designed to provide reasonable protection against harmful interference in a residential installation.

This computer generates, uses, and can radiate radio frequency energy. If not installed and used in accordance with the instructions, it may cause harmful interference to radio communications. However, there is no guarantee that interference will not occur in a particular installation. If this computer does cause harmful interference to radio or television reception (which can be determined by removing the unit's batteries and AC adapter), try the following:

- Reorienting or relocating the receiving antenna.
- Relocating the computer with respect to the receiver.
- Connecting the computer's AC adapter to another power outlet.

### **Connections to Peripheral Devices**

To maintain compliance with FCC Rules and Regulations, use properly shielded cables with this device.

For more information, consult your dealer, an experienced radio/television technician, or the following booklet, prepared by the Federal Communications Commission: *How to Identify and Resolve Radio-TV Interference Problems*. This booklet is available from the U.S. Government Printing Office, Washington, DC 20402, Stock Number 004-000-00345-4. At the first printing of this manual, the telephone number was (202) 512-1800.

**Declaration of Conformity (U.S.A.)**

**Responsible Party:** Hewlett-Packard Company  
Manager of Corporate Product Regulations  
3000 Hanover Street  
Palo Alto, CA 94304  
+1 (650) 857-1501

declares that the product(s)

**Trade name:** Hewlett-Packard Company

**Product name:** HP Pavilion ZE4... and XT... series

Complies with Part 15 of the FCC Rules. Operation is subject to the following two conditions:

1. This device may not cause harmful interference, and
2. This device must accept any interference received, including interference that may cause undesired operation.

---

## Canada

This digital apparatus does not exceed the Class B limits for radio noise emissions from digital apparatus as set out in the radio interference regulations of the Canadian Department of Communications. The internal wireless radio complies with RSS 210 of Industry Canada.

Le présent appareil numérique n'émet pas de bruits radioélectriques dépassant les limites applicables aux appareils numériques de Classe B prescrites dans le règlement sur le brouillage radioélectrique édicté par le Ministère des Communications du Canada. Le composant RF interne est conforme à la norme CNR-210 d'Industrie Canada. L'utilisation de ce dispositif est autorisée seulement aux conditions suivantes : (1) il ne doit pas produire de brouillage et (2) l'utilisateur du dispositif doit être prêt à accepter tout brouillage radioélectrique reçu, même si ce brouillage est susceptible de compromettre le fonctionnement du dispositif.

## European Union

The equipment has been approved in accordance with Council Decision 98/482/EC for pan-European single terminal connection to the public switched telephone network (PSTN) and to a radio-frequency wireless network. However, due to differences between the individual PSTN's provided in different countries, the approval does not, of itself, give an unconditional assurance of successful operation on every PSTN network termination point.

In event of problems, you should contact your equipment supplier in the first instance.

This equipment has been designed to work in all of the countries of the European Economic Area (Public Switched Telephone Networks). Network compatibility is dependent on internal software settings. Contact your equipment supplier if it is necessary to use the equipment on a different telephone network. For further product support, contact Hewlett-Packard—see “To contact HP for support or service” on page 52.

**Belgium:** For outdoor usage only channels 10 (2457 MHz) through 13 (2472 MHz) are allowed. For private usage outside buildings across public grounds over less than 300m, no special registration with IBPT/BIPT is required. Registration to IBPT/BIPT is required for private usage outside buildings across public grounds over more than 300m. An IBPT/BIPT license is required for public usage outside building. For registration and license please contact IBPT/BIPT.

**France:** Restricted frequency band: only channels 10 through 13 (2457 MHz through 2472 MHz respectively) may be used in France. License required for every installation, indoor and outdoor installations. Please contact ART for the procedure to follow. Use with outdoor installations not allowed.

**Germany:** License required for outdoor installations. Check with reseller for procedure to follow.

**Netherlands:** License required for outdoor installations. Check with reseller for procedure to follow.

**Italy:** Indoor or outdoor use in a public area requires a user license.

---

## Japan

この装置は、情報処理装置等電波障害自主規制協議会（VCCI）の基準に基づくクラスB情報技術装置です。この装置は、家庭環境で使用することを目的としていますが、この装置がラジオやテレビジョン受信機に近接して使用されると受信障害を引き起こすことがあります。

取り扱い説明書に従って正しい取り扱いをして下さい。

### Japan Telecommunications Approval

Name of Equipment: AMC20493-001-KT1, AMC20493-001-KT3,  
AMC20493-001-KT5, AMC20493-001

機器に内蔵の無線LANをお使いのお客様へ。

この機器の使用周波数帯では、電子レンジ等の産業・科学・医療用機器のほか工場の製造ライン等で使用されている移動体識別用の構内無線局（免許を要する無線局）及び特定小電力無線局（免許を要しない無線局）が運用されています。

- 1 この機器を使用する前に、近くで移動体識別用の構内無線局及び特定小電力無線局が運用されていないことを確認して下さい。
- 2 万一、この機器から移動体識別用の構内無線局に対して電波干渉の事例が発生した場合には、速やかに使用周波数を変更するか又は電波の発射を停止した上、下記連絡先にご連絡頂き、混信回避のための処置等（例えば、パーティションの設置など）についてご相談して下さい。
- 3 その他、この機器から移動体識別用の特定小電力無線局に対して電波干渉の事例が発生した場合など何かお困りのことが起きたときは、次の連絡先へお問い合わせ下さい。

連絡先： 03-5344-7181

TELEC approval number: D02-0005JP  
Name of Equipment: T60H424

2.4DS1

Reference Information  
**Regulatory Information**

---

## Russia

Продукт сертифицирован в системе ГОСТ Р  
Модем сертифицирован в системе ЭЛЕКТРОСВ



---

## International

Products sold internationally by Hewlett-Packard and its authorized dealers meet the specifications listed on the following page.

---

**Note**

For regulatory identification purposes, your product is assigned a Regulatory Model Number. The Regulatory Model Number for your product is listed in the declaration below. This regulatory number is different from the marketing name and product number.

---



**Declaration of Conformity (according to ISO/IEC Guide 22 and EN 45014)**

**Manufacturer's Name:** Hewlett-Packard Company, Mobile Computing Division  
**Manufacturer's Address:** 19310 Pruneridge Ave., Cupertino, CA 95014, U.S.A.

declares that the following product

**Product Name:** Omnibook XE4... series, Pavilion ZE4... and ZE5... series, Pavilion XT... series  
**Regulatory Model Numbers:** CRVSA-02T1-60, CRVSA-02T1-75, CRVSA-02T1-90  
**Product Options:** Includes all options for analog modems (Conexant) and 802.11b and Bluetooth RF devices (Ambit)

conforms to the following product specifications

**Safety:** IEC 60950: 1991 +A1,A2,A3,A4 / EN 60950: 1992 +A1,A2,A3,A4,A11  
IEC 60825-1: 1993 +A1 / EN 60825-1: 1994 +A11 Class 1 LED  
GB4943-1995

**EMC:** EN 55022: 1994 +A1: 1995 +A2: 1997, Class B [1]  
CISPR 24: 1997 / EN 55024: 1998  
IEC 61000-3-2: 1995 / EN 61000-3-2:1995 +A1: 1998 +A2: 1998  
IEC 61000-3-3: 1994 / EN 61000-3-3:1995  
GB9254-1998  
FCC Title 47 CFR, Part 15 Class B/ANSI C63.4: 1992  
AS/NZS 3548: 1995 Rules and Regulations of Class B

**Telecom:** TBR 21: 1998, EG 201 121: 1998

**Radio:** EN 301 489-17: 2000 Specific conditions for wideband data HYPERLAN equipment  
**Equipment Class 2** EN 300 328-2: 2000 Technical requirements for Radio equipment  
Notified Body Number: 0682  
Notified Body Address: CETECOM ICT Services GmbH, Untertuerkheimer Str. 6-10, D-66117 Saarbruecken

**Supplementary Information:** The product herewith complies with the requirements of the R&TTE Directive 1999/5/EC and carries the CE marking accordingly.

[1] The product was tested in a typical configuration with Hewlett-Packard Personal Computer peripherals.

This device complies with Part 15 of the FCC Rules. Operation is subject to the following two conditions:  
(1) this device may not cause harmful interference, and (2) this device must accept any interference received, including interference that may cause undesired operation.

The HP F1454, F1781, F4600, F4814, F4813, F5104, 5950-4334, and 5950-4359 ac/dc adapters used with this product are designed to operate on all power systems, other than IT power systems.

Corvallis, OR, June 21, 2002



  
Jerry Erickson, R&D Product Execution Manager

European Contact for regulatory topics only: Hewlett Packard GmbH, HQ-TRE, Herrenberger Strasse 140, 71034 Boeblingen, Germany. Fax: +49 7031 143143.  
USA Contact: Hewlett Packard Co., Corporate Product Regulations Manager, 3000 Hanover Street, Palo Alto, CA 94304, U.S.A. Phone: +1 (650) 857-1501.



# Index

## A

- AC adapter
  - compatibility, 19
  - connecting, 19
- AC adapter jack
  - location, 13
- adding RAM, 38
- adjusting
  - brightness, 28
  - volume, 28
- antistatic precautions, 38
- AT commands, *See Reference Guide*
- audio
  - connecting devices, *See Reference Guide*
  - volume, 28
- audio jacks, 13
- audio mute button, 13

## B

- battery
  - checking status, 34
  - installing, 17
  - location, 12
  - low power warning, 35
  - release latch, 14
  - safety, 65
  - saving power, *See Reference Guide*
  - status lights, 34
  - troubleshooting, 44
- BIOS Setup utility
  - menus, *See Reference Guide*
  - using, 48
- boot device order, 25
- brightness
  - adjusting, 28

## C

- Caps Lock, 12, 16
- CD-ROM drive
  - location, 12
- clicking items, 27
- COM1 port, 13
- computer
  - caring for, *See Reference Guide*
  - changing BIOS settings, 48

- opening/closing, 12
- reinstalling Windows, 49
- resetting, 25
- testing, 46
- turning on, 21
- configuring
  - BIOS settings, 48
  - touch pad, 27
- connecting
  - external devices, *See Reference Guide*
  - LAN, *See Reference Guide*
  - modem, *See Reference Guide*
  - PC Cards, *See Reference Guide*
  - to Internet, *See Reference Guide*
- cursor (pointer), 27
- Customer Care
  - getting support, 52
  - Web site, 11

## D

- DDR-266 RAM, 38
- devices
  - about, *See Reference Guide*
  - temporary boot order, 25
- diagnostics, 46
- display
  - brightness, 28
  - connecting external, *See Reference Guide*
  - port, 13
  - troubleshooting, 42
- docking
  - See Reference Guide*, 24
- docking port, 14
- dragging items, 27
- drives
  - replacing hard disk, 39
- DVD drive
  - location, 12
  - playing movies, 29
  - setting region code, 29

## E

- e-Diagtools for Windows, 47
- e-mail
  - HP Customer Care, 53
- ergonomics, 17
- external devices

- installing, *See Reference Guide*
- external monitor, *See Reference Guide*
- external monitor port
  - location, 13
- external mouse
  - configuring, 27

## F

- F10 (diagnostics), 46
- files
  - recovering, 49
- floppy disk drive
  - location, 13
- Fn key
  - + Back Space (mute), 28
  - + F1 (decrease brightness), 28
  - + F12 (hibernate), 28
  - + F2 (increase brightness), 28
  - + F5 (display select), 28
  - + F8 (keypad), 28
  - + NumLock (scroll lock), 28
  - + Page Down (decrease audio), 28
  - + Page Up (increase audio), 28

## H

- hard disk drive
  - Hibernate partition, 39
  - location, 14
  - replacing, 39
  - troubleshooting, 43
- hardware specifications, 60
- Hewlett-Packard support, 52
- Hibernate mode
  - definition, 24
  - status lights, 15
- Hibernate partition, 39
- hot keys, 28
- HP Business Support
  - Web site, 11
- HP Customer Care
  - contact by e-mail, 53
  - getting support, 52
- HP Instant Support, 42
- HP Library, 11
- HP Notes, 11

- I
    - IEEE 1394 port
      - location, 13
    - infrared port
      - connecting, *See Reference Guide*
      - location, 12
      - safety, 66
    - installing
      - hard disk drive, 39
      - RAM, 38
    - installing original software, 49
    - Internet
      - connecting to, *See Reference Guide*
    - inventory, 10
  - K
    - keyboard
      - connecting external, *See Reference Guide*
      - ergonomic precautions, 17
      - opening, 38
      - status lights, 12, 16
      - troubleshooting, 43
    - Keypad Lock, 12, 16
  - L
    - LAN
      - connecting to, *See Reference Guide*
    - LAN port
      - location, 13
    - laser safety, 66
    - Library (HP), 11
    - lights
      - status, 12, 15, 16
    - LPT1 port, 13
  - M
    - memory
      - adding, 38
      - PC2100 DDR-266, 38
    - microphone
      - location, 12
    - mini-PCI
      - location, 14
    - modem
      - built-in, 20
      - connecting, *See Reference Guide*
      - port location, 13
    - monitor
      - port, 13
    - mouse
      - connecting, *See Reference Guide*
      - troubleshooting, 43
    - movies (DVD), 29
    - mute button
      - location, 13
  - N
    - Notebook Web sites, 11
    - Num Lock, 12, 16
  - O
    - off
      - button location, 12
      - status lights, 15
      - turning off, 24
    - on
      - button location, 12
    - One-Touch buttons
      - location, 12
  - P
    - parallel port
      - location, 13
    - partition (Utility), 49
    - PC Card slot
      - location, 13
    - PC Cards
      - installing, *See Reference Guide*
    - PC2100 DDR-266 RAM, 38
    - phone cord, connecting, 20
    - plug requirements, 64
    - pointing devices
      - configuring, 27
      - using, 27
    - port locations, 13
    - port replicator, *See Reference Guide*
    - power
      - connecting AC, 19
      - saving, *See Reference Guide*
      - troubleshooting, 44
    - power button
      - location, 12
      - resetting with, 25
    - power cords, 64
    - PS/2 port
      - location, 12
  - R
    - RAM
      - adding, 38
      - location, 14
      - PC2100 DDR-266, 38
    - rebooting
      - temporary boot device, 25
      - recovering original software, 49
  - Recovery CD or DVD
    - diagnostics, 47
    - using, 49
  - region code, 29
  - registering computer, 22
  - regulatory information, 68
  - removing
    - hard disk drive, 39
  - repair service
    - obtaining, 54
    - shipment, 55
  - reset button, 25
  - resetting, 25
- S
  - safety
    - battery use, 65
    - infrared port, 66
    - laser, 66
    - power cords, 64
  - scroll pad
    - location, 12
  - security
    - Kensington lock, 13
  - selecting items, 27
  - serial port
    - location, 13
  - setting up, 17
  - software
    - pre-installed, 10
  - specifications
    - hardware, 60
  - Standby mode
    - definition, 24
    - status lights, 15
    - timeout, 24
  - startup
    - troubleshooting, 45
  - static electricity, 38
  - status lights
    - battery charge, 34
    - keyboard, 12, 16
    - location, 12
    - meanings, 15
  - Support Ticket, 46
  - S-video port
    - location, 13
- T
  - technology code, 60
  - temperature
    - limits, 62

- touch pad
  - configuring, 27
  - location, 12
  - troubleshooting, 43
  - using, 27
- troubleshooting
  - battery, 44
  - display, 42
  - hard disk drive, 43
  - HP Instant Support, 42
  - keyboard, 43
  - pointing devices, 43
  - power, 44
  - startup, 45

- turning on computer, 21

## U

- URLs, 11

## USB

- connecting, *See Reference Guide*

## USB ports

- location, 13

## Utility partition

- creating, 49

## V

- voltage requirements, 64

## volume

- adjusting, 28

- volume control

- location, 13

## W

- warranty

- repair, 54

- Web sites, 11

## Windows

- documentation, 11

- reinstalling, 49

- setting up, 21

- wireless communication

- indicator light, 12