



User Guide

HP L156v 15" and L176v 17" LCD Monitors

Document Part Number: 432558-001

July 2006

This guide provides information on setting up the monitor, installing drivers, using the on-screen display menu, troubleshooting and technical specifications.

© Copyright 2006 Hewlett-Packard Development Company, L.P.
The information contained herein is subject to change without notice.

Microsoft, MS-DOS, Windows, and Windows NT are trademarks of Microsoft Corporation in the U.S. and other countries.

Adobe, Acrobat, and Acrobat Reader are trademarks or registered trademarks of Adobe Systems Incorporated.

The only warranties for HP products and services are set forth in the express warranty statements accompanying such products and services. Nothing herein should be construed as constituting an additional warranty. HP shall not be liable for technical or editorial errors or omissions contained herein.

This document contains proprietary information that is protected by copyright. No part of this document may be photocopied, reproduced, or translated to another language without the prior written consent of Hewlett-Packard Company.



WARNING: Text set off in this manner indicates that failure to follow directions could result in bodily harm or loss of life.



CAUTION: Text set off in this manner indicates that failure to follow directions could result in damage to equipment or loss of information.

User Guide

HP L156v 15" and L176v 17" LCD Monitors

First Edition (July 2006)

Document Part Number: 432558-001

Contents

1 Product Features

L156v Model	1-1
L176v Model	1-1

2 Safety and Maintenance Guidelines

Important Safety Information	2-1
Maintenance Guidelines	2-2
Cleaning the Monitor	2-3
Shipping the Monitor	2-3

3 Setting Up the Monitor

Installing and Removing the Base	3-1
Power Cord	3-2
Connecting the Monitor	3-2
Adjusting the Viewing Angle	3-3

4 Operating the Monitor

General Instructions	4-1
Front Panel Controls	4-1
L156v Model	4-2
L176v Model	4-3
OSD Lock Function	4-3
How To Adjust a Setting	4-4
Adjusting the Picture	4-4
Software and Utilities	4-7

The Information File	4-7
The Image Color Matching File	4-8
Installing the .INF and .ICM Files	4-8
Installing from the CD	4-8
Downloading from the Worldwide Web	4-9
Plug and Play	4-9
Plug & Play DDC2B Feature	4-9

A Troubleshooting

Solving Common Problems	A-1
Error Messages and Possible Solutions	A-2
Using the Worldwide Web	A-3
Preparing to call Technical Support	A-3

B Technical Specifications

L156v Model	B-1
L176v Model	B-4
Recognizing Preset Display Resolutions	B-6
L156v Model	B-6
L176v Model	B-7
Entering User Modes	B-8

C Agency Regulatory Notices

Federal Communications Commission Notice	C-1
Modifications	C-2
Cables	C-2
Declaration of Conformity for Products Marked with the FCC Logo (United States Only)	C-2
Materials disposal	C-3
ENERGY STAR Compliance	C-3
Power Cord Set Requirements	C-3

Product Features

The flat panel display has an active matrix, thin-film transistor (TFT), liquid crystal display (LCD). The monitor features include:

L156v Model

- 38.1cm (15") TFT Color LCD Monitor
- Crisp, clear display for Windows
- Recommended resolutions: 1024 x 768 @60Hz
- EPA ENERGY STAR®
- Ergonomic design
- Space saving, compact case design
- Power cord, signal cable, audio cable
- Software and documentation CD includes an information file (INF), Image Color Matching file (ICM), and product documentation

L176v Model

- 43.2cm (17") TFT Color LCD Monitor
- Crisp, clear display for Windows
- Recommended resolution: 1280 X 1024 @60Hz
- EPA ENERGY STAR®

- Ergonomic design
- Space saving, compact case design
- Power cord, signal cable, audio cable
- Software and documentation CD includes an information file (INF), Image Color Matching file (ICM), and product documentation

Safety and Maintenance Guidelines

Important Safety Information

A power cord is included with your monitor. If another cord is used, use only a power source and connection appropriate for this monitor. For information on the correct power cord set to use with your monitor, refer to the “Power Cord Set Requirements” section in Appendix C.



WARNING: To reduce the risk of electric shock or damage to your equipment, do not disable the power cord grounding feature. This equipment is designed to be connected to a grounded (earthed) power outlet that is easily accessible to the operator. The grounding plug is an important safety feature.



WARNING: For your safety, be sure that the power outlet you plug the power cord into is easily accessible and located as close to the equipment as possible. When you need to disconnect the power to the equipment, unplug the power cord from the power outlet by grasping the plug firmly. Never pull on the cord.



CAUTION: For the protection of your monitor, as well as your computer, connect all power cords for your computer and its peripheral devices (such as a monitor, printer, scanner) to some form of surge protection device such as a power strip or Uninterruptible Power Supply (UPS). Not all power strips provide surge protection; the power strips must be specifically labeled as having this ability. Use a power strip whose manufacturer offers a Damage Replacement Policy so you can replace your equipment if surge protection fails.

Maintenance Guidelines

To enhance the performance and extend the life of your monitor:

- Do not open your monitor cabinet or attempt to service this product yourself. Adjust only those controls that are covered in the operating instructions. If your monitor is not operating properly or has been dropped or damaged, contact your HP authorized dealer, reseller, or service provider.
- Use only a power source and connection appropriate for this monitor, as indicated on the label/back plate of the monitor.
- Be sure the total ampere rating of the products connected to the outlet does not exceed the current rating of the electrical outlet, and the total ampere rating of the products connected to the cord does not exceed the rating of the cord. Look on the power label to determine the ampere rating (AMPS or A) for each device.
- Install your monitor near an outlet that you can easily reach. Disconnect the monitor by grasping the plug firmly and pulling it from the outlet. Never disconnect the monitor by pulling the cord.
- Turn your monitor off when not in use. You can substantially increase the life expectancy of your monitor by using a screen saver program and turning off the monitor when not in use.

- Slots and openings in the cabinet are provided for ventilation. These openings must not be blocked or covered. Never push objects of any kind into cabinet slots or other openings.
- Do not drop your monitor or place it on an unstable surface.
- Do not allow anything to rest on the power cord. Do not walk on the cord.
- Keep your monitor in a well-ventilated area, away from excessive light, heat or moisture.
- When removing the monitor base, you must lay the monitor face down on a soft area to prevent it from getting scratched, defaced, or broken.

Cleaning the Monitor

1. Turn off the monitor and the computer.
2. Unplug the monitor from the wall outlet.
3. Clean the monitor plastics with a clean cloth dampened with water.
4. Clean the monitor screen with an antistatic screen cleaner.



CAUTION: Do not use benzene, thinner, ammonia, or any other volatile substances to clean your monitor or the screen. These chemicals may damage the cabinet finish as well as the screen.

Shipping the Monitor

Keep the original packing box in a storage area. You may need it later if you move or ship your monitor.

Setting Up the Monitor

To set up the monitor, ensure that the power is turned off to the monitor, computer system, and other attached devices, then follow the steps below.

Installing and Removing the Base

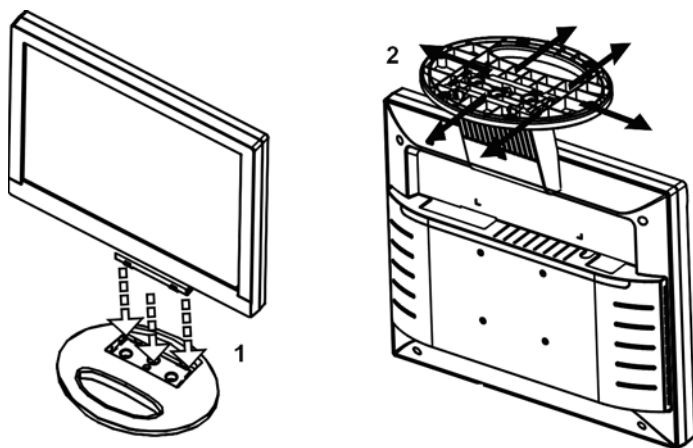

-
- ❶ Installing the base.
 - ❷ Removing the base.
-

Power Cord

Be sure the power cord is the correct type required in your region. This LCD monitor has an internal universal power supply that allows operation in either 100/120V AC or 220/240V AC voltage area (No user adjustment is required.)



A certified power supply cord has to be used with this equipment. The relevant national installation and/or equipment regulations shall be considered. A certified power supply cord not lighter than ordinary polyvinyl chloride flexible cord according to IEC 60227 (designation H05VV-F 3G 0.75mm² or H05VVH2-F2 3G 0.75mm²) shall be used. Alternative: a flexible cord of synthetic rubber according to IEC 60245 (designation H05RR-F 3G 0.75mm²) shall be used.

Connecting the Monitor

1. **Connecting the signal cable:** Connect one end of the signal cable into the LCD monitor's socket, the other end into the computer's VGA port, and tighten the two screws on the cable connector.
2. **Connecting the power cord:** Connect one end of the AC-power cord into the LCD monitor's AC input socket, the other end into the wall outlet.



CAUTION: If the AC outlet is not grounded (with three holes), install the proper grounding adapter (not supplied).

3. **Connecting the audio line:** Connect one end of an audio cable into the computer's multimedia (or sound) card's audio output, and the other end into the monitor's audio input.

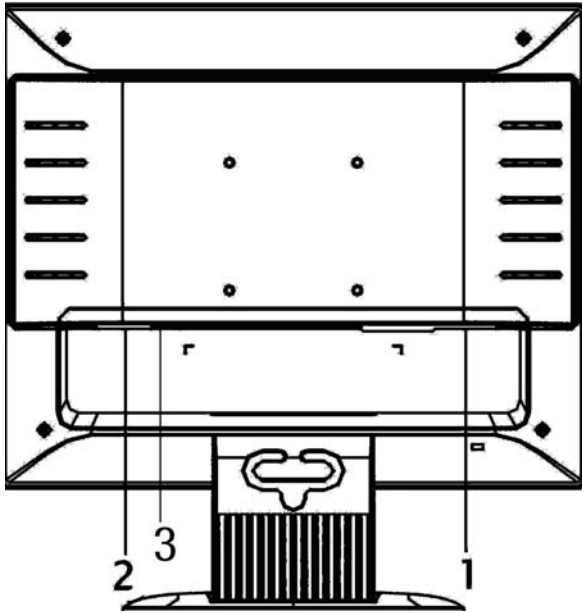

-
- ❶ VGA Input
 - ❷ AC Input socket
 - ❸ Audio Input
-

Adjusting the Viewing Angle

- For optimal viewing, it is recommended that you look at the full face of the monitor, then adjust the monitor's angle to your own preference.
- Hold the stand so you do not topple the monitor when you change the monitor's angle.
- You are able to adjust the monitor's angle from -5° to 20° .

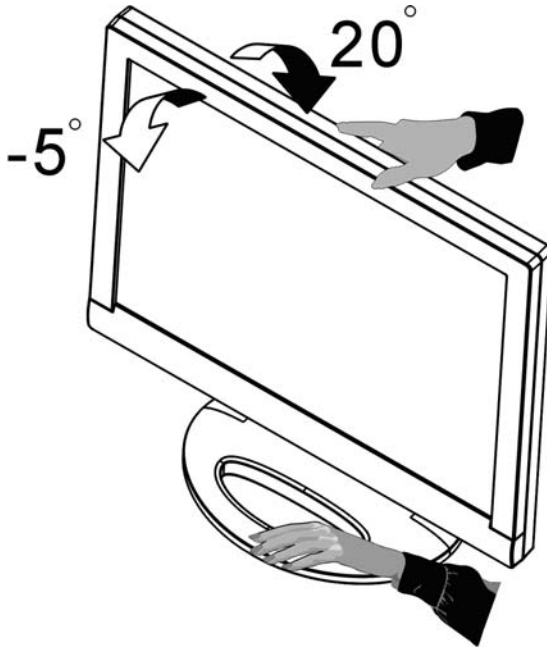

 **CAUTION:** Do not touch the LCD screen when you change the angle. It may cause damage or break the LCD screen. Careful attention is required not to catch your fingers or hands when you change the angle.

Operating the Monitor

General Instructions



Press the power button to turn the monitor on or off. The other control buttons are located at the front panel of the monitor. By changing these settings, the picture can be adjusted to your personal preference.

- The power cord should be connected.
- Connect the video cable from the monitor to the video card.
- Press the power button to turn on the monitor. The power indicator will light up.

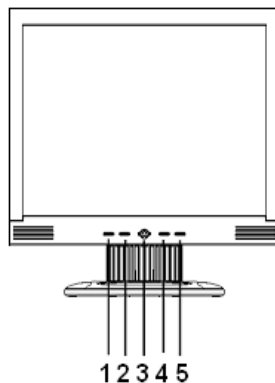

Front Panel Controls



L156v Model

Control	Function
① Auto Config / Exit	When OSD menu is in active status, this button will act as EXIT-KEY (EXIT OSD menu). When OSD menu is in off status, press this button to activate the Auto Adjustment function. The Auto Adjustment function is used to optimized the HPos, VPos, Clock and Focus.
②  / Volume	Decrease volume or adjust function.
③ Power Button/ Power Indicator	Press this button to switch the monitor's power ON/OFF. Blue - Power on mode Orange - Off mode
④  / Volume	Increase volume or adjust function.
⑤ Menu / Enter	Activates the OSD menu or function, adjusts, confirms or Exits OSD menu when in volume OSD status.

L176v Model

Control	Function
① Auto Adjust button / Exit	<p>When OSD menu is in active status, this button will act as EXIT-KEY (EXIT OSD menu).</p> <p>When OSD menu is in off status, press and hold this button for 2 seconds to activate the Auto Adjustment function.</p> <p>The Auto Adjustment function is used to set the HPos, VPos, Clock and Focus.</p>
②  / Volume	<p>Activates the volume control when the OSD is OFF or navigates through adjustment icons when OSD is ON or adjusts a function when function is activated.</p>
③ Power Button/ Power Indicator	<p>Press this button to switch the monitor's power ON/OFF.</p> <p>Green - Power on mode</p> <p>Orange - Off mode</p>
④  / Volume	<p>Activates the volume control when the OSD is OFF or navigates through adjustment icons when OSD is ON or adjusts a function when function is activated.</p>
⑤ Menu / Enter	<p>Activates the OSD menu or function, adjusts, confirms or Exits OSD menu when in Brightness/Contrast OSD status.</p>

OSD Lock Function

To lock the OSD, press and hold the MENU button while the monitor is off and then press power button to turn the monitor on. To unlock the OSD - press and hold the MENU button while the monitor is off and then press the power button to turn the monitor on.





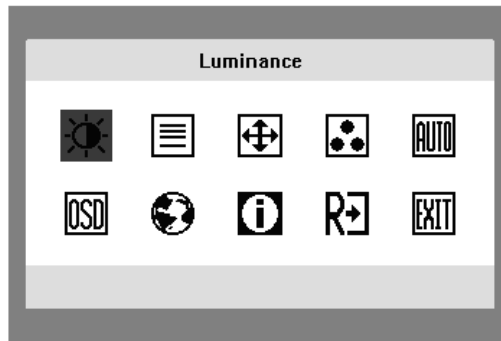





How To Adjust a Setting







1. Press the MENU-button to activate the OSD window.
2. Press < or > to navigate through the functions. Once the desired function is highlighted, press the MENU-button to activate it. If the function selected has a sub-menu, press < or > again to navigate through the sub-menu functions. Once the desired function is highlighted, press MENU-button to activate it.
3. Press < or > to change the settings of the selected function.
4. To exit and save, select the exit function. If you want to adjust any other function, repeat steps 2-3.





Adjusting the Picture

The descriptions for function control LEDs.

Main Menu Item	Main Menu Icon	Sub Menu Item	Sub Menu Icon	Description
Luminance		Contrast		Contrast from digital-register
		Brightness		Backlight adjustment
Image Setup		Focus		Adjust picture phase to reduce horizontal line noise
		Clock		Adjust picture Clock to reduce vertical-line noise
Image Position		H. Position		Adjust the horizontal position of the picture
		V. Position		Adjust the vertical position of the picture
Color Temp		Warm	N/A	Recall warm color temperature from EEPROM
		Cool	N/A	Recall cool color temperature from EEPROM
		User / Red	R	Red gain from digital-register

Main Menu Item	Main Menu Icon	Sub Menu Item	Sub Menu Icon	Description
		User / Green	G	Green gain digital-register
		User / Blue	B	Blue gain from digital-register
Auto Config		Yes	N/A	Auto adjust the H/V position, Focus and Clock of picture
		No	N/A	Do not execute Auto Config, return to main menu
OSD Setup		H. Position		Adjust the horizontal position of the OSD
		V. Position		Adjust the vertical position of the OSD
		OSD Timeout		Adjust the OSD timeout
Language		Language	N/A	Set OSD Language
Information		Information	N/A	Show the resolution, H/V frequency and input port of current input timing

Main Menu Item	Main Menu Icon	Sub Menu Item	Sub Menu Icon	Description
Reset		Yes	N/A	Clear each old status of Auto Configuration and set the color temperature to Cool
		No	N/A	Do not execute reset, return to main menu
Exit		N/A	N/A	Exit OSD

Software and Utilities

The monitor includes a CD that contains two files you can install on your computer:

- an .INF (Information) file
- an .ICM (Image Color Matching) file

Adobe Reader is supplied on this CD and can be installed from the menu.



If the monitor does not include a CD, the .INF and .ICM files can be downloaded from the HP monitors support Web site. See “Downloading from the Worldwide Web” in this chapter.

The Information File

The .INF file defines monitor resources used by Microsoft Windows operating systems to ensure monitor compatibility with the computer’s graphics adapter.

This monitor is Windows Plug and Play compatible and the monitor will work correctly without installing the .INF file. Monitor Plug and Play compatibility requires that the computer's graphic card is VESA DDC2 compliant and that the monitor connects directly to the graphics card. Plug and Play does not work through separate BNC type connectors or through distribution buffers/boxes. You may need to install the .INF file if these conditions are not met.

The Image Color Matching File

The .ICM files are data files that are used in conjunction with graphics programs to provide consistent color matching from monitor screen to printer, or from scanner to monitor screen. The .ICM file contains a monitor color system profile. This file is activated from within graphics programs that support this feature.



The ICM color profile is written in accordance with the International Color Consortium (ICC) Profile Format specification.

Installing the .INF and .ICM Files

After you determine that you need to update, you can install the .INF and .ICM files from the CD or download them.

Installing from the CD

To install the .INF and .ICM files on the computer from the CD:

1. Insert the CD in the computer CD-ROM drive. The CD menu displays.
2. View the “INF and ICM Readme” file.
3. Select “Install INF and ICM Files.”

4. Follow the on-screen instructions.
5. After the INF software has been installed, restart Windows.
6. Ensure that the proper resolution and refresh rates appear in the Windows Display control panel.



You may need to install the digitally signed monitor .INF and .ICM files manually from the CD in the event of an installation error. Refer to the INF and ICM Readme file on the CD.

Downloading from the Worldwide Web

To download the latest version of .INF and .ICM files from the HP monitors support Web site:

1. Refer to <http://www.hp.com/support> and select your country region.
2. Follow the links for your monitor to the support page and download page.
3. Ensure your system meets the requirements.
4. Download the software by following the instructions.

Plug and Play

Plug & Play DDC2B Feature

This monitor is equipped with VESA DDC2B capabilities according to the VESA DDC STANDARD. It allows the monitor to inform the host system of its identity and, depending on the level of DDC used, communicate additional information about its display capabilities.

The DDC2B is a bidirectional data channel based on the I²C protocol. The host can request EDID information over the DDC2B channel.

THIS MONITOR WILL APPEAR TO BE NON-FUNCTIONAL IF THERE IS NO VIDEO INPUT SIGNAL. IN ORDER FOR THIS MONITOR TO OPERATE PROPERLY, THERE MUST BE A VIDEO INPUT SIGNAL.

This monitor meets the Green monitor standards as set by the Video Electronics Standards Association (VESA) and/or the United States Environmental Protection Agency (EPA) and The Swedish Confederation Employees (NUTEK). This feature is designed to conserve electrical energy by reducing power consumption when there is no video-input signal present. When there is no video input signal this monitor, following a time-out period, will automatically switch to an OFF mode. This reduces the monitor's internal power supply consumption. After the video input signal is restored, full power is restored and the display is automatically redrawn. The appearance is similar to a "Screen Saver" feature except the display is completely off. The display is restored by pressing a key on the keyboard, or clicking the mouse.

Troubleshooting

Solving Common Problems

The following table lists possible problems and the recommended solutions.

Problem	Solution
Power LED is not on	Check if the power switch is in the ON position. Power cord should be connected.
No Plug & Play	Check if the PC system is Plug & Play compatible. Check if the Video Card is Plug & Play compatible. Check if the D-15 plug pin of Video Cable is bent.
Picture is fuzzy	Adjust the contrast and brightness controls.
Picture bounces or a wave pattern is present in the picture	Move electrical devices that may cause electrical interference.
The power LED is ON but there's no video or no picture	Computer Power Switch should be in the ON position. Computer Video Card should be snugly seated in its slot. Be sure monitor's video cable is properly connected to the computer. Inspect monitor's video cable and be sure none of the pins are bent. Be sure the computer is operational by pressing the Caps Lock key on the keyboard while observing the Caps Lock LED. The LED should either turn ON or OFF after pressing the Caps Lock key.

Problem	Solution
Missing one of the primary colors (RED, GREEN, or BLUE)	Inspect the monitor's video cable and be sure that none of the pins are bent.
Screen image is not centered or sized properly	Adjust pixel frequency (CLOCK) and FOCUS or press hot-key (AUTO).
Picture has color defects (white does not look white)	Adjust RGB color or select color temperature.
Horizontal or vertical disturbances on the screen	Use Microsoft Windows shut-down mode, adjust CLOCK and FOCUS in the OSD menu or perform hot-key (AUTO-key).

CLOCK (pixel frequency) controls the number of pixels scanned by one horizontal sweep. If the frequency is not correct, the screen shows vertical stripes and the picture has not correct width.

FOCUS adjusts the phase of the pixel clock signal. With a wrong phase adjustment the picture has horizontal disturbances in light picture.

For FOCUS and CLOCK adjustment use “dot-pattern” or Windows shut-down mode pattern.

Error Messages and Possible Solutions

Cable Not Connected - 1) Check that the signal-cable is properly connected. If the connector is loose, tighten the connector's screws. 2) Check the signal-cable's connection pins for damage.

Input Not Supported - Your computer has been set to an unsuitable display mode. Set the computer to display a mode listed in the “Factory Preset Display Modes” table in *Appendix B* of this guide.

Unsupported Mode. Try Different Video Card Setting - Your computer resolution is out of VESA specification.

Using the Worldwide Web

For online access to technical support information, self-solve tools, online assistance, community forums of IT experts, broad multivendor knowledge base, monitoring and diagnostic tools, go to: <http://www.hp.com/support>.

Preparing to call Technical Support

If you cannot solve a problem using the troubleshooting tips in this section, you may need to call technical support. Have the following information available when you call:

- The monitor
- Monitor model number
- Serial number for the monitor
- Purchase date on invoice
- Conditions under which the problem occurred
- Error messages received
- Hardware configuration
- Hardware and software you are using

Technical Specifications



All performance specifications are provided by the component manufacturers. Performance specifications represent the highest specification of all HP's component manufacturers' typical level specifications for performance and actual performance may vary either higher or lower.

L156v Model

15" Flat Panel Monitor

LCD Panel	TFT Color LCD	
Driving System	TFT Color LCD	
Size	15.0 in	38.1 cm
Pixel Pitch	0.01 in (H) x 0.01 in (V)	0.297 mm (H) x 0.297 mm (V)

Input	R, G, B Analog Interface	
Video	R, G, B Analog Interface	
Separate Sync	H/V TTL	
H-Frequency	30kHz - 60kHz	
V-Frequency	55-75Hz	

Display Colors	16.2M Colors
----------------	--------------

Dot Clock	80MHz
-----------	-------

Max Resolution	1024 x 768 @ 75Hz
Native Resolution	1024 X 768 @ 60Hz

15" Flat Panel Monitor (Continued)

Plug & Play	VESA DDC2B™
EPA ENERGY STAR	
On Mode	≤ 30W (for 2 CCFL)
Off Mode	≤ 2W
Audio Output	Rated power 1.0W rms (per channel)
Input Connector	D-sub 15 pin
Input Video Signal	Analog: 0.7Vp-p (standard, 75 OHM, Positive)
Maximum Screen Size	Horizontal: 11.97 in/304.1 mm Vertical: 8.98 in/ 228.1mm
Power Source	100~240VAC, 50~60Hz
Environmental Considerations	Operating Temp: 41 ^o to 95 ^o F/ 5 ^o to 35 ^o C Storage Temp: -4 ^o to 140 ^o F / -20 ^o to 60 ^o C Operating Humidity: 10% to 85%
Weight (N.W.)	6.61 lbs 3 kg Unit (net)

15" Flat Panel Monitor (Continued)

Dimensions 13.56 (w) x 13.64 (H) x 2.36 (D) in
344.6 (w) x 346.5 (H) x 160 (D) mm

External Controls

Switch

- Auto Adjust Key / Exit
- Volume
- Volume
- Power Button
- MENU / ENTER

Functions

- Contrast
 - Brightness
 - Focus
 - Clock
 - H.Position
 - V.Position
 - OSD location & Time
 - Language
 - Warm color temperature
 - Cool color temperature
 - RGB Color temperature
 - Information
 - Reset
 - Exit
-

L176v Model

17" Flat Panel Monitor

LCD Panel	TFT Color LCD	
Driving System	TFT Color LCD	
Size	17.0 in	43.2 cm
Pixel Pitch	0.01 in (H) x 0.01 in (V)	0.264 mm (H) x 0.264 mm (V)

Input		
Video	R, G, B Analog Interface	
Separate Sync	H/V TTL	
H-Frequency	30kHz - 60kHz	
V-Frequency	55-75Hz	

Display Colors	16.2M Colors
----------------	--------------

Dot Clock	135MHz
-----------	--------

Max Resolution	1280 x 768 @ 75Hz
Native Resolution	1280 x 768 @ 60Hz

Plug & Play	VESA DDC2B™
-------------	-------------

EPA ENERGY STAR		
On Mode	≤ 37W	
Off Mode	≤ 2W	

Audio Output	Rated power 1.0W rms (per channel)
--------------	------------------------------------

Input Connector	D-sub 15 pin
-----------------	--------------

Input Video Signal	Analog: 0.7Vp-p (standard, 75 OHM, Positive)
--------------------	--

Maximum Screen Size	Horizontal: 13.38 in/339.92 mm Vertical: 10.64 in/ 270.34mm
---------------------	--

Power Source	100~240VAC, 47~63Hz
--------------	---------------------

17" Flat Panel Monitor (Continued)

Environmental Considerations Operating Temp: 41^o to 95^o F / 5^o to 35^o C
Storage Temp: -4^o to 140^o F / -20^o to 60^o C
Operating Humidity: 10% to 85%

Weight (N.W.) 9.92 lbs
4.5 kg Unit (net)

Dimensions 14.77 (w) x 15.0 (H) x 2.36 (D) in
375.4 (w) x 381.6 (H) x 160 (D) mm

External Controls

Switch

- Auto Adjust Key / Exit
- Volume
- Volume
- Power Button
- MENU / ENTER

Functions

- Contrast
 - Brightness
 - Focus
 - Clock
 - H.Position
 - V.Position
 - OSD location & Time
 - Language
 - Warm color temperature
 - Cool color temperature
 - RGB Color temperature
 - Information
 - Reset
 - Exit
-

Recognizing Preset Display Resolutions

The display resolutions listed below are the most commonly used modes and are set as factory defaults. This monitor automatically recognizes these preset modes and they will appear properly sized and centered on the screen.

L156v Model

Factory Preset Display Modes			
Standard	Resolution	Horz Freq (kHz)	Vert Freq (Hz)
VGA	720 x 400	31.47	70.0
	640 x 480	31.47	60.0
	640 x 480	35.00	66.6
	640 x 480	37.50	75.0
	640 x 480	37.9	60.3
SVGA	800 x 600	35.156	56.3
	800 x 600	37.879	60.0
	800 x 600	48.077	72.2
	800 x 600	46.875	75.0
	832 x 624	49.725	75.0
XGA	1024 x 768	48.363	60.0
	1024 x 768	56.476	70.0

Factory Preset Display Modes (Continued)

Standard	Resolution	Horz Freq (kHz)	Vert Freq (Hz)
	1024 x 768	60.24	74.0
	1024 x 768	60.02	75.0

L176v Model

Factory Preset Display Modes

Standard	Resolution	Horz Freq (kHz)	Vert Freq (Hz)
DOS-mode	640 x 350	31.47	70
DOS-mode	720 x 400	31.47	70
VGA	640 x 480	31.47	60.0
	640 x 480	35.00	66.6
	640 x 480	37.50	75.0
	640 x 480	37.86	72
SVGA	800 x 600	37.879	60.0
	800 x 600	48.875	75
	800 x 600	35.16	56
	800 x 600	48.01	72
	832 x 624	49.725	75.0
XGA	1024 x 768	48.363	60.0
	1024 x 768	56.476	70.0

Factory Preset Display Modes (Continued)

Standard	Resolution	Horz Freq (kHz)	Vert Freq (Hz)
	1024 x 768	60.02	75
SXGA	1280 x 1024	64.02	60
	1280 x 1024	80.00	75

Entering User Modes

The video controller signal may occasionally call for a mode that is not preset if:

- You are not using a standard graphics adapter.
- You are not using a preset mode.

If this occurs, you may need to readjust the parameters of the monitor screen by using the on-screen display. Your changes can be made to any or all of these modes and saved in memory. The monitor automatically stores the new setting, then recognizes the new mode just as it does a preset mode. In addition to the 15 factory preset modes, there are four user modes that can be entered and stored.

Agency Regulatory Notices

Federal Communications Commission Notice

This equipment has been tested and found to comply with the limits for a Class B digital device, pursuant to Part 15 of the FCC Rules. These limits are designed to provide reasonable protection against harmful interference in a residential installation. This equipment generates, uses, and can radiate radio frequency energy and, if not installed and used in accordance with the instructions, may cause harmful interference to radio communications. However, there is no guarantee that interference will not occur in a particular installation. If this equipment does cause harmful interference to radio or television reception, which can be determined by turning the equipment off and on, the user is encouraged to try to correct the interference by one or more of the following measures:

- Reorient or relocate the receiving antenna.
- Increase the separation between the equipment and the receiver.
- Connect the equipment into an outlet on a circuit different from that to which the receiver is connected.
- Consult the dealer or an experienced radio or television technician for help.

Modifications

The FCC requires the user to be notified that any changes or modifications made to this device that are not expressly approved by Hewlett Packard Company may void the user's authority to operate the equipment.

Cables

Connections to this device must be made with shielded cables with metallic RFI/EMI connector hoods to maintain compliance with FCC Rules and Regulations.

Declaration of Conformity for Products Marked with the FCC Logo (United States Only)

This device complies with Part 15 of the FCC Rules. Operation is subject to the following two conditions: (1) this device may not cause harmful interference, and (2) this device must accept any interference received, including interference that may cause undesired operation.

For questions regarding your product, contact:

Hewlett Packard Company
P. O. Box 692000, Mail Stop 530113
Houston, Texas 77269-2000

Or, call 1-800-HP-INVENT (1-800 474-6836)

For questions regarding this FCC declaration, contact:

Hewlett Packard Company
P. O. Box 692000, Mail Stop 510101
Houston, Texas 77269-2000

Or, call (281) 514-3333

To identify this product, refer to the Part, Series, or Model number found on the product.

Materials disposal

This HP product contains Mercury in the fluorescent lamp in the display LCD that might require special handling at end-of-life.

Disposal of this material can be regulated because of environmental considerations. For disposal or recycling information, please contact your local authorities or the Electronic Industries Alliance (EIA) (www.eiae.org).

ENERGY STAR Compliance



Monitors that are marked with the ENERGY STAR Logo meet the requirements of the U.S. Environmental Protection Agency (EPA) ENERGY STAR program. As an ENERGY STAR Partner, Hewlett Packard Company has determined that this product meets the ENERGY STAR guidelines for energy efficiency.

Specific details on using the Energy Saving features can be found in the energy saver or power management section of the computer manual.

Power Cord Set Requirements

The monitor power supply is provided with Automatic Line Switching (ALS). This feature allows the monitor to operate on input voltages between 100-120V or 200-240V.

The power cord set (flexible cord or wall plug) received with the monitor meets the requirements for use in the country where you purchased the equipment.

If you need to obtain a power cord for a different country, you should purchase a power cord that is approved for use in that country.

The power cord must be rated for the product and for the voltage and current marked on the product's electrical ratings label. The voltage and current rating of the cord should be greater than the voltage and current rating marked on the product. In addition, the cross-sectional area of the wire must be a minimum of 0.75 mm² or 18AWG, and the length of the cord must be between 5 feet (1.5 m) and 12 feet (3.6 m). If you have questions about the type of power cord to use, contact your HP authorized service provider.

A power cord should be routed so that it is not likely to be walked on or pinched by items placed upon it or against it. Particular attention should be paid to the plug, electrical outlet, and the point where the cord exits from the product.



FABRICADO POR C.N.P.J. 04.176.689/0001-60