



LASERJET ENTERPRISE 500 MFP

Quick Reference Guide



M525

Print a stored job

Use the following procedure to print a job that is stored in the product memory.

1. From the Home screen on the product control panel, scroll to and touch the [Retrieve from Device Memory](#) button.
2. Select the name of the folder where the job is stored.
3. Select the name of the job. If the job is private or encrypted, enter the PIN or password.
4. Adjust the number of copies, and then touch the Start  button to print the job.

Use easy-access USB printing

This product features easy-access USB printing, so you can quickly print files without sending them from a computer. The product accepts standard USB flash drives in the USB port on the front of the product. You can print the following types of files:

- .pdf
- .prn
- .pcl
- .ps
- .cht

Before you can use this feature, you must enable the USB port. Use the following procedure to enable the port from the product control-panel menus:

1. From the Home screen on the product control panel, scroll to and touch the [Administration](#) button.
2. Open the following menus:
 - [General Settings](#)
 - [Enable Retrieve from USB](#)
3. Select the [Enable](#) option, and then touch the [Save](#) button.

Print easy-access USB documents

1. Insert the USB flash drive into the USB port on the left side of the product control panel.

NOTE: You might need to remove the cover from the USB port.

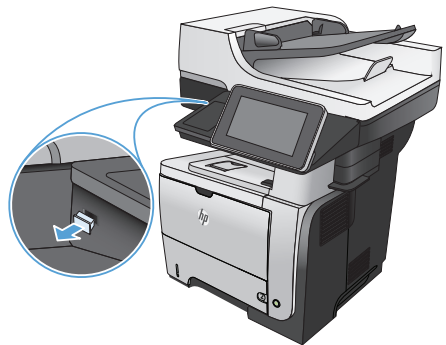

2. The [Retrieve from USB](#) screen opens. Select a folder from the list on the left side of the screen.

3. Select the name of the document that you want to print.
4. To adjust the number of copies, touch the **Copies** field, and then use the keypad to select the number of copies.
5. Touch the Start  button to print the document.

Collate a copy job

1. From the Home screen on the product control panel, touch the **Copy** button.



2. Touch the **Collate** button.

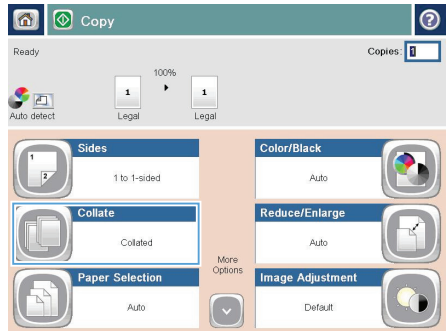

3. Touch the **Collate on (Sets in page order)** option. Touch the **OK** button.

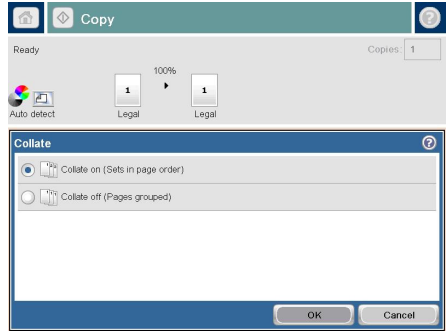

4. Touch the **Start** button.

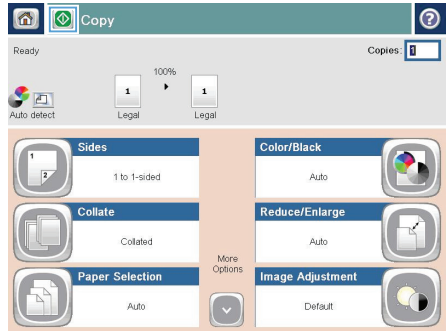

Copy on both sides (duplex)

Copy on both sides automatically

1. Load the original documents into the document feeder with the first page facing up, and with the top of the page leading.

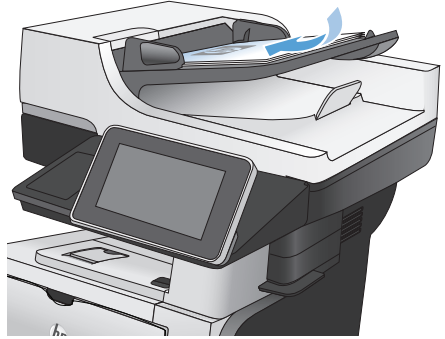

2. Adjust the paper guides to fit the size of the document.

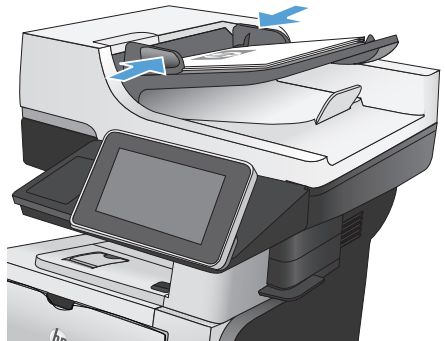

3. From the Home screen on the product control panel, touch the [Copy](#) button.
4. Touch the [Sides](#) button.

5. To make a two-sided copy from a one-sided original, touch the **1-sided original, 2-sided output** button.

To make a two-sided copy from a two-sided original, touch the **2-sided original, 2-sided output** button.

To make a one-sided copy from a two-sided original, touch the **2-sided original, 1-sided output** button.

Touch the **OK** button.

6. Touch the **Start** button.

Copy on both sides manually

1. Lift the scanner lid.

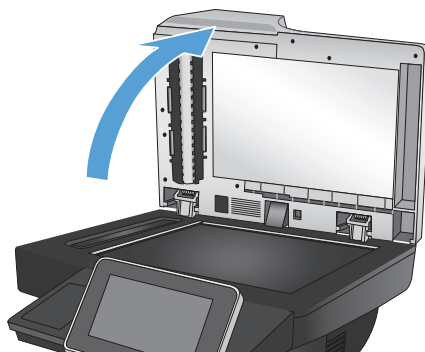

2. Place the document face-down on the scanner glass with the upper-left corner of the page in the upper-left corner of the glass.

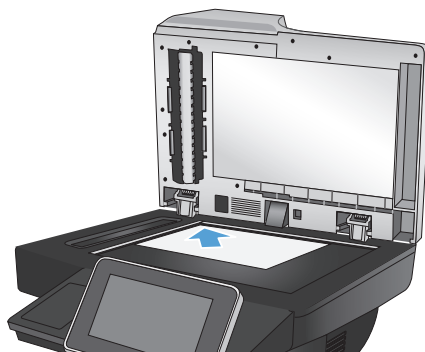

3. Gently close the scanner lid.

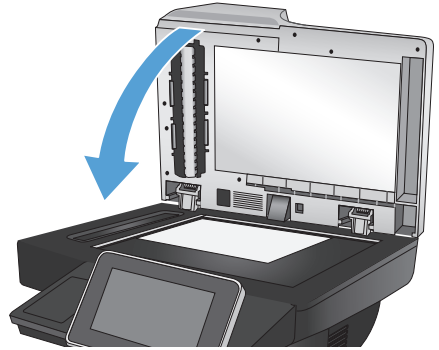

4. From the Home screen on the product control panel, touch the **Copy** button.
5. Touch the **Sides** button.
6. To make a two-sided copy from a one-sided original, touch the **1-sided original, 2-sided output** button.

To make a two-sided copy from a two-sided original, touch the **2-sided original, 2-sided output** button.

To make a one-sided copy from a two-sided original, touch the **2-sided original, 1-sided output** button.

Touch the **OK** button.
7. Touch the **Start**  button.
8. The product prompts you to load the next original document. Place it on the glass, and then touch the **Scan** button.
9. The product temporarily saves the scanned images. Touch the **Finish** button to finish printing the copies.

Reduce or enlarge a copy image

1. From the Home screen on the product control panel, touch the **Copy** button.



2. Touch the **Reduce/Enlarge** button.

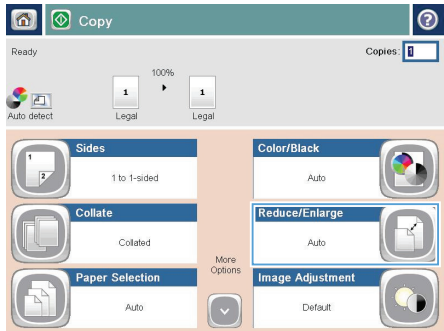

3. Select one of the predefined percentages, or touch the **Scaling** field and type a percentage between 25 and 200 when using the document feeder or between 25 and 400 when copying from the scanner glass. Touch the **OK** button. You can also select these options:

- **Auto**: The product automatically scales the image to fit the paper size in the tray.
- **Auto Include Margins**: The product reduces the image slightly to fit the entire scanned image within the printable area on the page.

NOTE: To reduce the image, select a scaling percentage that is less than 100. To enlarge the image, select a scaling percentage that is greater than 100.

4. Touch the **Start** button.

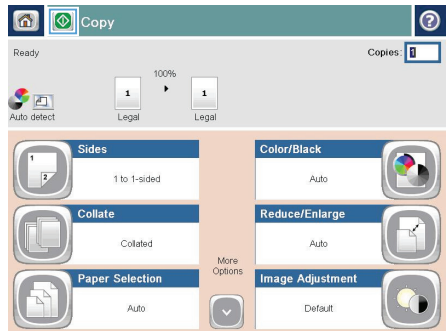
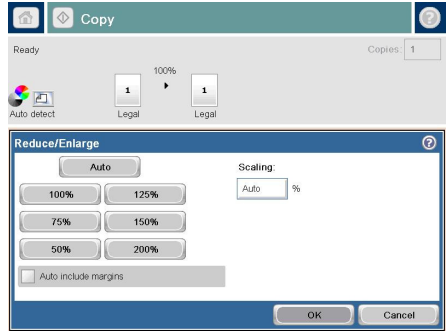

Optimize copy quality for text or pictures

Optimize the copy job for the type of image being copied: text, graphics, or photos.

1. From the Home screen on the product control panel, touch the **Copy** button.
2. Touch the **More Options** button, and then touch the **Optimize Text/Picture** button.
3. Select one of the predefined options, or touch the **Manually adjust** button and then adjust the slider in the **Optimize For** area. Touch the **OK** button.
4. Touch the Start  button.



NOTE: These settings are temporary. After you have finished the job, the product returns to the default settings.

Set the paper size and type for copying on special paper

1. From the Home screen on the product control panel, touch the **Copy** button.

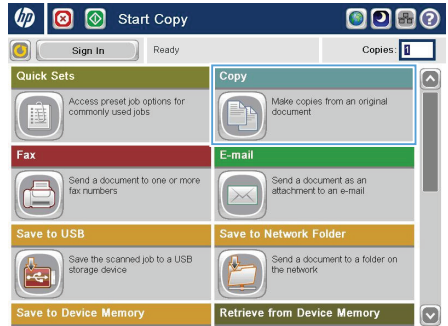

2. Touch the **Paper Selection** button.

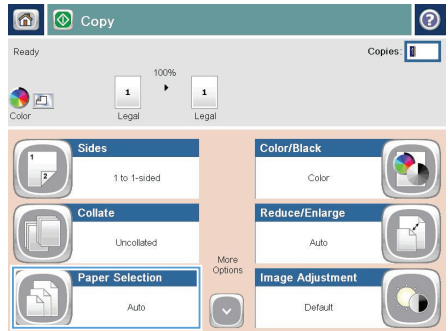

3. Select the tray that holds the paper that you want to use, and then touch the **OK** button.

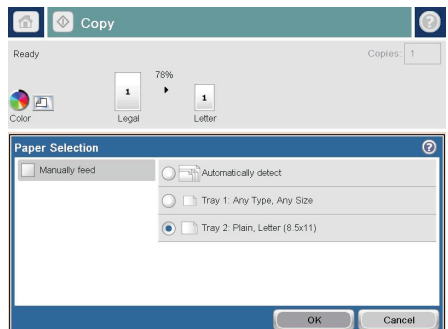

Send a scanned document to a network folder

The product can scan a file and save it in a folder on the network. The following operating systems support this feature:

- Windows Server 2003, 64-bit
- Windows Server 2008, 64-bit
- Windows XP, 64-bit
- Windows Vista, 64-bit
- Windows 7, 64-bit
- Novell v5.1 and later (access to the [Quick Sets](#) folders only)



NOTE: You might be required to sign in to the product to use this feature.

The system administrator can use the HP Embedded Web Server to configure pre-defined [Quick Sets](#) folders, or you can provide the path to another network folder.

1. Place the document face-down on the scanner glass, or place it face-up in the document feeder and adjust the paper guides to fit the size of the document.

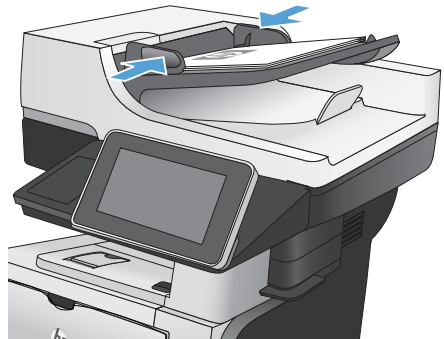

- From the Home screen on the product control panel, touch the **Save to Network Folder** button.

NOTE: If prompted, type your user name and password.

- To use one of the preset job settings, select one of the items in the **Quick Sets** list.

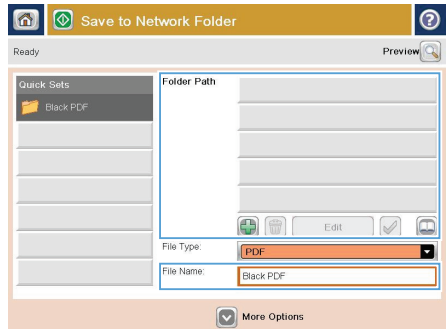
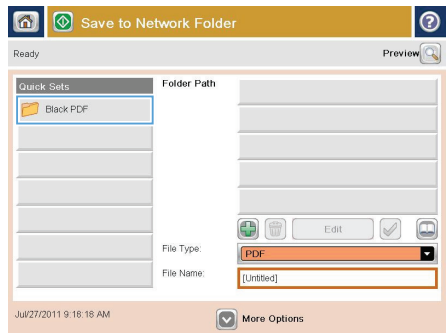
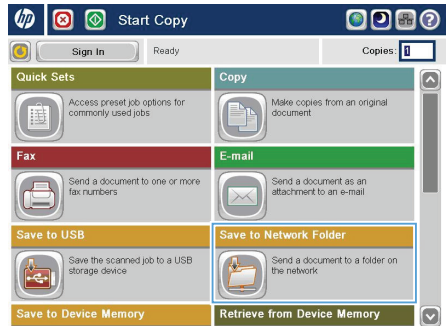

- To set up a new job, type the name for the file in the **File Name**: text field, and type the path to the network folder in the **Folder Path** field. Use this format for the path:

\\path\path

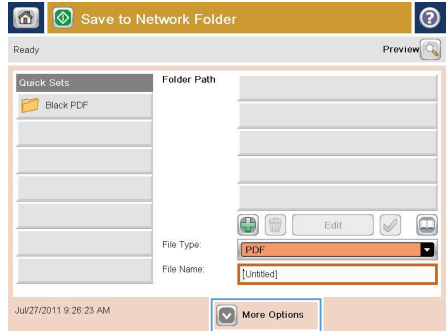

5. To configure settings for the document, touch the **More Options** button.



6. Touch the Start  button to save the file.
NOTE: You can preview the image at any time by touching the **Preview** button in the upper-right corner of the screen. For more information about this feature, touch the **Help**  button on the preview screen.

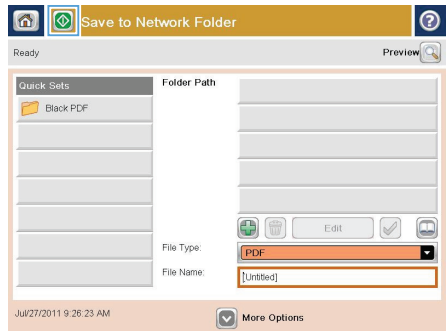

Send a scanned document to a folder in the product memory

Use this procedure to scan a document and save it on the product so you can print copies at any time.

1. Place the document face-down on the scanner glass, or place it face-up in the document feeder and adjust the paper guides to fit the size of the document.

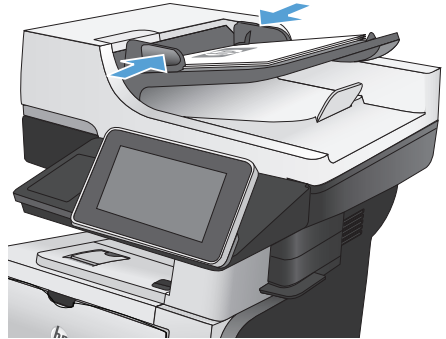

2. From the Home screen on the product control panel, scroll to and touch the **Save to Device Memory** button.
NOTE: If prompted, enter your user name and password.
3. Select an existing folder, or touch the **New Folder** button to create a new folder.
4. Enter the name for the file in the **File Name:** field.
5. To configure settings for the document, touch the **More Options** button.
6. Touch the **Start**  button to save the file.

Send a scanned document to a USB flash drive

The product can scan a file and save it in a folder on a USB flash drive.



NOTE: You might be required to sign in to the product to use this feature.

1. Place the document face-down on the scanner glass, or place it face-up in the document feeder and adjust the paper guides to fit the size of the document.

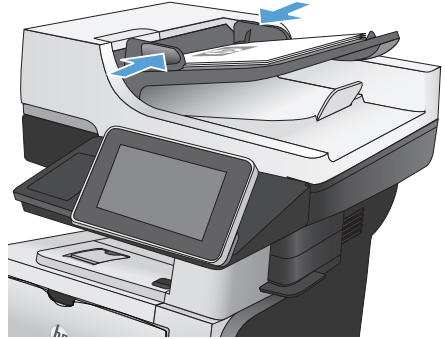

2. Insert the USB flash drive into the USB port on the left side of the product control panel.

NOTE: You might need to remove the cover from the USB port.

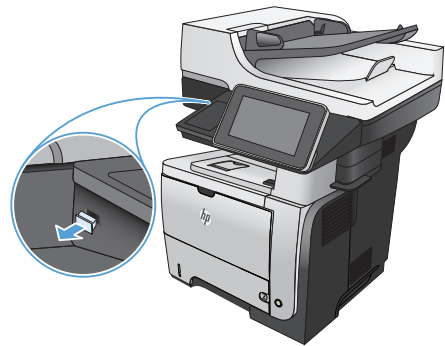

- From the Home screen on the product control panel, scroll to and touch the **Save to USB** button.

NOTE: If prompted, enter your user name and password.

- Select one of the folders in the list, or touch the **New Folder** button to create a new folder on the USB flash drive.

- Enter the name for the file in the **File Name:** field. Touch the **OK** button. Select the file type from the **File Type** drop-down list. Touch the **OK** button.

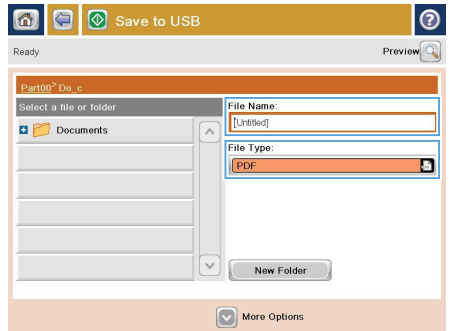
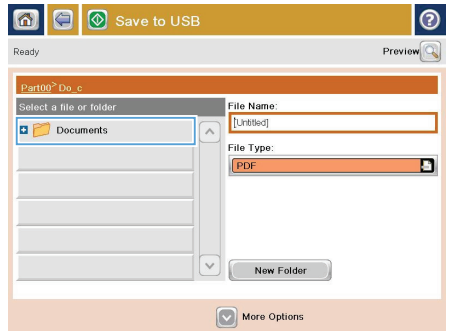
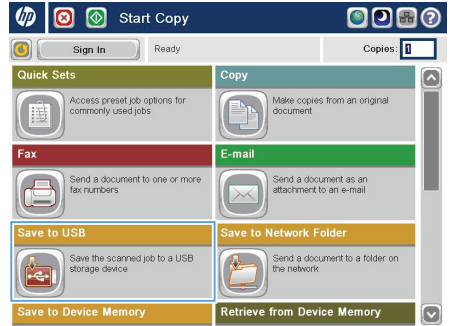

- To configure settings for the document, touch the **More Options** button.

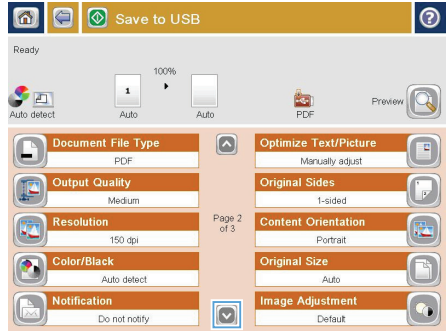

- Touch the Start button to save the file.

NOTE: You can preview the image at any time by touching the **Preview** button in the upper-right corner of the screen. For more information about this feature, touch the **Help** button on the preview screen.

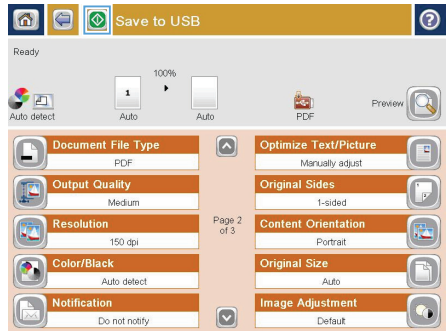

Send a scanned document to one or more email addresses

1. Place the document face-down on the scanner glass, or place it face-up in the document feeder and adjust the paper guides to fit the size of the document.

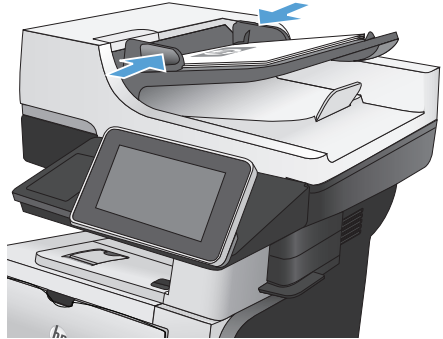

2. From the Home screen on the product control panel, touch the **E-mail** button.

NOTE: If prompted, type your user name and password.



3. Touch the **To** field to open a keypad.

NOTE: If you are signed in to the product, your user name or other default information might appear in the **From:** field. If so, you might not be able to change it.

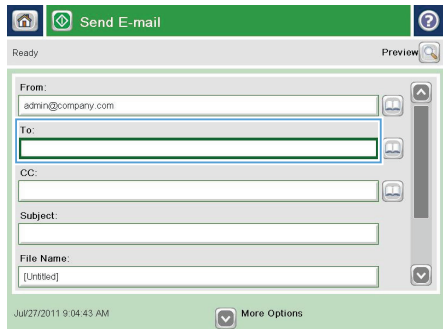

- To send to multiple addresses, separate the addresses with a semicolon, or touch the **Enter** button on the touchscreen keypad after you type each address.

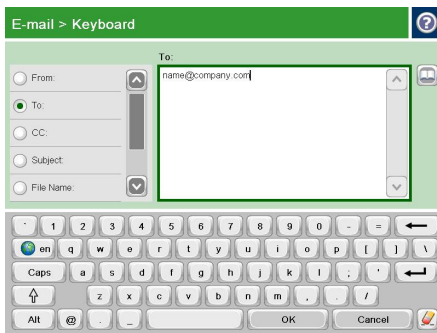

- Complete the **CC:**, **Subject:**, and **File Name:** fields by touching the field and using the touchscreen keypad to enter information.
- To change the settings for the document touch the **More Options** button.

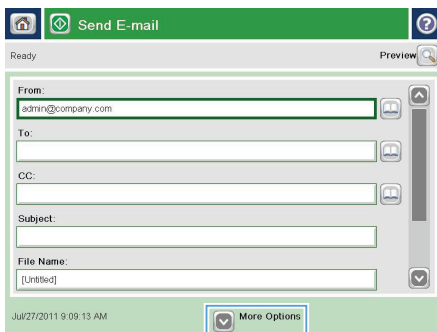

- If you are sending a two-sided document, select the **Original Sides** menu and select the **2-sided** option. Touch the **OK** button.

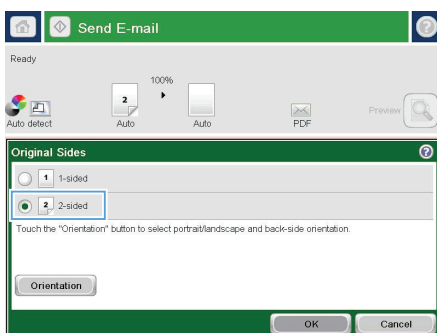

8. Touch the Start  button to begin sending.

NOTE: You can preview the image at any time by touching the **Preview** button in the upper-right corner of the screen. For more information about this feature, touch the **Help**  button on the preview screen.

9. To set up another email job, touch the **OK** button on the Status screen.

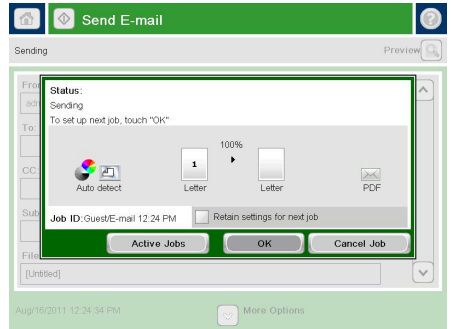
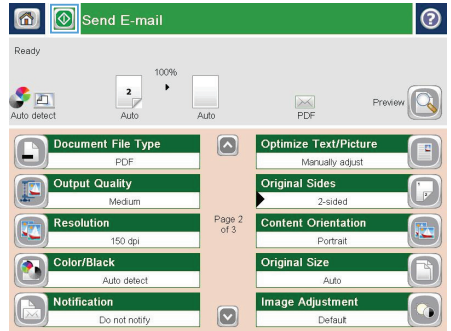

Send a fax by entering numbers manually

1. Place the document face-down on the scanner glass, or place it face-up in the document feeder and adjust the paper guides to fit the size of the document.

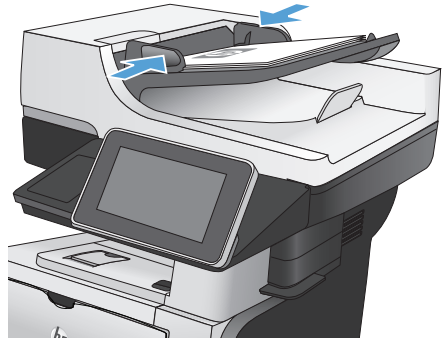

2. From the Home screen on the product control panel, touch the **Fax** button. You might be prompted to type a user name and password.

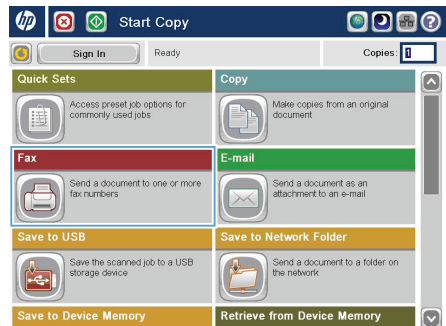

3. Touch the **More Options** button. Verify that the settings match those of your original. When all settings are completed, touch the up arrow to scroll to the main **Fax** screen.

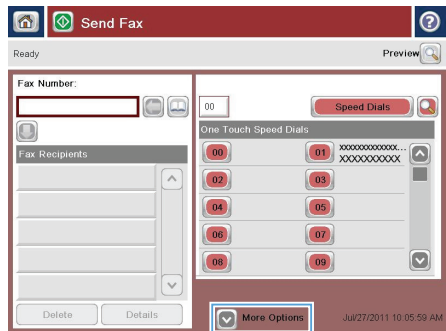

4. Touch the **Fax Number** field to open the keypad.

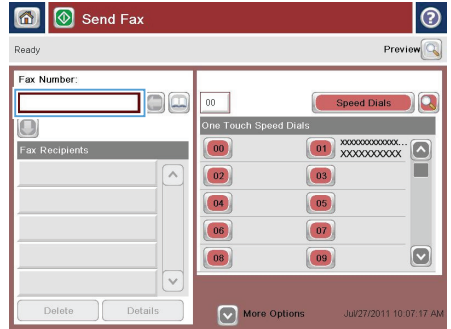

5. Enter a phone number and then touch the **OK** button.

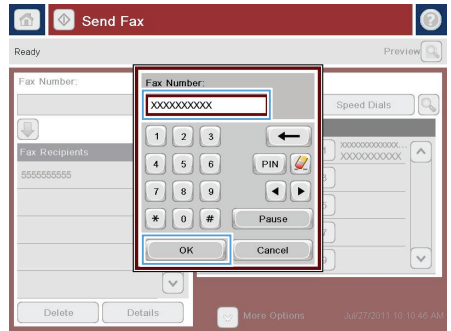

6. Touch the **Start** button to send the fax.

NOTE: You can preview the image at any time by touching the **Preview** button in the upper-right corner of the screen. For more information about this feature, touch the **Help** button on the preview screen.

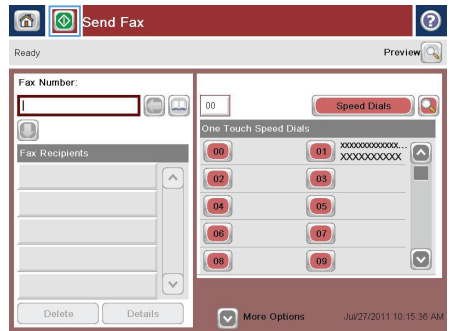

© 2012 Hewlett-Packard Development Company, L.P.

www.hp.com

Edition 1, 05/2012

Part number: CF116-91030

Windows® is a U.S. registered trademark of Microsoft Corporation.

Reproduction, adaptation or translation without prior written permission is prohibited, except as allowed under the copyright laws.

The information contained herein is subject to change without notice.

The only warranties for HP products and services are set forth in the express warranty statements accompanying such products and services. Nothing herein should be construed as constituting an additional warranty. HP shall not be liable for technical or editorial errors or omissions contained herein.



CF116-91030

