



HP 255 G6 Notebook PC

Maintenance and Service Guide

© Copyright 2017, 2019 HP Development Company, L.P.

AMD is a trademark of Advanced Micro Devices, Inc. Bluetooth is a trademark owned by its proprietor and used by HP Inc. under license. Intel, Celeron, and Pentium are trademarks of Intel Corporation in the U.S. and other countries. Microsoft and Windows are U.S. registered trademarks of the Microsoft group of companies.

In accordance with Microsoft's support policy, HP does not support the Windows 8 or Windows 7 operating system on products configured with Intel and AMD 7th generation and forward processors or provide any Windows 8 or Windows 7 drivers on <http://www.support.hp.com>.

The information contained herein is subject to change without notice. The only warranties for HP products and services are set forth in the express warranty statements accompanying such products and services. Nothing herein should be construed as constituting an additional warranty. HP shall not be liable for technical or editorial errors or omissions contained herein.

Second Edition: February 2019

First Edition: April 2017

Document Part Number: 926814-002

Product notice

This guide describes features that are common to most models. Some features may not be available on your computer.

Not all features are available in all editions or versions of Windows. Systems may require upgraded and/or separately purchased hardware, drivers, software or BIOS update to take full advantage of Windows functionality. Windows 10 is automatically updated, which is always enabled. ISP fees may apply and additional requirements may apply over time for updates. Go to <http://www.microsoft.com> for details.

To access the latest user guides or manuals for your product, go to <http://www.hp.com/support>, and select your country. Select **Find your product**, and then follow the on-screen instructions.

Software terms

By installing, copying, downloading, or otherwise using any software product preinstalled on this computer, you agree to be bound by the terms of the HP End User License Agreement (EULA). If you do not accept these license terms, your sole remedy is to return the entire unused product (hardware and software) within 14 days for a full refund subject to the refund policy of your seller.

For any further information or to request a full refund of the price of the computer, please contact your seller.

Safety warning notice

 **WARNING!** To reduce the possibility of heat-related injuries or of overheating the device, do not place the device directly on your lap or obstruct the device air vents. Use the device only on a hard, flat surface. Do not allow another hard surface, such as an adjoining optional printer, or a soft surface, such as pillows or rugs or clothing, to block airflow. Also, do not allow the AC adapter to contact the skin or a soft surface, such as pillows or rugs or clothing, during operation. The device and the AC adapter comply with the user-accessible surface temperature limits defined by the International Standard for Safety of Information Technology Equipment (IEC 60950-1).

Table of contents

1 Product description	1
2 Components	5
Right	5
Left	6
Display	8
Keyboard area	9
TouchPad	9
Lights	10
Button	11
Special keys	12
Action keys	13
Bottom	14
Labels	15
3 Illustrated parts catalog	17
Computer major components	17
Display assembly subcomponents	20
Cables	21
Mass storage devices	22
Miscellaneous parts	23
4 Removal and replacement procedures preliminary requirements	25
Tools required	25
Service considerations	25
Plastic parts	25
Cables and connectors	25
Drive handling	26
Grounding guidelines	26
Electrostatic discharge damage	26
Packaging and transporting guidelines	27
Workstation guidelines	27
5 Removal and replacement procedures for Customer Self-Repair parts	29
Component replacement procedures	29
Battery	30

Optical drive	31
6 Removal and replacement procedures for Authorized Service Provider parts	33
Component replacement procedures	33
Display subcomponents (bezel, panel, camera)	33
Rubber feet	37
Bottom cover	38
WLAN module	41
Memory module	43
Optical drive connector board	44
Hard drive and hard drive connector board	45
M.2 solid-state drive adapter bracket and connector board	48
Solid-state drive (SSD)	50
RTC battery	51
Speakers	52
USB board	53
Fan	54
Heat sink assembly	56
TouchPad button board	60
System board	61
Display assembly	63
Power connector cable	73
Power button board	74
Cable locations	75
Top cover/keyboard	76
7 Using Setup Utility (BIOS)	77
Starting Setup Utility (BIOS)	77
Updating Setup Utility (BIOS)	77
Determining the BIOS version	77
Downloading a BIOS update	78
8 Backing up, restoring, and recovering	79
Creating recovery media and backups	79
Creating HP Recovery media (select products only)	79
Using Windows tools	80
Restore and recovery	81
Recovering using HP Recovery Manager	81
What you need to know before you get started	81
Using the HP Recovery partition (select products only)	82

Using HP Recovery media to recover	82
Changing the computer boot order	83
Removing the HP Recovery partition (select products only)	84
9 Using HP PC Hardware Diagnostics (UEFI)	85
Downloading HP PC Hardware Diagnostics (UEFI) to a USB device	85
10 Specifications	87
Computer specifications	87
39.6-cm (15.6-in) display specifications	88
Hard drive specifications	89
M.2 solid-state drive specifications	90
DVD±RW SuperMulti DL Drive specifications	91
11 Statement of memory volatility	93
Nonvolatile memory usage	95
Questions and answers	97
Using HP Sure Start (select models only)	98
12 Power cord set requirements	99
Requirements for all countries	99
Requirements for specific countries and regions	100
13 Recycling	103
Index	105

1 Product description

Category	Description
Product name	HP 255 G6 Notebook PC
Processor	AMD Dual-Core processor A6-9220 (2.5-GHz, turbo up to 2.9 GHz, 2133-MHz/1-MB L2 cache) E2-9000e (1.5-GHz, turbo up to 2.0 GHz, 1866-MHz/1-MB L2 cache)
Graphics	Internal graphics AMD Radeon™ R4 Graphics AMD Radeon R2 Graphics Support HD Decode, DX12, and HDMI
Panel	39.6-cm (15.6-in), high-definition (HD), white light-emitting diode (WLED), SVA, anti glare (1366×768) display, slim 3.2 mm, eDP; typical brightness: 220 nits 39.6-cm (15.6-in), full high-definition (FHD), white light-emitting diode (WLED), SVA, anti glare (1920×1080) display, slim 3.2 mm, eDP; typical brightness: 220 nits
Memory	One/two non-customer-accessible/upgradable memory module slots DDR4-1866 dual channel support (DDR4-2400 bridge to DDR4-1866) Supports up to 8 GB of system RAM in the following configurations: <ul style="list-style-type: none">• 8192-MB total system memory (8192×1)• 6144-MB total system memory (4096×1) + (2048×1)• 4096-MB total system memory (4096×1)
Hard drives	Supports 6.35-cm (2.5-in) SATA hard drives in 9.5-mm (.37-in) and 7.2-mm (.28-in) thicknesses Support for m.2 SATA SSD Single hard drive configurations: <ul style="list-style-type: none">• 1-TB, 5400 rpm, 9.5 mm or 7.2 mm• 500-GB, 5400 rpm, 7.0-mm eMMC configurations: <ul style="list-style-type: none">• 128 GB M.2 SATA-3 configurations (Value): <ul style="list-style-type: none">• 256 GB• 128 GB M.2 SATA-3 configurations (TLC): <ul style="list-style-type: none">• 256 GB• 128 GB
Optical drive	Fixed, serial ATA, 9.0-mm tray load DVD+/-RW Double-Layer writer





Category	Description
	<p>Supports zero power optical drive</p> <p>Supports M-disc</p> <p>Supports configuration without optical drive</p>
Camera	HP TrueVision HD camera - activity LED, USB 2.0, HD BSI sensor, f2.0, 720p by 30 frames per second
Mic	<p>HP Camera – VGA camera, indicator LED, USB 2.0, f2.4, 480p by 30 frames per second</p> <p>Single digital microphone</p>
Audio	<p>Dual speakers</p> <p>HP Audio Control</p>
Ethernet	Integrated 10/100/1000 network interface card (NIC)
Wireless Network	<p>Integrated wireless options with dual antennas (M.2/PCIe):</p> <p>Compatible with Miracast-certified devices</p> <p>Support for the following WLAN format:</p> <ul style="list-style-type: none"> Intel Dual Band Wireless-AC 3168 802.11 ac 1x1 WiFi + BT 4.2 Combo (non-vPro)
External media card	<p>HP Multi-Format Digital Media Reader</p> <p>Support SD/SDHC/SDXC</p> <p>Push-pull insertion/removal</p>
Internal Card	<p>One M.2 slot for SSD</p> <p>One M.2 slot for WLAN</p>
Ports	<p>VGA (Dsub 15 pin) supporting 1920 × 1200 @ 60Hz</p> <p>Hot Plug/unplug and auto detect for correct output to wide-aspect vs. standard aspect video</p> <p>HDMI version 1.4b supporting 1920 × 1080 @ 60Hz</p> <p>RJ-45 (Ethernet)</p> <p>USB 3.0 (2 ports; left side)</p> <p>USB 2.0 (1 right side)</p> <p>AC Smart Pin adapter plug</p> <p>Headphone/line out and microphone/line in combo jack</p>
Keyboard/pointing devices	<p>Full-size textured, island style keyboard with numeric keypad</p> <p>TouchPad with multi-touch gestures enabled</p> <p>TouchPad taps enabled by default</p> <p>TouchPad supports Modern Trackpad Gestures</p>
Power	<p>AC adapters</p> <p>65-W</p> <p>45-W</p> <p>1 meter power cord</p> <p>Batteries</p> <p>4-cell, 41-Whr Li-ion battery</p>

Category	Description
	3-cell, 31-Whr Li-ion battery
Security	fTPM 2.0 Kensington Security Lock
Operating system	<p>Preinstalled</p> <p>Windows 10</p> <p>Windows 10 Professional</p> <p>For Developed Market (ML):</p> <p>Windows 10 Home ML</p> <p>Windows 10 Home Plus ML</p> <p>Windows 10 Pro StF MSNA Standard</p> <p>For Emerging Market (EM/SL):</p> <p>Windows 10 Home EM/SL</p> <p>Windows 10 Home Plus EM/SL</p> <p>Windows 10 Pro StF MSNA Value (EM)</p> <p>For China Market:</p> <p>FreeDOS 2.0</p>
Service	<p>End-user replaceable parts</p> <p>AC adapter</p> <p>Battery</p> <p>Optical drive</p>

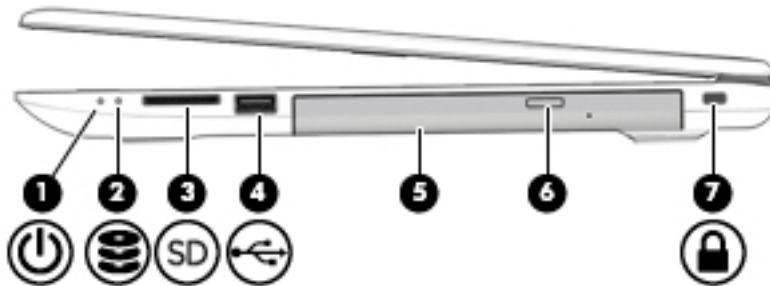
2 Components







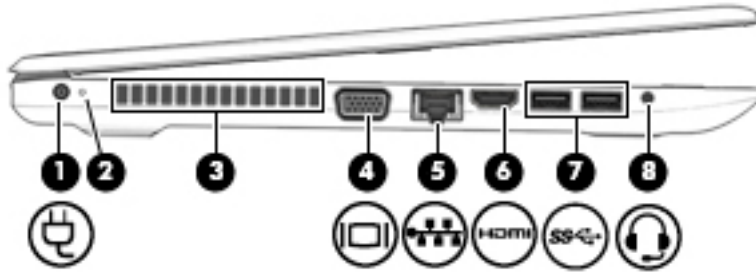

Right



Component	Description
(1)  Power light	<ul style="list-style-type: none">• On: The computer is on.• Blinking: The computer is in the Sleep state, a power-saving state. The computer shuts off power to the display and other unneeded components.• Off: The computer is off or in Hibernation. Hibernation is a power-saving state that uses the least amount of power.
(2)  Drive light	<ul style="list-style-type: none">• Blinking white: The hard drive is being accessed.
(3)  Memory card reader	Reads optional memory cards that store, manage, share, or access information. To insert a card: <ol style="list-style-type: none">1. Hold the card label-side up, with the connectors facing the computer.2. Insert the card into the memory card reader, and then press in on the card until it is firmly seated. To remove a card: <ul style="list-style-type: none">▲ Pull the card out of the memory card reader.
(4)  USB 2.0 port	Connects a USB device, such as a cell phone, camera, activity tracker, or smartwatch, and provides data transfer.
(5) Optical drive (select products only)	Depending on your computer model, reads an optical disc or reads and writes to an optical disc.
(6) Optical drive eject button (select products only)	Releases the optical drive disc tray.
(7)  Security cable slot	Attaches an optional security cable to the computer. NOTE: The security cable is designed to act as a deterrent, but it may not prevent the computer from being mishandled or stolen.

Left



Component	Description
(1) 	Power connector Connects an AC adapter.
(2) 	Battery light When AC power is connected: <ul style="list-style-type: none"> White: The battery charge is greater than 90 percent. Amber: The battery charge is from 0 to 90 percent. Off: The battery is not charging. When AC power is disconnected (battery not charging): <ul style="list-style-type: none"> Blinking amber: The battery has reached a low battery level. When the battery has reached a critical battery level, the battery light begins blinking rapidly. Off: The battery is not charging.
(3) 	Vent Enables airflow to cool internal components. NOTE: The computer fan starts up automatically to cool internal components and prevent overheating. It is normal for the internal fan to cycle on and off during routine operation.
(4) 	External monitor port Connects an external VGA monitor or projector.
(5) 	RJ-45 (network) jack/status lights Connects a network cable. <ul style="list-style-type: none"> White (left): The network is connected. Amber (right): Activity is occurring on the network.
(6) 	HDMI port Connects an optional video or audio device, such as a high-definition television, any compatible digital or audio component, or a high-speed High Definition Multimedia Interface (HDMI) device.
(7) 	USB 3.x SuperSpeed ports (2) Connect a USB device, such as a cell phone, camera, activity tracker, or smartwatch, and provides high-speed data transfer.
(8) 	Audio-out (headphone)/Audio-in (microphone) combo jack Connects optional powered stereo speakers, headphones, earbuds, a headset, or a television audio cable. Also connects an optional headset microphone. This jack does not support optional standalone microphones.

Component	Description
	<p data-bbox="900 226 1445 327">WARNING! To reduce the risk of personal injury, adjust the volume before putting on headphones, earbuds, or a headset. For additional safety information, refer to the <i>Regulatory, Safety, and Environmental Notices</i>.</p> <p data-bbox="900 348 1078 371">To access this guide:</p> <ol data-bbox="900 392 1458 596" style="list-style-type: none"><li data-bbox="900 392 1458 443">1. Type <code>support</code> in the taskbar search box, and then select the HP Support Assistant app.<li data-bbox="948 464 999 487">– or –<li data-bbox="948 508 1326 531">Click the question mark icon in the taskbar.<li data-bbox="900 552 1414 596">2. Select My PC, select the Specifications tab, and then select User Guides. <p data-bbox="900 617 1445 667">NOTE: When a device is connected to the jack, the computer speakers are disabled.</p>

Display

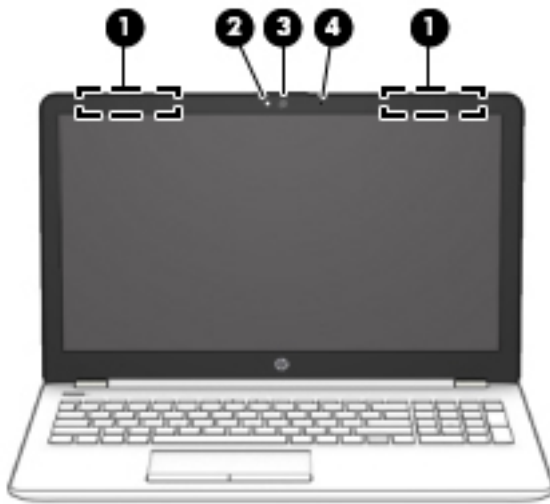

Component	Description
(1) WLAN antennas*	Send and receive wireless signals to communicate with wireless local area networks (WLANs).
(2) Camera light	On: The camera is in use.
(3) Camera	Records video and captures photographs. Some models allow you to video conference and chat online using streaming video. To use the camera: ▲ Type <code>camera</code> in the taskbar search box, and then select Camera .
(4) Internal microphone	Records sound.

*The antennas are not visible from the outside of the computer. For optimal transmission, keep the areas immediately around the antennas free from obstructions.

For wireless regulatory notices, see the section of the *Regulatory, Safety, and Environmental Notices* that applies to your country or region.

To access this guide:

1. Type `support` in the taskbar search box, and then select the **HP Support Assistant** app.

– or –

Click the question mark icon in the taskbar.
2. Select **My PC**, select the **Specifications** tab, and then select **User Guides**.

Keyboard area

TouchPad

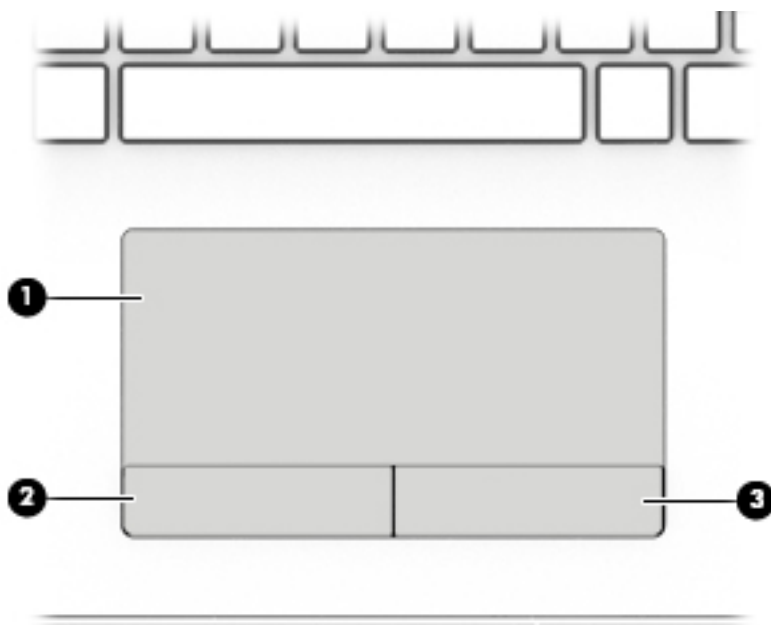

Component	Description
(1) TouchPad zone	Reads your finger gestures to move the pointer or activate items on the screen.
(2) Left TouchPad button	Functions like the left button on an external mouse.
(3) Right TouchPad button	Functions like the right button on an external mouse.

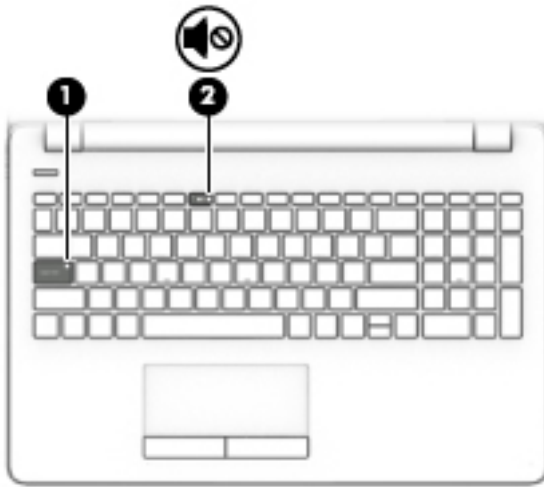

Lights

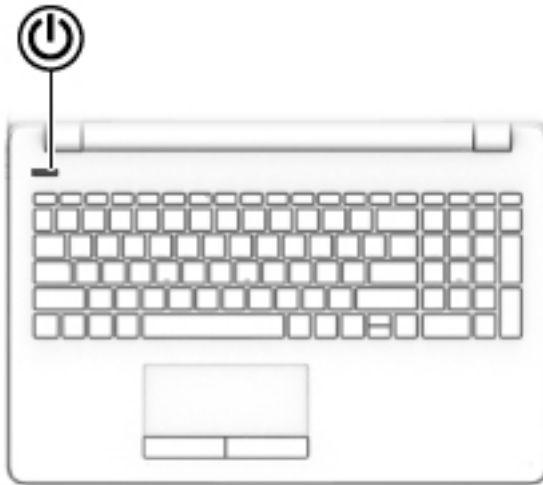

Component		Description
(1)	Caps lock light	On: Caps lock is on, which switches the key input to all capital letters.
(2)	 Mute light	<ul style="list-style-type: none">• Amber: Computer sound is off.• Off: Computer sound is on.

Button



Component	Description
 Power button	<ul style="list-style-type: none">• When the computer is off, press the button to turn on the computer.• When the computer is on, press the button briefly to initiate Sleep.• When the computer is in the Sleep state, press the button briefly to exit Sleep.• When the computer is in Hibernation, press the button briefly to exit Hibernation. <p>CAUTION: Pressing and holding down the power button results in the loss of unsaved information.</p> <p>If the computer has stopped responding and shutdown procedures are ineffective, press and hold the power button for at least 5 seconds to turn off the computer.</p> <p>To learn more about your power settings, see your power options.</p> <ul style="list-style-type: none">▲ Type <code>power options</code> in the taskbar search box, and then select Power Options. <p>– or –</p> <p>Right-click the Power meter icon  and then select Power Options.</p>

Special keys

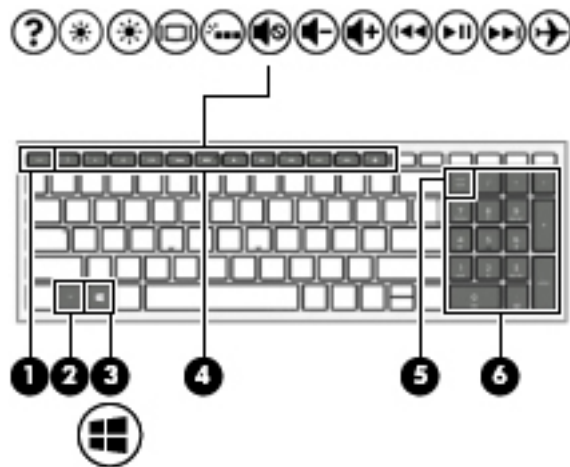













Component	Description
(1) <code>esc</code> key	Displays system information when pressed in combination with the <code>fn</code> key.
(2) <code>fn</code> key	Executes frequently used system functions when pressed in combination with another key. Such key combinations are called <i>hot keys</i> .
(3)  Windows key	Opens the Start menu. NOTE: Pressing the Windows key again will close the Start menu.
(4) Action keys	Execute frequently used system functions. See Action keys on page 13 .
(5) <code>num lk</code> key	Turns the embedded numeric keypad on and off.
(6) Integrated numeric keypad	A separate keypad to the right of the alphabet keyboard. When <code>num lk</code> is pressed, the integrated keypad can be used like an external numeric keypad. NOTE: If the keypad function is active when the computer is turned off, that function is reinstated when the computer is turned back on.

Action keys

An action key performs the function indicated by the icon on the key. To determine which keys are on your product, see [Special keys on page 12](#).



▲ To use an action key, press and hold the key.

Icon	Description
	Opens Help and Support, which provides tutorials, information about the Windows operating system and your computer, answers to questions, and updates to your computer. Help and Support also provides automated troubleshooting tools and access to support.
	Decreases the screen brightness incrementally as long as you hold down the key.
	Increases the screen brightness incrementally as long as you hold down the key.
	Switches the screen image among display devices connected to the system. For example, if a monitor is connected to the computer, repeatedly pressing the key alternates the screen image from computer display to monitor display to simultaneous display on both the computer and monitor.
	Turns the keyboard backlight off or on. NOTE: To conserve battery power, turn off this feature.
	Mutes or restores speaker sound.
	Decreases speaker volume incrementally while you hold down the key.
	Increases speaker volume incrementally while you hold down the key.
	Plays the previous track of an audio CD or the previous section of a DVD or a Blu-ray Disc (BD).
	Starts, pauses, or resumes playback of an audio CD, a DVD, or a BD.
	Plays the next track of an audio CD or the next section of a DVD or a BD.
	Turns the airplane mode and wireless feature on or off. NOTE: The airplane mode key is also referred to as the wireless button. NOTE: A wireless network must be set up before a wireless connection is possible.

 **NOTE:** The action key feature is enabled at the factory. You can disable this feature by pressing and holding the **fn** key and the left **shift** key. The **fn** lock light will turn on. After you have disabled the action key feature, you can still perform each function by pressing the **fn** key in combination with the appropriate action key.

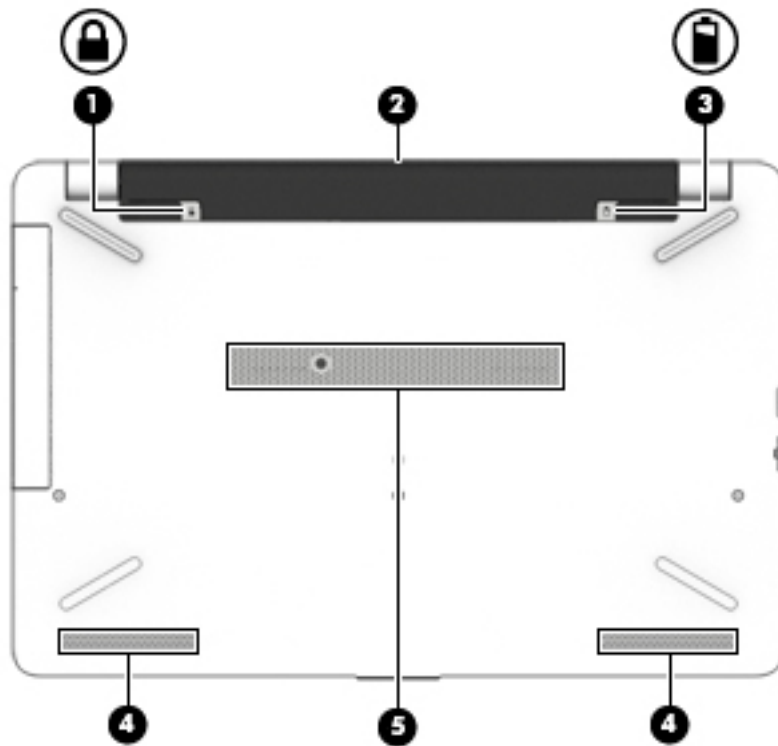
Bottom



Component	Description
(1) 	Battery lock Locks the battery in the battery bay.
(2)	Battery bay Holds the battery.
(3) 	Battery release latch Releases the battery.
(4)	Speakers (2) Produce sound.
(5)	Vent Enables airflow to cool internal components. NOTE: The computer fan starts up automatically to cool internal components and prevent overheating. It is normal for the internal fan to cycle on and off during routine operation.

Labels

The labels affixed to the computer provide information you may need when you troubleshoot system problems or travel internationally with the computer.

 **IMPORTANT:** Check the following locations for the labels described in this section: the bottom of the computer, inside the battery bay, under the service door, or on the back of the display.

- Service label—Provides important information to identify your computer. When contacting support, you will probably be asked for the serial number, and possibly for the product number or the model number. Locate these numbers before you contact support.

Your service label will resemble one of the examples shown below. Refer to the illustration that most closely matches the service label on your computer.



Component

- (1) Serial number
 - (2) Product number
 - (3) Warranty period
 - (4) Model number (select products only)
-

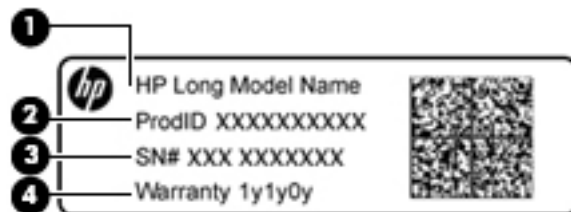

Component

- (1) Model name (select products only)
 - (2) Product number
 - (3) Serial number
 - (4) Warranty period
-

- Regulatory label(s)—Provide(s) regulatory information about the computer.
- Wireless certification label(s)—Provide(s) information about optional wireless devices and the approval markings for the countries or regions in which the devices have been approved for use.

3 Illustrated parts catalog

Computer major components

 **NOTE:** HP continually improves and changes product parts. For complete and current information on supported parts for your computer, go to <http://partsurfer.hp.com>, select your country or region, and then follow the on-screen instructions.

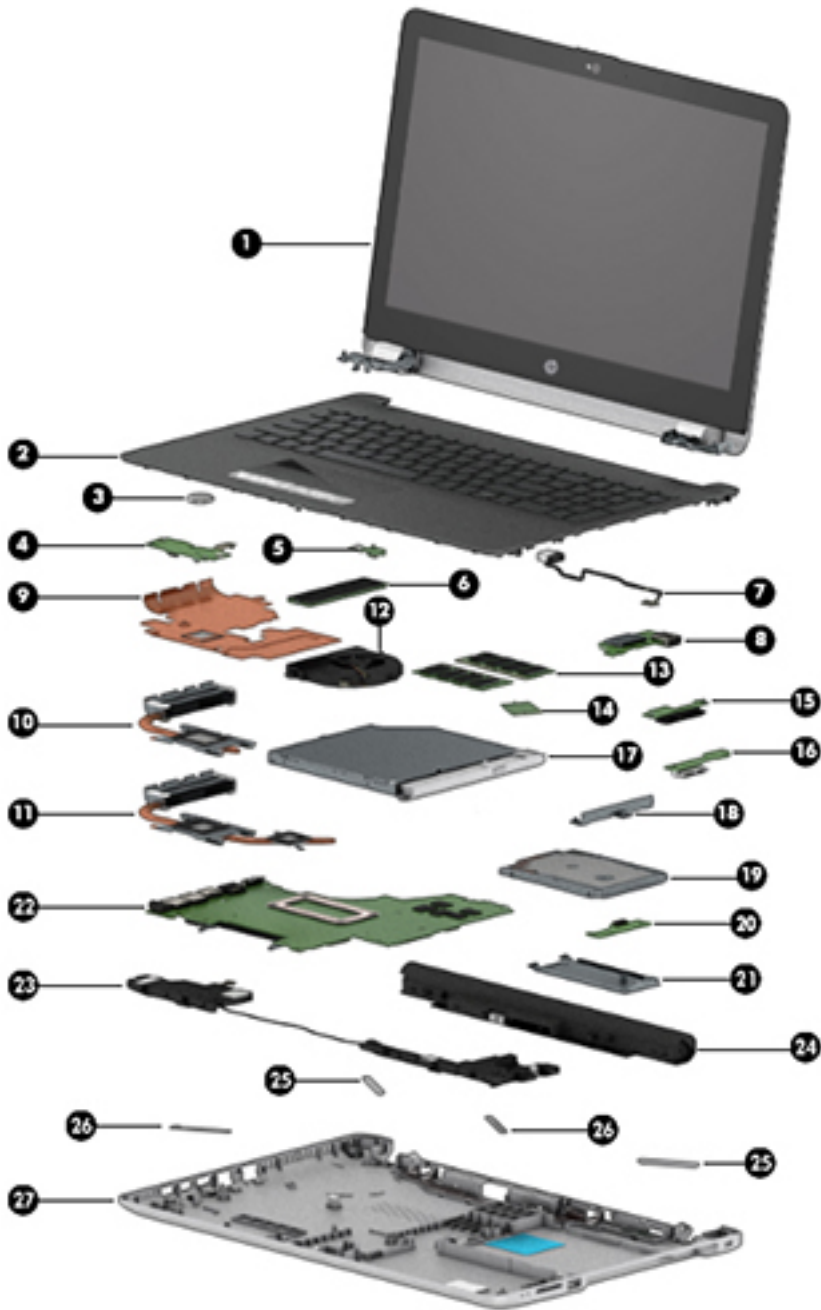

Item	Component	Spare part number
(1)	Display assembly NOTE: For display assembly spare part information, see Display assembly subcomponents on page 20 .	not spared
(2)	Top cover/keyboard NOTE: For a detailed list of keyboard country codes, see Top cover/keyboard on page 76 .	
	Asteroid silver models with no backlight	929904-xxx
	Dark ash silver models with no backlight	929906-xxx
(3)	RTC battery	922847-001
(4)	TouchPad button board	924993-001
(5)	Power button board	924994-001
(6)	Solid-state drive, M.2	
	256 GB	926271-001
	128 GB	926270-001
(7)	Power connector cable	931613-001
(8)	USB board	924991-001
	Heat sink assembly (includes replacement thermal materials)	
(9)	For use in models with UMA graphics and AMD dual core, 6 W processors	925019-001
(10)	For use in models with UMA graphics and AMD dual core, 15 W processors	925020-001
(11)	For use in models with UMA graphics memory and AMD quad core processors	925017-001
(11)	For use in models with discrete graphics memory and AMD dual core processors	925021-001
	For use in models with discrete graphics memory and AMD quad core processors	925018-001
(12)	Fan	925012-001
(13)	Memory module (DDR4-2400)	
	8-GB	862398-855
	4 GB	862397-855
	2 GB	864271-855
(14)	WLAN module	
	Intel Dual Band Wireless-AC 3168 802.11 ac 1x1 WiFi + BT 4.2 Combo Adapter	863934-855
(15)	Hard drive connector board	924995-001
(16)	Optical drive connector board	924990-001
(17)	Optical drive (DVD+/-RW Double-Layer SuperMulti)	920420-004
(18)	Hard drive bracket	924980-001
(19)	Hard drive, 2.5 inch (does not include bracket, connector board, or cable)	
	• 1-TB, 5400-rpm	778192-005

Item	Component	Spare part number
	<ul style="list-style-type: none"> 500-GB, 7200-rpm 	703267-005
	<ul style="list-style-type: none"> 500-GB, 5400-rpm 	778186-005
(20)	Solid-state drive board	924992-001
(21)	Solid-state drive bracket	924981-001
(22)	<p>System board (includes replacement thermal materials)</p> <p>All system boards use the following part numbers:</p> <p>xxxxxx-001: Non-Windows operating systems</p> <p>xxxxxx-601: Windows 10 operating system</p>	
	AMD A6-9220P processor	926268-xx1
	AMD E2-9000e processor	926269-xx1
(23)	Speakers (includes left and right speakers and cable)	925306-001
(24)	Battery	
	4-cell, 41-Whr, 2.8-Ah Li-ion battery	919701-850
	3-cell, 31-Whr, 2.8-Ah Li-ion battery	919700-850
(25)	Rubber Kit (includes upper feet)	
	Asteroid silver	931599-001
	Dark ash silver	931600-001
(26)	Rubber Kit (includes lower feet)	
	Asteroid silver	931601-001
	Dark ash silver	931602-001
(27)	Bottom cover	
	For use in models with an optical drive:	
	<ul style="list-style-type: none"> Asteroid silver 	929894-001
	<ul style="list-style-type: none"> Dark ash silver 	929895-001
	For use in models without an optical drive:	
	<ul style="list-style-type: none"> Dark ash silver 	929897-001

Display assembly subcomponents

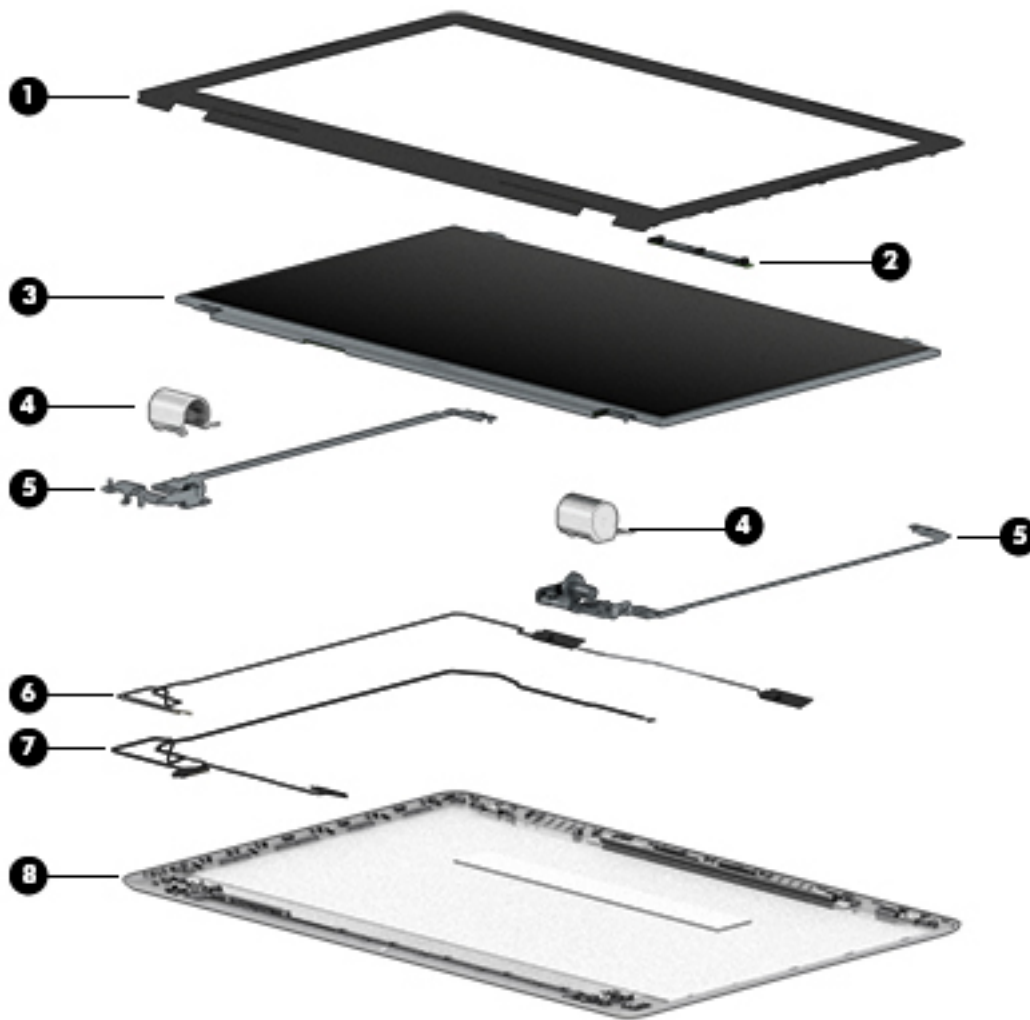

Item	Component	Spare part number
(1)	Display bezel	924925-001
(2)	Camera/microphone module	
	HD	919475-003
	VGA	919476-003
(3)	Raw display panel (39.6-cm [15.6-in])	
	FHD	850475-004
	HD	850477-004
(4)	Hinge cover	
	Left, asteroid silver	929900-001
	Right, asteroid silver	929901-001
	Left, dark ash silver	929902-001

Item	Component	Spare part number
	Right, dark ash silver	929903-001
(5)	Hinge Kit (left and right)	925297-001
(6)	Antenna (includes wireless antenna cable and transceiver)	925032-001
(7)	Display cable (includes display panel cable and camera/microphone cable)	924930-001
(8)	Display enclosure:	
	Asteroid silver	929892-001
	Dark ash silver	929893-001

Cables

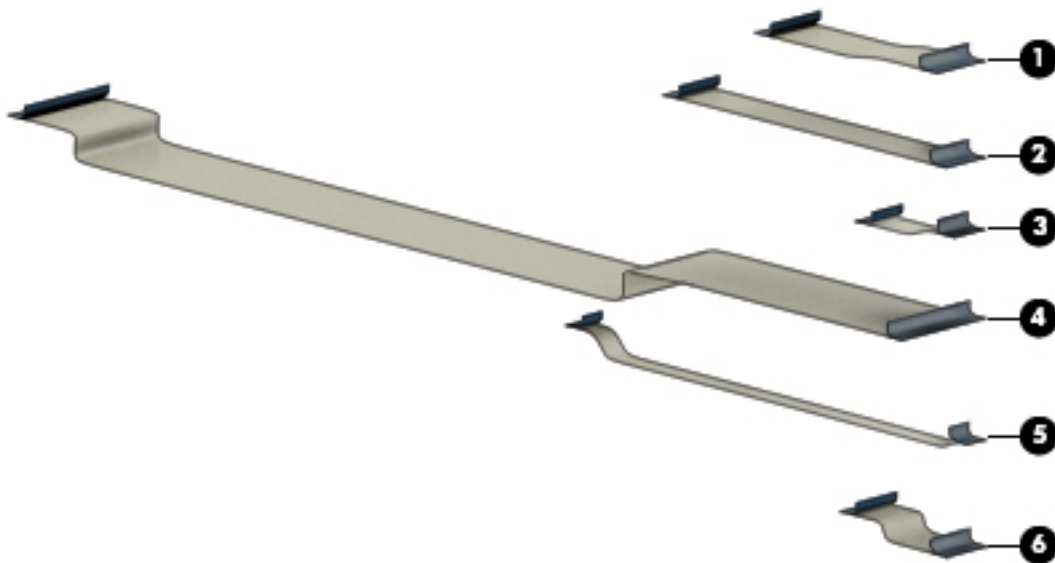

Item	Component	Spare part number
(1)	Hard drive connector board cable	924927-001
(2)	TouchPad button board cable	924934-001
(3)	TouchPad cable	924928-001
(4)	USB board cable	924929-001
(5)	Power button board cable	924933-001
(6)	Optical drive connector board cable	924926-001

Mass storage devices

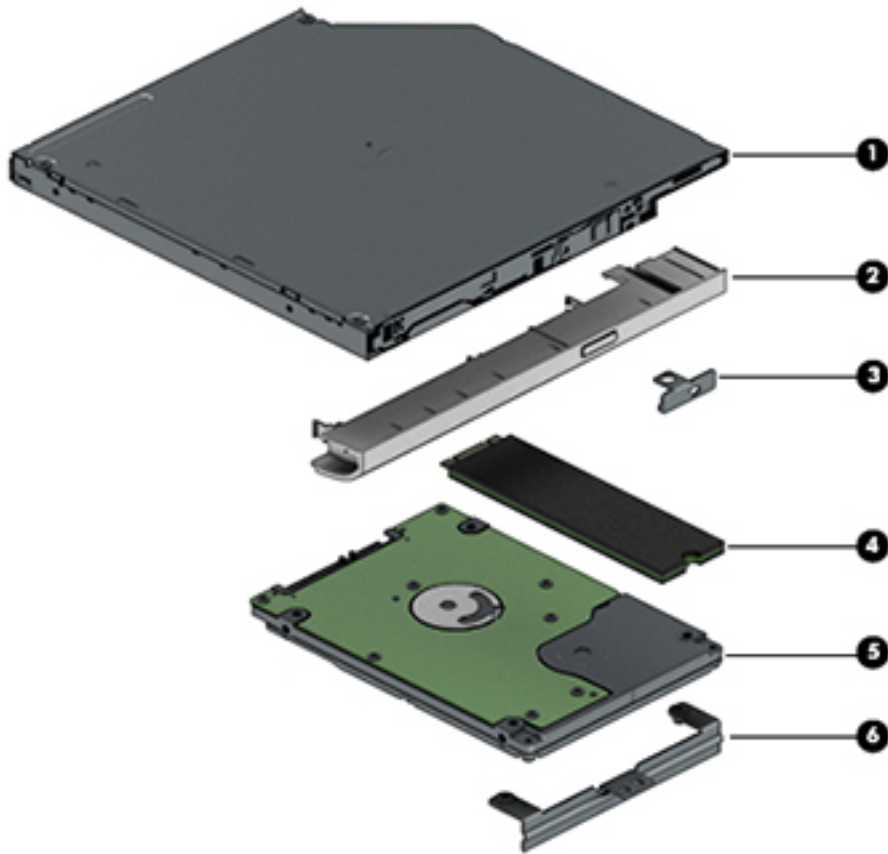

Item	Component	Spare part number
(1)	Optical drive (DVD+/-RW Double-Layer SuperMulti)	920420-004
	Optical drive bezel	
	Asteroid silver	929898-001
	Dark ash silver	929899-001
(2)	Optical drive bracket	924979-001
(3)	Solid-state drive, M.2	
	256 GB	926271-001
	128 GB	926270-001
(4)	Hard drive, SATA; does not include brackets, connector board, or cable):	
	1-TB, 5400-rpm	778192-005
	500-GB, 7200-rpm	703267-005
	500-GB, 5400-rpm	778186-005
(5)	Hard drive bracket	924980-001

Miscellaneous parts

Component	Spare part number
HP Smart AC adapter (4.5 mm, non-PFC)	
45-W	741727-001
Power cord (3-pin, black, 1.0-m; Longwell):	
For use in Denmark	920688-007
For use in Europe	920688-005
For use in India	920688-016
For use in Israel	920688-008
For use in Japan	920688-017
For use in North America	920688-001
For use in South Africa	920688-010
For use in South Korea	920688-013
For use in Switzerland	920688-009
For use in the United Kingdom and Singapore	920688-006
Essential top load case	679921-001

4 Removal and replacement procedures preliminary requirements

Tools required

You will need the following tools to complete the removal and replacement procedures:

- Flat-bladed screwdriver
- Magnetic screwdriver
- Phillips P0 and P1 screwdrivers

Service considerations

The following sections include some of the considerations that you must keep in mind during disassembly and assembly procedures.

 **NOTE:** As you remove each subassembly from the computer, place the subassembly (and all accompanying screws) away from the work area to prevent damage.

Plastic parts

 **CAUTION:** Using excessive force during disassembly and reassembly can damage plastic parts. Use care when handling the plastic parts. Apply pressure only at the points designated in the maintenance instructions.

Cables and connectors

 **CAUTION:** When servicing the computer, be sure that cables are placed in their proper locations during the reassembly process. Improper cable placement can damage the computer.

Cables must be handled with extreme care to avoid damage. Apply only the tension required to unseat or seat the cables during removal and insertion. Handle cables by the connector whenever possible. In all cases, avoid bending, twisting, or tearing cables. Be sure that cables are routed in such a way that they cannot be caught or snagged by parts being removed or replaced. Handle flex cables with extreme care; these cables tear easily.

Drive handling

⚠ CAUTION: Drives are fragile components that must be handled with care. To prevent damage to the computer, damage to a drive, or loss of information, observe these precautions:

Before removing or inserting a hard drive, shut down the computer. If you are unsure whether the computer is off or in Hibernation, turn the computer on, and then shut it down through the operating system.

Before handling a drive, be sure that you are discharged of static electricity. While handling a drive, avoid touching the connector.

Before removing a diskette drive or optical drive, be sure that a diskette or disc is not in the drive and be sure that the optical drive tray is closed.

Handle drives on surfaces covered with at least one inch of shock-proof foam.

Avoid dropping drives from any height onto any surface.

After removing a hard drive, an optical drive, or a diskette drive, place it in a static-proof bag.

Avoid exposing an internal hard drive to products that have magnetic fields, such as monitors or speakers.

Avoid exposing a drive to temperature extremes or liquids.

If a drive must be mailed, place the drive in a bubble pack mailer or other suitable form of protective packaging and label the package "FRAGILE."

Grounding guidelines

Electrostatic discharge damage

Electronic components are sensitive to electrostatic discharge (ESD). Circuitry design and structure determine the degree of sensitivity. Networks built into many integrated circuits provide some protection, but in many cases, ESD contains enough power to alter device parameters or melt silicon junctions.

A discharge of static electricity from a finger or other conductor can destroy static-sensitive devices or microcircuitry. Even if the spark is neither felt nor heard, damage may have occurred.

An electronic device exposed to ESD may not be affected at all and can work perfectly throughout a normal cycle. Or the device may function normally for a while, then degrade in the internal layers, reducing its life expectancy.

⚠ CAUTION: To prevent damage to the computer when you are removing or installing internal components, observe these precautions:

Keep components in their electrostatic-safe containers until you are ready to install them.

Before touching an electronic component, discharge static electricity by using the guidelines described in this section.

Avoid touching pins, leads, and circuitry. Handle electronic components as little as possible.

If you remove a component, place it in an electrostatic-safe container.

The following table shows how humidity affects the electrostatic voltage levels generated by different activities.

⚠ CAUTION: A product can be degraded by as little as 700 V.

Typical electrostatic voltage levels			
Event	Relative humidity		
	10%	40%	55%
Walking across carpet	35,000 V	15,000 V	7,500 V
Walking across vinyl floor	12,000 V	5,000 V	3,000 V
Motions of bench worker	6,000 V	800 V	400 V
Removing DIPS from plastic tube	2,000 V	700 V	400 V
Removing DIPS from vinyl tray	11,500 V	4,000 V	2,000 V
Removing DIPS from Styrofoam	14,500 V	5,000 V	3,500 V
Removing bubble pack from PCB	26,500 V	20,000 V	7,000 V
Packing PCBs in foam-lined box	21,000 V	11,000 V	5,000 V

Packaging and transporting guidelines

Follow these grounding guidelines when packaging and transporting equipment:

- To avoid hand contact, transport products in static-safe tubes, bags, or boxes.
- Protect ESD-sensitive parts and assemblies with conductive or approved containers or packaging.
- Keep ESD-sensitive parts in their containers until the parts arrive at static-free workstations.
- Place items on a grounded surface before removing items from their containers.
- Always be properly grounded when touching a component or assembly.
- Store reusable ESD-sensitive parts from assemblies in protective packaging or non-conductive foam.
- Use transporters and conveyors made of antistatic belts and roller bushings. Be sure that mechanized equipment used for moving materials is wired to ground and that proper materials are selected to avoid static charging. When grounding is not possible, use an ionizer to dissipate electric charges.

Workstation guidelines

Follow these grounding workstation guidelines:

- Cover the workstation with approved static-shielding material.
- Use a wrist strap connected to a properly grounded work surface and use properly grounded tools and equipment.
- Use conductive field service tools, such as cutters, screwdrivers, and vacuums.
- When fixtures must directly contact dissipative surfaces, use fixtures made only of static-safe materials.
- Keep the work area free of nonconductive materials, such as ordinary plastic assembly aids and Styrofoam.
- Handle ESD-sensitive components, parts, and assemblies by the case or PCM laminate. Handle these items only at static-free workstations.
- Avoid contact with pins, leads, or circuitry.
- Turn off power and input signals before inserting or removing connectors or test equipment.

Equipment guidelines

Grounding equipment must include either a wrist strap or a foot strap at a grounded workstation.

- When seated, wear a wrist strap connected to a grounded system. Wrist straps are flexible straps with a minimum of one megohm $\pm 10\%$ resistance in the ground cords. To provide proper ground, wear a strap snugly against the skin at all times. On grounded mats with banana-plug connectors, use alligator clips to connect a wrist strap.
- When standing, use foot straps and a grounded floor mat. Foot straps (heel, toe, or boot straps) can be used at standing workstations and are compatible with most types of shoes or boots. On conductive floors or dissipative floor mats, use foot straps on both feet with a minimum of one megohm resistance between the operator and ground. To be effective, the conductive must be worn in contact with the skin.

The following grounding equipment is recommended to prevent electrostatic damage:

- Antistatic tape
- Antistatic smocks, aprons, and sleeve protectors
- Conductive bins and other assembly or soldering aids
- Nonconductive foam
- Conductive tabletop workstations with ground cords of one megohm resistance
- Static-dissipative tables or floor mats with hard ties to the ground
- Field service kits
- Static awareness labels
- Material-handling packages
- Nonconductive plastic bags, tubes, or boxes
- Metal tote boxes
- Electrostatic voltage levels and protective materials

The following table lists the shielding protection provided by antistatic bags and floor mats.

Material	Use	Voltage protection level
Antistatic plastics	Bags	1,500 V
Carbon-loaded plastic	Floor mats	7,500 V
Metallized laminate	Floor mats	5,000 V

5 Removal and replacement procedures for Customer Self-Repair parts

 **CAUTION:** The Customer Self-Repair program is not available in all locations. Installing a part not supported by the Customer Self-Repair program may void your warranty. Check your warranty to determine if Customer Self-Repair is supported in your location.

 **NOTE:** HP continually improves and changes product parts. For complete and current information on supported parts for your computer, go to <http://partsurfer.hp.com>, select your country or region, and then follow the on-screen instructions.

Component replacement procedures

 **NOTE:** Please read and follow the procedures described here to access and replace Customer Self-Repair parts successfully.

 **NOTE:** Details about your computer, including model, serial number, product key, and length of warranty, are on the service tag at the bottom of your computer. See [Labels on page 15](#) for details.

This chapter provides removal and replacement procedures for Customer Self-Repair parts.

There are as many as 3 screws that must be removed, replaced, or loosened when servicing Customer Self-Repair parts. Make special note of each screw size and location during removal and replacement.

Battery

Description	Spare part number
4-cell, 41-Whr, 2.8-Ah Li-ion battery	919701-850
3-cell, 31-Whr, 2.8-Ah Li-ion battery	919700-850

Before disassembling the computer, follow these steps:

1. Shut down the computer. If you are unsure whether the computer is off or in Hibernation, turn the computer on, and then shut it down through the operating system.
2. Disconnect all external devices connected to the computer.
3. Disconnect the power from the computer by first unplugging the power cord from the AC outlet and then unplugging the AC adapter from the computer.

To remove the battery:

1. Position the computer upside down on a flat surface.
2. Slide the battery lock latch **(1)** to unlock the battery, and then slide the battery release latch **(2)** to release the battery.



NOTE: The battery release latch automatically returns to its original position.

3. Remove the battery **(3)** from the computer.

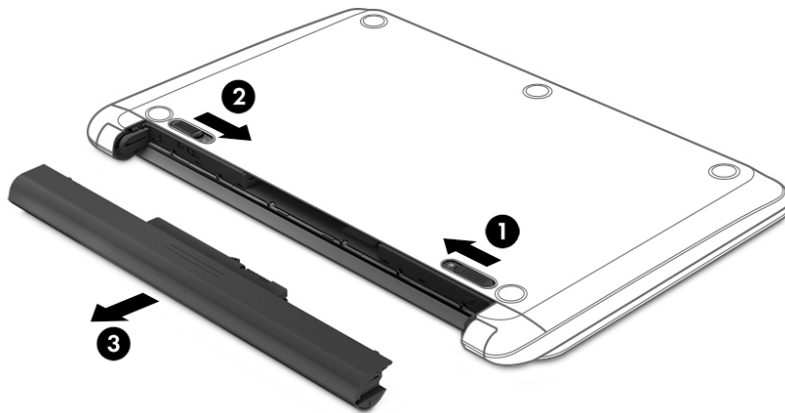

Optical drive



NOTE: Optical drive spare part kits include bracket and bezel.

Description	Spare part number
DVD+/-RW Double-Layer SuperMulti Drive	920420-004
Optical drive bracket	924979-001
Optical drive bezel	
Asteroid silver	929898-001
Dark ash silver	929899-001

Before removing the optical drive, follow these steps:

1. Shut down the computer. If you are unsure whether the computer is off or in Hibernation, turn the computer on, and then shut it down through the operating system.
2. Disconnect all external devices connected to the computer.
3. Disconnect the power from the computer by first unplugging the power cord from the AC outlet and then unplugging the AC adapter from the computer.
4. Remove the battery (see [Battery on page 30](#)).

To remove the optical drive:

1. Remove the Phillips PM2.5×11.0 screw **(1)** that secures the optical drive to the computer.
2. Remove the optical drive **(2)** by sliding it out of the optical drive bay.

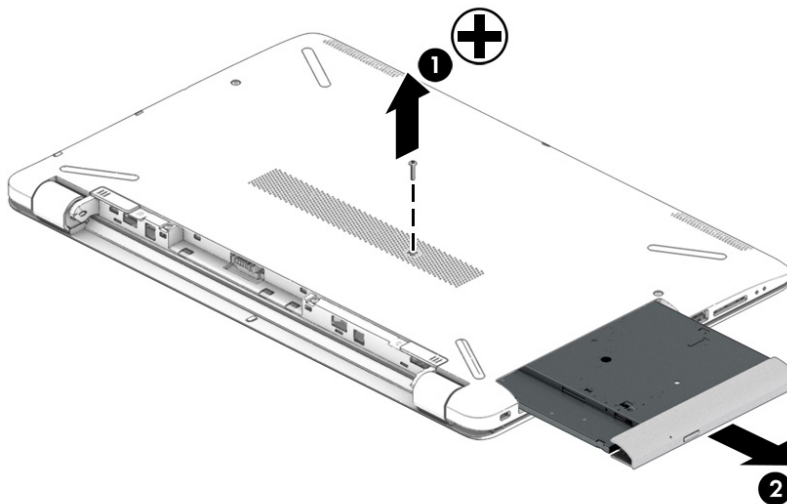

3. If it is necessary to remove the optical drive bezel, insert a paper clip into the release hole **(1)** to disengage the bezel. Press the tab **(2)** to release the bezel from the drive. Rotate the side of the bezel **(3)**, and then remove it **(4)**.

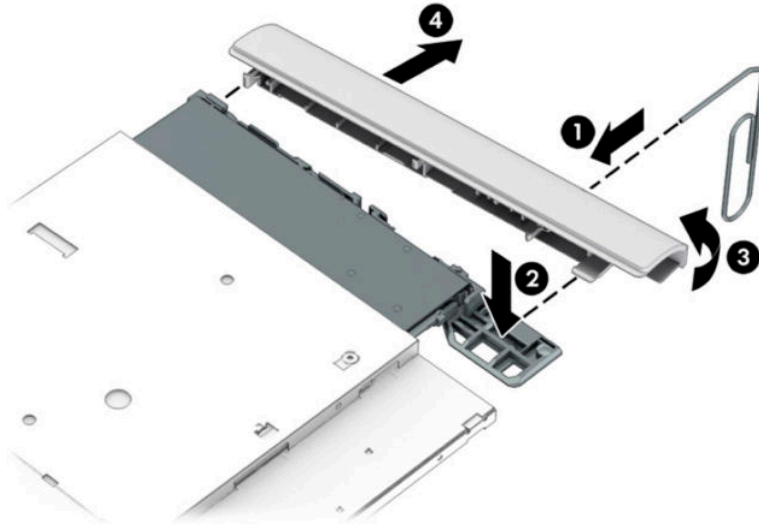

4. If it is necessary to replace the bracket on the rear of the optical drive, remove the Phillips PM2.0×2.5 screw **(1)** that secures the bracket to the drive, and then remove the bracket **(2)**.

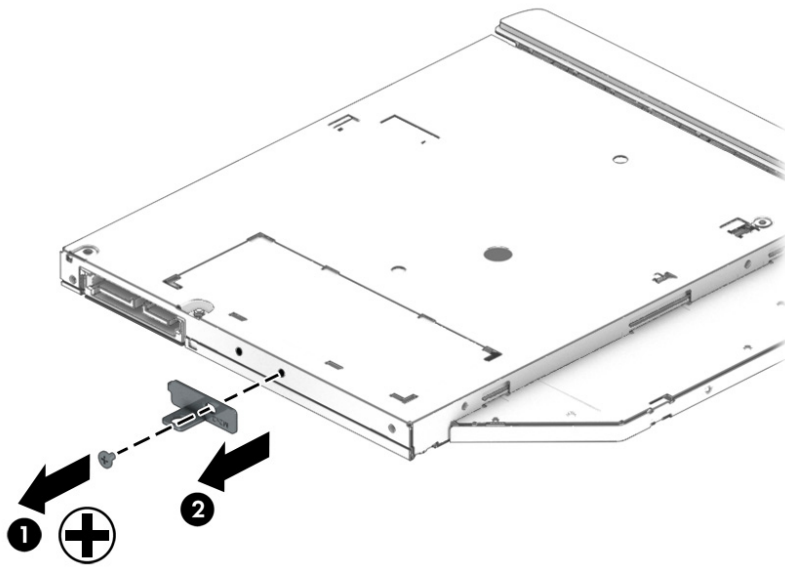

Reverse this procedure to reassemble and install the optical drive.

6 Removal and replacement procedures for Authorized Service Provider parts

 **CAUTION:** Components described in this chapter should only be accessed by an authorized service provider. Accessing these parts can damage the computer or void the warranty.

 **NOTE:** HP continually improves and changes product parts. For complete and current information on supported parts for your computer, go to <http://partsurfer.hp.com>, select your country or region, and then follow the on-screen instructions.

Component replacement procedures

 **NOTE:** Details about your computer, including model, serial number, product key, and length of warranty, are on the service tag at the bottom of your computer. See [Labels on page 15](#) for details.

This chapter provides removal and replacement procedures for Authorized Service Provider only parts.

There are as many as 54 screws that must be removed, replaced, or loosened when servicing Authorized Service Provider only parts. Make special note of each screw size and location during removal and replacement.

Display subcomponents (bezel, panel, camera)

 **NOTE:** Display assemblies are spared at the subcomponent level only.

This section illustrates how to remove the display bezel, display panel, and camera module without removing the display from the computer. The [Display assembly on page 63](#) section illustrates removing all display subcomponents.

To remove the display assembly subcomponents, follow these steps:

1. Shut down the computer. If you are unsure whether the computer is off or in Hibernation, turn the computer on, and then shut it down through the operating system.
2. Disconnect all external devices connected to the computer.
3. Disconnect the power from the computer by first unplugging the power cord from the AC outlet and then unplugging the AC adapter from the computer.

Remove the display assembly subcomponents:

1. Open the computer as far as it will open.
2. To remove the display bezel:
 - a. Flex the inside of the top edge **(1)**, the left and right edges **(2)**, and the bottom edge **(3)** of the display bezel until the bezel disengages from the display enclosure.

 **NOTE:** When removing the bezel from the bottom of the display **(3)**, be careful not to peel the Mylar from the bottom of the display panel.

- b. Remove the display bezel (4).

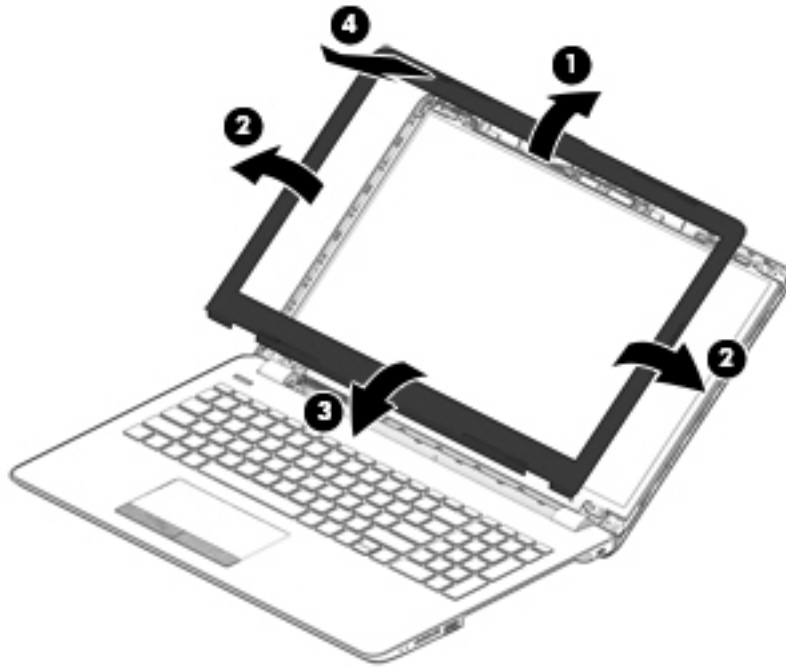

3. To remove the camera/microphone module:

- a. Position the display assembly with the top edge toward you.
- b. Pry up to disengage the camera/microphone module from the adhesive that secures it to the display (1).
- c. Disconnect the cable (2) from the module.
- d. Remove the tape from the enclosure (3). Replacement cameras come with tape already installed.

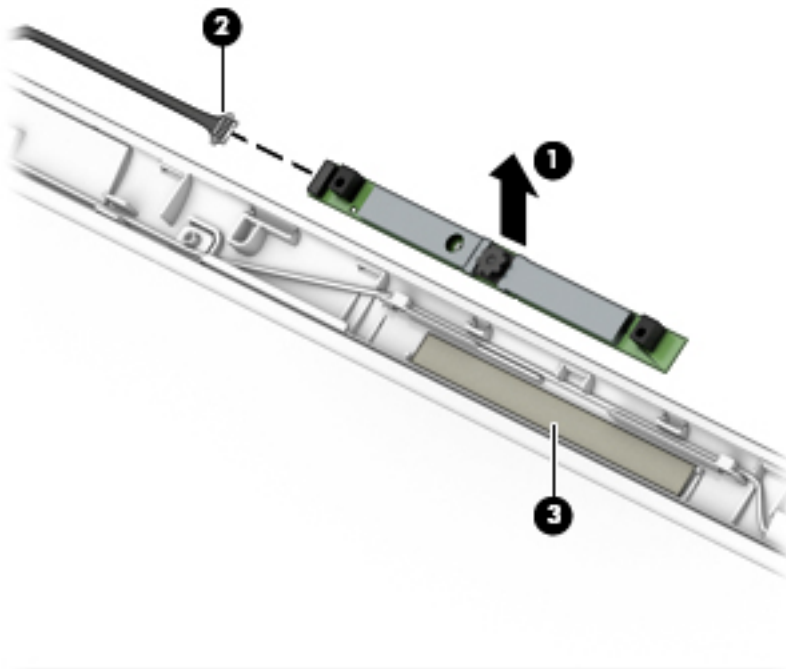

4. To remove the display panel:
 - a. Remove the four Phillips PM2.0×3.0 screws **(1)** that secure the display panel to the top of the enclosure.
 - b. Remove the two Phillips PM2.0×3.0 screws **(2)** that secure the display panel to the bottom of the enclosure.
 - c. Lift the hinges up and move aside enough to be able to rotate the panel up and over **(3)**.
 - d. Rotate the display panel onto the keyboard **(4)** to gain access to the display cable connection on the back of the panel.

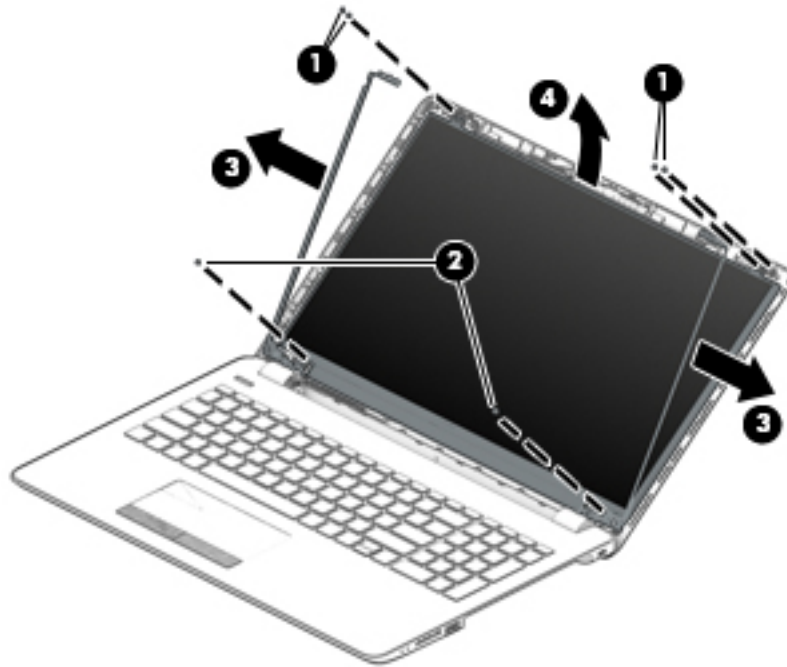

- e. On the back of the display panel, release the adhesive strip that secures the display panel cable to the display panel, and then disconnect the cable **(1)**.

- f. Remove the display panel from the computer **(2)**.

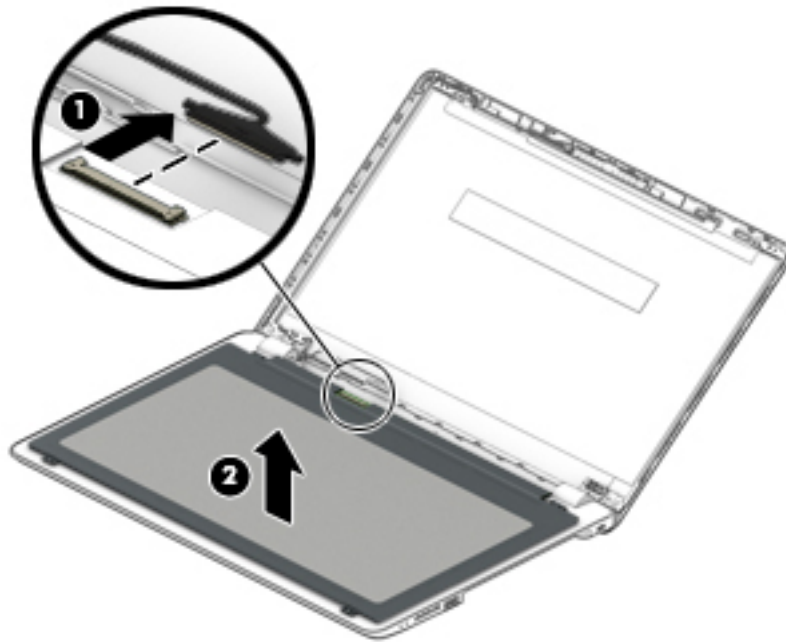

Reverse this procedure to reassemble and install the display assembly components.

Rubber feet

Description	Spare part number
Rubber feet, upper	
Asteroid silver	931599-001
Dark ash silver	931600-001
Rubber feet, lower	
Asteroid silver	931601-001
Dark ash silver	931602-001

Before removing the rubber feet, follow these steps:

1. Shut down the computer. If you are unsure whether the computer is off or in Hibernation, turn the computer on, and then shut it down through the operating system.
2. Disconnect all external devices connected to the computer.
3. Disconnect the power from the computer by first unplugging the power cord from the AC outlet and then unplugging the AC adapter from the computer.

To remove the rubber feet:

- ▲ Peel the lower rubber feet **(1)** and upper rubber feet **(2)** from the bottom of the computer.



NOTE: The lower feet and upper feet are different sizes.

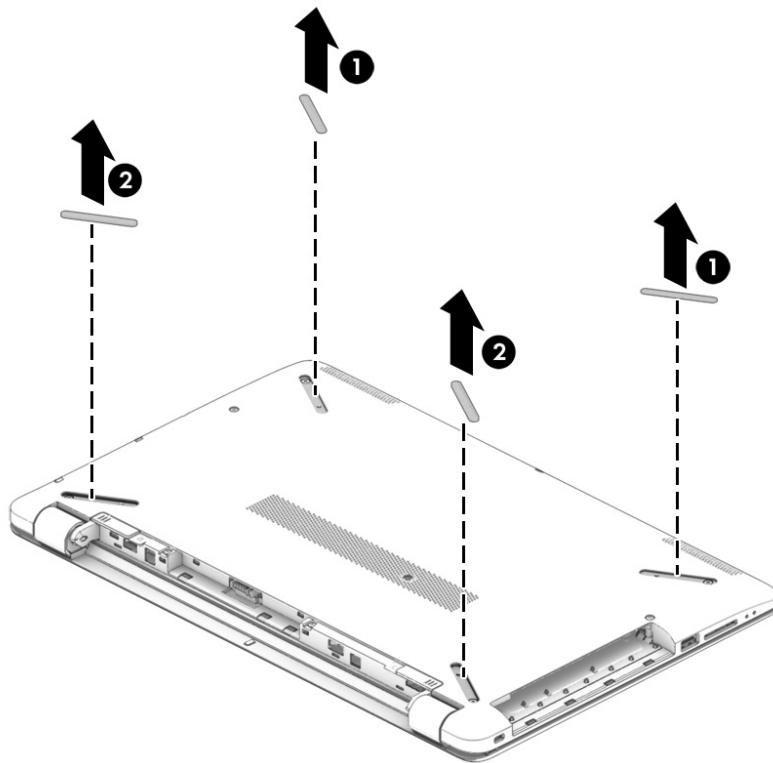

Reverse this procedure to install the rubber feet.

Bottom cover

Description	Spare part number
Bottom cover for use in models with an optical drive:	
<ul style="list-style-type: none">Asteroid silver	929894-001
<ul style="list-style-type: none">Dark ash silver	929895-001
Bottom cover for use in models without an optical drive:	
<ul style="list-style-type: none">Dark ash silver	929897-001

Before removing the bottom cover, follow these steps:

1. Shut down the computer. If you are unsure whether the computer is off or in Hibernation, turn the computer on, and then shut it down through the operating system.
2. Disconnect all external devices connected to the computer.
3. Disconnect the power from the computer by first unplugging the power cord from the AC outlet and then unplugging the AC adapter from the computer.
4. Remove the battery (see [Battery on page 30](#)).
5. Remove the optical drive (see [Optical drive on page 31](#)), if installed.

To remove the bottom cover:

1. Position the computer upside down with the front toward you.
2. Peel back the rubber feet enough to access the screws underneath **(1)**

3. Remove the 9 Phillips PM2.5×11.0 screws (2) that secure the bottom cover to the computer.

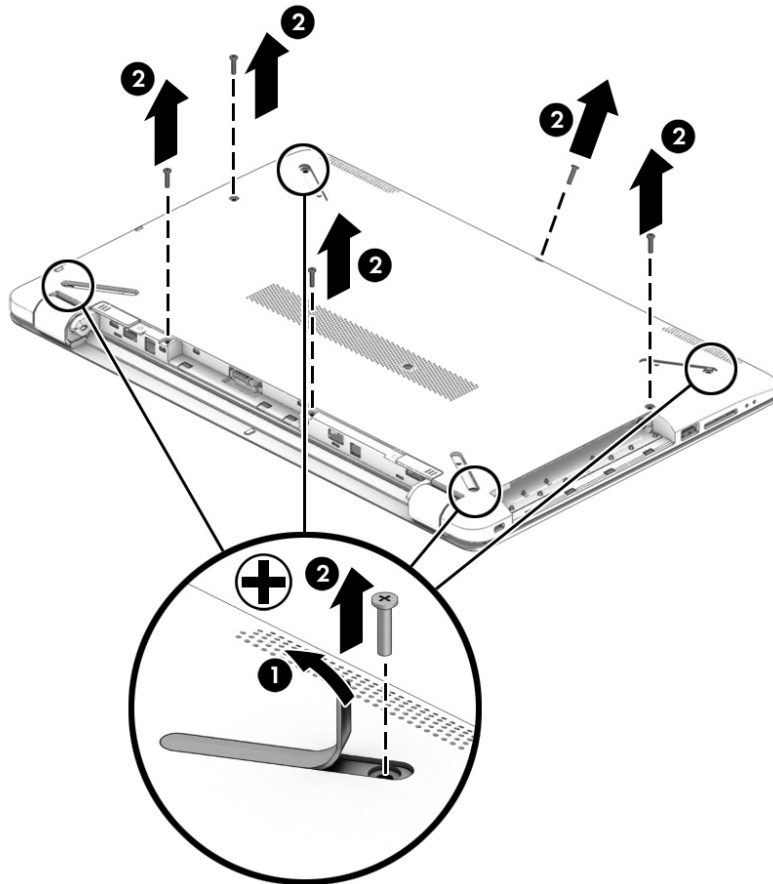

4. Start prying at the front of the computer and work around to the back to separate the bottom cover from computer **(1)**, and then remove the bottom cover **(2)**.

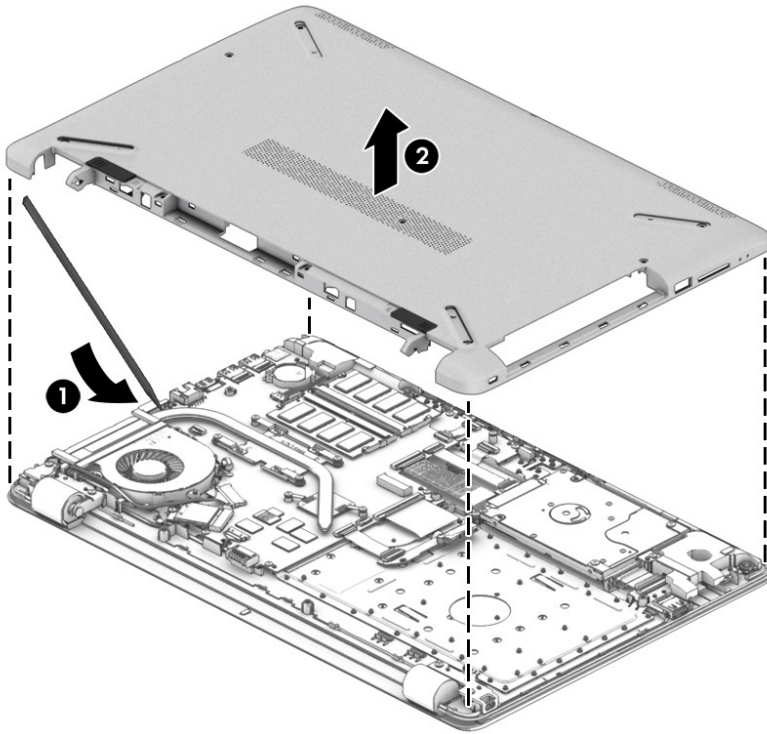

Reverse this procedure to install the bottom cover.

WLAN module

Description	Spare part number
Intel Dual Band Wireless-AC 3168 802.11 ac 1x1 WiFi + BT 4.2 Combo Adapter	863934-855

 **CAUTION:** To prevent an unresponsive system, replace the wireless module only with a wireless module authorized for use in the computer by the governmental agency that regulates wireless devices in your country or region. If you replace the module and then receive a warning message, remove the module to restore device functionality, and then contact support.

Before removing the WLAN module, follow these steps:

1. Shut down the computer. If you are unsure whether the computer is off or in Hibernation, turn the computer on, and then shut it down through the operating system.
2. Disconnect all external devices connected to the computer.
3. Disconnect the power from the computer by first unplugging the power cord from the AC outlet and then unplugging the AC adapter from the computer.
4. Remove the battery (see [Battery on page 30](#)).
5. Remove the optical drive (see [Optical drive on page 31](#)), if installed.
6. Remove the bottom cover (see [Bottom cover on page 38](#)).

To remove the WLAN module:

1. Disconnect the WLAN antenna cables **(1)** from the terminals on the WLAN module.



NOTE: The WLAN antenna cable labeled “1” connects to the WLAN module “Main” terminal labeled “1”. The WLAN antenna cable labeled “2” connects to the WLAN module “Aux” terminal labeled “2” (if applicable).

2. Remove the Phillips PM2.0×3.0 screw **(2)** that secures the WLAN module to the system board. (The WLAN module tilts up.)

3. Remove the WLAN module by pulling the module away from the slot at an angle (3).

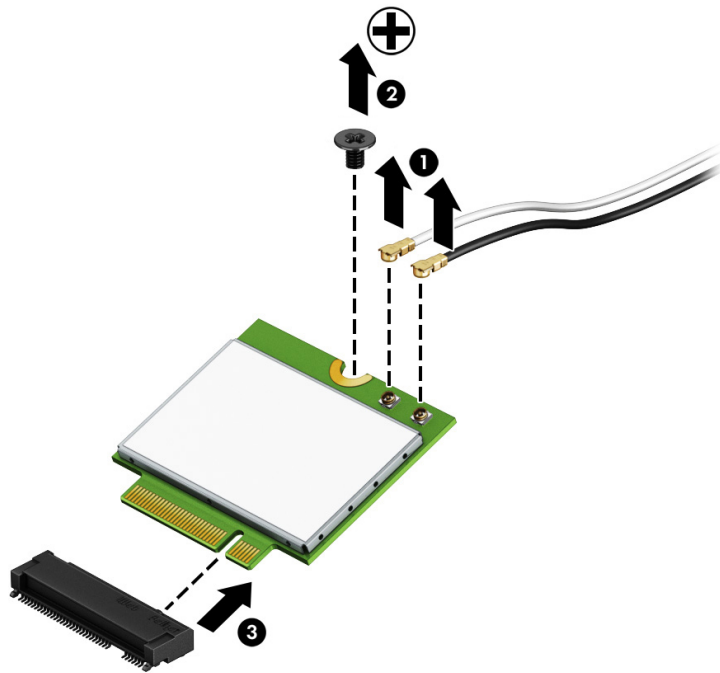

 **NOTE:** If the WLAN antennas are not connected to the terminals on the WLAN module, the protective sleeves must be installed on the antenna connectors, as shown in the following illustration.

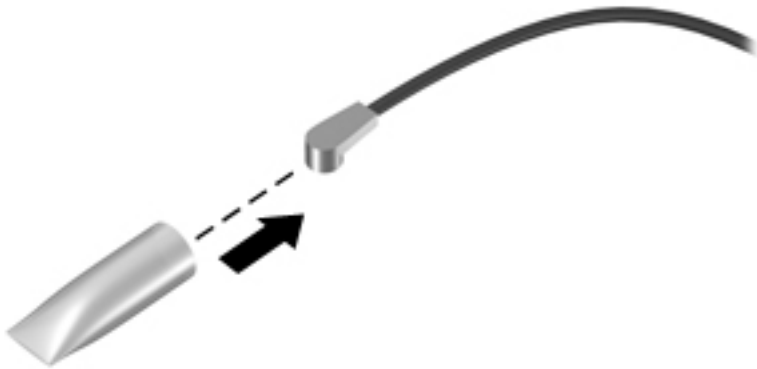

Reverse this procedure to install the WLAN module.

Memory module

Description	Spare part number
Memory module (PC4-2400)	
8-GB	862398-855
4-GB	862397-855
2-GB	864271-855

Before removing a memory module, follow these steps:

1. Shut down the computer. If you are unsure whether the computer is off or in Hibernation, turn the computer on, and then shut it down through the operating system.
2. Disconnect all external devices connected to the computer.
3. Disconnect the power from the computer by first unplugging the power cord from the AC outlet and then unplugging the AC adapter from the computer.
4. Remove the battery (see [Battery on page 30](#)).
5. Remove the optical drive (see [Optical drive on page 31](#)), if installed.
6. Remove the bottom cover (see [Bottom cover on page 38](#)).

To remove a memory module:

1. Spread the retaining tabs **(1)** on each side of the memory module slot to release the memory module. (The memory module tilts up.)
2. Remove the memory module **(2)** by pulling it away from the slot at an angle.

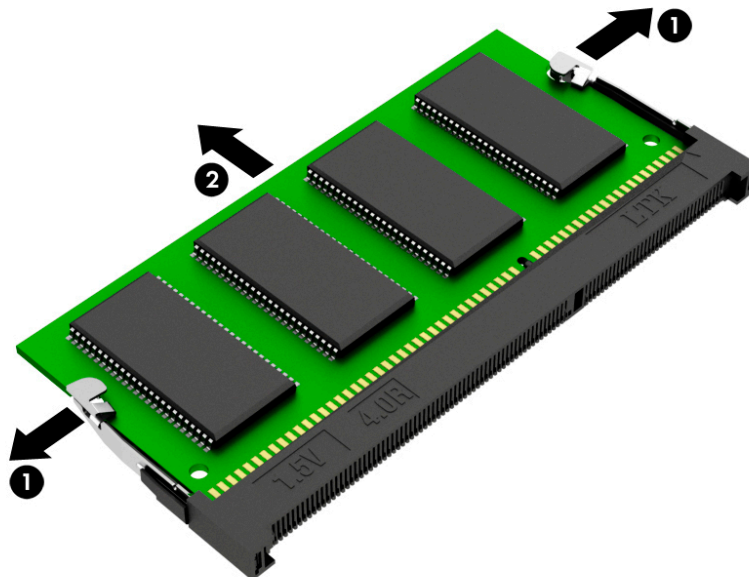

Reverse this procedure to install a memory module.

Optical drive connector board

Description	Spare part number
Optical drive connector board	924990-001
Optical drive cable	924926-001

Before removing the optical drive connector board, follow these steps:

1. Shut down the computer. If you are unsure whether the computer is off or in Hibernation, turn the computer on, and then shut it down through the operating system.
2. Disconnect all external devices connected to the computer.
3. Disconnect the power from the computer by first unplugging the power cord from the AC outlet and then unplugging the AC adapter from the computer.
4. Remove the battery (see [Battery on page 30](#)).
5. Remove the optical drive (see [Optical drive on page 31](#)), if installed.
6. Remove the bottom cover (see [Bottom cover on page 38](#)).

To remove the optical drive connector board:

1. Disconnect the cable from the optical drive connector board **(1)**.
2. Remove the Phillips PM2.0×2.0 screw **(2)** that secures the optical drive connector board to the computer.
3. Rotate the connector side of the board upward, and then pull the board up and out of the computer **(3)**.

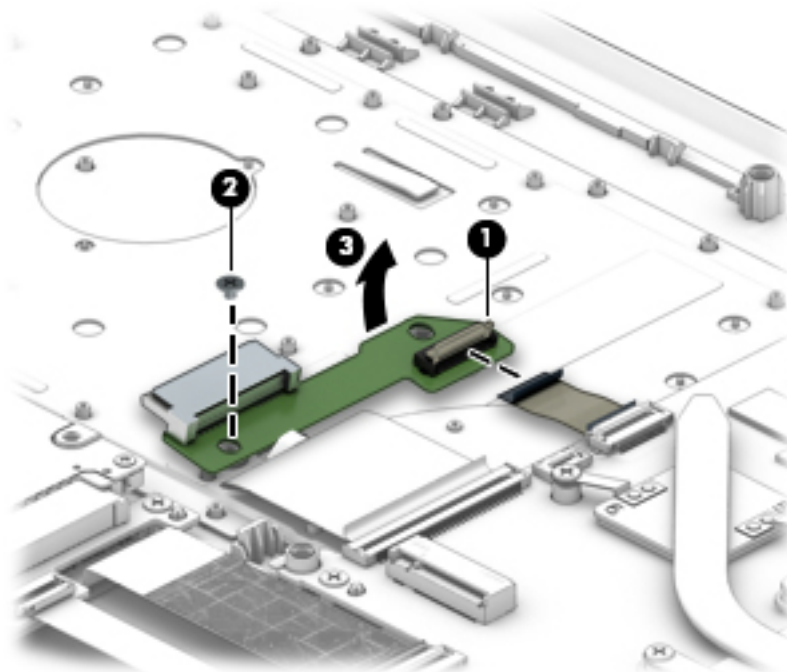

Reverse this procedure to install the optical drive board connector.

Hard drive and hard drive connector board



NOTE: The hard drive spare part kit does not include the hard drive bracket, cable, or connector board.

Description	Spare part number
Hard drives:	
1-TB, 5400-rpm	778192-005
500-GB, 7200-rpm	703267-005
500-GB, 5400-rpm	778186-005
Hard drive bracket	924980-001

Before removing the hard drive, follow these steps:

1. Shut down the computer. If you are unsure whether the computer is off or in Hibernation, turn the computer on, and then shut it down through the operating system.
2. Disconnect all external devices connected to the computer.
3. Disconnect the power from the computer by first unplugging the power cord from the AC outlet and then unplugging the AC adapter from the computer.
4. Remove the battery (see [Battery on page 30](#)).
5. Remove the optical drive (see [Optical drive on page 31](#)), if installed.
6. Remove the bottom cover (see [Bottom cover on page 38](#)).

To remove the hard drive:

1. Remove the Phillips PM2.0×3.0 screw **(1)** that secures the hard drive assembly to the computer.
2. Lift the rear of the hard drive upward **(2)**.

3. Pull the hard drive assembly away from connector to remove it **(3)**.

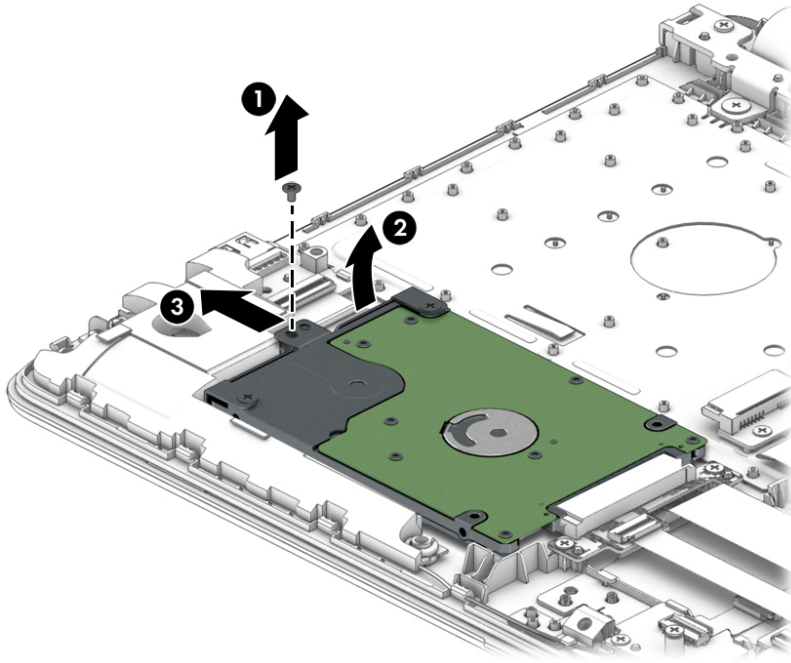

4. To remove the hard drive bracket, remove the two Phillips PM3.0×3.0 screws **(1)** that secure the bracket to the hard drive.
5. Remove the hard drive bracket from the hard drive **(2)**.

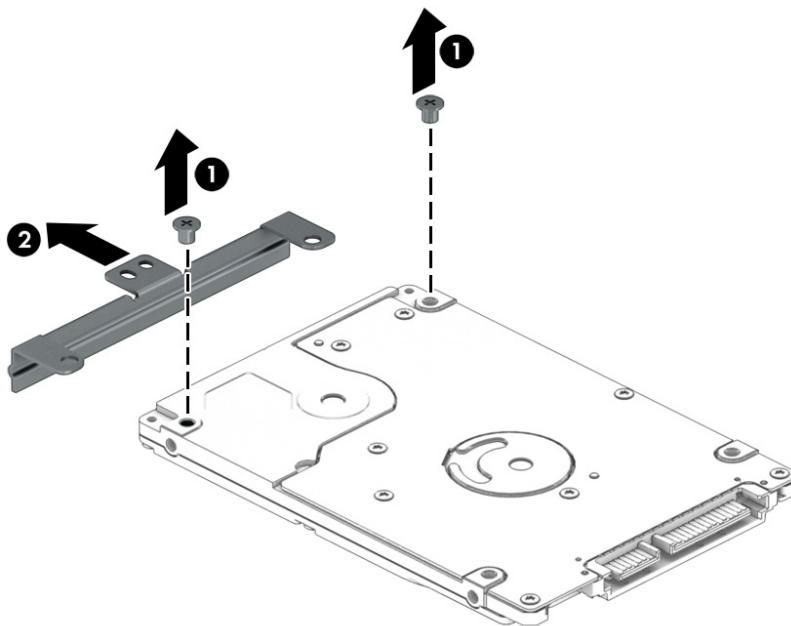

6. To remove the hard drive connector board, disconnect the cable from the board **(1)**.
7. Remove the two Phillips PM2.0×3.0 screws **(2)** that secure the hard drive board to the computer.

8. Remove the hard drive board from the computer **(3)**.

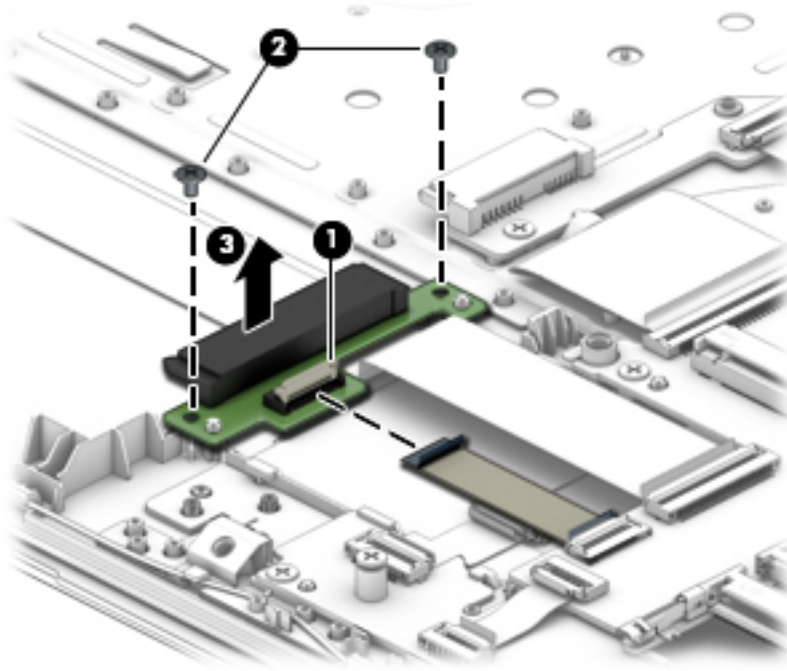

Reverse this procedure to reassemble and install the hard drive.

M.2 solid-state drive adapter bracket and connector board



NOTE: You can install an M.2 solid-state drive into the hard drive bay using an adapter bracket and connector board.

Description	Spare part number
Solid-state drive board	924992-001
Solid-state drive bracket	924981-001

Before removing the solid-state drive adapter bracket and connector board, follow these steps:

1. Shut down the computer. If you are unsure whether the computer is off or in Hibernation, turn the computer on, and then shut it down through the operating system.
2. Disconnect all external devices connected to the computer.
3. Disconnect the power from the computer by first unplugging the power cord from the AC outlet and then unplugging the AC adapter from the computer.
4. Remove the battery (see [Battery on page 30](#)).
5. Remove the optical drive (see [Optical drive on page 31](#)), if installed.
6. Remove the bottom cover (see [Bottom cover on page 38](#)).

To remove the solid-state drive adapter bracket and connector board:

1. Disconnect the cable from the connector board **(1)**.
2. Remove the two Phillips PM2.0×3.0 screws **(2)** that secure the connector board to the computer.
3. Lift the connector board out of the computer **(3)**.
4. Remove the Phillips PM2.0×3.0 screw **(4)** that secures the adapter bracket to the computer.

5. Lift the adapter bracket out of the computer (5)

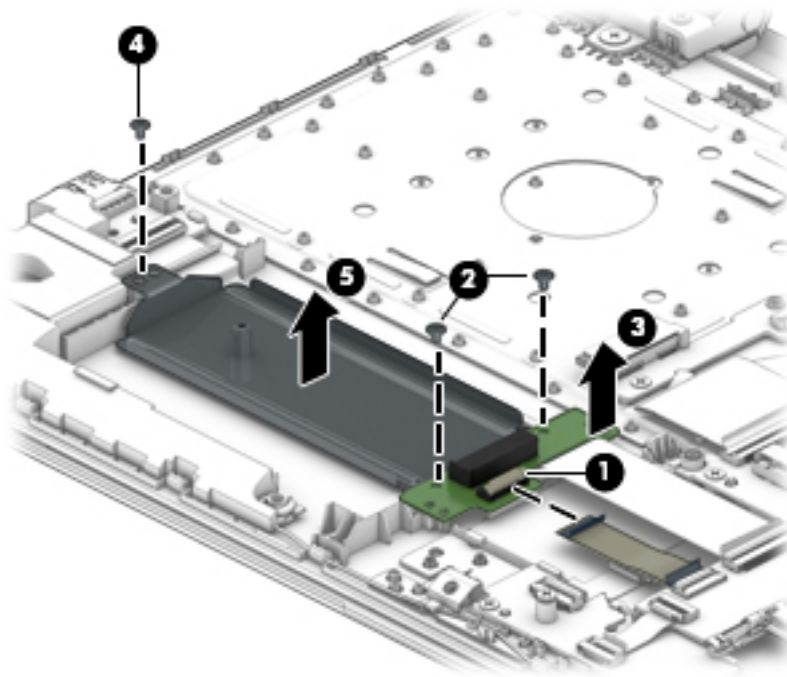

Reverse this procedure to reassemble and install the solid-state drive adapter bracket and connector board.

Solid-state drive (SSD)

Description	Spare part number
256 GB	926271-001
128 GB	926270-001

Before removing the solid-state drive, follow these steps:

1. Shut down the computer. If you are unsure whether the computer is off or in Hibernation, turn the computer on, and then shut it down through the operating system.
2. Disconnect all external devices connected to the computer.
3. Disconnect the power from the computer by first unplugging the power cord from the AC outlet and then unplugging the AC adapter from the computer.
4. Remove the battery (see [Battery on page 30](#)).
5. Remove the optical drive (see [Optical drive on page 31](#)), if installed.
6. Remove the bottom cover (see [Bottom cover on page 38](#)).

Remove the solid-state drive:

1. Remove the Phillips PM2.0×2.0 screw **(1)** that secures the drive to the system board.
2. Remove the drive **(2)** by pulling it away from the connector.

 **NOTE:** Solid-state drives are designed with notches to prevent incorrect insertion.

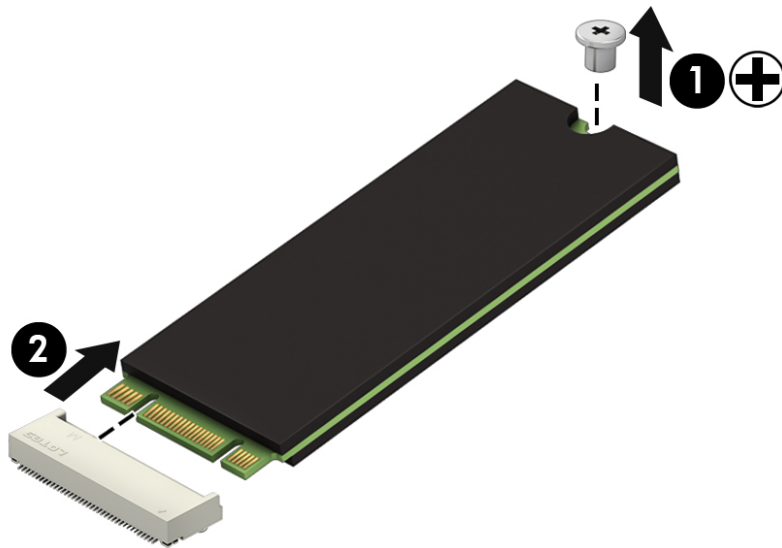

Reverse this procedure to reassemble and install the solid-state drive.

RTC battery

Description	Spare part number
RTC battery	922847-001

Before removing the RTC battery, follow these steps:

1. Shut down the computer. If you are unsure whether the computer is off or in Hibernation, turn the computer on, and then shut it down through the operating system.
2. Disconnect all external devices connected to the computer.
3. Disconnect the power from the computer by first unplugging the power cord from the AC outlet and then unplugging the AC adapter from the computer.
4. Remove the battery (see [Battery on page 30](#)).
5. Remove the optical drive (see [Optical drive on page 31](#)), if installed.
6. Remove the bottom cover (see [Bottom cover on page 38](#)).

To remove the RTC battery:

- ▲ Using a thin tool or screwdriver, disengage the battery from the socket **(1)**, and then remove the battery **(2)**.

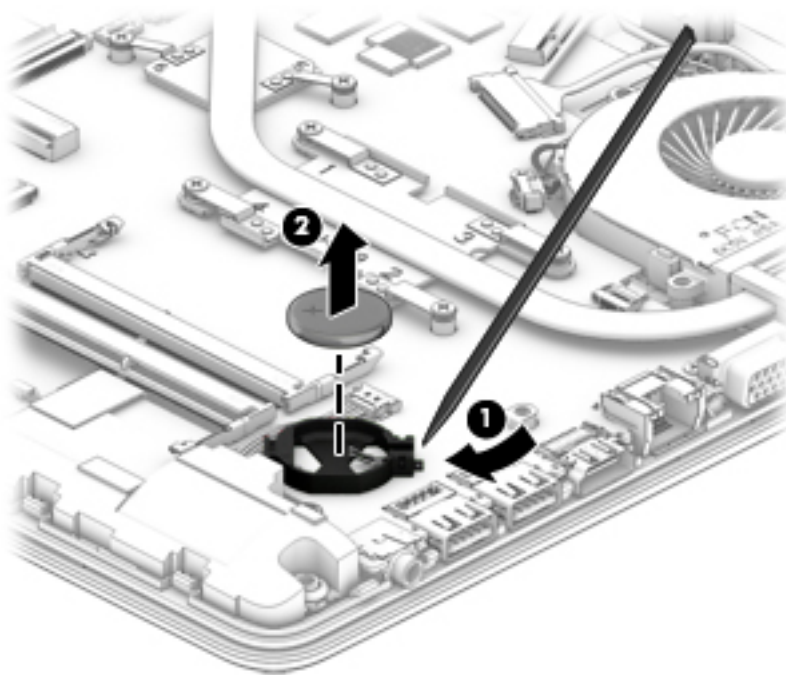

Reverse this procedure to install the RTC battery.

Speakers

Description	Spare part number
Speakers (includes left and right speakers and cable)	925306-001

Before removing the speakers, follow these steps:

1. Shut down the computer. If you are unsure whether the computer is off or in Hibernation, turn the computer on, and then shut it down through the operating system.
2. Disconnect all external devices connected to the computer.
3. Disconnect the power from the computer by first unplugging the power cord from the AC outlet and then unplugging the AC adapter from the computer.
4. Remove the battery (see [Battery on page 30](#)).
5. Remove the optical drive (see [Optical drive on page 31](#)), if installed.
6. Remove the bottom cover (see [Bottom cover on page 38](#)).

To remove the speakers:

1. Disconnect the speaker cable from the system board **(1)**.
2. Remove the cable from its routing path along the bottom of the computer **(2)**, and then lift up and remove the speakers from the computer **(3)**.

 **NOTE:** The speakers are not secured with screws. Note the rubber gaskets **(4)** that help secure the speakers to the computer. When installing the speakers, make sure the gaskets are installed correctly.



Reverse this procedure to install the speakers.

USB board

Description	Spare part number
USB board	924991-001
USB board cable	924929-001

Before removing the USB board, follow these steps:

1. Shut down the computer. If you are unsure whether the computer is off or in Hibernation, turn the computer on, and then shut it down through the operating system.
2. Disconnect all external devices connected to the computer.
3. Disconnect the power from the computer by first unplugging the power cord from the AC outlet and then unplugging the AC adapter from the computer.
4. Remove the battery (see [Battery on page 30](#)).
5. Remove the optical drive (see [Optical drive on page 31](#)), if installed.
6. Remove the bottom cover (see [Bottom cover on page 38](#)).
7. Remove the speakers (see [Speakers on page 52](#)).

To remove the USB board:

1. Disconnect the USB board cable from the USB board **(1)**.
2. Remove the Phillips PM2.0×3.0 screw **(2)** that secures the USB board to the computer.
3. Remove the USB board **(3)**.

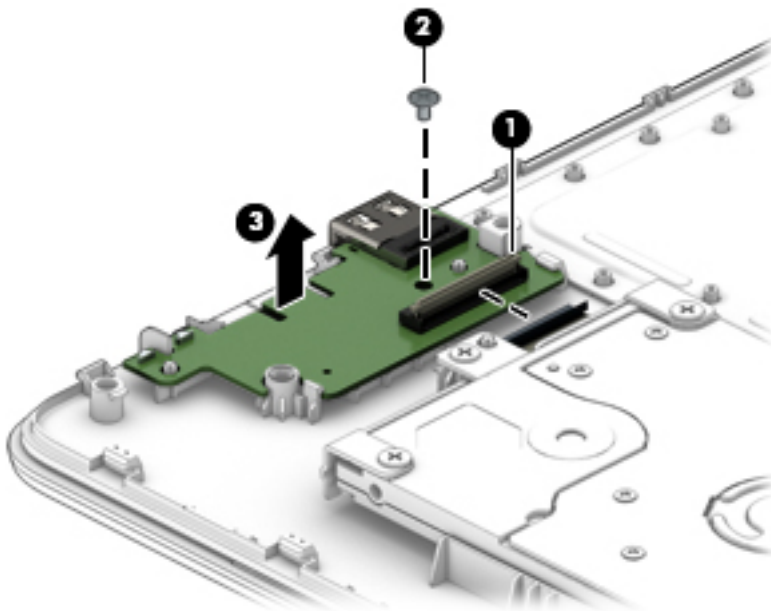

Reverse this procedure to install the USB board.

Fan

Description	Spare part number
Fan	925012-001



NOTE: To properly ventilate the computer, allow at least **7.6 cm** (3.0 in) of clearance on the left side of the computer. The computer uses an electric fan for ventilation. The fan is controlled by a temperature sensor and is designed to turn on automatically when high temperature conditions exist. These conditions are affected by high external temperatures, system power consumption, power management/battery conservation configurations, battery fast charging, and software requirements. Exhaust air is displaced through the ventilation grill located on the left side of the computer.

Before removing the fan/heat sink assembly, follow these steps:

1. Shut down the computer. If you are unsure whether the computer is off or in Hibernation, turn the computer on, and then shut it down through the operating system.
2. Disconnect all external devices connected to the computer.
3. Disconnect the power from the computer by first unplugging the power cord from the AC outlet and then unplugging the AC adapter from the computer.
4. Remove the battery (see [Battery on page 30](#)).
5. Remove the optical drive (see [Optical drive on page 31](#)), if installed.
6. Remove the bottom cover (see [Bottom cover on page 38](#)).

To remove the fan:

1. Lift the cables (antenna, display, power connector) from atop the screw **(1)**.
2. Disconnect the fan cable **(2)** from the system board.
3. Remove the Phillips PM2.5×6.5 screw **(3)** that secures the fan to the computer.

4. Remove the fan from the computer (4).

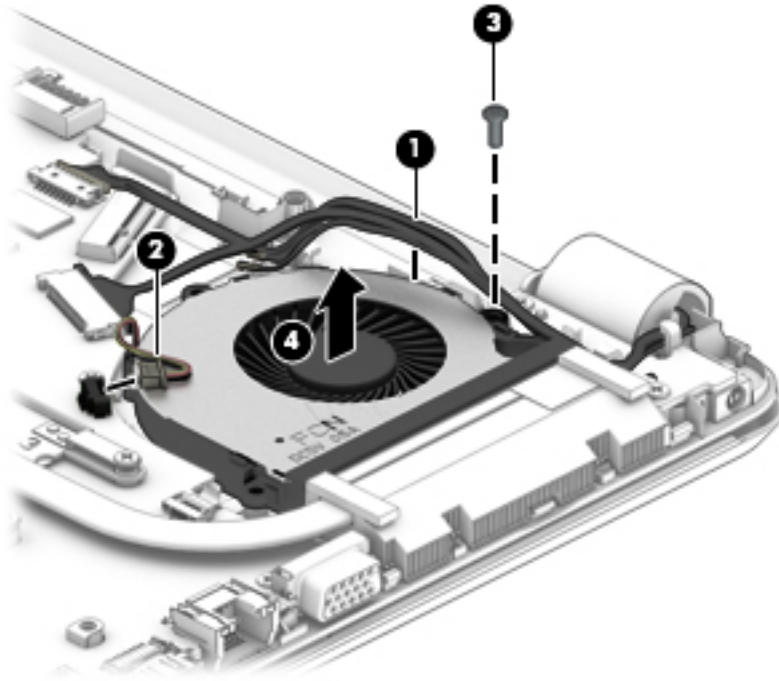

Reverse this procedure to install the fan.

Heat sink assembly

 **NOTE:** The heat sink assembly spare part kit includes replacement thermal materials.

Description	Spare part number
Heat sink for use in models with UMA graphics and AMD dual core, 6 W processors	925019-001
Heat sink for use in models with UMA graphics and AMD dual core, 15 W processors	925020-001
Heat sink for use in models with UMA graphics memory and AMD quad core processors	925017-001
Heat sink for use in models with discrete graphics memory and AMD dual core processors	925021-001
Heat sink for use in models with discrete graphics memory and AMD quad core processors	925018-001

 **NOTE:** To properly ventilate the computer, allow at least **7.6 cm (3.0 in)** of clearance on the left side of the computer. The computer uses an electric fan for ventilation. The fan is controlled by a temperature sensor and is designed to turn on automatically when high temperature conditions exist. These conditions are affected by high external temperatures, system power consumption, power management/battery conservation configurations, battery fast charging, and software requirements. Exhaust air is displaced through the ventilation grill located on the left side of the computer.

Before removing the heat sink assembly, follow these steps:

1. Shut down the computer. If you are unsure whether the computer is off or in Hibernation, turn the computer on, and then shut it down through the operating system.
2. Disconnect all external devices connected to the computer.
3. Disconnect the power from the computer by first unplugging the power cord from the AC outlet and then unplugging the AC adapter from the computer.
4. Remove the battery (see [Battery on page 30](#)).
5. Remove the optical drive (see [Optical drive on page 31](#)), if installed.
6. Remove the bottom cover (see [Bottom cover on page 38](#)).

To remove the heat sink assembly:

1. Refer to the following heat sink removal image that matches your computer.
2. In the order indicated on the heat sink, remove the screws that secure the heat sink assembly to the system board.
3. Remove the heat sink assembly from the system board.

 **NOTE:** Heat sink appearance may vary.

Discrete graphics

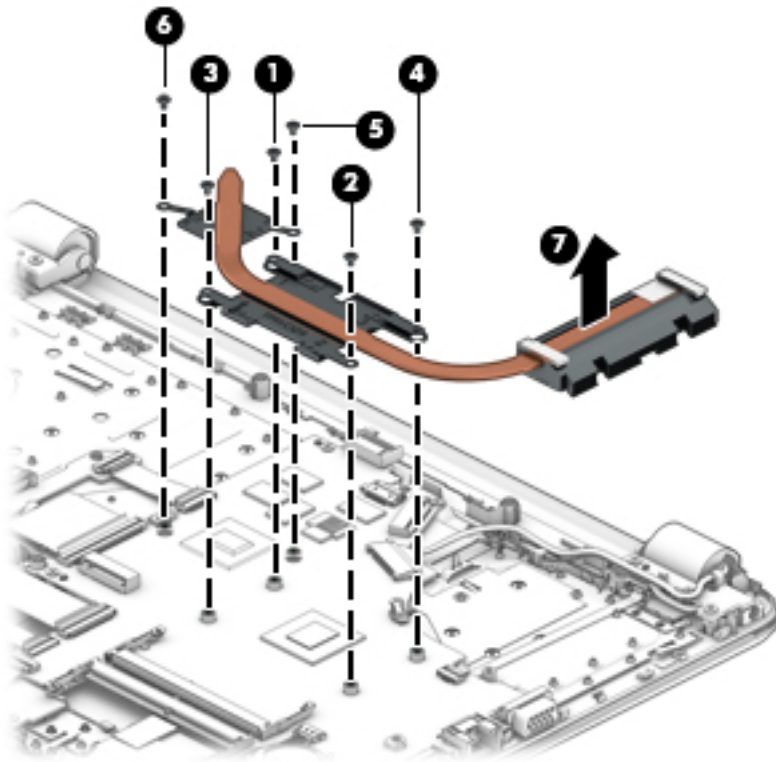

- **Discrete graphics** Thermal paste is used on the processor and associated heat sink area **(1)(2)**, as well as the graphics chip and associated heat sink area **(3)(4)**.

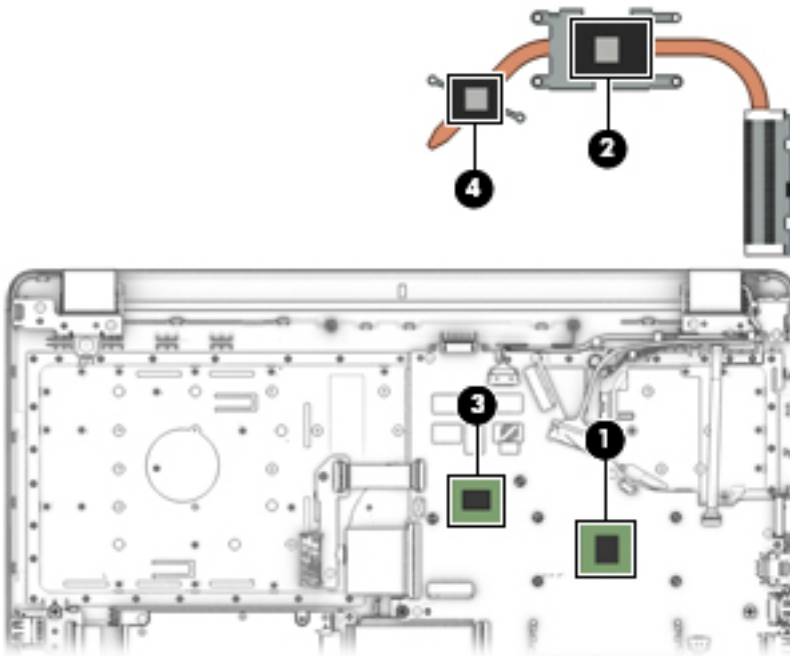

4. UMA graphics

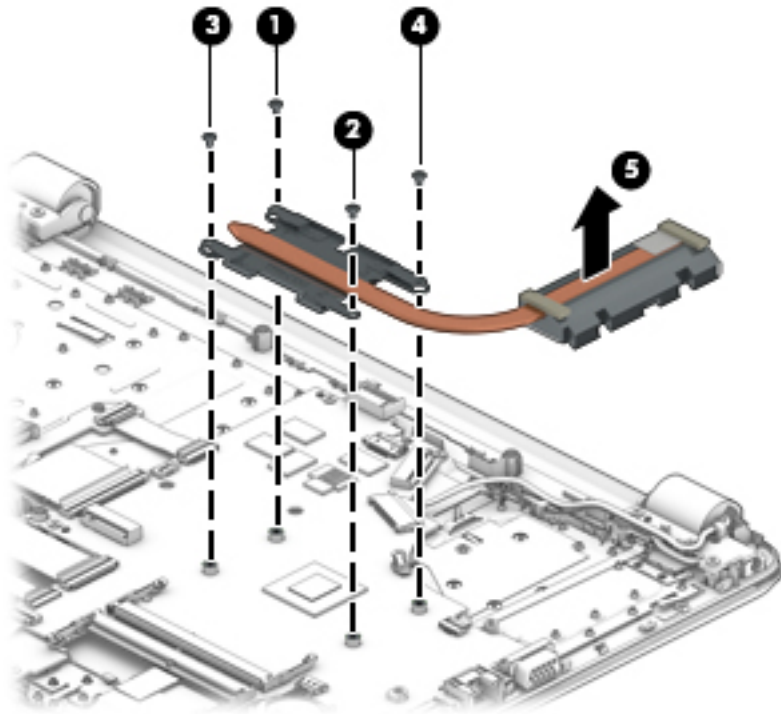

- **UMA graphics** Thermal paste is used on the heat sink (1) and the processor (2).

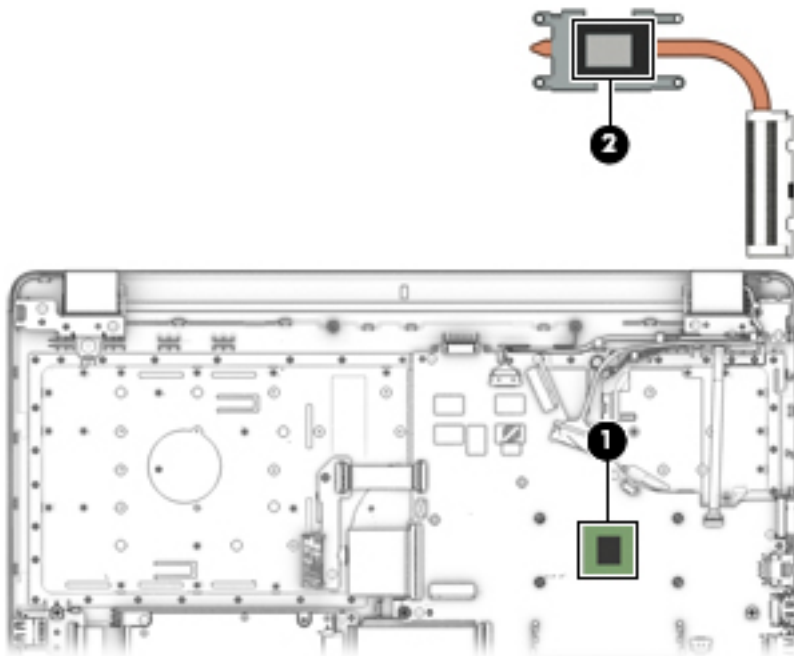

5. **UMA graphics (fanless)**

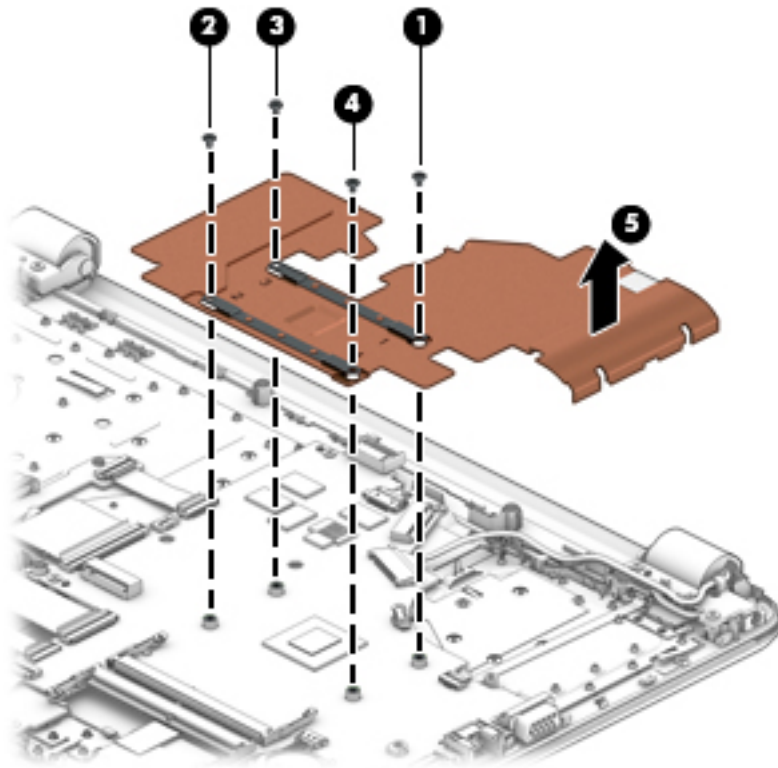

- **UMA graphics (fanless)** Thermal paste is used on the heat sink (1) and the processor (2).

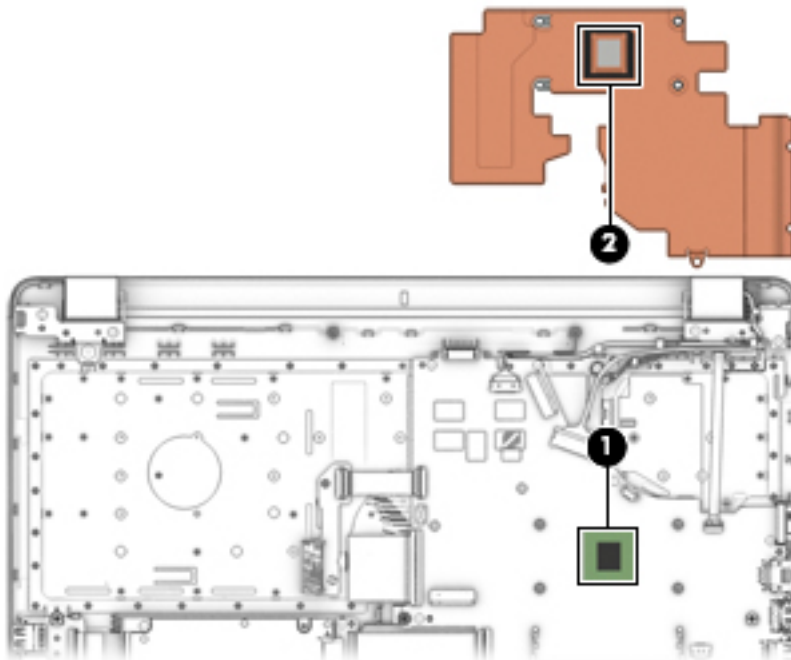

Reverse this procedure to reassemble and install the heat sink assembly.

TouchPad button board

Description	Spare part number
TouchPad button board	924993-001
TouchPad button board cable	924934-001
TouchPad cable	924928-001

Before removing the TouchPad button board, follow these steps:

1. Shut down the computer. If you are unsure whether the computer is off or in Hibernation, turn the computer on, and then shut it down through the operating system.
2. Disconnect all external devices connected to the computer.
3. Disconnect the power from the computer by first unplugging the power cord from the AC outlet and then unplugging the AC adapter from the computer.
4. Remove the battery (see [Battery on page 30](#)).
5. Remove the optical drive (see [Optical drive on page 31](#)), if installed.
6. Remove the bottom cover (see [Bottom cover on page 38](#)).

To remove the TouchPad button board:

1. Disconnect the system board cable (1) and the TouchPad cable from the TouchPad button board (2).
2. Remove the two Phillips PM2.0×3.0 screws (3) that secure the TouchPad button board to the computer.
3. Pull the TouchPad button board toward the bottom of the computer, and then remove the TouchPad button board (4).

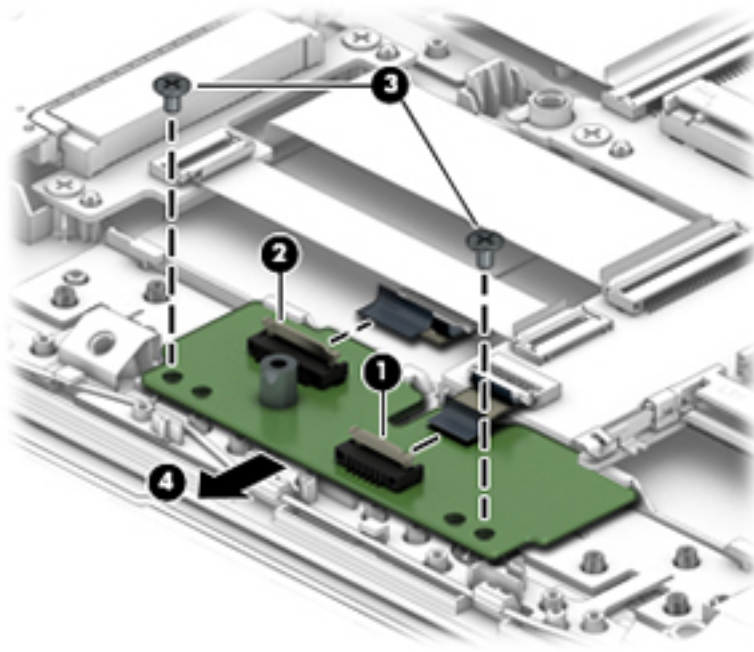

Reverse this procedure to install the TouchPad button board.

System board



NOTE: The system board spare part kit includes replacement thermal materials.

Description	Spare part number
System board (includes replacement thermal materials):	
All system boards use the following part numbers:	
xxxxxx-001: Non-Windows operating systems	
xxxxxx-601: Windows 10 operating system	
AMD A6-9220P processor	926268-xx1
AMD E2-9000e processor	926269-xx1

Before removing the system board, follow these steps:

1. Shut down the computer. If you are unsure whether the computer is off or in Hibernation, turn the computer on, and then shut it down through the operating system.
2. Disconnect all external devices connected to the computer.
3. Disconnect the power from the computer by first unplugging the power cord from the AC outlet and then unplugging the AC adapter from the computer.
4. Remove the battery (see [Battery on page 30](#)).
5. Remove the optical drive (see [Optical drive on page 31](#)), if installed.
6. Remove the bottom cover (see [Bottom cover on page 38](#)).
7. Remove the WLAN module (see [WLAN module on page 41](#)).
8. Remove the memory module (see [Memory module on page 43](#)).
9. Remove the solid-state drive (see [Solid-state drive \(SSD\) on page 50](#)).

To remove the system board:

1. Position the computer upright, and then disconnect the following cables from the system board:
 - (1): Power connector cable
 - (2): Display cable
 - (3): Power button board cable
 - (4): Speaker cable
 - (5): TouchPad cable
 - (6): Hard drive connector cable
 - (7): USB board cable
 - (8): Keyboard cable
 - (9): Optical drive board cable

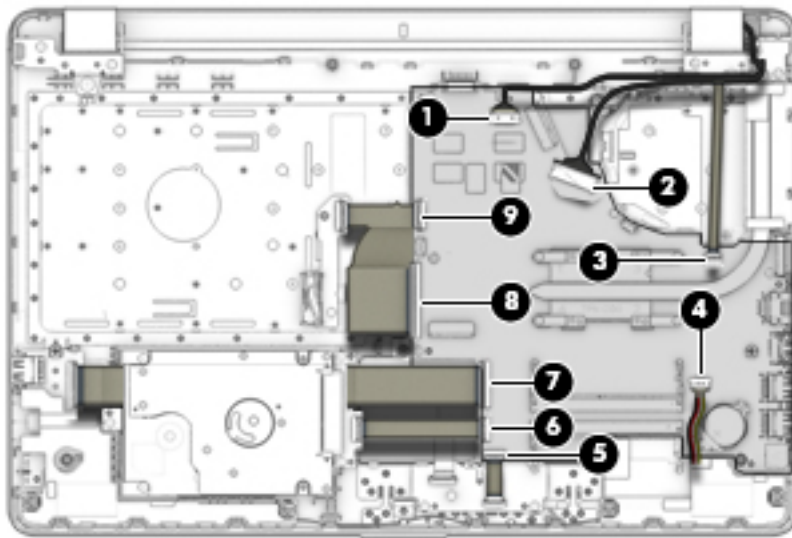

2. Remove the six Phillips PM2.0×3.0 screws (1) that secure the system board to the computer.
3. Rotate the side of the board upward (2), and then lift the system board out of the computer (3).

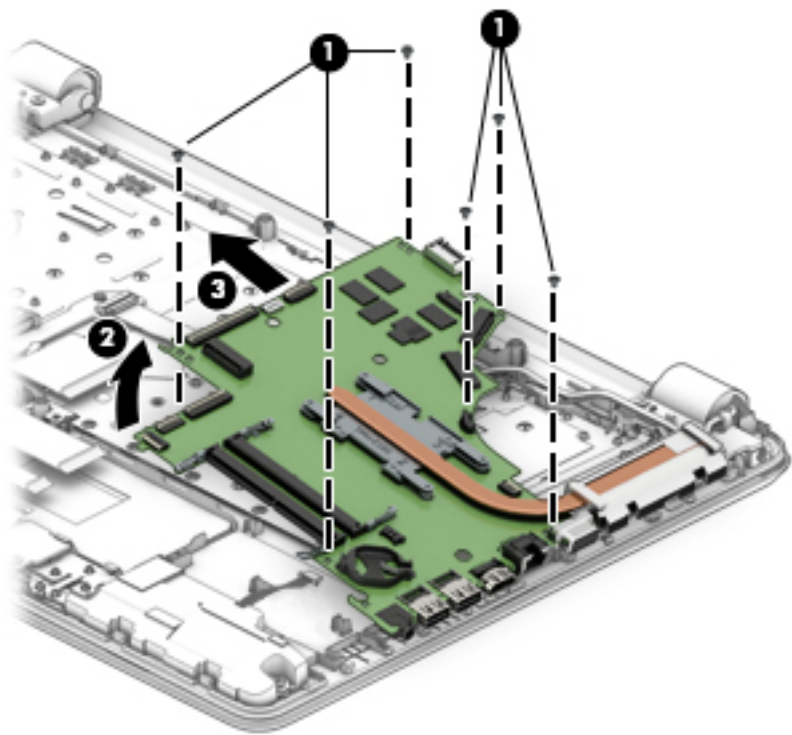

Reverse this procedure to install the system board.

Display assembly

This section describes removing the display assembly and disassembling display subcomponents. You must remove the display from the computer to disassemble display subcomponents.

Before removing the display assembly, follow these steps:

1. Shut down the computer. If you are unsure whether the computer is off or in Hibernation, turn the computer on, and then shut it down through the operating system.
2. Disconnect all external devices connected to the computer.
3. Disconnect the power from the computer by first unplugging the power cord from the AC outlet and then unplugging the AC adapter from the computer.
4. Remove the battery (see [Battery on page 30](#)).
5. Remove the optical drive (see [Optical drive on page 31](#)), if installed.
6. Remove the bottom cover (see [Bottom cover on page 38](#)).
7. Remove the fan (see [Fan on page 54](#)).

To remove the display assembly:

1. Disconnect the display panel cable from the system board **(1)**.
2. Disconnect the wireless antennas from the WLAN module **(2)**.
3. Remove the four Phillips PM2.5×6.0 screws **(3)** (two from each hinge) and one broadhead Phillips PM2.0×2.0 screw **(4)** (on the left hinge) that secures the display assembly to the computer.
4. Lift the display to bend the hinges upward **(5)**.

5. Separate the display from the computer (6).

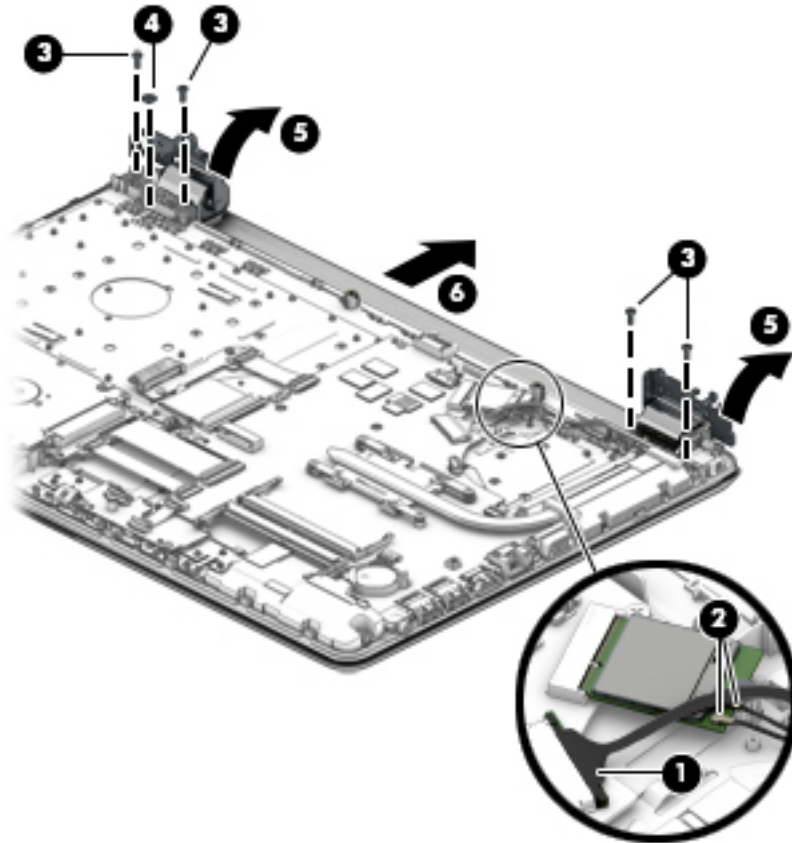

If it is necessary to replace any of the display assembly subcomponents:

1. To remove the display bezel:
 - a. Flex the inside of the top edge (1), the left and right edges (2), and the bottom edge (3) of the display bezel until the bezel disengages from the display enclosure.

 **NOTE:** When removing the bezel from the bottom of the display (3), be careful not to peel the Mylar from the bottom of the display panel.

- b.** Remove the display bezel **(4)**.

 **NOTE:** The display will not be connected to the computer as shown in the following image.

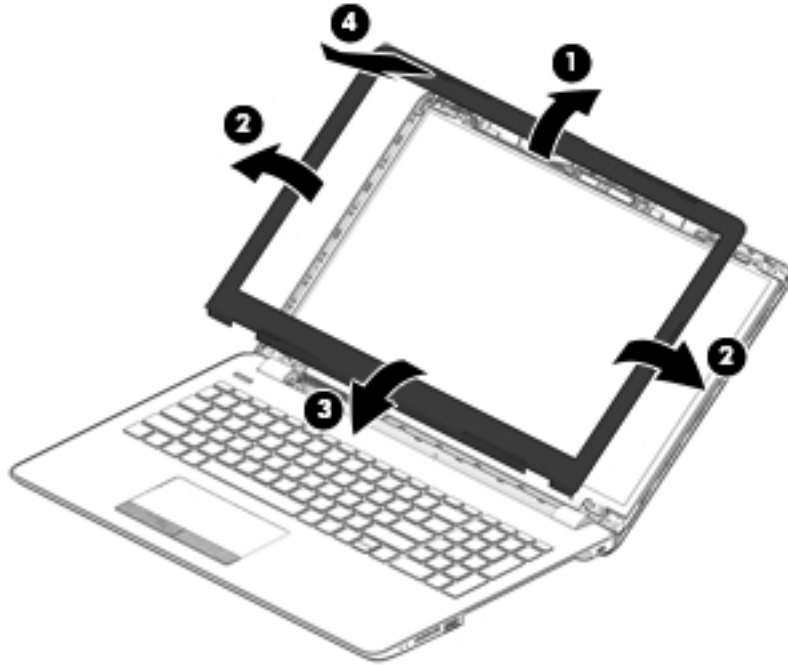

- 2.** To remove the camera/microphone module:
 - a.** Position the display assembly with the top edge toward you.
 - b.** Pry up to disengage the camera/microphone module from the adhesive that secures it to the display **(1)**.
 - c.** Disconnect the cable **(2)** from the module.

- d. Remove the tape from the enclosure **(3)**. Replacement cameras come with tape already installed.

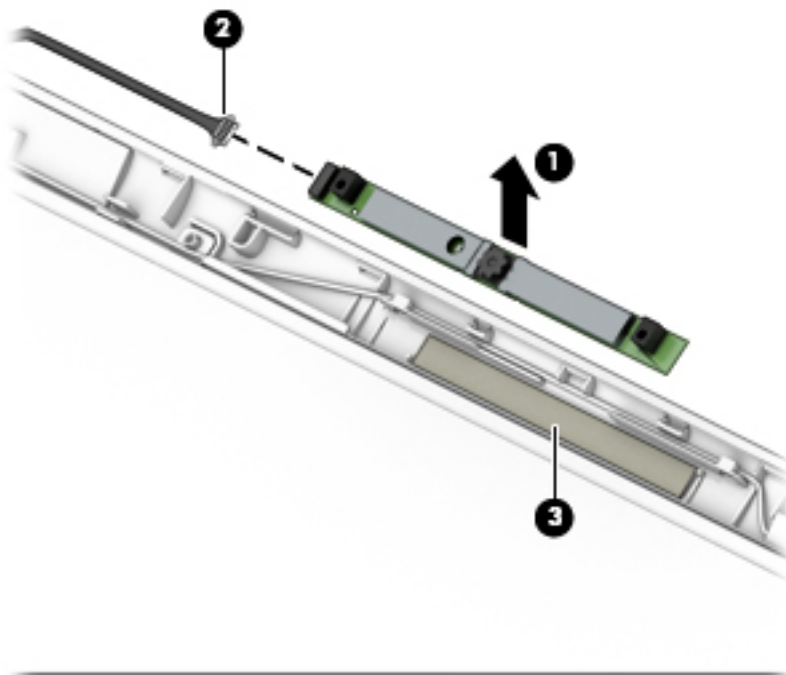

3. To remove the display panel:

- a. Remove the four Phillips PM2.0×3.0 screws **(1)** that secure the display panel to the top of the enclosure.
- b. Remove the two Phillips PM2.0×3.0 screws **(2)** that secure the display panel to the bottom of the enclosure.
- c. Lift the hinges up and move aside enough to be able to rotate the panel up and over **(3)**.

- d. Rotate the display panel onto the keyboard (4) to gain access to the display cable connection on the back of the panel.

 **NOTE:** The display will not be connected to the computer as shown in the following image.

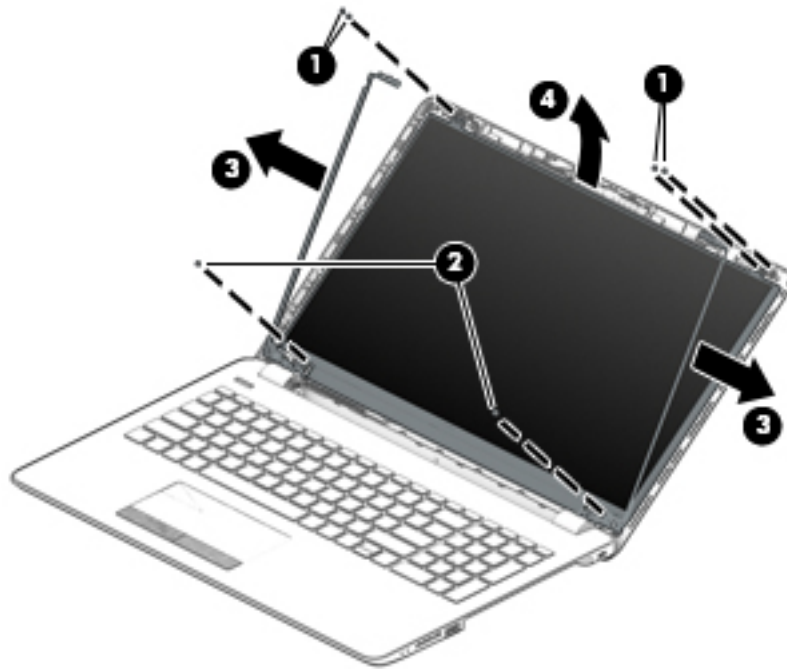

- e. On the back of the display panel, release the adhesive strip that secures the display panel cable to the display panel, and then disconnect the cable (1).
- f. Remove the display panel from the computer (2).

 **NOTE:** The display will not be connected to the computer as shown in the following image.

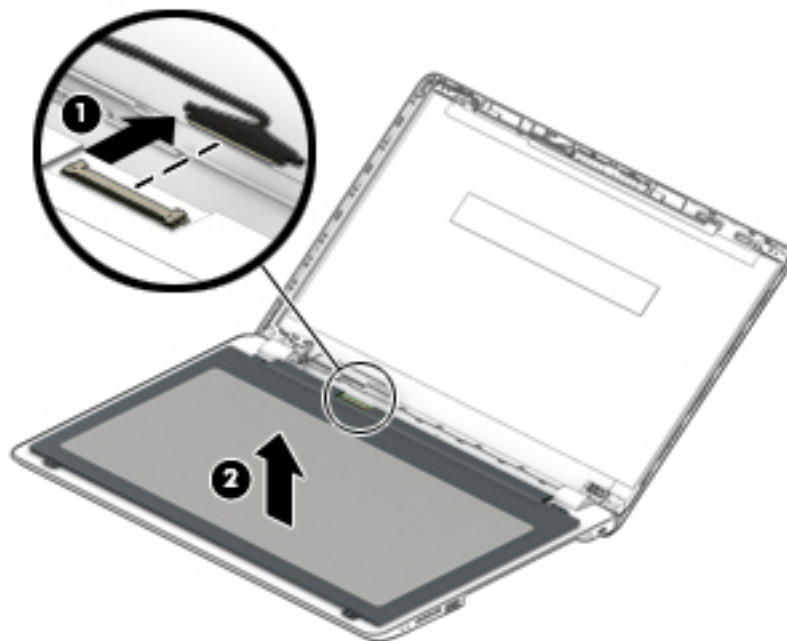

- 4. To remove the display hinges:

- a. Remove the Phillips PM2.0×3.0 screw **(1)** that secures each hinge cover to the display enclosure.
- b. Slide the left hinge cover toward the left and remove while threading the cable through the hinge cover **(2)**.
- c. Slide the right hinge cover toward the right to remove **(3)**.

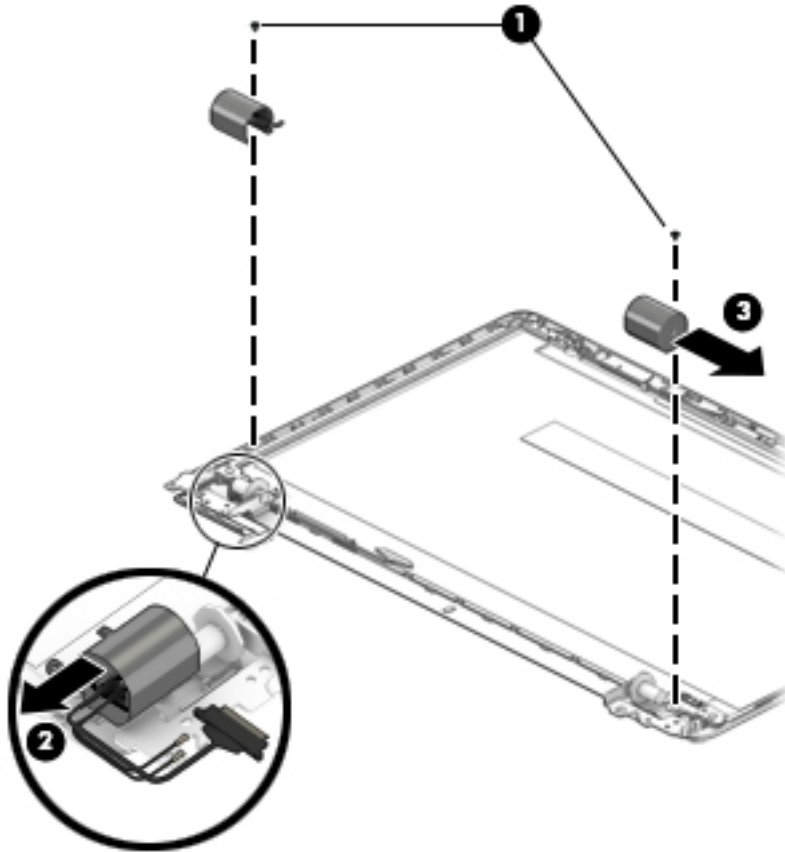

- d. Remove the two broadhead Phillips PM2.5×2.5 screws **(1)** and the broadhead PM2.5×3.0 screw **(2)** that secure each hinge to the bottom of the display enclosure.

e. Remove the display hinges (3).

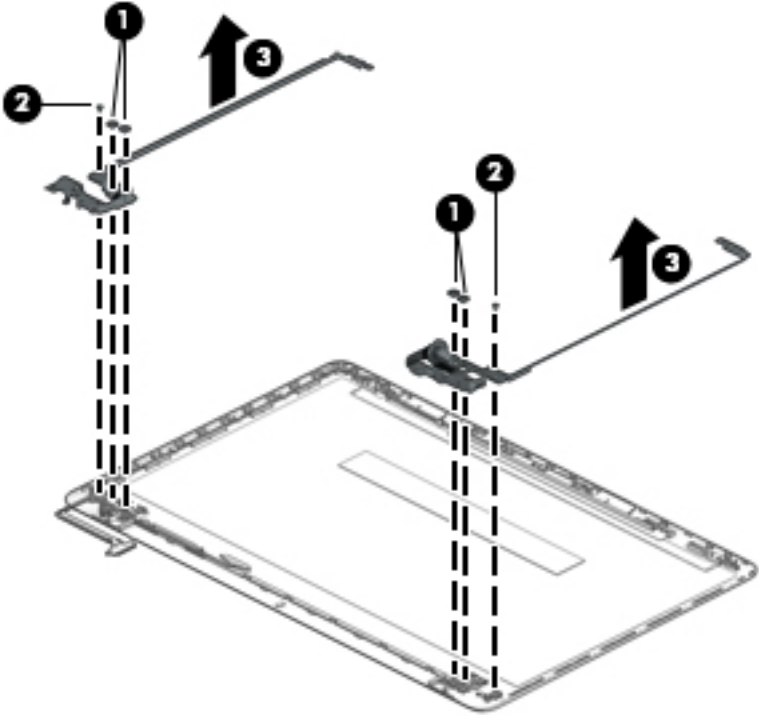

5. To remove the wireless antennas and cables, release the cables from the clips built into the side of the display enclosure (1), and then remove the antennas and cables (2).

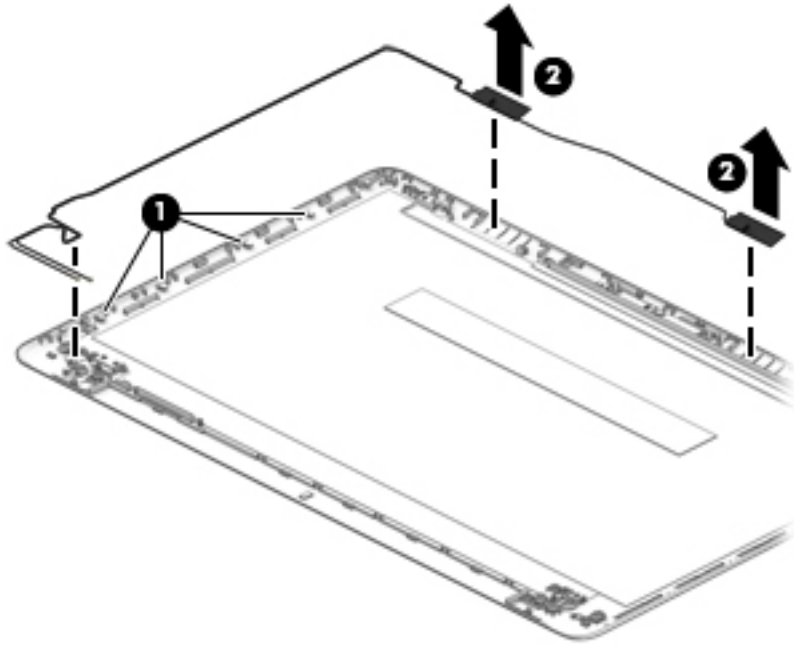

When installing the antennas, use the following image to determine correct installation locations at the top of the display enclosure.

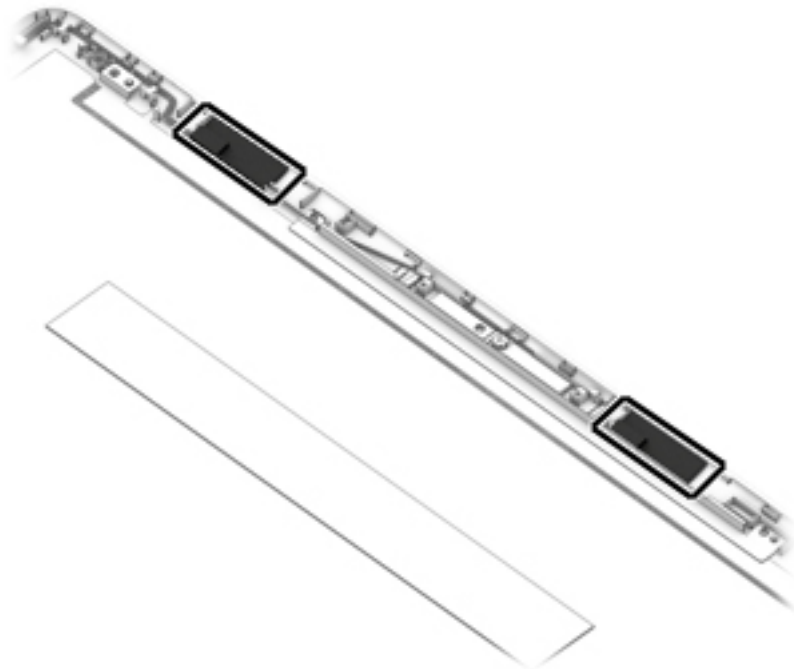

6. To remove the display/camera cable, remove the cable from the clips built into the side of the display enclosure (1), and then remove the cable from the display enclosure (2).

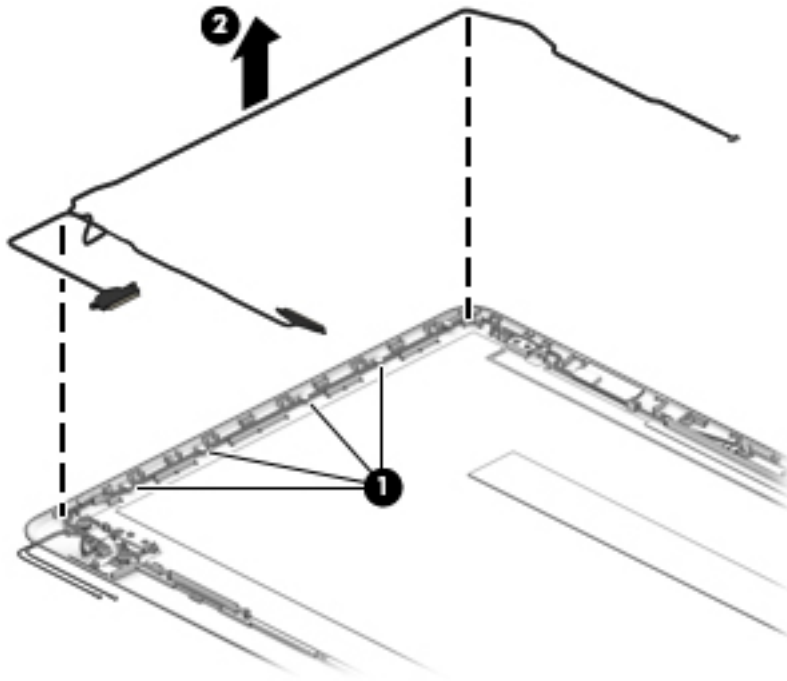

7. Use the following image to determine proper cable routing around the left hinge for the camera/display cable and the wireless antenna cables.

(1): Camera cable routing path

(2): Display/camera cable routing path

(3): Antenna cable routing path

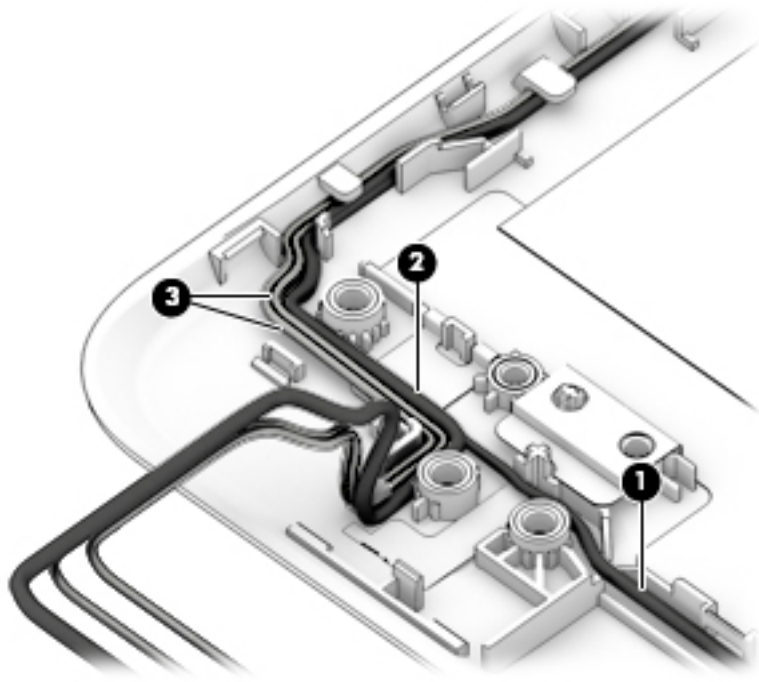

8. If replacing the display enclosure, be sure that the subcomponents (including the camera/microphone module, the antenna receivers, and all associated cables and hardware) are transferred to the new enclosure.

Reverse this procedure to reassemble and install the display assembly.

Power connector cable

Description	Spare part number
Power connector cable	931613-001

Before removing the power connector cable, follow these steps:

1. Shut down the computer. If you are unsure whether the computer is off or in Hibernation, turn the computer on, and then shut it down through the operating system.
2. Disconnect all external devices connected to the computer.
3. Disconnect the power from the computer by first unplugging the power cord from the AC outlet and then unplugging the AC adapter from the computer.
4. Remove the battery (see [Battery on page 30](#)).
5. Remove the optical drive (see [Optical drive on page 31](#)), if installed.
6. Remove the bottom cover (see [Bottom cover on page 38](#)).
7. Remove the display (see [Display assembly on page 63](#)).

To remove the power connector cable:

1. Disconnect the power connector cable from the system board **(1)**.
2. Remove the cable from its routing path in the computer **(2)**.
3. Use a tool to pry the connector out of the computer **(3)**, and then remove the power connector cable **(4)**.

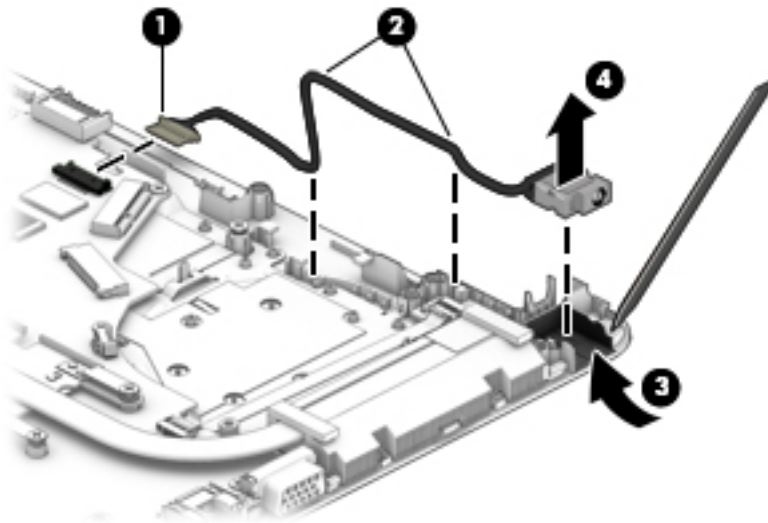

Reverse this procedure to install the power connector cable.

Power button board

Description	Spare part number
Power button board	924994-001
Power button board cable	924933-001

Before removing the power button board, follow these steps:

1. Shut down the computer. If you are unsure whether the computer is off or in Hibernation, turn the computer on, and then shut it down through the operating system.
2. Disconnect all external devices connected to the computer.
3. Disconnect the power from the computer by first unplugging the power cord from the AC outlet and then unplugging the AC adapter from the computer.
4. Remove the battery (see [Battery on page 30](#)).
5. Remove the optical drive (see [Optical drive on page 31](#)), if installed.
6. Remove the bottom cover (see [Bottom cover on page 38](#)).
7. Remove the display (see [Display assembly on page 63](#)).

To remove the power button board:

1. Disconnect the cable from the power button board **(1)**.
2. Remove the Phillips PM2.0×2.0 screw **(2)** that secures the power button board to the computer.
3. Remove the power button board from the computer **(3)**.

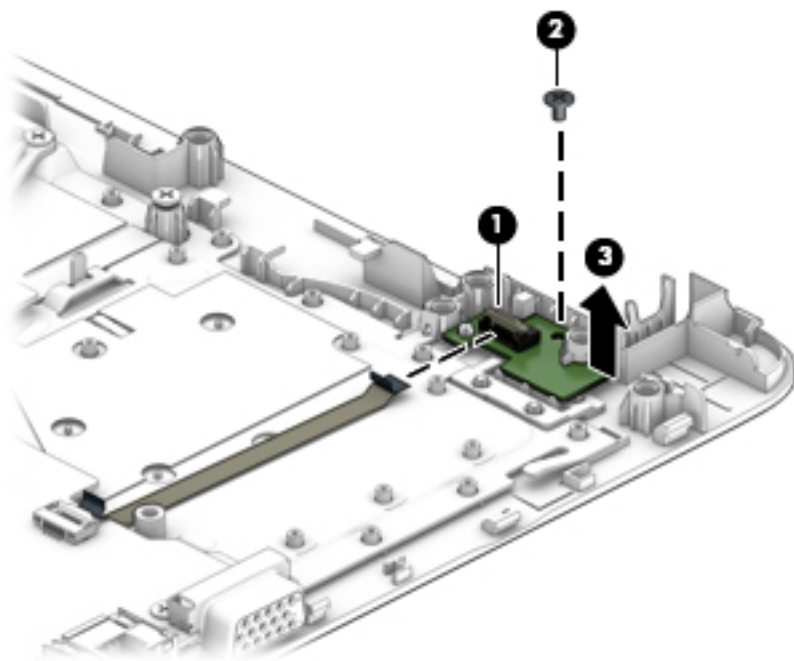

Reverse this procedure to install the power button board and cable.

Cable locations

Description	Spare part number
TouchPad cable	924928-001
Hard drive cable	924927-001
USB board cable	924929-001
Optical drive connector board cable	924926-001
Power button board cable	924933-001

Use the following image to determine properly cable location and routing.

- (1)** TouchPad cable
- (2)** Hard drive cable
- (3)** USB board cable
- (4)** Optical drive connector board cable
- (5)** Power button board cable

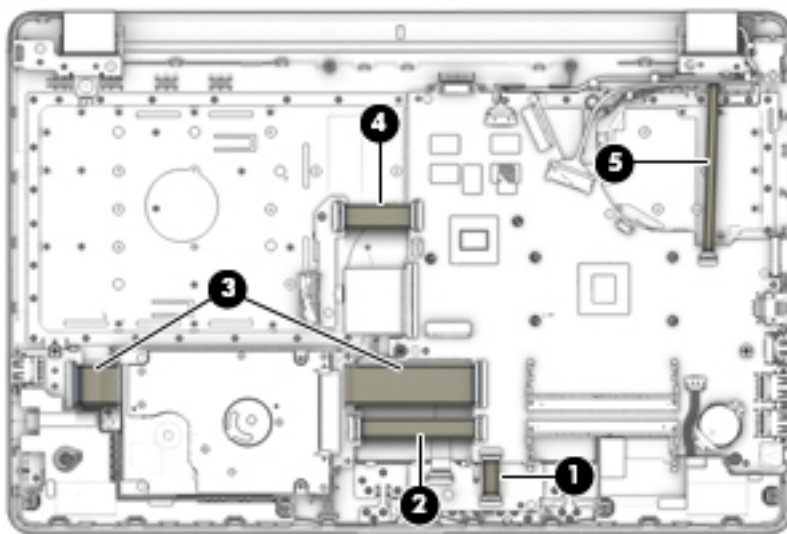

Top cover/keyboard

The top cover/keyboard spare part remains after all other spare parts have been removed.

The top cover/keyboard spare part kit includes the keyboard, keyboard cable and the keyboard backlight cable (if equipped).

In this section, the first table provides the main spare part number for the keyboard. The second table provides the country codes.



NOTE: All top cover/keyboard spare part kits include TouchPad.

Description	Spare part number
Asteroid silver models with no backlight	929904-xxx
Dark ash silver models with no backlight	929906-xxx

For use in country or region	Spare part number	For use in country or region	Spare part number	For use in country or region	Spare part number
Belgium	-A41	India	-002	Slovenia	-BA1
Bulgaria	-261	Italy	-061	South Korea	-AD1
Canada	-DB1	Latin America	-161	Spain	-071
Czech Republic and Slovakia	-FL1	Japan	-291	Switzerland	-BG1
Denmark, Finland, and Norway	-DH1	The Netherlands	-B31	Taiwan	-AB1
France	-051	Portugal	-131	Thailand	-281
Germany	-041	Romania	-271	Turkey	-141
Greece	-151	Russia	-251	United Kingdom	-031
Hungary	-211	Saudi Arabia	-171	United States	-001

7 Using Setup Utility (BIOS)

Setup Utility, or Basic Input/Output System (BIOS), controls communication between all the input and output devices on the system (such as disk drives, display, keyboard, mouse, and printer). Setup Utility (BIOS) includes settings for the types of devices installed, the startup sequence of the computer, and the amount of system and extended memory.

 **NOTE:** To start Setup Utility on convertible computers, your computer must be in notebook mode and you must use the keyboard attached to your notebook.

Starting Setup Utility (BIOS)

 **CAUTION:** Use extreme care when making changes in Setup Utility (BIOS). Errors can prevent the computer from operating properly.

- ▲ Turn on or restart the computer, quickly press **esc**, and then press **f10**.

Updating Setup Utility (BIOS)

Updated versions of Setup Utility (BIOS) may be available on the HP website.

Most BIOS updates on the HP website are packaged in compressed files called *SoftPaqs*.

Some download packages contain a file named *Readme.txt*, which contains information regarding installing and troubleshooting the file.

Determining the BIOS version

To decide whether you need to update Setup Utility (BIOS), first determine the BIOS version on your computer.

To reveal the BIOS version information (also known as *ROM date* and *System BIOS*), use one of these options.

- HP Support Assistant
 1. Type `support` in the taskbar search box, and then select the **HP Support Assistant** app.
– or –
Click the question mark icon in the taskbar.
 2. Select **My PC**, and then select **Specifications**.
- Setup Utility (BIOS)
 1. Start Setup Utility (BIOS) (see [Starting Setup Utility \(BIOS\) on page 77](#)).
 2. Select **Main**, select **System Information**, and then make note of the BIOS version.
 3. Select **Exit**, select **No**, and then follow the on-screen instructions.

To check for later BIOS versions, see [Downloading a BIOS update on page 78](#).

Downloading a BIOS update

 **CAUTION:** To reduce the risk of damage to the computer or an unsuccessful installation, download and install a BIOS update only when the computer is connected to reliable external power using the AC adapter. Do not download or install a BIOS update while the computer is running on battery power, docked in an optional docking device, or connected to an optional power source. During the download and installation, follow these instructions:

- Do not disconnect power from the computer by unplugging the power cord from the AC outlet.
- Do not shut down the computer or initiate Sleep.
- Do not insert, remove, connect, or disconnect any device, cable, or cord.

 **NOTE:** If your computer is connected to a network, consult the network administrator before installing any software updates, especially system BIOS updates.

1. Type `support` in the taskbar search box, and then select the **HP Support Assistant** app.
– or –
Click the question mark icon in the taskbar.
2. Click **Updates**, and then click **Check for updates and messages**.
3. Follow the on-screen instructions.
4. At the download area, follow these steps:
 - a. Identify the most recent BIOS update and compare it to the BIOS version currently installed on your computer. If the update is more recent than your BIOS version, make a note of the date, name, or other identifier. You may need this information to locate the update later, after it has been downloaded to your hard drive.
 - b. Follow the on-screen instructions to download your selection to the hard drive.

Make a note of the path to the location on your hard drive where the BIOS update is downloaded. You will need to access this path when you are ready to install the update.

BIOS installation procedures vary. Follow any instructions that appear on the screen after the download is complete. If no instructions appear, follow these steps:

1. Type `file` in the taskbar search box, and then select **File Explorer**.
2. Click your hard drive designation. The hard drive designation is typically Local Disk (C:).
3. Using the hard drive path you recorded earlier, open the folder that contains the update.
4. Double-click the file that has an `.exe` extension (for example, `filename.exe`).

The BIOS installation begins.
5. Complete the installation by following the on-screen instructions.

 **NOTE:** After a message on the screen reports a successful installation, you can delete the downloaded file from your hard drive.

8 Backing up, restoring, and recovering

This chapter provides information about the following processes. The information in the chapter is standard procedure for most products.

- Creating recovery media and backups
- Restoring and recovering your system

For additional information, refer to the HP Support Assistant app.

▲ Type `support` in the taskbar search box, and then select the **HP Support Assistant** app.

– or –

Select the question mark icon in the taskbar.

 **IMPORTANT:** If you will be performing recovery procedures on a tablet, the tablet battery must be at least 70% charged before you start the recovery process.

IMPORTANT: For a tablet with a detachable keyboard, connect the tablet to the keyboard base before beginning any recovery process.

Creating recovery media and backups

The following methods of creating recovery media and backups are available on select products only. Choose the available method according to your computer model.

- Use HP Recovery Manager to create HP Recovery media after you successfully set up the computer. This step creates a backup of the HP Recovery partition on the computer. The backup can be used to reinstall the original operating system in cases where the hard drive is corrupted or has been replaced. For information on creating recovery media, see [Creating HP Recovery media \(select products only\) on page 79](#). For information on the recovery options that are available using the recovery media, see [Using Windows tools on page 80](#).
- Use Windows tools to create system restore points and create backups of personal information.

For more information, see [Recovering using HP Recovery Manager on page 81](#).

 **NOTE:** If storage is 32 GB or less, Microsoft System Restore is disabled by default.

Creating HP Recovery media (select products only)

If possible, check for the presence of the Recovery partition and the Windows partition. From the **Start** menu, select **File Explorer**, and then select **This PC**.

- If your computer does not list the Windows partition and the Recovery partition, you can obtain recovery media for your system from support. See the *Worldwide Telephone Numbers* booklet included with the computer. You can also find contact information on the HP website. Go to <http://www.hp.com/support>, select your country or region, and follow the on-screen instructions.

You can use Windows tools to create system restore points and create backups of personal information, see [Using Windows tools on page 80](#).

- If your computer does list the Recovery partition and the Windows partition, you can use HP Recovery Manager to create recovery media after you successfully set up the computer. HP Recovery media can be used to perform system recovery if the hard drive becomes corrupted. System recovery reinstalls the original operating system and software programs that were installed at the factory and then configures the settings for the programs. HP Recovery media can also be used to customize the system or restore the factory image if you replace the hard drive.
 - Only one set of recovery media can be created. Handle these recovery tools carefully, and keep them in a safe place.
 - HP Recovery Manager examines the computer and determines the required storage capacity for the media that will be required.
 - To create recovery discs, your computer must have an optical drive with DVD writer capability, and you must use only high-quality blank DVD-R, DVD+R, DVD-R DL, or DVD+R DL discs. Do not use rewritable discs such as CD±RW, DVD±RW, double-layer DVD±RW, or BD-RE (rewritable Blu-ray) discs; they are not compatible with HP Recovery Manager software. Or, instead, you can use a high-quality blank USB flash drive.
 - If your computer does not include an integrated optical drive with DVD writer capability, but you would like to create DVD recovery media, you can use an external optical drive (purchased separately) to create recovery discs. If you use an external optical drive, it must be connected directly to a USB port on the computer; the drive cannot be connected to a USB port on an external device, such as a USB hub. If you cannot create DVD media yourself, you can obtain recovery discs for your computer from HP. See the *Worldwide Telephone Numbers* booklet included with the computer. You can also find contact information on the HP website. Go to <http://www.hp.com/support>, select your country or region, and follow the on-screen instructions.
 - Be sure that the computer is connected to AC power before you begin creating the recovery media.
 - The creation process can take an hour or more. Do not interrupt the creation process.
 - If necessary, you can exit the program before you have finished creating all of the recovery DVDs. HP Recovery Manager will finish burning the current DVD. The next time you start HP Recovery Manager, you will be prompted to continue.

To create HP Recovery media:



IMPORTANT: For a tablet with a detachable keyboard, connect the tablet to the keyboard base before beginning these steps.

1. Type `recovery` in the taskbar search box, and then select **HP Recovery Manager**.
2. Select **Create recovery media**, and then follow the on-screen instructions.

If you ever need to recover the system, see [Recovering using HP Recovery Manager on page 81](#).

Using Windows tools

You can create recovery media, system restore points, and backups of personal information using Windows tools.



NOTE: If storage is 32 GB or less, Microsoft System Restore is disabled by default.

For more information and steps, see the Get started app.

- ▲ Select the **Start** button, and then select the **Get started** app.

Restore and recovery

There are several options for recovering your system. Choose the method that best matches your situation and level of expertise:

 **IMPORTANT:** Not all methods are available on all products.

- Windows offers several options for restoring from backup, refreshing the computer, and resetting the computer to its original state. For more information see the Get started app.
 - ▲ Select the **Start** button, and then select the **Get started** app.
- If you need to correct a problem with a preinstalled application or driver, use the Reinstall drivers and/or applications option (select products only) of HP Recovery Manager to reinstall the individual application or driver.
 - ▲ Type `recovery` in the taskbar search box, select **HP Recovery Manager**, select **Reinstall drivers and/or applications**, and then follow the on-screen instructions.
- If you want to recover the Windows partition to original factory content, you can choose the System Recovery option from the HP Recovery partition (select products only) or use the HP Recovery media. For more information, see [Recovering using HP Recovery Manager on page 81](#). If you have not already created recovery media, see [Creating HP Recovery media \(select products only\) on page 79](#).
- On select products, if you want to recover the computer's original factory partition and content, or if you have replaced the hard drive, you can use the Factory Reset option of HP Recovery media. For more information, see [Recovering using HP Recovery Manager on page 81](#).
- On select products, if you want to remove the Recovery partition to reclaim hard drive space, HP Recovery Manager offers the Remove Recovery Partition option.

For more information, see [Removing the HP Recovery partition \(select products only\) on page 84](#).

Recovering using HP Recovery Manager

HP Recovery Manager software allows you to recover the computer to its original factory state by using the HP Recovery media that you either created or that you obtained from HP, or by using the HP Recovery partition (select products only). If you have not already created recovery media, see [Creating HP Recovery media \(select products only\) on page 79](#).

What you need to know before you get started

- HP Recovery Manager recovers only software that was installed at the factory. For software not provided with this computer, you must either download the software from the manufacturer's website or reinstall the software from the media provided by the manufacturer.

 **IMPORTANT:** Recovery through HP Recovery Manager should be used as a final attempt to correct computer issues.

- HP Recovery media must be used if the computer hard drive fails. If you have not already created recovery media, see [Creating HP Recovery media \(select products only\) on page 79](#).
- To use the Factory Reset option (select products only), you must use HP Recovery media. If you have not already created recovery media, see [Creating HP Recovery media \(select products only\) on page 79](#).
- If your computer does not allow the creation of HP Recovery media or if the HP Recovery media does not work, you can obtain recovery media for your system from support. See the *Worldwide Telephone Numbers* booklet included with the computer. You can also find contact information from the HP

website. Go to <http://www.hp.com/support>, select your country or region, and follow the on-screen instructions.

 **IMPORTANT:** HP Recovery Manager does not automatically provide backups of your personal data. Before beginning recovery, back up any personal data you want to retain.

Using HP Recovery media, you can choose from one of the following recovery options:

 **NOTE:** Only the options available for your computer display when you start the recovery process.

- System Recovery—Reinstalls the original operating system, and then configures the settings for the programs that were installed at the factory.
- Factory Reset—Restores the computer to its original factory state by deleting all information from the hard drive and re-creating the partitions. Then it reinstalls the operating system and the software that was installed at the factory.

The HP Recovery partition (select products only) allows System Recovery only.

Using the HP Recovery partition (select products only)

The HP Recovery partition allows you to perform a system recovery without the need for recovery discs or a recovery USB flash drive. This type of recovery can be used only if the hard drive is still working.

To start HP Recovery Manager from the HP Recovery partition:

 **IMPORTANT:** For a tablet with a detachable keyboard, connect the tablet to the keyboard base before beginning these steps (select products only).

1. Type `recovery` in the taskbar search box, select **Recovery Manager**, and then select **HP Recovery Environment**.

– or –

For computers or tablets with keyboards attached, press **f11** while the computer boots, or press and hold **f11** as you press the power button.

For tablets without keyboards:

- Turn on or restart the tablet, and then quickly hold down the volume up button; then select **f11**.

– or –

- Turn on or restart the tablet, and then quickly hold down the volume down button; then select **f11**.

2. Select **Troubleshoot** from the boot options menu.
3. Select **Recovery Manager**, and then follow the on-screen instructions.

Using HP Recovery media to recover

You can use HP Recovery media to recover the original system. This method can be used if your system does not have an HP Recovery partition or if the hard drive is not working properly.

1. If possible, back up all personal files.
2. Insert the HP Recovery media, and then restart the computer.

 **NOTE:** If the computer does not automatically restart in HP Recovery Manager, change the computer boot order. See [Changing the computer boot order on page 83](#).

3. Follow the on-screen instructions.

Changing the computer boot order

If your computer does not restart in HP Recovery Manager, you can change the computer boot order, which is the order of devices listed in BIOS where the computer looks for startup information. You can change the selection to an optical drive or a USB flash drive.

To change the boot order:



IMPORTANT: For a tablet with a detachable keyboard, connect the tablet to the keyboard base before beginning these steps.

1. Insert the HP Recovery media.

2. Access the system **Startup** menu.

For computers or tablets with keyboards attached:

- ▲ Turn on or restart the computer or tablet, quickly press **esc**, and then press **f9** for boot options.

For tablets without keyboards:

- ▲ Turn on or restart the tablet, and then quickly hold down the volume up button; then select **f9**.

– or –

Turn on or restart the tablet, and then quickly hold down the volume down button; then select **f9**.

3. Select the optical drive or USB flash drive from which you want to boot.

4. Follow the on-screen instructions.

Removing the HP Recovery partition (select products only)

HP Recovery Manager software allows you to remove the HP Recovery partition to free up hard drive space.



IMPORTANT: After you remove the HP Recovery partition, you will not be able to perform System Recovery or create HP Recovery media from the HP Recovery partition. So before you remove the Recovery partition, create HP Recovery media; see [Creating HP Recovery media \(select products only\) on page 79](#).



NOTE: The Remove Recovery Partition option is only available on products that support this function.

Follow these steps to remove the HP Recovery partition:

1. Type `recovery` in the taskbar search box, and then select **HP Recovery Manager**.
2. Select **Remove Recovery Partition**, and then follow the on-screen instructions.

9 Using HP PC Hardware Diagnostics (UEFI)

HP PC Hardware Diagnostics is a Unified Extensible Firmware Interface (UEFI) that allows you to run diagnostic tests to determine whether the computer hardware is functioning properly. The tool runs outside the operating system so that it can isolate hardware failures from issues that are caused by the operating system or other software components.

When HP PC Hardware Diagnostics (UEFI) detects a failure that requires hardware replacement, a 24-digit Failure ID code is generated. This ID code can then be provided to support to help determine how to correct the problem.

 **NOTE:** To start diagnostics on a convertible computer, your computer must be in notebook mode and you must use the keyboard attached.

To start HP PC Hardware Diagnostics (UEFI), follow these steps:

1. Turn on or restart the computer, and quickly press **esc**.
2. Press **f2**.

The BIOS searches three places for the diagnostic tools, in the following order:

- a. Connected USB drive

 **NOTE:** To download the HP PC Hardware Diagnostics (UEFI) tool to a USB drive, see [Downloading HP PC Hardware Diagnostics \(UEFI\) to a USB device on page 85](#).

- b. Hard drive

- c. BIOS

3. When the diagnostic tool opens, select the type of diagnostic test you want to run, and then follow the on-screen instructions.

 **NOTE:** If you need to stop a diagnostic test, press **esc**.

Downloading HP PC Hardware Diagnostics (UEFI) to a USB device

 **NOTE:** The HP PC Hardware Diagnostics (UEFI) download instructions are provided in English only, and you must use a Windows computer to download and create the HP UEFI support environment because only .exe files are offered.

There are two options to download HP PC Hardware Diagnostics to a USB device.

Download the latest UEFI version

1. Go to <http://www.hp.com/go/techcenter/pcdiags>. The HP PC Diagnostics home page is displayed.
2. In the HP PC Hardware Diagnostics section, select the **Download** link, and then select **Run**.

Download any version of UEFI for a specific product

1. Go to <http://www.hp.com/support>.
2. Select **Get software and drivers**.

3. Enter the product name or number.

– or –

Select **Identify now** to let HP automatically detect your product.

4. Select your computer, and then select your operating system.
5. In the **Diagnostic** section, follow the on-screen instructions to select and download the UEFI version you want.

Additional BIOS crisis recovery tool

HP provides a BIOS crisis recovery tool through the HP PC Hardware Diagnostics 3-in-1 USB key. This tool can be used by HP authorized service providers to recover systems that have failed due to a corrupted BIOS. For more information about using the 3-in-1 USB key for BIOS crisis recovery, go to <http://www.hp.com/go/techcenter/pcdiags>. Additional information is included in the web-based training offered by HP University. See the modules that cover HP PC Hardware Diagnostics (UEFI).

10 Specifications

Computer specifications

	Metric	U.S.
Dimensions		
Depth	253.8 mm	9.99 in
Width	380.0 mm	14.9 in
Height	23.8 mm	0.94 in
Weight (includes only SSD)		
3 cell battery	1.86 kg	4.1 lb
4 cell battery	1.91 kg	4.21 lb
Input power		
Operating voltage and current	19.5 V dc @ 3.33 A – 65 W	
	19.5 V dc @ 2.31 A – 45 W	
Temperature		
Operating	5°C to 35°C	41°F to 95°F
Nonoperating	-20°C to 60°C	-4°F to 140°F
Relative humidity (noncondensing)		
Operating	10% to 90%	
Nonoperating	5% to 95%	
Maximum altitude (unpressurized)		
Operating	-15 m to 3,048 m	-50 ft to 10,000 ft
Nonoperating	-15 m to 12,192 m	-50 ft to 40,000 ft
NOTE: Applicable product safety standards specify thermal limits for plastic surfaces. The device operates well within this range of temperatures.		

39.6-cm (15.6-in) display specifications

	Metric	U.S.
Active diagonal size	39.6-cm	15.6-in
Resolution	1366x768 (HD) 1920x1080 (FHD)	
Surface treatment	Anit glare	
Brightness	220 nits	
Viewing angle	SVA	
Backlight	WLED	
Graphics adapter	eDP	
Thickness	3.2 mm	

Hard drive specifications

	1-TB*	500-GB*
Dimensions		
Height	9.5 mm or 7.2 mm	7.0 mm
Length	100.4 mm	100.6 mm
Width	69.9 mm	70.1 mm
Weight	107.0 g	92.0 g
Interface type	SATA	SATA
Transfer rate		
Synchronous (maximum)	300 MB/sec	300 MB/sec
Security	ATA security	ATA security
Seek times (typical read, including setting)		
Single track	2.0 ms	3 ms
Average (read/write)	12 ms	13 ms
Maximum	22 ms	24 ms
Logical blocks	1,953,525,168	1,048,576,000
Disk rotational speed	5400 rpm	5400 rpm or 7200 rpm
Operating temperature		
*1 GB = 1 billion bytes when referring to hard drive storage capacity. Actual accessible capacity is less.		
NOTE: Certain restrictions and exclusions apply. Contact technical support for details.		

M.2 solid-state drive specifications

	128-GB*	256-GB*
Dimensions		
Height	1 mm	1 mm
Length	50.8 mm	50.8 mm
Width	28.9 mm	28.9 mm
Weight	< 10 g	< 10 g
Interface type	ATA-7	ATA-7
Transfer rate		
Sequential Read	Up to 520 MB/s	Up to 540 MB/s
Random Read	Up to 60K IOPs	Up to 85K IOPs
Sequential Write	Up to 160 MB/s	Up to 280 MB/s
Random Write	Up to 34K IOPs	Up to 67K IOPs
Ready time, Maximum (to not busy)	1.0 s	1.0 s
Access times		
Logical	0.1 ms	0.1
Total logical sectors	250,069,680	500,118,192
Operating temperature		
Operating	0° to 70°C (32°F to 158°F)	0° to 70°C (32°F to 158°F)
Non-operating	-40° to 95°C (-40°F to 203°F)	-55° to 90°C (-67°F to 194°F)
*1 GB = 1 billion bytes when referring to hard drive storage capacity. Actual accessible capacity is less.		
NOTE: Certain restrictions and exclusions apply. Contact technical support for details.		

DVD±RW SuperMulti DL Drive specifications

Component	Value	
Applicable disc	Read: CD-DA, CD+(E)G, CD-MIDI, CD-TEXT, CD-ROM, CD-ROM XA, MIXED MODE CD, CD-I, CD-I Bridge (Photo-CD, Video CD), Multisession CD (Photo-CD, CD-EXTRA, Portfolio, CD-R, CD-RW), CD-R, CD-RW, DVD-ROM (DVD-5, DVD-9, DVD-10, DVD-18), DVD-R, DVD-RW, DVD+R, DVD+RW, DVD-RAM	Write: CD-R and CD-RW DVD+R, DVD+RW, DVD-R, DVD-RW, DVD-RAM
Center hole diameter	1.5 cm (0.59 in)	
Disc diameter		
Standard disc	12 cm (4.72 in)	
Mini disc	8 cm (3.15 in)	
Disc thickness	1.2 mm (0.047 in)	
Track pitch	0.74 µm	
Access time	CD	DVD
Random	< 175 ms	< 230 ms
Full stroke	< 285 ms	< 335 ms
Audio output level	Line-out, 0.7 Vrms	
Cache buffer	2 MB	
Data transfer rate		
24X CD-ROM	3,600 KB/sec	
8X DVD-ROM	10,800 KB/sec	
24X CD-R	3,600 KB/sec	
16X CD-RW	2,400 KB/sec	
8X DVD+R	10,800 KB/sec	
4X DVD+RW	5,400 KB/sec	
8X DVD-R	10,800 KB/sec	
4X DVD-RW	5,400 KB/sec	
2.4X DVD+R(9)	2,700 KB/sec	
5X DVD-RAM	6,750 KB/sec	
Transfer mode	Multiword DMA Mode	
Startup time	< 15 seconds	
Stop time	< 6 seconds	

11 Statement of memory volatility

The purpose of this chapter is to provide general information regarding nonvolatile memory in HP Business computers. This chapter also provides general instructions for restoring nonvolatile memory that can contain personal data after the system has been powered off and the hard drive has been removed.

HP Business computer products that use Intel®-based or AMD®-based system boards contain volatile DDR memory. The amount of nonvolatile memory present in the system depends upon the system configuration. Intel-based and AMD-based system boards contain nonvolatile memory subcomponents as originally shipped from HP, assuming that no subsequent modifications have been made to the system and assuming that no applications, features, or functionality have been added to or installed on the system.

Following system shutdown and removal of all power sources from an HP Business computer system, personal data can remain on volatile system memory (DIMMs) for a finite period of time and will also remain in nonvolatile memory. Use the steps below to remove personal data from the computer, including the nonvolatile memory found in Intel-based and AMD-based system boards.

 **NOTE:** If your tablet has a keyboard base, connect to the keyboard base before beginning steps in this chapter.

Current BIOS steps

1. Follow steps (a) through (l) below to restore the nonvolatile memory that can contain personal data. Restoring or reprogramming nonvolatile memory that does not store personal data is neither necessary nor recommended.
 - a. Turn on or restart the computer, and then press **esc** while the "Press the ESC key for Startup Menu" message is displayed at the bottom of the screen.

 **NOTE:** If the system has a BIOS administrator password, enter the password at the prompt.
 - b. Select **Main**, select **Apply Factory Defaults and Exit**, and then select **Yes** to load defaults.
The computer will reboot.
 - c. During the reboot, press **esc** while the "Press the ESC key for Startup Menu" message is displayed at the bottom of the screen.

 **NOTE:** If the system has a BIOS administrator password, enter the password at the prompt.
 - d. Select the **Security** menu, select **Restore Security Settings to Factory Defaults**, and then select **Yes** to restore security level defaults.
The computer will reboot.
 - e. During the reboot, press **esc** while the "Press the ESC key for Startup Menu" message is displayed at the bottom of the screen.

 **NOTE:** If the system has a BIOS administrator password, enter the password at the prompt.
 - f. If an asset or ownership tag is set, select the **Security** menu and scroll down to the **Utilities** menu. Select **System IDs**, and then select **Asset Tracking Number**. Clear the tag, and then make the selection to return to the prior menu.

- g. If a DriveLock password is set, select the **Security** menu, and scroll down to **Hard Drive Utilities** under the **Utilities** menu. Select **Hard Drive Utilities**, select **DriveLock**, then uncheck the checkbox for **DriveLock password on restart**. Select **OK** to proceed.
- h. Select the **Main** menu, and then select **Reset BIOS Security to factory default**. Click **Yes** at the warning message.
The computer will reboot.
- i. During the reboot, press **esc** while the “Press the ESC key for Startup Menu” message is displayed at the bottom of the screen.



NOTE: If the system has a BIOS administrator password, enter the password at the prompt.

- j. Select the **Main** menu, select **Apply Factory Defaults and Exit**, select **Yes** to save changes and exit, and then select **Shutdown**.
 - k. Reboot the system. If the system has a Trusted Platform Module (TPM) and/or fingerprint reader, one or two prompts will appear—one to clear the TPM and the other to Reset Fingerprint Sensor; press or tap **F1** to accept or **F2** to reject.
 - l. Remove all power and system batteries for at least 24 hours.
2. Complete one of the following:
- Remove and retain the storage drive.
 - or –
 - Clear the drive contents by using a third party utility designed to erase data from an SSD.
 - or –
 - Clear the contents of the drive by using the following BIOS Setup Secure Erase command option steps:



IMPORTANT: If you clear data using Secure Erase, it cannot be recovered.

- a. Turn on or restart the computer, and then press **esc** while the “Press the ESC key for Startup Menu” message is displayed at the bottom of the screen.
- b. Select the **Security** menu and scroll down to the **Utilities** menu.
- c. Select **Hard Drive Utilities**.
- d. Under **Utilities**, select **Secure Erase**, select the hard drive storing the data you want to clear, and then follow the on-screen instructions to continue.

Nonvolatile memory usage

Nonvolatile Memory Type	Amount (Size)	Does this memory store customer data?	Does this memory retain data when power is removed?	What is the purpose of this memory?	How is data input into this memory?	How is this memory write-protected?
HP Sure Start flash (select models only)	8 MBytes	No	Yes	Provides protected backup of critical System BIOS code, EC firmware, and critical computer configuration data for select platforms that support HP Sure Start. For more information, see Using HP Sure Start (select models only) on page 98 .	Data cannot be written to this device via the host processor. The content is managed solely by the HP Sure Start Embedded Controller.	This memory is protected by the HP Sure Start Embedded Controller.
Real Time Clock (RTC) battery backed-up CMOS configuration memory	256 Bytes	No	Yes	Stores system date and time and noncritical data.	RTC battery backed-up CMOS is programmed using the Computer Setup (BIOS), or changing the Microsoft Windows date & time.	This memory is not write-protected.
Controller (NIC) EEPROM	64 KBytes (not customer accessible)	No	Yes	Stores NIC configuration and NIC firmware.	NIC EEPROM is programmed using a utility from the NIC vendor that can be run from DOS.	A utility is required to write data to this memory and is available from the NIC vendor. Writing data to this ROM in an inappropriate manner will render the NIC non-functional.
DIMM Serial Presence Detect (SPD) configuration data	256 Bytes per memory module, 128 Bytes programmable (not customer accessible)	No	Yes	Stores memory module information.	DIMM SPD is programmed by the memory vendor.	Data cannot be written to this memory when the module is installed in a computer. The specific write-protection method varies by memory vendor.
System BIOS	9 MBytes	Yes	Yes	Stores system BIOS code and computer configuration data.	System BIOS code is programmed at the factory. Code is updated when the system BIOS is updated. Configuration data and settings are input using the Computer Setup (BIOS) or a custom utility.	NOTE: Writing data to this ROM in an inappropriate manner can render the computer non-functional. A utility is required for writing data to this memory and is available on the HP website; go to http://www.hp.com/support . Select Find your

Nonvolatile Memory Type	Amount (Size)	Does this memory store customer data?	Does this memory retain data when power is removed?	What is the purpose of this memory?	How is data input into this memory?	How is this memory write-protected?
Intel Management Engine Firmware (present only in select Elite or Z models. For more information, go to http://www.hp.com/support . Select Find your product , and then follow the on-screen instructions.)	1.5 MBytes or 7 MBytes	Yes	Yes	Stores Management Engine Code, Settings, Provisioning Data and iAMT third-party data store.	Management Engine Code is programmed at the factory. Code is updated via Intel secure firmware update utility. Unique Provisioning Data can be entered at the factory or by an administrator using the Management Engine (MEBx) setup utility. The third party data store contents can be populated by a remote management console or local applications that have been registered by an administrator to have access to the space.	product , and then follow the on-screen instructions. The Intel chipset is configured to enforce hardware protection to block all direct read/write access to this area. An Intel utility is required for updating the firmware. Only firmware updates digitally signed by Intel can be applied using this utility.
Bluetooth flash (select products only)	2 Mbit	No	Yes	Stores Bluetooth configuration and firmware.	Bluetooth flash is programmed at the factory. Tools for writing data to this memory are not publicly available but can be obtained from the silicon vendor.	A utility is required for writing data to this memory and is made available through newer versions of the driver whenever the flash requires an upgrade.
802.11 WLAN EEPROM	4 Kbit to 8 Kbit	No	Yes	Stores configuration and calibration data.	802.11 WLAN EEPROM is programmed at the factory. Tools for writing data to this memory are not made public.	A utility is required for writing data to this memory and is typically not made available to the public unless a firmware upgrade is necessary to address a unique issue.
Camera (select products only)	64 Kbit	No	Yes	Stores camera configuration and firmware.	Camera memory is programmed using a utility from the device manufacturer that can be run from Windows.	A utility is required for writing data to this memory and is typically not made available to the public unless a firmware upgrade is necessary to address a unique issue.
Fingerprint reader (select products only)	512 KByte flash	Yes	Yes	Stores fingerprint templates.	Fingerprint reader memory is programmed by user enrollment in HP ProtectTools Security Manager.	Only a digitally signed application can make the call to write to the flash.

Questions and answers

1. How can the BIOS settings be restored (returned to factory settings)?



IMPORTANT: Restore defaults does not securely erase any data on your hard drive. See question and answer 6 for steps to securely erase data.

Restore defaults does not reset the Custom Secure Boot keys. See question and answer 7 for information about resetting the keys.

- a. Turn on or restart the computer, and then press **esc** while the "Press the ESC key for Startup Menu" message is displayed at the bottom of the screen.
- b. Select **Main**, and then select **Apply Factory Defaults and Exit**.
- c. Follow the on-screen instructions.
- d. Select **Main**, select **Save Changes and Exit**, and then follow the on-screen instructions.

2. What is a UEFI BIOS, and how is it different from a legacy BIOS?

The Unified Extensible Firmware Interface (UEFI) BIOS is an industry-standard software interface between the platform firmware and an operating system (OS). It is a replacement for the older BIOS architecture, but supports much of the legacy BIOS functionality.

Like the legacy BIOS, the UEFI BIOS provides an interface to display the system information and configuration settings and to change the configuration of your computer before an OS is loaded. BIOS provides a secure run-time environment that supports a Graphic User Interface (GUI). In this environment, you can use either a pointing device (Touchscreen, TouchPad, pointing stick, or USB mouse) or the keyboard to navigate and make menu and configuration selections. The UEFI BIOS also contains basic system diagnostics.

The UEFI BIOS provides functionality beyond that of the legacy BIOS. In addition, the UEFI BIOS works to initialize the computer's hardware before loading and executing the OS; the run-time environment allows the loading and execution of software programs from storage devices to provide more functionality, such as advanced hardware diagnostics (with the ability to display more detailed system information) and advanced firmware management and recovery software.

HP has provided options in Computer Setup (BIOS) to allow you to run in legacy BIOS, if required by the operating system. Examples of this requirement would be if you upgrade or downgrade the OS.

3. Where does the UEFI BIOS reside?

The UEFI BIOS resides on a flash memory chip. A utility is required to write to the chip.

4. What kind of configuration data is stored on the DIMM Serial Presence Detect (SPD) memory module? How would this data be written?

The DIMM SPD memory contains information about the memory module, such as size, serial number, data width, speed/timing, voltage, and thermal information. This information is written by the module manufacturer and stored on an EEPROM. This EEPROM cannot be written to when the memory module is installed in a computer. Third-party tools do exist that can write to the EEPROM when the memory module is not installed in a computer. Various third-party tools are available to read SPD memory.

5. What is meant by "Restore the nonvolatile memory found in Intel-based system boards"?

This message relates to clearing the Real Time Clock (RTC) CMOS memory that contains computer configuration data.

6. How can the BIOS security be reset to factory defaults and data erased?

 **IMPORTANT:** Resetting will result in the loss of information.

These steps will not reset Custom Secure Boot Keys. See question and answer 7 for information about resetting the keys.

- a. Turn on or restart the computer, and then press **esc** while the "Press the ESC key for Startup Menu" message is displayed at the bottom of the screen.
- b. Select **Main**, and then select **Reset Security to Factory Defaults**.
- c. Follow the on-screen instructions.
- d. Select **Main**, select **Save Changes and Exit**, and then follow the on-screen instructions.

7. How can the Custom Secure Boot Keys be reset?

Secure Boot is a feature to ensure that only authenticated code can start on a platform. If you enabled Secure Boot and created Custom Secure Boot Keys, simply disabling Secure Boot will not clear the keys. You must also select to clear the Custom Secure Boot Keys. Use the same Secure Boot access procedure you used to create the Custom Secure Boot Keys, but make the selection to clear or delete all Secure Boot Keys.

- a. Turn on or restart the computer, and then press **esc** while the "Press the ESC key for Startup Menu" message is displayed at the bottom of the screen.
- b. Select the **Security** menu, select **Secure Boot Configuration**, and then follow the on-screen instructions.
- c. At the **Secure Boot Configuration** window, select **Secure Boot**, select **Clear Secure Boot Keys**, and then follow the on-screen instructions to continue.

Using HP Sure Start (select models only)

Select computer models are configured with HP Sure Start, a technology that continuously monitors your computer's BIOS for attacks or corruption. If the BIOS becomes corrupted or is attacked, HP Sure Start restores the BIOS to its previously safe state, without user intervention. Those select computer models ship with HP Sure Start configured and enabled. HP Sure Start is configured and already enabled so that most users can use the HP Sure Start default configuration. The default configuration can be customized by advanced users.

To access the latest documentation on HP Sure Start, go to <http://www.hp.com/support>. Select **Find your product**, and then follow the on-screen instructions.

12 Power cord set requirements

The wide-range input feature of the computer permits it to operate from any line voltage from 100 to 120 volts ac, or from 220 to 240 volts ac.

The 3-conductor power cord set included with the computer meets the requirements for use in the country or region where the equipment is purchased.

Power cord sets for use in other countries and regions must meet the requirements of the country or region where the computer is used.

Requirements for all countries

The following requirements are applicable to all countries and regions:

- The length of the power cord set must be at least **1.5 m** (5.0 ft) and no more than **2.0 m** (6.5 ft).
- All power cord sets must be approved by an acceptable accredited agency responsible for evaluation in the country or region where the power cord set will be used.
- The power cord sets must have a minimum current capacity of 10 A and a nominal voltage rating of 125 or 250 V ac, as required by the power system of each country or region.
- The appliance coupler must meet the mechanical configuration of an EN 60 320/IEC 320 Standard Sheet C13 connector for mating with the appliance inlet on the back of the computer.

Requirements for specific countries and regions

Country/region	Accredited agency	Applicable note number
Argentina	IRAM	1
Australia	SAA	1
Austria	OVE	1
Belgium	CEBEC	1
Brazil	ABNT	1
Canada	CSA	2
Chile	IMQ	1
Denmark	DEMKO	1
Finland	FIMKO	1
France	UTE	1
Germany	VDE	1
India	ISI	1
Israel	SII	1
Italy	IMQ	1
Japan	JIS	3
The Netherlands	KEMA	1
New Zealand	SANZ	1
Norway	NEMKO	1
The People's Republic of China	CCC	4
Saudi Arabia	SASO	7
Singapore	PSB	1
South Africa	SABS	1
South Korea	KTL	5
Sweden	SEMKO	1
Switzerland	SEV	1
Taiwan	BSMI	6
Thailand	TISI	1
The United Kingdom	ASTA	1
The United States	UL	2

1. The flexible cord must be Type H05VV-F, 3-conductor, 0.75mm² conductor size. Power cord set fittings (appliance coupler and wall plug) must bear the certification mark of the agency responsible for evaluation in the country or region where it will be used.
2. The flexible cord must be Type SVT/SJT or equivalent, No. 18 AWG, 3-conductor. The wall plug must be a two-pole grounding type with a NEMA 5-15P (15 A, 125 V ac) or NEMA 6-15P (15 A, 250 V ac) configuration. CSA or C-UL mark. UL file number must be on each element.

Country/region	Accredited agency	Applicable note number
		3. The appliance coupler, flexible cord, and wall plug must bear a “T” mark and registration number in accordance with the Japanese Dentori Law. The flexible cord must be Type VCTF, 3-conductor, 0.75mm ² or 1.25mm ² conductor size. The wall plug must be a two-pole grounding type with a Japanese Industrial Standard C8303 (7 A, 125 V ac) configuration.
		4. The flexible cord must be Type RVV, 3-conductor, 0.75mm ² conductor size. Power cord set fittings (appliance coupler and wall plug) must bear the CCC certification mark.
		5. The flexible cord must be Type H05VV-F 3X0.75mm ² conductor size. KTL logo and individual approval number must be on each element. Corset approval number and logo must be printed on a flag label.
		6. The flexible cord must be Type HVCTF 3X1.25mm ² conductor size. Power cord set fittings (appliance coupler, cable, and wall plug) must bear the BSMI certification mark.
		7. For 127 V ac, the flexible cord must be Type SVT or SJT 3 x 18 AWG, with plug NEMA 5-15P (15 A, 125 V ac), with UL and CSA or C-UL marks. For 240 V ac, the flexible cord must be Type H05VV-F 3X0.75/1.00mm ² conductor size, with plug BS 1363/A with BSI or ASTA marks.

13 Recycling

When a non-rechargeable or rechargeable battery has reached the end of its useful life, do not dispose of the battery in general household waste. Follow the local laws and regulations in your area for battery disposal.

HP encourages customers to recycle used electronic hardware, HP original print cartridges, and rechargeable batteries. For more information about recycling programs, see the HP Web site at <http://www.hp.com/recycle>.

Index

A

- action keys
 - using 13
- airplane mode key 13
- antenna
 - illustrated 21
- antennas
 - removing 70, 71
- audio, product description 2
- audio-out (headphone)/audio-in (microphone) combo jack, identifying 6

B

- backups 79
- battery
 - illustrated 19
 - removing 30
- battery cover, identifying 14
- battery light 6
- battery lock, identifying 14
- battery release latch 14
- BIOS
 - determining version 77
 - downloading an update 78
 - starting the Setup Utility 77
 - updating 77

- Bluetooth label 15
- boot order
 - changing 83
- bottom 15
- bottom cover
 - illustrated 19
 - removing 38
- buttons
 - left TouchPad 9
 - optical drive eject 5
 - power 11
 - right TouchPad 9

C

- cable locations
 - removing 75
- cables
 - illustrated 21

- cables, service considerations 25
- camera 8
- camera light, identifying 8
- camera, identifying 8
- camera/microphone cable
 - illustrated 21
 - removing 35, 66, 67
- camera/microphone module
 - illustrated 20
 - removing 34, 65
- caps lock light, identifying 10
- components
 - bottom 14
 - display 8
 - left side 6
 - right side 5
 - top 9
- computer major components, illustrated 17
- computer specifications 87
- connector, power 6
- connectors, service considerations 25

D

- display assembly
 - illustrated 18
 - removing 63
- display assembly subcomponents
 - illustrated 20
 - removing 63
- display bezel
 - illustrated 20
 - removing 33, 64
- display cable
 - illustrated 21
 - removing 67
- display enclosure
 - illustrated 21
 - removing 72
- display panel
 - illustrated 20
 - product description 1
 - removing 35, 66, 67
- display specifications 88

- display subcomponents
 - removal 33
 - spare part numbers 33
- drive light 5
- DVD±RW SuperMulti DL Drive specifications 91

E

- electrostatic discharge 26
- equipment guidelines 28
- esc key, identifying 12
- Ethernet, product description 2
- external media cards 2
- external monitor port 6

F

- fan
 - illustrated 18
 - removing 54
- fn key, identifying 12
- function keys, identifying 12

G

- graphics, product description 1
- grounding guidelines 26
- guidelines
 - equipment 28
 - grounding 26
 - packaging 27
 - transporting 27
 - workstation 27

H

- hard drive
 - illustrated 18, 22
 - precautions 26
 - product description 1
 - removing 45
 - specifications 89
- hard drive board
 - illustrated 18
- hard drive bracket
 - illustrated 18, 22
- hard drive brackets
 - removing 46

- hard drive connector
 - removing 47
- hard drive connector and cable
 - removing 46
- hard drive connector board
 - removing 45
- hard drive connector board cable
 - illustrated 21
- HDMI port, identifying 6
- heat sink assembly
 - illustrated 18
 - removing 18, 56
- hinge cover
 - illustrated 20
- hinges
 - illustrated 21
 - removing 35, 66, 67
- HP PC Hardware Diagnostics (UEFI)
 - using 85
- HP Recovery Manager
 - correcting boot problems 83
 - starting 82
- HP Recovery media
 - creating 79
 - recovery 82
- HP Recovery partition
 - recovery 82
 - removing 84
- HP Sure Start 98

I

- integrated camera light, identifying 8
- integrated numeric keypad, identifying 12
- internal card
 - product description 2
- internal microphone, identifying 8

J

- jacks
 - audio-out (headphone)/audio-in (microphone) combo 6
 - network 6
 - RJ-45 (network) 6

K

- keyboard
 - illustrated 18
 - product description 2

- keypad
 - integrated numeric 12
- keys
 - airplane mode 13
 - esc 12
 - fn 12
 - Windows key 12

L

- labels
 - Bluetooth 15
 - regulatory 15
 - serial number 15
 - service 15
 - wireless certification 15
 - WLAN 15
- latch, battery release 14
- lights
 - battery 6
 - camera 8
 - caps lock 10
 - drive 5
 - power 5
 - RJ-45 (network) 6

M

- M.2 solid-state drive
 - specifications 90
- M.2 solid-state drive adapter bracket
 - and connector board
 - removing 48
- mass storage devices
 - illustrated 22
 - precautions 26
- memory
 - nonvolatile 93
 - volatile 93
- memory card reader, identifying 5
- memory module
 - illustrated 18
 - product description 1
 - removing 43
- microphone 2
- minimized image recovery 82
- minimized image, creating 81
- model name 1

N

- network jack, identifying 6
- nonvolatile memory 93

O

- operating system 3
- optical drive
 - illustrated 18, 22
 - precautions 26
 - product description 1
 - removing 31
 - specifications 91
- optical drive bracket
 - illustrated 22
- optical drive connector board
 - illustrated 18, 44
 - removing 44
- optical drive connector board cable
 - illustrated 21
- optical drive eject button, identifying 5
- optical drive rear bracket
 - removing 32
- optical drive, identifying 5
- original system recovery 81

P

- packaging guidelines 27
- plastic parts, service
 - considerations 25
- pointing device 2
- ports
 - external monitor 6
 - HDMI 6
 - product description 2
 - USB 2.0 5
 - USB 3.x SuperSpeed 6
- power button board
 - illustrated 18
 - removing 74
- power button board cable
 - illustrated 21
- power button, identifying 11
- power connector cable
 - illustrated 18
 - removing 73
- power connector, identifying 6
- power cord
 - requirements for all countries 99
 - requirements for specific countries and regions 100
 - set requirements 99
 - spare part numbers 23

- power lights 5
- power requirements 2
- processor
 - product description 1
- product description
 - audio 2
 - display panel 1
 - Ethernet 2
 - external media cards 2
 - graphics 1
 - hard drive 1
 - internal card 2
 - keyboard 2
 - memory module 1
 - microphone 2
 - operating system 3
 - optical drive 1
 - pointing device 2
 - ports 2
 - power requirements 2
 - processor 1
 - product name 1
 - security 3
 - serviceability 3
 - video 2
 - wireless 2
- product name 1
- product name and number, computer 15
- R**
- recover
 - options 81
- recovery
 - discs 80, 82
 - HP Recovery Manager 81
 - media 82
 - starting 82
 - supported discs 80
 - system 81
 - USB flash drive 82
 - using HP Recovery media 80
- recovery media
 - creating 79
 - creating using HP Recovery Manager 80
- recovery partition
 - removing 84
- regulatory information
 - regulatory label 15
 - wireless certification labels 15
- removal/replacement
 - preliminaries 25
 - procedures 29, 33
- removing personal data from volatile system memory 93
- RJ-45 (network) jack, identifying 6
- RJ-45 (network) lights, identifying 6
- RTC battery
 - illustrated 18
 - removing 51
- rubber feet
 - removing 37
- S**
- security cable slot, identifying 5
- security, product description 3
- serial number 15
- serial number, computer 15
- service considerations
 - cables 25
 - connectors 25
 - plastic parts 25
- service labels, locating 15
- serviceability, product description 3
- slots
 - security cable 5
- solid-state drive
 - illustrated 22
 - removal 50
 - spare part number 18, 22, 50
- solid-state drive board
 - illustrated 19, 48
- solid-state drive bracket
 - illustrated 19, 48
- speakers
 - illustrated 19
 - removing 52
- speakers, identifying 14
- specifications
 - computer 87
 - display 88
 - DVD±RW SuperMulti DL Drive 91
 - hard drive 89
 - M.2 solid-state drive 90
 - optical drive 91
- supported discs, recovery 80
- system board
 - removing 61
 - spare part number 19, 61
- system memory, removing personal data from volatile 93
- system recovery 81
- system restore point
 - creating 80
- system restore point, creating 79
- T**
- tools required 25
- top cover/keyboard
 - removing 76
- TouchPad
 - buttons 9
- TouchPad button board
 - removing 60
 - spare part number 18, 60
- TouchPad button board cable
 - illustrated 21
- TouchPad cable
 - illustrated 21
- TouchPad zone
 - identifying 9
- transporting guidelines 27
- traveling with the computer 15
- U**
- USB 2.0 port, identifying 5
- USB 3.x SuperSpeed port, identifying 6
- USB board
 - removing 53
 - spare part number 18
- USB board cable
 - illustrated 21
- V**
- vents, identifying 6, 14
- video, product description 2
- W**
- Windows
 - system restore point 79, 80
- Windows key, identifying 12
- Windows tools
 - using 80
- wireless antenna
 - illustrated 21

- wireless antennas
 - removing 70, 71
- wireless certification label 15
- wireless, product description 2
- WLAN antennas, identifying 8
- WLAN device 15
- WLAN label 15
- WLAN module
 - illustrated 18
 - removing 41
- workstation guidelines 27